



FCC TEST REPORT (15.247)

REPORT NO.: RF931026L19A

MODEL NO.: DWL-AG132

RECEIVED: Oct. 21, 2004

TESTED: Oct. 21, 2004 ~ Jan. 22, 2005

ISSUED: Jan. 25, 2005

APPLICANT: D-Link Corporation

ADDRESS: No. 8, Li-Hsin VII Road Science Based
Industrial Park Hsin-Chu, Taiwan, R.O.C.

ISSUED BY: Advance Data Technology Corporation

LAB ADDRESS: No. 47, 14th Ling, Chia Pau Tsuen, Lin Kou
Hsiang 244, Taipei Hsien, Taiwan, R.O.C.

TEST LOCATION: No. 19, Hwa Ya 2nd Rd., Wen Hwa Tsuen,
Kwei Shan Hsiang, Taoyuan Hsien 333,
Taiwan, R.O.C.

This test report consists of 166 pages in total. It may be duplicated completely for legal use with the approval of the applicant. It should not be reproduced except in full, without the written approval of our laboratory. The client should not use it to claim product endorsement by CNLA, A2LA or any government agencies. The test results in the report only apply to the tested sample.



0528
ILAC MRA



No. 2177-01



Table of Contents

1.	CERTIFICATION.....	5
2.	SUMMARY OF TEST RESULTS	6
2.1	MEASUREMENT UNCERTAINTY	7
3.	GENERAL INFORMATION	8
3.1	GENERAL DESCRIPTION OF EUT	8
3.2	DESCRIPTION OF TEST MODES	9
3.3	GENERAL DESCRIPTION OF APPLIED STANDARDS	12
3.4	DESCRIPTION OF SUPPORT UNITS	13
3.5	CONFIGURATION OF SYSTEM UNDER TEST	14
4.	TEST TYPES AND RESULTS (802.11B & G 2412-2462M BAND)	15
4.1	CONDUCTED EMISSION MEASUREMENT	15
4.1.1	LIMITS OF CONDUCTED EMISSION MEASUREMENT	15
4.1.2	TEST INSTRUMENTS	15
4.1.3	TEST PROCEDURES	16
4.1.4	DEVIATION FROM TEST STANDARD	16
4.1.5	TEST SETUP	17
4.1.6	EUT OPERATING CONDITIONS.....	17
4.1.7	TEST RESULTS	18
4.2	Radiated Emission Measurement.....	30
4.2.1	LIMITS OF RADIATED EMISSION MEASUREMENT	30
4.2.2	TEST INSTRUMENTS	31
4.2.3	TEST PROCEDURES	32
4.2.4	DEVIATION FROM TEST STANDARD	32
4.2.5	TEST SETUP	33
4.2.6	EUT OPERATING CONDITIONS.....	33
4.2.7	TEST RESULTS	34
4.3	6dB BANDWIDTH MEASUREMENT	52
4.3.1	LIMITS OF 6dB BANDWIDTH MEASUREMENT	52
4.3.2	TEST INSTRUMENTS	52
4.3.3	TEST PROCEDURE	53
4.3.4	DEVIATION FROM TEST STANDARD	53
4.3.5	TEST SETUP	53
4.3.6	EUT OPERATING CONDITIONS.....	53
4.3.7	TEST RESULTS	54
4.4	MAXIMUM PEAK OUTPUT POWER	64
4.4.1	LIMITS OF MAXIMUM PEAK OUTPUT POWER MEASUREMENT	64
4.4.2	INSTRUMENTS.....	64
4.4.1	TEST PROCEDURES	65
4.4.2	DEVIATION FROM TEST STANDARD	65



4.4.3	TEST SETUP	65
4.4.4	EUT OPERATING CONDITIONS.....	65
4.4.3	TEST RESULTS	66
4.5	POWER SPECTRAL DENSITY MEASUREMENT.....	68
4.5.1	LIMITS OF POWER SPECTRAL DENSITY MEASUREMENT.....	68
4.5.2	TEST INSTRUMENTS	68
4.5.3	TEST PROCEDURE	69
4.5.4	DEVIATION FROM TEST STANDARD	69
4.5.5	TEST SETUP	69
4.5.6	EUT OPERATING CONDITION	69
4.5.7	TEST RESULTS	70
4.6	BAND EDGES MEASUREMENT	80
4.6.1	LIMITS OF BAND EDGES MEASUREMENT	80
4.6.2	TEST INSTRUMENTS	80
4.6.3	TEST PROCEDURE	80
4.6.4	DEVIATION FROM TEST STANDARD	80
4.6.5	EUT OPERATING CONDITION	80
4.6.6	TEST RESULTS	81
4.7	ANTENNA REQUIREMENT	102
4.7.1	STANDARD APPLICABLE	102
4.7.2	ANTENNA CONNECTED CONSTRUCTION.....	102
5.	TEST TYPES AND RESULTS (802.11A 5725-5850M BAND)	103
5.1	CONDUCTED EMISSION MEASUREMENT	103
5.1.1	LIMITS OF CONDUCTED EMISSION MEASUREMENT	103
5.1.2	TEST INSTRUMENTS	103
5.1.3	TEST PROCEDURES	104
5.1.4	DEVIATION FROM TEST STANDARD	104
5.1.5	TEST SETUP	105
5.1.6	EUT OPERATING CONDITIONS.....	105
5.1.7	TEST RESULTS	106
5.2	Radiated Emission Measurement.....	110
5.2.1	LIMITS OF RADIATED EMISSION MEASUREMENT	110
5.2.2	TEST INSTRUMENTS	111
5.2.3	TEST PROCEDURES	112
5.2.4	DEVIATION FROM TEST STANDARD	112
5.2.5	TEST SETUP	113
5.2.6	EUT OPERATING CONDITIONS.....	113
5.2.7	TEST RESULTS	114
5.3	6dB BANDWIDTH MEASUREMENT	128
5.3.1	LIMITS OF 6dB BANDWIDTH MEASUREMENT	128
5.3.2	TEST INSTRUMENTS	128
5.3.3	TEST PROCEDURE	129
5.3.4	DEVIATION FROM TEST STANDARD	129



5.3.5	TEST SETUP	129
5.3.6	EUT OPERATING CONDITIONS.....	129
5.3.7	TEST RESULTS	130
5.4	MAXIMUM PEAK OUTPUT POWER	137
5.4.1	LIMITS OF MAXIMUM PEAK OUTPUT POWER MEASUREMENT	137
5.4.2	INSTRUMENTS.....	137
5.4.3	TEST PROCEDURES	138
5.4.4	DEVIATION FROM TEST STANDARD	138
5.4.5	TEST SETUP	138
5.4.6	EUT OPERATING CONDITIONS.....	138
5.4.7	TEST RESULTS	139
5.5	POWER SPECTRAL DENSITY MEASUREMENT.....	140
5.5.1	LIMITS OF POWER SPECTRAL DENSITY MEASUREMENT.....	140
5.5.2	TEST INSTRUMENTS	140
5.5.3	TEST PROCEDURE	141
5.5.4	DEVIATION FROM TEST STANDARD	141
5.5.5	TEST SETUP	141
5.5.6	EUT OPERATING CONDITION	141
5.5.7	TEST RESULTS	142
5.6	BAND EDGES MEASUREMENT	149
5.6.1	LIMITS OF BAND EDGES MEASUREMENT	149
5.6.2	TEST INSTRUMENTS	149
5.6.3	TEST PROCEDURE	149
5.6.4	DEVIATION FROM TEST STANDARD	149
5.6.5	EUT OPERATING CONDITION	150
5.6.6	TEST RESULTS	150
5.7	ANTENNA REQUIREMENT	161
5.7.1	STANDARD APPLICABLE	161
5.7.2	ANTENNA CONNECTED CONSTRUCTION.....	161
6.	PHOTOGRAPHS OF THE TEST CONFIGURATION	162
7.	INFORMATION ON THE TESTING LABORATORIES.....	166



1. CERTIFICATION

PRODUCT: D-Link AirPremier AG DWL-AG132 Wireless USB Adapter
BRAND NAME: D-Link
MODEL NO.: DWL-AG132
APPLICANT: D-Link Corporation
TEST SAMPLE: Engineering Sample
TESTED: Oct. 21, 2004 ~ Jan. 22, 2005
STANDARDS: FCC Part 15, Subpart C (Section 15.247),
ANSI C63.4-2003

The above equipment has been tested by **Advance Data Technology Corporation**, and found compliance with the requirement of the above standards. The test record, data evaluation & Equipment Under Test (EUT) configurations represented herein are true and accurate accounts of the measurements of the sample's EMC characteristics under the conditions specified in this report.

PREPARED BY : Windy Chou , **DATE:** Jan. 25, 2005
(Windy Chou)

TECHNICAL ACCEPTANCE : Gary Chang , **DATE:** Jan. 25, 2005
Responsible for RF (Gary Chang)

APPROVED BY : Cody Chang **DATE:** Jan. 25, 2005
(Cody Chang, Deputy Manager)



2. SUMMARY OF TEST RESULTS

The EUT has been tested according to the following specifications:

APPLIED STANDARD: FCC Part 15, Subpart C (Section 15.247)			
Standard Section	Test Type and Limit	Result	Remark
15.207	AC Power Conducted Emission	PASS	Meet the requirement of limit. Minimum passing margin is -15.61dB at 0.203MHz
15.247(a)(2)	Spectrum Bandwidth of a Direct Sequence Spread Spectrum System Limit: min. 500kHz	PASS	Meet the requirement of limit.
15.247(b)	Maximum Peak Output Power Limit: max. 30dBm	PASS	Meet the requirement of limit.
15.247(d)	Radiated Emissions Limit: Table 15.209	PASS	Meet the requirement of limit. Minimum passing margin is -1.71dB at 9748.00MHz
15.247(e)	Power Spectral Density Limit: max. 8dBm	PASS	Meet the requirement of limit.
15.247(d)	Band Edge Measurement Limit: 20dB less than the peak value of fundamental frequency	PASS	Meet the requirement of limit.

2.1 MEASUREMENT UNCERTAINTY

Where relevant, the following measurement uncertainty levels have been estimated for tests performed on the EUT as specified in CISPR 16-4:

Measurement	Frequency	Uncertainty
Conducted emissions	9kHz~30MHz	2.44 dB
Radiated emissions	30MHz ~ 200MHz	3.73 dB
	200MHz ~1000MHz	3.74 dB
	1GHz ~ 18GHz	2.20 dB
	18GHz ~ 40GHz	1.88 dB



3. GENERAL INFORMATION

3.1 GENERAL DESCRIPTION OF EUT

EUT	D-Link AirPremier AG DWL-AG132 Wireless USB Adapter
MODEL NO.	DWL-AG132
POWER SUPPLY	5.0Vdc from host equipment
MODULATION TYPE	CCK, DQPSK, DBPSK for DSSS 64QAM, 16QAM, QPSK, BPSK for OFDM
MODULATION TECHNOLOGY	DSSS, OFDM
TRANSFER RATE	802.11b: 11/5.5/2/1Mbps 802.11g: 54/48/36/24/18/12/9/6Mbps (Turbo mode: up to 108Mbps *see Note 2) 802.11a: 54/48/36/24/18/12/9/6Mbps (Turbo mode: up to 108Mbps *see Note 2)
FREQUENCY RANGE	802.11b & 802.11g: 2412 ~ 2462MHz 802.11a: 5.15 ~ 5.35GHz and 5.725 ~ 5.850GHz
NUMBER OF CHANNEL	802.11b & 802.11g: 11 for Normal mode 802.11a: 13 for Normal mode / 5 for Turbo mode
CHANNEL SPACING	802.11b & 802.11g: 5MHz 802.11a: 20MHz for Normal mode / 40MHz for Turbo mode
OUTPUT POWER	52.481mW for 802.11b 44.875mW for 802.11g 41.210mW for 5.15 ~ 5.35GHz 41.305mW for 5.725 ~ 5.850GHz
DATA CABLE	Non-shielded, 1.6m without core
ANTENNA TYPE	Chip antenna with 2.0dBi gain for 2.4GHz Chip antenna with 4.0dBi gain for 5GHz
I/O PORTS	USB
ASSOCIATED DEVICES	NA

NOTE:

1. The EUT operates in both the 5GHz and 2.4GHz Bands and compatibility with 802.11a and 802.11b, 802.11g technology.
2. This EUT is capable of providing data rates of up to 108 Mbps in Turbo mode depending upon reception quality.
3. The above EUT information was declared by the manufacturer and for more detailed features description, please refer to the manufacturer's specifications or User's Manual.



3.2 DESCRIPTION OF TEST MODES

802.11b and 802.11g: Eleven channels are provided to this EUT.

Channel	Frequency	Channel	Frequency
1	2412 MHz	7	2442 MHz
2	2417 MHz	8	2447 MHz
3	2422 MHz	9	2452 MHz
4	2427 MHz	10	2457 MHz
5	2432 MHz	11	2462 MHz
6	2437 MHz		

One channel is provided to this EUT for Turbo Mode.

Channel	Frequency
6	2437 MHz

For 802.11a: Thirteen channels are provided to this EUT.

Channel	Frequency	Channel	Frequency
1	5180 MHz	8	5320 MHz
2	5200 MHz	9	5745 MHz
3	5220 MHz	10	5765 MHz
4	5240 MHz	11	5785 MHz
5	5260 MHz	12	5805 MHz
6	5280 MHz	13	5825 MHz
7	5300 MHz		

This report covers only channels 9-13 for 15.247 portion. For channels 1-8 test data please refer to 15.407 test report.

Five channels are provided to this EUT for Turbo Mode.

Channel	Frequency	Channel	Frequency
1	5210 MHz	4	5760 MHz
2	5250 MHz	5	5800 MHz
3	5290 MHz		

This report covers only channels 4-5 for 15.247 portion. For channels 1-3 test data please refer to 15.407 test report.

Test Mode Applicability:

EUT configure mode	Applicable to				Description
	PLC	RE<1G	RE≥1G	APCM	
With Cradle	x	x	x	x	EUT tested with USB cradle
Without Cradle	x	x	Note 1	Note 2	EUT tested without USB cradle

Where PLC: Power Line Conducted Emission RE<1G RE: Radiated Emission below 1GHz
RE≥1G: Radiated Emission above 1GHz APCM: Antenna Port Conducted Measurement

Note 1: Pre-scan shown USB cradle has no effect for radiated emission above 1 GHz.

Note 2: Conducted RF measurement is independent of Cradle.



Power Line Conducted Emission Test:

- Pre-Scan has been conducted to determine the worst-cast mode from all possible combinations between available modulations, data rates and antenna ports (if EUT with antenna diversity architecture).
- Following channel(s) was (were) selected for the final test as listed below.

Mode	Available Channels	Tested Channels	Modulation Technology	Modulation Type	Data Rate (Mbps)
802.11g	1 to 11	1, 6, 11	OFDM	BPSK	6
802.11a	9 to 13	11	OFDM	BPSK	6

Radiated Emission Test (Below 1 GHz):

- Pre-Scan has been conducted to determine the worst-cast mode from all possible combinations between available modulations, data rates and antenna ports (if EUT with antenna diversity architecture).
- Following channel(s) was (were) selected for the final test as listed below.

Mode	Available Channels	Tested Channel	Modulation Technology	Modulation Type	Data Rate (Mbps)
802.11g	1 to 11	1	OFDM	BPSK	6
802.11a	9 to 13	11	OFDM	BPSK	6

Radiated Emission Test (Above 1 GHz):

- Pre-Scan has been conducted to determine the worst-cast mode from all possible combinations between available modulations, data rates and antenna ports (if EUT with antenna diversity architecture).
- Following channel(s) was (were) selected for the final test as listed below.

Mode	Available Channels	Tested Channels	Modulation Technology	Modulation Type	Data Rate (Mbps)
802.11b	1 to 11	1, 6, 11	DSSS	CKC	11
802.11g	1 to 11	1, 6, 11	OFDM	BPSK	6
802.11g Turbo	6	6	OFDM	BPSK	12
802.11a	9 to 13	9, 11, 13	OFDM	BPSK	6
802.11a Turbo	4 to 5	4, 5	OFDM	BPSK	12



Bandedge Measurement:

- Pre-Scan has been conducted to determine the worst-cast mode from all possible combinations between available modulations, data rates and antenna ports (if EUT with antenna diversity architecture).
- Following channels, those sit next to the investigated bandedge were selected for the final test as listed below.

Mode	Available Channels	Tested Channels	Modulation Technology	Modulation Type	Data Rate (Mbps)
802.11b	1 to 11	1, 11	DSSS	CKC	11
802.11g	1 to 11	1, 11	OFDM	BPSK	6
802.11g Turbo	6	6	OFDM	BPSK	12
802.11a	9 to 13	9, 13	OFDM	BPSK	6
802.11a Turbo	4 to 5	4, 5	OFDM	BPSK	12

Antenna Port Conducted Measurement:

- Pre-Scan has been conducted to determine the worst-cast mode from all possible combinations between available modulations, data rates and antenna ports (if EUT with antenna diversity architecture).
- Following channel(s) was (were) selected for the final test as listed below.

Mode	Available Channels	Tested Channels	Modulation Technology	Modulation Type	Data Rate (Mbps)
802.11b	1 to 11	1, 6, 11	DSSS	CKC	11
802.11g	1 to 11	1, 6, 11	OFDM	BPSK	6
802.11g Turbo	6	6	OFDM	BPSK	12
802.11a	9 to 13	9, 11, 13	OFDM	BPSK	6
802.11a Turbo	4 to 5	4, 5	OFDM	BPSK	12



3.3 GENERAL DESCRIPTION OF APPLIED STANDARDS

The EUT is a D-Link AirPremier AG DWL-AG132 Wireless USB Adapter. According to the specifications of the manufacturer, it must comply with the requirements of the following standards:

FCC Part 15, Subpart C. (15.247), ANSI C63.4-2003

All test items have been performed and recorded as per the above standards.

NOTE: The EUT is also considered as a kind of computer peripheral, because the connection to computer is necessary for typical use. It has been verified to comply with the requirements of FCC Part 15, Subpart B, Class B (DoC). The test report has been issued separately.



3.4 DESCRIPTION OF SUPPORT UNITS

The EUT has been tested as an independent unit together with other necessary accessories or support units. The following support units or accessories were used to form a representative test configuration during the tests.

NO.	PRODUCT	BRAND	MODEL NO.	SERIAL NO.	FCC ID
1	NOTEBOOK COMPUTER	DELL	PP05L	12130898320	E2K24CLNS
2	PRINTER	EPSON	LQ-300+	DCGY054147	FCC DoC Approved
3	MODEM	ACEEX	1414V/3	0401008269	IFAXDM1414

NO.	SIGNAL CABLE DESCRIPTION OF THE ABOVE SUPPORT UNITS
1	NA
2	1.2m shielded cable without core
3	1.2m shielded cable without core

NOTE: All power cords of the above support units are non shielded (1.8m).

3.5 CONFIGURATION OF SYSTEM UNDER TEST

For test mode 1 – without USB cradle

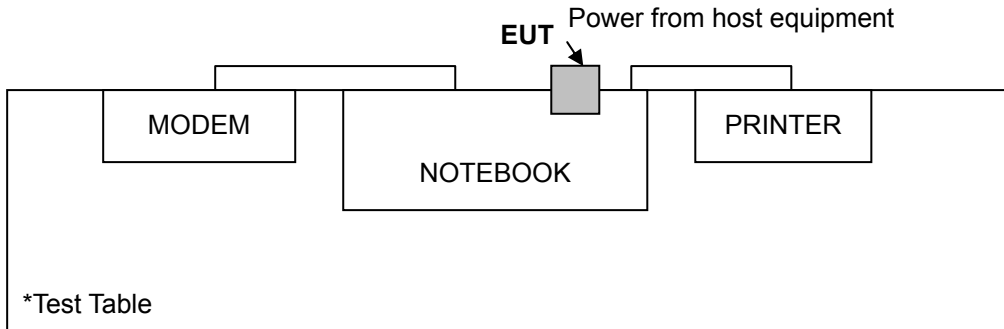

For test mode 2 – with USB cradle

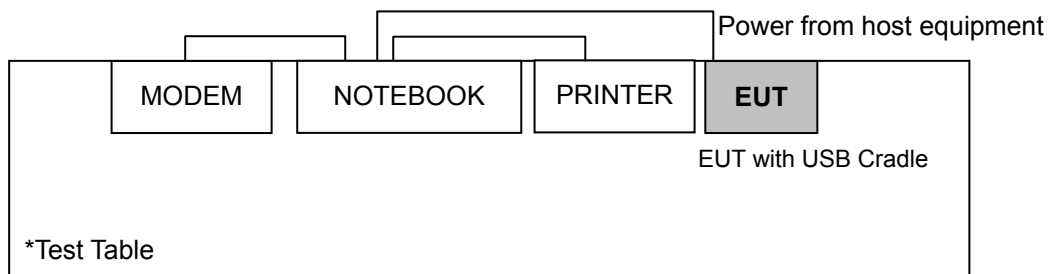



4. TEST TYPES AND RESULTS (802.11b & g 2412-2462M Band)

4.1 CONDUCTED EMISSION MEASUREMENT

4.1.1 LIMITS OF CONDUCTED EMISSION MEASUREMENT

FREQUENCY OF EMISSION (MHz)	CONDUCTED LIMIT (dB μ V)	
	Quasi-peak	Average
0.15-0.5	66 to 56	56 to 46
0.5-5	56	46
5-30	60	50

- NOTE:**
1. The lower limit shall apply at the transition frequencies.
 2. The limit decreases in line with the logarithm of the frequency in the range of 0.15 to 0.50 MHz.
 3. All emanations from a class A/B digital device or system, including any network of conductors and apparatus connected thereto, shall not exceed the level of field strengths specified above.

4.1.2 TEST INSTRUMENTS

DESCRIPTION & MANUFACTURER	MODEL NO.	SERIAL NO.	CALIBRATED UNTIL
Test Receiver ROHDE & SCHWARZ	ESCS30	100291	Nov. 16, 2005
RF signal cable Woken	5D-FB	Cable-HYC01-01	Mar. 02, 2005
LISN ROHDE & SCHWARZ	ESH3-Z5	100312	Mar. 03, 2005
LISN ROHDE & SCHWARZ	ESH2-Z5	100104	Mar. 02, 2005
Software ADT	ADT_Cond_V3	NA	NA

- NOTE:**
1. The calibration interval of the above test instruments is 12 months and the calibrations are traceable to NML/ROC and NIST/USA.
 2. The test was performed in HwaYa Shielded Room 1.
 3. The VCCI Site Registration No. is C-2040.



4.1.3 TEST PROCEDURES

- a. The EUT was placed 0.4 meters from the conducting wall of the shielded room with EUT being connected to the power mains through a line impedance stabilization network (LISN). Other support units were connected to the power mains through another LISN. The two LISNs provide 50 ohm/ 50uH of coupling impedance for the measuring instrument.
- b. Both lines of the power mains connected to the EUT were checked for maximum conducted interference.
- c. The frequency range from 150kHz to 30MHz was searched. Emission levels under (Limit - 20dB) was not recorded.

4.1.4 DEVIATION FROM TEST STANDARD

No deviation

4.1.5 TEST SETUP

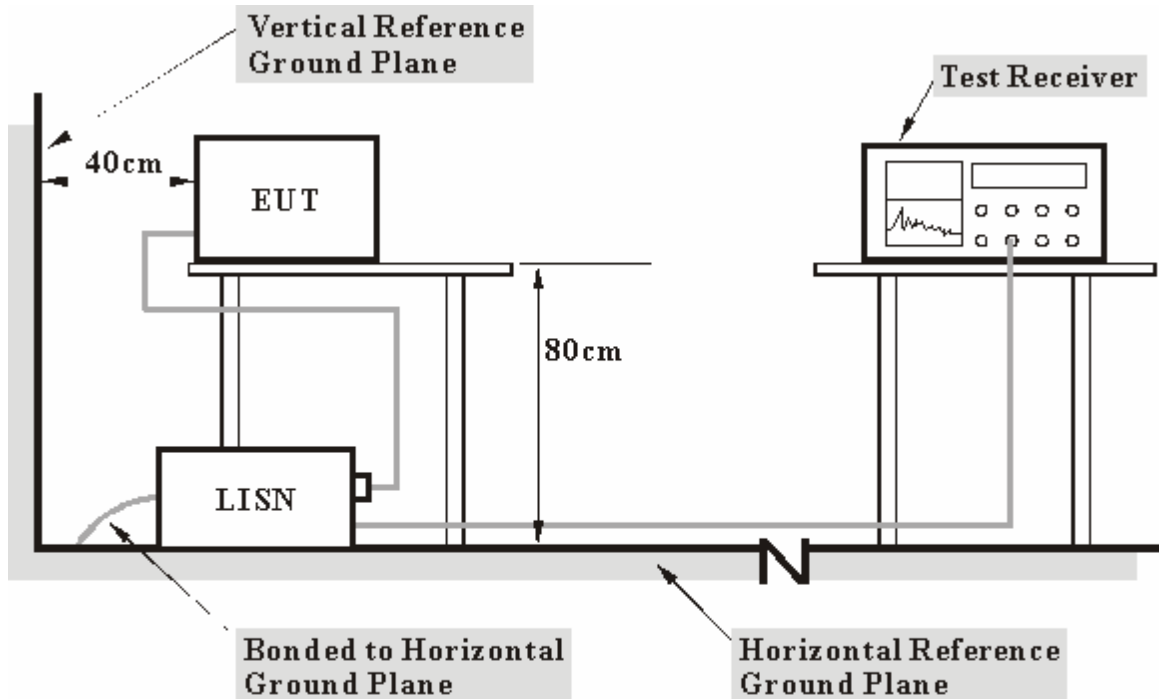

- Note:**
1. Support units were connected to second LISN.
 2. Both of LISNs (AMN) 80 cm from EUT and at the least 80 cm from other units and other metal planes support units.

For the actual test configuration, please refer to the related item – Photographs of the Test Configuration.

4.1.6 EUT OPERATING CONDITIONS

- a. Connected the EUT to a Notebook system placed on a testing table.
- b. The Notebook system ran a test program (provided by manufacturer) to enable EUT under transmission/receiving condition continuously at specific channel frequency.
- c. The Notebook system sent "H" messages to its screen.
- d. The Notebook system sent "H" messages to printer, and the printer printed them on paper.
- e. Steps c ~ d were repeated.



4.1.7 TEST RESULTS

Conducted Worst-Case Data (without Cradle)

EUT	D-Link AirPremier AG DWL-AG132 Wireless USB Adapter	MODEL	DWL-AG132
MODE	Channel 1	6dB BANDWIDTH	9 kHz
INPUT POWER (SYSTEM)	120Vac, 60Hz	PHASE	Line (L)
ENVIRONMENTAL CONDITIONS	23deg. C, 67%RH, 991hPa	TESTED BY	Steven Lu
TEST MODE	1 (Without USB Cradle)		

No	Freq. [MHz]	Corr. Factor (dB)	Reading Value [dB (uV)]		Emission Level [dB (uV)]		Limit [dB (uV)]		Margin (dB)	
			Q.P.	AV.	Q.P.	AV.	Q.P.	AV.	Q.P.	AV.
			1	0.203	0.12	47.75	-	47.87	-	63.48
2	0.306	0.12	38.43	-	38.55	-	60.07	50.07	-21.52	-
3	0.502	0.13	32.19	-	32.32	-	56.00	46.00	-23.68	-
4	3.891	0.20	32.46	-	32.66	-	56.00	46.00	-23.34	-
5	14.379	0.72	37.71	-	38.43	-	60.00	50.00	-21.57	-
6	22.426	1.09	29.04	-	30.13	-	60.00	50.00	-29.87	-

- REMARKS:**
1. Q.P. and AV. are abbreviations of quasi-peak and average individually.
 2. "-": The Quasi-peak reading value also meets average limit and measurement with the average detector is unnecessary.
 3. The emission levels of other frequencies were very low against the limit.
 4. Margin value = Emission level - Limit value
 5. Correction factor = Insertion loss + Cable loss
 6. Emission Level = Correction Factor + Reading Value.

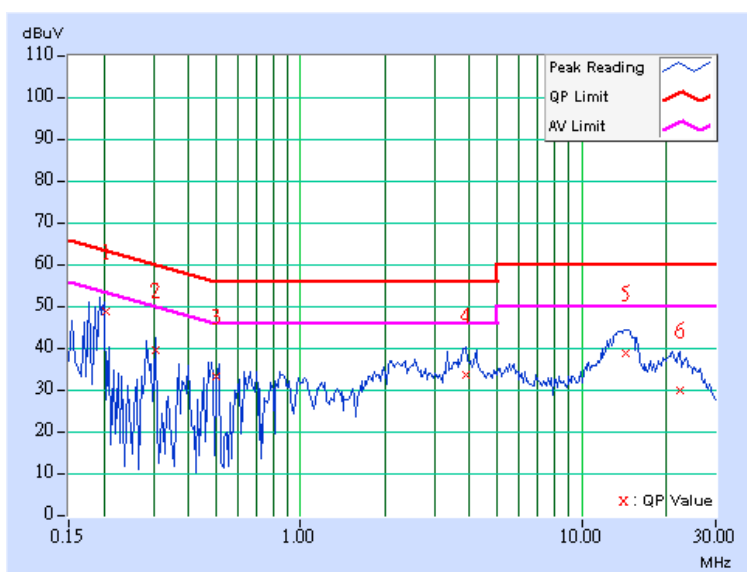



EUT	D-Link AirPremier AG DWL-AG132 Wireless USB Adapter	MODEL	DWL-AG132
MODE	Channel 1	6dB BANDWIDTH	9 kHz
INPUT POWER (SYSTEM)	120Vac, 60Hz	PHASE	Neutral (N)
ENVIRONMENTAL CONDITIONS	23deg. C, 67%RH, 991hPa	TESTED BY	Steven Lu
TEST MODE	1 (Without USB Cradle)		

No	Freq. [MHz]	Corr. Factor (dB)	Reading Value		Emission Level		Limit		Margin	
			[dB (uV)]		[dB (uV)]		[dB (uV)]		(dB)	
			Q.P.	AV.	Q.P.	AV.	Q.P.	AV.	Q.P.	AV.
1	0.217	0.11	45.92	-	46.03	-	62.95	52.95	-16.92	-
2	0.318	0.11	38.07	-	38.18	-	59.76	49.76	-21.58	-
3	1.668	0.16	33.00	-	33.16	-	56.00	46.00	-22.84	-
4	3.762	0.20	31.93	-	32.13	-	56.00	46.00	-23.87	-
5	14.711	0.62	35.45	-	36.07	-	60.00	50.00	-23.93	-
6	19.969	0.71	28.70	-	29.41	-	60.00	50.00	-30.59	-

- REMARKS:**
1. Q.P. and AV. are abbreviations of quasi-peak and average individually.
 2. "-": The Quasi-peak reading value also meets average limit and measurement with the average detector is unnecessary.
 3. The emission levels of other frequencies were very low against the limit.
 4. Margin value = Emission level - Limit value
 5. Correction factor = Insertion loss + Cable loss
 6. Emission Level = Correction Factor + Reading Value.

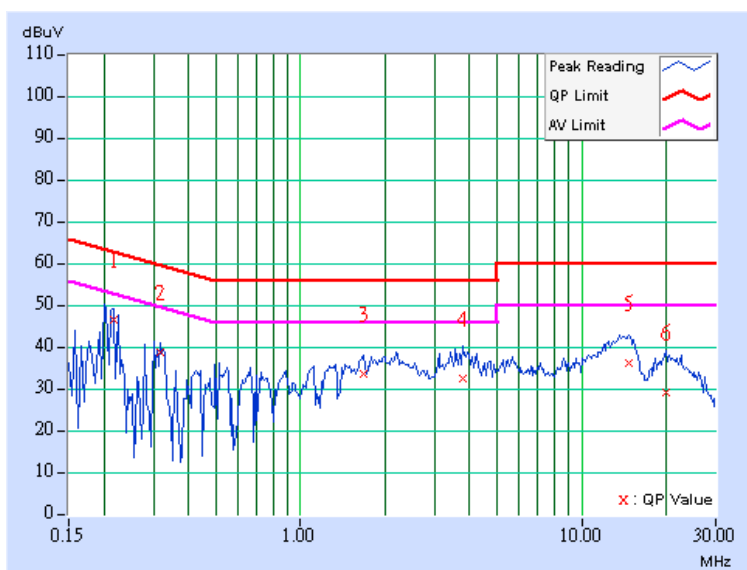



EUT	D-Link AirPremier AG DWL-AG132 Wireless USB Adapter	MODEL	DWL-AG132
MODE	Channel 6	6dB BANDWIDTH	9 kHz
INPUT POWER (SYSTEM)	120Vac, 60Hz	PHASE	Line (L)
ENVIRONMENTAL CONDITIONS	23deg. C, 67%RH, 991hPa	TESTED BY	Steven Lu
TEST MODE	1 (Without USB Cradle)		

No	Freq. [MHz]	Corr. Factor (dB)	Reading Value [dB (uV)]		Emission Level [dB (uV)]		Limit [dB (uV)]		Margin (dB)	
			Q.P.	AV.	Q.P.	AV.	Q.P.	AV.	Q.P.	AV.
			1	0.232	0.12	45.43	-	45.55	-	62.38
2	0.353	0.13	36.85	-	36.98	-	58.89	48.89	-21.91	-
3	0.591	0.13	33.33	-	33.46	-	56.00	46.00	-22.54	-
4	2.336	0.17	33.09	-	33.26	-	56.00	46.00	-22.74	-
5	15.219	0.79	33.89	-	34.68	-	60.00	50.00	-25.32	-
6	22.750	1.10	27.84	-	28.94	-	60.00	50.00	-31.06	-

- REMARKS:**
1. Q.P. and AV. are abbreviations of quasi-peak and average individually.
 2. "-": The Quasi-peak reading value also meets average limit and measurement with the average detector is unnecessary.
 3. The emission levels of other frequencies were very low against the limit.
 4. Margin value = Emission level - Limit value
 5. Correction factor = Insertion loss + Cable loss
 6. Emission Level = Correction Factor + Reading Value.

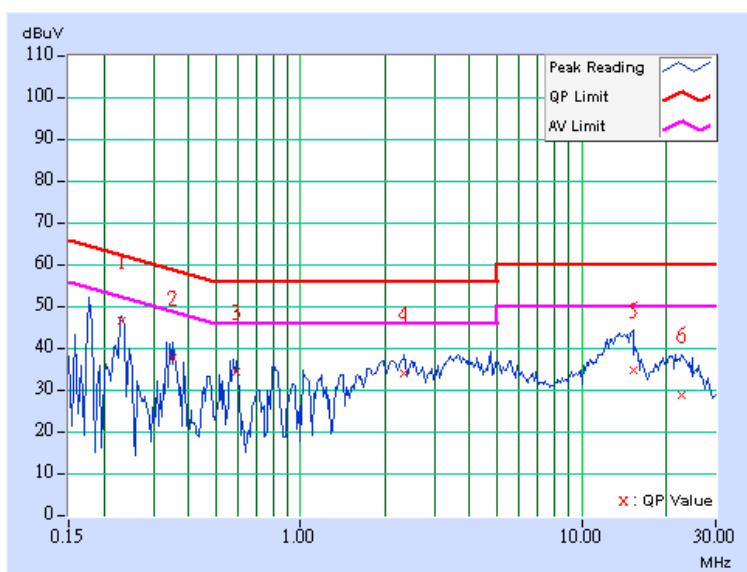



EUT	D-Link AirPremier AG DWL-AG132 Wireless USB Adapter	MODEL	DWL-AG132
MODE	Channel 6	6dB BANDWIDTH	9 kHz
INPUT POWER (SYSTEM)	120Vac, 60Hz	PHASE	Neutral (N)
ENVIRONMENTAL CONDITIONS	23deg. C, 67%RH, 991hPa	TESTED BY	Steven Lu
TEST MODE	1 (Without USB Cradle)		

No	Freq. [MHz]	Corr. Factor (dB)	Reading Value [dB (uV)]		Emission Level [dB (uV)]		Limit [dB (uV)]		Margin (dB)	
			Q.P.	AV.	Q.P.	AV.	Q.P.	AV.	Q.P.	AV.
			1	0.231	0.11	44.62	-	44.73	-	62.42
2	0.345	0.11	36.14	-	36.25	-	59.08	49.08	-22.82	-
3	1.773	0.16	33.48	-	33.64	-	56.00	46.00	-22.36	-
4	3.887	0.20	30.39	-	30.59	-	56.00	46.00	-25.41	-
5	14.637	0.61	34.62	-	35.23	-	60.00	50.00	-24.77	-
6	21.504	0.70	28.54	-	29.24	-	60.00	50.00	-30.76	-

- REMARKS:**
1. Q.P. and AV. are abbreviations of quasi-peak and average individually.
 2. "-": The Quasi-peak reading value also meets average limit and measurement with the average detector is unnecessary.
 3. The emission levels of other frequencies were very low against the limit.
 4. Margin value = Emission level - Limit value
 5. Correction factor = Insertion loss + Cable loss
 6. Emission Level = Correction Factor + Reading Value.

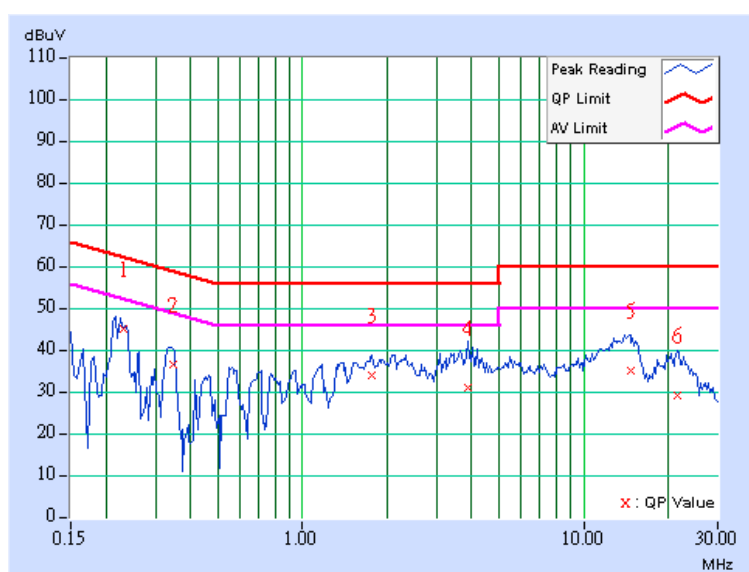



EUT	D-Link AirPremier AG DWL-AG132 Wireless USB Adapter	MODEL	DWL-AG132
MODE	Channel 11	6dB BANDWIDTH	9 kHz
INPUT POWER (SYSTEM)	120Vac, 60Hz	PHASE	Line (L)
ENVIRONMENTAL CONDITIONS	23deg. C, 67%RH, 991hPa	TESTED BY	Steven Lu
TEST MODE	1 (Without USB Cradle)		

No	Freq. [MHz]	Corr. Factor (dB)	Reading Value [dB (uV)]		Emission Level [dB (uV)]		Limit [dB (uV)]		Margin (dB)	
			Q.P.	AV.	Q.P.	AV.	Q.P.	AV.	Q.P.	AV.
			1	0.232	0.12	43.30	-	43.42	-	62.38
2	0.357	0.13	38.10	-	38.23	-	58.80	48.80	-20.57	-
3	0.595	0.13	34.80	-	34.93	-	56.00	46.00	-21.07	-
4	2.375	0.17	31.60	-	31.77	-	56.00	46.00	-24.23	-
5	13.918	0.68	36.41	-	37.09	-	60.00	50.00	-22.91	-
6	23.098	1.11	26.99	-	28.10	-	60.00	50.00	-31.90	-

- REMARKS:**
1. Q.P. and AV. are abbreviations of quasi-peak and average individually.
 2. "-": The Quasi-peak reading value also meets average limit and measurement with the average detector is unnecessary.
 3. The emission levels of other frequencies were very low against the limit.
 4. Margin value = Emission level - Limit value
 5. Correction factor = Insertion loss + Cable loss
 6. Emission Level = Correction Factor + Reading Value.

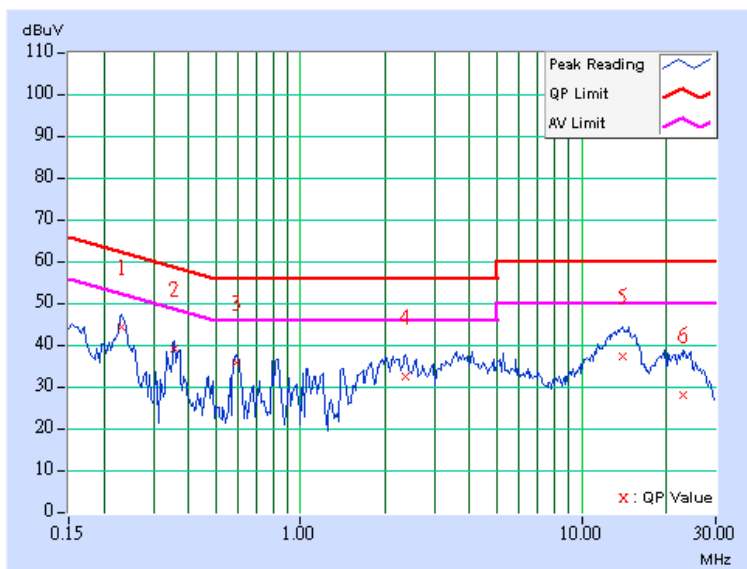



EUT	D-Link AirPremier AG DWL-AG132 Wireless USB Adapter	MODEL	DWL-AG132
MODE	Channel 11	6dB BANDWIDTH	9 kHz
INPUT POWER (SYSTEM)	120Vac, 60Hz	PHASE	Neutral (N)
ENVIRONMENTAL CONDITIONS	23deg. C, 67%RH, 991hPa	TESTED BY	Steven Lu
TEST MODE	1 (Without USB Cradle)		

No	Freq. [MHz]	Corr. Factor (dB)	Reading Value [dB (uV)]		Emission Level [dB (uV)]		Limit [dB (uV)]		Margin (dB)	
			Q.P.	AV.	Q.P.	AV.	Q.P.	AV.	Q.P.	AV.
			1	0.224	0.11	43.24	-	43.35	-	62.66
2	0.377	0.12	35.65	-	35.77	-	58.35	48.35	-22.59	-
3	0.600	0.12	34.44	-	34.56	-	56.00	46.00	-21.44	-
4	2.027	0.16	31.66	-	31.82	-	56.00	46.00	-24.18	-
5	14.887	0.63	33.04	-	33.67	-	60.00	50.00	-26.33	-
6	22.746	0.69	25.99	-	26.68	-	60.00	50.00	-33.32	-

- REMARKS:**
1. Q.P. and AV. are abbreviations of quasi-peak and average individually.
 2. "-": The Quasi-peak reading value also meets average limit and measurement with the average detector is unnecessary.
 3. The emission levels of other frequencies were very low against the limit.
 4. Margin value = Emission level - Limit value
 5. Correction factor = Insertion loss + Cable loss
 6. Emission Level = Correction Factor + Reading Value.

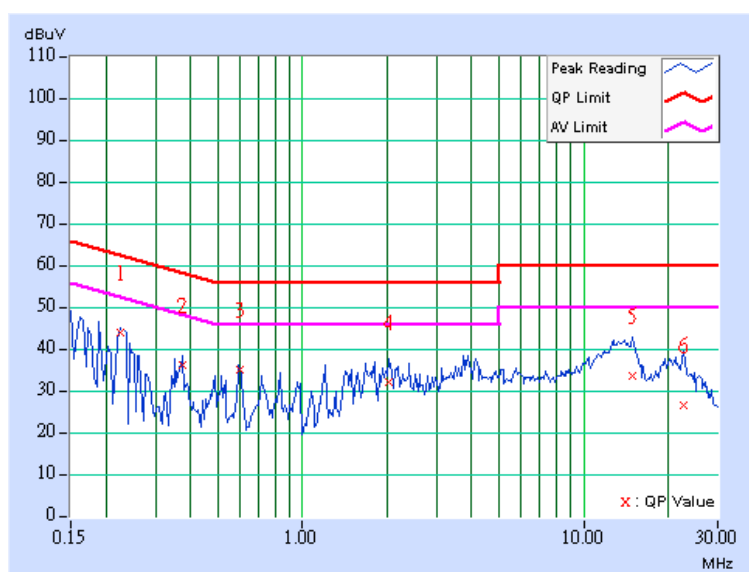



Conducted Worst-Case Data (with Cradle)

EUT	D-Link AirPremier AG DWL-AG132 Wireless USB Adapter	MODEL	DWL-AG132
MODE	Channel 1	6dB BANDWIDTH	9 kHz
INPUT POWER (SYSTEM)	120Vac, 60Hz	PHASE	Line (L)
ENVIRONMENTAL CONDITIONS	20deg. C, 60%RH, 991hPa	TESTED BY	Match Tsui
TEST MODE	2 (With USB Cradle)		

No	Freq. [MHz]	Corr. Factor (dB)	Reading Value [dB (uV)]		Emission Level [dB (uV)]		Limit [dB (uV)]		Margin (dB)	
			Q.P.	AV.	Q.P.	AV.	Q.P.	AV.	Q.P.	AV.
			1	0.185	0.12	43.38	-	43.50	-	64.25
2	0.213	0.12	42.89	-	43.01	-	63.11	53.11	-20.10	-
3	0.490	0.13	23.41	-	23.54	-	56.17	46.17	-32.63	-
4	1.613	0.16	30.54	-	30.70	-	56.00	46.00	-25.30	-
5	3.938	0.21	27.20	-	27.41	-	56.00	46.00	-28.59	-
6	10.086	0.31	35.94	-	36.25	-	60.00	50.00	-23.75	-

- REMARKS:**
1. Q.P. and AV. are abbreviations of quasi-peak and average individually.
 2. "-": The Quasi-peak reading value also meets average limit and measurement with the average detector is unnecessary.
 3. The emission levels of other frequencies were very low against the limit.
 4. Margin value = Emission level - Limit value
 5. Correction factor = Insertion loss + Cable loss
 6. Emission Level = Correction Factor + Reading Value.

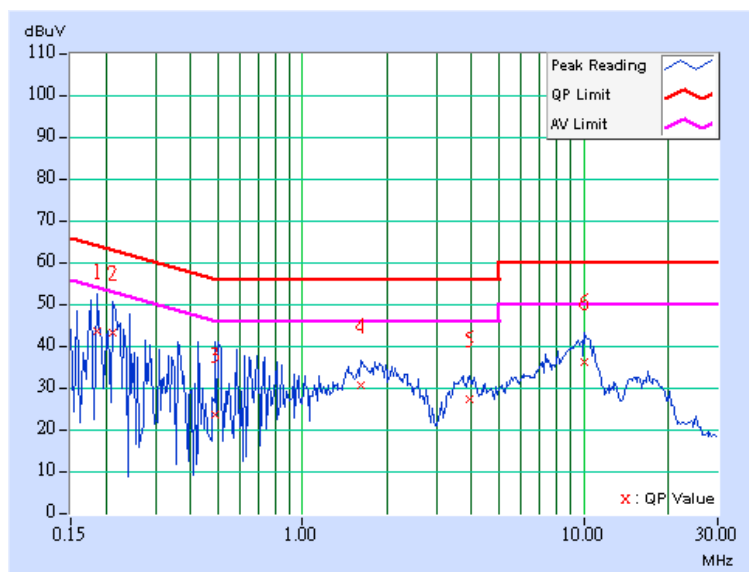



EUT	D-Link AirPremier AG DWL-AG132 Wireless USB Adapter	MODEL	DWL-AG132
MODE	Channel 1	6dB BANDWIDTH	9 kHz
INPUT POWER (SYSTEM)	120Vac, 60Hz	PHASE	Neutral (N)
ENVIRONMENTAL CONDITIONS	20deg. C, 60%RH, 991hPa	TESTED BY	Match Tsui
TEST MODE	2 (With USB Cradle)		

No	Freq. [MHz]	Corr. Factor (dB)	Reading Value [dB (uV)]		Emission Level [dB (uV)]		Limit [dB (uV)]		Margin (dB)	
			Q.P.	AV.	Q.P.	AV.	Q.P.	AV.	Q.P.	AV.
			1	0.193	0.11	45.11	-	45.22	-	63.91
2	0.388	0.12	25.56	-	25.68	-	58.10	48.10	-32.42	-
3	1.844	0.16	31.07	-	31.23	-	56.00	46.00	-24.77	-
4	3.656	0.19	25.25	-	25.44	-	56.00	46.00	-30.56	-
5	9.766	0.28	35.41	-	35.69	-	60.00	50.00	-24.31	-
6	17.938	0.68	26.00	-	26.68	-	60.00	50.00	-33.32	-

- REMARKS:**
1. Q.P. and AV. are abbreviations of quasi-peak and average individually.
 2. "-": The Quasi-peak reading value also meets average limit and measurement with the average detector is unnecessary.
 3. The emission levels of other frequencies were very low against the limit.
 4. Margin value = Emission level - Limit value
 5. Correction factor = Insertion loss + Cable loss
 6. Emission Level = Correction Factor + Reading Value.

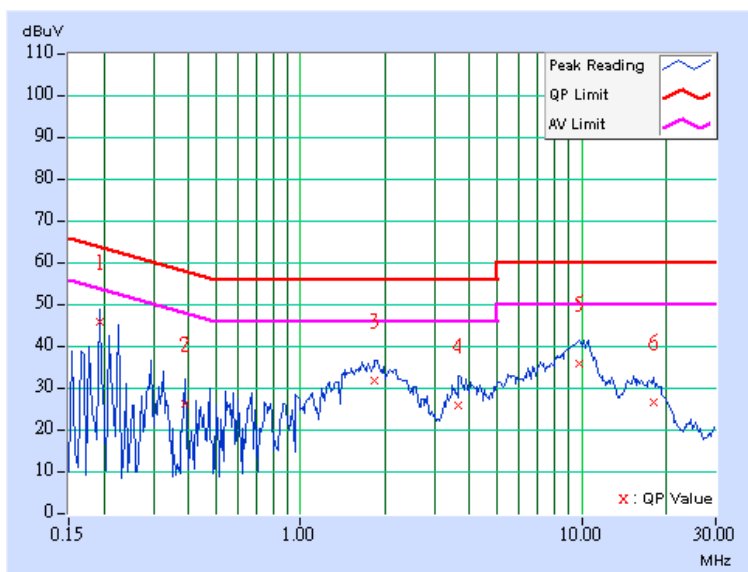



EUT	D-Link AirPremier AG DWL-AG132 Wireless USB Adapter	MODEL	DWL-AG132
MODE	Channel 6	6dB BANDWIDTH	9 kHz
INPUT POWER (SYSTEM)	120Vac, 60Hz	PHASE	Line (L)
ENVIRONMENTAL CONDITIONS	20deg. C, 60%RH, 991hPa	TESTED BY	Match Tsui
TEST MODE	2 (With USB Cradle)		

No	Freq. [MHz]	Corr. Factor (dB)	Reading Value [dB (uV)]		Emission Level [dB (uV)]		Limit [dB (uV)]		Margin (dB)	
			Q.P.	AV.	Q.P.	AV.	Q.P.	AV.	Q.P.	AV.
			1	0.197	0.12	45.15	-	45.27	-	63.74
2	0.220	0.12	43.01	-	43.13	-	62.81	52.81	-19.68	-
3	1.910	0.16	31.63	-	31.79	-	56.00	46.00	-24.21	-
4	3.703	0.20	27.71	-	27.91	-	56.00	46.00	-28.09	-
5	9.750	0.30	35.41	-	35.71	-	60.00	50.00	-24.29	-
6	18.195	0.93	26.30	-	27.23	-	60.00	50.00	-32.77	-

- REMARKS:**
1. Q.P. and AV. are abbreviations of quasi-peak and average individually.
 2. "-": The Quasi-peak reading value also meets average limit and measurement with the average detector is unnecessary.
 3. The emission levels of other frequencies were very low against the limit.
 4. Margin value = Emission level - Limit value
 5. Correction factor = Insertion loss + Cable loss
 6. Emission Level = Correction Factor + Reading Value.

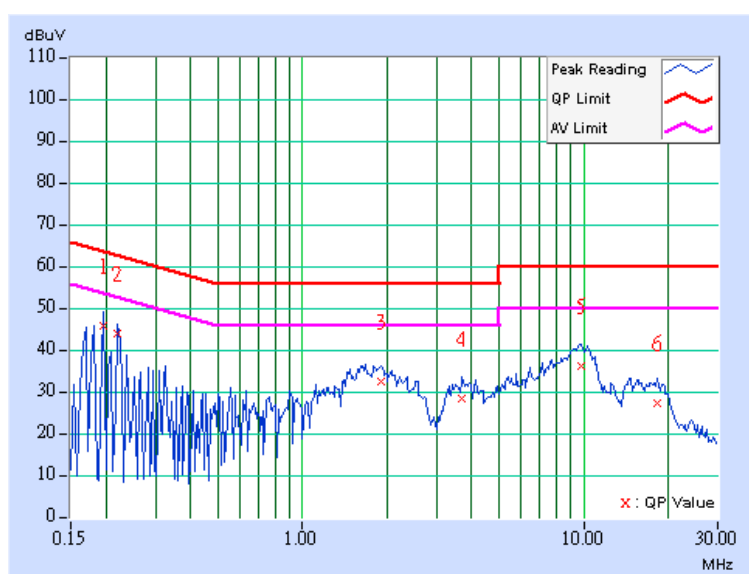



EUT	D-Link AirPremier AG DWL-AG132 Wireless USB Adapter	MODEL	DWL-AG132
MODE	Channel 6	6dB BANDWIDTH	9 kHz
INPUT POWER (SYSTEM)	120Vac, 60Hz	PHASE	Neutral (N)
ENVIRONMENTAL CONDITIONS	20deg. C, 60%RH, 991hPa	TESTED BY	Match Tsui
TEST MODE	2 (With USB Cradle)		

No	Freq. [MHz]	Corr. Factor (dB)	Reading Value [dB (uV)]		Emission Level [dB (uV)]		Limit [dB (uV)]		Margin (dB)	
			Q.P.	AV.	Q.P.	AV.	Q.P.	AV.	Q.P.	AV.
			1	0.184	0.11	40.37	-	40.48	-	64.32
2	0.220	0.11	43.85	-	43.96	-	62.81	52.81	-18.85	-
3	1.816	0.16	30.18	-	30.34	-	56.00	46.00	-25.66	-
4	3.871	0.20	25.69	-	25.89	-	56.00	46.00	-30.11	-
5	9.879	0.28	35.70	-	35.98	-	60.00	50.00	-24.02	-
6	17.469	0.67	26.26	-	26.93	-	60.00	50.00	-33.07	-

- REMARKS:**
1. Q.P. and AV. are abbreviations of quasi-peak and average individually.
 2. "-": The Quasi-peak reading value also meets average limit and measurement with the average detector is unnecessary.
 3. The emission levels of other frequencies were very low against the limit.
 4. Margin value = Emission level - Limit value
 5. Correction factor = Insertion loss + Cable loss
 6. Emission Level = Correction Factor + Reading Value.

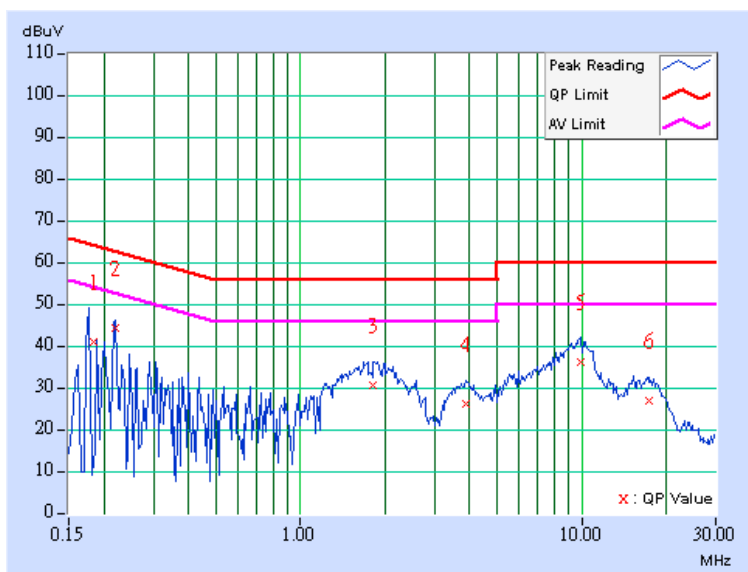



EUT	D-Link AirPremier AG DWL-AG132 Wireless USB Adapter	MODEL	DWL-AG132
MODE	Channel 11	6dB BANDWIDTH	9 kHz
INPUT POWER (SYSTEM)	120Vac, 60Hz	PHASE	Line (L)
ENVIRONMENTAL CONDITIONS	20deg. C, 60%RH, 991hPa	TESTED BY	Match Tsui
TEST MODE	2 (With USB Cradle)		

No	Freq. [MHz]	Corr. Factor (dB)	Reading Value [dB (uV)]		Emission Level [dB (uV)]		Limit [dB (uV)]		Margin (dB)	
			Q.P.	AV.	Q.P.	AV.	Q.P.	AV.	Q.P.	AV.
			1	0.214	0.12	43.26	-	43.38	-	63.06
2	0.384	0.13	33.91	-	34.04	-	58.18	48.18	-24.15	-
3	1.691	0.16	31.78	-	31.94	-	56.00	46.00	-24.06	-
4	3.875	0.20	25.06	-	25.26	-	56.00	46.00	-30.74	-
5	10.227	0.32	36.58	-	36.90	-	60.00	50.00	-23.10	-
6	18.309	0.94	27.18	-	28.12	-	60.00	50.00	-31.88	-

- REMARKS:**
1. Q.P. and AV. are abbreviations of quasi-peak and average individually.
 2. "-": The Quasi-peak reading value also meets average limit and measurement with the average detector is unnecessary.
 3. The emission levels of other frequencies were very low against the limit.
 4. Margin value = Emission level - Limit value
 5. Correction factor = Insertion loss + Cable loss
 6. Emission Level = Correction Factor + Reading Value.

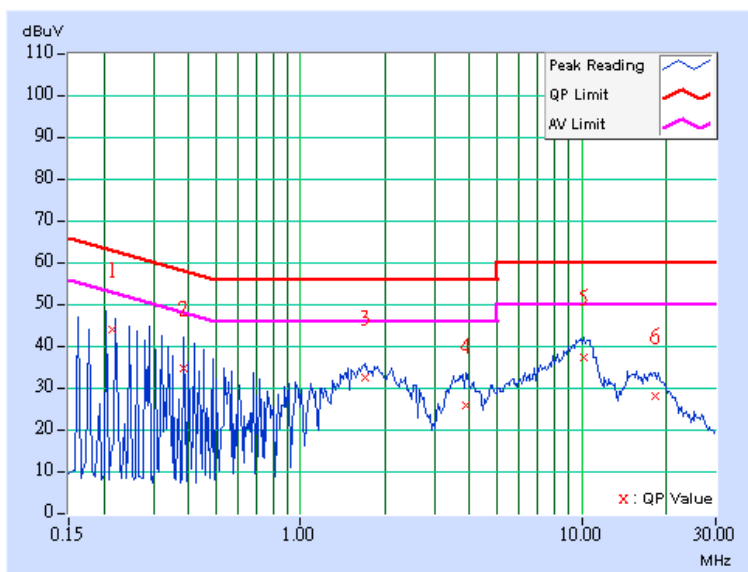



EUT	D-Link AirPremier AG DWL-AG132 Wireless USB Adapter	MODEL	DWL-AG132
MODE	Channel 11	6dB BANDWIDTH	9 kHz
INPUT POWER (SYSTEM)	120Vac, 60Hz	PHASE	Neutral (N)
ENVIRONMENTAL CONDITIONS	20deg. C, 60%RH, 991hPa	TESTED BY	Match Tsui
TEST MODE	2 (With USB Cradle)		

No	Freq. [MHz]	Corr. Factor (dB)	Reading Value [dB (uV)]		Emission Level [dB (uV)]		Limit [dB (uV)]		Margin (dB)	
			Q.P.	AV.	Q.P.	AV.	Q.P.	AV.	Q.P.	AV.
			1	0.189	0.11	42.59	-	42.70	-	64.08
2	0.236	0.11	43.82	-	43.93	-	62.24	52.24	-18.31	-
3	1.813	0.16	28.90	-	29.06	-	56.00	46.00	-26.94	-
4	3.676	0.19	25.74	-	25.93	-	56.00	46.00	-30.07	-
5	10.328	0.30	37.09	-	37.39	-	60.00	50.00	-22.61	-
6	18.125	0.68	27.37	-	28.05	-	60.00	50.00	-31.95	-

- REMARKS:**
1. Q.P. and AV. are abbreviations of quasi-peak and average individually.
 2. "-": The Quasi-peak reading value also meets average limit and measurement with the average detector is unnecessary.
 3. The emission levels of other frequencies were very low against the limit.
 4. Margin value = Emission level - Limit value
 5. Correction factor = Insertion loss + Cable loss
 6. Emission Level = Correction Factor + Reading Value.

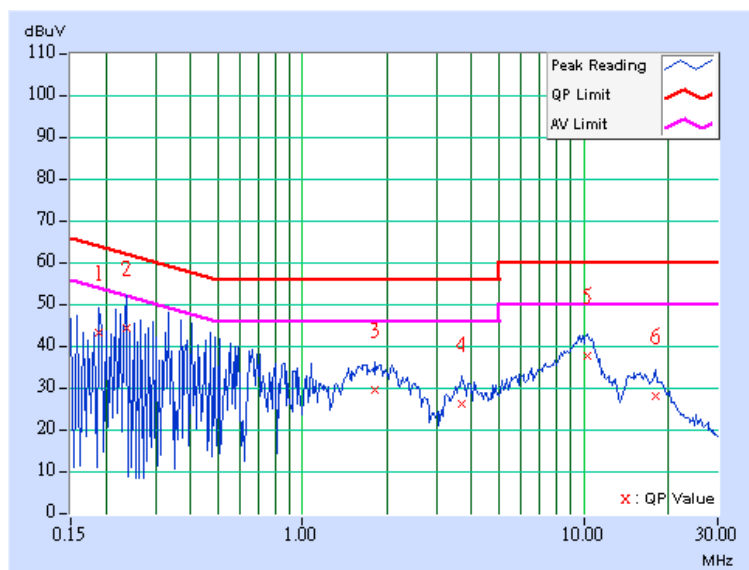



4.2 RADIATED EMISSION MEASUREMENT

4.2.1 LIMITS OF RADIATED EMISSION MEASUREMENT

Emissions radiated outside of the specified bands, shall be according to the general radiated limits in 15.209 as following:

Frequencies (MHz)	Field strength (microvolts/meter)	Measurement distance (meters)
0.009-0.490	2400/F(kHz)	300
0.490-1.705	24000/F(kHz)	30
1.705-30.0	30	30
30-88	100	3
88-216	150	3
216-960	200	3
Above 960	500	3

NOTE:

1. The lower limit shall apply at the transition frequencies.
2. Emission level (dBuV/m) = 20 log Emission level (uV/m).
3. As shown in 15.35(b), for frequencies above 1000MHz, the field strength limits are based on average detector, however, the peak field strength of any emission shall not exceed the maximum permitted average limits, specified above by more than 20dB under any condition of modulation.



4.2.2 TEST INSTRUMENTS

DESCRIPTION & MANUFACTURER	MODEL NO.	SERIAL NO.	CALIBRATED UNTIL
Test Receiver ROHDE & SCHWARZ	ESIB7	100188	Jan. 13, 2005
Spectrum Analyzer ROHDE & SCHWARZ	FSP40	100039	Nov. 21, 2005
BILOG Antenna SCHWARZBECK	VULB9168	9168-157	Feb. 03, 2005
HORN Antenna SCHWARZBECK	BBHA 9120 D	9120D-407	Feb. 03, 2005
HORN Antenna SCHWARZBECK	BBHA 9170	BBHA 9170241	Feb. 23, 2005
Preamplifier Agilent	8449B	3008A01961	Nov. 09, 2005
Preamplifier Agilent	8447D	2944A10629	Nov. 09, 2005
RF signal cable HUBER+SUHNER	SUCOFLEX 104	218182/4	Mar. 04, 2005
RF signal cable HUBER+SUHNER	SUCOFLEX 104	218194/4	Mar. 04, 2005
Software ADT.	ADT_Radiated_V5.14	NA	NA
Antenna Tower ADT.	AT100	AT93021702	NA
Turn Table ADT.	TT100.	TT93021702	NA
Controller ADT.	SC100.	SC93021702	NA

- NOTE:**
1. The calibration interval of the above test instruments is 12 months and the calibrations are traceable to NML/ROC and NIST/USA.
 2. The test was performed in HwaYa Chamber 1.
 3. The horn antenna and HP preamplifier (model: 8449B) are used only for the measurement of emission frequency above 1GHz if tested.
 4. The IC Site Registration No. is IC4924-2.



4.2.3 TEST PROCEDURES

- a. The EUT was placed on the top of a rotating table 0.8 meters above the ground at a 3 meter semi- anechoic. The table was rotated 360 degrees to determine the position of the highest radiation.
- b. The EUT was set 3 meters away from the interference-receiving antenna, which was mounted on the top of a variable-height antenna tower.
- c. The antenna is a broadband antenna, and its height is varied from one meter to four meters above the ground to determine the maximum value of the field strength. Both horizontal and vertical polarizations of the antenna are set to make the measurement.
- d. For each suspected emission, the EUT was arranged to its worst case and then the antenna was tuned to heights from 1 meter to 4 meters and the rotatable table was turned from 0 degrees to 360 degrees to find the maximum reading.
- e. The test-receiver system was set to Peak Detect Function and Specified Bandwidth with Maximum Hold Mode.
- f. If the emission level of the EUT in peak mode was 10 dB lower than the limit specified, then testing could be stopped and the peak values of the EUT would be reported. Otherwise the emissions that did not have 10 dB margin would be re-tested one by one using the quasi-peak method or average method as specified and then reported in Data sheet peak mode and QP mode.

NOTE:

1. The resolution bandwidth and video bandwidth of test receiver/spectrum analyzer is 120kHz for Quasi-peak detection at frequency below 1GHz.
2. The resolution bandwidth and video bandwidth of test receiver/spectrum analyzer is 1 MHz for Peak detection (PK) at frequency above 1GHz.
3. The resolution bandwidth of test receiver/spectrum analyzer is 1 MHz and the video bandwidth is 10 Hz for Average detection (AV) at frequency above 1GHz.

4.2.4 DEVIATION FROM TEST STANDARD

No deviation

4.2.5 TEST SETUP

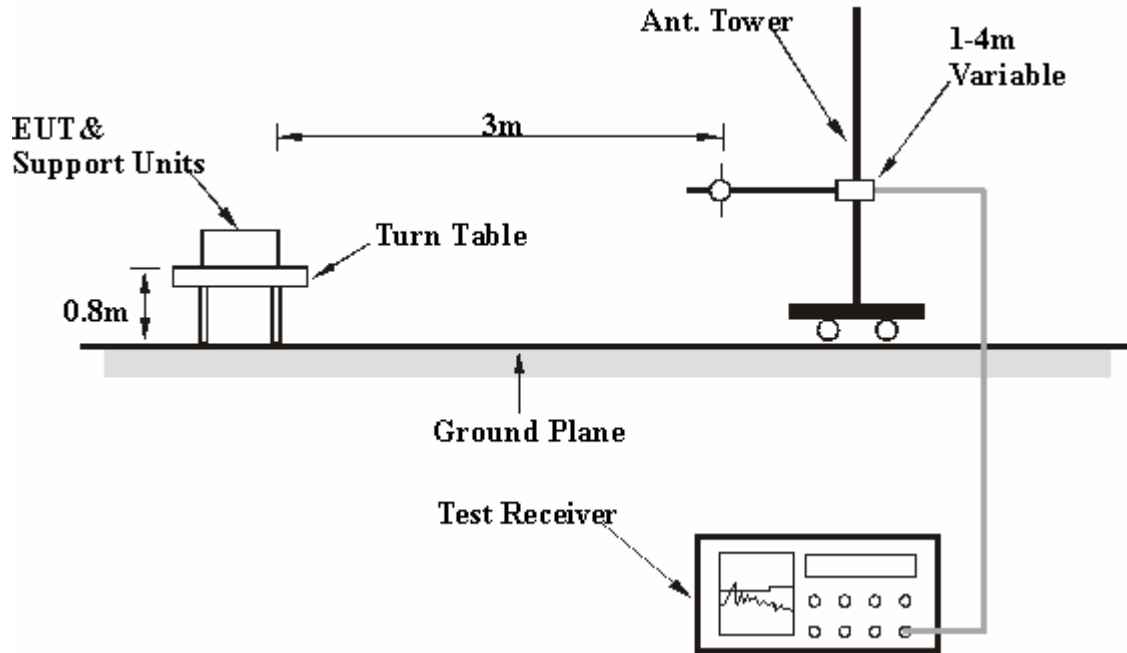

For the actual test configuration, please refer to the related item – Photographs of the Test Configuration.

4.2.6 EUT OPERATING CONDITIONS

Same as 4.1.6



4.2.7 TEST RESULTS

Below 1G worst-case data (without Cradle)

EUT	D-Link AirPremier AG DWL-AG132 Wireless USB Adapter	MODEL	DWL-AG132
FREQUENCY RANGE	Below 1000MHz	DETECTOR FUNCTION	Quasi-Peak
ENVIRONMENTAL CONDITIONS	25deg. C, 60%RH, 991hPa	INPUT POWER (SYSTEM)	120Vac, 60 Hz
TEST MODE	1 (Without USB Cradle)	TESTED BY	Match Tsui

ANTENNA POLARITY & TEST DISTANCE: HORIZONTAL AT 3 M

No.	Freq. (MHz)	Emission Level (dBuV/m)	Limit (dBuV/m)	Margin (dB)	Antenna Height (m)	Table Angle (Degree)	Raw Value (dBuV)	Correction Factor (dB/m)
1	115.53	37.75 QP	43.50	-5.75	1.50 H	46	25.17	12.57
2	168.02	32.41 QP	43.50	-11.09	1.50 H	241	18.29	14.12
3	199.12	35.30 QP	43.50	-8.20	1.50 H	268	23.84	11.46
4	249.66	28.14 QP	46.00	-17.86	1.00 H	268	14.93	13.22
5	356.57	32.81 QP	46.00	-13.19	1.00 H	277	17.02	15.79
6	455.71	30.38 QP	46.00	-15.62	2.00 H	79	12.23	18.15
7	500.42	33.13 QP	46.00	-12.87	1.50 H	337	14.39	18.74
8	533.47	27.38 QP	46.00	-18.62	1.50 H	16	8.01	19.37
9	599.56	33.18 QP	46.00	-12.82	1.50 H	82	12.18	21.00
10	667.60	31.89 QP	46.00	-14.11	1.50 H	220	9.99	21.90
11	731.74	33.95 QP	46.00	-12.05	1.00 H	310	10.86	23.08
12	760.90	33.57 QP	46.00	-12.43	2.00 H	49	9.98	23.59
13	799.78	32.89 QP	46.00	-13.11	1.00 H	43	9.07	23.82
14	863.93	34.51 QP	46.00	-11.49	2.50 H	64	10.06	24.45
15	961.12	34.07 QP	54.00	-19.93	1.50 H	247	8.39	25.68

- REMARKS:**
1. Emission level(dBuV/m)=Raw Value(dBuV) + Correction Factor(dB/m)
 2. Correction Factor(dB/m) = Antenna Factor (dB/m) + Cable Factor (dB)
 3. The other emission levels were very low against the limit.
 4. Margin value = Emission level – Limit value



EUT	D-Link AirPremier AG DWL-AG132 Wireless USB Adapter	MODEL	DWL-AG132
FREQUENCY RANGE	Below 1000MHz	DETECTOR FUNCTION	Quasi-Peak
ENVIRONMENTAL CONDITIONS	25deg. C, 60%RH, 991hPa	INPUT POWER (SYSTEM)	120Vac, 60 Hz
TEST MODE	1 (Without USB Cradle)	TESTED BY	Match Tsui

ANTENNA POLARITY & TEST DISTANCE: VERTICAL AT 3 M

No.	Freq. (MHz)	Emission Level (dBuV/m)	Limit (dBuV/m)	Margin (dB)	Antenna Height (m)	Table Angle (Degree)	Raw Value (dBuV)	Correction Factor (dB/m)
1	70.82	31.40 QP	40.00	-8.60	1.00 V	301	19.04	12.37
2	117.47	29.15 QP	43.50	-14.35	1.50 V	217	16.38	12.77
3	156.35	28.38 QP	43.50	-15.12	1.00 V	97	13.58	14.80
4	171.90	29.10 QP	43.50	-14.40	1.00 V	181	15.36	13.74
5	249.66	25.47 QP	46.00	-20.53	1.50 V	337	12.25	13.22
6	346.85	27.34 QP	46.00	-18.66	2.00 V	328	11.76	15.58
7	399.34	34.06 QP	46.00	-11.94	1.00 V	13	17.32	16.74
8	455.71	34.84 QP	46.00	-11.16	1.00 V	13	16.69	18.15
9	533.47	31.26 QP	46.00	-14.74	1.00 V	1	11.89	19.37
10	605.39	35.23 QP	46.00	-10.77	1.50 V	331	14.15	21.08
11	665.65	31.15 QP	46.00	-14.85	1.00 V	301	9.28	21.87
12	731.74	31.43 QP	46.00	-14.57	2.00 V	10	8.35	23.08
13	797.84	31.60 QP	46.00	-14.40	2.00 V	4	7.79	23.81
14	863.93	32.89 QP	46.00	-13.11	2.00 V	349	8.45	24.45
15	933.91	33.80 QP	46.00	-12.20	1.00 V	25	8.33	25.47

- REMARKS:**
1. Emission level(dBuV/m)=Raw Value(dBuV) + Correction Factor(dB/m)
 2. Correction Factor(dB/m) = Antenna Factor (dB/m) + Cable Factor (dB)
 3. The other emission levels were very low against the limit.
 4. Margin value = Emission level – Limit value



Below 1G worst-case data (with Cradle)

EUT	D-Link AirPremier AG DWL-AG132 Wireless USB Adapter	MODEL	DWL-AG132
FREQUENCY RANGE	Below 1000MHz	DETECTOR FUNCTION	Quasi-Peak
ENVIRONMENTAL CONDITIONS	21deg. C, 64%RH, 991hPa	INPUT POWER (SYSTEM)	120Vac, 60 Hz
TEST MODE	2 (With USB Cradle)	TESTED BY	Match Tsui

ANTENNA POLARITY & TEST DISTANCE: HORIZONTAL AT 3 M

No.	Freq. (MHz)	Emission Level (dBuV/m)	Limit (dBuV/m)	Margin (dB)	Antenna Height (m)	Table Angle (Degree)	Raw Value (dBuV)	Correction Factor (dB/m)
1	64.99	15.56 QP	40.00	-24.44	1.25 H	16	38.93	-23.37
2	113.59	29.90 QP	43.50	-13.60	1.50 H	268	54.98	-25.08
3	199.12	30.63 QP	43.50	-12.87	1.75 H	244	54.62	-23.99
4	350.74	33.14 QP	46.00	-12.86	1.00 H	346	50.86	-17.72
5	399.34	28.48 QP	46.00	-17.52	1.00 H	349	43.12	-14.64
6	449.88	25.47 QP	46.00	-20.53	1.75 H	319	39.99	-14.53
7	533.47	21.88 QP	46.00	-24.12	1.50 H	358	36.43	-14.55
8	595.67	26.49 QP	46.00	-19.51	1.50 H	274	39.78	-13.30
9	667.60	31.51 QP	46.00	-14.49	1.00 H	40	42.99	-11.48
10	720.08	26.92 QP	46.00	-19.08	1.75 H	7	39.42	-12.51
11	801.72	24.44 QP	46.00	-21.56	1.00 H	97	34.81	-10.37
12	863.93	24.60 QP	46.00	-21.40	1.00 H	139	33.27	-8.68
13	931.96	24.09 QP	46.00	-21.91	1.75 H	214	32.56	-8.47

- REMARKS:**
1. Emission level(dBuV/m)=Raw Value(dBuV) + Correction Factor(dB/m)
 2. Correction Factor(dB/m) = Antenna Factor (dB/m) + Cable Factor (dB)
 3. The other emission levels were very low against the limit.
 4. Margin value = Emission level – Limit value

EUT	D-Link AirPremier AG DWL-AG132 Wireless USB Adapter	MODEL	DWL-AG132
FREQUENCY RANGE	Below 1000MHz	DETECTOR FUNCTION	Quasi-Peak
ENVIRONMENTAL CONDITIONS	25deg. C, 60%RH, 991hPa	INPUT POWER (SYSTEM)	120Vac, 60 Hz
TEST MODE	2 (With USB Cradle)	TESTED BY	Match Tsui

ANTENNA POLARITY & TEST DISTANCE: VERTICAL AT 3 M

No.	Freq. (MHz)	Emission Level (dBuV/m)	Limit (dBuV/m)	Margin (dB)	Antenna Height (m)	Table Angle (Degree)	Raw Value (dBuV)	Correction Factor (dB/m)
1	64.99	29.51 QP	40.00	-10.49	1.00 V	43	48.65	-19.14
2	113.59	27.13 QP	43.50	-16.37	1.25 V	16	47.33	-20.20
3	133.03	26.38 QP	43.50	-17.12	1.00 V	229	45.33	-18.95
4	164.13	28.15 QP	43.50	-15.35	1.00 V	313	46.71	-18.57
5	199.12	28.27 QP	43.50	-15.23	1.50 V	310	46.76	-18.50
6	350.74	24.11 QP	46.00	-21.89	1.50 V	277	44.27	-20.16
7	399.34	26.08 QP	46.00	-19.92	1.25 V	280	46.40	-20.33
8	457.66	24.87 QP	46.00	-21.13	1.00 V	298	42.26	-17.39
9	533.47	19.54 QP	46.00	-26.46	1.00 V	337	35.06	-15.52
10	599.56	22.33 QP	46.00	-23.67	1.00 V	115	35.92	-13.60
11	733.69	19.41 QP	46.00	-26.59	1.50 V	262	33.28	-13.87
12	801.72	21.51 QP	46.00	-24.49	1.25 V	169	33.95	-12.45
13	935.85	23.96 QP	46.00	-22.04	1.00 V	55	31.72	-7.76

- REMARKS:**
1. Emission level(dBuV/m)=Raw Value(dBuV) + Correction Factor(dB/m)
 2. Correction Factor(dB/m) = Antenna Factor (dB/m) + Cable Factor (dB)
 3. The other emission levels were very low against the limit.
 4. Margin value = Emission level – Limit value

**802.11b CKC modulation (without Cradle)**

EUT	D-Link AirPremier AG DWL-AG132 Wireless USB Adapter	MODEL	DWL-AG132
CHANNEL	Channel 1	FREQUENCY RANGE	1 ~ 25GHz
MODE	DSSS		
INPUT POWER (SYSTEM)	120Vac, 60 Hz	DETECTOR FUNCTION	Peak(PK) Average (AV)
ENVIRONMENTAL CONDITIONS	25deg. C, 60%RH, 991hPa	TESTED BY	Match Tsui
TEST MODE	1 (Without USB Cradle)		

ANTENNA POLARITY & TEST DISTANCE: HORIZONTAL AT 3 M

No.	Freq. (MHz)	Emission Level (dBuV/m)	Limit (dBuV/m)	Margin (dB)	Antenna Height (m)	Table Angle (Degree)	Raw Value (dBuV)	Correction Factor (dB/m)
1	2360.00	58.10 PK	74.00	-15.90	1.09 H	360	26.39	31.71
1	2360.00	37.59 AV	54.00	-16.41	1.09 H	360	5.88	31.71
2	2386.00	57.15 PK	74.00	-16.85	1.06 H	21	25.36	31.79
2	2386.00	49.45 AV	54.00	-4.55	1.06 H	21	17.66	31.79
3	*2412.00	111.34 PK			1.06 H	21	79.47	31.87
3	*2412.00	103.64 AV			1.06 H	21	71.77	31.87
4	4824.00	56.77 PK	74.00	-17.23	1.01 H	204	18.66	38.11
4	4824.00	49.56 AV	54.00	-4.44	1.01 H	204	11.45	38.11
5	9648.00	56.48 PK	74.00	-17.52	1.22 H	190	14.20	42.28
5	9648.00	49.53 AV	54.00	-4.47	1.22 H	190	7.25	42.28

ANTENNA POLARITY & TEST DISTANCE: VERTICAL AT 3 M

No.	Freq. (MHz)	Emission Level (dBuV/m)	Limit (dBuV/m)	Margin (dB)	Antenna Height (m)	Table Angle (Degree)	Raw Value (dBuV)	Correction Factor (dB/m)
1	2360.00	52.61 PK	74.00	-21.39	1.09 V	34	20.90	31.71
1	2360.00	34.83 AV	54.00	-19.17	1.09 V	34	3.12	31.71
2	2386.00	49.70 PK	74.00	-24.30	1.03 V	258	17.91	31.79
2	2386.00	41.99 AV	54.00	-12.01	1.03 V	258	10.20	31.79
3	*2412.00	103.89 PK			1.03 V	258	72.02	31.87
3	*2412.00	96.18 AV			1.03 V	258	64.31	31.87
4	4824.00	54.86 PK	74.00	-19.14	1.07 V	265	16.75	38.11
4	4824.00	46.74 AV	54.00	-7.26	1.07 V	265	8.63	38.11
5	9648.00	57.85 PK	74.00	-16.15	1.14 V	121	15.57	42.28
5	9648.00	50.44 AV	54.00	-3.56	1.14 V	121	8.16	42.28

- REMARKS:**
1. Emission level(dBuV/m)=Raw Value(dBuV) + Correction Factor(dB/m)
 2. Correction Factor(dB/m) = Antenna Factor (dB/m) + Cable Factor (dB)
 3. The other emission levels were very low against the limit.
 4. Margin value = Emission level – Limit value.
 5. The limit value is defined as per 15.247
 6. " * " : Fundamental frequency



EUT	D-Link AirPremier AG DWL-AG132 Wireless USB Adapter	MODEL	DWL-AG132
CHANNEL	Channel 6	FREQUENCY RANGE	1 ~ 25GHz
MODE	DSSS		
INPUT POWER (SYSTEM)	120Vac, 60 Hz	DETECTOR FUNCTION	Peak(PK) Average (AV)
ENVIRONMENTAL CONDITIONS	25deg. C, 60%RH, 991hPa	TESTED BY	Match Tsui
TEST MODE	1 (Without USB Cradle)		

ANTENNA POLARITY & TEST DISTANCE: HORIZONTAL AT 3M

No.	Freq. (MHz)	Emission Level (dBuV/m)	Limit (dBuV/m)	Margin (dB)	Antenna Height (m)	Table Angle (Degree)	Raw Value (dBuV)	Correction Factor (dB/m)
1	2360.00	50.31 PK	74.00	-23.69	1.09 H	26	18.60	31.71
1	2360.00	40.86 AV	54.00	-13.14	1.09 H	26	9.15	31.71
2	*2437.00	111.43 PK			1.05 H	19	79.48	31.95
2	*2437.00	103.82 AV			1.05 H	19	71.87	31.95
3	4874.00	57.34 PK	74.00	-16.66	1.15 H	87	19.06	38.28
3	4874.00	50.03 AV	54.00	-3.97	1.15 H	87	11.75	38.28
4	9748.00	56.49 PK	74.00	-17.51	1.10 H	98	17.98	38.51
4	9748.00	52.29 AV	54.00	-1.71	1.10 H	98	13.78	38.51

ANTENNA POLARITY & TEST DISTANCE: VERTICAL AT 3M

No.	Freq. (MHz)	Emission Level (dBuV/m)	Limit (dBuV/m)	Margin (dB)	Antenna Height (m)	Table Angle (Degree)	Raw Value (dBuV)	Correction Factor (dB/m)
1	2360.00	46.20 PK	74.00	-27.80	1.00 V	258	14.49	31.71
1	2360.00	36.03 AV	54.00	-17.97	1.00 V	258	4.32	31.71
2	*2437.00	103.61 PK			1.00 V	341	71.66	31.95
2	*2437.00	95.92 AV			1.00 V	341	63.97	31.95
3	4874.00	56.76 PK	74.00	-17.24	1.07 V	118	18.48	38.28
3	4874.00	49.22 AV	54.00	-4.78	1.07 V	118	10.94	38.28
4	9748.00	54.91 PK	74.00	-19.09	1.03 V	175	16.40	38.51
4	9748.00	49.83 AV	54.00	-4.17	1.03 V	175	11.32	38.51

- REMARKS:**
1. Emission level(dBuV/m)=Raw Value(dBuV) + Correction Factor(dB/m)
 2. Correction Factor(dB/m) = Antenna Factor (dB/m) + Cable Factor (dB)
 3. The other emission levels were very low against the limit.
 4. Margin value = Emission level – Limit value.
 5. The limit value is defined as per 15.247
 6. “ * “ : Fundamental frequency



EUT	D-Link AirPremier AG DWL-AG132 Wireless USB Adapter	MODEL	DWL-AG132
CHANNEL	Channel 11	FREQUENCY RANGE	1 ~ 25GHz
MODE	DSSS		
INPUT POWER (SYSTEM)	120Vac, 60 Hz	DETECTOR FUNCTION	Peak(PK) Average (AV)
ENVIRONMENTAL CONDITIONS	25deg. C, 60%RH, 991hPa	TESTED BY	Match Tsui
TEST MODE	1 (Without USB Cradle)		

ANTENNA POLARITY & TEST DISTANCE: HORIZONTAL AT 3M

No.	Freq. (MHz)	Emission Level (dBuV/m)	Limit (dBuV/m)	Margin (dB)	Antenna Height (m)	Table Angle (Degree)	Raw Value (dBuV)	Correction Factor (dB/m)
1	*2462.00	111.06 PK			1.03 H	21	79.04	32.02
1	*2462.00	103.21 AV			1.03 H	21	71.19	32.02
2	2487.00	56.56 PK	74.00	-17.44	1.03 H	21	24.46	32.10
2	2487.00	48.71 AV	54.00	-5.29	1.03 H	21	16.61	32.10
3	2688.00	49.20 PK	74.00	-24.80	1.24 H	151	16.30	32.90
3	2688.00	43.18 AV	54.00	-10.82	1.24 H	151	10.28	32.90
4	4924.00	55.61 PK	74.00	-18.39	1.02 H	186	17.12	38.49
4	4924.00	48.13 AV	54.00	-5.87	1.02 H	186	9.64	38.49
5	9848.00	53.38 PK	74.00	-20.62	1.22 H	219	18.05	35.33
5	9848.00	49.14 AV	54.00	-4.86	1.22 H	219	13.81	35.33

ANTENNA POLARITY & TEST DISTANCE: VERTICAL AT 3M

No.	Freq. (MHz)	Emission Level (dBuV/m)	Limit (dBuV/m)	Margin (dB)	Antenna Height (m)	Table Angle (Degree)	Raw Value (dBuV)	Correction Factor (dB/m)
1	*2462.00	103.61 PK			1.00 V	258	71.59	32.02
1	*2462.00	96.11 AV			1.00 V	258	64.09	32.02
2	2487.00	49.77 PK	74.00	-24.23	1.00 V	258	17.67	32.10
2	2487.00	41.61 AV	54.00	-12.39	1.00 V	258	9.51	32.10
3	2688.00	45.42 PK	74.00	-28.58	1.17 V	360	12.52	32.90
3	2688.00	39.01 AV	54.00	-14.99	1.17 V	360	6.11	32.90
4	4924.00	56.90 PK	74.00	-17.10	1.00 V	199	18.41	38.49
4	4924.00	50.43 AV	54.00	-3.57	1.00 V	199	11.94	38.49
5	9848.00	54.33 PK	74.00	-19.67	1.26 V	168	19.00	35.33
5	9848.00	50.99 AV	54.00	-3.01	1.26 V	168	15.66	35.33

- REMARKS:**
1. Emission level(dBuV/m)=Raw Value(dBuV) + Correction Factor(dB/m)
 2. Correction Factor(dB/m) = Antenna Factor (dB/m) + Cable Factor (dB)
 3. The other emission levels were very low against the limit.
 4. Margin value = Emission level – Limit value.
 5. The limit value is defined as per 15.247
 6. “ * “ : Fundamental frequency

**802.11b CKC modulation (with Cradle)**

EUT	D-Link AirPremier AG DWL-AG132 Wireless USB Adapter	MODEL	DWL-AG132
CHANNEL	Channel 1	FREQUENCY RANGE	1 ~ 25GHz
MODE	DSSS		
INPUT POWER (SYSTEM)	120Vac, 60 Hz	DETECTOR FUNCTION	Peak(PK) Average (AV)
ENVIRONMENTAL CONDITIONS	22deg. C, 64%RH, 991hPa	TESTED BY	Match Tsui
TEST MODE	2 (With USB Cradle)		

ANTENNA POLARITY & TEST DISTANCE: HORIZONTAL AT 3 M

No.	Freq. (MHz)	Emission Level (dBuV/m)	Limit (dBuV/m)	Margin (dB)	Antenna Height (m)	Table Angle (Degree)	Raw Value (dBuV)	Correction Factor (dB/m)
1	2386.00	57.50 PK	74.00	-16.50	1.54 H	340	26.80	30.70
1	2386.00	46.05 AV	54.00	-7.95	1.54 H	340	15.35	30.70
2	*2412.00	105.18 PK			1.54 H	340	74.38	30.80
2	*2412.00	97.52 AV			1.54 H	340	66.72	30.80
3	4824.00	50.56 PK	74.00	-23.44	1.00 H	6	13.98	36.58
3	4824.00	43.85 AV	54.00	-10.15	1.00 H	6	7.27	36.58
4	9648.00	50.65 PK	74.00	-23.35	1.01 H	360	8.53	42.12
4	9648.00	40.45 AV	54.00	-13.55	1.01 H	360	-1.67	42.12

ANTENNA POLARITY & TEST DISTANCE: VERTICAL AT 3 M

No.	Freq. (MHz)	Emission Level (dBuV/m)	Limit (dBuV/m)	Margin (dB)	Antenna Height (m)	Table Angle (Degree)	Raw Value (dBuV)	Correction Factor (dB/m)
1	2386.00	59.91 PK	74.00	-14.09	1.10 V	327	29.21	30.70
1	2386.00	47.78 AV	54.00	-6.22	1.10 V	327	17.08	30.70
2	*2412.00	107.46 PK			1.10 V	327	76.66	30.80
2	*2412.00	99.82 AV			1.10 V	327	69.02	30.80
3	4824.00	49.96 PK	74.00	-24.04	1.27 V	352	13.38	36.58
3	4824.00	43.13 AV	54.00	-10.87	1.27 V	352	6.55	36.58
4	9648.00	57.69 PK	74.00	-16.31	1.01 V	165	15.57	42.12
4	9648.00	52.04 AV	54.00	-1.96	1.01 V	165	9.92	42.12

- REMARKS:**
1. Emission level(dBuV/m)=Raw Value(dBuV) + Correction Factor(dB/m)
 2. Correction Factor(dB/m) = Antenna Factor (dB/m) + Cable Factor (dB)
 3. The other emission levels were very low against the limit.
 4. Margin value = Emission level – Limit value.
 5. The limit value is defined as per 15.247
 6. “ * ” : Fundamental frequency



EUT	D-Link AirPremier AG DWL-AG132 Wireless USB Adapter	MODEL	DWL-AG132
CHANNEL	Channel 6	FREQUENCY RANGE	1 ~ 25GHz
MODE	DSSS		
INPUT POWER (SYSTEM)	120Vac, 60 Hz	DETECTOR FUNCTION	Peak(PK) Average (AV)
ENVIRONMENTAL CONDITIONS	22deg. C, 64%RH, 991hPa	TESTED BY	Match Tsui
TEST MODE	2 (With USB Cradle)		

ANTENNA POLARITY & TEST DISTANCE: HORIZONTAL AT 3M

No.	Freq. (MHz)	Emission Level (dBuV/m)	Limit (dBuV/m)	Margin (dB)	Antenna Height (m)	Table Angle (Degree)	Raw Value (dBuV)	Correction Factor (dB/m)
1	*2437.00	104.78 PK			1.01 H	300	73.88	30.90
1	*2437.00	97.20 AV			1.01 H	300	66.30	30.90
2	4874.00	50.18 PK	74.00	-23.82	1.00 H	310	13.42	36.76
2	4874.00	44.10 AV	54.00	-9.90	1.00 H	310	7.34	36.76
3	9748.00	51.80 PK	74.00	-22.20	1.20 H	199	13.46	38.34
3	9748.00	41.41 AV	54.00	-12.59	1.20 H	199	3.07	38.34

ANTENNA POLARITY & TEST DISTANCE: VERTICAL AT 3M

No.	Freq. (MHz)	Emission Level (dBuV/m)	Limit (dBuV/m)	Margin (dB)	Antenna Height (m)	Table Angle (Degree)	Raw Value (dBuV)	Correction Factor (dB/m)
1	*2437.00	107.12 PK			1.11 V	190	76.22	30.90
1	*2437.00	100.01 AV			1.11 V	190	69.11	30.90
2	4874.00	50.14 PK	74.00	-23.86	1.21 V	140	13.38	36.76
2	4874.00	43.56 AV	54.00	-10.44	1.21 V	140	6.80	36.76
3	9748.00	57.89 PK	74.00	-16.11	1.00 V	120	19.55	38.34
3	9748.00	52.16 AV	54.00	-1.84	1.00 V	120	13.82	38.34

- REMARKS:**
1. Emission level(dBuV/m)=Raw Value(dBuV) + Correction Factor(dB/m)
 2. Correction Factor(dB/m) = Antenna Factor (dB/m) + Cable Factor (dB)
 3. The other emission levels were very low against the limit.
 4. Margin value = Emission level – Limit value.
 5. The limit value is defined as per 15.247
 6. “ * “ : Fundamental frequency



EUT	D-Link AirPremier AG DWL-AG132 Wireless USB Adapter	MODEL	DWL-AG132
CHANNEL	Channel 11	FREQUENCY RANGE	1 ~ 25GHz
MODE	DSSS		
INPUT POWER (SYSTEM)	120Vac, 60 Hz	DETECTOR FUNCTION	Peak(PK) Average (AV)
ENVIRONMENTAL CONDITIONS	22deg. C, 64%RH, 991hPa	TESTED BY	Match Tsui
TEST MODE	2 (With USB Cradle)		

ANTENNA POLARITY & TEST DISTANCE: HORIZONTAL AT 3M

No.	Freq. (MHz)	Emission Level (dBuV/m)	Limit (dBuV/m)	Margin (dB)	Antenna Height (m)	Table Angle (Degree)	Raw Value (dBuV)	Correction Factor (dB/m)
1	*2462.00	107.12 PK			1.11 H	112	76.13	30.99
1	*2462.00	100.13 AV			1.11 H	112	69.14	30.99
2	2487.00	56.41 PK	74.00	-17.59	1.11 H	112	25.32	31.09
2	2487.00	45.29 AV	54.00	-8.71	1.11 H	112	14.20	31.09
3	4924.00	51.89 PK	74.00	-22.11	1.00 H	300	14.92	36.97
3	4924.00	44.34 AV	54.00	-9.66	1.00 H	300	7.37	36.97
4	9848.00	51.68 PK	74.00	-22.32	1.01 H	290	16.54	35.14
4	9848.00	41.40 AV	54.00	-12.60	1.01 H	290	6.26	35.14

ANTENNA POLARITY & TEST DISTANCE: VERTICAL AT 3M

No.	Freq. (MHz)	Emission Level (dBuV/m)	Limit (dBuV/m)	Margin (dB)	Antenna Height (m)	Table Angle (Degree)	Raw Value (dBuV)	Correction Factor (dB/m)
1	*2462.00	108.20 PK			1.35 V	16	77.21	30.99
1	*2462.00	101.40 AV			1.35 V	16	70.41	30.99
2	2487.00	56.21 PK	74.00	-17.79	1.38 V	16	25.12	31.09
2	2487.00	49.99 AV	54.00	-4.01	1.38 V	16	18.90	31.09
3	4924.00	56.20 PK	74.00	-17.80	1.11 V	130	19.23	36.97
3	4924.00	48.90 AV	54.00	-5.10	1.11 V	130	11.93	36.97
4	9848.00	58.12 PK	74.00	-15.88	1.04 V	320	22.98	35.14
4	9848.00	52.69 AV	54.00	-1.31	1.04 V	320	17.55	35.14

- REMARKS:**
1. Emission level(dBuV/m)=Raw Value(dBuV) + Correction Factor(dB/m)
 2. Correction Factor(dB/m) = Antenna Factor (dB/m) + Cable Factor (dB)
 3. The other emission levels were very low against the limit.
 4. Margin value = Emission level – Limit value.
 5. The limit value is defined as per 15.247
 6. “ * “ : Fundamental frequency



802.11g OFDM modulation (without Cradle)

EUT	D-Link AirPremier AG DWL-AG132 Wireless USB Adapter	MODEL	DWL-AG132
CHANNEL	Channel 1	FREQUENCY RANGE	1 ~ 25GHz
MODE	OFDM		
INPUT POWER (SYSTEM)	120Vac, 60 Hz	DETECTOR FUNCTION	Peak(PK) Average (AV)
ENVIRONMENTAL CONDITIONS	25deg. C, 60%RH, 991hPa	TESTED BY	Match Tsui
TEST MODE	1 (Without USB Cradle)		

ANTENNA POLARITY & TEST DISTANCE: HORIZONTAL AT 3 M

No.	Freq. (MHz)	Emission Level (dBuV/m)	Limit (dBuV/m)	Margin (dB)	Antenna Height (m)	Table Angle (Degree)	Raw Value (dBuV)	Correction Factor (dB/m)
1	2360.00	49.33 PK	74.00	-24.67	1.11 H	360	17.62	31.71
1	2360.00	38.12 AV	54.00	-15.88	1.11 H	360	6.41	31.71
2	2390.00	58.85 PK	74.00	-15.15	1.06 H	21	27.05	31.80
2	2390.00	48.72 AV	54.00	-5.28	1.06 H	21	16.92	31.80
3	*2412.00	108.16 PK			1.06 H	21	76.29	31.87
3	*2412.00	98.03 AV			1.06 H	21	66.16	31.87
4	4824.00	50.56 PK	74.00	-23.44	1.19 H	263	12.45	38.11
4	4824.00	38.15 AV	54.00	-15.85	1.19 H	263	0.04	38.11

ANTENNA POLARITY & TEST DISTANCE: VERTICAL AT 3 M

No.	Freq. (MHz)	Emission Level (dBuV/m)	Limit (dBuV/m)	Margin (dB)	Antenna Height (m)	Table Angle (Degree)	Raw Value (dBuV)	Correction Factor (dB/m)
1	2390.00	48.84 PK	74.00	-25.16	1.03 V	257	17.04	31.80
1	2390.00	38.86 AV	54.00	-15.14	1.03 V	257	7.06	31.80
2	*2412.00	98.15 PK			1.03 V	257	66.28	31.87
2	*2412.00	88.17 AV			1.03 V	257	56.30	31.87
3	4824.00	51.20 PK	74.00	-22.80	1.12 V	213	13.09	38.11
3	4824.00	38.50 AV	54.00	-15.50	1.12 V	213	0.39	38.11

- REMARKS:**
1. Emission level(dBuV/m)=Raw Value(dBuV) + Correction Factor(dB/m)
 2. Correction Factor(dB/m) = Antenna Factor (dB/m) + Cable Factor (dB)
 3. The other emission levels were very low against the limit.
 4. Margin value = Emission level – Limit value.
 5. The limit value is defined as per 15.247
 6. “ * “ : Fundamental frequency



EUT	D-Link AirPremier AG DWL-AG132 Wireless USB Adapter	MODEL	DWL-AG132
CHANNEL	Channel 6	FREQUENCY RANGE	1 ~ 25GHz
MODE	OFDM		
INPUT POWER (SYSTEM)	120Vac, 60 Hz	DETECTOR FUNCTION	Peak(PK) Average (AV)
ENVIRONMENTAL CONDITIONS	25deg. C, 60%RH, 991hPa	TESTED BY	Match Tsui
TEST MODE	1 (Without USB Cradle)		

ANTENNA POLARITY & TEST DISTANCE: HORIZONTAL AT 3M

No.	Freq. (MHz)	Emission Level (dBuV/m)	Limit (dBuV/m)	Margin (dB)	Antenna Height (m)	Table Angle (Degree)	Raw Value (dBuV)	Correction Factor (dB/m)
1	2360.00	54.76 PK	74.00	-19.24	1.11 H	360	23.05	31.71
1	2360.00	40.07 AV	54.00	-13.93	1.11 H	360	8.36	31.71
2	*2437.00	108.13 PK			1.05 H	360	76.18	31.95
2	*2437.00	98.07 AV			1.05 H	360	66.12	31.95
3	4874.00	50.61 PK	74.00	-23.39	1.16 H	158	12.33	38.28
3	4874.00	38.03 AV	54.00	-15.97	1.16 H	158	-0.25	38.28

ANTENNA POLARITY & TEST DISTANCE: VERTICAL AT 3M

No.	Freq. (MHz)	Emission Level (dBuV/m)	Limit (dBuV/m)	Margin (dB)	Antenna Height (m)	Table Angle (Degree)	Raw Value (dBuV)	Correction Factor (dB/m)
1	2360.00	48.06 PK	74.00	-25.94	1.00 V	315	16.35	31.71
1	2360.00	34.73 AV	54.00	-19.27	1.00 V	315	3.02	31.71
2	*2437.00	100.70 PK			1.00 V	298	68.75	31.95
2	*2437.00	91.09 AV			1.00 V	298	59.14	31.95
3	4874.00	51.48 PK	74.00	-22.52	1.14 V	236	13.20	38.28
3	4874.00	38.40 AV	54.00	-15.60	1.14 V	236	0.12	38.28

- REMARKS:**
1. Emission level(dBuV/m)=Raw Value(dBuV) + Correction Factor(dB/m)
 2. Correction Factor(dB/m) = Antenna Factor (dB/m) + Cable Factor (dB)
 3. The other emission levels were very low against the limit.
 4. Margin value = Emission level – Limit value.
 5. The limit value is defined as per 15.247
 6. “ * “ : Fundamental frequency



EUT	D-Link AirPremier AG DWL-AG132 Wireless USB Adapter	MODEL	DWL-AG132
CHANNEL	Channel 11	FREQUENCY RANGE	1 ~ 25GHz
MODE	OFDM		
INPUT POWER (SYSTEM)	120Vac, 60 Hz	DETECTOR FUNCTION	Peak(PK) Average (AV)
ENVIRONMENTAL CONDITIONS	25deg. C, 60%RH, 991hPa	TESTED BY	Match Tsui
TEST MODE	1 (Without USB Cradle)		

ANTENNA POLARITY & TEST DISTANCE: HORIZONTAL AT 3M

No.	Freq. (MHz)	Emission Level (dBuV/m)	Limit (dBuV/m)	Margin (dB)	Antenna Height (m)	Table Angle (Degree)	Raw Value (dBuV)	Correction Factor (dB/m)
1	*2462.00	106.34 PK			1.04 H	12	74.32	32.02
1	*2462.00	96.32 AV			1.04 H	12	64.30	32.02
2	2483.50	62.02 PK	74.00	-11.98	1.04 H	12	29.93	32.09
2	2483.50	51.80 AV	54.00	-2.20	1.04 H	12	19.71	32.09
3	2688.00	47.43 PK	74.00	-26.57	1.00 H	360	14.53	32.90
3	2688.00	41.64 AV	54.00	-12.36	1.00 H	360	8.74	32.90
4	4924.00	52.12 PK	74.00	-21.88	1.00 H	127	13.63	38.49
4	4924.00	39.86 AV	54.00	-14.14	1.00 H	127	1.37	38.49

ANTENNA POLARITY & TEST DISTANCE: VERTICAL AT 3M

No.	Freq. (MHz)	Emission Level (dBuV/m)	Limit (dBuV/m)	Margin (dB)	Antenna Height (m)	Table Angle (Degree)	Raw Value (dBuV)	Correction Factor (dB/m)
1	*2462.00	101.20 PK			1.12 V	257	69.18	32.02
1	*2462.00	91.78 AV			1.12 V	257	59.76	32.02
2	2483.50	56.88 PK	74.00	-17.12	1.12 V	257	24.79	32.09
2	2483.50	47.46 AV	54.00	-6.54	1.12 V	257	15.37	32.09
3	2688.00	45.33 PK	74.00	-28.67	1.18 V	342	12.43	32.90
3	2688.00	35.20 AV	54.00	-18.80	1.18 V	342	2.30	32.90
4	4924.00	52.28 PK	74.00	-21.72	1.00 V	194	13.79	38.49
4	4924.00	39.49 AV	54.00	-14.51	1.00 V	194	1.00	38.49

- REMARKS:**
1. Emission level(dBuV/m)=Raw Value(dBuV) + Correction Factor(dB/m)
 2. Correction Factor(dB/m) = Antenna Factor (dB/m) + Cable Factor (dB)
 3. The other emission levels were very low against the limit.
 4. Margin value = Emission level – Limit value.
 5. The limit value is defined as per 15.247
 6. " * " : Fundamental frequency

**802.11g OFDM modulation (with Cradle)**

EUT	D-Link AirPremier AG DWL-AG132 Wireless USB Adapter	MODEL	DWL-AG132
CHANNEL	Channel 1	FREQUENCY RANGE	1 ~ 25GHz
MODE	OFDM		
INPUT POWER (SYSTEM)	120Vac, 60 Hz	DETECTOR FUNCTION	Peak(PK) Average (AV)
ENVIRONMENTAL CONDITIONS	22deg. C, 64%RH, 991hPa	TESTED BY	Match Tsui
TEST MODE	2 (With USB Cradle)		

ANTENNA POLARITY & TEST DISTANCE: HORIZONTAL AT 3 M

No.	Freq. (MHz)	Emission Level (dBuV/m)	Limit (dBuV/m)	Margin (dB)	Antenna Height (m)	Table Angle (Degree)	Raw Value (dBuV)	Correction Factor (dB/m)
1	2390.00	58.54 PK	74.00	-15.46	1.03 H	336	27.83	30.71
1	2390.00	45.09 AV	54.00	-8.91	1.03 H	336	14.38	30.71
2	*2412.00	99.84 PK			1.03 H	336	69.04	30.80
2	*2412.00	89.58 AV			1.03 H	336	58.78	30.80
3	4824.00	45.30 PK	74.00	-28.70	1.10 H	226	8.72	36.58
3	4824.00	33.79 AV	54.00	-20.21	1.10 H	226	-2.79	36.58

ANTENNA POLARITY & TEST DISTANCE: VERTICAL AT 3 M

No.	Freq. (MHz)	Emission Level (dBuV/m)	Limit (dBuV/m)	Margin (dB)	Antenna Height (m)	Table Angle (Degree)	Raw Value (dBuV)	Correction Factor (dB/m)
1	2390.00	55.55 PK	74.00	-18.45	1.29 V	106	24.84	30.71
1	2390.00	43.88 AV	54.00	-10.12	1.29 V	106	13.17	30.71
2	*2412.00	102.15 PK			1.29 V	106	71.35	30.80
2	*2412.00	92.05 AV			1.29 V	106	61.25	30.80
3	4824.00	48.37 PK	74.00	-25.63	1.26 V	223	11.79	36.58
3	4824.00	34.66 AV	54.00	-19.34	1.26 V	223	-1.92	36.58

- REMARKS:**
1. Emission level(dBuV/m)=Raw Value(dBuV) + Correction Factor(dB/m)
 2. Correction Factor(dB/m) = Antenna Factor (dB/m) + Cable Factor (dB)
 3. The other emission levels were very low against the limit.
 4. Margin value = Emission level – Limit value.
 5. The limit value is defined as per 15.247
 6. “ * “ : Fundamental frequency



EUT	D-Link AirPremier AG DWL-AG132 Wireless USB Adapter	MODEL	DWL-AG132
CHANNEL	Channel 6	FREQUENCY RANGE	1 ~ 25GHz
MODE	OFDM		
INPUT POWER (SYSTEM)	120Vac, 60 Hz	DETECTOR FUNCTION	Peak(PK) Average (AV)
ENVIRONMENTAL CONDITIONS	22deg. C, 64%RH, 991hPa	TESTED BY	Match Tsui
TEST MODE	2 (With USB Cradle)		

ANTENNA POLARITY & TEST DISTANCE: HORIZONTAL AT 3M

No.	Freq. (MHz)	Emission Level (dBuV/m)	Limit (dBuV/m)	Margin (dB)	Antenna Height (m)	Table Angle (Degree)	Raw Value (dBuV)	Correction Factor (dB/m)
1	*2437.00	100.01 PK			1.24 H	260	69.11	30.90
1	*2437.00	90.12 AV			1.24 H	260	59.22	30.90
2	4874.00	45.68 PK	74.00	-28.32	1.11 H	350	8.92	36.76
2	4874.00	33.48 AV	54.00	-20.52	1.11 H	350	-3.28	36.76

ANTENNA POLARITY & TEST DISTANCE: VERTICAL AT 3M

No.	Freq. (MHz)	Emission Level (dBuV/m)	Limit (dBuV/m)	Margin (dB)	Antenna Height (m)	Table Angle (Degree)	Raw Value (dBuV)	Correction Factor (dB/m)
1	*2437.00	102.87 PK			1.24 V	150	71.97	30.90
1	*2437.00	93.40 AV			1.24 V	150	62.50	30.90
2	4874.00	48.69 PK	74.00	-25.31	1.17 V	300	11.93	36.76
2	4874.00	35.01 AV	54.00	-18.99	1.17 V	300	-1.75	36.76

- REMARKS:**
1. Emission level(dBuV/m)=Raw Value(dBuV) + Correction Factor(dB/m)
 2. Correction Factor(dB/m) = Antenna Factor (dB/m) + Cable Factor (dB)
 3. The other emission levels were very low against the limit.
 4. Margin value = Emission level – Limit value.
 5. The limit value is defined as per 15.247
 6. “ * “ : Fundamental frequency



EUT	D-Link AirPremier AG DWL-AG132 Wireless USB Adapter	MODEL	DWL-AG132
CHANNEL	Channel 11	FREQUENCY RANGE	1 ~ 25GHz
MODE	OFDM		
INPUT POWER (SYSTEM)	120Vac, 60 Hz	DETECTOR FUNCTION	Peak(PK) Average (AV)
ENVIRONMENTAL CONDITIONS	22deg. C, 64%RH, 991hPa	TESTED BY	Match Tsui
TEST MODE	2 (With USB Cradle)		

ANTENNA POLARITY & TEST DISTANCE: HORIZONTAL AT 3M

No.	Freq. (MHz)	Emission Level (dBuV/m)	Limit (dBuV/m)	Margin (dB)	Antenna Height (m)	Table Angle (Degree)	Raw Value (dBuV)	Correction Factor (dB/m)
1	*2462.00	100.01 PK			1.00 H	339	69.02	30.99
1	*2462.00	90.01 AV			1.00 H	339	59.02	30.99
2	2483.50	61.40 PK	74.00	-12.60	1.00 H	339	30.33	31.07
2	2483.50	46.98 AV	54.00	-7.02	1.00 H	339	15.91	31.07
3	4924.00	44.87 PK	74.00	-29.13	1.17 H	223	7.89	36.97
3	4924.00	34.83 AV	54.00	-19.17	1.17 H	223	-2.15	36.97

ANTENNA POLARITY & TEST DISTANCE: VERTICAL AT 3M

No.	Freq. (MHz)	Emission Level (dBuV/m)	Limit (dBuV/m)	Margin (dB)	Antenna Height (m)	Table Angle (Degree)	Raw Value (dBuV)	Correction Factor (dB/m)
1	*2462.00	102.26 PK			1.05 V	255	71.27	30.99
1	*2462.00	91.96 AV			1.05 V	255	60.97	30.99
2	2483.50	66.55 PK	74.00	-7.45	1.05 V	255	35.48	31.07
2	2483.50	48.38 AV	54.00	-5.62	1.05 V	255	17.31	31.07
3	4924.00	43.65 PK	74.00	-30.35	1.00 V	19	6.68	36.97
3	4924.00	32.52 AV	54.00	-21.48	1.00 V	19	-4.45	36.97

- REMARKS:**
1. Emission level(dBuV/m)=Raw Value(dBuV) + Correction Factor(dB/m)
 2. Correction Factor(dB/m) = Antenna Factor (dB/m) + Cable Factor (dB)
 3. The other emission levels were very low against the limit.
 4. Margin value = Emission level – Limit value.
 5. The limit value is defined as per 15.247
 6. “ * “ : Fundamental frequency



802.11g Turbo OFDM modulation (without Cradle)

EUT	D-Link AirPremier AG DWL-AG132 Wireless USB Adapter	MODEL	DWL-AG132
CHANNEL	Channel 6	FREQUENCY RANGE	1 ~ 25GHz
MODE	OFDM		
INPUT POWER (SYSTEM)	120Vac, 60 Hz	DETECTOR FUNCTION	Peak(PK) Average (AV)
ENVIRONMENTAL CONDITIONS	25deg. C, 65%RH, 991hPa	TESTED BY	Rush Kao
TEST MODE	1 (Without USB Cradle)		

ANTENNA POLARITY & TEST DISTANCE: HORIZONTAL AT 3 M

No.	Freq. (MHz)	Emission Level (dBuV/m)	Limit (dBuV/m)	Margin (dB)	Antenna Height (m)	Table Angle (Degree)	Raw Value (dBuV)	Correction Factor (dB/m)
1	2390.00	49.44 PK	74.00	-24.56	1.00 H	304	17.83	31.61
1	2390.00	39.67 AV	54.00	-14.33	1.00 H	304	8.06	31.61
2	*2437.00	97.31 PK			1.00 H	304	65.46	31.85
2	*2437.00	87.54 AV			1.00 H	304	55.69	31.85
3	2483.50	47.87 PK	74.00	-26.13	1.00 H	304	15.74	32.13
3	2483.50	38.10 AV	54.00	-15.90	1.00 H	304	5.97	32.13
4	2688.00	46.07 PK	74.00	-27.93	1.28 H	196	13.37	32.70
4	2688.00	42.69 AV	54.00	-11.31	1.28 H	196	9.99	32.70
5	4874.00	48.68 PK	74.00	-25.32	1.14 H	10	11.02	37.66
5	4874.00	34.91 AV	54.00	-19.09	1.14 H	10	-2.75	37.66

ANTENNA POLARITY & TEST DISTANCE: VERTICAL AT 3 M

No.	Freq. (MHz)	Emission Level (dBuV/m)	Limit (dBuV/m)	Margin (dB)	Antenna Height (m)	Table Angle (Degree)	Raw Value (dBuV)	Correction Factor (dB/m)
1	2390.00	46.85 PK	74.00	-27.15	1.18 V	197	15.24	31.61
1	2390.00	37.87 AV	54.00	-16.13	1.18 V	197	6.26	31.61
2	*2437.00	94.72 PK			1.18 V	197	62.87	31.85
2	*2437.00	85.74 AV			1.18 V	197	53.89	31.85
3	2483.50	45.28 PK	74.00	-28.72	1.18 V	197	13.15	32.13
3	2483.50	36.30 AV	54.00	-17.70	1.18 V	197	4.17	32.13
4	2688.00	40.17 PK	74.00	-33.83	1.19 V	47	7.47	32.70
4	2688.00	32.44 AV	54.00	-21.56	1.19 V	47	-0.26	32.70
5	4874.00	46.18 PK	74.00	-27.82	1.19 V	11	8.52	37.66
5	4874.00	33.91 AV	54.00	-20.09	1.19 V	11	-3.75	37.66

- REMARKS:**
1. Emission level(dBuV/m)=Raw Value(dBuV) + Correction Factor(dB/m)
 2. Correction Factor(dB/m) = Antenna Factor (dB/m) + Cable Factor (dB)
 3. The other emission levels were very low against the limit.
 4. Margin value = Emission level – Limit value.
 5. " * " : Fundamental frequency

802.11g Turbo OFDM modulation (with Cradle)

EUT	D-Link AirPremier AG DWL-AG132 Wireless USB Adapter	MODEL	DWL-AG132
CHANNEL	Channel 6	FREQUENCY RANGE	1 ~ 25GHz
MODE	OFDM		
INPUT POWER (SYSTEM)	120Vac, 60 Hz	DETECTOR FUNCTION	Peak(PK) Average (AV)
ENVIRONMENTAL CONDITIONS	22deg. C, 64%RH, 991hPa	TESTED BY	Rush Kao
TEST MODE	2 (With USB Cradle)		

ANTENNA POLARITY & TEST DISTANCE: HORIZONTAL AT 3 M

No.	Freq. (MHz)	Emission Level (dBuV/m)	Limit (dBuV/m)	Margin (dB)	Antenna Height (m)	Table Angle (Degree)	Raw Value (dBuV)	Correction Factor (dB/m)
1	2390.00	55.24 PK	74.00	-18.76	1.01 H	331	24.53	30.71
1	2390.00	44.13 AV	54.00	-9.87	1.01 H	331	13.42	30.71
2	*2437.00	97.59 PK			1.01 H	331	66.69	30.90
2	*2437.00	88.39 AV			1.01 H	331	57.49	30.90
3	2483.50	55.52 PK	74.00	-18.48	1.01 H	331	24.45	31.07
3	2483.50	45.10 AV	54.00	-8.90	1.01 H	331	14.03	31.07
4	4874.00	48.05 PK	74.00	-25.95	1.07 H	15	11.29	36.76
4	4874.00	35.54 AV	54.00	-18.46	1.07 H	15	-1.22	36.76

ANTENNA POLARITY & TEST DISTANCE: VERTICAL AT 3 M

No.	Freq. (MHz)	Emission Level (dBuV/m)	Limit (dBuV/m)	Margin (dB)	Antenna Height (m)	Table Angle (Degree)	Raw Value (dBuV)	Correction Factor (dB/m)
1	2390.00	55.75 PK	74.00	-18.25	1.06 V	32	25.04	30.71
1	2390.00	46.03 AV	54.00	-7.97	1.06 V	32	15.32	30.71
2	*2437.00	101.00 PK			1.06 V	32	70.10	30.90
2	*2437.00	91.68 AV			1.06 V	32	60.78	30.90
3	2483.50	56.37 PK	74.00	-17.63	1.06 V	32	25.30	31.07
3	2483.50	46.49 AV	54.00	-7.51	1.06 V	32	15.42	31.07
4	4874.00	46.90 PK	74.00	-27.10	1.21 V	243	10.14	36.76
4	4874.00	35.18 AV	54.00	-18.82	1.21 V	243	-1.58	36.76

- REMARKS:**
1. Emission level(dBuV/m)=Raw Value(dBuV) + Correction Factor(dB/m)
 2. Correction Factor(dB/m) = Antenna Factor (dB/m) + Cable Factor (dB)
 3. The other emission levels were very low against the limit.
 4. Margin value = Emission level – Limit value.
 5. “ * “ : Fundamental frequency



4.3 6dB BANDWIDTH MEASUREMENT

4.3.1 LIMITS OF 6dB BANDWIDTH MEASUREMENT

The minimum of 6dB Bandwidth Measurement is 0.5 MHz.

4.3.2 TEST INSTRUMENTS

Description & Manufacturer	Model No.	Serial No.	Calibrated Until
SPECTRUM ANALYZER	FSEK 30	100049	Aug. 12, 2005

NOTE: The calibration interval of the above test instruments is 12 months and the calibrations are traceable to NML/ROC and NIST/USA.

4.3.3 TEST PROCEDURE

The transmitter output was connected to the spectrum analyzer through an attenuator. The bandwidth of the fundamental frequency was measured by spectrum analyzer with 100kHz RBW and 100kHz VBW. The 6dB bandwidth is defined as the total spectrum the power of which is higher than peak power minus 6dB.

4.3.4 DEVIATION FROM TEST STANDARD

No deviation

4.3.5 TEST SETUP

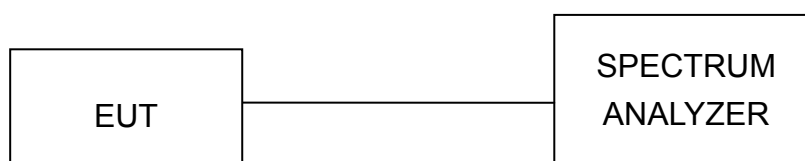

4.3.6 EUT OPERATING CONDITIONS

The software provided by client to enable the EUT under transmission condition continuously at lowest, middle and highest channel frequencies individually.



4.3.7 TEST RESULTS

802.11b Mode

EUT	D-Link AirPremier AG DWL-AG132 Wireless USB Adapter	MODEL	DWL-AG132
MODE	CKC	INPUT POWER (SYSTEM)	120Vac, 60 Hz
ENVIRONMENTAL CONDITIONS	24deg.C, 64%RH, 991hPa	TESTED BY	Leo Hung

CHANNEL	CHANNEL FREQUENCY (MHz)	6dB BANDWIDTH (MHz)	MINIMUM LIMIT (MHz)	PASS/FAIL
1	2412	12.24	0.5	PASS
6	2437	12.40	0.5	PASS
11	2462	11.80	0.5	PASS



CH 1

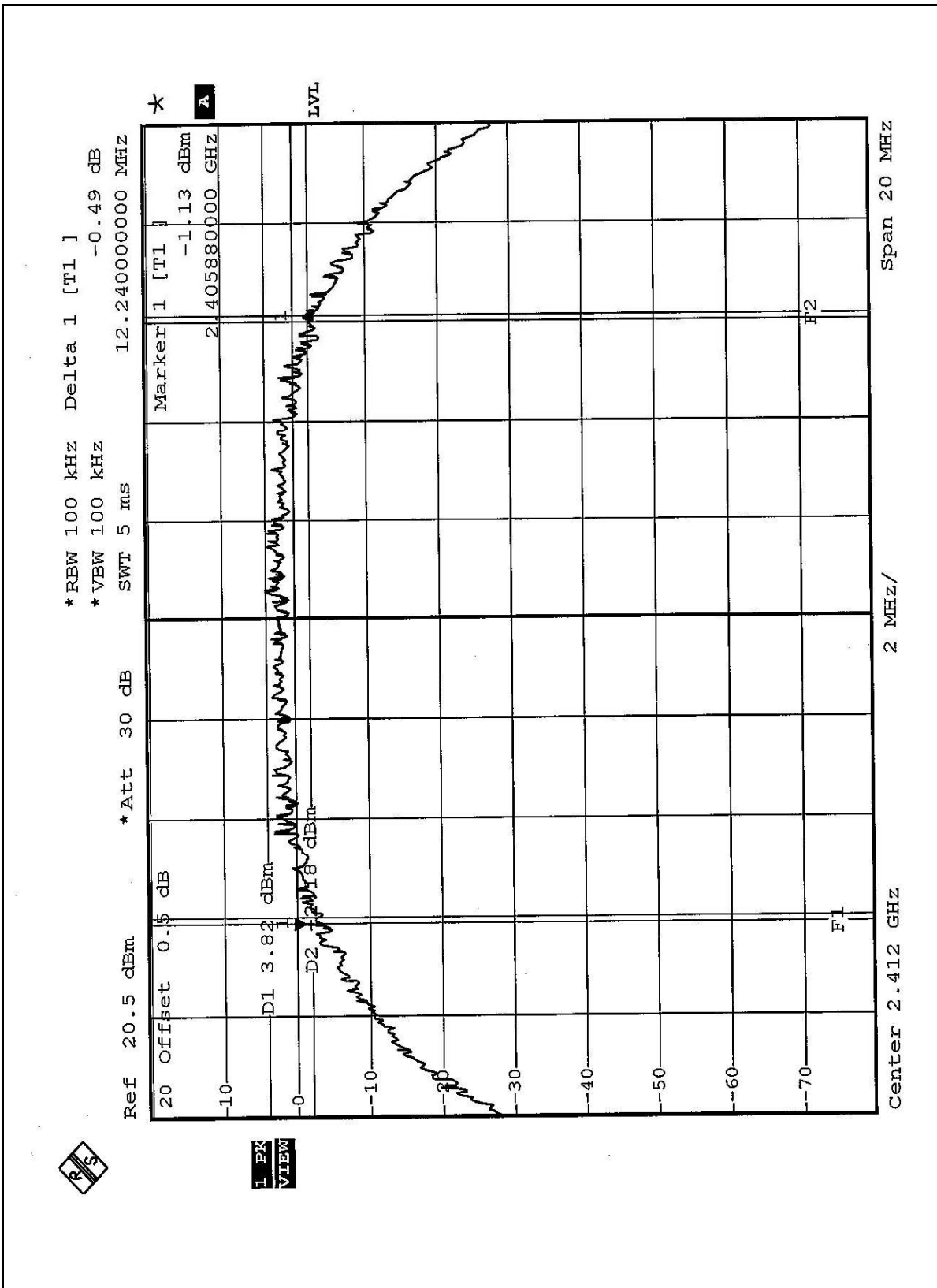



CH 6

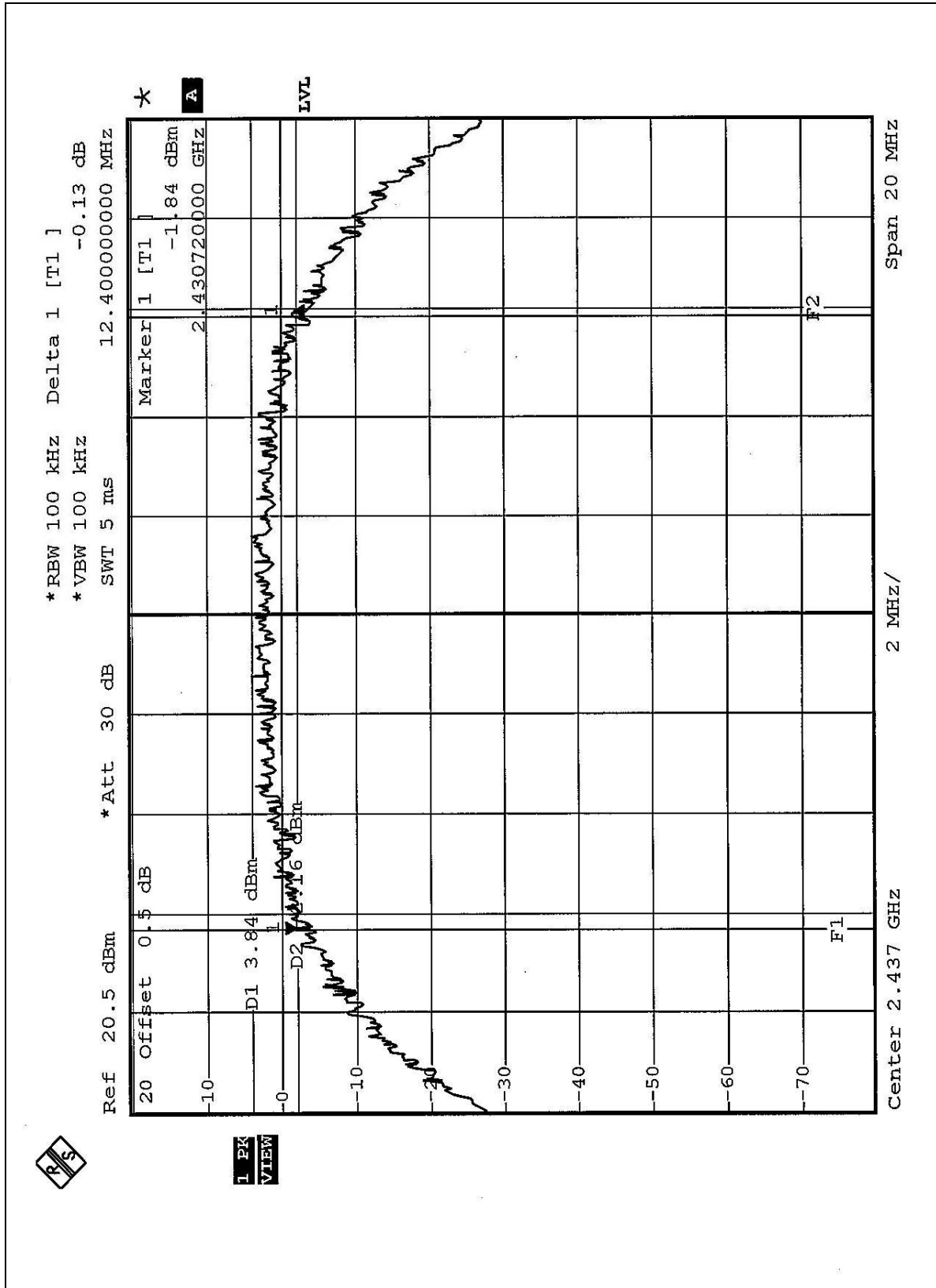



CH 11

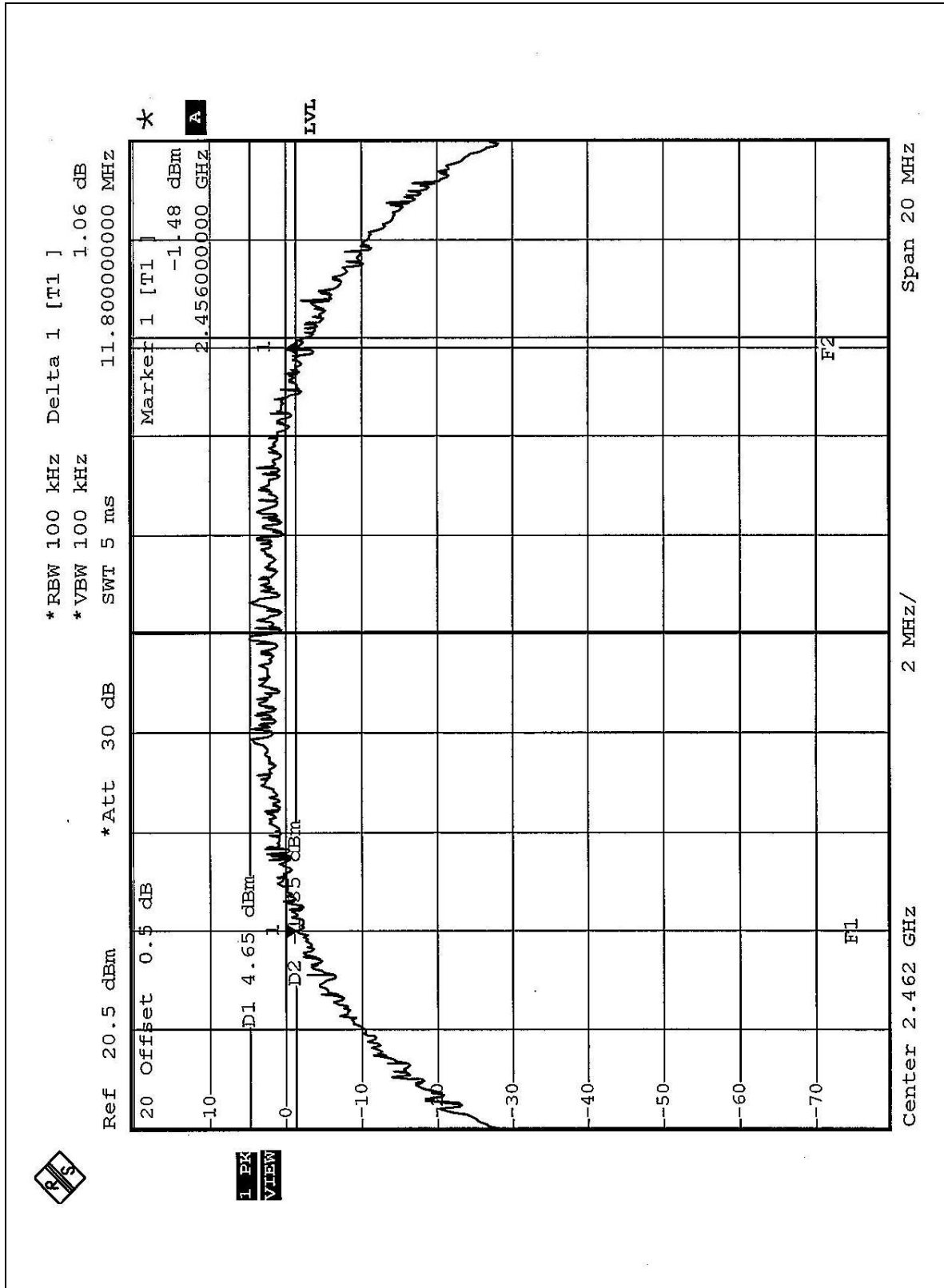

**802.11g Mode**

EUT	D-Link AirPremier AG DWL-AG132 Wireless USB Adapter	MODEL	DWL-AG132
MODE	OFDM	INPUT POWER (SYSTEM)	120Vac, 60 Hz
ENVIRONMENTAL CONDITIONS	24deg.C, 64%RH, 991hPa	TESTED BY	Leo Hung

CHANNEL	CHANNEL FREQUENCY (MHz)	6dB BANDWIDTH (MHz)	MINIMUM LIMIT (MHz)	PASS/FAIL
1	2412	16.44	0.5	PASS
6	2437	16.40	0.5	PASS
11	2462	16.44	0.5	PASS



CH 1

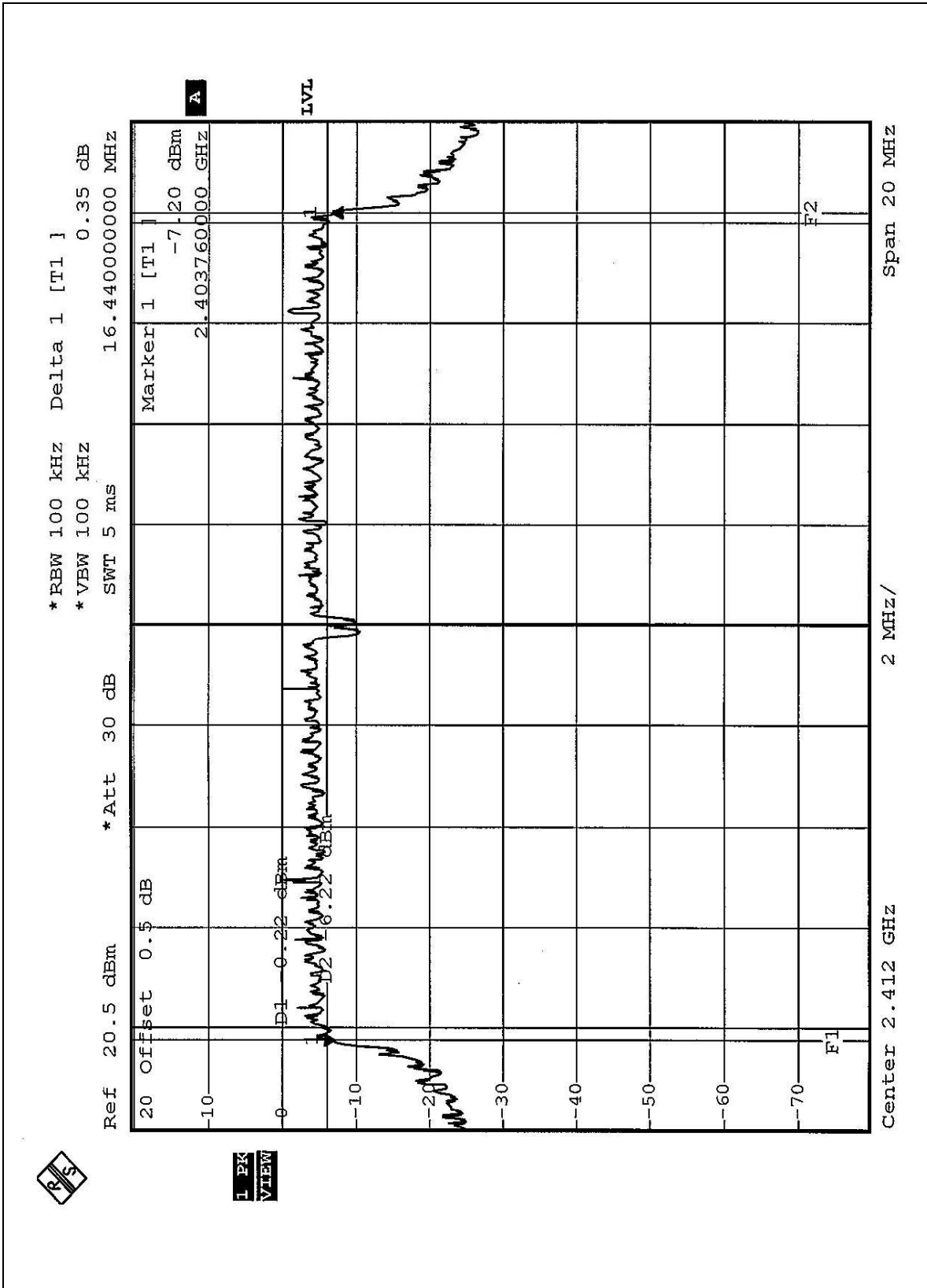

1 PK VIEW



CH 6

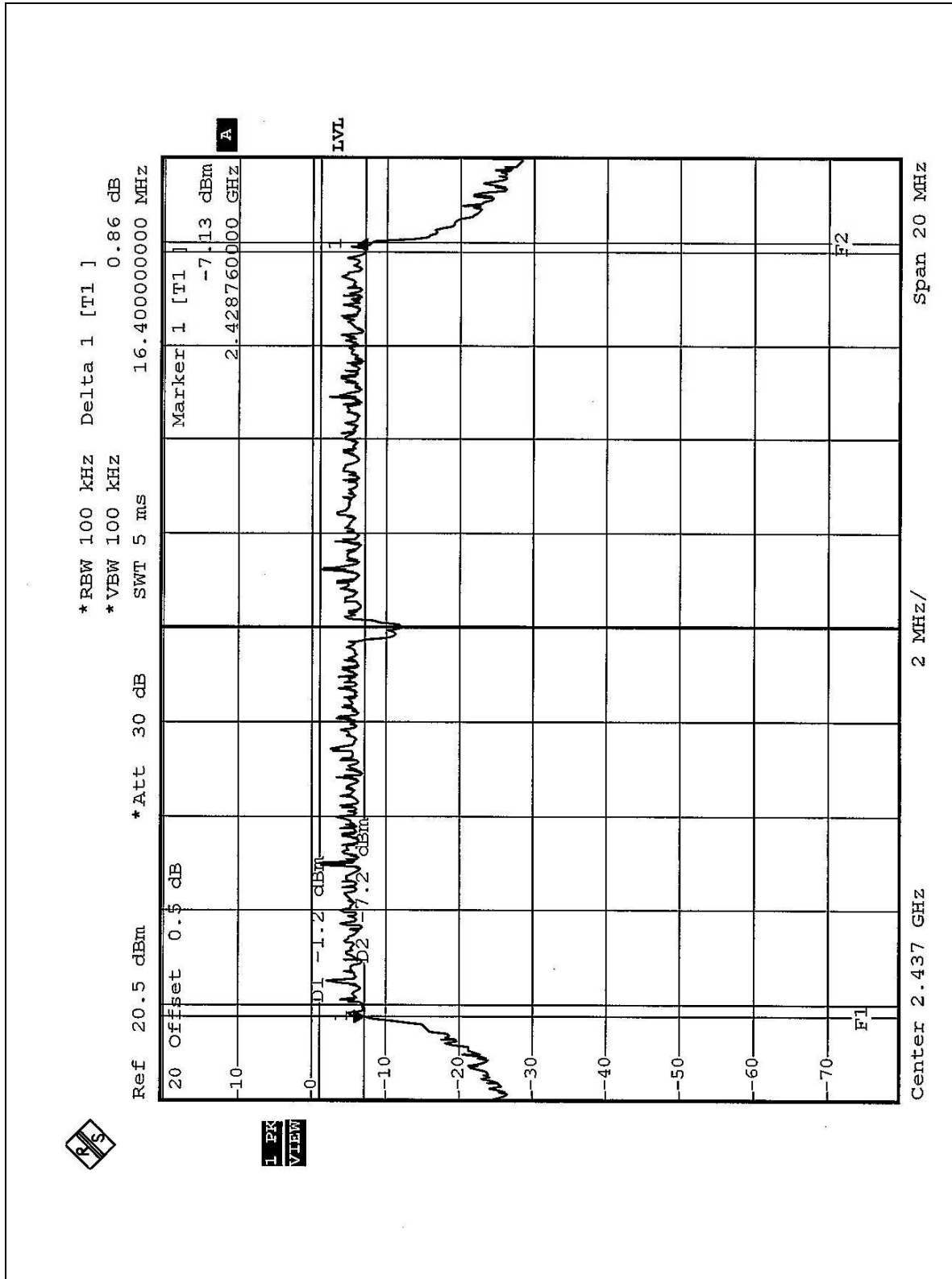



CH 11

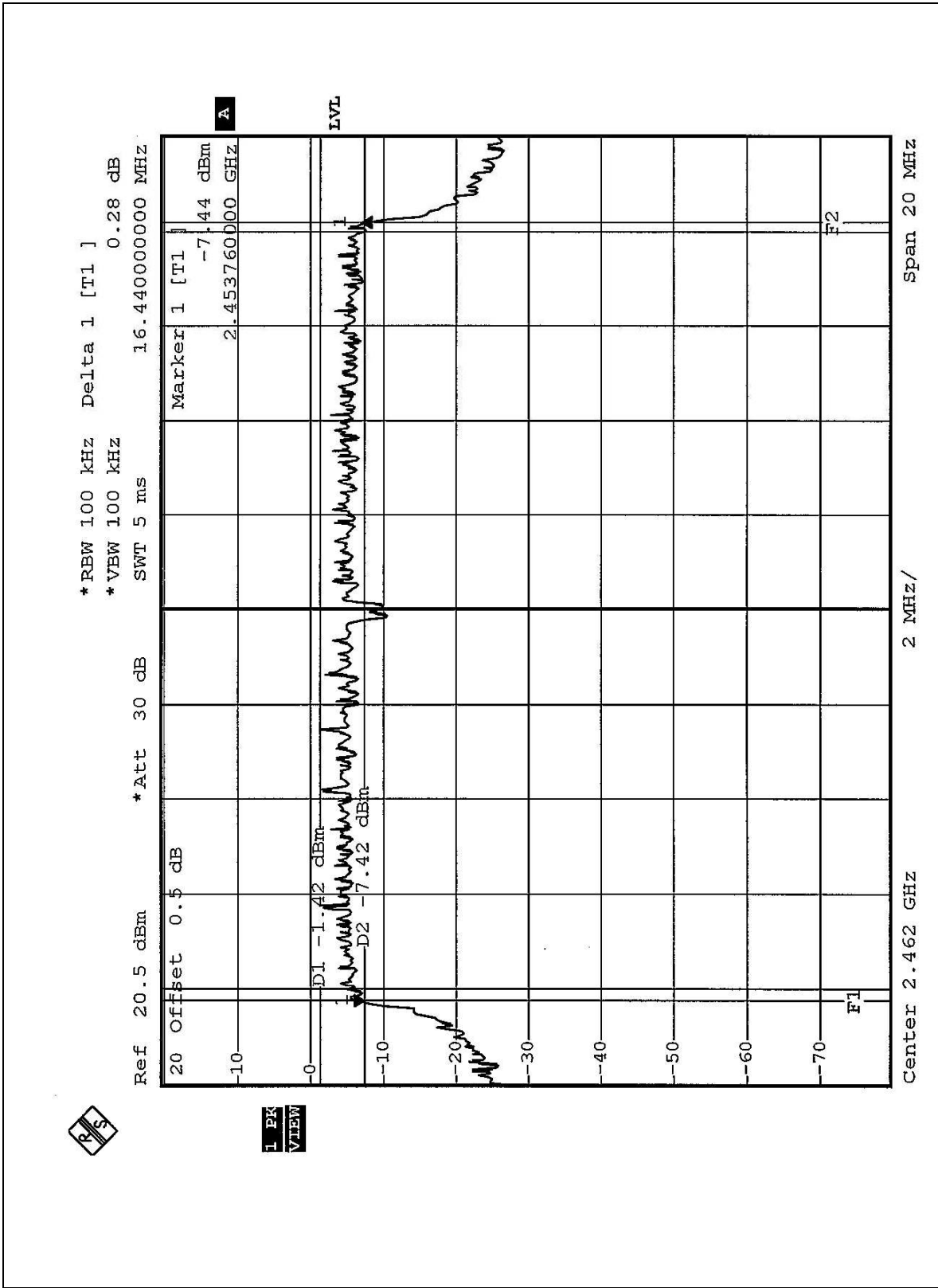



802.11g Turbo mode

EUT	D-Link AirPremier AG DWL-AG132 Wireless USB Adapter	MODEL	DWL-AG132
MODE	OFDM	INPUT POWER (SYSTEM)	120Vac, 60 Hz
ENVIRONMENTAL CONDITIONS	24deg.C, 64%RH, 991hPa	TESTED BY	Leo Hung

CHANNEL	CHANNEL FREQUENCY (MHz)	6 dB BANDWIDTH (MHz)	MINIMUM LIMIT (MHz)	PASS/FAIL
6	2437	32.78	0.5	PASS



CH 6

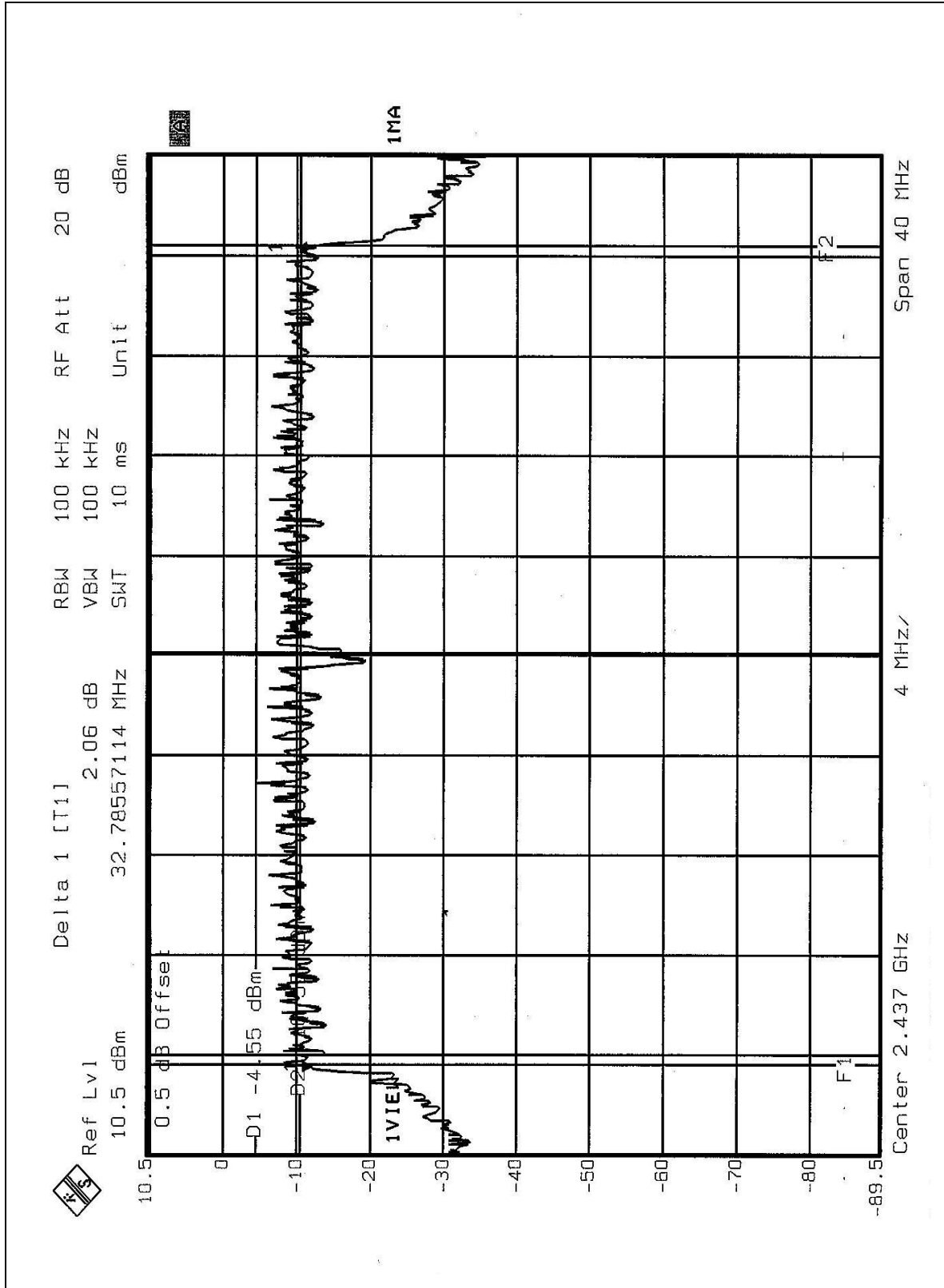



4.4 MAXIMUM PEAK OUTPUT POWER

4.4.1 LIMITS OF MAXIMUM PEAK OUTPUT POWER MEASUREMENT

The Maximum Peak Output Power Measurement is 30dBm.

4.4.2 INSTRUMENTS

Description & Manufacturer	Model No.	Serial No.	Calibrated Until
R&S SPECTRUM ANALYZER	FSEK30	100049	Aug. 12, 2005
AGILENT SIGNAL GENERATOR	E8257C	MY43320668	Dec. 31, 2005
TEKTRONIX OSCILLOSCOPE	TDS 1012	C019167	Feb. 01, 2005
NARDA DETECTOR	4503A	FSCM99899	NA

NOTE:

The calibration interval of the above test instruments is 12 months and the calibrations are traceable to NML/ROC and NIST/USA.

4.4.1 TEST PROCEDURES

1. A detector was used on the output port of the EUT. An oscilloscope was used to read the response of the detector.
2. Replaced the EUT by the signal generator. The center frequency of the S.G was adjusted to the center frequency of the measured channel.
3. Adjusted the power to have the same reading on oscilloscope. Record the power level.

4.4.2 DEVIATION FROM TEST STANDARD

No deviation

4.4.3 TEST SETUP



4.4.4 EUT OPERATING CONDITIONS

Same as Item 4.3.6

4.4.3 TEST RESULTS

EUT	D-Link AirPremier AG DWL-AG132 Wireless USB Adapter	MODEL	DWL-AG132
INPUT POWER (SYSTEM)	120Vac, 60Hz	ENVIRONMENTAL CONDITIONS	23deg.C, 67%RH, 991hPa
MODE	DSSS	TESTED BY	Leo Hung

802.11b Mode

CHANNEL	CHANNEL FREQUENCY (MHz)	PEAK POWER OUTPUT (mW)	PEAK POWER OUTPUT (dBm)	PEAK POWER LIMIT (dBm)	PASS/FAIL
1	2412	51.286	17.10	30	PASS
6	2437	52.481	17.20	30	PASS
11	2462	50.119	17.00	30	PASS

802.11g Mode

EUT	D-Link AirPremier AG DWL-AG132 Wireless USB Adapter	MODEL	DWL-AG132
INPUT POWER (SYSTEM)	120Vac, 60Hz	ENVIRONMENTAL CONDITIONS	23deg.C, 67%RH, 991hPa
MODE	OFDM	TESTED BY	Leo Hung

CHANNEL	CHANNEL FREQUENCY (MHz)	PEAK POWER OUTPUT (mW)	PEAK POWER OUTPUT (dBm)	PEAK POWER LIMIT (dBm)	PASS/FAIL
1	2412	44.875	16.52	30	PASS
6	2437	44.771	16.51	30	PASS
11	2462	39.811	16.00	30	PASS

802.11g Turbo Mode

EUT	D-Link AirPremier AG DWL-AG132 Wireless USB Adapter	MODEL	DWL-AG132
INPUT POWER (SYSTEM)	120Vac, 60Hz	ENVIRONMENTAL CONDITIONS	24deg.C, 64%RH, 991hPa
MODE	OFDM	TESTED BY	Leo Hung

CHANNEL	CHANNEL FREQUENCY	PEAK POWER	PEAK POWER	PEAK POWER	PASS/FAIL
---------	-------------------	------------	------------	------------	-----------



	(MHz)	OUTPUT (mW)	OUTPUT (dBm)	LIMIT (dBm)	
6	2437	43.652	16.40	30	PASS



4.5 POWER SPECTRAL DENSITY MEASUREMENT

4.5.1 LIMITS OF POWER SPECTRAL DENSITY MEASUREMENT

The Maximum of Power Spectral Density Measurement is 8dBm.

4.5.2 TEST INSTRUMENTS

Description & Manufacturer	Model No.	Serial No.	Calibrated Until
R&S SPECTRUM ANALYZER	FSEK30	100049	Aug. 12, 2005

NOTE:

The calibration interval of the above test instruments is 12 months and the calibrations are traceable to NML/ROC and NIST/USA.

4.5.3 TEST PROCEDURE

The transmitter output was connected to the spectrum analyzer through an attenuator, the bandwidth of the fundamental frequency was measured with the spectrum analyzer using 3kHz RBW and 30kHz VBW, set sweep time = span/3kHz. The power spectral density was measured and recorded. The sweep time is allowed to be longer than span/3kHz for a full response of the mixer in the spectrum analyzer.

4.5.4 DEVIATION FROM TEST STANDARD

No deviation

4.5.5 TEST SETUP

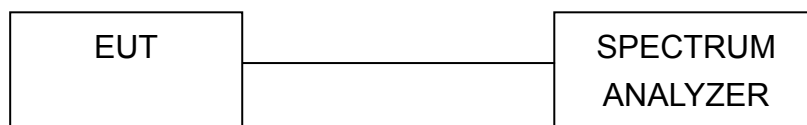

4.5.6 EUT OPERATING CONDITION

Same as Item 4.3.6



4.5.7 TEST RESULTS

802.11b Mode

EUT	D-Link AirPremier AG DWL-AG132 Wireless USB Adapter	MODEL	DWL-AG132
INPUT POWER (SYSTEM)	120Vac, 60Hz	ENVIRONMENTAL CONDITIONS	24deg.C, 64%RH, 991hPa
MODE	DSSS	TESTED BY	Leo Hung

CHANNEL	CHANNEL FREQUENCY (MHz)	RF POWER LEVEL IN 3kHz BW (dBm)	MAXIMUM LIMIT (dBm)	PASS/FAIL
1	2412	-8.38	8	PASS
6	2437	-8.13	8	PASS
11	2462	-8.64	8	PASS



CH 1

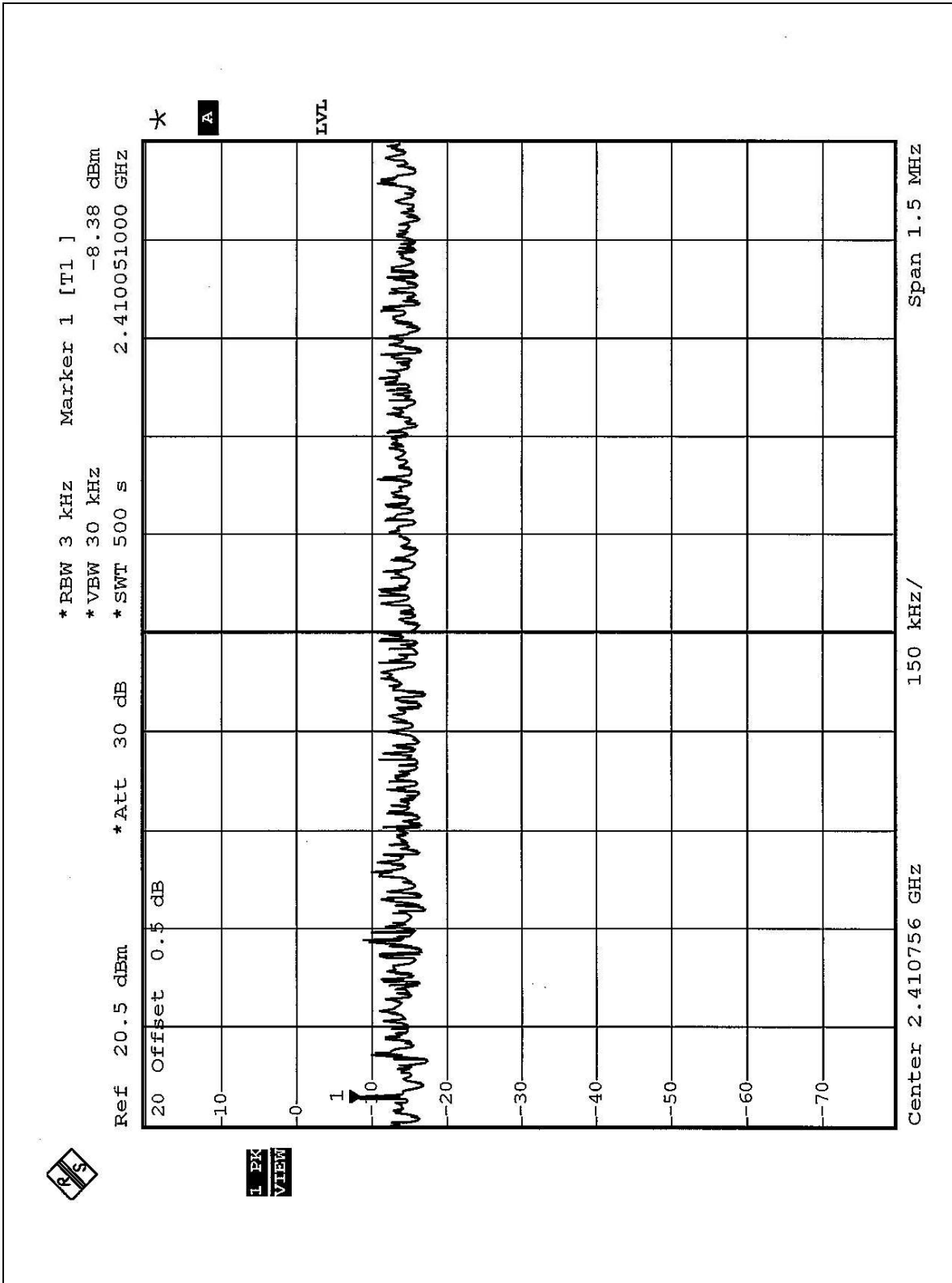



CH 6

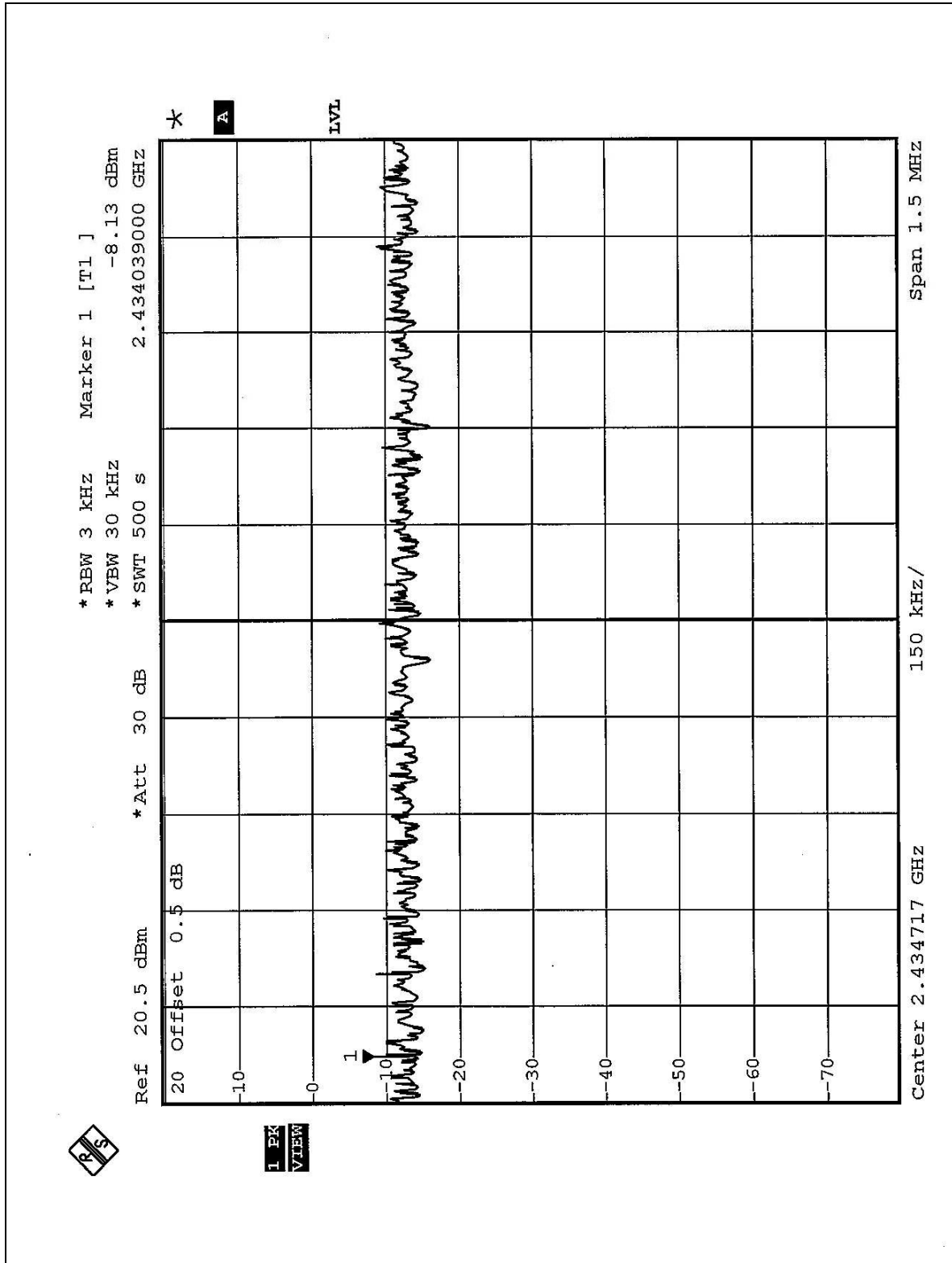



CH 11

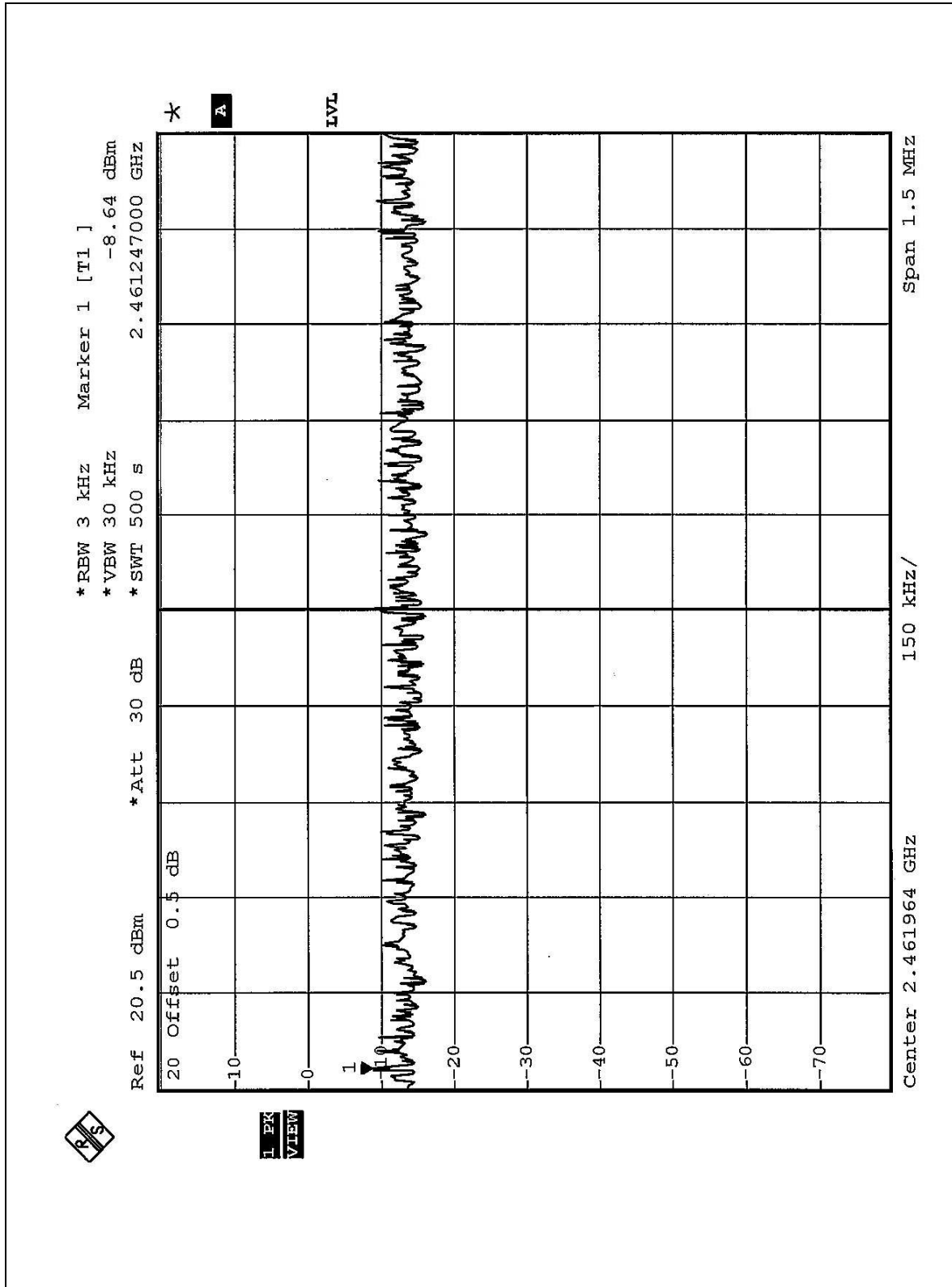

**802.11g Mode**

EUT	D-Link AirPremier AG DWL-AG132 Wireless USB Adapter	MODEL	DWL-AG132
INPUT POWER (SYSTEM)	120Vac, 60Hz	ENVIRONMENTAL CONDITIONS	24deg.C, 64%RH, 991hPa
MODE	OFDM	TESTED BY	Leo Hung

CHANNEL	CHANNEL FREQUENCY (MHz)	RF POWER LEVEL IN 3kHz BW (dBm)	MAXIMUM LIMIT (dBm)	PASS/FAIL
1	2412	-13.76	8	PASS
6	2437	-13.63	8	PASS
11	2462	-14.03	8	PASS



CH 1

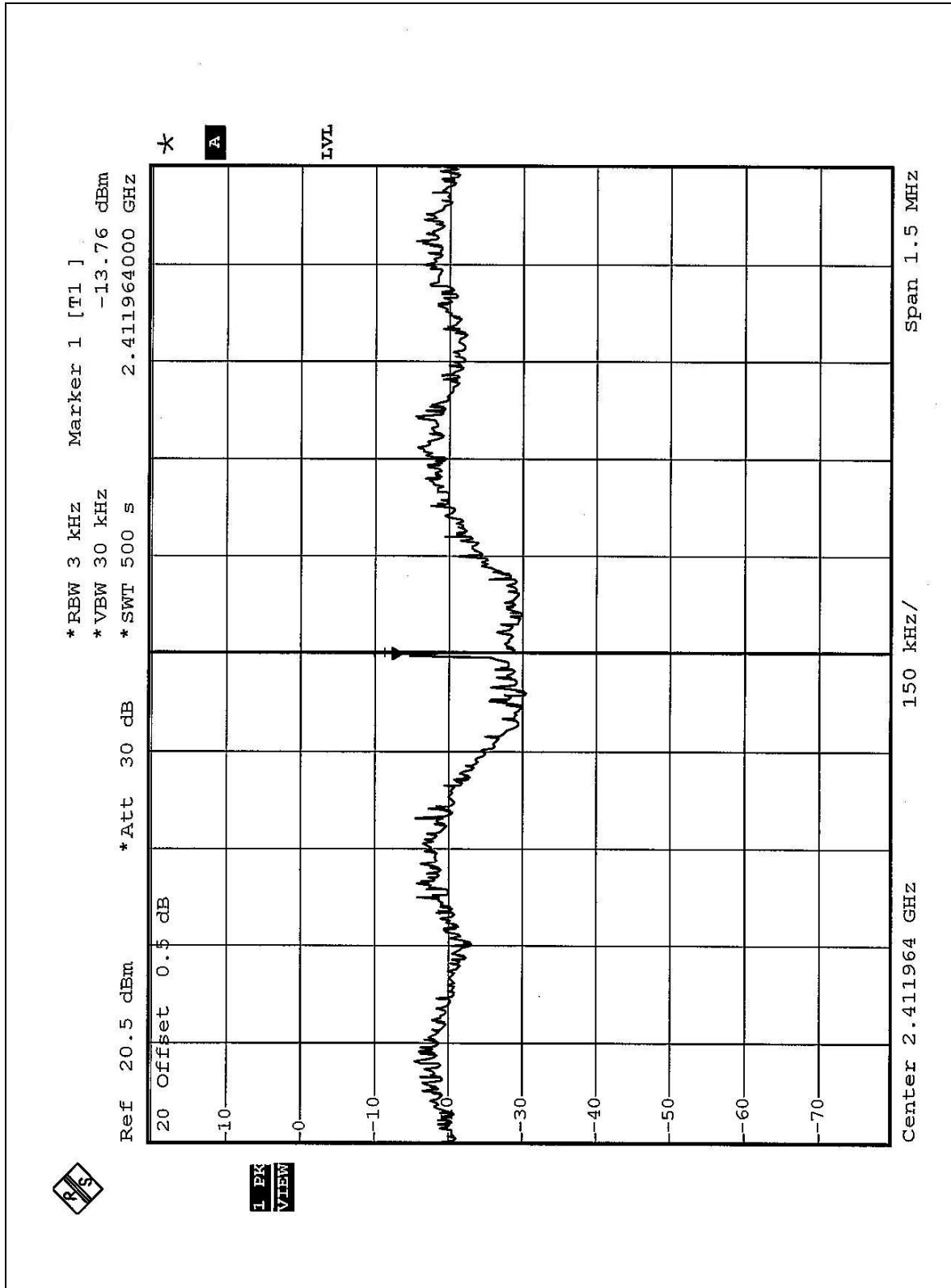



CH 6

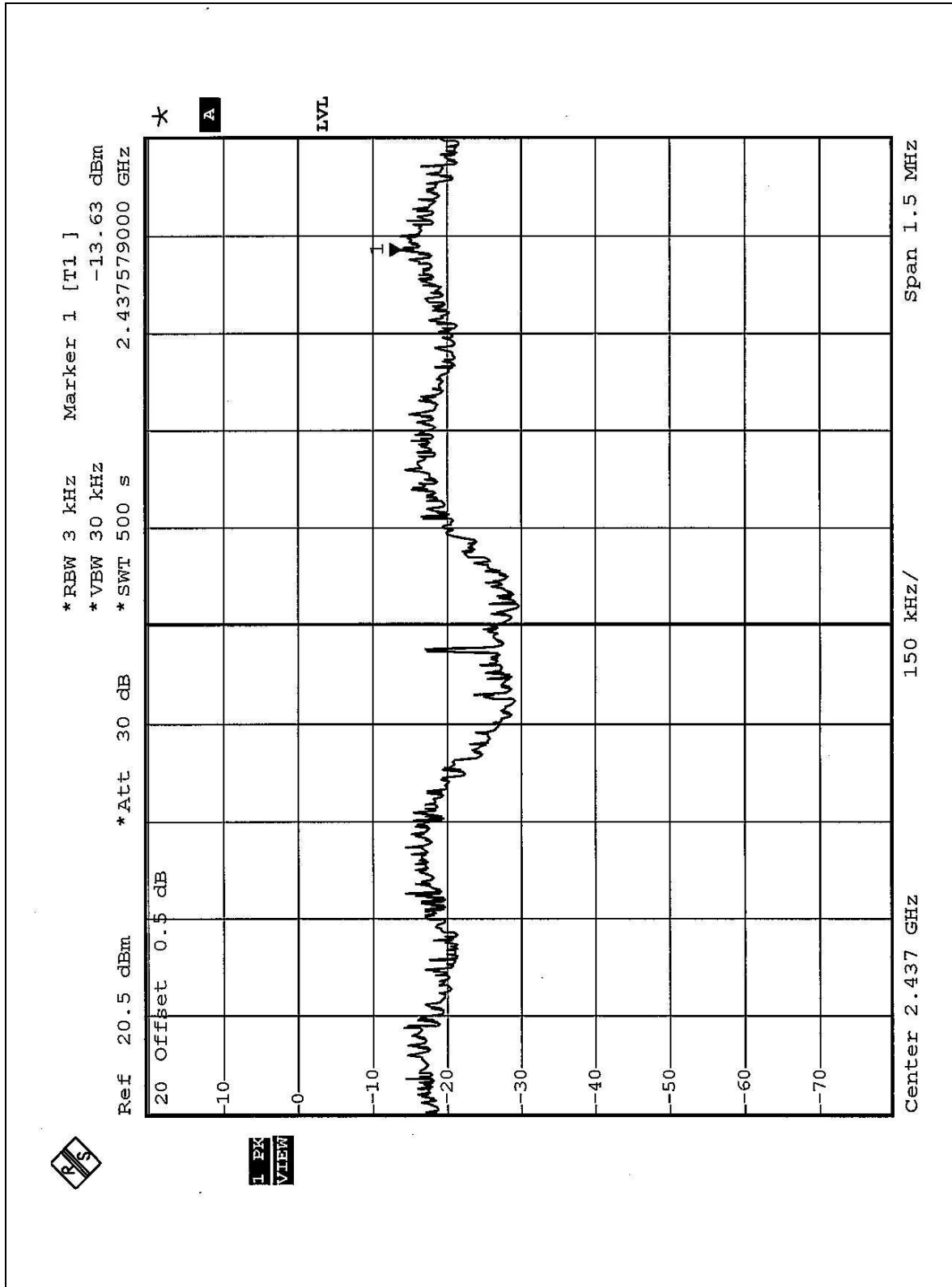



CH 11

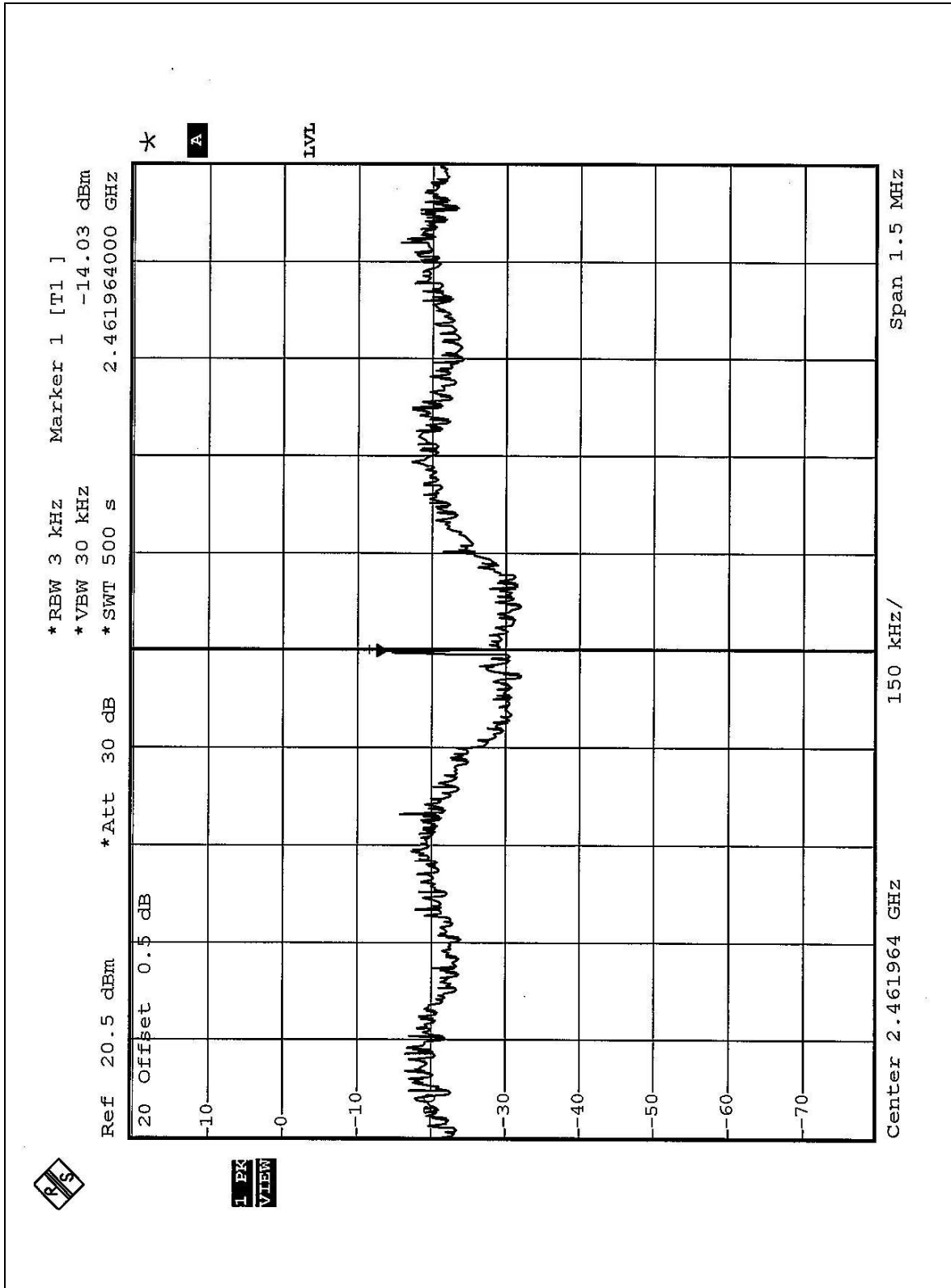

**802.11g Turbo Mode**

EUT	D-Link AirPremier AG DWL-AG132 Wireless USB Adapter	MODEL	DWL-AG132
INPUT POWER (SYSTEM)	120Vac, 60Hz	ENVIRONMENTAL CONDITIONS	24deg.C, 64%RH, 991hPa
MODE	OFDM	TESTED BY	Leo Hung

CHANNEL	CHANNEL FREQUENCY (MHz)	RF POWER LEVEL IN 3kHz BW (dBm)	MAXIMUM LIMIT (dBm)	PASS/FAIL
6	2437	-18.33	8	PASS



CH 6

