



FCC TEST REPORT

REPORT NO.: RF950302L18

MODEL NO.: DWA-645

RECEIVED: Apr. 14, 2006

TESTED: Apr. 15 ~ 20, 2006

ISSUED: Apr. 27, 2006

APPLICANT: D-Link Corporation

ADDRESS: 17595 Mt. Herrmann, Fountain Valley, CA 92708,
U.S.A.

ISSUED BY: Advance Data Technology Corporation

LAB ADDRESS: 47 14th Lin, Chiapau Tsun, Linko, Taipei, Taiwan,
R.O.C.

TEST LOCATION: No. 19, Hwa Ya 2nd Rd., Kueishan, Taoyuan,
Taiwan, R.O.C.

This test report consists of 130 pages in total. It may be duplicated completely for legal use with the approval of the applicant. It should not be reproduced except in full, without the written approval of our laboratory. The client should not use it to claim product endorsement by CNLA, A2LA or any government agencies. The test results in the report only apply to the tested sample.



TABLE OF CONTENTS

1.	CERTIFICATION	4
2.	SUMMARY OF TEST RESULTS	5
2.1	MEASUREMENT UNCERTAINTY.....	5
3.	GENERAL INFORMATION.....	6
3.1	GENERAL DESCRIPTION OF EUT	6
3.2	DESCRIPTION OF TEST MODES	7
3.2.1	CONFIGURATION OF SYSTEM UNDER TEST	7
3.2.2	TEST MODE APPLICABILITY AND TESTED CHANNEL DETAIL	8
3.3	GENERAL DESCRIPTION OF APPLIED STANDARDS	11
3.4	DESCRIPTION OF SUPPORT UNITS.....	11
4.	TEST TYPES AND RESULTS	12
4.1	CONDUCTED EMISSION MEASUREMENT	12
4.1.1	LIMITS OF CONDUCTED EMISSION MEASUREMENT.....	12
4.1.2	TEST INSTRUMENTS.....	12
4.1.3	TEST PROCEDURES	13
4.1.4	DEVIATION FROM TEST STANDARD	13
4.1.5	TEST SETUP	14
4.1.6	EUT OPERATING CONDITIONS	14
4.1.7	TEST RESULTS	15
4.2	RADIATED EMISSION MEASUREMENT	33
4.2.1	LIMITS OF RADIATED EMISSION MEASUREMENT.....	33
4.2.2	TEST INSTRUMENTS.....	34
4.2.3	TEST PROCEDURES	35
4.2.4	DEVIATION FROM TEST STANDARD	35
4.2.5	TEST SETUP	36
4.2.6	EUT OPERATING CONDITIONS	36
4.2.7	TEST RESULTS	37
4.3	6dB BANDWIDTH MEASUREMENT	60
4.3.1	LIMITS OF 6dB BANDWIDTH MEASUREMENT.....	60
4.3.2	TEST INSTRUMENTS.....	60
4.3.3	TEST PROCEDURE.....	60
4.3.4	DEVIATION FROM TEST STANDARD	60
4.3.5	TEST SETUP	61
4.3.6	EUT OPERATING CONDITIONS	61
4.3.7	TEST RESULTS	62
4.4	MAXIMUM PEAK OUTPUT POWER.....	78
4.4.1	LIMITS OF MAXIMUM PEAK OUTPUT POWER MEASUREMENT	78
4.4.2	INSTRUMENTS.....	78
4.4.3	TEST PROCEDURES	78
4.4.4	DEVIATION FROM TEST STANDARD	78
4.4.5	TEST SETUP	79
4.4.6	EUT OPERATING CONDITIONS	79



4.4.7	TEST RESULTS	80
4.5	POWER SPECTRAL DENSITY MEASUREMENT	83
4.5.1	LIMITS OF POWER SPECTRAL DENSITY MEASUREMENT	83
4.5.2	TEST INSTRUMENTS	83
4.5.3	TEST PROCEDURE	83
4.5.4	DEVIATION FROM TEST STANDARD	83
4.5.5	TEST SETUP	84
4.5.6	EUT OPERATING CONDITION	84
4.5.7	TEST RESULTS	85
4.6	BAND EDGES MEASUREMENT	101
4.6.1	LIMITS OF BAND EDGES MEASUREMENT	101
4.6.2	TEST INSTRUMENTS	101
4.6.3	TEST PROCEDURE	101
4.6.4	DEVIATION FROM TEST STANDARD	101
4.6.5	EUT OPERATING CONDITION	101
4.6.6	TEST RESULTS	102
4.7	ANTENNA REQUIREMENT	126
4.7.1	STANDARD APPLICABLE	126
4.7.2	ANTENNA CONNECTED CONSTRUCTION	126
5.	PHOTOGRAPHS OF THE TEST CONFIGURATION	127
6.	INFORMATION ON THE TESTING LABORATORIES	129
	APPENDIX-A	A-1



1. CERTIFICATION

PRODUCT: D-Link DWA-645 RangeBooster N™ 650 Notebook Adapter
MODEL: DWA-645
BRAND: D-Link
APPLICANT: D-Link Corporation
TESTED: Apr. 15 ~ 20, 2006
TEST SAMPLE: ENGINEERING SAMPLE
STANDARDS: FCC Part 15, Subpart C (Section 15.247), ANSI C63.4-2003

The above equipment has been tested by **Advance Data Technology Corporation**, and found compliance with the requirement of the above standards. The test record, data evaluation & Equipment Under Test (EUT) configurations represented herein are true and accurate accounts of the measurements of the sample's EMC characteristics under the conditions specified in this report.

PREPARED BY : Rennie Wang , **DATE:** Apr. 27, 2006
Rennie Wang

TECHNICAL ACCEPTANCE : Long Chen , **DATE:** Apr. 27, 2006
Responsible for RF Long Chen

APPROVED BY : Gary Chang , **DATE:** Apr. 27, 2006
Gary Chang / Supervisor

2. SUMMARY OF TEST RESULTS

The EUT has been tested according to the following specifications:

APPLIED STANDARD: FCC Part 15, Subpart C			
STANDARD SECTION	TEST TYPE AND LIMIT	RESULT	REMARK
15.207	AC Power Conducted Emission	PASS	Meet the requirement of limit. Minimum passing margin is -16.97dB at 0.220MHz.
15.247(a)(2)	Spectrum Bandwidth of a Direct Sequence Spread Spectrum System Limit : min. 500kHz	PASS	Meet the requirement of limit.
15.247(b)	Maximum Peak Output Power Limit: max. 30dBm	PASS	Meet the requirement of limit.
15.247(d)	Transmitter Radiated Emissions Limit: Table 15.209	PASS	Meet the requirement of limit. Minimum passing margin is -1.39dB at 2390.00MHz.
15.247(e)	Power Spectral Density Limit: max. 8dBm	PASS	Meet the requirement of limit.
15.247(d)	Band Edge Measurement Limit: 20dB less than the peak value of fundamental frequency	PASS	Meet the requirement of limit.

2.1 MEASUREMENT UNCERTAINTY

Where relevant, the following measurement uncertainty levels have been estimated for tests performed on the EUT as specified in CISPR 16-4:

MEASUREMENT	FREQUENCY	UNCERTAINTY
Conducted emissions	9kHz ~ 30MHz	2.44dB
Radiated emissions	30MHz ~ 200MHz	3.73dB
	200MHz ~ 1000MHz	3.74dB
	1GHz ~ 18GHz	2.20dB
	18GHz ~ 40GHz	1.88dB

This uncertainty represents an expanded uncertainty expressed at approximately the 95% confidence level using a coverage factor of $k = 2$.



3. GENERAL INFORMATION

3.1 GENERAL DESCRIPTION OF EUT

PRODUCT	D-Link DWA-645 RangeBooster N™ 650 Notebook Adapter
MODEL NO.	DWA-645
FCC ID	KA2DWA645B1
POWER SUPPLY	3.3Vdc from host equipment
MODULATION TYPE	CCK, DQPSK, DBPSK for DSSS 64QAM, 16QAM, QPSK, BPSK for OFDM
MODULATION TECHNOLOGY	DSSS, OFDM
TRANSFER RATE	802.11b: 11/ 5.5/ 2/ 1Mbps 802.11g: 54/ 48/ 36/ 24/ 18/ 12/ 9/ 6Mbps Draft 802.11n (20MHz): 144.444/ 130.000/ 115.556/ 86.667/ 57.778/ 43.333/ 28.889/ 14.444/ 72.2/ 65.0/ 57.8/ 43.3/ 28.9/ 21.7/ 14.4/ 7.2Mbps Draft 802.11n (40MHz): 300/ 270/ 240/ 180/ 120/ 90/ 60/ 30/ 150/ 135/ 120/ 90/ 60/ 45/ 30/ 15Mbps
FREQUENCY RANGE	2412MHz ~ 2462MHz
NUMBER OF CHANNEL	11 for 802.11b, 802.11g, draft 802.11n (20MHz) 7 for draft 802.11n (40MHz)
MAXIMUM OUTPUT POWER	160.712mW
ANTENNA TYPE	Printed antenna with 3.29dBi gain
DATA CABLE	NA
I/O PORTS	NA

NOTE:

1. The EUT incorporates a MIMO function with 802.11b, 802.11g, draft 802.11n. Physically, the card provides two completed transmitters and three receivers.
2. The EUT is 2 * 3 spatial MIMO (2Tx & 3Rx) without beam forming function.
3. When the EUT operating in 802.11b, 802.11g, the software operation, which is defined by manufacturer, only set single Tx.
4. When the EUT operating in draft 802.11n, the software operation, which is defined by manufacturer, only set 0 ~ 7 of "MCS" (MCS: Modulation and Coding Schemes) for single Tx, 8 ~ 15 for dual Tx.
5. The EUT complies with draft 802.11n standards and backwards compatible with 802.11b, 802.11g products.
6. The EUT operates in the 2.4GHz frequency spectrum with throughput of up to 300Mbps.
7. The above EUT information was declared by manufacturer and for more detailed features description, please refer to the manufacturer's specifications or user's manual.

3.2 DESCRIPTION OF TEST MODES

Eleven channels are provided for 802.11b, 802.11g, draft 802.11n (20MHz):

CHANNEL	FREQUENCY	CHANNEL	FREQUENCY
1	2412MHz	7	2442MHz
2	2417MHz	8	2447MHz
3	2422MHz	9	2452MHz
4	2427MHz	10	2457MHz
5	2432MHz	11	2462MHz
6	2437MHz		

Seven channels are provided for draft 802.11n (40MHz):

CHANNEL	FREQUENCY	CHANNEL	FREQUENCY
1	2422MHz	5	2442MHz
2	2427MHz	6	2447MHz
3	2432MHz	7	2452MHz
4	2437MHz		

3.2.1 CONFIGURATION OF SYSTEM UNDER TEST

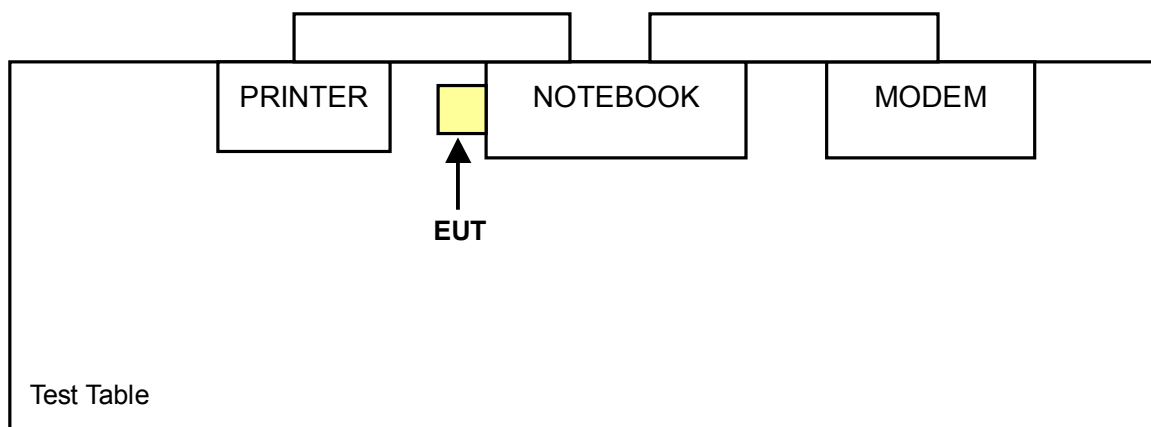

3.2.2 TEST MODE APPLICABILITY AND TESTED CHANNEL DETAIL

EUT CONFIGURE MODE	APPLICABLE TO				DESCRIPTION
	PLC	RE < 1G	RE ≥ 1G	APCM	
-	√	√	√	√	-

Where **PLC**: Power Line Conducted Emission **RE < 1G**: Radiated Emission below 1GHz
RE ≥ 1G: Radiated Emission above 1GHz **APCM**: Antenna Port Conducted Measurement

POWER LINE CONDUCTED EMISSION TEST:

- Pre-Scan has been conducted to determine the worst-case mode from all possible combinations between available modulations, data rates and antenna ports (if EUT with antenna diversity architecture).
- Following channel(s) was (were) selected for the final test as listed below.

MODE	AVAILABLE CHANNEL	TESTED CHANNEL	MODULATION TECHNOLOGY	MODULATION TYPE	DATA RATE (Mbps)	TX CONDITION
802.11g	1 to 11	1, 6, 11	OFDM	BPSK	6	Single
Draft 802.11n (20MHz)	1 to 11	1, 6, 11	OFDM	BPSK	14.444	Dual
Draft 802.11n (40MHz)	1 to 7	1, 4, 7	OFDM	BPSK	30	Dual

RADIATED EMISSION TEST (BELOW 1 GHz):

- Pre-Scan has been conducted to determine the worst-case mode from all possible combinations between available modulations, data rates and antenna ports (if EUT with antenna diversity architecture).
- Following channel(s) was (were) selected for the final test as listed below.

MODE	AVAILABLE CHANNEL	TESTED CHANNEL	MODULATION TECHNOLOGY	MODULATION TYPE	DATA RATE (Mbps)	TX CONDITION
802.11g	1 to 11	1	OFDM	BPSK	6	Single
Draft 802.11n (20MHz)	1 to 11	1	OFDM	BPSK	7.2	Single
Draft 802.11n (20MHz)	1 to 11	1	OFDM	BPSK	14.444	Dual
Draft 802.11n (40MHz)	1 to 7	1	OFDM	BPSK	15	Single
Draft 802.11n (40MHz)	1 to 7	1	OFDM	BPSK	30	Dual

RADIATED EMISSION TEST (ABOVE 1 GHz):

- Pre-Scan has been conducted to determine the worst-case mode from all possible combinations between available modulations, data rates and antenna ports (if EUT with antenna diversity architecture).
- Following channel(s) was (were) selected for the final test as listed below.

MODE	AVAILABLE CHANNEL	TESTED CHANNEL	MODULATION TECHNOLOGY	MODULATION TYPE	DATA RATE (Mbps)	TX CONDITION
802.11b	1 to 11	1, 6, 11	DSSS	DBPSK	1	Single
802.11g	1 to 11	1, 6, 11	OFDM	BPSK	6	Single
Draft 802.11n (20MHz)	1 to 11	1, 6, 11	OFDM	BPSK	7.2	Single
Draft 802.11n (20MHz)	1 to 11	1, 6, 11	OFDM	BPSK	14.444	Dual
Draft 802.11n (40MHz)	1 to 7	1, 4, 7	OFDM	BPSK	15	Single
Draft 802.11n (40MHz)	1 to 7	1, 4, 7	OFDM	BPSK	30	Dual

BANDEDGE MEASUREMENT:

- Pre-Scan has been conducted to determine the worst-case mode from all possible combinations between available modulations, data rates and antenna ports (if EUT with antenna diversity architecture).
- Following channel(s) was (were) selected for the final test as listed below.

MODE	AVAILABLE CHANNEL	TESTED CHANNEL	MODULATION TECHNOLOGY	MODULATION TYPE	DATA RATE (Mbps)	TX CONDITION
802.11b	1 to 11	1, 11	DSSS	DBPSK	1	Single
802.11g	1 to 11	1, 11	OFDM	BPSK	6	Single
Draft 802.11n (20MHz)	1 to 11	1, 11	OFDM	BPSK	7.2	Single
Draft 802.11n (20MHz)	1 to 11	1, 11	OFDM	BPSK	14.444	Dual
Draft 802.11n (40MHz)	1 to 7	1, 7	OFDM	BPSK	15	Single
Draft 802.11n (40MHz)	1 to 7	1, 7	OFDM	BPSK	30	Dual

ANTENNA PORT CONDUCTED MEASUREMENT:

- Pre-Scan has been conducted to determine the worst-case mode from all possible combinations between available modulations, data rates and antenna ports (if EUT with antenna diversity architecture).
- Following channel(s) was (were) selected for the final test as listed below.

MODE	AVAILABLE CHANNEL	TESTED CHANNEL	MODULATION TECHNOLOGY	MODULATION TYPE	DATA RATE (Mbps)	TX CONDITION
802.11b	1 to 11	1, 6, 11	DSSS	DBPSK	1	Single
802.11g	1 to 11	1, 6, 11	OFDM	BPSK	6	Single
Draft 802.11n (20MHz)	1 to 11	1, 6, 11	OFDM	BPSK	7.2	Single
Draft 802.11n (20MHz)	1 to 11	1, 6, 11	OFDM	BPSK	14.444	Dual
Draft 802.11n (40MHz)	1 to 7	1, 4, 7	OFDM	BPSK	15	Single
Draft 802.11n (40MHz)	1 to 7	1, 4, 7	OFDM	BPSK	30	Dual



3.3 GENERAL DESCRIPTION OF APPLIED STANDARDS

The EUT is a RF product. According to the specifications of the manufacturer, it must comply with the requirements of the following standards:

FCC Part 15, Subpart C. (15.247)

ANSI C63.4-2003

All test items have been performed and recorded as per the above standards.

NOTE: The EUT is also considered as a kind of computer peripheral, because the connection to computer is necessary for typical use. It has been verified to comply with the requirements of FCC Part 15, Subpart B, Class B (DoC). The test report has been issued separately.

3.4 DESCRIPTION OF SUPPORT UNITS

The EUT has been tested as an independent unit together with other necessary accessories or support units. The following support units or accessories were used to form a representative test configuration during the tests.

NO.	PRODUCT	BRAND	MODEL NO.	SERIAL NO.	FCC ID
1	NOTEBOOK COMPUTER	DELL	PP05L	16484462992	E2K24CLNS
2	PRINTER	EPSON	LQ-300+	DCGY054147	FCC DoC Approved
3	MODEM	ACEEX	1414V/3	0401008269	IFAXDM1414

NO.	SIGNAL CABLE DESCRIPTION OF THE ABOVE SUPPORT UNITS
1	NA
2	NA
3	NA

NOTE: All power cords of the above support units are non shielded (1.8m).

4. TEST TYPES AND RESULTS

4.1 CONDUCTED EMISSION MEASUREMENT

4.1.1 LIMITS OF CONDUCTED EMISSION MEASUREMENT

FREQUENCY OF EMISSION (MHz)	CONDUCTED LIMIT (dB μ V)	
	Quasi-peak	Average
0.15-0.5	66 to 56	56 to 46
0.5-5	56	46
5-30	60	50

- NOTE:**
1. The lower limit shall apply at the transition frequencies.
 2. The limit decreases in line with the logarithm of the frequency in the range of 0.15 to 0.50 MHz.
 3. All emanations from a class A/B digital device or system, including any network of conductors and apparatus connected thereto, shall not exceed the level of field strengths specified above.

4.1.2 TEST INSTRUMENTS

DESCRIPTION & MANUFACTURER	MODEL NO.	SERIAL NO.	CALIBRATED UNTIL
Test Receiver ROHDE & SCHWARZ	ESCS30	100288	Nov. 02, 2006
RF signal cable Woken	5D-FB	Cable-HYCO3-01	Jan. 06, 2007
LISN ROHDE & SCHWARZ	ESH2-Z5	100100	Jan. 09, 2007
LISN ROHDE & SCHWARZ	ESH3-Z5	100311	Jan. 22, 2007
Software ADT	ADT_Cond_V3	NA	NA

- NOTE:**
1. The calibration interval of the above test instruments is 12 months and the calibrations are traceable to NML/ROC and NIST/USA.
 2. The test was performed in HwaYa Shielded Room 3.
 3. The VCCI Site Registration No. is C-2047.

4.1.3 TEST PROCEDURES

- a. The EUT was placed 0.4 meters from the conducting wall of the shielded room with EUT being connected to the power mains through a line impedance stabilization network (LISN). Other support units were connected to the power mains through another LISN. The two LISNs provide 50 ohm/ 50uH of coupling impedance for the measuring instrument.
- b. Both lines of the power mains connected to the EUT were checked for maximum conducted interference.
- c. The frequency range from 150kHz to 30MHz was searched. Emission levels under (Limit - 20dB) was not recorded.

4.1.4 DEVIATION FROM TEST STANDARD

No deviation

4.1.5 TEST SETUP

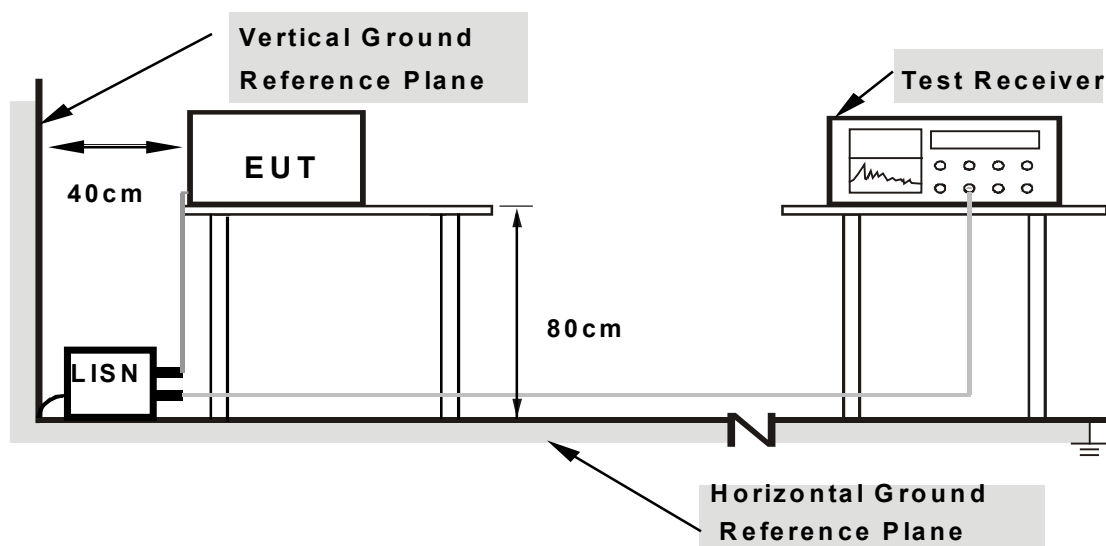

Note: 1. Support units were connected to second LISN.

2. Both of LISNs (AMN) are 80 cm from EUT and at least 80 from other units and other metal planes

For the actual test configuration, please refer to the related item – Photographs of the Test Configuration.

4.1.6 EUT OPERATING CONDITIONS

- a. Connected the EUT into the notebook system and placed on a testing table.
- b. The computer system ran a test program (provided by manufacturer) to enable EUT under transmission/receiving condition continuously at specific channel frequency.
- c. The notebook system displayed “H” messages on its screen.
- d. The notebook system show “H” messages to modem.
- e. The notebook system sent "H" messages to printer and the printer prints them on paper.
- f. Repeated item c ~e.

4.1.7 TEST RESULTS

CONDUCTED WORST-CASE DATA: 802.11g OFDM MODULATION:

EUT TEST CONDITION		MEASUREMENT DETAIL	
CHANNEL	Channel 1	PHASE	Line 1
MODULATION TYPE	BPSK	6dB BANDWIDTH	9 kHz
TRANSFER RATE	6Mbps	INPUT POWER (SYSTEM)	120Vac, 60 Hz
ENVIRONMENTAL CONDITIONS	20deg. C, 60%RH, 991hPa	TESTED BY	Match Tsui

No	Freq. [MHz]	Corr. Factor [dB]	Reading Value [dB (uV)]		Emission Level [dB (uV)]		Limit [dB (uV)]		Margin (dB)	
			Q.P.	AV.	Q.P.	AV.	Q.P.	AV.	Q.P.	AV.
1	0.177	0.10	37.94	-	38.04	-	64.61	54.61	-26.57	-
2	0.218	0.10	45.16	-	45.26	-	62.90	52.90	-17.64	-
3	0.955	0.10	30.14	-	30.24	-	56.00	46.00	-25.76	-
4	2.074	0.21	28.48	-	28.69	-	56.00	46.00	-27.31	-
5	10.816	0.40	33.80	-	34.20	-	60.00	50.00	-25.80	-
6	12.773	0.51	27.96	-	28.47	-	60.00	50.00	-31.53	-

- REMARKS:**
1. Q.P. and AV. are abbreviations of quasi-peak and average individually.
 2. "-": The Quasi-peak reading value also meets average limit and measurement with the average detector is unnecessary.
 3. The emission levels of other frequencies were very low against the limit.
 4. Margin value = Emission level - Limit value
 5. Correction factor = Insertion loss + Cable loss
 6. Emission Level = Correction Factor + Reading Value.

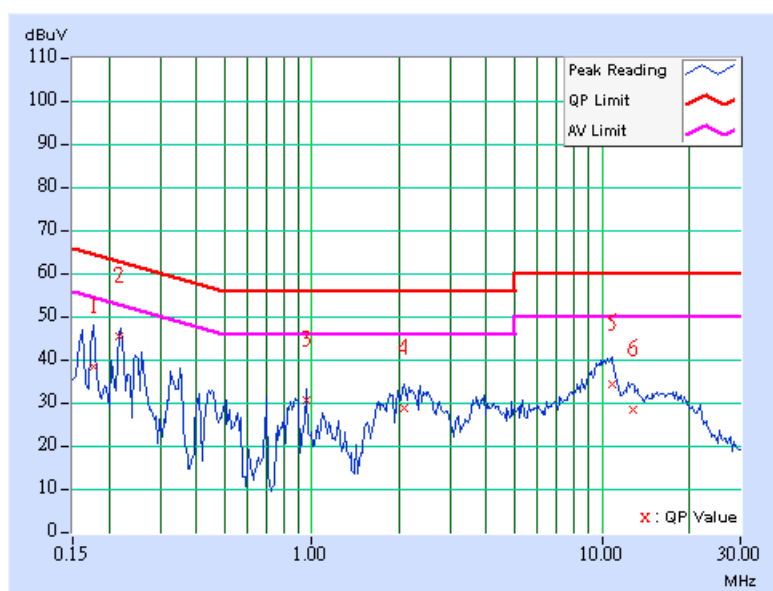

EUT TEST CONDITION		MEASUREMENT DETAIL	
CHANNEL	Channel 1	PHASE	Line 2
MODULATION TYPE	BPSK	6dB BANDWIDTH	9 kHz
TRANSFER RATE	6Mbps	INPUT POWER (SYSTEM)	120Vac, 60 Hz
ENVIRONMENTAL CONDITIONS	20deg. C, 60%RH, 991hPa	TESTED BY	Match Tsui

No	Freq. [MHz]	Corr. Factor [dB]	Reading Value [dB (uV)]		Emission Level [dB (uV)]		Limit [dB (uV)]		Margin (dB)	
			Q.P.	AV.	Q.P.	AV.	Q.P.	AV.	Q.P.	AV.
1	0.209	0.10	41.51	-	41.61	-	63.26	53.26	-21.65	-
2	0.228	0.10	42.93	-	43.03	-	62.52	52.52	-19.49	-
3	0.869	0.18	30.79	-	30.97	-	56.00	46.00	-25.03	-
4	2.344	0.23	26.98	-	27.21	-	56.00	46.00	-28.79	-
5	10.375	0.47	34.96	-	35.43	-	60.00	50.00	-24.57	-
6	12.918	0.56	28.58	-	29.14	-	60.00	50.00	-30.86	-

- REMARKS:**
1. Q.P. and AV. are abbreviations of quasi-peak and average individually.
 2. "-": The Quasi-peak reading value also meets average limit and measurement with the average detector is unnecessary.
 3. The emission levels of other frequencies were very low against the limit.
 4. Margin value = Emission level - Limit value
 5. Correction factor = Insertion loss + Cable loss
 6. Emission Level = Correction Factor + Reading Value.

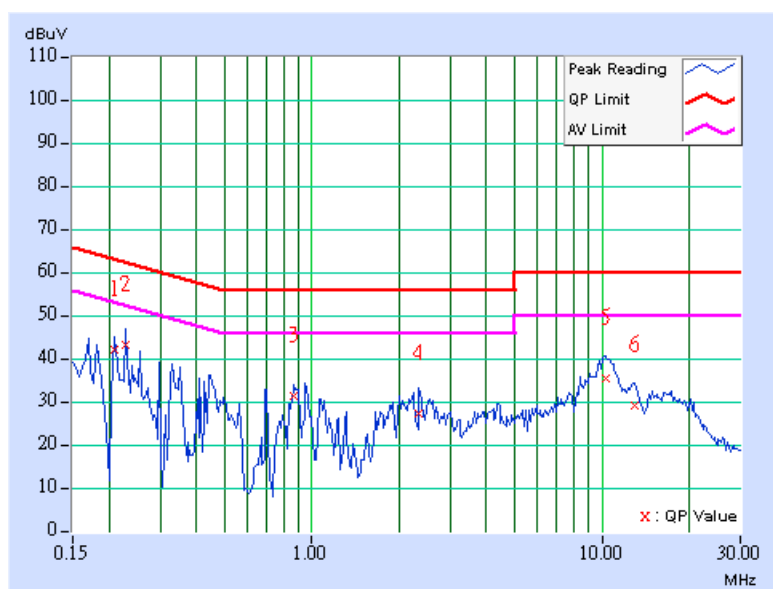

EUT TEST CONDITION		MEASUREMENT DETAIL	
CHANNEL	Channel 6	PHASE	Line 1
MODULATION TYPE	BPSK	6dB BANDWIDTH	9 kHz
TRANSFER RATE	6Mbps	INPUT POWER (SYSTEM)	120Vac, 60 Hz
ENVIRONMENTAL CONDITIONS	20deg. C, 60%RH, 991hPa	TESTED BY	Match Tsui

No	Freq. [MHz]	Corr. Factor (dB)	Reading Value [dB (uV)]		Emission Level [dB (uV)]		Limit [dB (uV)]		Margin (dB)	
			Q.P.	AV.	Q.P.	AV.	Q.P.	AV.	Q.P.	AV.
1	0.158	0.10	43.28	-	43.38	-	65.58	55.58	-22.20	-
2	0.224	0.10	45.42	-	45.52	-	62.66	52.66	-17.14	-
3	0.709	0.10	30.47	-	30.57	-	56.00	46.00	-25.43	-
4	2.281	0.22	28.40	-	28.62	-	56.00	46.00	-27.38	-
5	10.480	0.39	34.59	-	34.98	-	60.00	50.00	-25.02	-
6	12.793	0.51	28.62	-	29.13	-	60.00	50.00	-30.87	-

- REMARKS:**
1. Q.P. and AV. are abbreviations of quasi-peak and average individually.
 2. "-": The Quasi-peak reading value also meets average limit and measurement with the average detector is unnecessary.
 3. The emission levels of other frequencies were very low against the limit.
 4. Margin value = Emission level - Limit value
 5. Correction factor = Insertion loss + Cable loss
 6. Emission Level = Correction Factor + Reading Value.

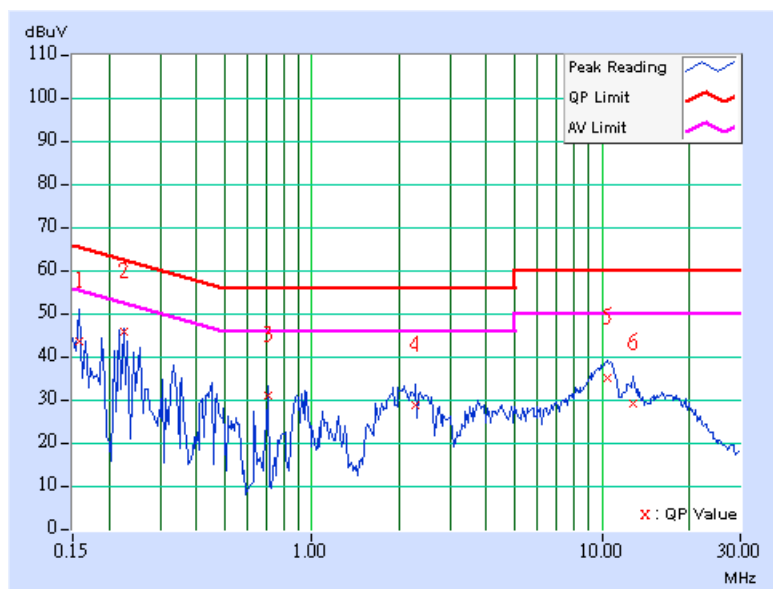

EUT TEST CONDITION		MEASUREMENT DETAIL	
CHANNEL	Channel 6	PHASE	Line 2
MODULATION TYPE	BPSK	6dB BANDWIDTH	9 kHz
TRANSFER RATE	6Mbps	INPUT POWER (SYSTEM)	120Vac, 60 Hz
ENVIRONMENTAL CONDITIONS	20deg. C, 60%RH, 991hPa	TESTED BY	Match Tsui

No	Freq. [MHz]	Corr. Factor [dB]	Reading Value [dB (uV)]		Emission Level [dB (uV)]		Limit [dB (uV)]		Margin (dB)	
			Q.P.	AV.	Q.P.	AV.	Q.P.	AV.	Q.P.	AV.
1	0.158	0.10	43.95	-	44.05	-	65.58	55.58	-21.53	-
2	0.349	0.10	34.93	-	35.03	-	58.98	48.98	-23.95	-
3	0.967	0.19	27.34	-	27.53	-	56.00	46.00	-28.47	-
4	2.441	0.24	25.48	-	25.72	-	56.00	46.00	-30.28	-
5	10.879	0.49	34.15	-	34.64	-	60.00	50.00	-25.36	-
6	13.688	0.59	24.62	-	25.21	-	60.00	50.00	-34.79	-

- REMARKS:**
1. Q.P. and AV. are abbreviations of quasi-peak and average individually.
 2. "-": The Quasi-peak reading value also meets average limit and measurement with the average detector is unnecessary.
 3. The emission levels of other frequencies were very low against the limit.
 4. Margin value = Emission level - Limit value
 5. Correction factor = Insertion loss + Cable loss
 6. Emission Level = Correction Factor + Reading Value.

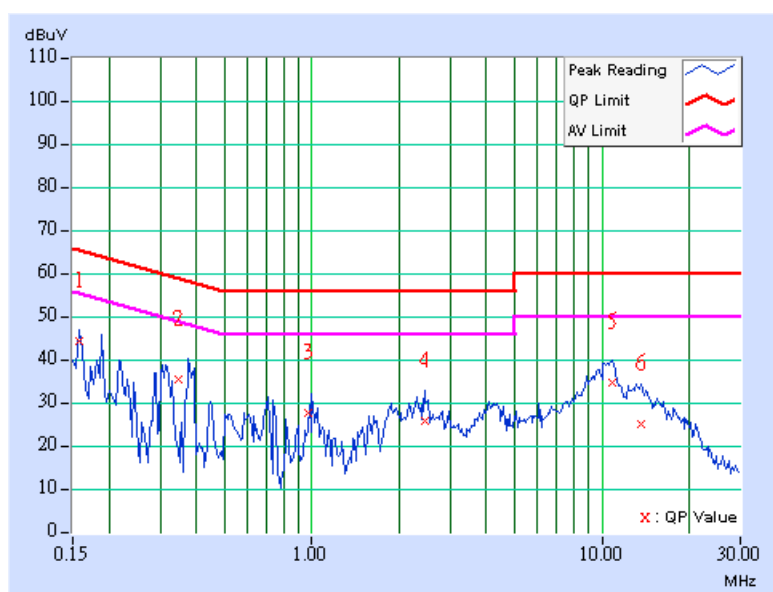

EUT TEST CONDITION		MEASUREMENT DETAIL	
CHANNEL	Channel 11	PHASE	Line 1
MODULATION TYPE	BPSK	6dB BANDWIDTH	9 kHz
TRANSFER RATE	6Mbps	INPUT POWER (SYSTEM)	120Vac, 60 Hz
ENVIRONMENTAL CONDITIONS	20deg. C, 60%RH, 991hPa	TESTED BY	Match Tsui

No	Freq. [MHz]	Corr. Factor [dB]	Reading Value [dB (uV)]		Emission Level [dB (uV)]		Limit [dB (uV)]		Margin (dB)	
			Q.P.	AV.	Q.P.	AV.	Q.P.	AV.	Q.P.	AV.
1	0.170	0.10	40.39	-	40.49	-	64.98	54.98	-24.49	-
2	0.228	0.10	45.26	-	45.36	-	62.52	52.52	-17.16	-
3	0.658	0.10	30.04	-	30.14	-	56.00	46.00	-25.86	-
4	2.047	0.20	26.33	-	26.53	-	56.00	46.00	-29.47	-
5	10.598	0.39	34.09	-	34.48	-	60.00	50.00	-25.52	-
6	12.816	0.51	28.08	-	28.59	-	60.00	50.00	-31.41	-

- REMARKS:**
1. Q.P. and AV. are abbreviations of quasi-peak and average individually.
 2. "-": The Quasi-peak reading value also meets average limit and measurement with the average detector is unnecessary.
 3. The emission levels of other frequencies were very low against the limit.
 4. Margin value = Emission level - Limit value
 5. Correction factor = Insertion loss + Cable loss
 6. Emission Level = Correction Factor + Reading Value.

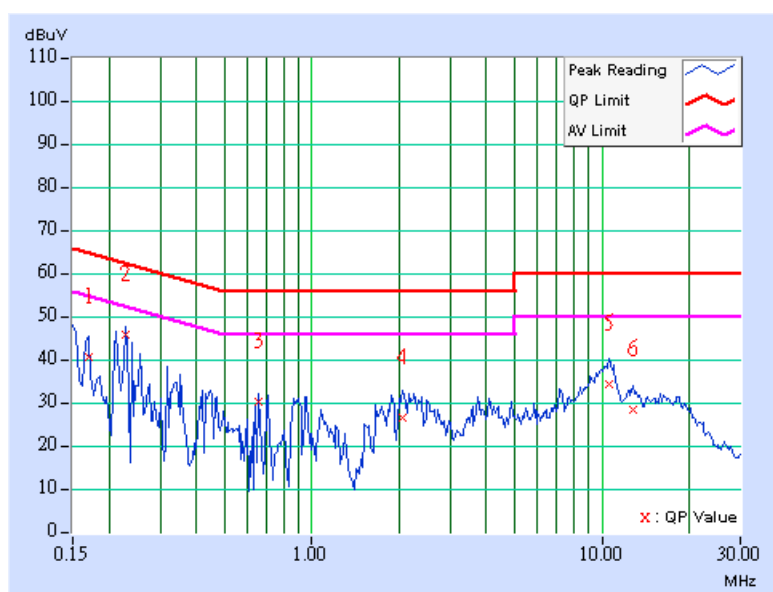

EUT TEST CONDITION		MEASUREMENT DETAIL	
CHANNEL	Channel 11	PHASE	Line 2
MODULATION TYPE	BPSK	6dB BANDWIDTH	9 kHz
TRANSFER RATE	6Mbps	INPUT POWER (SYSTEM)	120Vac, 60 Hz
ENVIRONMENTAL CONDITIONS	20deg. C, 60%RH, 991hPa	TESTED BY	Match Tsui

No	Freq. [MHz]	Corr. Factor [dB]	Reading Value [dB (uV)]		Emission Level [dB (uV)]		Limit [dB (uV)]		Margin (dB)	
			Q.P.	AV.	Q.P.	AV.	Q.P.	AV.	Q.P.	AV.
1	0.158	0.10	44.07	-	44.17	-	65.58	55.58	-21.41	-
2	0.255	0.10	39.46	-	39.56	-	61.58	51.58	-22.02	-
3	0.677	0.15	32.72	-	32.87	-	56.00	46.00	-23.13	-
4	2.156	0.21	27.23	-	27.44	-	56.00	46.00	-28.56	-
5	10.449	0.48	34.74	-	35.22	-	60.00	50.00	-24.78	-
6	12.598	0.55	28.54	-	29.09	-	60.00	50.00	-30.91	-

- REMARKS:**
1. Q.P. and AV. are abbreviations of quasi-peak and average individually.
 2. "-": The Quasi-peak reading value also meets average limit and measurement with the average detector is unnecessary.
 3. The emission levels of other frequencies were very low against the limit.
 4. Margin value = Emission level - Limit value
 5. Correction factor = Insertion loss + Cable loss
 6. Emission Level = Correction Factor + Reading Value.

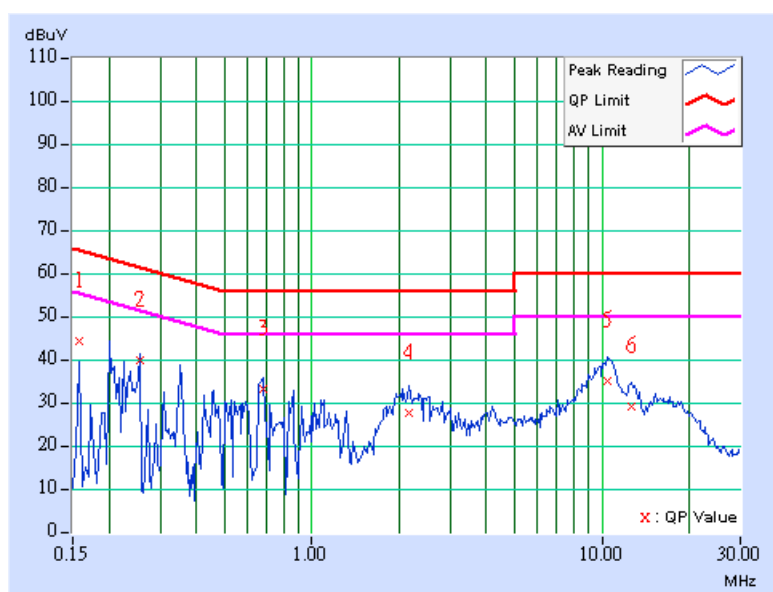

DRAFT 802.11n (20MHz) OFDM MODULATION: DUAL TX:

EUT TEST CONDITION		MEASUREMENT DETAIL	
CHANNEL	Channel 1	PHASE	Line 1
MODULATION TYPE	BPSK	6dB BANDWIDTH	9 kHz
TRANSFER RATE	14.444Mbps	INPUT POWER (SYSTEM)	120Vac, 60 Hz
ENVIRONMENTAL CONDITIONS	20deg. C, 60%RH, 991hPa	TESTED BY	Match Tsui

No	Freq. [MHz]	Corr. Factor [dB]	Reading Value [dB (uV)]		Emission Level [dB (uV)]		Limit [dB (uV)]		Margin (dB)	
			Q.P.	AV.	Q.P.	AV.	Q.P.	AV.	Q.P.	AV.
			1	0.158	0.10	44.77	-	44.87	-	65.58
2	0.216	0.10	44.46	-	44.56	-	62.96	52.96	-18.40	-
3	0.650	0.10	27.76	-	27.86	-	56.00	46.00	-28.14	-
4	2.082	0.21	28.22	-	28.43	-	56.00	46.00	-27.57	-
5	10.617	0.39	34.03	-	34.42	-	60.00	50.00	-25.58	-
6	16.137	0.61	26.06	-	26.67	-	60.00	50.00	-33.33	-

- REMARKS:**
1. Q.P. and AV. are abbreviations of quasi-peak and average individually.
 2. "-": The Quasi-peak reading value also meets average limit and measurement with the average detector is unnecessary.
 3. The emission levels of other frequencies were very low against the limit.
 4. Margin value = Emission level - Limit value
 5. Correction factor = Insertion loss + Cable loss
 6. Emission Level = Correction Factor + Reading Value.

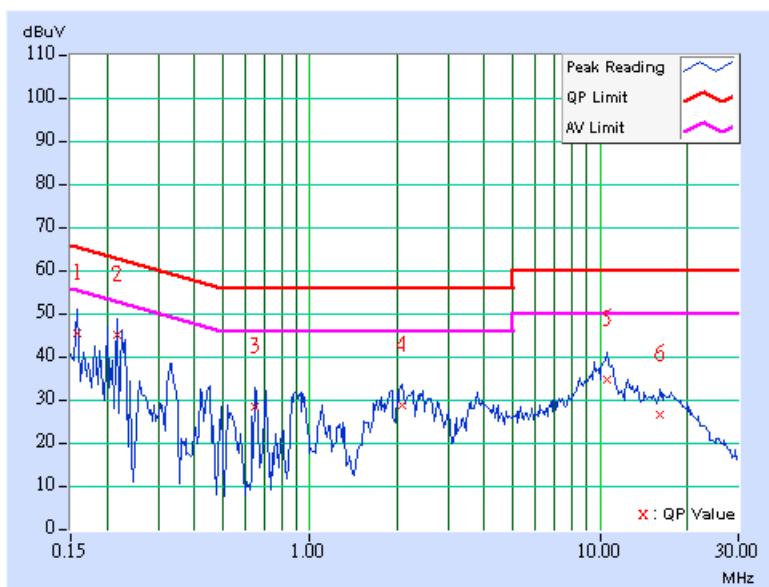

EUT TEST CONDITION		MEASUREMENT DETAIL	
CHANNEL	Channel 1	PHASE	Line 2
MODULATION TYPE	BPSK	6dB BANDWIDTH	9 kHz
TRANSFER RATE	14.444Mbps	INPUT POWER (SYSTEM)	120Vac, 60 Hz
ENVIRONMENTAL CONDITIONS	20deg. C, 60%RH, 991hPa	TESTED BY	Match Tsui

No	Freq. [MHz]	Corr. Factor [dB]	Reading Value [dB (uV)]		Emission Level [dB (uV)]		Limit [dB (uV)]		Margin (dB)	
			Q.P.	AV.	Q.P.	AV.	Q.P.	AV.	Q.P.	AV.
1	0.158	0.10	42.87	-	42.97	-	65.58	55.58	-22.61	-
2	0.232	0.10	40.23	-	40.33	-	62.38	52.38	-22.05	-
3	0.667	0.14	32.27	-	32.41	-	56.00	46.00	-23.59	-
4	2.383	0.23	27.57	-	27.80	-	56.00	46.00	-28.20	-
5	10.441	0.48	35.18	-	35.66	-	60.00	50.00	-24.34	-
6	12.688	0.55	28.80	-	29.35	-	60.00	50.00	-30.65	-

- REMARKS:**
1. Q.P. and AV. are abbreviations of quasi-peak and average individually.
 2. "-": The Quasi-peak reading value also meets average limit and measurement with the average detector is unnecessary.
 3. The emission levels of other frequencies were very low against the limit.
 4. Margin value = Emission level - Limit value
 5. Correction factor = Insertion loss + Cable loss
 6. Emission Level = Correction Factor + Reading Value.

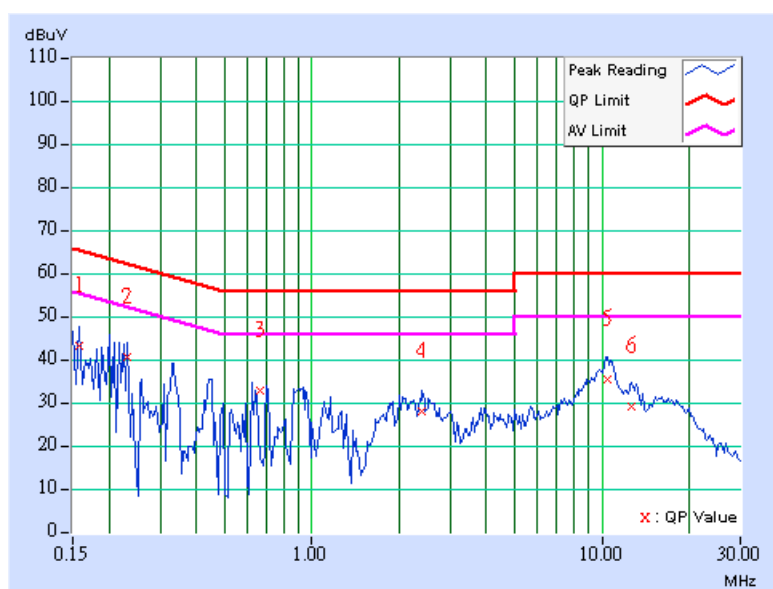

EUT TEST CONDITION		MEASUREMENT DETAIL	
CHANNEL	Channel 6	PHASE	Line 1
MODULATION TYPE	BPSK	6dB BANDWIDTH	9 kHz
TRANSFER RATE	14.444Mbps	INPUT POWER (SYSTEM)	120Vac, 60 Hz
ENVIRONMENTAL CONDITIONS	20deg. C, 60%RH, 991hPa	TESTED BY	Match Tsui

No	Freq. [MHz]	Corr. Factor [dB]	Reading Value [dB (uV)]		Emission Level [dB (uV)]		Limit [dB (uV)]		Margin (dB)	
			Q.P.	AV.	Q.P.	AV.	Q.P.	AV.	Q.P.	AV.
1	0.162	0.10	43.36	-	43.46	-	65.38	55.38	-21.92	-
2	0.205	0.10	42.73	-	42.83	-	63.42	53.42	-20.59	-
3	0.685	0.10	29.34	-	29.44	-	56.00	46.00	-26.56	-
4	1.949	0.19	26.23	-	26.42	-	56.00	46.00	-29.58	-
5	10.691	0.40	33.78	-	34.18	-	60.00	50.00	-25.82	-
6	12.789	0.51	29.34	-	29.85	-	60.00	50.00	-30.15	-

- REMARKS:**
1. Q.P. and AV. are abbreviations of quasi-peak and average individually.
 2. "-": The Quasi-peak reading value also meets average limit and measurement with the average detector is unnecessary.
 3. The emission levels of other frequencies were very low against the limit.
 4. Margin value = Emission level - Limit value
 5. Correction factor = Insertion loss + Cable loss
 6. Emission Level = Correction Factor + Reading Value.

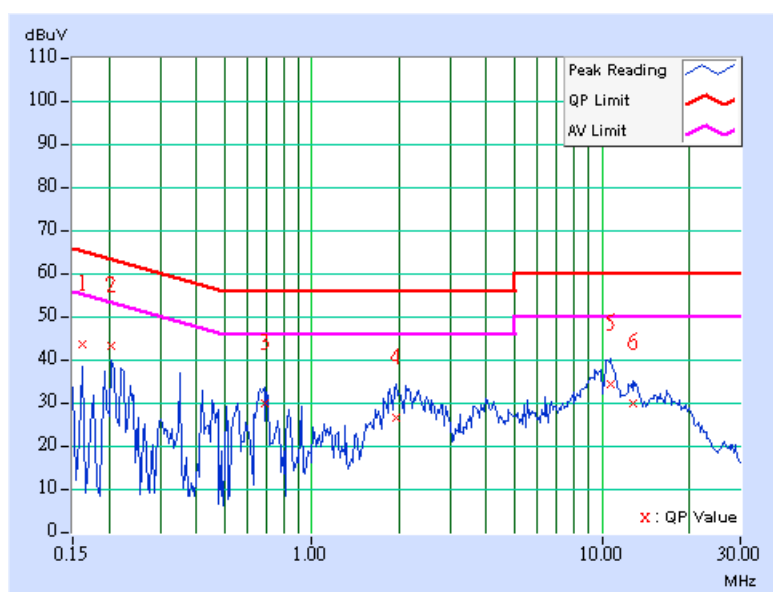

EUT TEST CONDITION		MEASUREMENT DETAIL	
CHANNEL	Channel 6	PHASE	Line 2
MODULATION TYPE	BPSK	6dB BANDWIDTH	9 kHz
TRANSFER RATE	14.444Mbps	INPUT POWER (SYSTEM)	120Vac, 60 Hz
ENVIRONMENTAL CONDITIONS	20deg. C, 60%RH, 991hPa	TESTED BY	Match Tsui

No	Freq. [MHz]	Corr. Factor [dB]	Reading Value [dB (uV)]		Emission Level [dB (uV)]		Limit [dB (uV)]		Margin (dB)	
			Q.P.	AV.	Q.P.	AV.	Q.P.	AV.	Q.P.	AV.
1	0.209	0.10	41.18	-	41.28	-	63.26	53.26	-21.98	-
2	0.252	0.10	40.57	-	40.67	-	61.71	51.71	-21.04	-
3	0.670	0.14	32.37	-	32.51	-	56.00	46.00	-23.49	-
4	2.379	0.23	28.01	-	28.24	-	56.00	46.00	-27.76	-
5	10.387	0.47	35.02	-	35.49	-	60.00	50.00	-24.51	-
6	13.055	0.56	29.53	-	30.09	-	60.00	50.00	-29.91	-

- REMARKS:**
1. Q.P. and AV. are abbreviations of quasi-peak and average individually.
 2. "-": The Quasi-peak reading value also meets average limit and measurement with the average detector is unnecessary.
 3. The emission levels of other frequencies were very low against the limit.
 4. Margin value = Emission level - Limit value
 5. Correction factor = Insertion loss + Cable loss
 6. Emission Level = Correction Factor + Reading Value.

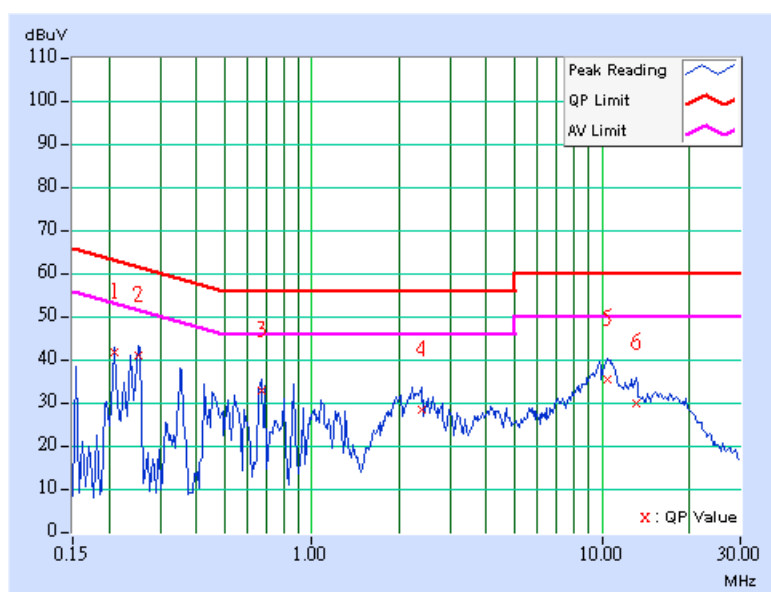

EUT TEST CONDITION		MEASUREMENT DETAIL	
CHANNEL	Channel 11	PHASE	Line 1
MODULATION TYPE	BPSK	6dB BANDWIDTH	9 kHz
TRANSFER RATE	14.444Mbps	INPUT POWER (SYSTEM)	120Vac, 60 Hz
ENVIRONMENTAL CONDITIONS	20deg. C, 60%RH, 991hPa	TESTED BY	Match Tsui

No	Freq. [MHz]	Corr. Factor [dB]	Reading Value [dB (uV)]		Emission Level [dB (uV)]		Limit [dB (uV)]		Margin (dB)	
			Q.P.	AV.	Q.P.	AV.	Q.P.	AV.	Q.P.	AV.
1	0.154	0.10	43.77	-	43.87	-	65.79	55.79	-21.92	-
2	0.228	0.10	42.54	-	42.64	-	62.52	52.52	-19.88	-
3	0.673	0.10	30.77	-	30.87	-	56.00	46.00	-25.13	-
4	2.082	0.21	27.65	-	27.86	-	56.00	46.00	-28.14	-
5	10.668	0.40	34.11	-	34.51	-	60.00	50.00	-25.49	-
6	18.578	0.58	26.35	-	26.93	-	60.00	50.00	-33.07	-

- REMARKS:**
1. Q.P. and AV. are abbreviations of quasi-peak and average individually.
 2. "-": The Quasi-peak reading value also meets average limit and measurement with the average detector is unnecessary.
 3. The emission levels of other frequencies were very low against the limit.
 4. Margin value = Emission level - Limit value
 5. Correction factor = Insertion loss + Cable loss
 6. Emission Level = Correction Factor + Reading Value.

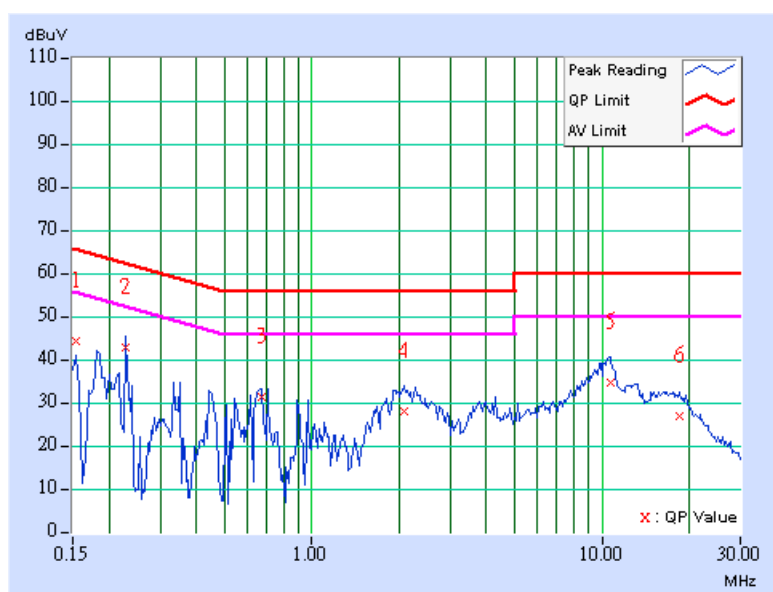

EUT TEST CONDITION		MEASUREMENT DETAIL	
CHANNEL	Channel 11	PHASE	Line 2
MODULATION TYPE	BPSK	6dB BANDWIDTH	9 kHz
TRANSFER RATE	14.444Mbps	INPUT POWER (SYSTEM)	120Vac, 60 Hz
ENVIRONMENTAL CONDITIONS	20deg. C, 60%RH, 991hPa	TESTED BY	Match Tsui

No	Freq. [MHz]	Corr. Factor [dB]	Reading Value [dB (uV)]		Emission Level [dB (uV)]		Limit [dB (uV)]		Margin (dB)	
			Q.P.	AV.	Q.P.	AV.	Q.P.	AV.	Q.P.	AV.
1	0.150	0.10	47.13	-	47.23	-	66.00	56.00	-18.77	-
2	0.228	0.10	44.47	-	44.57	-	62.52	52.52	-17.95	-
3	0.662	0.14	32.39	-	32.53	-	56.00	46.00	-23.47	-
4	2.137	0.21	27.18	-	27.39	-	56.00	46.00	-28.61	-
5	10.340	0.47	34.39	-	34.86	-	60.00	50.00	-25.14	-
6	16.672	0.61	26.80	-	27.41	-	60.00	50.00	-32.59	-

- REMARKS:**
1. Q.P. and AV. are abbreviations of quasi-peak and average individually.
 2. "-": The Quasi-peak reading value also meets average limit and measurement with the average detector is unnecessary.
 3. The emission levels of other frequencies were very low against the limit.
 4. Margin value = Emission level - Limit value
 5. Correction factor = Insertion loss + Cable loss
 6. Emission Level = Correction Factor + Reading Value.

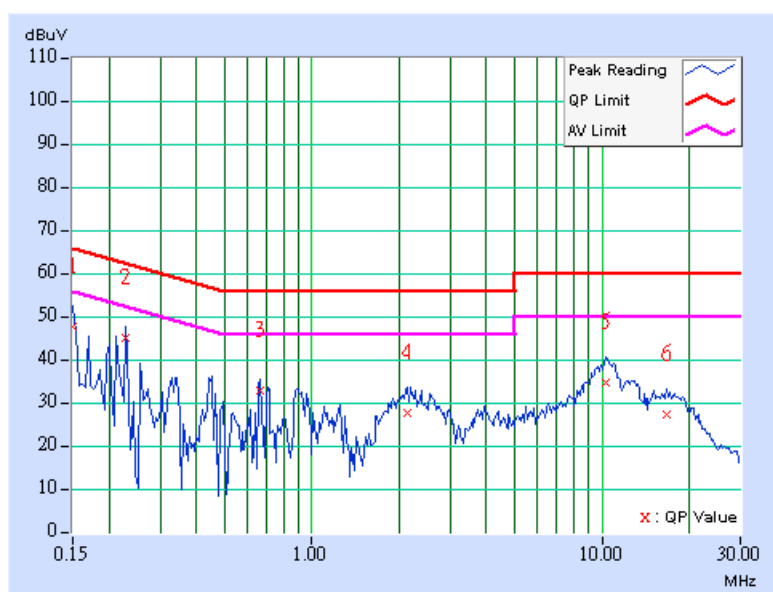

DRAFT 802.11n (40MHz) OFDM MODULATION: DUAL TX:

EUT TEST CONDITION		MEASUREMENT DETAIL	
CHANNEL	Channel 1	PHASE	Line 1
MODULATION TYPE	BPSK	6dB BANDWIDTH	9 kHz
TRANSFER RATE	30Mbps	INPUT POWER (SYSTEM)	120Vac, 60 Hz
ENVIRONMENTAL CONDITIONS	20deg. C, 60%RH, 991hPa	TESTED BY	Match Tsui

No	Freq. [MHz]	Corr. Factor (dB)	Reading Value [dB (uV)]		Emission Level [dB (uV)]		Limit [dB (uV)]		Margin (dB)	
			Q.P.	AV.	Q.P.	AV.	Q.P.	AV.	Q.P.	AV.
			1	0.154	0.10	43.22	-	43.32	-	65.79
2	0.252	0.10	39.21	-	39.31	-	61.71	51.71	-22.40	-
3	0.667	0.10	30.52	-	30.62	-	56.00	46.00	-25.38	-
4	2.129	0.21	27.92	-	28.13	-	56.00	46.00	-27.87	-
5	10.551	0.39	34.06	-	34.45	-	60.00	50.00	-25.55	-
6	12.922	0.52	29.13	-	29.65	-	60.00	50.00	-30.35	-

- REMARKS:**
1. Q.P. and AV. are abbreviations of quasi-peak and average individually.
 2. "-": The Quasi-peak reading value also meets average limit and measurement with the average detector is unnecessary.
 3. The emission levels of other frequencies were very low against the limit.
 4. Margin value = Emission level - Limit value
 5. Correction factor = Insertion loss + Cable loss
 6. Emission Level = Correction Factor + Reading Value.

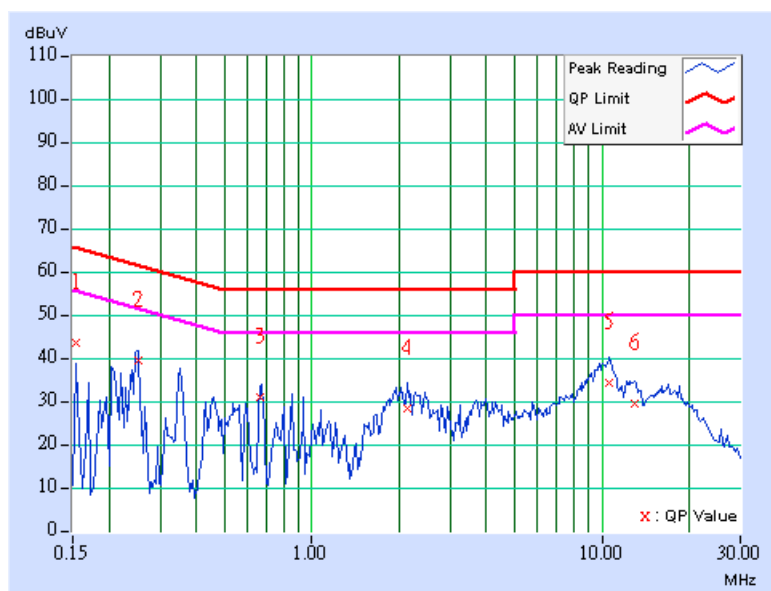

EUT TEST CONDITION		MEASUREMENT DETAIL	
CHANNEL	Channel 1	PHASE	Line 2
MODULATION TYPE	BPSK	6dB BANDWIDTH	9 kHz
TRANSFER RATE	30Mbps	INPUT POWER (SYSTEM)	120Vac, 60 Hz
ENVIRONMENTAL CONDITIONS	20deg. C, 60%RH, 991hPa	TESTED BY	Match Tsui

No	Freq. [MHz]	Corr. Factor [dB]	Reading Value [dB (uV)]		Emission Level [dB (uV)]		Limit [dB (uV)]		Margin (dB)	
			Q.P.	AV.	Q.P.	AV.	Q.P.	AV.	Q.P.	AV.
1	0.166	0.10	41.34	-	41.44	-	65.18	55.18	-23.74	-
2	0.252	0.10	40.59	-	40.69	-	61.71	51.71	-21.02	-
3	0.670	0.14	32.43	-	32.57	-	56.00	46.00	-23.43	-
4	2.316	0.23	26.86	-	27.09	-	56.00	46.00	-28.91	-
5	10.781	0.49	34.91	-	35.40	-	60.00	50.00	-24.60	-
6	12.961	0.56	29.56	-	30.12	-	60.00	50.00	-29.88	-

- REMARKS:**
1. Q.P. and AV. are abbreviations of quasi-peak and average individually.
 2. "-": The Quasi-peak reading value also meets average limit and measurement with the average detector is unnecessary.
 3. The emission levels of other frequencies were very low against the limit.
 4. Margin value = Emission level - Limit value
 5. Correction factor = Insertion loss + Cable loss
 6. Emission Level = Correction Factor + Reading Value.

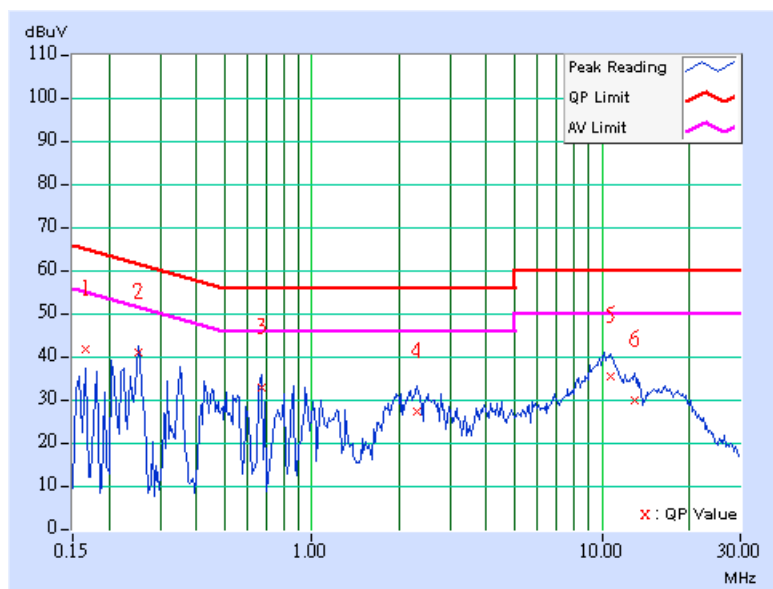

EUT TEST CONDITION		MEASUREMENT DETAIL	
CHANNEL	Channel 4	PHASE	Line 1
MODULATION TYPE	BPSK	6dB BANDWIDTH	9 kHz
TRANSFER RATE	30Mbps	INPUT POWER (SYSTEM)	120Vac, 60 Hz
ENVIRONMENTAL CONDITIONS	20deg. C, 60%RH, 991hPa	TESTED BY	Match Tsui

No	Freq. [MHz]	Corr. Factor [dB]	Reading Value [dB (uV)]		Emission Level [dB (uV)]		Limit [dB (uV)]		Margin (dB)	
			Q.P.	AV.	Q.P.	AV.	Q.P.	AV.	Q.P.	AV.
1	0.150	0.10	46.93	-	47.03	-	66.00	56.00	-18.97	-
2	0.213	0.10	41.11	-	41.21	-	63.11	53.11	-21.90	-
3	0.677	0.10	31.05	-	31.15	-	56.00	46.00	-24.85	-
4	2.113	0.21	28.07	-	28.28	-	56.00	46.00	-27.72	-
5	10.789	0.40	33.95	-	34.35	-	60.00	50.00	-25.65	-
6	12.328	0.49	29.30	-	29.79	-	60.00	50.00	-30.21	-

- REMARKS:**
1. Q.P. and AV. are abbreviations of quasi-peak and average individually.
 2. "-": The Quasi-peak reading value also meets average limit and measurement with the average detector is unnecessary.
 3. The emission levels of other frequencies were very low against the limit.
 4. Margin value = Emission level - Limit value
 5. Correction factor = Insertion loss + Cable loss
 6. Emission Level = Correction Factor + Reading Value.

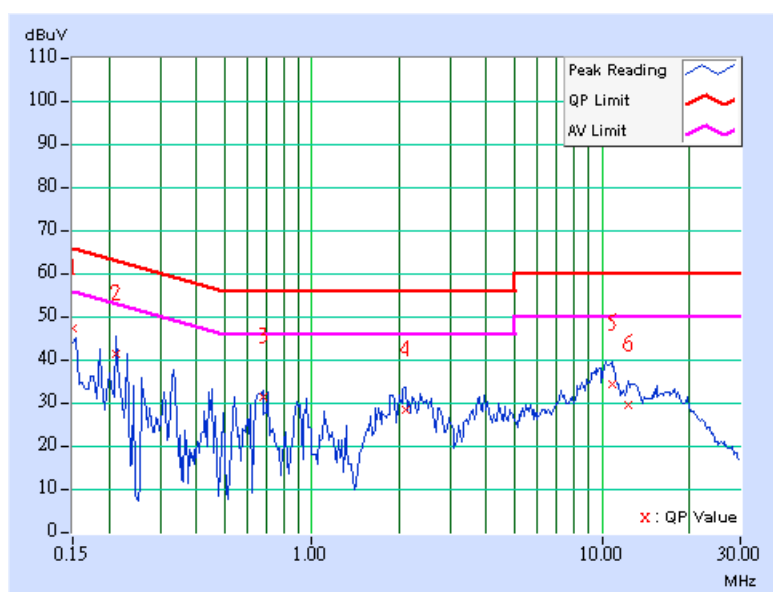

EUT TEST CONDITION		MEASUREMENT DETAIL	
CHANNEL	Channel 4	PHASE	Line 2
MODULATION TYPE	BPSK	6dB BANDWIDTH	9 kHz
TRANSFER RATE	30Mbps	INPUT POWER (SYSTEM)	120Vac, 60 Hz
ENVIRONMENTAL CONDITIONS	20deg. C, 60%RH, 991hPa	TESTED BY	Match Tsui

No	Freq. [MHz]	Corr. Factor [dB]	Reading Value [dB (uV)]		Emission Level [dB (uV)]		Limit [dB (uV)]		Margin (dB)	
			Q.P.	AV.	Q.P.	AV.	Q.P.	AV.	Q.P.	AV.
1	0.150	0.10	45.96	-	46.06	-	66.00	56.00	-19.94	-
2	0.216	0.10	45.02	-	45.12	-	62.96	52.96	-17.84	-
3	0.705	0.15	32.16	-	32.31	-	56.00	46.00	-23.69	-
4	2.195	0.22	27.03	-	27.25	-	56.00	46.00	-28.75	-
5	10.527	0.48	35.27	-	35.75	-	60.00	50.00	-24.25	-
6	12.965	0.56	29.58	-	30.14	-	60.00	50.00	-29.86	-

- REMARKS:**
1. Q.P. and AV. are abbreviations of quasi-peak and average individually.
 2. "-": The Quasi-peak reading value also meets average limit and measurement with the average detector is unnecessary.
 3. The emission levels of other frequencies were very low against the limit.
 4. Margin value = Emission level - Limit value
 5. Correction factor = Insertion loss + Cable loss
 6. Emission Level = Correction Factor + Reading Value.

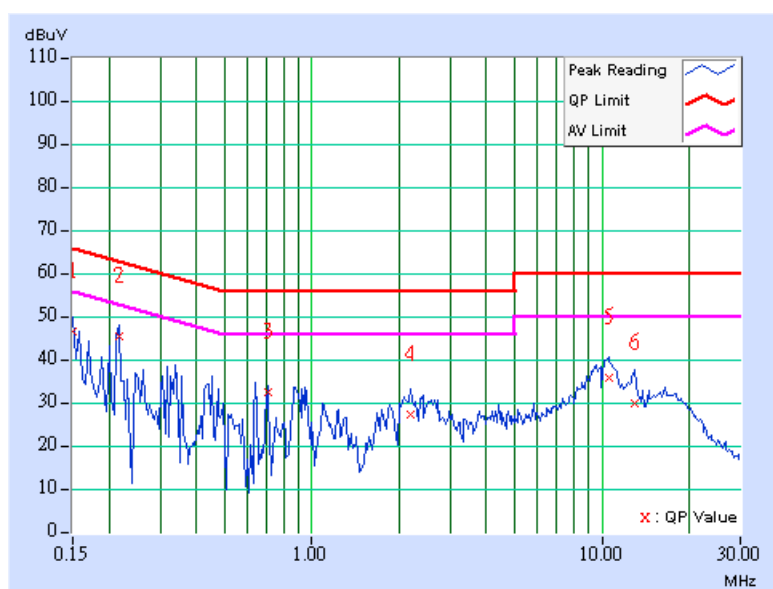

EUT TEST CONDITION		MEASUREMENT DETAIL	
CHANNEL	Channel 7	PHASE	Line 1
MODULATION TYPE	BPSK	6dB BANDWIDTH	9 kHz
TRANSFER RATE	30Mbps	INPUT POWER (SYSTEM)	120Vac, 60 Hz
ENVIRONMENTAL CONDITIONS	20deg. C, 60%RH, 991hPa	TESTED BY	Match Tsui

No	Freq. [MHz]	Corr. Factor [dB]	Reading Value [dB (uV)]		Emission Level [dB (uV)]		Limit [dB (uV)]		Margin (dB)	
			Q.P.	AV.	Q.P.	AV.	Q.P.	AV.	Q.P.	AV.
1	0.150	0.10	46.73	-	46.83	-	66.00	56.00	-19.17	-
2	0.220	0.10	44.26	-	44.36	-	62.81	52.81	-18.45	-
3	0.658	0.10	30.28	-	30.38	-	56.00	46.00	-25.62	-
4	2.051	0.20	26.59	-	26.79	-	56.00	46.00	-29.21	-
5	10.496	0.39	34.82	-	35.21	-	60.00	50.00	-24.79	-
6	12.449	0.49	29.25	-	29.74	-	60.00	50.00	-30.26	-

- REMARKS:**
1. Q.P. and AV. are abbreviations of quasi-peak and average individually.
 2. "-": The Quasi-peak reading value also meets average limit and measurement with the average detector is unnecessary.
 3. The emission levels of other frequencies were very low against the limit.
 4. Margin value = Emission level - Limit value
 5. Correction factor = Insertion loss + Cable loss
 6. Emission Level = Correction Factor + Reading Value.

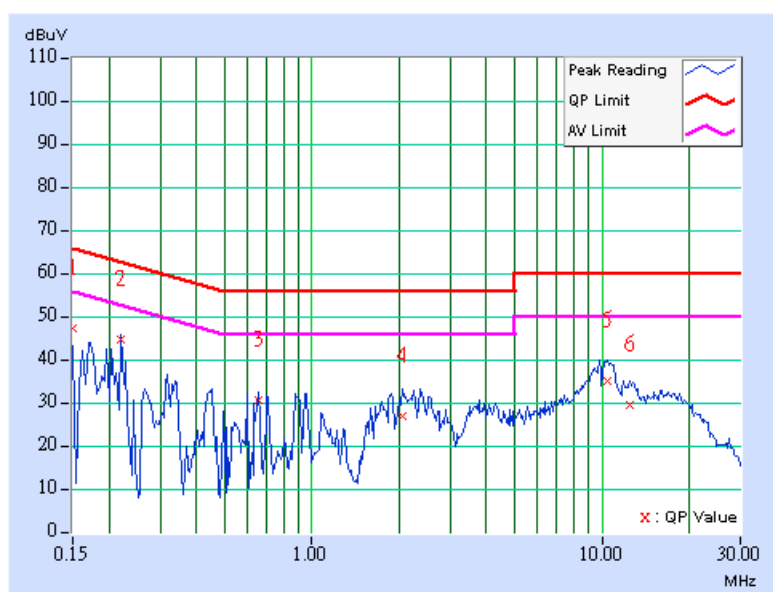

EUT TEST CONDITION		MEASUREMENT DETAIL	
CHANNEL	Channel 7	PHASE	Line 2
MODULATION TYPE	BPSK	6dB BANDWIDTH	9 kHz
TRANSFER RATE	30Mbps	INPUT POWER (SYSTEM)	120Vac, 60 Hz
ENVIRONMENTAL CONDITIONS	20deg. C, 60%RH, 991hPa	TESTED BY	Match Tsui

No	Freq. [MHz]	Corr. Factor [dB]	Reading Value [dB (uV)]		Emission Level [dB (uV)]		Limit [dB (uV)]		Margin (dB)	
			Q.P.	AV.	Q.P.	AV.	Q.P.	AV.	Q.P.	AV.
1	0.150	0.10	46.43	-	46.53	-	66.00	56.00	-19.47	-
2	0.220	0.10	45.74	-	45.84	-	62.81	52.81	-16.97	-
3	0.709	0.15	32.22	-	32.37	-	56.00	46.00	-23.63	-
4	2.324	0.23	26.67	-	26.90	-	56.00	46.00	-29.10	-
5	10.262	0.47	34.55	-	35.02	-	60.00	50.00	-24.98	-
6	12.672	0.55	30.06	-	30.61	-	60.00	50.00	-29.39	-

- REMARKS:**
1. Q.P. and AV. are abbreviations of quasi-peak and average individually.
 2. "-": The Quasi-peak reading value also meets average limit and measurement with the average detector is unnecessary.
 3. The emission levels of other frequencies were very low against the limit.
 4. Margin value = Emission level - Limit value
 5. Correction factor = Insertion loss + Cable loss
 6. Emission Level = Correction Factor + Reading Value.

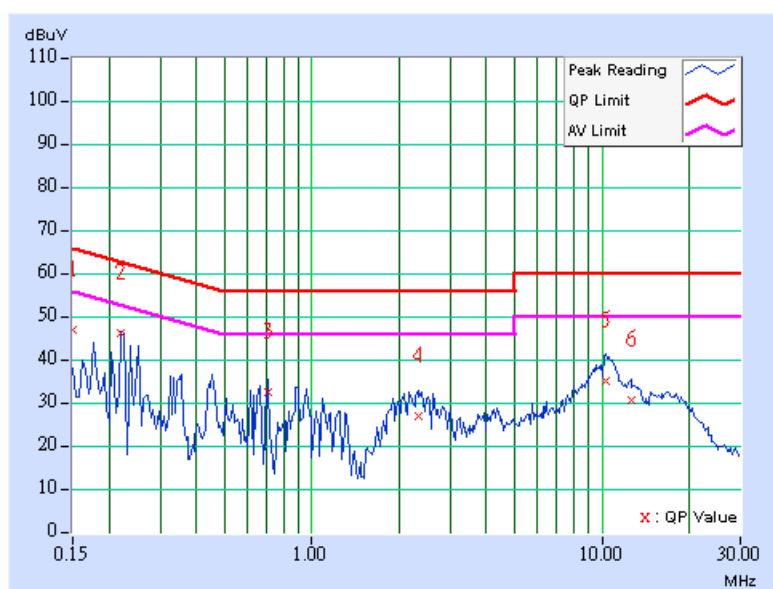

4.2 RADIATED EMISSION MEASUREMENT

4.2.1 LIMITS OF RADIATED EMISSION MEASUREMENT

Emissions radiated outside of the specified bands, shall be according to the general radiated limits in 15.209 as following:

FREQUENCIES (MHz)	FIELD STRENGTH (microvolts/meter)	MEASUREMENT DISTANCE (meters)
0.009 ~ 0.490	2400 / F(kHz)	300
0.490 ~ 1.705	24000 / F(kHz)	30
1.705 ~ 30.0	30	30
30 ~ 88	100	3
88 ~ 216	150	3
216 ~ 960	200	3
Above 960	500	3

NOTE:

1. The lower limit shall apply at the transition frequencies.
2. Emission level (dBuV/m) = 20 log Emission level (uV/m).
3. As shown in 15.35(b), for frequencies above 1000MHz, the field strength limits are based on average detector, however, the peak field strength of any emission shall not exceed the maximum permitted average limits, specified above by more than 20dB under any condition of modulation.



4.2.2 TEST INSTRUMENTS

DESCRIPTION & MANUFACTURER	MODEL NO.	SERIAL NO.	CALIBRATED UNTIL
Test Receiver ROHDE & SCHWARZ	ESIB7	100188	Dec. 20, 2006
Spectrum Analyzer ROHDE & SCHWARZ	FSP40	100039	Nov. 27, 2006
BILOG Antenna SCHWARZBECK	VULB9168	9168-157	Jan. 15, 2007
HORN Antenna SCHWARZBECK	BBHA 9120 D	9120D-407	Jan. 22, 2007
HORN Antenna SCHWARZBECK	BBHA 9170	BBHA9170147	Jan. 26, 2007
Preamplifier Agilent	8449B	3008A01961	Oct. 23, 2006
Preamplifier Agilent	8447D	2944A10629	Oct. 27, 2006
RF signal cable HUBER+SUHNER	SUCOFLEX 104	214380/4	Jan. 16, 2007
RF signal cable HUBER+SUHNER	SUCOFLEX 104	219266/4	Jan. 16, 2007
Software ADT.	ADT_Radiated_V5.14	NA	NA
Antenna Tower ADT.	AT100	AT93021702	NA
Turn Table ADT.	TT100.	TT93021702	NA
Controller ADT.	SC100.	SC93021702	NA

- NOTE:**
1. The calibration interval of the above test instruments is 12 months and the calibrations are traceable to NML/ROC and NIST/USA.
 2. The test was performed in HwaYa Chamber 1.
 3. The horn antenna and HP preamplifier (model: 8449B) are used only for the measurement of emission frequency above 1GHz if tested.
 4. The IC Site Registration No. is IC4924-2.

4.2.3 TEST PROCEDURES

- a. The EUT was placed on the top of a rotating table 0.8 meters above the ground at a 3 meters semi-anechoic chamber. The table was rotated 360 degrees to determine the position of the highest radiation.
- b. The EUT was set 3 meters away from the interference-receiving antenna, which was mounted on the top of a variable-height antenna tower.
- c. The antenna is a broadband antenna, and its height is varied from one meter to four meters above the ground to determine the maximum value of the field strength. Both horizontal and vertical polarizations of the antenna are set to make the measurement.
- d. For each suspected emission, the EUT was arranged to its worst case and then the antenna was tuned to heights from 1 meter to 4 meters and the rotatable table was turned from 0 degrees to 360 degrees to find the maximum reading.
- e. The test-receiver system was set to Peak Detect Function and Specified Bandwidth with Maximum Hold Mode.
- f. If the emission level of the EUT in peak mode was lower than the limit specified, then testing could be stopped and the peak values of the EUT would be reported. Otherwise the emissions would be re-tested one by one using peak, quasi-peak or average method as specified and then reported in a data sheet.

NOTE:

1. The resolution bandwidth and video bandwidth of test receiver/spectrum analyzer is 120kHz for Peak detection (PK) and Quasi-peak detection (QP) at frequency below 1GHz.
2. The resolution bandwidth and video bandwidth of test receiver/spectrum analyzer is 1 MHz for Peak detection at frequency above 1GHz.
3. The resolution bandwidth of test receiver/spectrum analyzer is 1MHz and the video bandwidth is 1kHz for Average detection (AV) at frequency above 1GHz.

4.2.4 DEVIATION FROM TEST STANDARD

No deviation

4.2.5 TEST SETUP

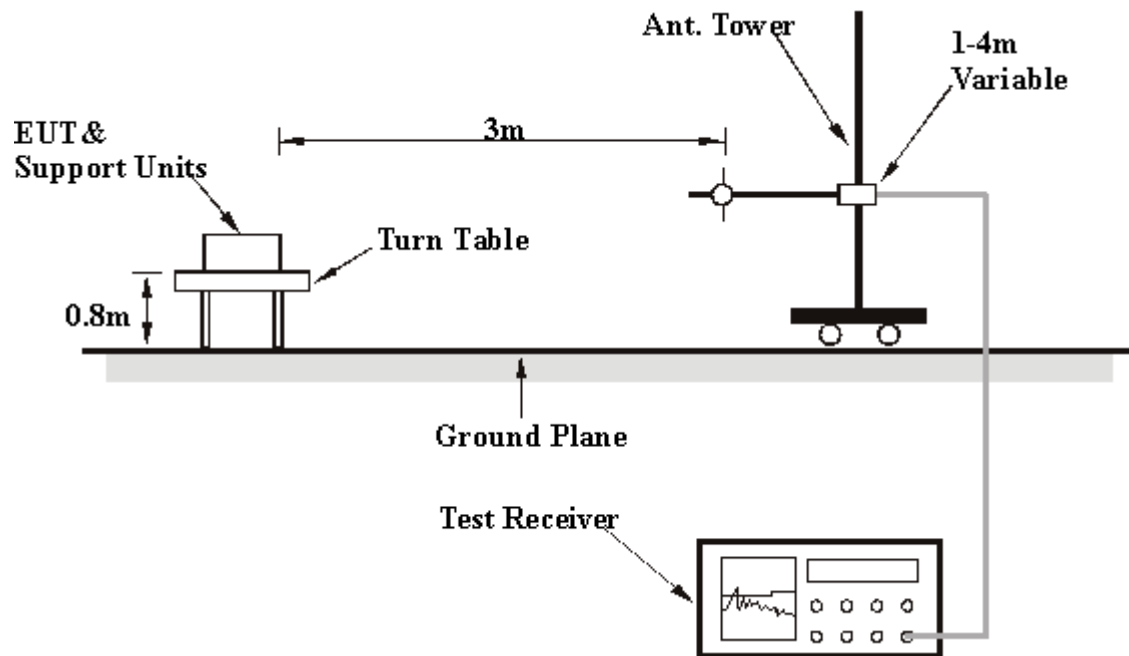

For the actual test configuration, please refer to the related item – Photographs of the Test Configuration.

4.2.6 EUT OPERATING CONDITIONS

Same as 4.1.6

4.2.7 TEST RESULTS

BELOW 1GHz WORST-CASE DATA: 802.11g OFDM MODULATION:

EUT TEST CONDITION		MEASUREMENT DETAIL	
CHANNEL	Channel 1	FREQUENCY RANGE	Below 1000MHz
MODULATION TYPE	BPSK for 802.11g	INPUT POWER (SYSTEM)	120Vac, 60 Hz
TRANSFER RATE	6Mbps	DETECTOR FUNCTION	Quasi-Peak
ENVIRONMENTAL CONDITIONS	25deg. C, 65%RH, 991hPa	TESTED BY	Lori Chui

ANTENNA POLARITY & TEST DISTANCE: HORIZONTAL AT 3 M								
No.	Freq. (MHz)	Emission Level (dBuV/m)	Limit (dBuV/m)	Margin (dB)	Antenna Height (m)	Table Angle (Degree)	Raw Value (dBuV)	Correction Factor (dB/m)
1	113.59	31.15 QP	43.50	-12.35	2.00 H	37	20.92	10.23
2	160.24	27.69 QP	43.50	-15.81	1.00 H	67	14.30	13.39
3	166.07	28.79 QP	43.50	-14.71	1.00 H	340	15.76	13.03
4	298.26	31.31 QP	46.00	-14.69	1.00 H	340	15.78	15.53
5	333.25	39.99 QP	46.00	-6.01	2.50 H	193	23.94	16.06
6	372.12	33.30 QP	46.00	-12.70	2.00 H	28	16.28	17.01
7	399.34	30.30 QP	46.00	-15.70	2.50 H	193	12.38	17.92
8	465.43	32.23 QP	46.00	-13.77	2.50 H	193	12.93	19.30

ANTENNA POLARITY & TEST DISTANCE: VERTICAL AT 3 M								
No.	Freq. (MHz)	Emission Level (dBuV/m)	Limit (dBuV/m)	Margin (dB)	Antenna Height (m)	Table Angle (Degree)	Raw Value (dBuV)	Correction Factor (dB/m)
1	61.10	25.77 QP	40.00	-14.23	1.50 V	262	12.42	13.35
2	63.05	24.28 QP	40.00	-15.72	1.00 V	259	11.27	13.01
3	121.36	29.48 QP	43.50	-14.02	1.00 V	112	18.49	10.99
4	160.24	31.32 QP	43.50	-12.18	1.50 V	262	17.93	13.39
5	166.07	33.68 QP	43.50	-9.82	1.00 V	109	20.65	13.03
6	331.30	31.19 QP	46.00	-14.81	1.00 V	109	15.16	16.03
7	465.43	29.14 QP	46.00	-16.86	1.00 V	100	9.85	19.30

- REMARKS:**
1. Emission level(dBuV/m)=Raw Value(dBuV) + Correction Factor(dB/m)
 2. Correction Factor(dB/m) = Antenna Factor (dB/m) + Cable Factor (dB)
 3. The other emission levels were very low against the limit.
 4. Margin value = Emission level – Limit value.

DRAFT 802.11n (20MHz) OFDM MODULATION: SINGLE TX:

EUT TEST CONDITION		MEASUREMENT DETAIL	
CHANNEL	Channel 1	FREQUENCY RANGE	Below 1000MHz
MODULATION TYPE	BPSK for draft 802.11n (20MHz)	INPUT POWER (SYSTEM)	120Vac, 60 Hz
TRANSFER RATE	7.2Mbps	DETECTOR FUNCTION	Quasi-Peak
ENVIRONMENTAL CONDITIONS	25deg. C, 65%RH, 991hPa	TESTED BY	Lori Chui

ANTENNA POLARITY & TEST DISTANCE: HORIZONTAL AT 3 M

NO.	FREQ. (MHz)	EMISSION LEVEL (dBuV/m)	LIMIT (dBuV/m)	MARGIN (dB)	ANTENNA HEIGHT (m)	TABLE ANGLE (Degree)	RAW VALUE (dBuV)	CORRECTION FACTOR (dB/m)
1	115.53	29.97 QP	43.50	-13.53	3.00 H	337	19.57	10.40
2	162.18	28.71 QP	43.50	-14.79	3.00 H	139	15.44	13.27
3	300.20	31.88 QP	46.00	-14.12	3.00 H	283	16.26	15.62
4	331.30	40.19 QP	46.00	-5.81	1.00 H	259	24.16	16.03
5	376.01	31.25 QP	46.00	-14.75	2.00 H	346	14.10	17.14
6	399.34	29.60 QP	46.00	-16.40	3.00 H	283	11.68	17.92
7	465.43	32.05 QP	46.00	-13.95	3.00 H	283	12.76	19.30
8	881.42	30.14 QP	46.00	-15.86	1.00 H	259	3.21	26.93

ANTENNA POLARITY & TEST DISTANCE: VERTICAL AT 3 M

NO.	FREQ. (MHz)	EMISSION LEVEL (dBuV/m)	LIMIT (dBuV/m)	MARGIN (dB)	ANTENNA HEIGHT (m)	TABLE ANGLE (Degree)	RAW VALUE (dBuV)	CORRECTION FACTOR (dB/m)
1	61.10	26.34 QP	40.00	-13.66	1.00 V	52	12.99	13.35
2	113.59	28.26 QP	43.50	-15.24	1.50 V	256	18.03	10.23
3	158.30	29.01 QP	43.50	-14.49	1.00 V	91	15.60	13.41
4	166.07	32.59 QP	43.50	-10.91	1.00 V	109	19.56	13.03
5	333.25	31.91 QP	46.00	-14.09	1.00 V	253	15.85	16.06
6	467.37	29.08 QP	46.00	-16.92	1.00 V	130	9.74	19.34
7	665.65	30.34 QP	46.00	-15.66	1.00 V	130	6.96	23.38
8	702.59	34.94 QP	46.00	-11.06	1.00 V	127	10.72	24.22

REMARKS: 1. Emission level (dBuV/m) = Raw Value (dBuV) + Correction Factor (dB/m).

2. Correction Factor (dB/m) = Antenna Factor (dB/m) + Cable Factor (dB).

3. The other emission levels were very low against the limit.

4. Margin value = Emission level – Limit value.

DRAFT 802.11n (20MHz) OFDM MODULATION: DUAL TX:

EUT TEST CONDITION		MEASUREMENT DETAIL	
CHANNEL	Channel 1	FREQUENCY RANGE	Below 1000MHz
MODULATION TYPE	BPSK for draft 802.11n (20MHz)	INPUT POWER (SYSTEM)	120Vac, 60 Hz
TRANSFER RATE	14.444Mbps	DETECTOR FUNCTION	Quasi-Peak
ENVIRONMENTAL CONDITIONS	25deg. C, 65%RH, 991hPa	TESTED BY	Lori Chui

ANTENNA POLARITY & TEST DISTANCE: HORIZONTAL AT 3 M

NO.	FREQ. (MHz)	EMISSION LEVEL (dBuV/m)	LIMIT (dBuV/m)	MARGIN (dB)	ANTENNA HEIGHT (m)	TABLE ANGLE (Degree)	RAW VALUE (dBuV)	CORRECTION FACTOR (dB/m)
1	115.53	30.29 QP	43.50	-13.21	2.00 H	40	19.88	10.40
2	162.18	28.31 QP	43.50	-15.19	3.00 H	172	15.04	13.27
3	298.26	31.79 QP	46.00	-14.21	1.00 H	43	16.26	15.53
4	333.25	40.32 QP	46.00	-5.68	1.50 H	157	24.26	16.06
5	383.79	31.89 QP	46.00	-14.11	1.50 H	76	14.49	17.40
6	465.43	31.35 QP	46.00	-14.65	1.50 H	157	12.06	19.30
7	700.64	30.65 QP	46.00	-15.35	1.50 H	76	6.50	24.16
8	799.78	29.03 QP	46.00	-16.97	2.50 H	40	3.04	26.00
9	881.42	29.74 QP	46.00	-16.26	1.00 H	43	2.81	26.93
10	935.85	29.15 QP	46.00	-16.85	2.00 H	295	0.39	28.76

ANTENNA POLARITY & TEST DISTANCE: VERTICAL AT 3 M

NO.	FREQ. (MHz)	EMISSION LEVEL (dBuV/m)	LIMIT (dBuV/m)	MARGIN (dB)	ANTENNA HEIGHT (m)	TABLE ANGLE (Degree)	RAW VALUE (dBuV)	CORRECTION FACTOR (dB/m)
1	63.05	26.70 QP	40.00	-13.30	1.00 V	268	13.69	13.01
2	115.53	28.73 QP	43.50	-14.77	1.50 V	262	18.33	10.40
3	156.35	30.18 QP	43.50	-13.32	1.00 V	100	16.76	13.41
4	166.07	33.06 QP	43.50	-10.44	1.00 V	94	20.03	13.03
5	199.12	26.39 QP	43.50	-17.11	1.00 V	94	15.50	10.89
6	333.25	32.49 QP	46.00	-13.51	1.00 V	118	16.43	16.06
7	467.37	28.60 QP	46.00	-17.40	1.00 V	136	9.26	19.34
8	881.42	28.14 QP	46.00	-17.86	1.00 V	94	1.21	26.93

- REMARKS:**
1. Emission level (dBuV/m) = Raw Value (dBuV) + Correction Factor (dB/m).
 2. Correction Factor (dB/m) = Antenna Factor (dB/m) + Cable Factor (dB).
 3. The other emission levels were very low against the limit.
 4. Margin value = Emission level – Limit value.

DRAFT 802.11n (40MHz) OFDM MODULATION: SINGLE TX:

EUT TEST CONDITION		MEASUREMENT DETAIL	
CHANNEL	Channel 1	FREQUENCY RANGE	Below 1000MHz
MODULATION TYPE	BPSK for draft 802.11n (40MHz)	INPUT POWER (SYSTEM)	120Vac, 60 Hz
TRANSFER RATE	15Mbps	DETECTOR FUNCTION	Quasi-Peak
ENVIRONMENTAL CONDITIONS	25deg. C, 65%RH, 991hPa	TESTED BY	Lori Chui

ANTENNA POLARITY & TEST DISTANCE: HORIZONTAL AT 3 M

NO.	FREQ. (MHz)	EMISSION LEVEL (dBuV/m)	LIMIT (dBuV/m)	MARGIN (dB)	ANTENNA HEIGHT (m)	TABLE ANGLE (Degree)	RAW VALUE (dBuV)	CORRECTION FACTOR (dB/m)
1	119.42	29.49 QP	43.50	-14.01	1.50 H	31	18.73	10.76
2	162.18	28.61 QP	43.50	-14.89	2.50 H	67	15.34	13.27
3	298.26	31.70 QP	46.00	-14.30	1.00 H	58	16.17	15.53
4	333.25	40.75 QP	46.00	-5.25	1.00 H	301	24.69	16.06
5	364.35	30.45 QP	46.00	-15.55	1.00 H	58	13.69	16.76
6	465.43	32.28 QP	46.00	-13.72	1.00 H	301	12.99	19.30
7	665.65	28.10 QP	46.00	-17.90	2.00 H	85	4.73	23.38
8	799.78	28.82 QP	46.00	-17.18	2.00 H	343	2.82	26.00
9	881.42	30.26 QP	46.00	-15.74	1.00 H	58	3.33	26.93
10	933.91	28.71 QP	46.00	-17.29	2.00 H	349	0.04	28.66

ANTENNA POLARITY & TEST DISTANCE: VERTICAL AT 3 M

NO.	FREQ. (MHz)	EMISSION LEVEL (dBuV/m)	LIMIT (dBuV/m)	MARGIN (dB)	ANTENNA HEIGHT (m)	TABLE ANGLE (Degree)	RAW VALUE (dBuV)	CORRECTION FACTOR (dB/m)
1	57.21	26.30 QP	40.00	-13.70	1.00 V	121	12.53	13.77
2	117.47	28.59 QP	43.50	-14.91	1.00 V	127	18.01	10.58
3	166.07	32.45 QP	43.50	-11.05	1.00 V	97	19.42	13.03
4	199.12	26.22 QP	43.50	-17.28	1.00 V	97	15.32	10.89
5	333.25	33.93 QP	46.00	-12.07	1.00 V	85	17.87	16.06
6	393.51	28.34 QP	46.00	-17.66	1.00 V	235	10.62	17.72
7	467.37	28.44 QP	46.00	-17.56	1.00 V	190	9.10	19.34
8	665.65	30.29 QP	46.00	-15.71	1.00 V	190	6.91	23.38
9	881.42	28.33 QP	46.00	-17.67	1.00 V	97	1.40	26.93

- REMARKS:**
1. Emission level (dBuV/m) = Raw Value (dBuV) + Correction Factor (dB/m).
 2. Correction Factor (dB/m) = Antenna Factor (dB/m) + Cable Factor (dB).
 3. The other emission levels were very low against the limit.
 4. Margin value = Emission level – Limit value.

DRAFT 802.11n (40MHz) OFDM MODULATION: DUAL TX:

EUT TEST CONDITION		MEASUREMENT DETAIL	
CHANNEL	Channel 1	FREQUENCY RANGE	Below 1000MHz
MODULATION TYPE	BPSK for draft 802.11n (40MHz)	INPUT POWER (SYSTEM)	120Vac, 60 Hz
TRANSFER RATE	30Mbps	DETECTOR FUNCTION	Quasi-Peak
ENVIRONMENTAL CONDITIONS	25deg. C, 65%RH, 991hPa	TESTED BY	Lori Chui

ANTENNA POLARITY & TEST DISTANCE: HORIZONTAL AT 3 M

NO.	FREQ. (MHz)	EMISSION LEVEL (dBuV/m)	LIMIT (dBuV/m)	MARGIN (dB)	ANTENNA HEIGHT (m)	TABLE ANGLE (Degree)	RAW VALUE (dBuV)	CORRECTION FACTOR (dB/m)
1	117.47	29.84 QP	43.50	-13.66	2.00 H	331	19.26	10.58
2	162.18	28.66 QP	43.50	-14.84	1.50 H	328	15.39	13.27
3	300.20	31.79 QP	46.00	-14.21	1.00 H	103	16.17	15.62
4	333.25	40.37 QP	46.00	-5.63	1.00 H	103	24.31	16.06
5	370.18	30.38 QP	46.00	-15.62	1.00 H	55	13.43	16.95
6	401.28	28.03 QP	46.00	-17.97	1.00 H	52	10.06	17.96
7	465.43	31.09 QP	46.00	-14.91	1.00 H	103	11.80	19.30
8	665.65	30.50 QP	46.00	-15.50	1.00 H	52	7.13	23.38
9	720.08	28.11 QP	46.00	-17.89	2.00 H	40	3.32	24.80
10	799.78	28.83 QP	46.00	-17.17	1.00 H	301	2.83	26.00
11	881.42	29.31 QP	46.00	-16.69	1.00 H	340	2.38	26.93

ANTENNA POLARITY & TEST DISTANCE: VERTICAL AT 3 M

NO.	FREQ. (MHz)	EMISSION LEVEL (dBuV/m)	LIMIT (dBuV/m)	MARGIN (dB)	ANTENNA HEIGHT (m)	TABLE ANGLE (Degree)	RAW VALUE (dBuV)	CORRECTION FACTOR (dB/m)
1	59.16	26.70 QP	40.00	-13.30	1.00 V	46	13.09	13.61
2	117.47	28.11 QP	43.50	-15.39	1.00 V	172	17.53	10.58
3	166.07	33.20 QP	43.50	-10.30	1.00 V	124	20.17	13.03
4	199.12	27.16 QP	43.50	-16.34	1.00 V	124	16.27	10.89
5	331.30	33.71 QP	46.00	-12.29	1.00 V	124	17.68	16.03
6	465.43	28.70 QP	46.00	-17.30	1.00 V	190	9.41	19.30
7	640.38	28.19 QP	46.00	-17.81	2.00 V	286	5.27	22.92
8	879.48	28.72 QP	46.00	-17.28	1.00 V	103	1.80	26.91
9	933.91	28.08 QP	46.00	-17.92	1.00 V	142	-0.58	28.66

- REMARKS:**
1. Emission level (dBuV/m) = Raw Value (dBuV) + Correction Factor (dB/m).
 2. Correction Factor (dB/m) = Antenna Factor (dB/m) + Cable Factor (dB).
 3. The other emission levels were very low against the limit.
 4. Margin value = Emission level – Limit value.

802.11b DSSS MODULATION:

EUT TEST CONDITION		MEASUREMENT DETAIL	
CHANNEL	Channel 1	FREQUENCY RANGE	1 ~ 25GHz
MODULATION TYPE	DBPSK	INPUT POWER (SYSTEM)	120Vac, 60 Hz
TRANSFER RATE	1Mbps	DETECTOR FUNCTION	Peak(PK) Average (AV)
ENVIRONMENTAL CONDITIONS	25deg. C, 65%RH, 991hPa	TESTED BY	Lori Chui

ANTENNA POLARITY & TEST DISTANCE: HORIZONTAL AT 3 M								
NO.	FREQ. (MHz)	EMISSION LEVEL (dBuV/m)	LIMIT (dBuV/m)	MARGIN (dB)	ANTENNA HEIGHT (m)	TABLE ANGLE (Degree)	RAW VALUE (dBuV)	CORRECTION FACTOR (dB/m)
1	2320.00	57.38 PK	74.00	-16.62	1.44 H	197	26.23	31.15
2	2320.00	47.49 AV	54.00	-6.51	1.44 H	197	16.34	31.15
3	2386.00	58.39 PK	74.00	-15.61	1.13 H	195	27.02	31.37
4	2386.00	48.58 AV	54.00	-5.42	1.13 H	195	17.21	31.37
5	*2412.00	108.39 PK			1.11 H	193	76.93	31.46
6	*2412.00	104.58 AV			1.11 H	193	73.12	31.46
7	4824.00	53.36 PK	74.00	-20.64	1.48 H	172	16.23	37.13
8	4824.00	49.20 AV	54.00	-4.80	1.48 H	172	12.07	37.13

ANTENNA POLARITY & TEST DISTANCE: VERTICAL AT 3 M								
NO.	FREQ. (MHz)	EMISSION LEVEL (dBuV/m)	LIMIT (dBuV/m)	MARGIN (dB)	ANTENNA HEIGHT (m)	TABLE ANGLE (Degree)	RAW VALUE (dBuV)	CORRECTION FACTOR (dB/m)
1	2390.00	55.22 PK	74.00	-18.78	1.57 V	194	23.83	31.39
2	2390.00	43.79 AV	54.00	-10.21	1.57 V	194	12.40	31.39
3	*2412.00	100.84 PK			1.32 V	198	69.38	31.46
4	*2412.00	97.19 AV			1.32 V	198	65.73	31.46
5	4824.00	54.84 PK	74.00	-19.16	1.00 V	115	17.71	37.13
6	4824.00	52.13 AV	54.00	-1.87	1.00 V	115	15.00	37.13

- REMARKS:**
1. Emission level (dBuV/m) = Raw Value (dBuV) + Correction Factor (dB/m).
 2. Correction Factor (dB/m) = Antenna Factor (dB/m) + Cable Factor (dB).
 3. The other emission levels were very low against the limit.
 4. Margin value = Emission level – Limit value.
 5. The limit value is defined as per 15.247.
 6. “ * “: Fundamental frequency.

EUT TEST CONDITION		MEASUREMENT DETAIL	
CHANNEL	Channel 6	FREQUENCY RANGE	1 ~ 25GHz
MODULATION TYPE	DBPSK	INPUT POWER (SYSTEM)	120Vac, 60 Hz
TRANSFER RATE	1Mbps	DETECTOR FUNCTION	Peak(PK) Average (AV)
ENVIRONMENTAL CONDITIONS	25deg. C, 65%RH, 991hPa	TESTED BY	Lori Chui

ANTENNA POLARITY & TEST DISTANCE: HORIZONTAL AT 3 M								
NO.	FREQ. (MHz)	EMISSION LEVEL (dBuV/m)	LIMIT (dBuV/m)	MARGIN (dB)	ANTENNA HEIGHT (m)	TABLE ANGLE (Degree)	RAW VALUE (dBuV)	CORRECTION FACTOR (dB/m)
1	2320.00	56.83 PK	74.00	-17.17	1.43 H	192	25.68	31.15
2	2320.00	47.11 AV	54.00	-6.89	1.43 H	192	15.96	31.15
3	*2437.00	110.23 PK			1.11 H	188	78.69	31.54
4	*2437.00	106.52 AV			1.11 H	188	74.98	31.54
5	4874.00	54.24 PK	74.00	-19.76	1.50 H	225	16.95	37.29
6	4874.00	51.16 AV	54.00	-2.84	1.50 H	225	13.87	37.29

ANTENNA POLARITY & TEST DISTANCE: VERTICAL AT 3 M								
NO.	FREQ. (MHz)	EMISSION LEVEL (dBuV/m)	LIMIT (dBuV/m)	MARGIN (dB)	ANTENNA HEIGHT (m)	TABLE ANGLE (Degree)	RAW VALUE (dBuV)	CORRECTION FACTOR (dB/m)
1	*2437.00	102.71 PK			1.00 V	120	71.17	31.54
2	*2437.00	98.96 AV			1.00 V	120	67.42	31.54
3	4874.00	55.15 PK	74.00	-18.85	1.26 V	272	17.86	37.29
4	4874.00	52.54 AV	54.00	-1.46	1.26 V	272	15.25	37.29

- REMARKS:**
1. Emission level (dBuV/m) = Raw Value (dBuV) + Correction Factor (dB/m).
 2. Correction Factor (dB/m) = Antenna Factor (dB/m) + Cable Factor (dB).
 3. The other emission levels were very low against the limit.
 4. Margin value = Emission level – Limit value.
 5. The limit value is defined as per 15.247.
 6. “ * “: Fundamental frequency.

EUT TEST CONDITION		MEASUREMENT DETAIL	
CHANNEL	Channel 11	FREQUENCY RANGE	1 ~ 25GHz
MODULATION TYPE	DBPSK	INPUT POWER (SYSTEM)	120Vac, 60 Hz
TRANSFER RATE	1Mbps	DETECTOR FUNCTION	Peak(PK) Average (AV)
ENVIRONMENTAL CONDITIONS	25deg. C, 65%RH, 991hPa	TESTED BY	Lori Chui

ANTENNA POLARITY & TEST DISTANCE: HORIZONTAL AT 3 M								
NO.	FREQ. (MHz)	EMISSION LEVEL (dBuV/m)	LIMIT (dBuV/m)	MARGIN (dB)	ANTENNA HEIGHT (m)	TABLE ANGLE (Degree)	RAW VALUE (dBuV)	CORRECTION FACTOR (dB/m)
1	*2462.00	110.61 PK			1.08 H	204	78.99	31.62
2	*2462.00	106.90 AV			1.08 H	204	75.28	31.62
3	2488.00	59.77 PK	74.00	-14.23	1.07 H	202	28.06	31.71
4	2488.00	48.39 AV	54.00	-5.61	1.07 H	202	16.68	31.71
5	4924.00	54.59 PK	74.00	-19.41	1.03 H	209	17.15	37.44
6	4924.00	51.92 AV	54.00	-2.08	1.03 H	209	14.48	37.44

ANTENNA POLARITY & TEST DISTANCE: VERTICAL AT 3 M								
NO.	FREQ. (MHz)	EMISSION LEVEL (dBuV/m)	LIMIT (dBuV/m)	MARGIN (dB)	ANTENNA HEIGHT (m)	TABLE ANGLE (Degree)	RAW VALUE (dBuV)	CORRECTION FACTOR (dB/m)
1	*2462.00	103.24 PK			1.28 V	195	71.62	31.62
2	*2462.00	98.63 AV			1.28 V	195	67.01	31.62
3	2488.00	57.14 PK	74.00	-16.86	1.53 V	198	25.43	31.71
4	2488.00	46.29 AV	54.00	-7.71	1.53 V	198	14.58	31.71
5	4924.00	55.13 PK	74.00	-18.87	1.17 V	156	17.69	37.44
6	4924.00	52.18 AV	54.00	-1.82	1.17 V	156	14.74	37.44

- REMARKS:**
1. Emission level (dBuV/m) = Raw Value (dBuV) + Correction Factor (dB/m).
 2. Correction Factor (dB/m) = Antenna Factor (dB/m) + Cable Factor (dB).
 3. The other emission levels were very low against the limit.
 4. Margin value = Emission level – Limit value.
 5. The limit value is defined as per 15.247.
 6. “ * “: Fundamental frequency.

802.11g OFDM MODULATION:

EUT TEST CONDITION		MEASUREMENT DETAIL	
CHANNEL	Channel 1	FREQUENCY RANGE	1 ~ 25GHz
MODULATION TYPE	BPSK	INPUT POWER (SYSTEM)	120Vac, 60 Hz
TRANSFER RATE	6Mbps	DETECTOR FUNCTION	Peak(PK) Average (AV)
ENVIRONMENTAL CONDITIONS	25deg. C, 65%RH, 991hPa	TESTED BY	Lori Chui

ANTENNA POLARITY & TEST DISTANCE: HORIZONTAL AT 3 M								
NO.	FREQ. (MHz)	EMISSION LEVEL (dBuV/m)	LIMIT (dBuV/m)	MARGIN (dB)	ANTENNA HEIGHT (m)	TABLE ANGLE (Degree)	RAW VALUE (dBuV)	CORRECTION FACTOR (dB/m)
1	2390.00	66.38 PK	74.00	-7.62	1.14 H	197	34.99	31.39
2	2390.00	52.30 AV	54.00	-1.70	1.14 H	197	20.91	31.39
3	*2412.00	107.30 PK			1.14 H	200	75.84	31.46
4	*2412.00	99.92 AV			1.14 H	200	68.46	31.46
5	4824.00	49.17 PK	74.00	-24.83	1.38 H	191	12.04	37.13
6	4824.00	37.04 AV	54.00	-16.96	1.38 H	191	-0.09	37.13

ANTENNA POLARITY & TEST DISTANCE: VERTICAL AT 3 M								
NO.	FREQ. (MHz)	EMISSION LEVEL (dBuV/m)	LIMIT (dBuV/m)	MARGIN (dB)	ANTENNA HEIGHT (m)	TABLE ANGLE (Degree)	RAW VALUE (dBuV)	CORRECTION FACTOR (dB/m)
1	2390.00	59.18 PK	74.00	-14.82	1.71 V	134	27.79	31.39
2	2390.00	46.22 AV	54.00	-7.78	1.71 V	134	14.83	31.39
3	*2412.00	99.05 PK			1.67 V	126	67.59	31.46
4	*2412.00	91.52 AV			1.67 V	126	60.06	31.46
5	4824.00	51.03 PK	74.00	-22.97	1.27 V	288	13.90	37.13
6	4824.00	40.48 AV	54.00	-13.52	1.27 V	288	3.35	37.13

- REMARKS:**
1. Emission level (dBuV/m) = Raw Value (dBuV) + Correction Factor (dB/m).
 2. Correction Factor (dB/m) = Antenna Factor (dB/m) + Cable Factor (dB).
 3. The other emission levels were very low against the limit.
 4. Margin value = Emission level – Limit value.
 5. The limit value is defined as per 15.247.
 6. “ * “: Fundamental frequency.

EUT TEST CONDITION		MEASUREMENT DETAIL	
CHANNEL	Channel 6	FREQUENCY RANGE	1 ~ 25GHz
MODULATION TYPE	BPSK	INPUT POWER (SYSTEM)	120Vac, 60 Hz
TRANSFER RATE	6Mbps	DETECTOR FUNCTION	Peak(PK) Average (AV)
ENVIRONMENTAL CONDITIONS	25deg. C, 65%RH, 991hPa	TESTED BY	Lori Chui

ANTENNA POLARITY & TEST DISTANCE: HORIZONTAL AT 3 M								
NO.	FREQ. (MHz)	EMISSION LEVEL (dBuV/m)	LIMIT (dBuV/m)	MARGIN (dB)	ANTENNA HEIGHT (m)	TABLE ANGLE (Degree)	RAW VALUE (dBuV)	CORRECTION FACTOR (dB/m)
1	*2437.00	107.22 PK			1.10 H	195	75.68	31.54
2	*2437.00	99.93 AV			1.10 H	195	68.39	31.54
3	4874.00	49.18 PK	74.00	-24.82	1.06 H	320	11.89	37.29
4	4874.00	37.12 AV	54.00	-16.88	1.06 H	320	-0.17	37.29

ANTENNA POLARITY & TEST DISTANCE: VERTICAL AT 3 M								
NO.	FREQ. (MHz)	EMISSION LEVEL (dBuV/m)	LIMIT (dBuV/m)	MARGIN (dB)	ANTENNA HEIGHT (m)	TABLE ANGLE (Degree)	RAW VALUE (dBuV)	CORRECTION FACTOR (dB/m)
1	*2437.00	98.96 PK			1.00 V	123	67.42	31.54
2	*2437.00	91.23 AV			1.00 V	123	59.69	31.54
3	4874.00	51.13 PK	74.00	-22.87	1.29 V	302	13.84	37.29
4	4874.00	40.51 AV	54.00	-13.49	1.29 V	302	3.22	37.29

- REMARKS:**
1. Emission level (dBuV/m) = Raw Value (dBuV) + Correction Factor (dB/m).
 2. Correction Factor (dB/m) = Antenna Factor (dB/m) + Cable Factor (dB).
 3. The other emission levels were very low against the limit.
 4. Margin value = Emission level – Limit value.
 5. The limit value is defined as per 15.247.
 6. “ * “: Fundamental frequency.

EUT TEST CONDITION		MEASUREMENT DETAIL	
CHANNEL	Channel 11	FREQUENCY RANGE	1 ~ 25GHz
MODULATION TYPE	BPSK	INPUT POWER (SYSTEM)	120Vac, 60 Hz
TRANSFER RATE	6Mbps	DETECTOR FUNCTION	Peak(PK) Average (AV)
ENVIRONMENTAL CONDITIONS	25deg. C, 65%RH, 991hPa	TESTED BY	Lori Chui

ANTENNA POLARITY & TEST DISTANCE: HORIZONTAL AT 3 M								
NO.	FREQ. (MHz)	EMISSION LEVEL (dBuV/m)	LIMIT (dBuV/m)	MARGIN (dB)	ANTENNA HEIGHT (m)	TABLE ANGLE (Degree)	RAW VALUE (dBuV)	CORRECTION FACTOR (dB/m)
1	*2462.00	105.87 PK			1.09 H	197	74.25	31.62
2	*2462.00	97.65 AV			1.09 H	197	66.03	31.62
3	2484.00	63.88 PK	74.00	-10.12	1.38 H	202	32.18	31.70
4	2484.00	52.58 AV	54.00	-1.42	1.38 H	202	20.88	31.70
5	4924.00	47.41 PK	74.00	-26.59	1.47 H	312	9.97	37.44
6	4924.00	35.08 AV	54.00	-18.92	1.47 H	312	-2.36	37.44

ANTENNA POLARITY & TEST DISTANCE: VERTICAL AT 3 M								
NO.	FREQ. (MHz)	EMISSION LEVEL (dBuV/m)	LIMIT (dBuV/m)	MARGIN (dB)	ANTENNA HEIGHT (m)	TABLE ANGLE (Degree)	RAW VALUE (dBuV)	CORRECTION FACTOR (dB/m)
1	*2462.00	97.85 PK			1.10 V	32	66.23	31.62
2	*2462.00	90.14 AV			1.10 V	32	58.52	31.62
3	2484.00	61.53 PK	74.00	-12.47	1.09 V	30	29.83	31.70
4	2484.00	50.46 AV	54.00	-3.54	1.09 V	30	18.76	31.70
5	4924.00	53.79 PK	74.00	-20.21	1.08 V	291	16.35	37.44
6	4924.00	43.97 AV	54.00	-10.03	1.08 V	291	6.53	37.44

- REMARKS:**
1. Emission level (dBuV/m) = Raw Value (dBuV) + Correction Factor (dB/m).
 2. Correction Factor (dB/m) = Antenna Factor (dB/m) + Cable Factor (dB).
 3. The other emission levels were very low against the limit.
 4. Margin value = Emission level – Limit value.
 5. The limit value is defined as per 15.247.
 6. “ * “: Fundamental frequency.

DRAFT 802.11n (20MHz) OFDM MODULATION: SINGLE TX:

EUT TEST CONDITION		MEASUREMENT DETAIL	
CHANNEL	Channel 1	FREQUENCY RANGE	1 ~ 25GHz
MODULATION TYPE	BPSK	INPUT POWER (SYSTEM)	120Vac, 60 Hz
TRANSFER RATE	7.2Mbps	DETECTOR FUNCTION	Peak(PK) Average (AV)
ENVIRONMENTAL CONDITIONS	25deg. C, 65%RH, 991hPa	TESTED BY	Lori Chui

ANTENNA POLARITY & TEST DISTANCE: HORIZONTAL AT 3 M

NO.	FREQ. (MHz)	EMISSION LEVEL (dBuV/m)	LIMIT (dBuV/m)	MARGIN (dB)	ANTENNA HEIGHT (m)	TABLE ANGLE (Degree)	RAW VALUE (dBuV)	CORRECTION FACTOR (dB/m)
1	2367.00	58.85 PK	74.00	-15.15	1.10 H	11	27.54	31.31
2	2367.00	47.68 AV	54.00	-6.32	1.10 H	11	16.37	31.31
3	2390.00	67.85 PK	74.00	-6.15	1.09 H	12	36.46	31.39
4	2390.00	52.31 AV	54.00	-1.69	1.09 H	12	20.92	31.39
5	*2412.00	108.82 PK			1.10 H	11	77.36	31.46
6	*2412.00	99.35 AV			1.10 H	11	67.89	31.46
7	2487.00	60.54 PK	74.00	-13.46	1.06 H	15	28.83	31.71
8	2487.00	50.48 AV	54.00	-3.52	1.06 H	15	18.77	31.71
9	4824.00	50.43 PK	74.00	-23.57	1.46 H	151	13.30	37.13
10	4824.00	36.68 AV	54.00	-17.32	1.46 H	151	-0.45	37.13

ANTENNA POLARITY & TEST DISTANCE: VERTICAL AT 3 M

NO.	FREQ. (MHz)	EMISSION LEVEL (dBuV/m)	LIMIT (dBuV/m)	MARGIN (dB)	ANTENNA HEIGHT (m)	TABLE ANGLE (Degree)	RAW VALUE (dBuV)	CORRECTION FACTOR (dB/m)
1	2390.00	58.07 PK	74.00	-15.93	1.29 V	342	26.68	31.39
2	2390.00	45.36 AV	54.00	-8.64	1.29 V	342	13.97	31.39
3	*2412.00	100.62 PK			1.30 V	14	69.16	31.46
4	*2412.00	90.30 AV			1.30 V	14	58.84	31.46
5	4824.00	49.22 PK	74.00	-24.78	1.39 V	94	12.09	37.13
6	4824.00	35.73 AV	54.00	-18.27	1.39 V	94	-1.40	37.13

- REMARKS:**
1. Emission level (dBuV/m) = Raw Value (dBuV) + Correction Factor (dB/m).
 2. Correction Factor (dB/m) = Antenna Factor (dB/m) + Cable Factor (dB).
 3. The other emission levels were very low against the limit.
 4. Margin value = Emission level – Limit value.
 5. The limit value is defined as per 15.247.
 6. “ * “: Fundamental frequency.

EUT TEST CONDITION		MEASUREMENT DETAIL	
CHANNEL	Channel 6	FREQUENCY RANGE	1 ~ 25GHz
MODULATION TYPE	BPSK	INPUT POWER (SYSTEM)	120Vac, 60 Hz
TRANSFER RATE	7.2Mbps	DETECTOR FUNCTION	Peak(PK) Average (AV)
ENVIRONMENTAL CONDITIONS	25deg. C, 65%RH, 991hPa	TESTED BY	Lori Chui

ANTENNA POLARITY & TEST DISTANCE: HORIZONTAL AT 3 M								
NO.	FREQ. (MHz)	EMISSION LEVEL (dBuV/m)	LIMIT (dBuV/m)	MARGIN (dB)	ANTENNA HEIGHT (m)	TABLE ANGLE (Degree)	RAW VALUE (dBuV)	CORRECTION FACTOR (dB/m)
1	2382.00	58.09 PK	74.00	-15.91	1.13 H	357	26.73	31.36
2	2382.00	46.97 AV	54.00	-7.03	1.13 H	357	15.61	31.36
3	*2437.00	108.76 PK			1.09 H	14	77.22	31.54
4	*2437.00	99.12 AV			1.09 H	14	67.58	31.54
5	4874.00	50.38 PK	74.00	-23.62	1.22 H	234	13.09	37.29
6	4874.00	36.59 AV	54.00	-17.41	1.22 H	234	-0.70	37.29

ANTENNA POLARITY & TEST DISTANCE: VERTICAL AT 3 M								
NO.	FREQ. (MHz)	EMISSION LEVEL (dBuV/m)	LIMIT (dBuV/m)	MARGIN (dB)	ANTENNA HEIGHT (m)	TABLE ANGLE (Degree)	RAW VALUE (dBuV)	CORRECTION FACTOR (dB/m)
1	*2437.00	100.55 PK			1.07 V	257	69.01	31.54
2	*2437.00	91.13 AV			1.07 V	257	59.59	31.54
3	4874.00	49.18 PK	74.00	-24.82	1.62 V	311	11.89	37.29
4	4874.00	35.61 AV	54.00	-18.39	1.62 V	311	-1.68	37.29

- REMARKS:**
1. Emission level (dBuV/m) = Raw Value (dBuV) + Correction Factor (dB/m).
 2. Correction Factor (dB/m) = Antenna Factor (dB/m) + Cable Factor (dB).
 3. The other emission levels were very low against the limit.
 4. Margin value = Emission level – Limit value.
 5. The limit value is defined as per 15.247.
 6. “ * “: Fundamental frequency.

EUT TEST CONDITION		MEASUREMENT DETAIL	
CHANNEL	Channel 11	FREQUENCY RANGE	1 ~ 25GHz
MODULATION TYPE	BPSK	INPUT POWER (SYSTEM)	120Vac, 60 Hz
TRANSFER RATE	7.2Mbps	DETECTOR FUNCTION	Peak(PK) Average (AV)
ENVIRONMENTAL CONDITIONS	25deg. C, 65%RH, 991hPa	TESTED BY	Lori Chui

ANTENNA POLARITY & TEST DISTANCE: HORIZONTAL AT 3 M								
NO.	FREQ. (MHz)	EMISSION LEVEL (dBuV/m)	LIMIT (dBuV/m)	MARGIN (dB)	ANTENNA HEIGHT (m)	TABLE ANGLE (Degree)	RAW VALUE (dBuV)	CORRECTION FACTOR (dB/m)
1	*2462.00	106.31 PK			1.33 H	12	74.69	31.62
2	*2462.00	97.17 AV			1.33 H	12	65.55	31.62
3	2483.50	69.34 PK	74.00	-4.66	1.34 H	13	37.64	31.70
4	2483.50	52.17 AV	54.00	-1.83	1.34 H	13	20.47	31.70
5	4924.00	50.02 PK	74.00	-23.98	1.02 H	345	12.58	37.44
6	4924.00	35.92 AV	54.00	-18.08	1.02 H	345	-1.52	37.44

ANTENNA POLARITY & TEST DISTANCE: VERTICAL AT 3 M								
NO.	FREQ. (MHz)	EMISSION LEVEL (dBuV/m)	LIMIT (dBuV/m)	MARGIN (dB)	ANTENNA HEIGHT (m)	TABLE ANGLE (Degree)	RAW VALUE (dBuV)	CORRECTION FACTOR (dB/m)
1	*2462.00	97.16 PK			1.51 V	13	65.54	31.62
2	*2462.00	88.35 AV			1.51 V	13	56.73	31.62
3	2483.50	60.32 PK	74.00	-13.68	1.49 V	24	28.62	31.70
4	2483.50	46.39 AV	54.00	-7.61	1.49 V	24	14.69	31.70
5	4924.00	49.18 PK	74.00	-24.82	1.24 V	315	11.74	37.44
6	4924.00	34.45 AV	54.00	-19.55	1.24 V	315	-2.99	37.44

- REMARKS:**
1. Emission level (dBuV/m) = Raw Value (dBuV) + Correction Factor (dB/m).
 2. Correction Factor (dB/m) = Antenna Factor (dB/m) + Cable Factor (dB).
 3. The other emission levels were very low against the limit.
 4. Margin value = Emission level – Limit value.
 5. The limit value is defined as per 15.247.
 6. “ * “: Fundamental frequency.

DRAFT 802.11n (20MHz) OFDM MODULATION: DUAL TX:

EUT TEST CONDITION		MEASUREMENT DETAIL	
CHANNEL	Channel 1	FREQUENCY RANGE	1 ~ 25GHz
MODULATION TYPE	BPSK	INPUT POWER (SYSTEM)	120Vac, 60 Hz
TRANSFER RATE	14.444Mbps	DETECTOR FUNCTION	Peak(PK) Average (AV)
ENVIRONMENTAL CONDITIONS	25deg. C, 65%RH, 991hPa	TESTED BY	Lori Chui

ANTENNA POLARITY & TEST DISTANCE: HORIZONTAL AT 3 M

NO.	FREQ. (MHz)	EMISSION LEVEL (dBuV/m)	LIMIT (dBuV/m)	MARGIN (dB)	ANTENNA HEIGHT (m)	TABLE ANGLE (Degree)	RAW VALUE (dBuV)	CORRECTION FACTOR (dB/m)
1	2320.00	58.38 PK	74.00	-15.62	1.13 H	25	27.23	31.15
2	2320.00	48.51 AV	54.00	-5.49	1.13 H	25	17.36	31.15
3	2390.00	66.35 PK	74.00	-7.65	1.10 H	16	34.96	31.39
4	2390.00	52.03 AV	54.00	-1.97	1.10 H	16	20.64	31.39
5	*2412.00	109.86 PK			1.09 H	16	78.40	31.46
6	*2412.00	99.07 AV			1.09 H	16	67.61	31.46
7	2487.00	60.09 PK	74.00	-13.91	1.06 H	20	28.38	31.71
8	2487.00	50.36 AV	54.00	-3.64	1.06 H	20	18.65	31.71

ANTENNA POLARITY & TEST DISTANCE: VERTICAL AT 3 M

NO.	FREQ. (MHz)	EMISSION LEVEL (dBuV/m)	LIMIT (dBuV/m)	MARGIN (dB)	ANTENNA HEIGHT (m)	TABLE ANGLE (Degree)	RAW VALUE (dBuV)	CORRECTION FACTOR (dB/m)
1	2390.00	65.55 PK	74.00	-8.45	1.07 V	258	34.16	31.39
2	2390.00	50.20 AV	54.00	-3.80	1.07 V	258	18.81	31.39
3	*2412.00	107.95 PK			1.04 V	257	76.49	31.46
4	*2412.00	96.78 AV			1.04 V	257	65.32	31.46
5	4824.00	50.28 PK	74.00	-23.72	1.33 V	160	13.15	37.13
6	4824.00	37.73 AV	54.00	-16.27	1.33 V	160	0.60	37.13

- REMARKS:**
1. Emission level (dBuV/m) = Raw Value (dBuV) + Correction Factor (dB/m).
 2. Correction Factor (dB/m) = Antenna Factor (dB/m) + Cable Factor (dB).
 3. The other emission levels were very low against the limit.
 4. Margin value = Emission level – Limit value.
 5. The limit value is defined as per 15.247.
 6. “ * “: Fundamental frequency.

EUT TEST CONDITION		MEASUREMENT DETAIL	
CHANNEL	Channel 6	FREQUENCY RANGE	1 ~ 25GHz
MODULATION TYPE	BPSK	INPUT POWER (SYSTEM)	120Vac, 60 Hz
TRANSFER RATE	14.444Mbps	DETECTOR FUNCTION	Peak(PK) Average (AV)
ENVIRONMENTAL CONDITIONS	25deg. C, 65%RH, 991hPa	TESTED BY	Lori Chui

ANTENNA POLARITY & TEST DISTANCE: HORIZONTAL AT 3 M								
NO.	FREQ. (MHz)	EMISSION LEVEL (dBuV/m)	LIMIT (dBuV/m)	MARGIN (dB)	ANTENNA HEIGHT (m)	TABLE ANGLE (Degree)	RAW VALUE (dBuV)	CORRECTION FACTOR (dB/m)
1	2320.00	59.13 PK	74.00	-14.87	1.13 H	22	27.98	31.15
2	2320.00	48.14 AV	54.00	-5.86	1.13 H	22	16.99	31.15
3	*2437.00	112.12 PK			1.08 H	360	80.58	31.54
4	*2437.00	101.94 AV			1.08 H	360	70.40	31.54
5	2502.00	58.16 PK	92.12	-33.96	1.31 H	28	26.40	31.76
6	2502.00	49.69 AV	81.94	-32.25	1.31 H	28	17.93	31.76
7	4874.00	48.56 PK	74.00	-25.44	1.00 H	36	11.27	37.29
8	4874.00	36.34 AV	54.00	-17.66	1.00 H	36	-0.95	37.29

ANTENNA POLARITY & TEST DISTANCE: VERTICAL AT 3 M								
NO.	FREQ. (MHz)	EMISSION LEVEL (dBuV/m)	LIMIT (dBuV/m)	MARGIN (dB)	ANTENNA HEIGHT (m)	TABLE ANGLE (Degree)	RAW VALUE (dBuV)	CORRECTION FACTOR (dB/m)
1	2382.00	55.88 PK	74.00	-18.12	1.06 V	256	24.52	31.36
2	2382.00	46.69 AV	54.00	-7.31	1.06 V	256	15.33	31.36
3	*2437.00	109.06 PK			1.05 V	257	77.52	31.54
4	*2437.00	97.93 AV			1.05 V	257	66.39	31.54
5	4874.00	50.15 PK	74.00	-23.85	1.10 V	312	12.86	37.29
6	4874.00	37.38 AV	54.00	-16.62	1.10 V	312	0.09	37.29

- REMARKS:**
1. Emission level (dBuV/m) = Raw Value (dBuV) + Correction Factor (dB/m).
 2. Correction Factor (dB/m) = Antenna Factor (dB/m) + Cable Factor (dB).
 3. The other emission levels were very low against the limit.
 4. Margin value = Emission level – Limit value.
 5. The limit value is defined as per 15.247.
 6. " * ": Fundamental frequency.

EUT TEST CONDITION		MEASUREMENT DETAIL	
CHANNEL	Channel 11	FREQUENCY RANGE	1 ~ 25GHz
MODULATION TYPE	BPSK	INPUT POWER (SYSTEM)	120Vac, 60 Hz
TRANSFER RATE	14.444Mbps	DETECTOR FUNCTION	Peak(PK) Average (AV)
ENVIRONMENTAL CONDITIONS	25deg. C, 65%RH, 991hPa	TESTED BY	Lori Chui

ANTENNA POLARITY & TEST DISTANCE: HORIZONTAL AT 3 M								
NO.	FREQ. (MHz)	EMISSION LEVEL (dBuV/m)	LIMIT (dBuV/m)	MARGIN (dB)	ANTENNA HEIGHT (m)	TABLE ANGLE (Degree)	RAW VALUE (dBuV)	CORRECTION FACTOR (dB/m)
1	2320.00	58.63 PK	74.00	-15.37	1.14 H	18	27.48	31.15
2	2320.00	49.41 AV	54.00	-4.59	1.14 H	18	18.26	31.15
3	*2462.00	106.73 PK			1.08 H	12	75.11	31.62
4	*2462.00	96.33 AV			1.08 H	12	64.71	31.62
5	2483.50	65.95 PK	74.00	-8.05	1.07 H	12	34.25	31.70
6	2483.50	52.28 AV	54.00	-1.72	1.07 H	12	20.58	31.70
7	4924.00	48.09 PK	74.00	-25.91	1.00 H	347	10.65	37.44
8	4924.00	35.51 AV	54.00	-18.49	1.00 H	347	-1.93	37.44

ANTENNA POLARITY & TEST DISTANCE: VERTICAL AT 3 M								
NO.	FREQ. (MHz)	EMISSION LEVEL (dBuV/m)	LIMIT (dBuV/m)	MARGIN (dB)	ANTENNA HEIGHT (m)	TABLE ANGLE (Degree)	RAW VALUE (dBuV)	CORRECTION FACTOR (dB/m)
1	*2462.00	103.68 PK			1.24 V	318	72.06	31.62
2	*2462.00	91.62 AV			1.24 V	318	60.00	31.62
3	2483.50	21.43 PK	74.00	-52.57	1.24 V	318	-10.26	31.70
4	2483.50	13.30 AV	54.00	-40.70	1.24 V	318	-18.39	31.70
5	4924.00	50.25 PK	74.00	-23.75	1.19 V	82	12.81	37.44
6	4924.00	38.72 AV	54.00	-15.28	1.19 V	82	1.28	37.44

- REMARKS:**
1. Emission level (dBuV/m) = Raw Value (dBuV) + Correction Factor (dB/m).
 2. Correction Factor (dB/m) = Antenna Factor (dB/m) + Cable Factor (dB).
 3. The other emission levels were very low against the limit.
 4. Margin value = Emission level – Limit value.
 5. The limit value is defined as per 15.247.
 6. “ * “: Fundamental frequency.

DRAFT 802.11n (40MHz) OFDM MODULATION: SINGLE TX:

EUT TEST CONDITION		MEASUREMENT DETAIL	
CHANNEL	Channel 1	FREQUENCY RANGE	1 ~ 25GHz
MODULATION TYPE	BPSK	INPUT POWER (SYSTEM)	120Vac, 60 Hz
TRANSFER RATE	15Mbps	DETECTOR FUNCTION	Peak(PK) Average (AV)
ENVIRONMENTAL CONDITIONS	25deg. C, 65%RH, 991hPa	TESTED BY	Lori Chui

ANTENNA POLARITY & TEST DISTANCE: HORIZONTAL AT 3 M

NO.	FREQ. (MHz)	EMISSION LEVEL (dBuV/m)	LIMIT (dBuV/m)	MARGIN (dB)	ANTENNA HEIGHT (m)	TABLE ANGLE (Degree)	RAW VALUE (dBuV)	CORRECTION FACTOR (dB/m)
1	2280.00	58.26 PK	74.00	-15.74	1.19 H	360	27.25	31.01
2	2280.00	48.07 AV	54.00	-5.93	1.19 H	360	17.06	31.01
3	2373.00	59.65 PK	74.00	-14.35	1.13 H	360	28.32	31.33
4	2373.00	48.13 AV	54.00	-5.87	1.13 H	360	16.80	31.33
5	2390.00	63.48 PK	74.00	-10.52	1.08 H	10	32.09	31.39
6	2390.00	52.46 AV	54.00	-1.54	1.08 H	10	21.07	31.39
7	*2422.00	104.25 PK			1.09 H	13	72.76	31.49
8	*2422.00	94.97 AV			1.09 H	13	63.48	31.49
9	2493.00	60.76 PK	74.00	-13.24	1.32 H	15	29.03	31.73
10	2493.00	49.50 AV	54.00	-4.50	1.32 H	15	17.77	31.73
11	4844.00	45.33 PK	74.00	-28.67	1.00 H	14	8.14	37.19
12	4844.00	34.35 AV	54.00	-19.65	1.00 H	14	-2.84	37.19

ANTENNA POLARITY & TEST DISTANCE: VERTICAL AT 3 M

NO.	FREQ. (MHz)	EMISSION LEVEL (dBuV/m)	LIMIT (dBuV/m)	MARGIN (dB)	ANTENNA HEIGHT (m)	TABLE ANGLE (Degree)	RAW VALUE (dBuV)	CORRECTION FACTOR (dB/m)
1	2390.00	59.35 PK	74.00	-14.65	1.06 V	252	27.96	31.39
1	2390.00	47.57 AV	54.00	-6.43	1.06 V	252	16.18	31.39
2	*2422.00	98.64 PK			1.06 V	252	67.15	31.49
2	*2422.00	89.25 AV			1.06 V	252	57.76	31.49
3	2493.00	56.03 PK	74.00	-17.97	1.27 V	360	24.30	31.73
3	2493.00	46.77 AV	54.00	-7.23	1.27 V	360	15.04	31.73
4	4844.00	47.22 PK	74.00	-26.78	1.00 V	249	10.03	37.19
4	4844.00	35.73 AV	54.00	-18.27	1.00 V	249	-1.46	37.19

- REMARKS:**
1. Emission level (dBuV/m) = Raw Value (dBuV) + Correction Factor (dB/m).
 2. Correction Factor (dB/m) = Antenna Factor (dB/m) + Cable Factor (dB).
 3. The other emission levels were very low against the limit.
 4. Margin value = Emission level – Limit value.
 5. The limit value is defined as per 15.247.
 6. “ * “: Fundamental frequency.

EUT TEST CONDITION		MEASUREMENT DETAIL	
CHANNEL	Channel 4	FREQUENCY RANGE	1 ~ 25GHz
MODULATION TYPE	BPSK	INPUT POWER (SYSTEM)	120Vac, 60 Hz
TRANSFER RATE	15Mbps	DETECTOR FUNCTION	Peak(PK) Average (AV)
ENVIRONMENTAL CONDITIONS	25deg. C, 65%RH, 991hPa	TESTED BY	Lori Chui

ANTENNA POLARITY & TEST DISTANCE: HORIZONTAL AT 3 M								
NO.	FREQ. (MHz)	EMISSION LEVEL (dBuV/m)	LIMIT (dBuV/m)	MARGIN (dB)	ANTENNA HEIGHT (m)	TABLE ANGLE (Degree)	RAW VALUE (dBuV)	CORRECTION FACTOR (dB/m)
1	2390.00	59.51 PK	74.00	-14.49	1.10 H	14	28.12	31.39
2	2390.00	48.70 AV	54.00	-5.30	1.10 H	14	17.31	31.39
3	*2437.00	104.89 PK			1.09 H	6	73.35	31.54
4	*2437.00	94.06 AV			1.09 H	6	62.52	31.54
5	2483.50	65.59 PK	74.00	-8.41	1.06 H	8	33.89	31.70
6	2483.50	52.56 AV	54.00	-1.44	1.06 H	8	20.86	31.70
7	4874.00	46.89 PK	74.00	-27.11	1.10 H	360	9.60	37.29
8	4874.00	35.05 AV	54.00	-18.95	1.10 H	360	-2.24	37.29

ANTENNA POLARITY & TEST DISTANCE: VERTICAL AT 3 M								
NO.	FREQ. (MHz)	EMISSION LEVEL (dBuV/m)	LIMIT (dBuV/m)	MARGIN (dB)	ANTENNA HEIGHT (m)	TABLE ANGLE (Degree)	RAW VALUE (dBuV)	CORRECTION FACTOR (dB/m)
1	*2437.00	98.31 PK			1.24 V	340	66.77	31.54
2	*2437.00	88.83 AV			1.24 V	340	57.29	31.54
3	2483.50	59.69 PK	74.00	-14.31	1.23 V	340	27.99	31.70
4	2483.50	47.78 AV	54.00	-6.22	1.23 V	340	16.08	31.70
5	4874.00	44.81 PK	74.00	-29.19	1.23 V	241	7.52	37.29
6	4874.00	34.57 AV	54.00	-19.43	1.23 V	241	-2.72	37.29

- REMARKS:**
1. Emission level (dBuV/m) = Raw Value (dBuV) + Correction Factor (dB/m).
 2. Correction Factor (dB/m) = Antenna Factor (dB/m) + Cable Factor (dB).
 3. The other emission levels were very low against the limit.
 4. Margin value = Emission level – Limit value.
 5. The limit value is defined as per 15.247.
 6. “ * “: Fundamental frequency.

EUT TEST CONDITION		MEASUREMENT DETAIL	
CHANNEL	Channel 7	FREQUENCY RANGE	1 ~ 25GHz
MODULATION TYPE	BPSK	INPUT POWER (SYSTEM)	120Vac, 60 Hz
TRANSFER RATE	15Mbps	DETECTOR FUNCTION	Peak(PK) Average (AV)
ENVIRONMENTAL CONDITIONS	25deg. C, 65%RH, 991hPa	TESTED BY	Lori Chui

ANTENNA POLARITY & TEST DISTANCE: HORIZONTAL AT 3 M								
NO.	FREQ. (MHz)	EMISSION LEVEL (dBuV/m)	LIMIT (dBuV/m)	MARGIN (dB)	ANTENNA HEIGHT (m)	TABLE ANGLE (Degree)	RAW VALUE (dBuV)	CORRECTION FACTOR (dB/m)
1	2280.00	54.94 PK	74.00	-19.06	1.15 H	359	23.93	31.01
2	2280.00	46.43 AV	54.00	-7.57	1.15 H	359	15.42	31.01
3	2320.00	56.96 PK	74.00	-17.04	1.40 H	49	25.81	31.15
4	2320.00	46.75 AV	54.00	-7.25	1.40 H	49	15.60	31.15
5	*2452.00	103.87 PK			1.28 H	56	72.28	31.59
6	*2452.00	93.53 AV			1.28 H	56	61.94	31.59
7	2483.50	68.35 PK	74.00	-5.65	1.29 H	50	36.65	31.70
8	2483.50	52.60 AV	54.00	-1.40	1.29 H	50	20.90	31.70
9	4904.00	46.24 PK	74.00	-27.76	1.00 H	76	8.86	37.38
10	4904.00	34.49 AV	54.00	-19.51	1.00 H	76	-2.89	37.38

ANTENNA POLARITY & TEST DISTANCE: VERTICAL AT 3 M								
NO.	FREQ. (MHz)	EMISSION LEVEL (dBuV/m)	LIMIT (dBuV/m)	MARGIN (dB)	ANTENNA HEIGHT (m)	TABLE ANGLE (Degree)	RAW VALUE (dBuV)	CORRECTION FACTOR (dB/m)
1	*2452.00	98.05 PK			1.00 V	275	66.46	31.59
2	*2452.00	87.90 AV			1.00 V	275	56.31	31.59
3	2483.50	62.73 PK	74.00	-11.27	1.22 V	276	31.03	31.70
4	2483.50	49.73 AV	54.00	-4.27	1.22 V	276	18.03	31.70
5	4904.00	47.70 PK	74.00	-26.30	1.09 V	332	10.32	37.38
6	4904.00	34.71 AV	54.00	-19.29	1.09 V	332	-2.67	37.38

- REMARKS:**
1. Emission level (dBuV/m) = Raw Value (dBuV) + Correction Factor (dB/m).
 2. Correction Factor (dB/m) = Antenna Factor (dB/m) + Cable Factor (dB).
 3. The other emission levels were very low against the limit.
 4. Margin value = Emission level – Limit value.
 5. The limit value is defined as per 15.247.
 6. “ * “: Fundamental frequency.

DRAFT 802.11n (40MHz) OFDM MODULATION: DUAL TX:

EUT TEST CONDITION		MEASUREMENT DETAIL	
CHANNEL	Channel 1	FREQUENCY RANGE	1 ~ 25GHz
MODULATION TYPE	BPSK	INPUT POWER (SYSTEM)	120Vac, 60 Hz
TRANSFER RATE	30Mbps	DETECTOR FUNCTION	Peak(PK) Average (AV)
ENVIRONMENTAL CONDITIONS	25deg. C, 65%RH, 991hPa	TESTED BY	Lori Chui

ANTENNA POLARITY & TEST DISTANCE: HORIZONTAL AT 3 M								
NO.	FREQ. (MHz)	EMISSION LEVEL (dBuV/m)	LIMIT (dBuV/m)	MARGIN (dB)	ANTENNA HEIGHT (m)	TABLE ANGLE (Degree)	RAW VALUE (dBuV)	CORRECTION FACTOR (dB/m)
1	2390.00	62.87 PK	74.00	-11.13	1.14 H	195	31.48	31.39
2	2390.00	52.61 AV	54.00	-1.39	1.14 H	195	21.22	31.39
3	*2422.00	106.36 PK			1.10 H	202	74.87	31.49
4	*2422.00	95.47 AV			1.10 H	202	63.98	31.49
5	2493.00	59.42 PK	74.00	-14.58	1.33 H	200	27.69	31.73
6	2493.00	48.59 AV	54.00	-5.41	1.33 H	200	16.86	31.73
7	4844.00	45.08 PK	74.00	-28.92	1.10 H	52	7.89	37.19
8	4844.00	32.81 AV	54.00	-21.19	1.10 H	52	-4.38	37.19

ANTENNA POLARITY & TEST DISTANCE: VERTICAL AT 3 M								
NO.	FREQ. (MHz)	EMISSION LEVEL (dBuV/m)	LIMIT (dBuV/m)	MARGIN (dB)	ANTENNA HEIGHT (m)	TABLE ANGLE (Degree)	RAW VALUE (dBuV)	CORRECTION FACTOR (dB/m)
1	2390.00	57.78 PK	74.00	-16.22	1.34 V	139	26.39	31.39
2	2390.00	46.47 AV	54.00	-7.53	1.34 V	139	15.08	31.39
3	*2422.00	102.12 PK			1.34 V	136	70.63	31.49
4	*2422.00	91.85 AV			1.34 V	136	60.36	31.49
5	4844.00	46.45 PK	74.00	-27.55	1.34 V	279	9.26	37.19
6	4844.00	33.87 AV	54.00	-20.13	1.34 V	279	-3.32	37.19

- REMARKS:**
1. Emission level (dBuV/m) = Raw Value (dBuV) + Correction Factor (dB/m).
 2. Correction Factor (dB/m) = Antenna Factor (dB/m) + Cable Factor (dB).
 3. The other emission levels were very low against the limit.
 4. Margin value = Emission level – Limit value.
 5. The limit value is defined as per 15.247.
 6. “ * “: Fundamental frequency.

EUT TEST CONDITION		MEASUREMENT DETAIL	
CHANNEL	Channel 4	FREQUENCY RANGE	1 ~ 25GHz
MODULATION TYPE	BPSK	INPUT POWER (SYSTEM)	120Vac, 60 Hz
TRANSFER RATE	30Mbps	DETECTOR FUNCTION	Peak(PK) Average (AV)
ENVIRONMENTAL CONDITIONS	25deg. C, 65%RH, 991hPa	TESTED BY	Lori Chui

ANTENNA POLARITY & TEST DISTANCE: HORIZONTAL AT 3 M								
NO.	FREQ. (MHz)	EMISSION LEVEL (dBuV/m)	LIMIT (dBuV/m)	MARGIN (dB)	ANTENNA HEIGHT (m)	TABLE ANGLE (Degree)	RAW VALUE (dBuV)	CORRECTION FACTOR (dB/m)
1	2390.00	49.22 PK	74.00	-4.78	1.37 H	57	17.83	31.39
1	2390.00	49.05 AV	54.00	-4.95	1.34 H	50	17.66	31.39
2	*2437.00	106.54 PK			1.30 H	48	75.00	31.54
2	*2437.00	95.86 AV			1.30 H	48	64.32	31.54
3	2483.50	63.70 PK	74.00	-10.30	1.31 H	55	32.00	31.70
3	2483.50	52.43 AV	54.00	-1.57	1.31 H	55	20.73	31.70
4	4874.00	47.84 PK	74.00	-26.16	1.00 H	37	10.55	37.29
4	4874.00	35.36 AV	54.00	-18.64	1.00 H	37	-1.93	37.29

ANTENNA POLARITY & TEST DISTANCE: VERTICAL AT 3 M								
NO.	FREQ. (MHz)	EMISSION LEVEL (dBuV/m)	LIMIT (dBuV/m)	MARGIN (dB)	ANTENNA HEIGHT (m)	TABLE ANGLE (Degree)	RAW VALUE (dBuV)	CORRECTION FACTOR (dB/m)
1	*2437.00	102.34 PK			1.02 V	255	70.80	31.54
2	*2437.00	92.06 AV			1.02 V	255	60.52	31.54
3	4874.00	45.55 PK	74.00	-28.45	1.00 V	166	8.26	37.29
4	4874.00	33.70 AV	54.00	-20.30	1.00 V	166	-3.59	37.29

- REMARKS:**
1. Emission level (dBuV/m) = Raw Value (dBuV) + Correction Factor (dB/m).
 2. Correction Factor (dB/m) = Antenna Factor (dB/m) + Cable Factor (dB).
 3. The other emission levels were very low against the limit.
 4. Margin value = Emission level – Limit value.
 5. The limit value is defined as per 15.247.
 6. “ * “: Fundamental frequency.

EUT TEST CONDITION		MEASUREMENT DETAIL	
CHANNEL	Channel 7	FREQUENCY RANGE	1 ~ 25GHz
MODULATION TYPE	BPSK	INPUT POWER (SYSTEM)	120Vac, 60 Hz
TRANSFER RATE	30Mbps	DETECTOR FUNCTION	Peak(PK) Average (AV)
ENVIRONMENTAL CONDITIONS	25deg. C, 65%RH, 991hPa	TESTED BY	Lori Chui

ANTENNA POLARITY & TEST DISTANCE: HORIZONTAL AT 3 M								
NO.	FREQ. (MHz)	EMISSION LEVEL (dBuV/m)	LIMIT (dBuV/m)	MARGIN (dB)	ANTENNA HEIGHT (m)	TABLE ANGLE (Degree)	RAW VALUE (dBuV)	CORRECTION FACTOR (dB/m)
1	2312.00	57.76 PK	74.00	-16.24	1.38 H	53	26.64	31.12
2	2312.00	47.40 AV	54.00	-6.60	1.38 H	53	16.28	31.12
3	*2452.00	105.23 PK			1.37 H	301	73.64	31.59
4	*2452.00	94.91 AV			1.37 H	301	63.32	31.59
5	2483.50	65.70 PK	74.00	-8.30	1.34 H	298	34.00	31.70
6	2483.50	51.98 AV	54.00	-2.02	1.34 H	298	20.28	31.70
7	4904.00	46.23 PK	74.00	-27.77	1.20 H	103	8.85	37.38
8	4904.00	34.35 AV	54.00	-19.65	1.20 H	103	-3.03	37.38

ANTENNA POLARITY & TEST DISTANCE: VERTICAL AT 3 M								
NO.	FREQ. (MHz)	EMISSION LEVEL (dBuV/m)	LIMIT (dBuV/m)	MARGIN (dB)	ANTENNA HEIGHT (m)	TABLE ANGLE (Degree)	RAW VALUE (dBuV)	CORRECTION FACTOR (dB/m)
1	*2452.00	101.09 PK			1.00 V	275	69.50	31.59
2	*2452.00	90.38 AV			1.00 V	275	58.79	31.59
3	2483.50	58.71 PK	74.00	-15.29	1.00 V	254	27.01	31.70
4	2483.50	47.59 AV	54.00	-6.41	1.00 V	254	15.89	31.70
5	4904.00	47.04 PK	74.00	-26.96	1.21 V	340	9.66	37.38
6	4904.00	33.85 AV	54.00	-20.15	1.21 V	340	-3.53	37.38

- REMARKS:**
1. Emission level (dBuV/m) = Raw Value (dBuV) + Correction Factor (dB/m).
 2. Correction Factor (dB/m) = Antenna Factor (dB/m) + Cable Factor (dB).
 3. The other emission levels were very low against the limit.
 4. Margin value = Emission level – Limit value.
 5. The limit value is defined as per 15.247.
 6. “ * “: Fundamental frequency.



4.3 6dB BANDWIDTH MEASUREMENT

4.3.1 LIMITS OF 6dB BANDWIDTH MEASUREMENT

The minimum of 6dB Bandwidth Measurement is 0.5 MHz.

4.3.2 TEST INSTRUMENTS

DESCRIPTION & MANUFACTURER	MODEL NO.	SERIAL NO.	CALIBRATED UNTIL
SPECTRUM ANALYZER	FSEK 30	100049	Aug. 14, 2006

NOTE: The calibration interval of the above test instruments is 12 months and the calibrations are traceable to NML/ROC and NIST/USA.

4.3.3 TEST PROCEDURE

The transmitter output was connected to the spectrum analyzer through an attenuator. The bandwidth of the fundamental frequency was measured by spectrum analyzer with 100kHz RBW and 100kHz VBW. The 6dB bandwidth is defined as the total spectrum the power of which is higher than peak power minus 6dB.

4.3.4 DEVIATION FROM TEST STANDARD

No deviation

4.3.5 TEST SETUP

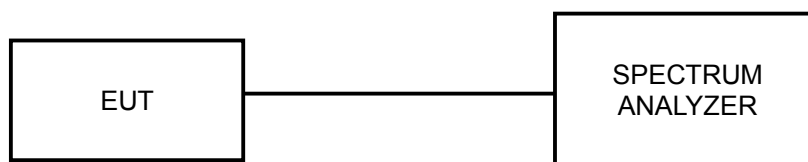

4.3.6 EUT OPERATING CONDITIONS

The software provided by client to enable the EUT under transmission condition continuously at lowest, middle and highest channel frequencies individually.

4.3.7 TEST RESULTS

802.11b DSSS MODULATION:

MODULATION TYPE	DBPSK	TRANSFER RATE	1Mbps
INPUT POWER (SYSTEM)	120Vac, 60 Hz	ENVIRONMENTAL CONDITIONS	25deg.C, 63%RH, 991hPa
TESTED BY	Match Tsui		

CHANNEL	CHANNEL FREQUENCY (MHz)	6dB BANDWIDTH (MHz)	MINIMUM LIMIT (MHz)	PASS / FAIL
1	2412	10.04	0.5	PASS
6	2437	10.04	0.5	PASS
11	2462	10.04	0.5	PASS

CH 1

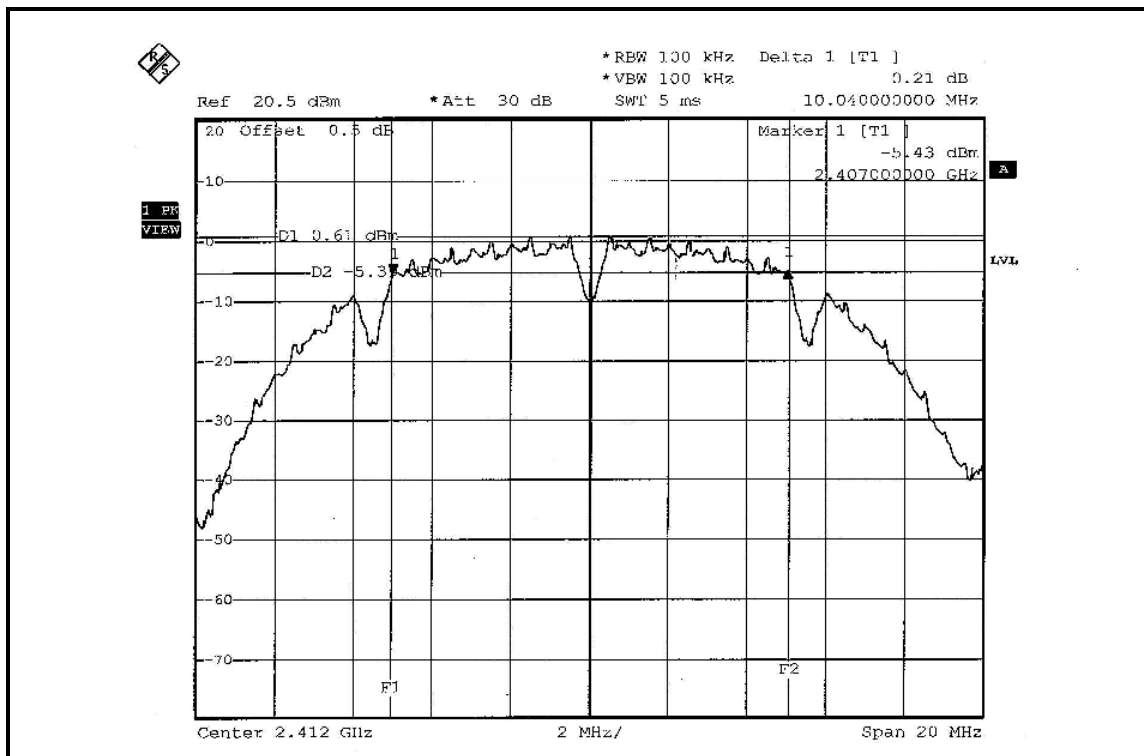

CH 6

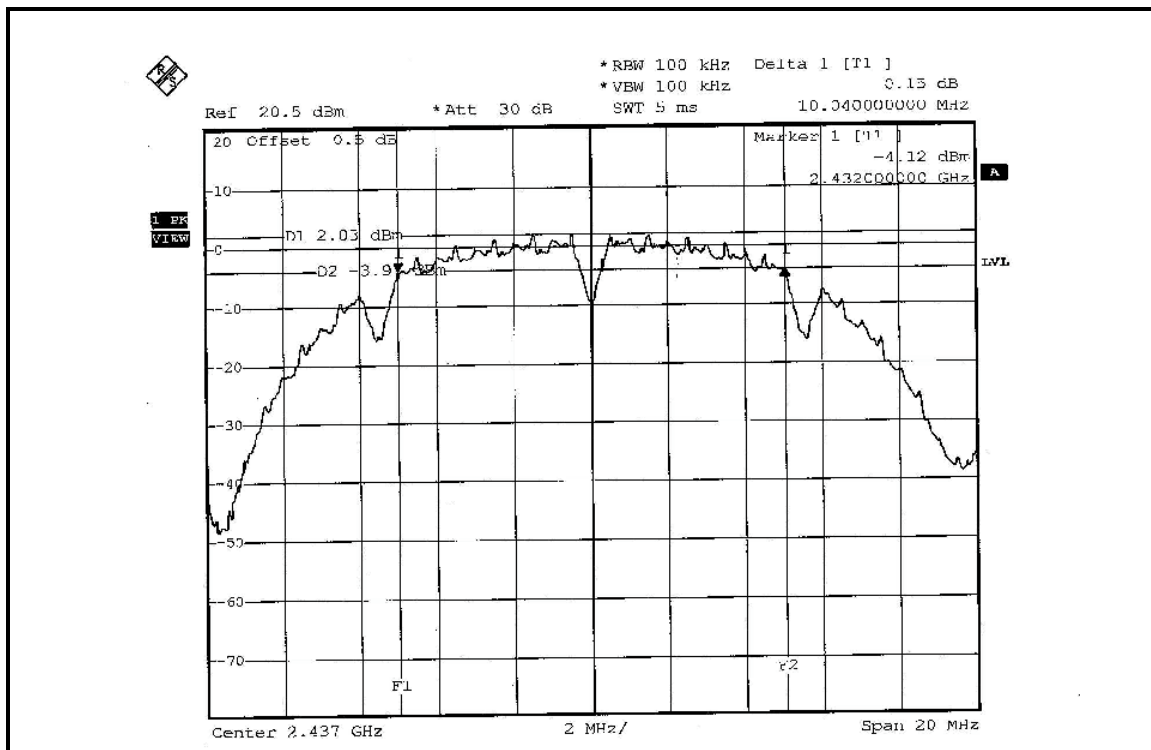

CH 11

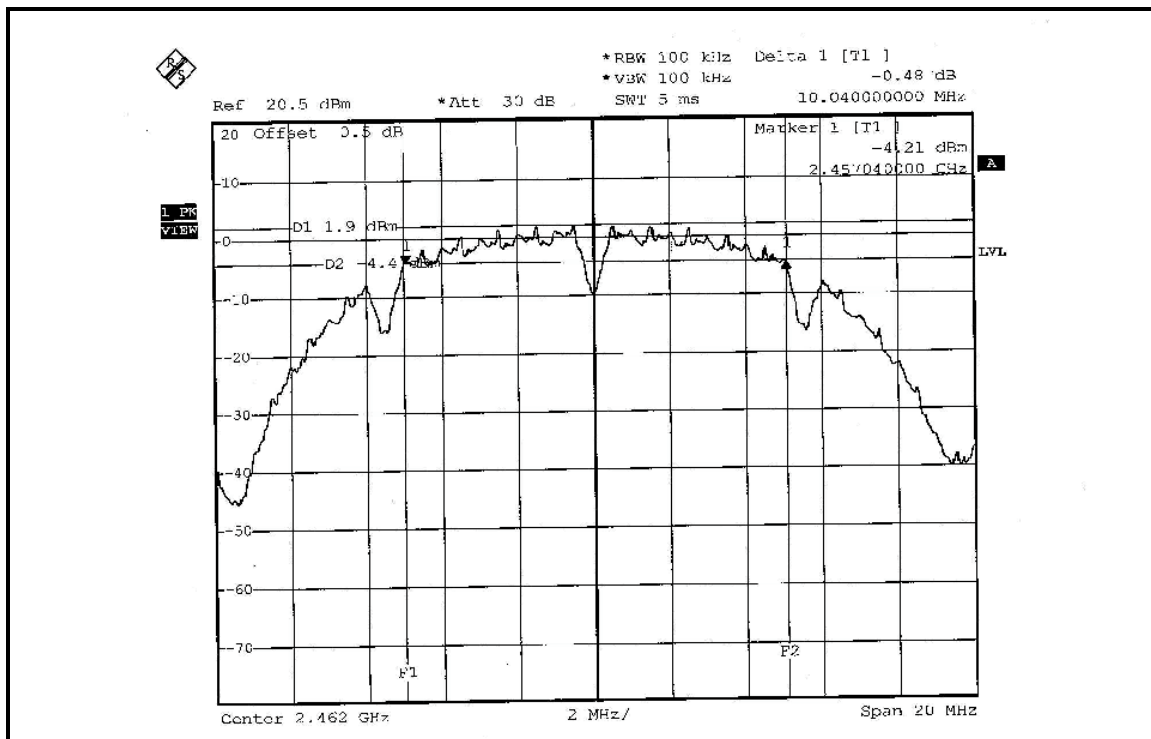

802.11g OFDM MODULATION:

MODULATION TYPE	BPSK	TRANSFER RATE	6Mbps
INPUT POWER (SYSTEM)	120Vac, 60 Hz	ENVIRONMENTAL CONDITIONS	25deg.C, 63%RH, 991hPa
TESTED BY	Match Tsui		

CHANNEL	CHANNEL FREQUENCY (MHz)	6dB BANDWIDTH (MHz)	MINIMUM LIMIT (MHz)	PASS / FAIL
1	2412	16.56	0.5	PASS
6	2437	16.52	0.5	PASS
11	2462	16.52	0.5	PASS

CH 1

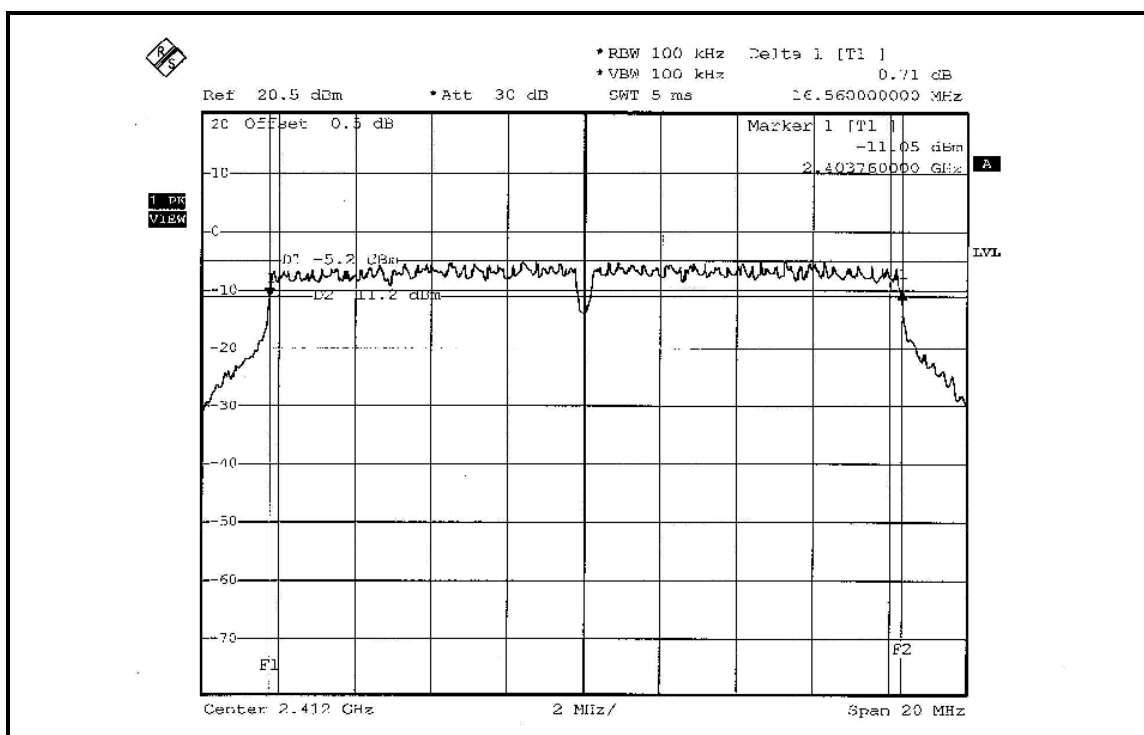

CH 6

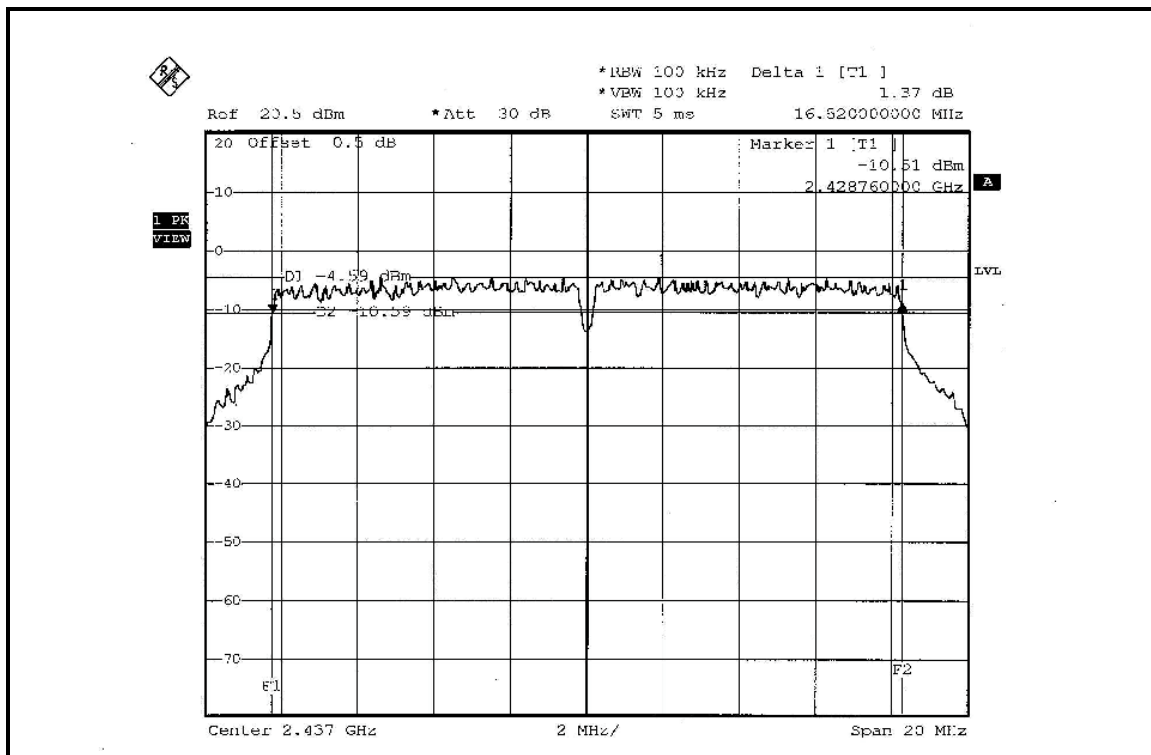

CH 11

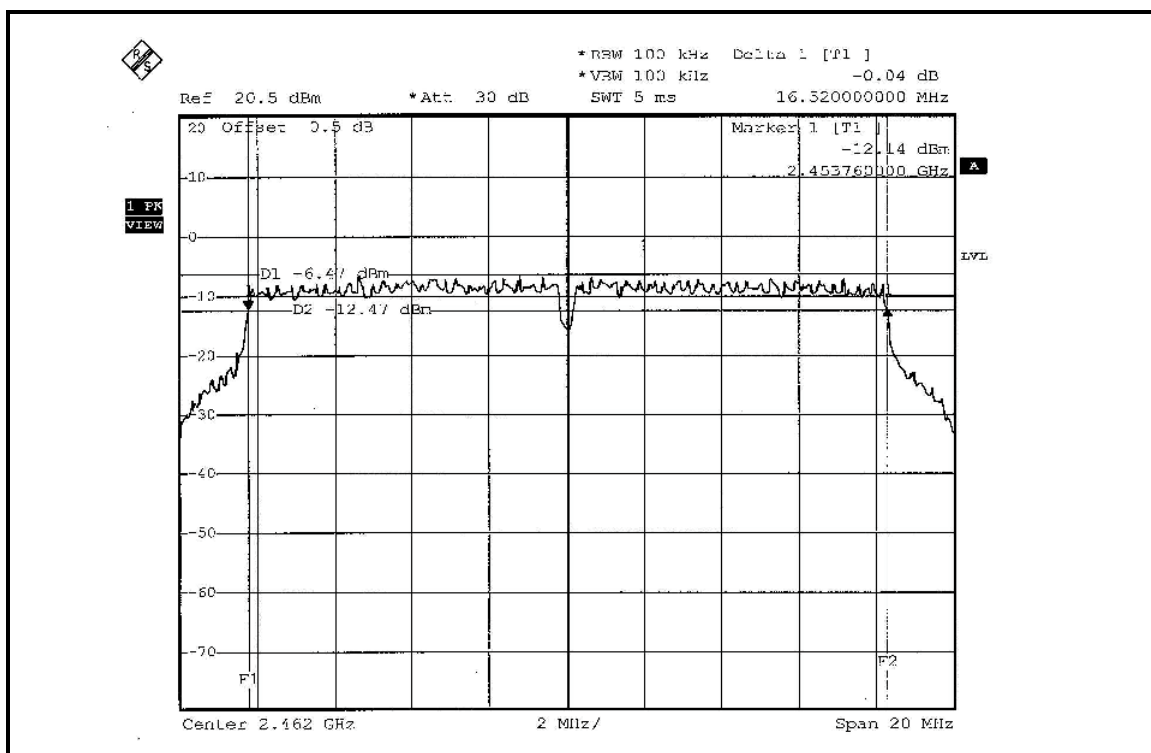

DRAFT 802.11n (20MHz) OFDM MODULATION: SINGLE TX:

MODULATION TYPE	BPSK	TRANSFER RATE	7.2Mbps
INPUT POWER (SYSTEM)	120Vac, 60 Hz	ENVIRONMENTAL CONDITIONS	25deg.C, 63%RH, 991hPa
TESTED BY	Match Tsui		

CHANNEL	CHANNEL FREQUENCY (MHz)	6dB BANDWIDTH (MHz)	MINIMUM LIMIT (MHz)	PASS / FAIL
1	2412	17.84	0.5	PASS
6	2437	17.80	0.5	PASS
11	2462	17.84	0.5	PASS

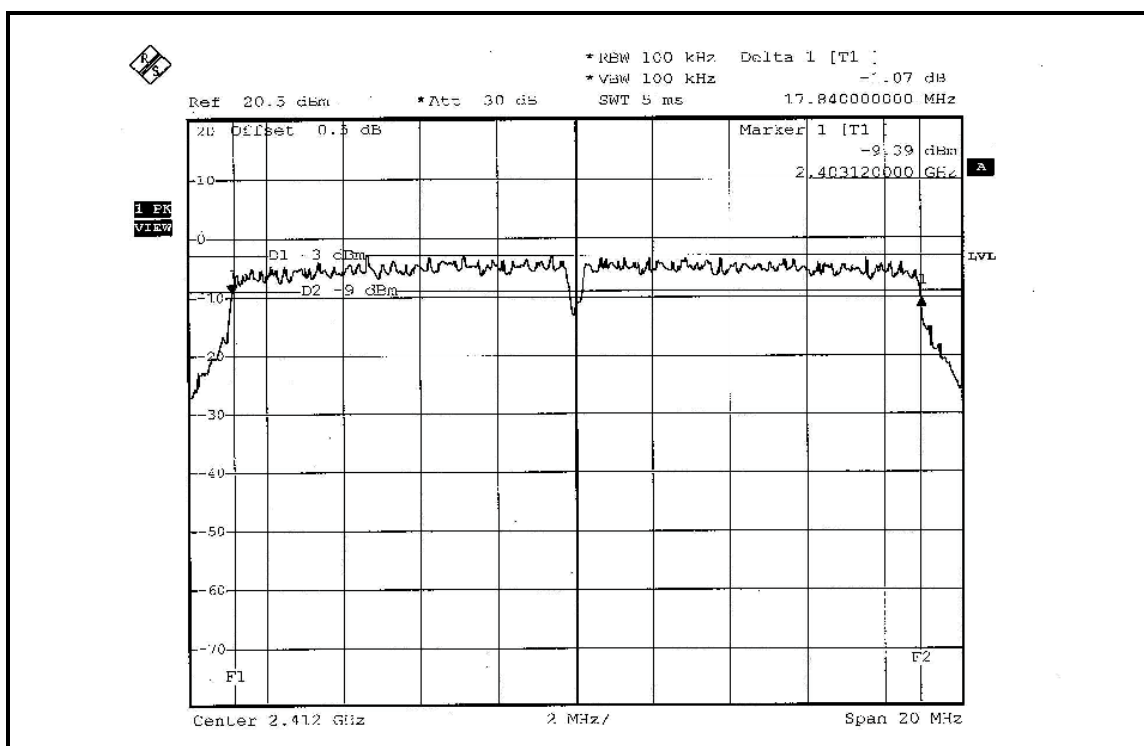
CH 1

CH 6

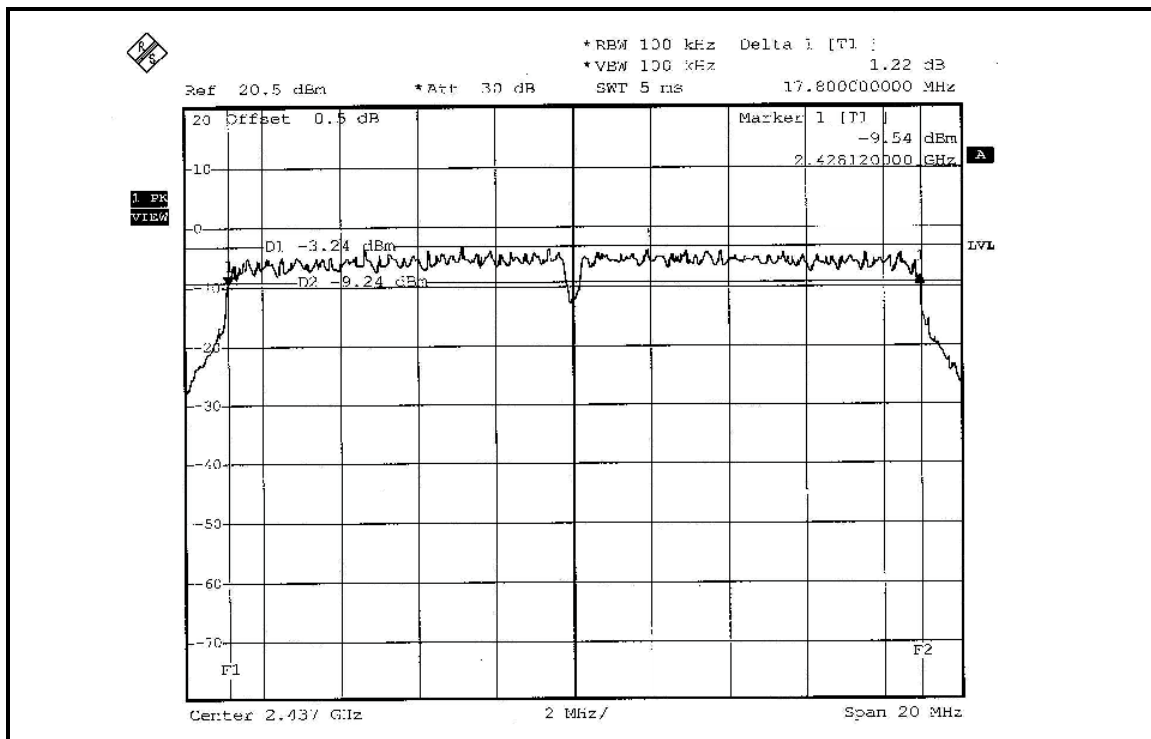

CH 11

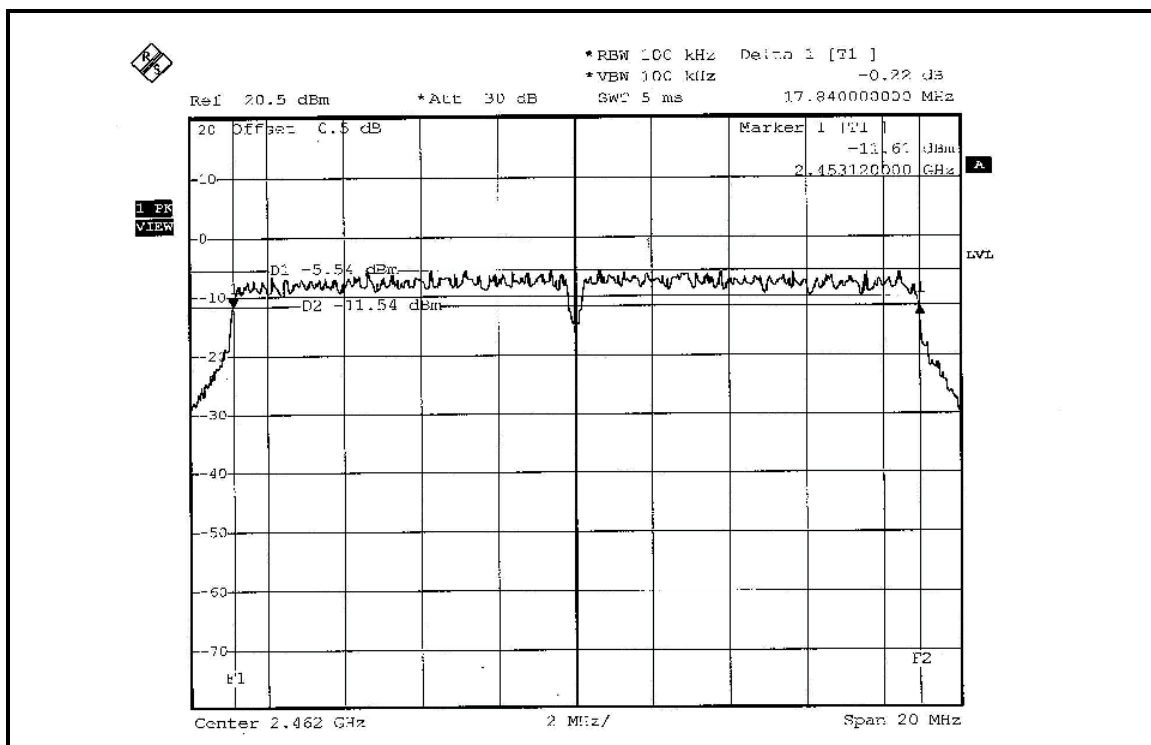



DRAFT 802.11n (20MHz) OFDM MODULATION: DUAL TX:

MODULATION TYPE	BPSK	TRANSFER RATE	14.444Mbps
INPUT POWER (SYSTEM)	120Vac, 60 Hz	ENVIRONMENTAL CONDITIONS	25deg.C, 63%RH, 991hPa
TESTED BY	Match Tsui		

CHANNEL	CHANNEL FREQUENCY (MHz)	6dB BANDWIDTH (MHz)		MINIMUM LIMIT (MHz)	PASS / FAIL
		CHAIN 0	CHAIN 1		
1	2412	17.72	17.76	0.5	PASS
6	2437	17.80	17.80	0.5	PASS
11	2462	17.84	17.80	0.5	PASS

FOR CHAIN 0: CH 1

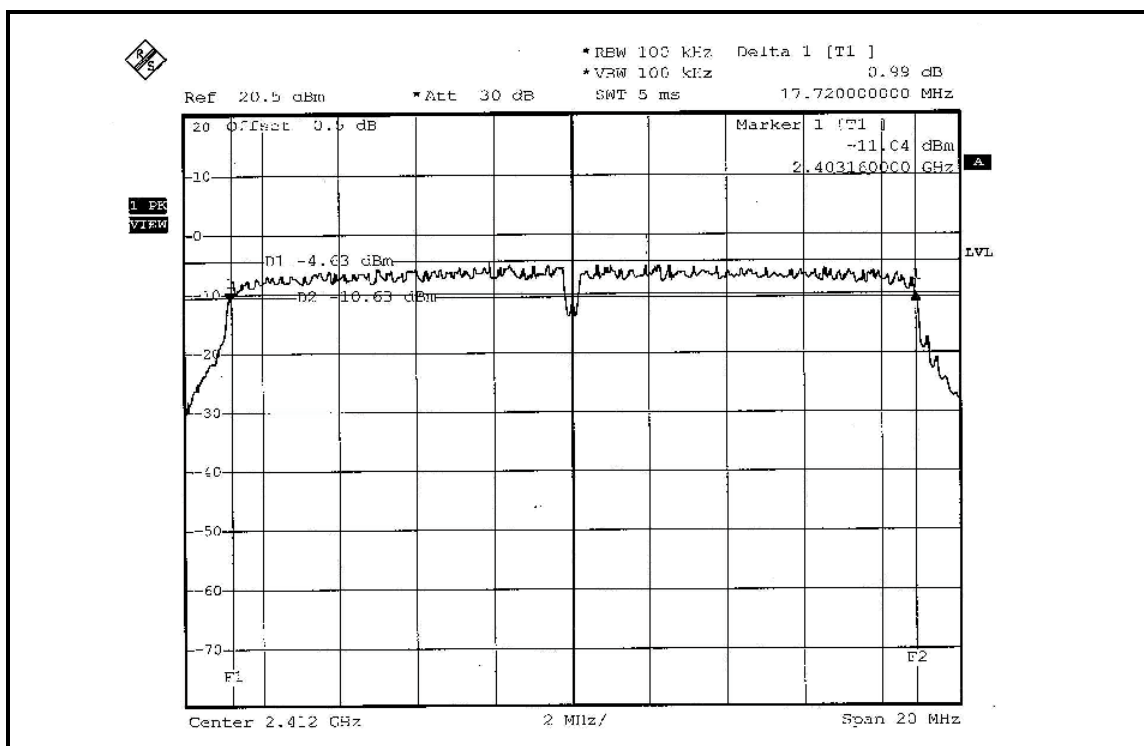

CH 6

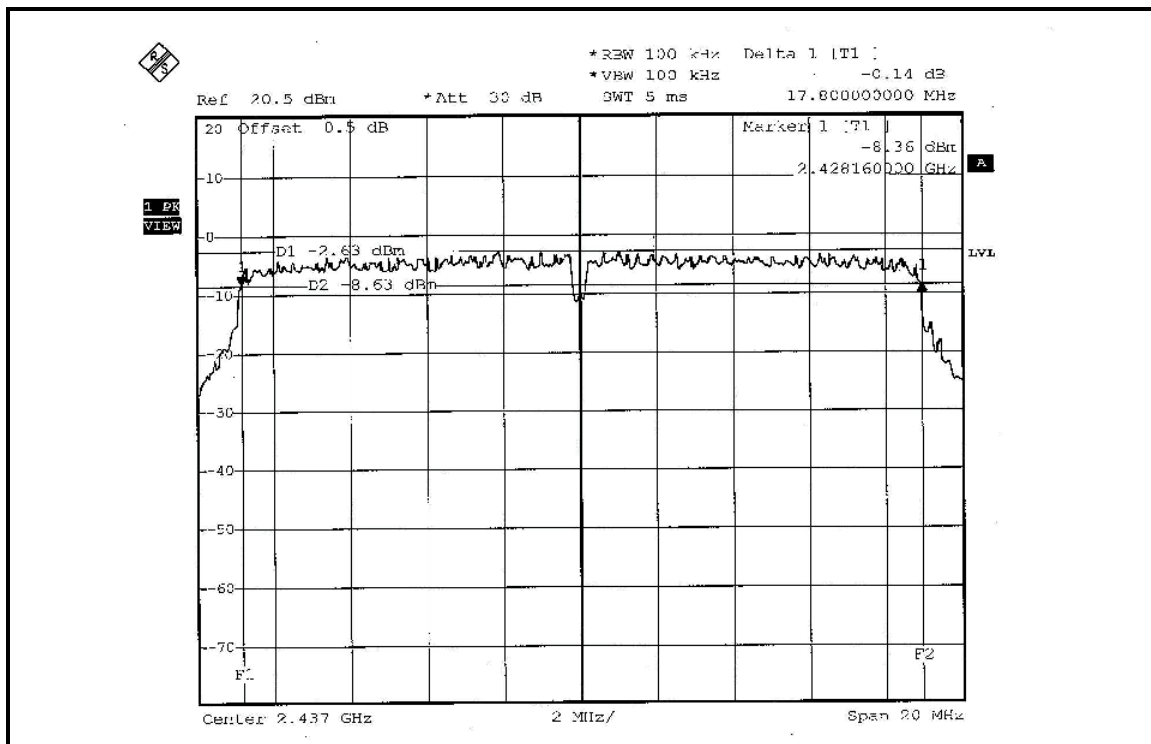

CH 11

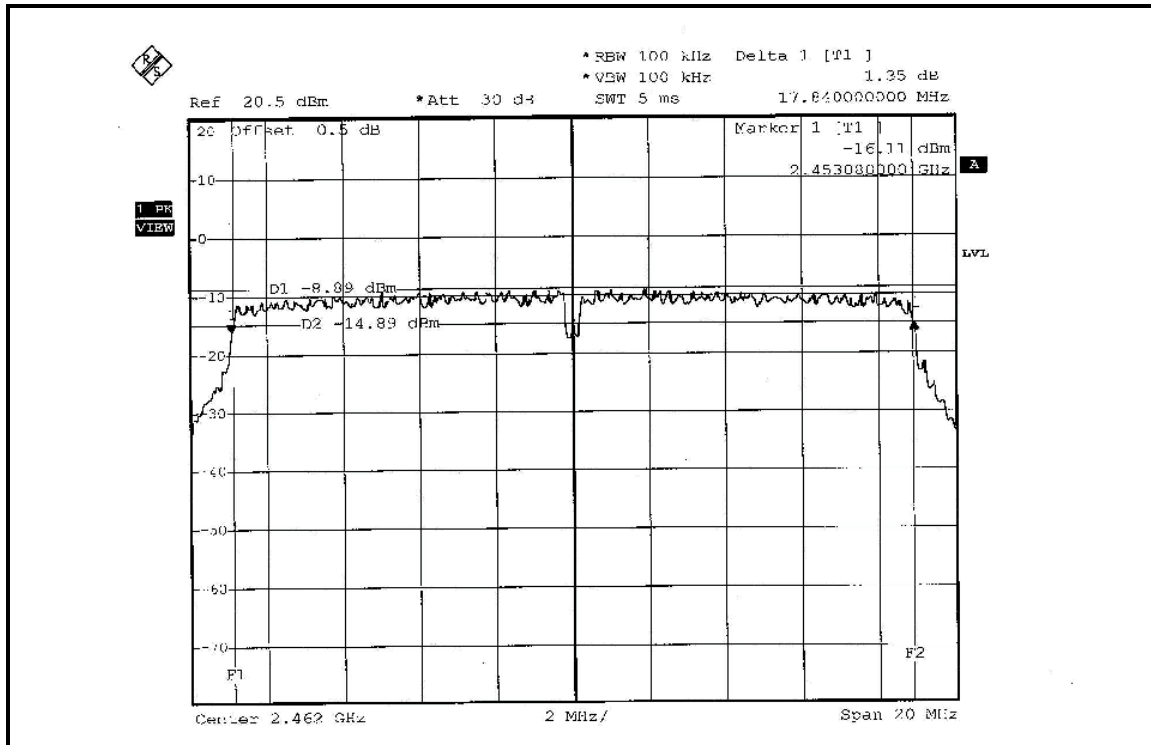

FOR CHAIN 1: CH 1

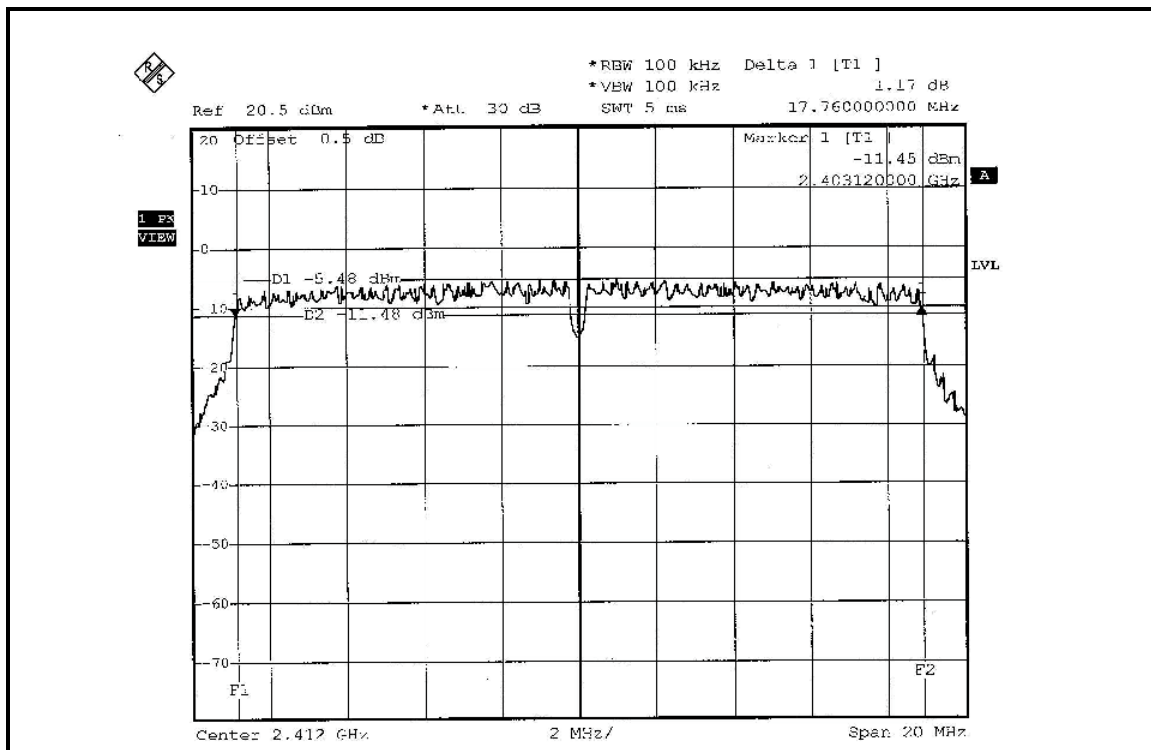

CH 6

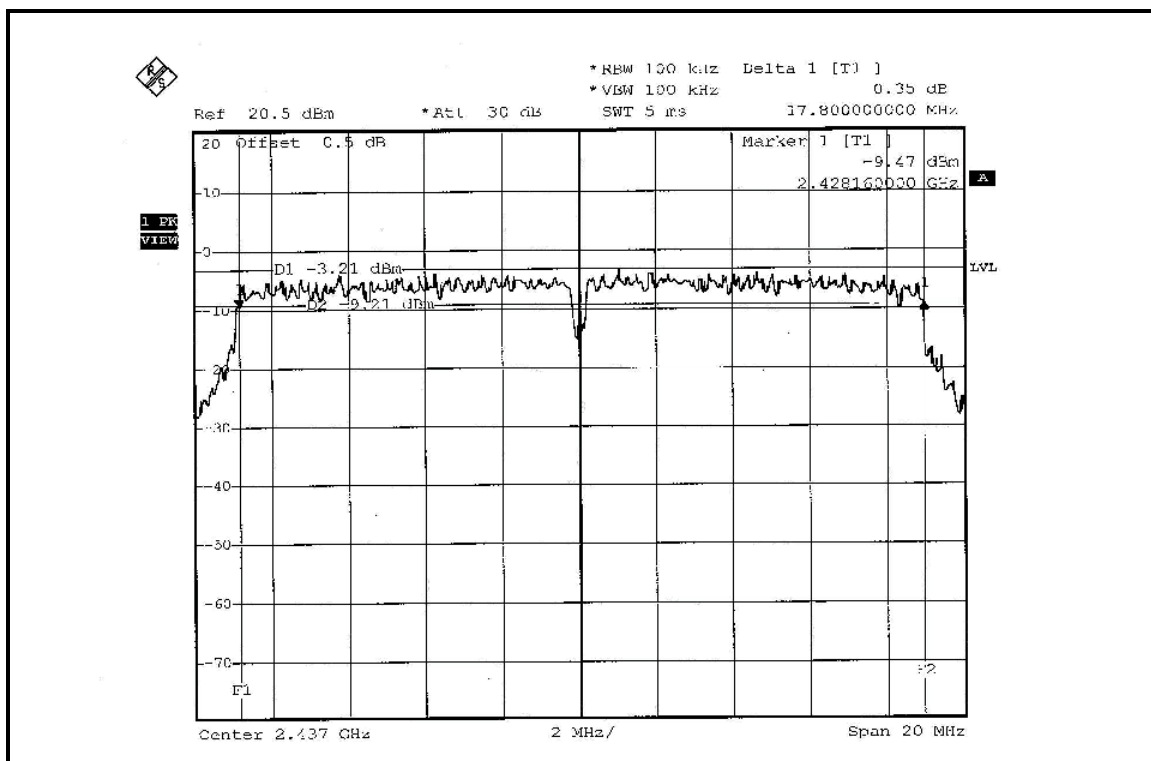

CH 11

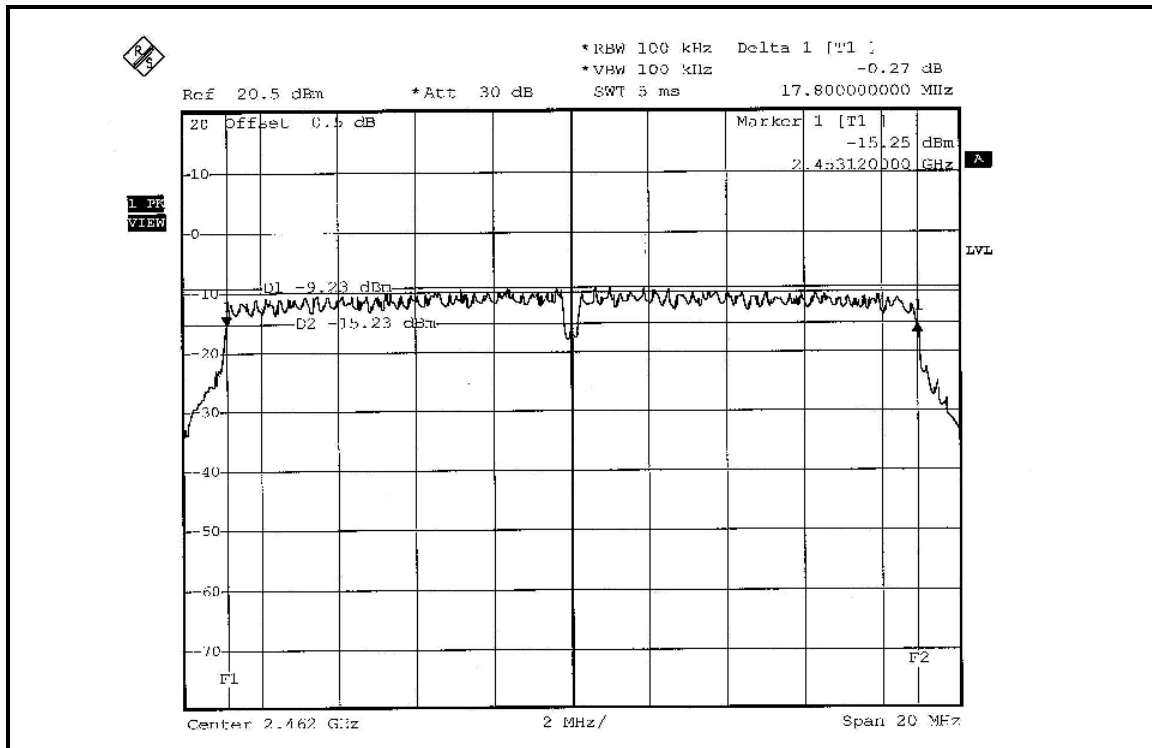

DRAFT 802.11n (40MHz) OFDM MODULATION: SINGLE TX:

MODULATION TYPE	BPSK	TRANSFER RATE	15Mbps
INPUT POWER (SYSTEM)	120Vac, 60 Hz	ENVIRONMENTAL CONDITIONS	25deg.C, 63%RH, 991hPa
TESTED BY	Match Tsui		

CHANNEL	CHANNEL FREQUENCY (MHz)	6dB BANDWIDTH (MHz)	MINIMUM LIMIT (MHz)	PASS / FAIL
1	2422	36.56	0.5	PASS
4	2437	36.48	0.5	PASS
7	2452	36.48	0.5	PASS

CH 1

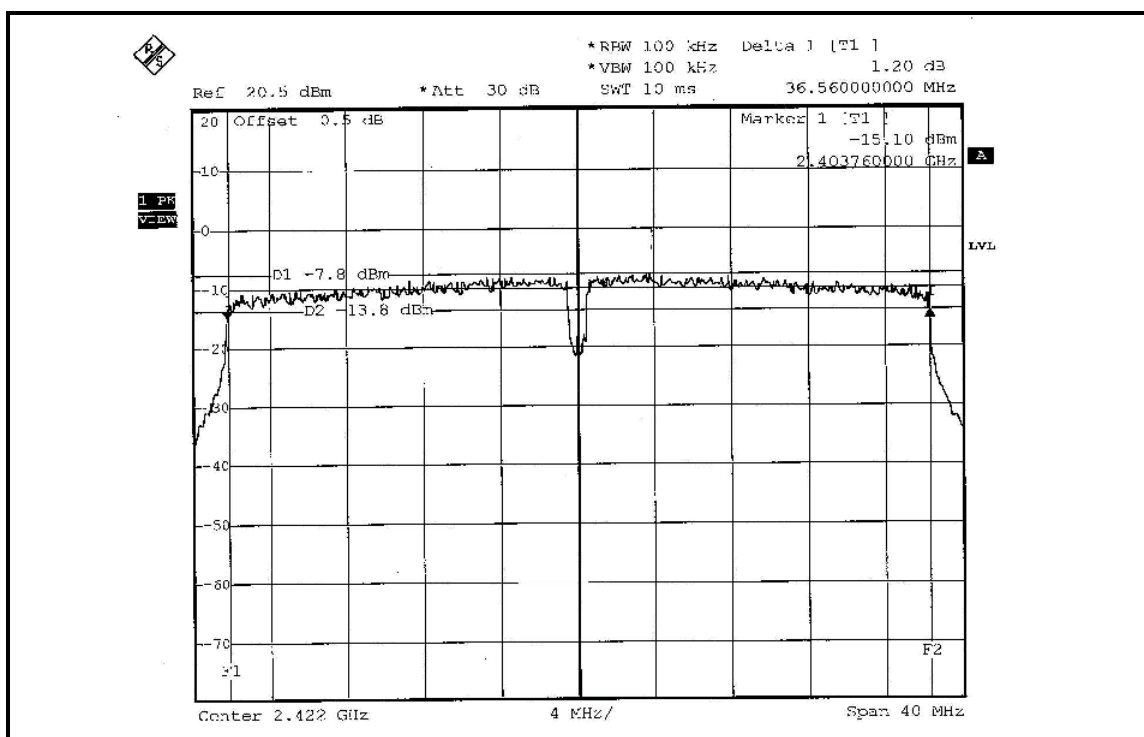

CH 4

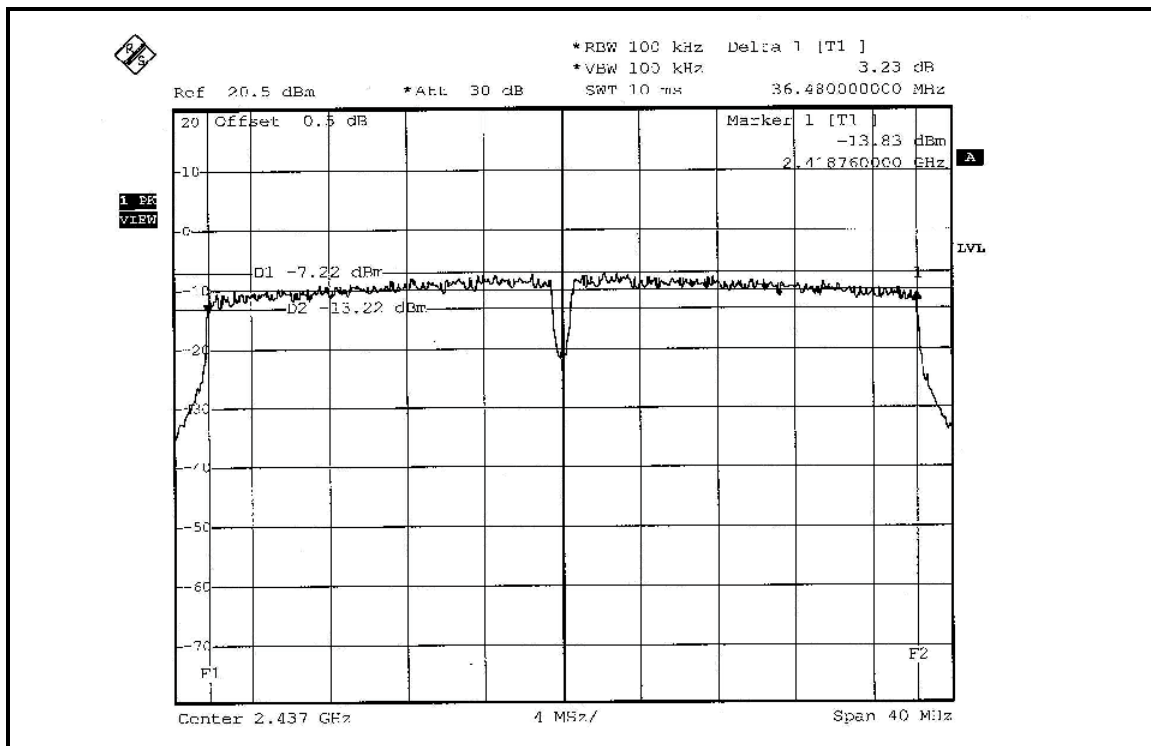

CH 7

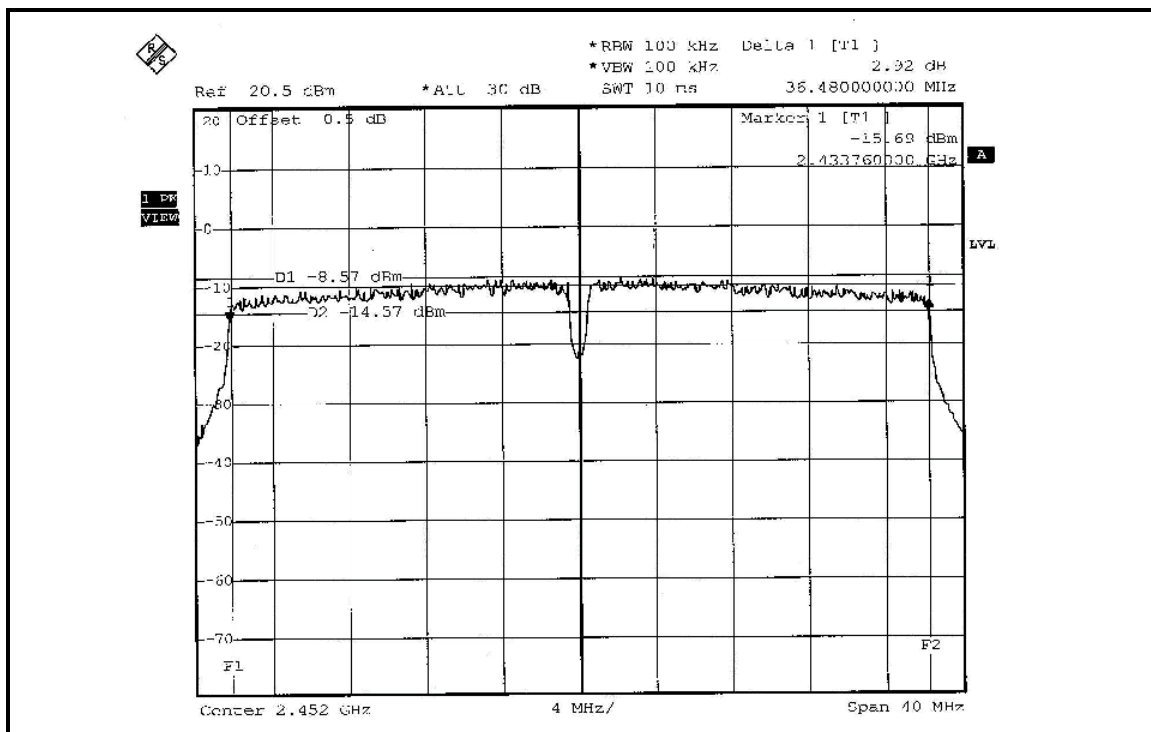

DRAFT 802.11n (40MHz) OFDM MODULATION: DUAL TX:

MODULATION TYPE	BPSK	TRANSFER RATE	30Mbps
INPUT POWER (SYSTEM)	120Vac, 60 Hz	ENVIRONMENTAL CONDITIONS	25deg.C, 63%RH, 991hPa
TESTED BY	Match Tsui		

CHANNEL	CHANNEL FREQUENCY (MHz)	6dB BANDWIDTH (MHz)		MINIMUM LIMIT (MHz)	PASS / FAIL
		CHAIN 0	CHAIN 1		
1	2422	36.48	36.48	0.5	PASS
4	2437	36.56	36.64	0.5	PASS
7	2452	36.48	36.56	0.5	PASS

FOR CHAIN 0: CH 1

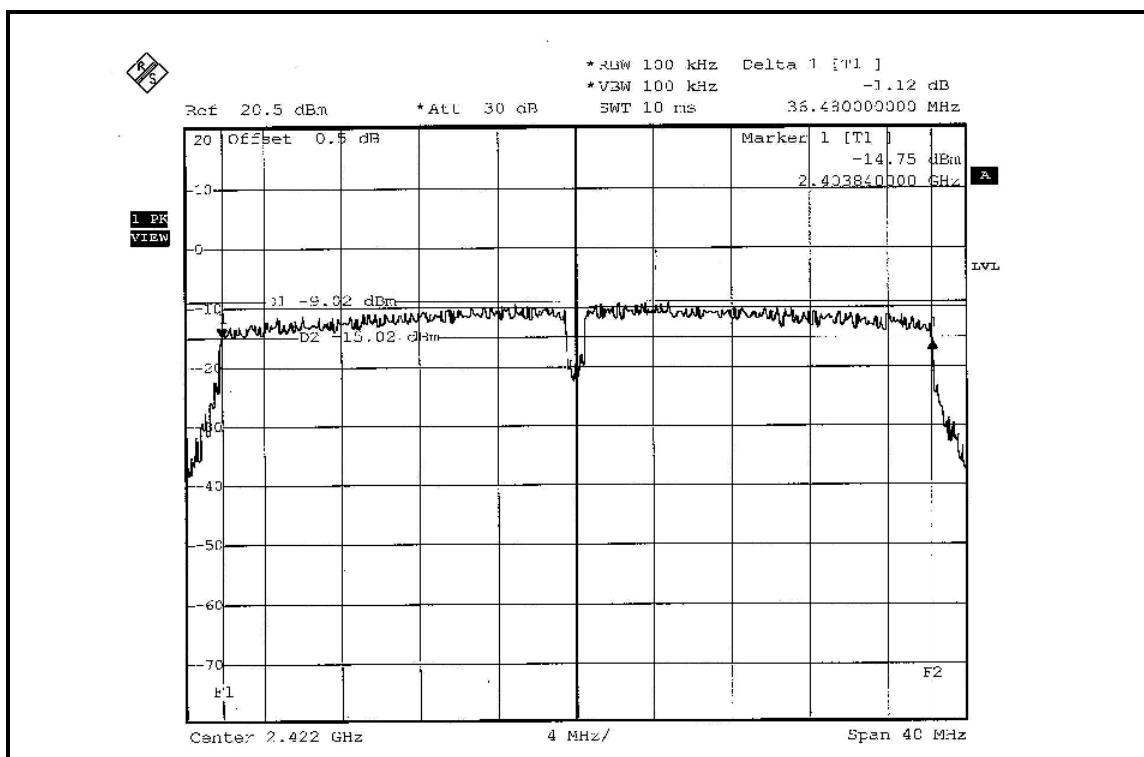

CH 4

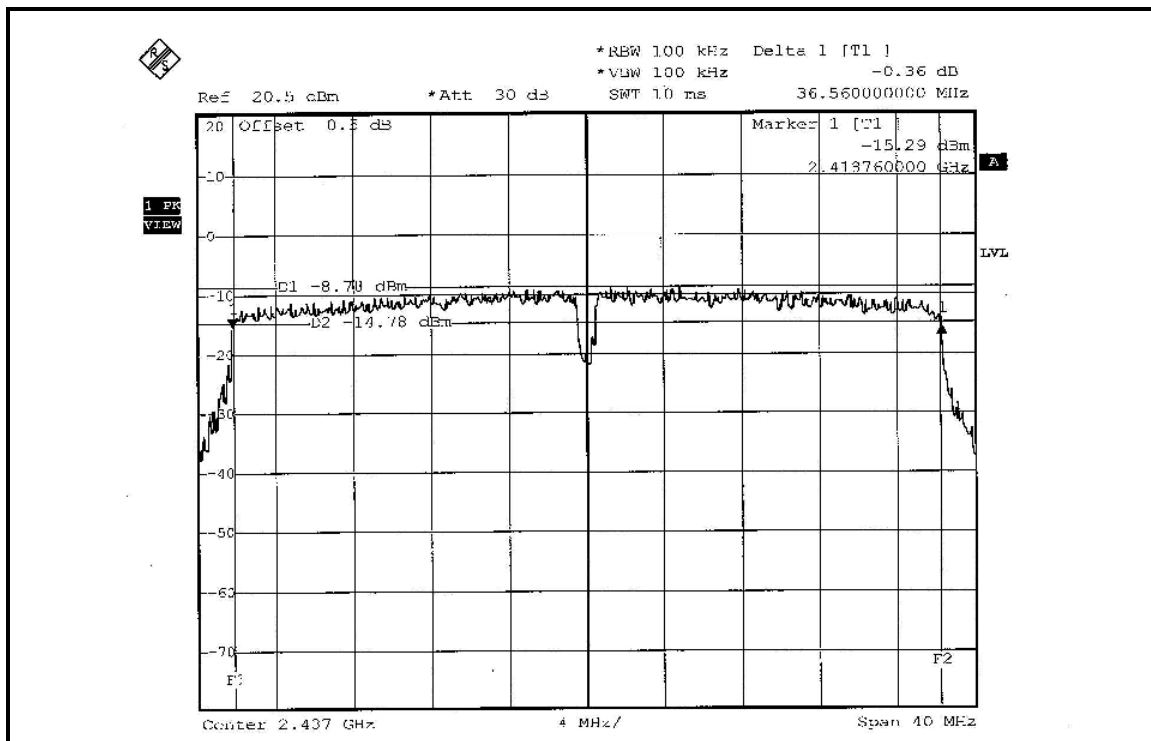

CH 7

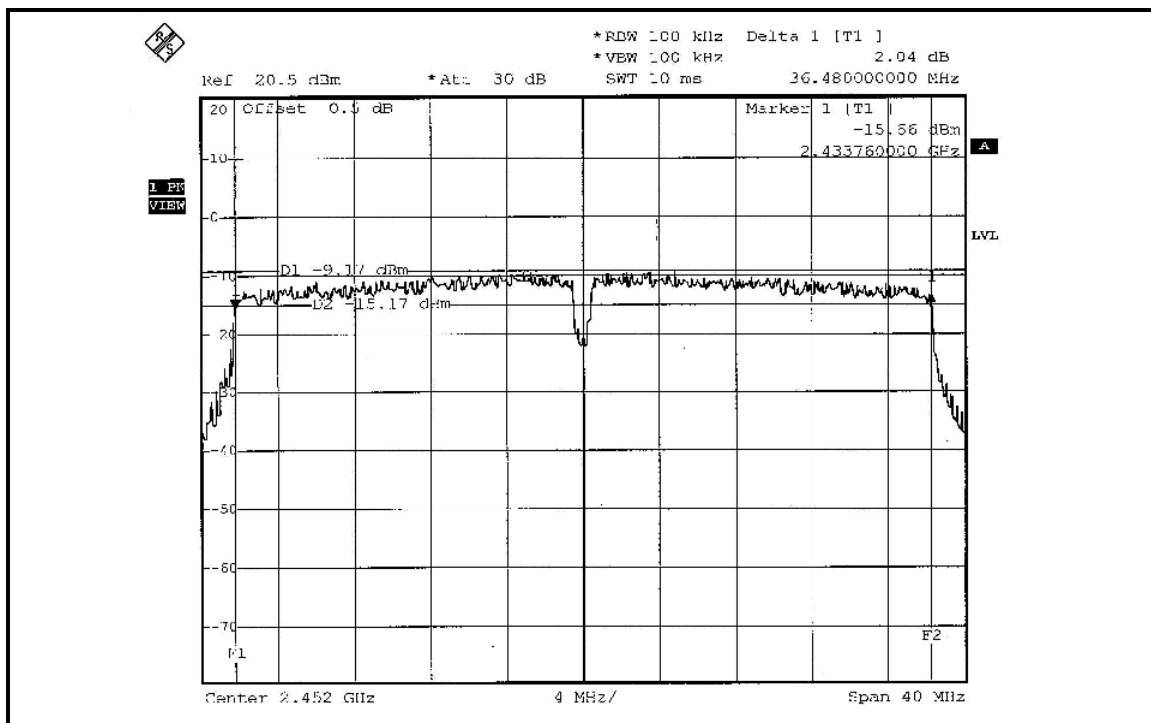

FOR CHAIN 1: CH 1

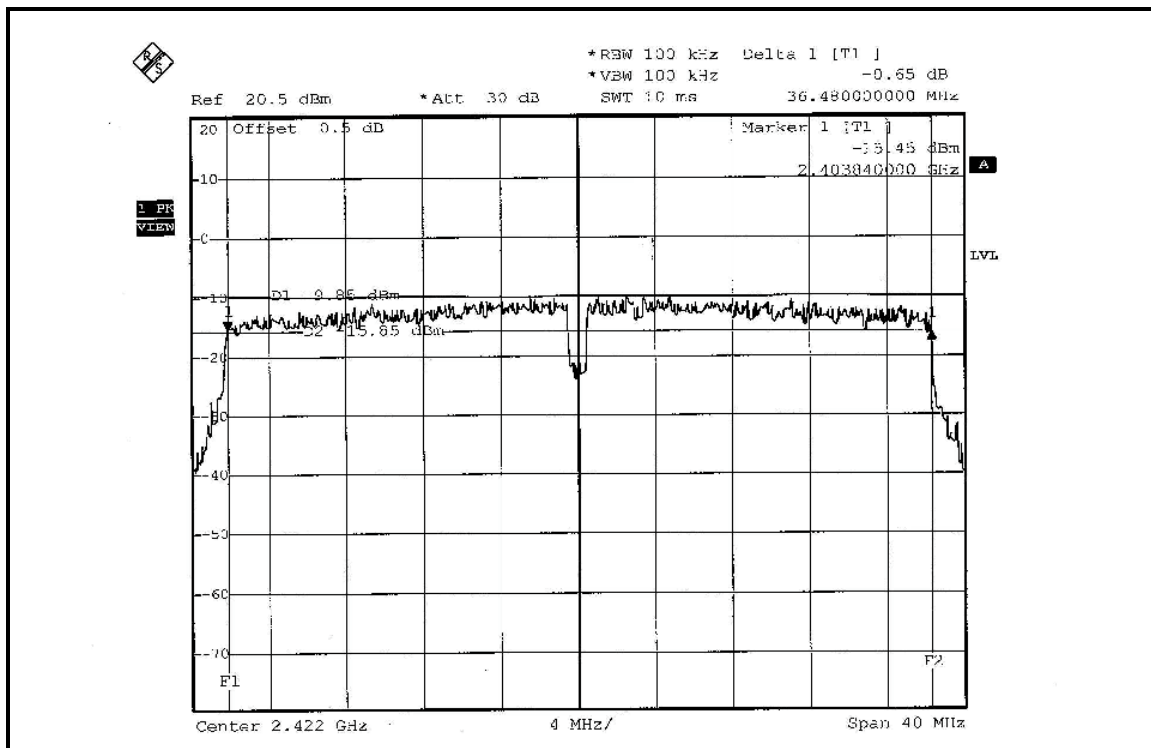

CH 4

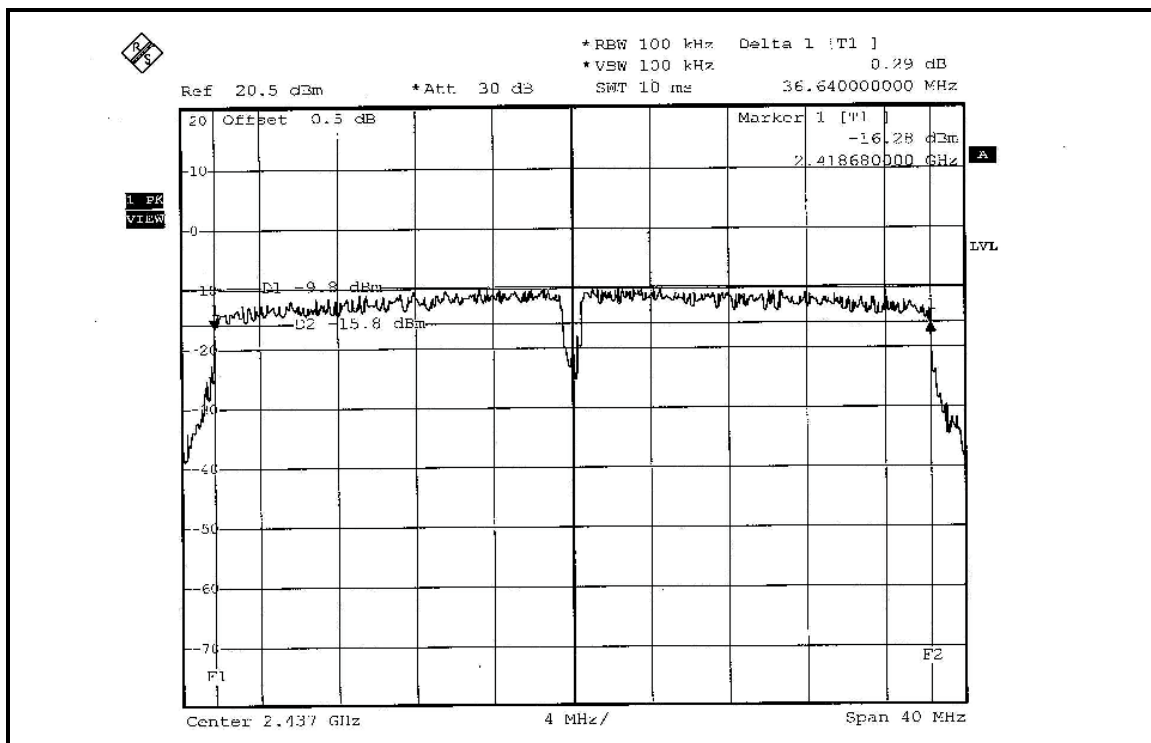

CH 7

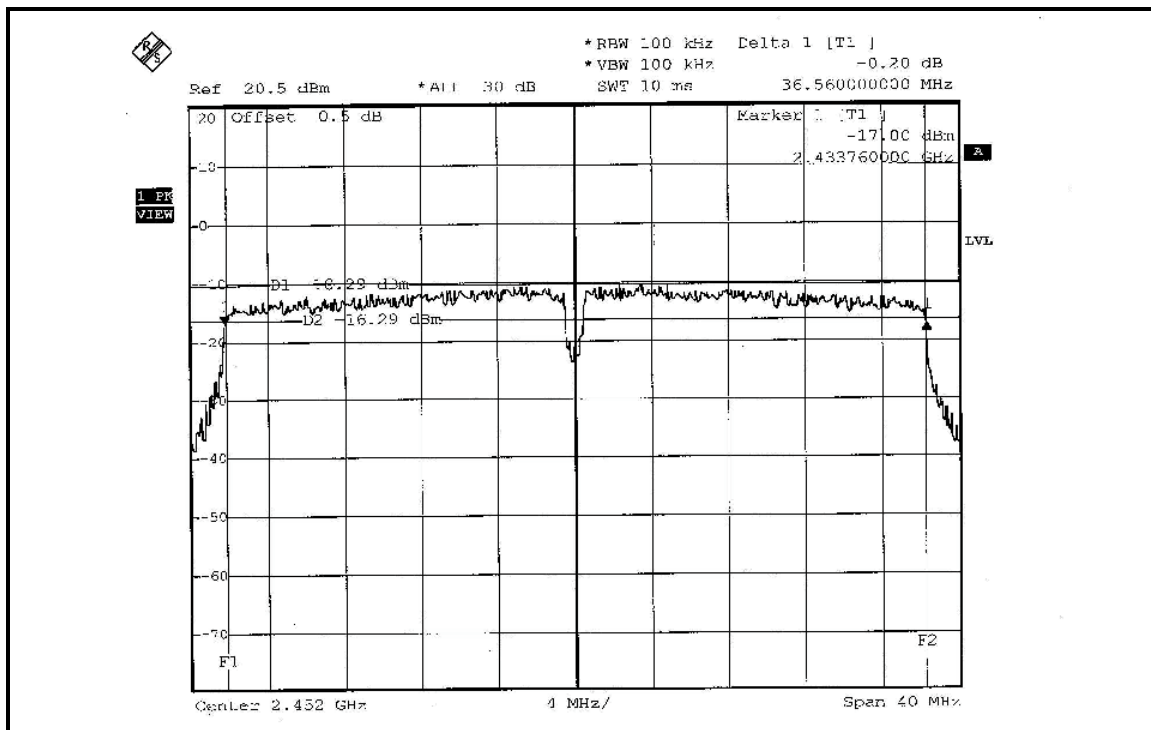

4.4 MAXIMUM PEAK OUTPUT POWER

4.4.1 LIMITS OF MAXIMUM PEAK OUTPUT POWER MEASUREMENT

The Maximum Peak Output Power Measurement is 30dBm.

4.4.2 INSTRUMENTS

DESCRIPTION & MANUFACTURER	MODEL NO.	SERIAL NO.	CALIBRATED UNTIL
R&S SPECTRUM ANALYZER	FSEK30	100049	Aug. 14, 2006
AGILENT SIGNAL GENERATOR	E8257C	MY43320668	Dec. 07, 2006
DIGITAL RT OSCILLOSCOPE	TDS1012	C037299	Nov. 28, 2006
NARDA DETECTOR	4503A	FSCM99899	NA

NOTE: The calibration interval of the above test instruments is 12 months and the calibrations are traceable to NML/ROC and NIST/USA.

4.4.3 TEST PROCEDURES

1. A detector was used on the output port of the EUT. An oscilloscope was used to read the response of the detector.
2. Replaced the EUT by the signal generator. The center frequency of the S.G was adjusted to the center frequency of the measured channel.
3. Adjusted the power to have the same reading on oscilloscope. Record the power level.

4.4.4 DEVIATION FROM TEST STANDARD

No deviation

4.4.5 TEST SETUP

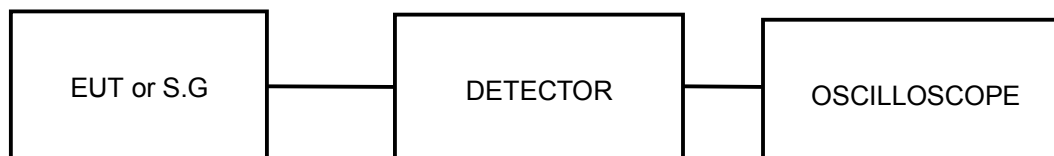

4.4.6 EUT OPERATING CONDITIONS

Same as Item 4.3.6

4.4.7 TEST RESULTS

802.11b DSSS MODULATION:

MODULATION TYPE	DBPSK	TRANSFER RATE	1Mbps
INPUT POWER (SYSTEM)	120Vac, 60 Hz	ENVIRONMENTAL CONDITIONS	25deg.C, 63%RH, 991hPa
TESTED BY	Match Tsui		

CHANNEL	CHANNEL FREQUENCY (MHz)	PEAK POWER OUTPUT (mW)	PEAK POWER OUTPUT (dBm)	PEAK POWER LIMIT (dBm)	PASS / FAIL
1	2412	45.290	16.56	30	PASS
6	2437	63.096	18.00	30	PASS
11	2462	64.121	18.07	30	PASS

802.11g OFDM MODULATION:

MODULATION TYPE	BPSK	TRANSFER RATE	6Mbps
INPUT POWER (SYSTEM)	120Vac, 60 Hz	ENVIRONMENTAL CONDITIONS	25deg.C, 63%RH, 991hPa
TESTED BY	Match Tsui		

CHANNEL	CHANNEL FREQUENCY (MHz)	PEAK POWER OUTPUT (mW)	PEAK POWER OUTPUT (dBm)	PEAK POWER LIMIT (dBm)	PASS / FAIL
1	2412	50.466	17.03	30	PASS
6	2437	50.699	17.05	30	PASS
11	2462	32.211	15.08	30	PASS



DRAFT 802.11n (20MHz) OFDM MODULATION: SINGLE TX:

MODULATION TYPE	BPSK	TRANSFER RATE	7.2Mbps
INPUT POWER (SYSTEM)	120Vac, 60 Hz	ENVIRONMENTAL CONDITIONS	25deg.C, 63%RH, 991hPa
TESTED BY	Match Tsui		

CHANNEL	CHANNEL FREQUENCY (MHz)	PEAK POWER OUTPUT (mW)	PEAK POWER OUTPUT (dBm)	PEAK POWER LIMIT (dBm)	PASS / FAIL
1	2412	80.168	19.04	30	PASS
6	2437	80.538	19.06	30	PASS
11	2462	39.994	16.02	30	PASS

DRAFT 802.11n (20MHz) OFDM MODULATION: DUAL TX:

MODULATION TYPE	BPSK	TRANSFER RATE	14.444Mbps
INPUT POWER (SYSTEM)	120Vac, 60 Hz	ENVIRONMENTAL CONDITIONS	25deg.C, 63%RH, 991hPa
TESTED BY	Match Tsui		

CHANNEL	CHANNEL FREQUENCY (MHz)	PEAK POWER OUTPUT (mW)		PEAK POWER OUTPUT (dBm)		TOTAL PEAK POWER (mW)	TOTAL PEAK POWER (dBm)	PEAK POWER LIMIT (dBm)	PASS / FAIL
		CHAIN 0	CHAIN 1	CHAIN 0	CHAIN 1				
1	2412	51.050	50.582	17.08	17.04	101.633	20.07	30	PASS
6	2437	81.096	79.616	19.09	19.01	160.712	22.06	30	PASS
11	2462	20.417	20.137	13.10	13.04	40.555	16.08	30	PASS



DRAFT 802.11n (40MHz) OFDM MODULATION: SINGLE TX:

MODULATION TYPE	BPSK	TRANSFER RATE	15Mbps
INPUT POWER (SYSTEM)	120Vac, 60 Hz	ENVIRONMENTAL CONDITIONS	25deg.C, 63%RH, 991hPa
TESTED BY	Match Tsui		

CHANNEL	CHANNEL FREQUENCY (MHz)	PEAK POWER OUTPUT (mW)	PEAK POWER OUTPUT (dBm)	PEAK POWER LIMIT (dBm)	PASS / FAIL
1	2422	35.563	15.51	30	PASS
4	2437	35.645	15.52	30	PASS
7	2452	31.769	15.02	30	PASS

DRAFT 802.11n (40MHz) OFDM MODULATION: DUAL TX:

MODULATION TYPE	BPSK	TRANSFER RATE	30Mbps
INPUT POWER (SYSTEM)	120Vac, 60 Hz	ENVIRONMENTAL CONDITIONS	25deg.C, 63%RH, 991hPa
TESTED BY	Match Tsui		

CHANNEL	CHANNEL FREQUENCY (MHz)	PEAK POWER OUTPUT (mW)		PEAK POWER OUTPUT (dBm)		TOTAL PEAK POWER (mW)	TOTAL PEAK POWER (dBm)	PEAK POWER LIMIT (dBm)	PASS / FAIL
		CHAIN 0	CHAIN 1	CHAIN 0	CHAIN 1				
1	2422	32.285	32.063	15.09	15.06	64.348	18.09	30	PASS
4	2437	32.509	32.137	15.12	15.07	64.645	18.11	30	PASS
7	2452	25.942	25.293	14.14	14.03	51.235	17.10	30	PASS



4.5 POWER SPECTRAL DENSITY MEASUREMENT

4.5.1 LIMITS OF POWER SPECTRAL DENSITY MEASUREMENT

The Maximum of Power Spectral Density Measurement is 8dBm.

4.5.2 TEST INSTRUMENTS

DESCRIPTION & MANUFACTURER	MODEL NO.	SERIAL NO.	CALIBRATED UNTIL
R&S SPECTRUM ANALYZER	FSEK30	100049	Aug. 14, 2006

NOTE: The calibration interval of the above test instruments is 12 months and the calibrations are traceable to NML/ROC and NIST/USA.

4.5.3 TEST PROCEDURE

The transmitter output was connected to the spectrum analyzer through an attenuator, the bandwidth of the fundamental frequency was measured with the spectrum analyzer using 3kHz RBW and 30kHz VBW, set sweep time = span/3kHz. The power spectral density was measured and recorded.

The sweep time is allowed to be longer than span/3kHz for a full response of the mixer in the spectrum analyzer.

4.5.4 DEVIATION FROM TEST STANDARD

No deviation

4.5.5 TEST SETUP

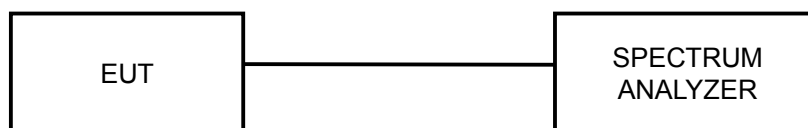

4.5.6 EUT OPERATING CONDITION

Same as Item 4.3.6

4.5.7 TEST RESULTS

802.11b DSSS MODULATION:

MODULATION TYPE	DBPSK	TRANSFER RATE	1Mbps
INPUT POWER (SYSTEM)	120Vac, 60 Hz	ENVIRONMENTAL CONDITIONS	25deg.C, 63%RH, 991hPa
TESTED BY	Match Tsui		

CHANNEL	CHANNEL FREQUENCY (MHz)	RF POWER LEVEL IN 3kHz BW (dBm)	MAXIMUM LIMIT (dBm)	PASS / FAIL
1	2412	-16.95	8	PASS
6	2437	-15.69	8	PASS
11	2462	-15.80	8	PASS

CH 1

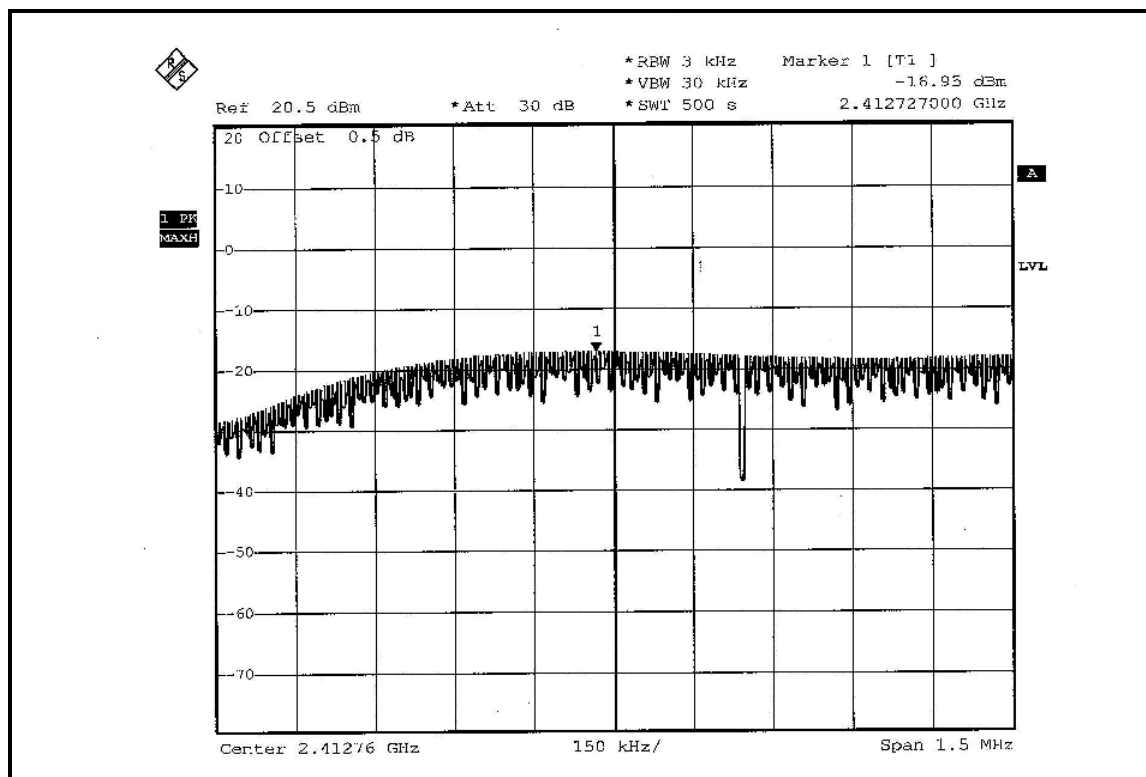

CH 6

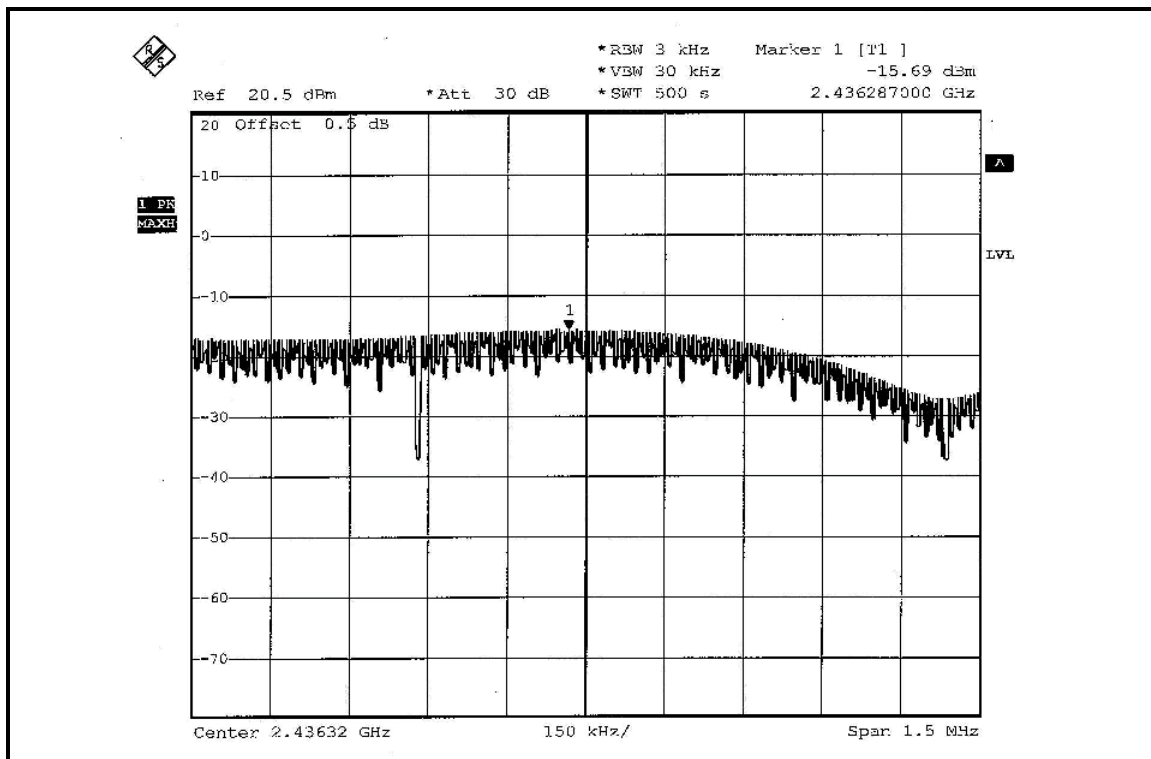

CH 11

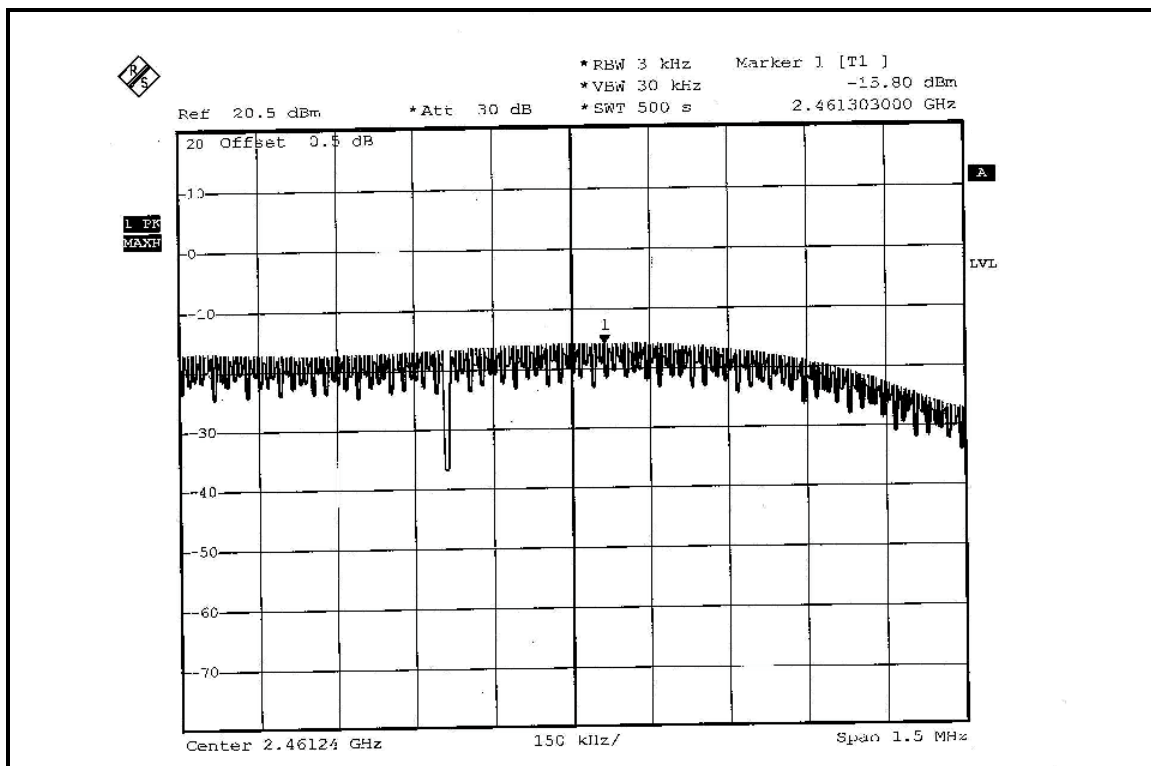

802.11g OFDM MODULATION:

MODULATION TYPE	BPSK	TRANSFER RATE	6Mbps
INPUT POWER (SYSTEM)	120Vac, 60 Hz	ENVIRONMENTAL CONDITIONS	25deg.C, 63%RH, 991hPa
TESTED BY	Match Tsui		

CHANNEL	CHANNEL FREQUENCY (MHz)	RF POWER LEVEL IN 3kHz BW (dBm)	MAXIMUM LIMIT (dBm)	PASS / FAIL
1	2412	-18.65	8	PASS
6	2437	-18.71	8	PASS
11	2462	-20.45	8	PASS

CH 1

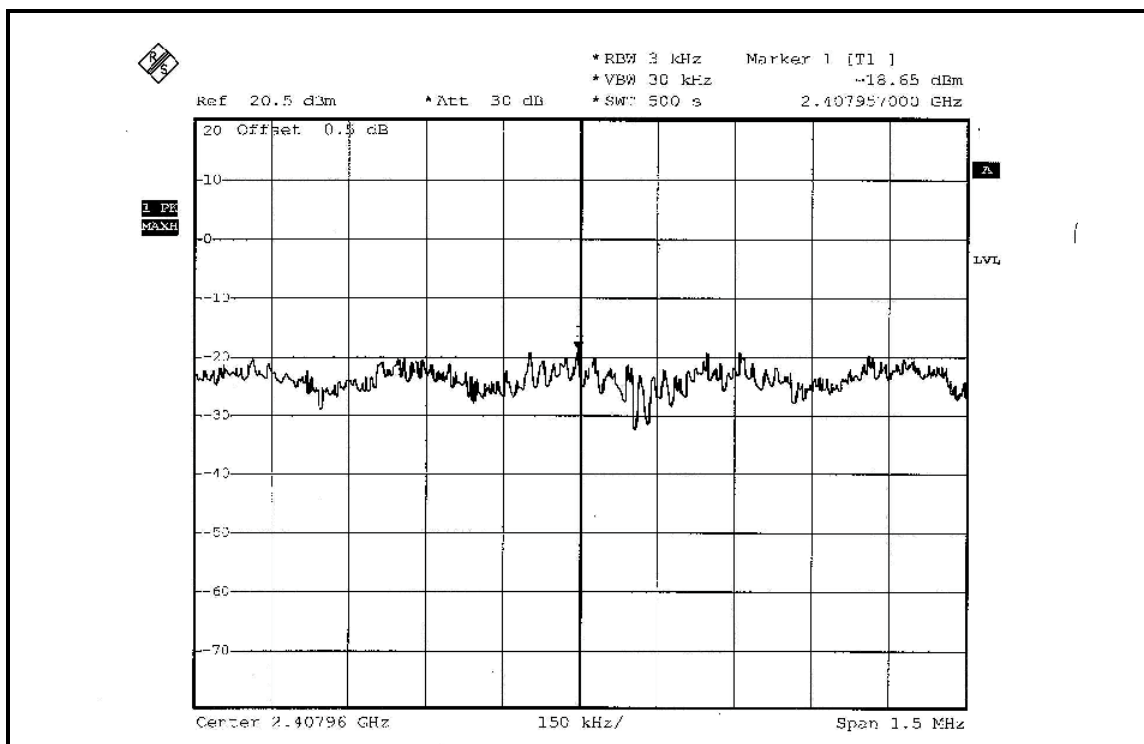

CH 6

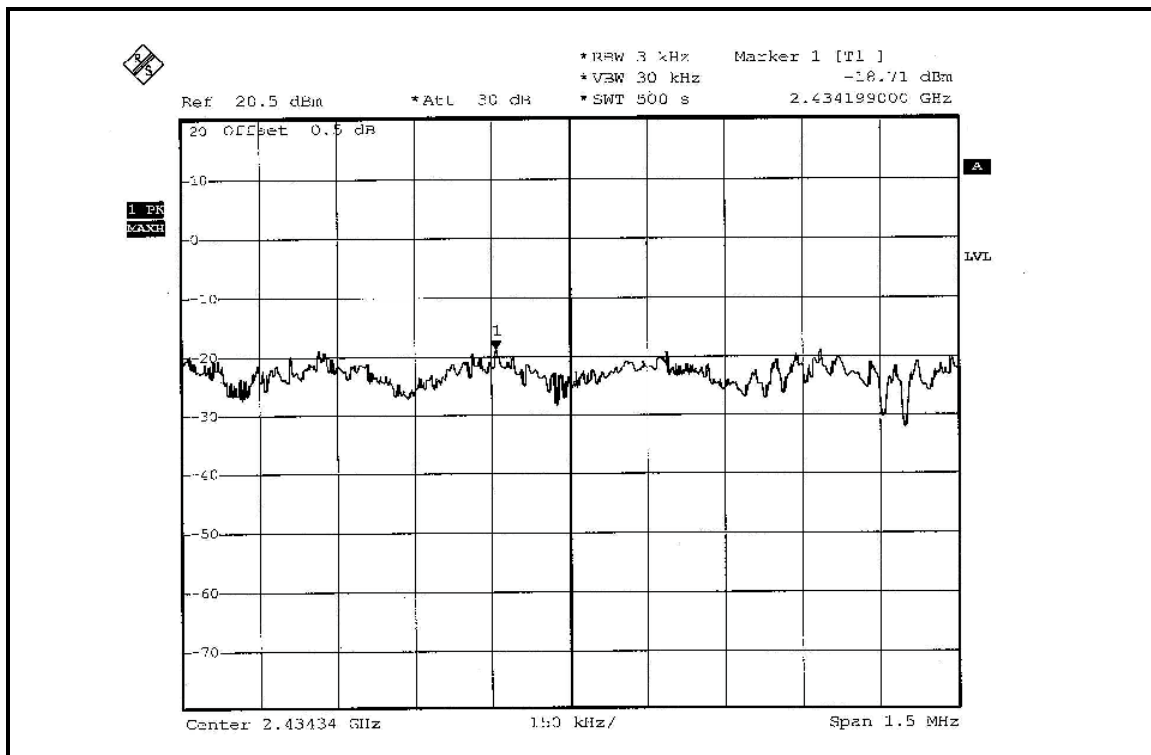

CH 11

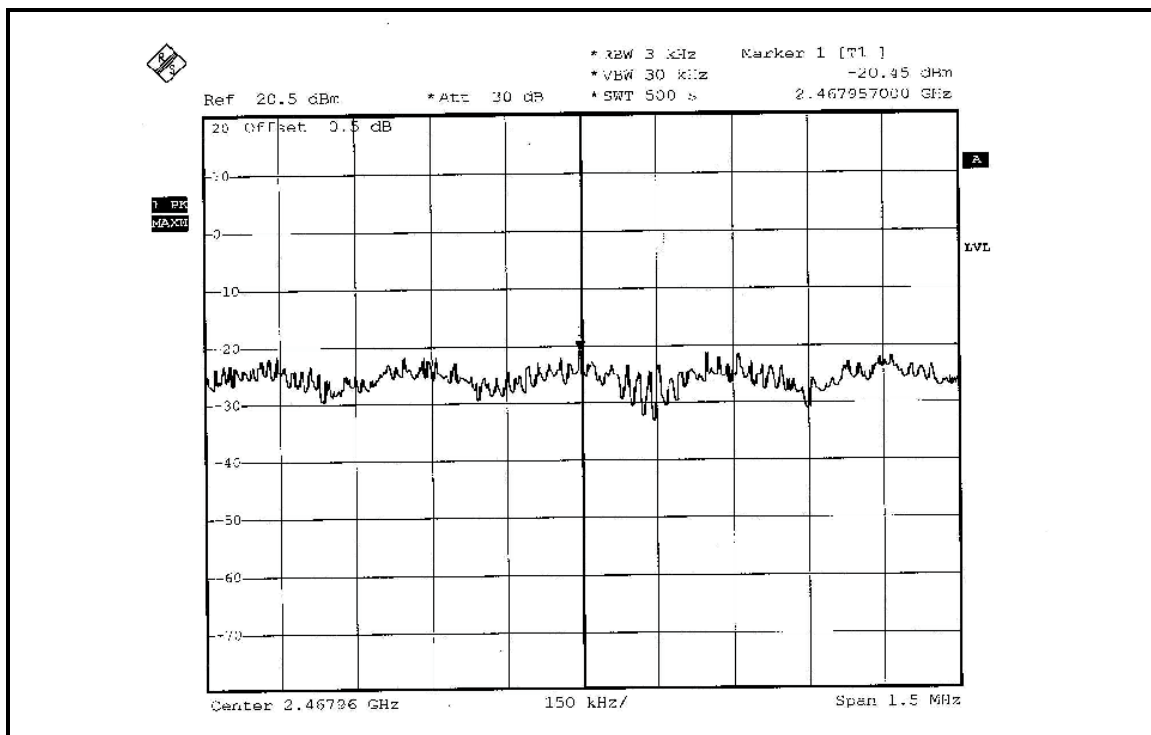

DRAFT 802.11n (20MHz) OFDM MODULATION: SINGLE TX:

MODULATION TYPE	BPSK	TRANSFER RATE	7.2Mbps
INPUT POWER (SYSTEM)	120Vac, 60 Hz	ENVIRONMENTAL CONDITIONS	25deg.C, 63%RH, 991hPa
TESTED BY	Match Tsui		

CHANNEL	CHANNEL FREQUENCY (MHz)	RF POWER LEVEL IN 3kHz BW (dBm)	MAXIMUM LIMIT (dBm)	PASS / FAIL
1	2412	-16.13	8	PASS
6	2437	-16.55	8	PASS
11	2462	-18.77	8	PASS

CH 1

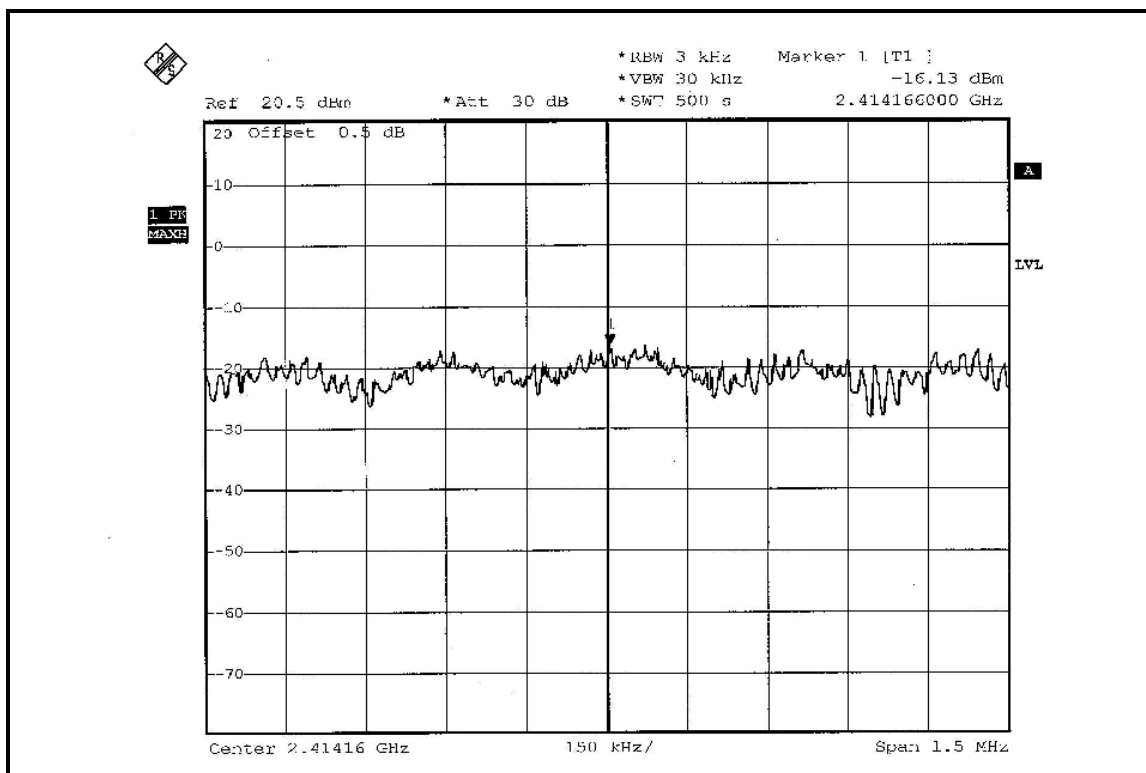

CH 6

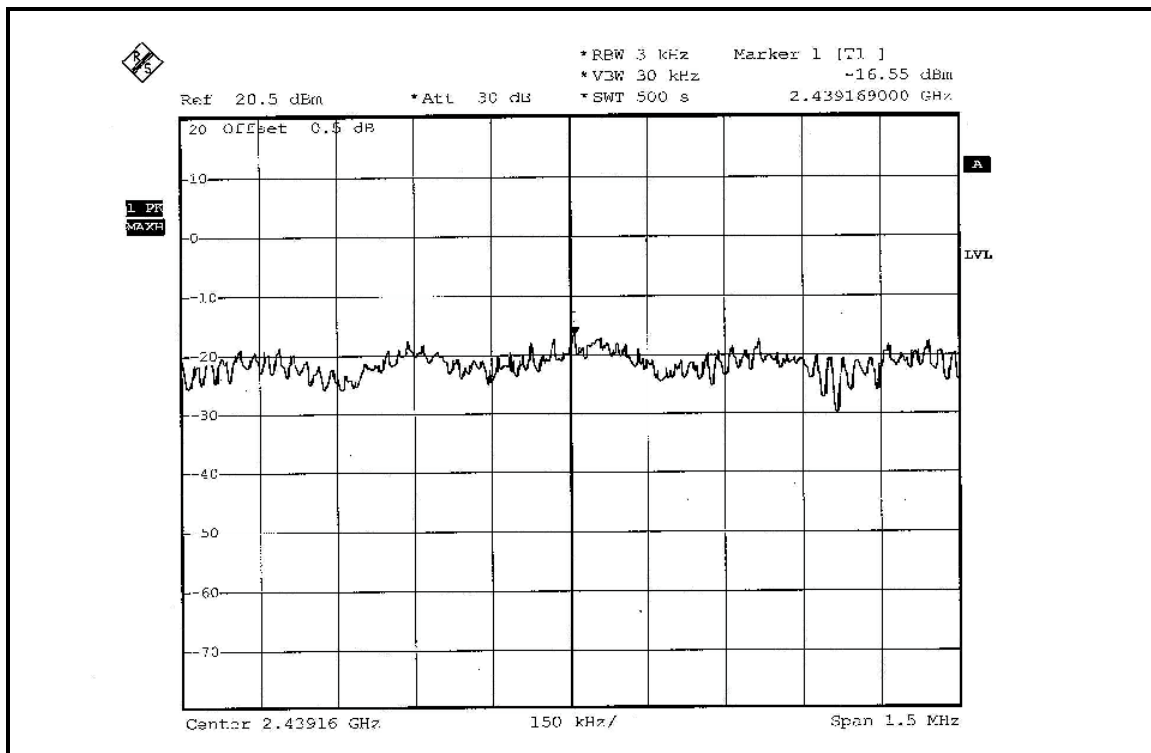

CH 11

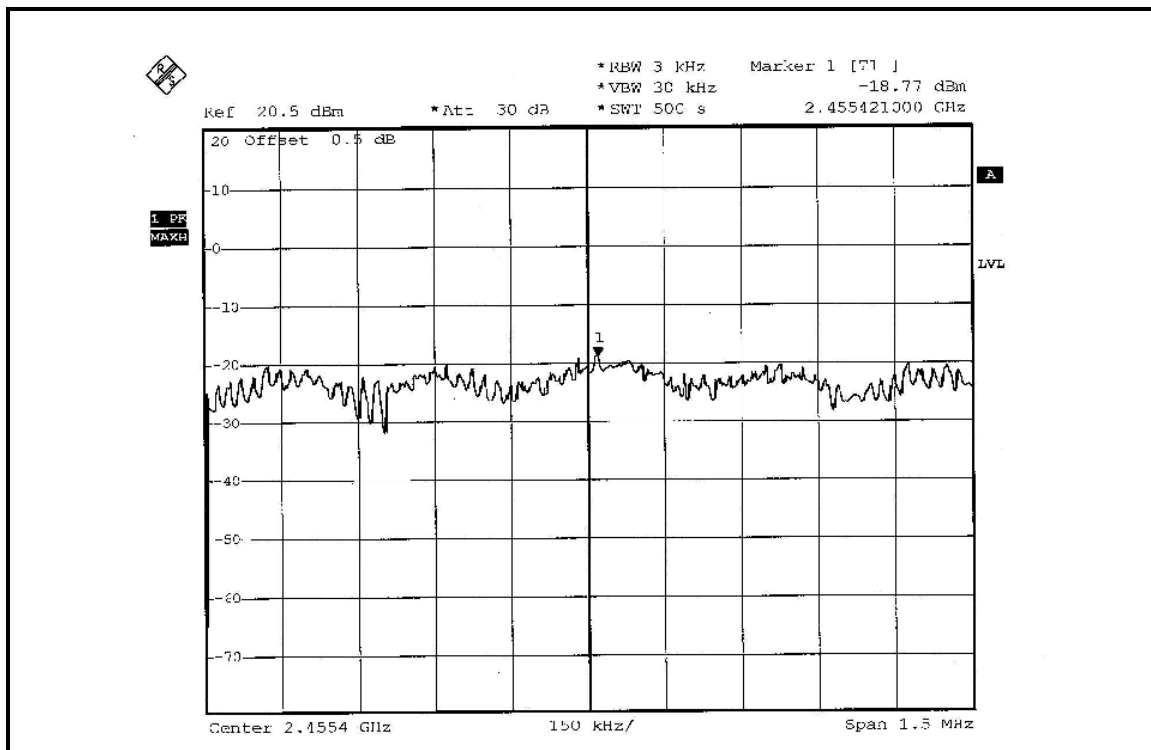



DRAFT 802.11n (20MHz) OFDM MODULATION: DUAL TX:

MODULATION TYPE	BPSK	TRANSFER RATE	14.444Mbps
INPUT POWER (SYSTEM)	120Vac, 60 Hz	ENVIRONMENTAL CONDITIONS	25deg.C, 63%RH, 991hPa
TESTED BY	Match Tsui		

CHANNEL	CHANNEL FREQUENCY (MHz)	RF POWER LEVEL IN 3kHz BW (dBm)		MAXIMUM LIMIT (dBm)	PASS / FAIL
		CHAIN 0	CHAIN 1		
1	2412	-17.48	-18.44	8	PASS
6	2437	-15.96	-16.12	8	PASS
11	2462	-21.72	-22.02	8	PASS

FOR CHAIN 0: CH 1

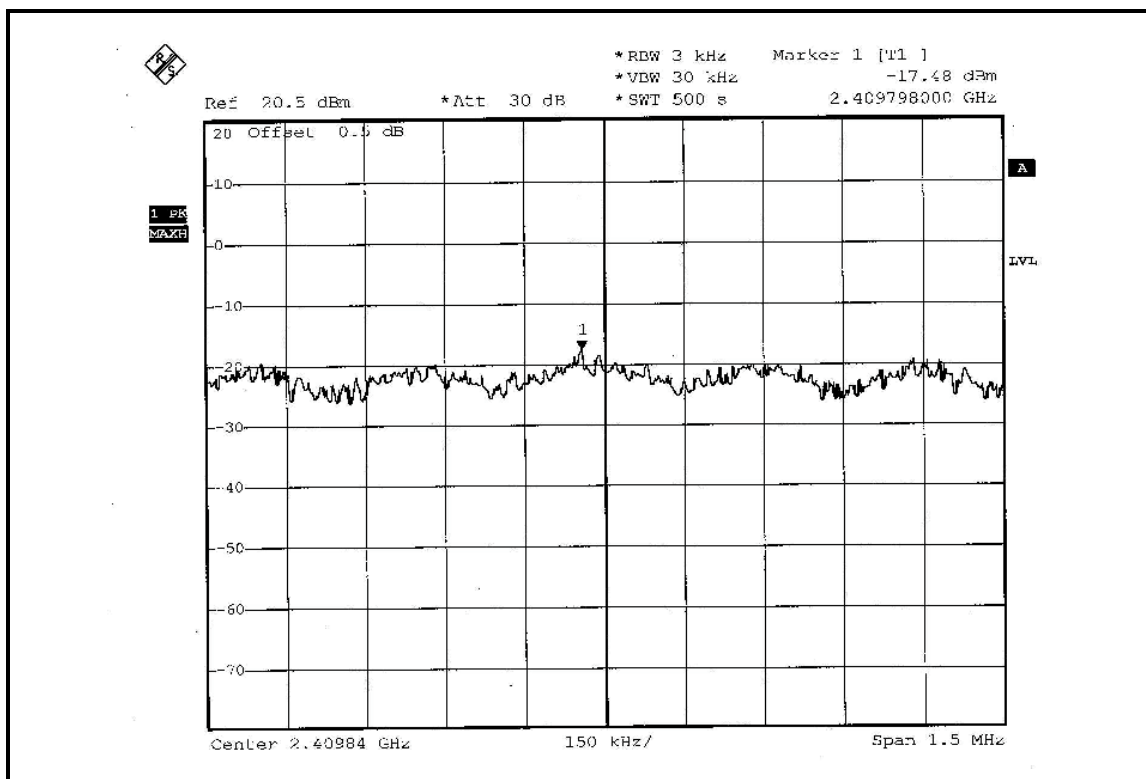

CH 6

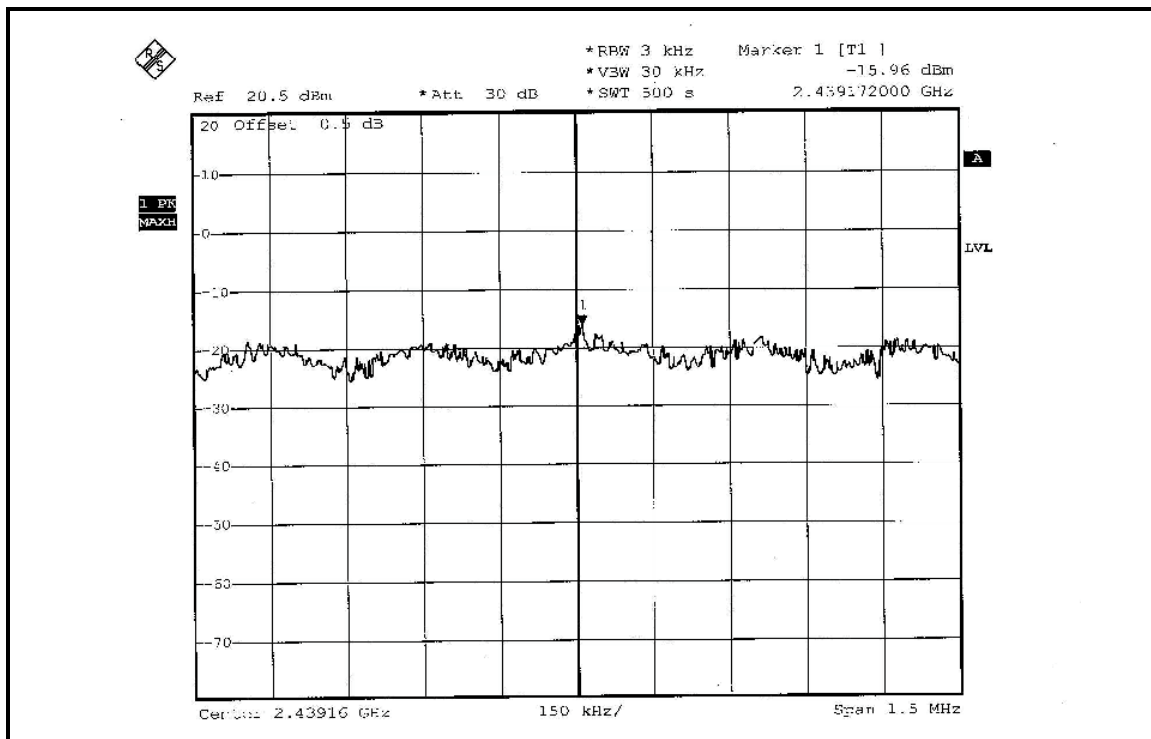

CH 11

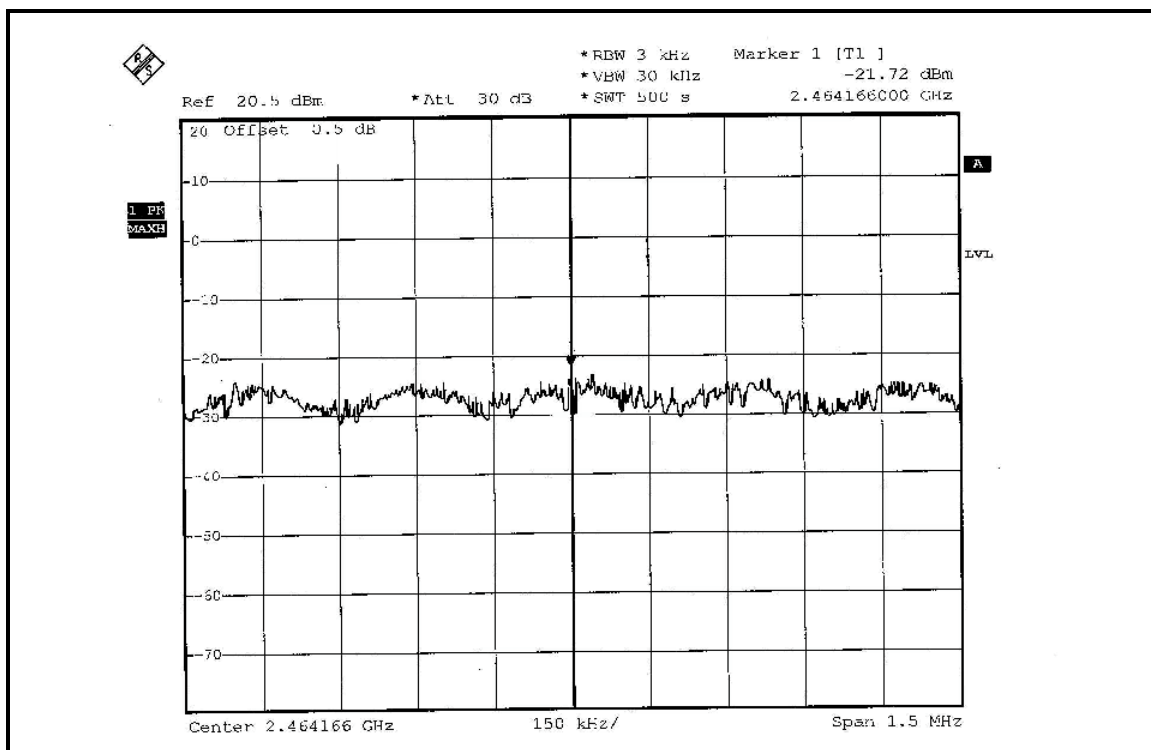

FOR CHAIN 1: CH 1

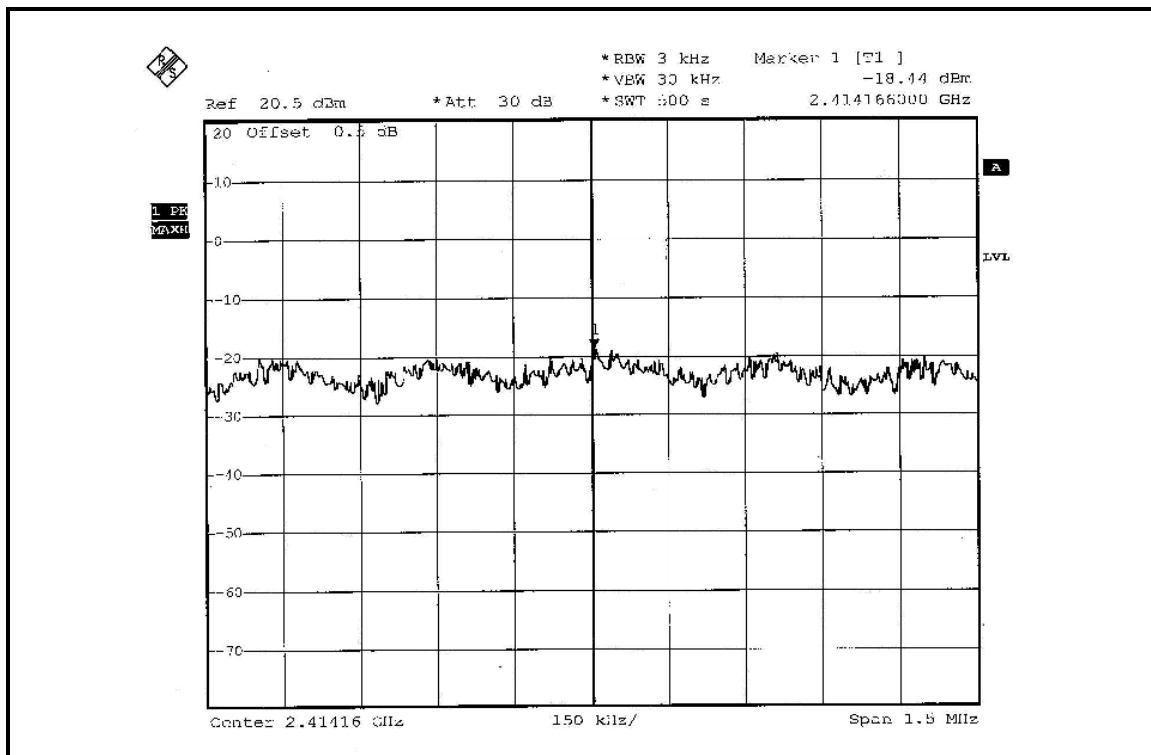

CH 6

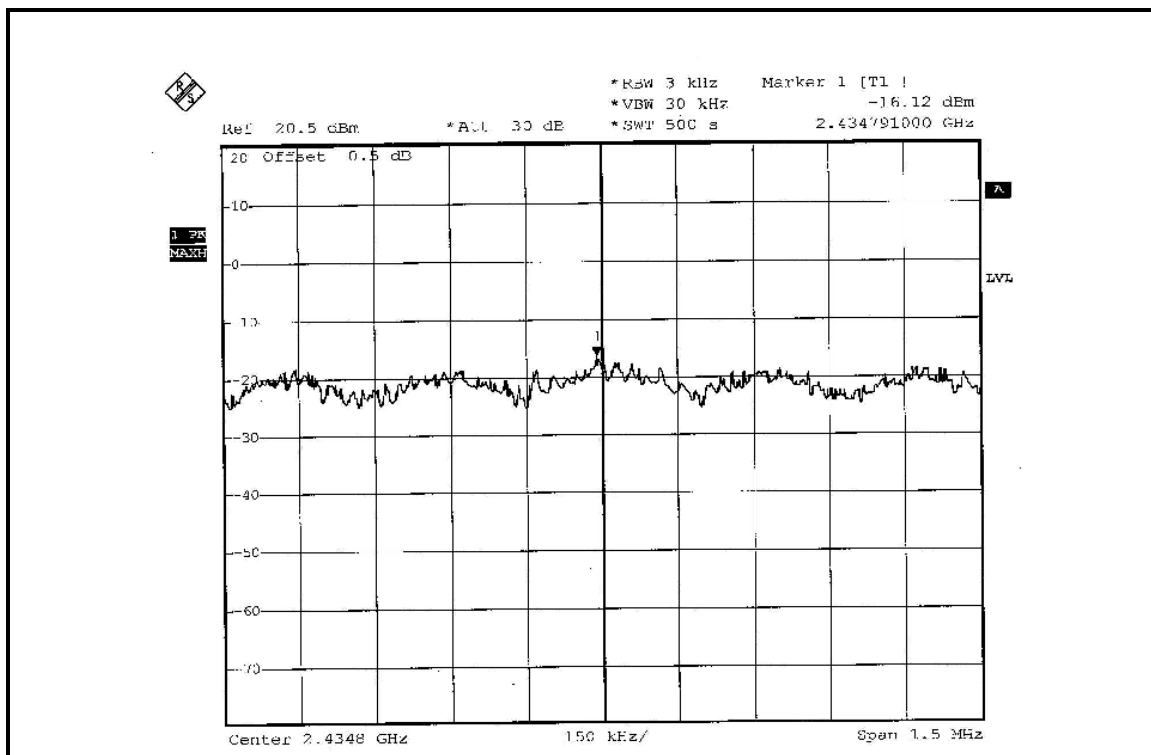

CH 11

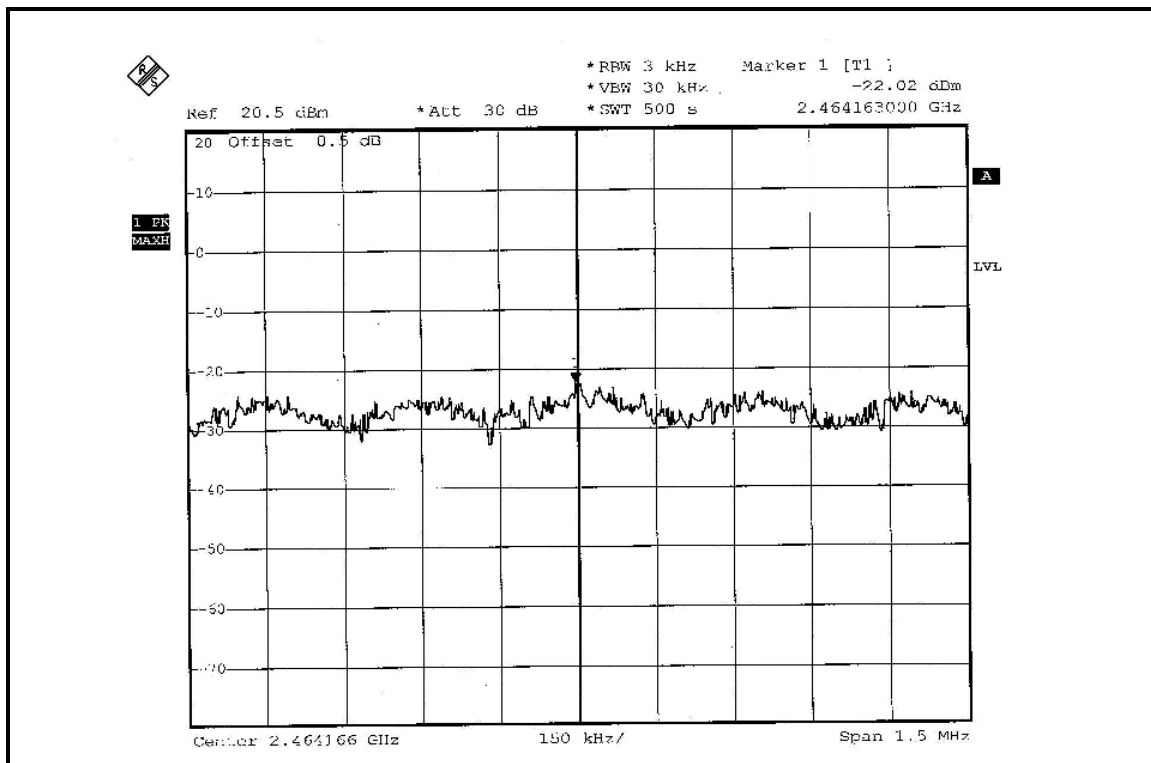

DRAFT 802.11n (40MHz) OFDM MODULATION: SINGLE TX:

MODULATION TYPE	BPSK	TRANSFER RATE	15Mbps
INPUT POWER (SYSTEM)	120Vac, 60 Hz	ENVIRONMENTAL CONDITIONS	25deg.C, 63%RH, 991hPa
TESTED BY	Match Tsui		

CHANNEL	CHANNEL FREQUENCY (MHz)	RF POWER LEVEL IN 3kHz BW (dBm)	MAXIMUM LIMIT (dBm)	PASS / FAIL
1	2422	-18.63	8	PASS
4	2437	-18.52	8	PASS
7	2452	-19.10	8	PASS

CH 1

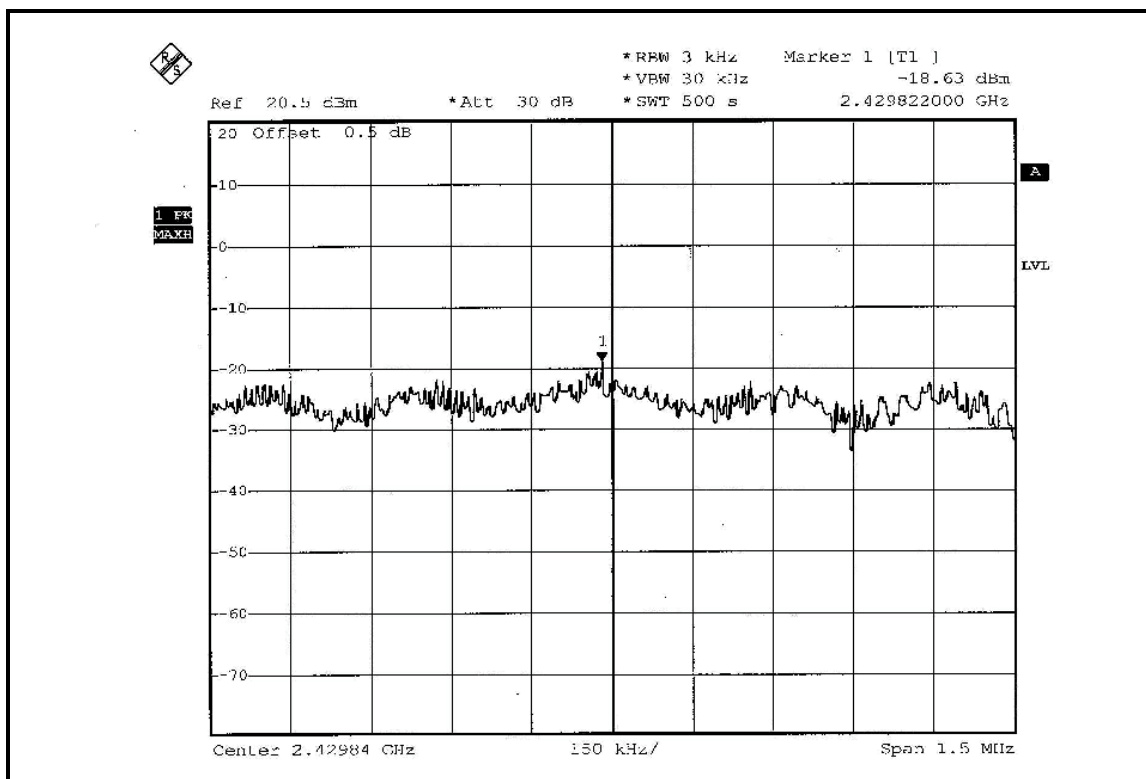

CH 4

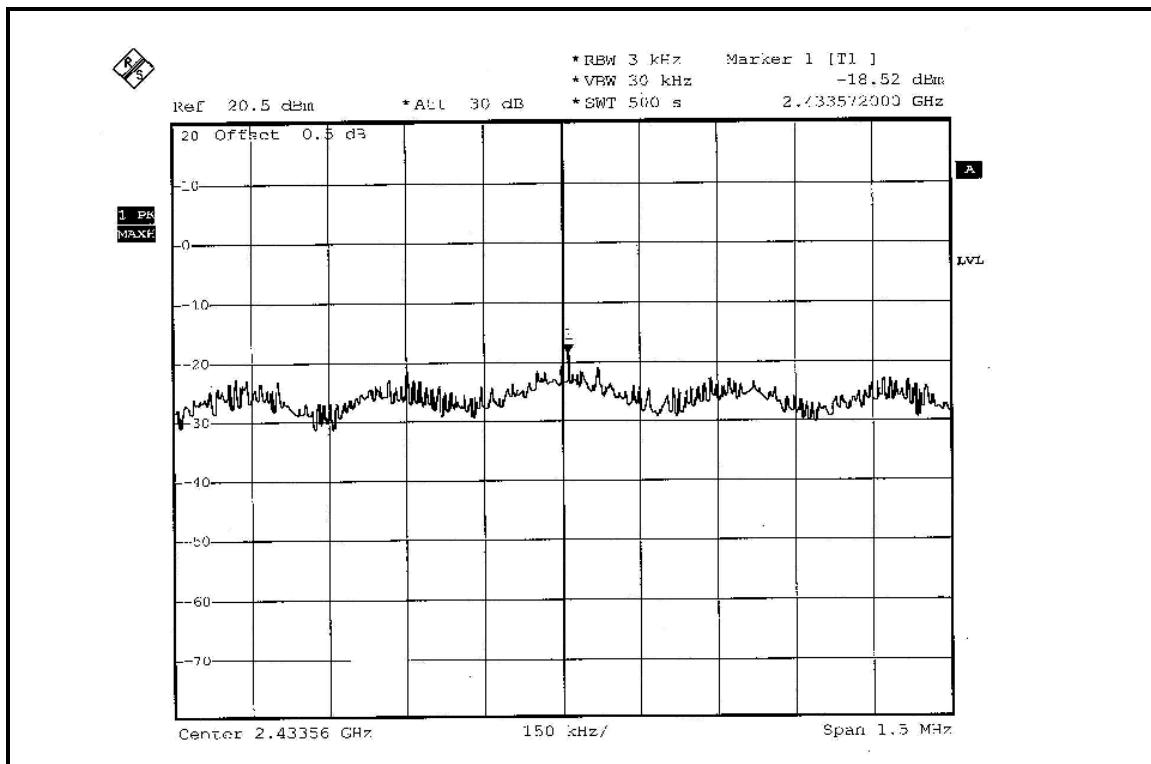

CH 7

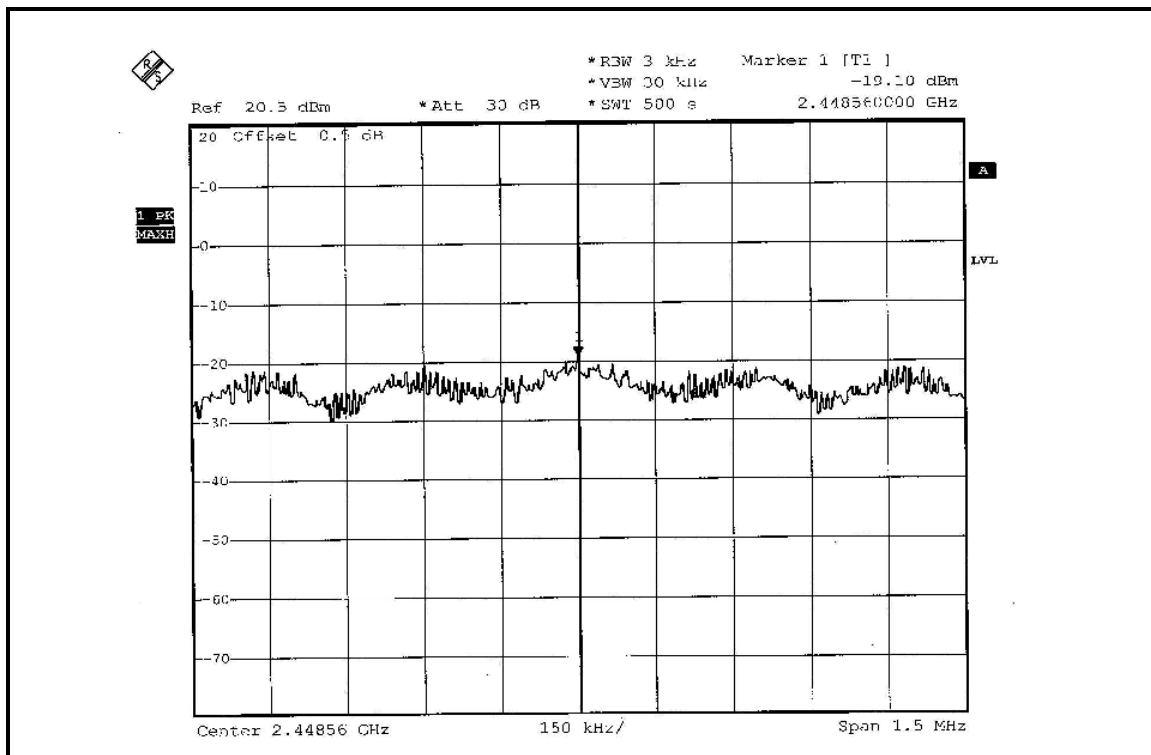



DRAFT 802.11n (40MHz) OFDM MODULATION: DUAL TX:

MODULATION TYPE	BPSK	TRANSFER RATE	30Mbps
INPUT POWER (SYSTEM)	120Vac, 60 Hz	ENVIRONMENTAL CONDITIONS	25deg.C, 63%RH, 991hPa
TESTED BY	Match Tsui		

CHANNEL	CHANNEL FREQUENCY (MHz)	RF POWER LEVEL IN 3kHz BW (dBm)		MAXIMUM LIMIT (dBm)	PASS / FAIL
		CHAIN 0	CHAIN 1		
1	2422	-20.55	-21.16	8	PASS
4	2437	-20.93	-21.11	8	PASS
7	2452	-21.78	-21.94	8	PASS

FOR CHAIN 0: CH 1

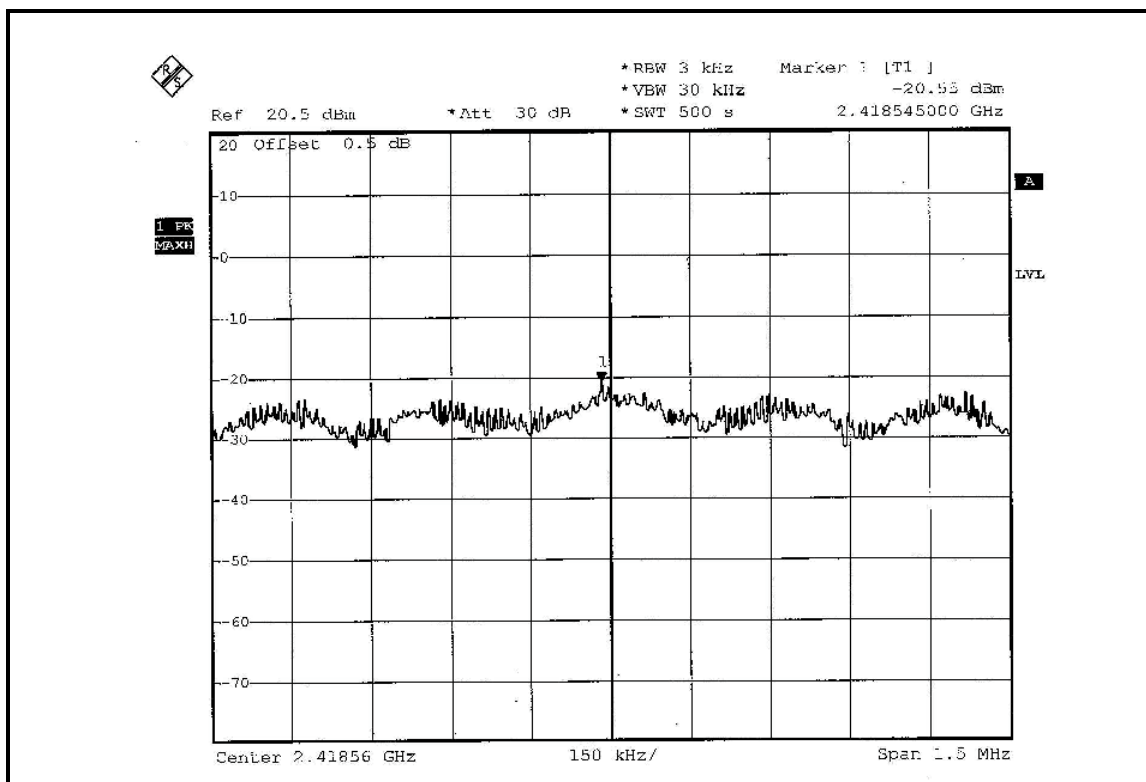

CH 4

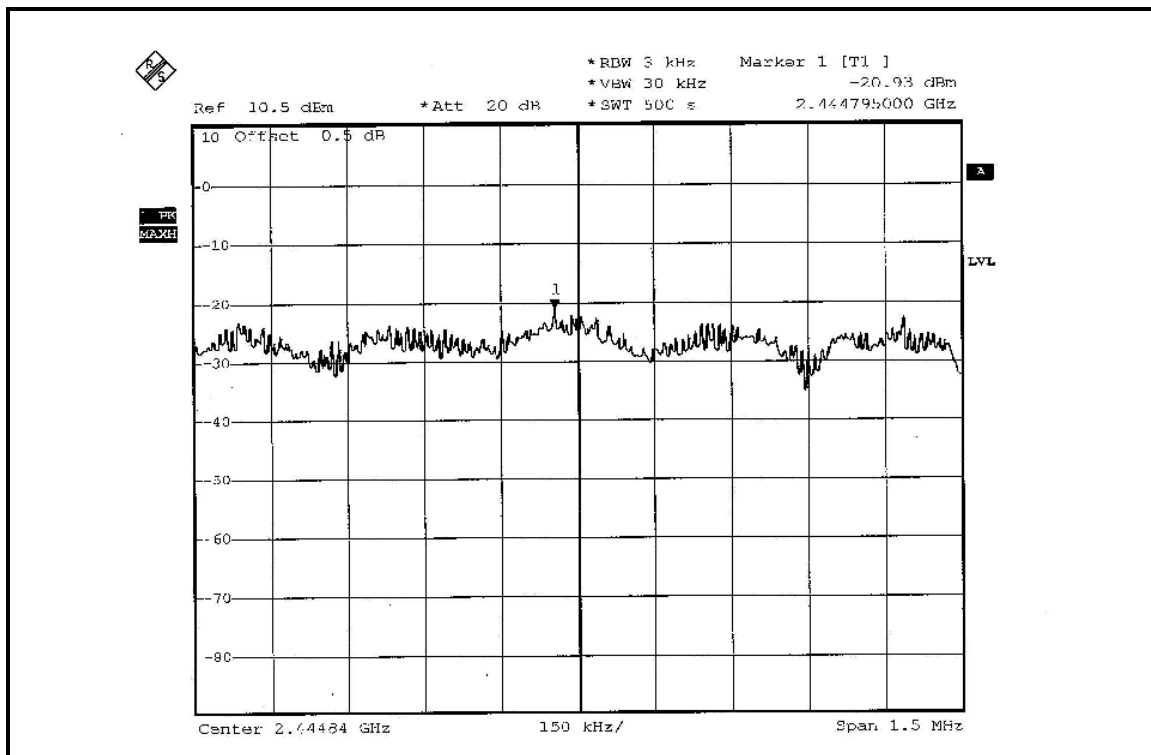

CH 7

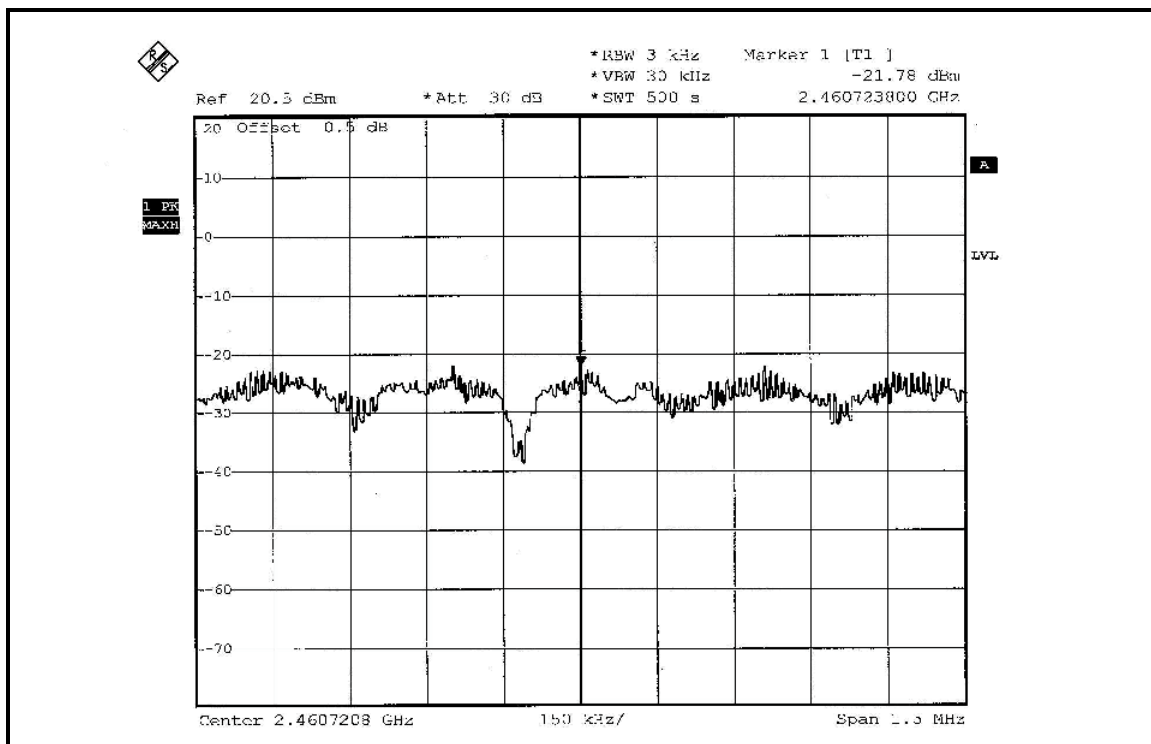

FOR CHAIN 1: CH 1

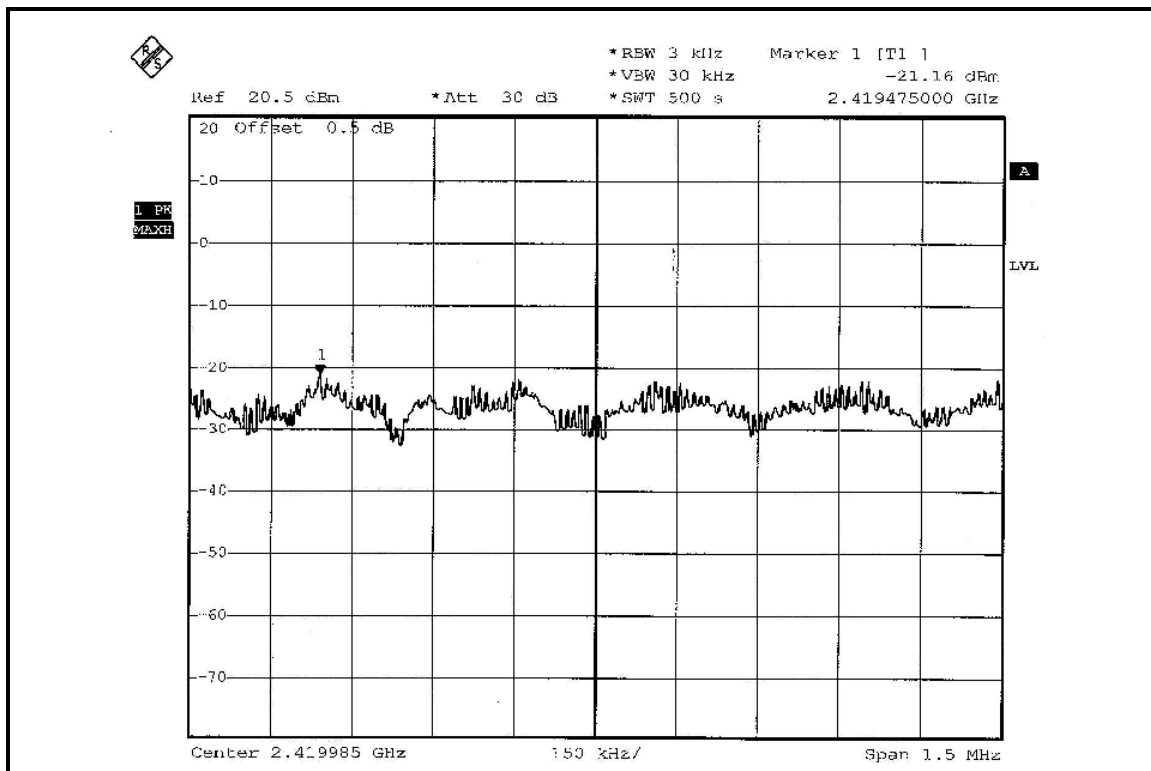

CH 4

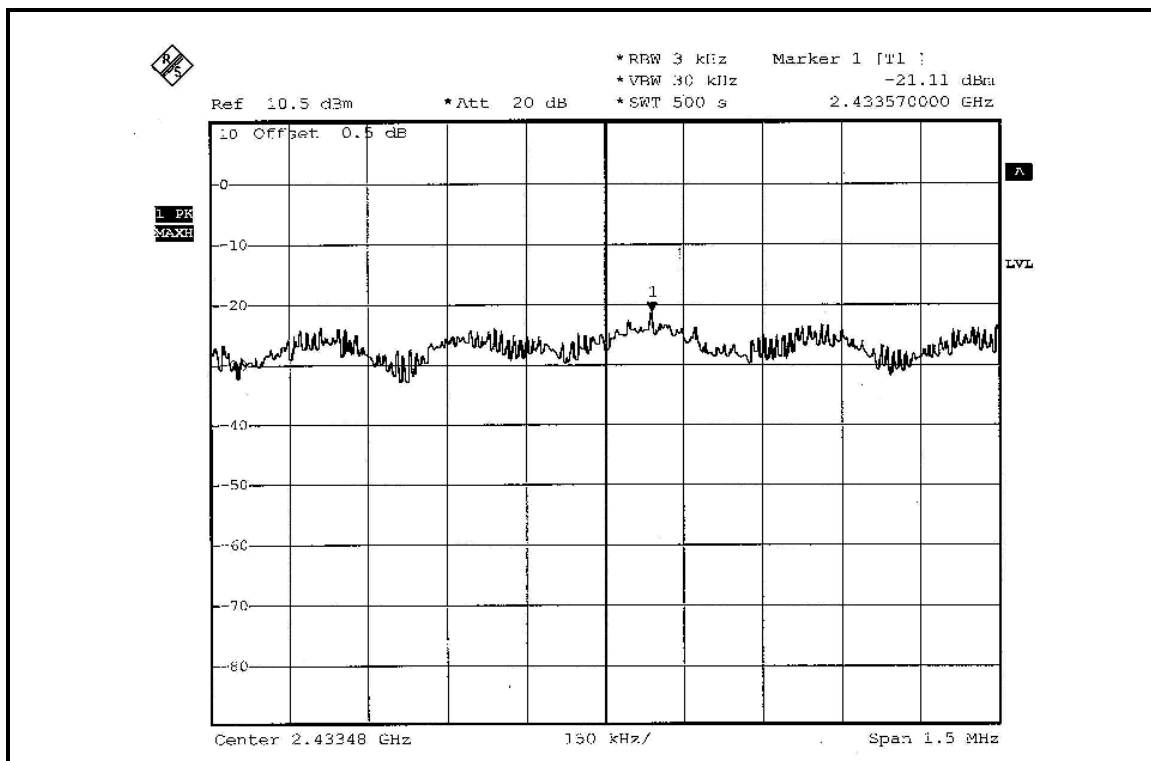

CH 7

