



FCC TEST REPORT (15.247)

REPORT NO.: 080814FIA01

MODEL NO.: DSL-2640U, DSL-G624B

RECEIVED: Aug. 06, 2008

TESTED: Aug. 06 ~Sept. 4, 2008

ISSUED: Aug. 26, 2008

APPLICANT: D-link Corporation

ADDRESS: No.289. Sinhu 3rd., Neihu District, Taipei City
114, Taiwan

ISSUED BY: ADT (Shanghai) Corporation

ADDRESS: 2F, Building C, No.1618, Yishan Rd., 201103,
Shanghai, China

This test report consists of 58 pages in total. It may be duplicated completely for legal use with the approval of the applicant. It should not be reproduced except in full, without the written approval of our laboratory. The client should not use it to claim product endorsement by TAF, A2LA or any government agencies. The test results in the report only apply to the tested sample.



TABLE OF CONTENTS

1. CERTIFICATION	3
2. SUMMARY OF TEST RESULTS	4
2.1 MEASUREMENT UNCERTAINTY	4
3. GENERAL INFORMATION.....	5
3.1 GENERAL DESCRIPTION OF EUT	5
3.2 DESCRIPTION OF TEST MODES.....	7
3.3 GENERAL DESCRIPTION OF APPLIED STANDARDS	11
3.4 DESCRIPTION OF SUPPORT UNITS	11
4. TEST TYPES AND RESULTS	12
4.1 RADIATED EMISSION MEASUREMENT	12
4.2 CONDUCTED EMISSION MEASUREMENT	23
4.3 6dB BANDWIDTH MEASUREMENT.....	28
4.4 MAXIMUM PEAK OUTPUT POWER	34
4.5 POWER SPECTRAL DENSITY MEASUREMENT	37
4.6 BAND EDGES MEASUREMENT	43
4.7 ANTENNA REQUIREMENT	49
5. PHOTOGRAPHS OF THE TEST CONFIGURATION.....	50
6. PHOTOGRAPHS OF THE EUT	52
7. APPENDIX A - INFORMATION ON THE TESTING LABORATORY	57
8. APPENDIX B - UNCERTAINTY IN EMC MEASUREMENT	58



1. CERTIFICATION

PRODUCT: Wireless ADSL2/2+ 4-port Ethernet Router

MODEL: DSL-2640U, DSL-G624B

BRAND: D-Link

APPLICANT: D-link Corporation

TEST SAMPLE: ENGINEERING SAMPLE

TESTED: Aug. 06 ~ Sept. 4, 2008

STANDARDS: FCC Part 15, Subpart C (Section 15.247)
ANSI C63.4-2003

The above equipment (Model: DSL-2640U, DSL-G624B) has been tested by **Advance Data Technology Corporation**, and found compliance with the requirement of the above standards. The test record, data evaluation & Equipment Under Test (EUT) configurations represented herein are true and accurate accounts of the measurements of the sample's EMC characteristics under the conditions specified in this report.

PREPARED BY : Lucy Tian , **DATE:** Sept. 5, 2008
Lucy Tian
Certification Engineer

TECHNICAL ACCEPTANCE : Joy Zhu , **DATE:** Sept. 5, 2008
Joy Zhu
Lab Manager

APPROVED BY : [Signature] , **DATE:** Sept. 5, 2008
Wallace Pan
Director of Operations



2. SUMMARY OF TEST RESULTS

The EUT has been tested according to the following specifications:

APPLIED STANDARD: FCC PART 15, SUBPART C (SECTION 15.247)			
STANDARD SECTION	TEST TYPE AND LIMIT	RESULT	REMARK
15.207	AC Power Conducted Emission	PASS	Meet the requirement of limit. Minimum passing margin is -4.91dB at 6.24MHz
15.247(a)(2)	Spectrum Bandwidth of a Direct Sequence Spread Spectrum System Limit: min. 500kHz	PASS	Meet the requirement of limit.
15.247(b)	Maximum Peak Output Power Limit: max. 30dBm	PASS	Meet the requirement of limit.
15.247(d)	Radiated Emissions Limit: Table 15.209	PASS	Meet the requirement of limit. Minimum passing margin is -1.69dB at 2483.50MHz
15.247(e)	Power Spectral Density Limit: max. 8dBm	PASS	Meet the requirement of limit.
15.247(d)	Band Edge Measurement Limit: 20dB less than the peak value of fundamental frequency	PASS	Meet the requirement of limit.

2.1 MEASUREMENT UNCERTAINTY

Where relevant, the following measurement uncertainty levels have been estimated for tests performed on the EUT as specified in CISPR 16-4-2:

MEASUREMENT	FREQUENCY	UNCERTAINTY
Conducted emissions	9kHz ~ 30MHz	2.55 dB
Radiated emissions	30MHz ~ 200MHz	2.98 dB
	200MHz ~ 1000MHz	2.96 dB
	1GHz ~18GHz	2.26 dB

Note: The measurement uncertainty is factored into the compliance determination. The additional information is listed on APPENDIX B of this report.



3. GENERAL INFORMATION

3.1 GENERAL DESCRIPTION OF EUT

EUT	Wireless ADSL2/2+ 4-port Ethernet Router
MODEL NO.	DSL-2640U, DSL-G624B
FCC ID	KA2DSL-G624B
POWER SUPPLY	Input: 100V - 240V AC, 50/60Hz, 0.5A; Output: +12V DC, 0.7A
MODULATION TYPE	CCK, DQPSK, DBPSK for DSSS 64QAM, 16QAM, QPSK, BPSK for OFDM
MODULATION TECHNOLOGY	DSSS, OFDM
TRANSFER RATE	802.11b: 11.0/ 5.5/ 2.0/ 1.0Mbps 802.11g: 54.0/ 48.0/ 36.0/ 24.0/ 18.0/ 12.0/ 9.0/ 6.0Mbps
FREQUENCY RANGE	2.4GHz: 2400 ~ 2483.5MHz
NUMBER OF CHANNEL	2.4GHz: 11 for 802.11b, 802.11g
OUTPUT POWER	CCK: 20.989mW, OFDM: 18.197mW
ANTENNA TYPE	2.4GHz: Monopole Antenna with 2.0dBi gain
I/O PORTS	LAN PORT*4, TELEPHONE PORT*1
ASSOCIATED DEVICES	Adapter

NOTE:

1. The frequency bands used in this EUT are listed as follows:

Frequency Band (MHz)	2412~2462
802.11b	√
802.11g	√



2. The EUT was powered by the following adapter:

BRAND:	DVE
MODEL:	DSA-15P-12 US 120084
INPUT:	100-240Vac, 50/60Hz, 0.5A
OUTPUT:	+12Vdc, 0.7A
POWER LINE:	1.4m non-shielded cable without core

3. The EUT provides only one antenna incorporate both transmitter and receiver..

MODULATION MODE	TX FUNCTION
802.11b	1TX
802.11g	1TX

4. The only difference between DSL-2640U and DSL-G624B is Model No..

5. The above EUT information was declared by manufacturer and for more detailed features description, please refer to the manufacturer's specifications or user's manual.



3.2 DESCRIPTION OF TEST MODES

11 channels are provided for 802.11b, 802.11g

CHANNEL	FREQUENCY	CHANNEL	FREQUENCY
1	2412MHz	7	2442MHz
2	2417MHz	8	2447MHz
3	2422MHz	9	2452MHz
4	2427MHz	10	2457MHz
5	2432MHz	11	2462MHz
6	2437MHz		

3.2.1 CONFIGURATION OF SYSTEM UNDER TEST

FOR CE TEST

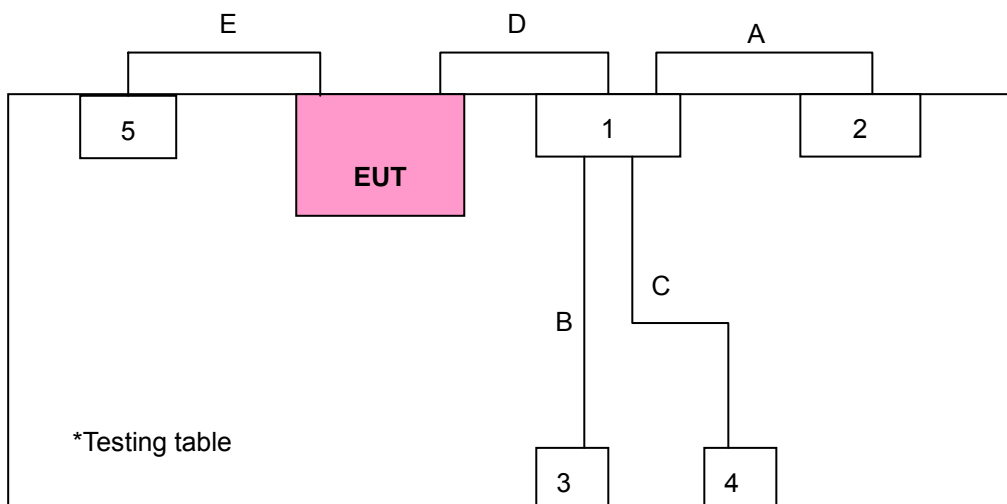

FOR RE TEST

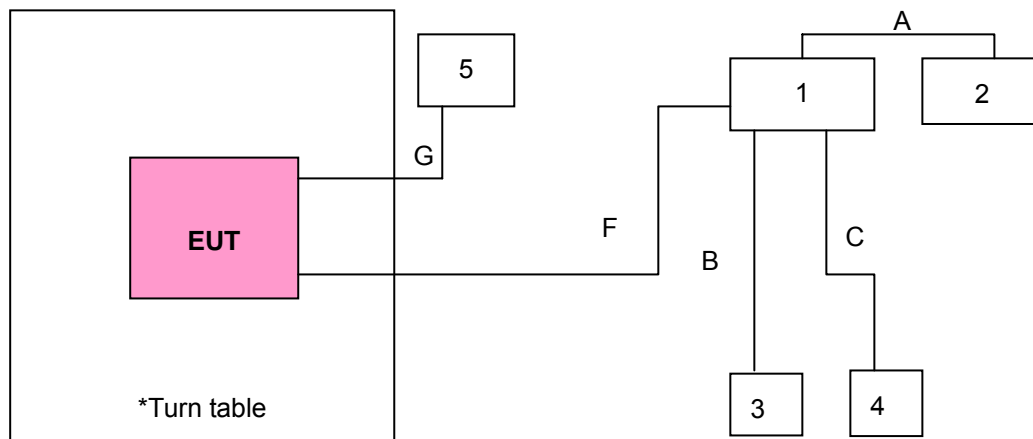

NOTE: For RE test, the DESLAM, PC, monitor, keyboard and mouse were out of the 966 chamber.



3.2.2 TEST MODE APPLICABILITY AND TESTED CHANNEL DETAIL

EUT CONFIGURE MODE	APPLICABLE TO				DESCRIPTION
	RE \geq 1G	RE<1G	PLC	APCM	
-	√	√	√	√	-

Where **RE \geq 1G**: Radiated Emission above 1GHz **RE<1G**: Radiated Emission below 1GHz
PLC: Power Line Conducted Emission **APCM**: Antenna Port Conducted Measurement

RADIATED EMISSION TEST (BELOW 1GHz):

- Pre-Scan has been conducted to determine the worst-case mode from all possible combinations between available modulations, data rates and antenna ports (if EUT with antenna diversity architecture).
- Following channel(s) was (were) selected for the final test as listed below.

MODE	AVAILABLE CHANNEL	TESTED CHANNEL	MODULATION TECHNOLOGY	MODULATION TYPE	DATA RATE (Mbps)
802.11b	1 to 11	1, 6, 11	DSSS	CCK	1.0
802.11g	1 to 11	1, 6, 11	OFDM	BPSK	6.0

RADIATED EMISSION TEST (ABOVE 1GHz):

- Pre-Scan has been conducted to determine the worst-case mode from all possible combinations between available modulations, data rates and antenna ports (if EUT with antenna diversity architecture).
- Following channel(s) was (were) selected for the final test as listed below.

MODE	AVAILABLE CHANNEL	TESTED CHANNEL	MODULATION TECHNOLOGY	MODULATION TYPE	DATA RATE (Mbps)
802.11b	1 to 11	1, 6, 11	DSSS	CCK	1.0
802.11g	1 to 11	1, 6, 11	OFDM	BPSK	6.0

POWER LINE CONDUCTED EMISSION TEST:

- Pre-Scan has been conducted to determine the worst-case mode from all possible combinations between available modulations, data rates and antenna ports (if EUT with antenna diversity architecture).
- Following channel(s) was (were) selected for the final test as listed below.

MODE	AVAILABLE CHANNEL	TESTED CHANNEL	MODULATION TECHNOLOGY	MODULATION TYPE	DATA RATE (Mbps)
802.11b	1 to 11	1	DSSS	CCK	1.0



BANDEDGE MEASUREMENT:

- Pre-Scan has been conducted to determine the worst-case mode from all possible combinations between available modulations, data rates and antenna ports (if EUT with antenna diversity architecture).
- Following channel(s) was (were) selected for the final test as listed below.

MODE	AVAILABLE CHANNEL	TESTED CHANNEL	MODULATION TECHNOLOGY	MODULATION TYPE	DATA RATE (Mbps)
802.11b	1 to 11	1, 11	DSSS	CCK	1.0
802.11g	1 to 11	1, 11	OFDM	BPSK	6.0

ANTENNA PORT CONDUCTED MEASUREMENT:

- Pre-Scan has been conducted to determine the worst-case mode from all possible combinations between available modulations, data rates and antenna ports (if EUT with antenna diversity architecture).
- Following channel(s) was (were) selected for the final test as listed below.

MODE	AVAILABLE CHANNEL	TESTED CHANNEL	MODULATION TECHNOLOGY	MODULATION TYPE	DATA RATE (Mbps)
802.11b	1 to 11	1, 6, 11	DSSS	CCK	1.0
802.11g	1 to 11	1, 6, 11	OFDM	BPSK	6.0



3.3 GENERAL DESCRIPTION OF APPLIED STANDARDS

The EUT is a RF Product. According to the specifications of the manufacturer, it must comply with the requirements of the following standards:

FCC Part 15, Subpart C (15.247)

ANSI C63.4-2003

All test items have been performed and recorded as per the above standards.

NOTE: The EUT is also considered as a kind of computer peripheral, because the connection to computer is necessary for typical use. It has been verified to comply with the requirements of FCC Part 15, Subpart B, Class B (DoC). The test report has been issued separately.

3.4 DESCRIPTION OF SUPPORT UNITS

The EUT has been tested as an independent unit together with other necessary accessories or support units. The following support units or accessories were used to form a representative test configuration during the tests.

NO.	PRODUCT	BRAND	MODEL NO.	FCC ID
1	PC	IBM	8705	FCC DoC Approved
2	Monitor	BenQ	Q7T6	FCC DoC Approved
3	Keyboard	Dell	SK-8115	FCC DoC Approved
4	Mouse	Lenovo	MO28UOL	FCC DoC Approved
5	DESLAM	ZYXEL	ZP express ZES-1000	N/A

NO.	SIGNAL CABLE DESCRIPTION OF THE ABOVE SUPPORT UNITS
A	1.2m shielded VGA cable
B	1.5m shielded PS2 cable
C	1.5m shielded USB cable
D	1m non-shielded Ethernet cable
E	1m non-shielded line cable
F	10m non-shielded Ethernet cable
G	10m non-shielded line cable



4. TEST TYPES AND RESULTS

4.1 RADIATED EMISSION MEASUREMENT

4.1.1 LIMITS OF RADIATED EMISSION MEASUREMENT

Emissions radiated outside of the specified bands, shall be according to the general radiated limits in 15.209 as following:

FREQUENCIES (MHz)	FIELD STRENGTH (microvolts/meter)	MEASUREMENT DISTANCE (meters)
0.009 ~ 0.490	2400/F(kHz)	300
0.490 ~ 1.705	24000/F(kHz)	30
1.705 ~ 30.0	30	30
30 ~ 88	100	3
88 ~ 216	150	3
216 ~ 960	200	3
Above 960	500	3

NOTE:

1. The lower limit shall apply at the transition frequencies.
2. Emission level (dBuV/m) = 20 log Emission level (uV/m).
3. As shown in 15.35(b), for frequencies above 1000MHz, the field strength limits are based on average detector, however, the peak field strength of any emission shall not exceed the maximum permitted average limits, specified above by more than 20dB under any condition of modulation.



4.1.2 TEST INSTRUMENTS

DESCRIPTION & MANUFACTURER	MODEL NO.	SERIAL NO.	CALIBRATED UNTIL
Spectrum Agilent	E4403B	E1S1001	Jul. 31, 2009
Receiver R&S	ESCS30	E1R1001	Oct. 31, 2009
Trilog Broadband Antenna Schwarzbeck	VULB 9168	E1A1001	Aug. 31, 2009
Double Ridged Broadband Horn Antenna Schwarzbeck	BBHA 9120D	E1A1002	Jul. 31, 2009
Preamplifier Agilent	HP 8447D-CFG001	E1A2001	Jul. 31, 2010
Signal Analyzer ROHDE & SCHWARZ	FSP30	E1S1002	Aug. 1, 2009
RF signal cable Woken	RG-402	E1CBH01	May. 30, 2009
RF signal cable Woken	RG-412	E1CBL02	May. 30, 2009
RF signal cable Woken	RG-412	E1CBL03	May. 30, 2009
RF signal cable Woken	RG-412	E1CBL04	May. 30, 2009
Software ADT	ADT_Radiated_V7.5	N/A	N/A



4.1.3 TEST PROCEDURES

- a. The EUT was placed on the top of a rotating table 0.8 meters above the ground at a 3 meters semi-anechoic chamber. The table was rotated 360 degrees to determine the position of the highest radiation.
- b. The EUT was set 3 meters away from the interference-receiving antenna, which was mounted on the top of a variable-height antenna tower.
- c. The antenna is a broadband antenna, and its height is varied from one meter to four meters above the ground to determine the maximum value of the field strength. Both horizontal and vertical polarizations of the antenna are set to make the measurement.
- d. For each suspected emission, the EUT was arranged to its worst case and then the antenna was tuned to heights from 1 meter to 4 meters and the rotatable table was turned from 0 degrees to 360 degrees to find the maximum reading.
- e. The test-receiver system was set to Peak Detect Function and Specified Bandwidth with Maximum Hold Mode.
- f. If the emission level of the EUT in peak mode was lower than the limit specified, then testing could be stopped and the peak values of the EUT would be reported. Otherwise the emissions would be re-tested one by one using peak, quasi-peak or average method as specified and then reported in a data sheet.

NOTE:

1. The resolution bandwidth and video bandwidth of test receiver/spectrum analyzer is 120kHz for Quasi-peak detection at frequency below 1GHz.
2. The resolution bandwidth of test receiver/spectrum analyzer is 1MHz and video bandwidth is 3MHz for Peak detection at frequency above 1GHz.
3. The resolution bandwidth of test receiver/spectrum analyzer is 1MHz and the video bandwidth is 10Hz for Average detection (AV) at frequency above 1GHz.
4. All modes of operation were investigated and the worst-case emissions are reported.

4.1.4 DEVIATION FROM TEST STANDARD

No deviation

4.1.5 TEST SETUP

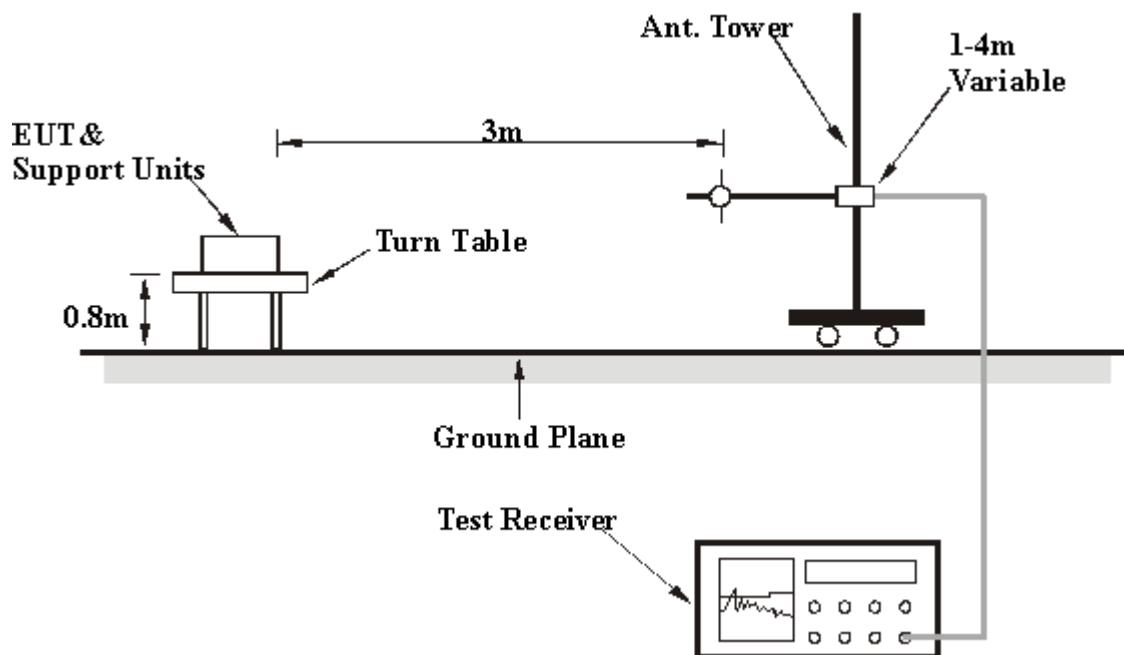

For the actual test configuration, please refer to the attached file (Test Setup Photo).

4.1.6 EUT OPERATING CONDITIONS

- a. Set up PC as the usual configuration.
- b. Link EUT's "LINE" port with the DESLAM and the "Ethernet" port to PC's Ethernet port, change the PC's IP address auto getting.
- c. Ping the EUT's IP address "192.168.1.1" and the DESLAM's address "192.168.1.254" by PC.
- d. Use special order to change EUT's emission channel in DOS system then do the test.



4.1.7 TEST RESULTS

802.11b DSSS MODULATION

EUT TEST CONDITION		MEASUREMENT DETAIL	
CHANNEL	Channel 1	FREQUENCY RANGE	1 ~ 25GHz
INPUT POWER (SYSTEM)	120Vac, 60 Hz	DETECTOR FUNCTION	Peak (PK) Average (AV)
ENVIRONMENTAL CONDITIONS	24deg. C, 70%RH 999hPa	TESTED BY	Rainy Wu

ANTENNA POLARITY & TEST DISTANCE: HORIZONTAL AT 3 M								
No.	Freq. (MHz)	Correction Factor (dB/m)	Raw Value (dBuV)	Emission Level (dBuV/m)	Limit (dBuV/m)	Margin (dB)	Antenna Height (cm)	Table Angle (Degree)
1	2390.00	32.59	28.20	60.79 PK	74.00	-13.21	100.00	0.00
2	4824.00	37.82	4.14	41.96 PK	74.00	-32.04	100.00	0.00
3	7236.00	44.64	3.87	48.50 PK	74.00	-25.50	100.00	0.00
4	9648.00	47.23	4.26	51.48 PK	74.00	-22.52	100.00	0.00
5	2390.00	32.59	17.05	49.63 AV	54.00	-4.37	100.00	0.00
6	4824.00	37.82	-6.65	31.17 AV	54.00	-22.83	100.00	20.00
7	7236.00	44.64	-6.95	37.68 AV	54.00	-16.32	100.00	20.00
8	9648.00	47.23	-6.78	40.44 AV	54.00	-13.56	100.00	20.00
ANTENNA POLARITY & TEST DISTANCE: VERTICAL AT 3 M								
No.	Freq. (MHz)	Correction Factor (dB/m)	Raw Value (dBuV)	Emission Level (dBuV/m)	Limit (dBuV/m)	Margin (dB)	Antenna Height (cm)	Table Angle (Degree)
1	2390.00	32.59	33.36	65.95 PK	74.00	-8.05	100.00	0.00
2	4824.04	37.82	4.43	42.25 PK	74.00	-31.75	100.00	0.00
3	7236.00	44.64	3.57	48.20 PK	74.00	-25.80	100.00	353.00
4	9648.00	47.23	3.60	50.83 PK	74.00	-23.17	100.00	20.00
5	2390.00	32.59	18.05	50.64 AV	54.00	-3.36	100.00	0.00
6	4824.00	37.82	-6.54	31.28 AV	54.00	-22.72	100.00	0.00
7	7236.00	44.64	-6.97	37.66 AV	54.00	-16.34	100.00	0.00
8	9648.00	47.23	-6.63	40.59 AV	54.00	-13.41	100.00	0.00

- REMARKS:**
1. Emission level (dBuV/m) = Raw Value (dBuV) + Correction Factor (dB/m).
 2. Correction Factor (dB/m) = Antenna Factor (dB/m) + Cable Factor (dB).
 3. The other emission levels were very low against the limit.
 4. Margin value = Emission level – Limit value.



EUT TEST CONDITION		MEASUREMENT DETAIL	
CHANNEL	Channel 6	FREQUENCY RANGE	1 ~ 25GHz
INPUT POWER (SYSTEM)	120Vac, 60 Hz	DETECTOR FUNCTION	Peak (PK) Average (AV)
ENVIRONMENTAL CONDITIONS	24deg. C, 70%RH 999hPa	TESTED BY	Rainy Wu

ANTENNA POLARITY & TEST DISTANCE: HORIZONTAL AT 3 M								
No.	Freq. (MHz)	Correction Factor (dB/m)	Raw Value (dBuV)	Emission Level (dBuV/m)	Limit (dBuV/m)	Margin (dB)	Antenna Height (cm)	Table Angle (Degree)
1	4872.00	38.00	4.16	42.17 PK	74.00	-31.83	100.00	20.00
2	7311.00	44.65	4.09	48.75 PK	74.00	-25.25	100.00	20.00
3	9748.00	47.48	4.00	51.48 PK	74.00	-22.52	100.00	20.00
4	4874.00	38.00	-6.54	31.46 AV	54.00	-22.54	100.00	57.00
5	7311.00	44.65	-7.01	37.64 AV	54.00	-16.36	100.00	10.00
6	9748.00	47.48	-6.74	40.75 AV	54.00	-13.25	100.00	0.00
ANTENNA POLARITY & TEST DISTANCE: VERTICAL AT 3 M								
No.	Freq. (MHz)	Correction Factor (dB/m)	Raw Value (dBuV)	Emission Level (dBuV/m)	Limit (dBuV/m)	Margin (dB)	Antenna Height (cm)	Table Angle (Degree)
1	4874.00	38.00	3.98	41.98 PK	74.00	-32.02	100.00	0.00
2	7311.00	44.65	5.22	49.87 PK	74.00	-24.13	100.00	0.00
3	9748.00	47.48	4.51	52.00 PK	74.00	-22.00	100.00	0.00
4	4874.00	38.00	-6.62	31.39 AV	54.00	-22.61	100.00	304.00
5	7311.00	44.65	-7.16	37.49 AV	54.00	-16.51	100.00	342.00
6	9748.00	47.48	-6.75	40.73 AV	54.00	-13.27	100.00	20.00

- REMARKS:**
1. Emission level (dBuV/m) = Raw Value (dBuV) + Correction Factor (dB/m).
 2. Correction Factor (dB/m) = Antenna Factor (dB/m) + Cable Factor (dB).
 3. The other emission levels were very low against the limit.
 4. Margin value = Emission level – Limit value.



EUT TEST CONDITION		MEASUREMENT DETAIL	
CHANNEL	Channel 11	FREQUENCY RANGE	1 ~ 25GHz
INPUT POWER (SYSTEM)	120Vac, 60 Hz	DETECTOR FUNCTION	Peak (PK) Average (AV)
ENVIRONMENTAL CONDITIONS	24deg. C, 70%RH 999hPa	TESTED BY	Rainy Wu

ANTENNA POLARITY & TEST DISTANCE: HORIZONTAL AT 3 M								
No.	Freq. (MHz)	Correction Factor (dB/m)	Raw Value (dBuV)	Emission Level (dBuV/m)	Limit (dBuV/m)	Margin (dB)	Antenna Height (cm)	Table Angle (Degree)
1	2483.50	32.76	28.00	60.76 PK	74.00	-13.24	100.00	0.00
2	4924.00	38.19	4.99	43.18 PK	74.00	-30.82	100.00	0.00
3	7386.00	44.64	4.83	49.47 PK	74.00	-24.53	100.00	0.00
4	9848.00	47.66	5.11	52.77 PK	74.00	-21.23	100.00	0.00
5	2483.50	32.76	17.27	50.02 AV	54.00	-3.98	100.00	0.00
6	4924.00	38.19	-6.90	31.29 AV	54.00	-22.71	100.00	20.00
7	7386.00	44.64	-6.84	37.80 AV	54.00	-16.20	100.00	217.00
8	9848.00	47.66	-6.56	41.10 AV	54.00	-12.90	100.00	281.00
ANTENNA POLARITY & TEST DISTANCE: VERTICAL AT 3 M								
No.	Freq. (MHz)	Correction Factor (Db/m)	Raw Value (dBuV)	Emission Level (dBuV/m)	Limit (dBuV/m)	Margin (Db)	Antenna Height (cm)	Table Angle (Degree)
1	2483.50	32.76	35.11	67.86 PK	74.00	-6.14	100.00	0.00
2	4924.00	38.19	3.69	41.88 PK	74.00	-32.12	100.00	349.00
3	7386.00	44.64	4.20	48.84 PK	74.00	-25.16	100.00	20.00
4	9848.00	47.66	5.82	53.48 PK	74.00	-20.52	100.00	20.00
5	2483.50	32.76	18.50	51.26 AV	54.00	-2.74	100.00	0.00
6	4924.00	38.19	-6.78	31.40 AV	54.00	-22.60	100.00	0.00
7	7386.00	44.64	-6.77	37.87 AV	54.00	-16.13	100.00	0.00
8	9848.00	47.66	-6.35	41.31 AV	54.00	-12.69	100.00	0.00

- REMARKS:**
1. Emission level (dBuV/m) = Raw Value (dBuV) + Correction Factor (dB/m).
 2. Correction Factor (dB/m) = Antenna Factor (dB/m) + Cable Factor (dB).
 3. The other emission levels were very low against the limit.
 4. Margin value = Emission level – Limit value.



802.11g OFDM MODULATION

EUT TEST CONDITION		MEASUREMENT DETAIL	
CHANNEL	Channel 1	FREQUENCY RANGE	1 ~ 25GHz
INPUT POWER (SYSTEM)	120Vac, 60 Hz	DETECTOR FUNCTION	Peak (PK) Average (AV)
ENVIRONMENTAL CONDITIONS	24deg. C, 70%RH 999hPa	TESTED BY	Rainy Wu

ANTENNA POLARITY & TEST DISTANCE: HORIZONTAL AT 3 M								
No.	Freq. (MHz)	Correction Factor (dB/m)	Raw Value (dBuV)	Emission Level (dBuV/m)	Limit (dBuV/m)	Margin (dB)	Antenna Height (cm)	Table Angle (Degree)
1	2390.00	32.59	28.91	61.50 PK	74.00	-12.50	100.00	0.00
2	4824.00	37.82	5.10	42.92 PK	74.00	-31.08	200.00	20.00
3	7236.00	44.64	4.97	49.61 PK	74.00	-24.39	200.00	20.00
4	9648.00	47.23	5.45	52.68 PK	74.00	-21.32	200.00	20.00
5	2390.00	32.59	17.26	49.85 AV	54.00	-4.15	100.00	0.00
6	4824.00	37.82	-6.55	31.27 AV	54.00	-22.73	100.00	124.00
7	7236.00	44.64	-6.92	37.72 AV	54.00	-16.28	100.00	74.00
8	9648.00	47.23	-6.44	40.79 AV	54.00	-13.21	100.00	27.00
ANTENNA POLARITY & TEST DISTANCE: VERTICAL AT 3 M								
No.	Freq. (MHz)	Correction Factor (dB/m)	Raw Value (dBuV)	Emission Level (dBuV/m)	Limit (dBuV/m)	Margin (dB)	Antenna Height (cm)	Table Angle (Degree)
1	2390.00	32.59	36.79	69.38 PK	74.00	-4.62	100.00	0.00
2	4824.00	37.82	5.43	43.25 PK	74.00	-30.75	100.00	0.00
3	7236.00	44.64	4.60	49.23 PK	74.00	-24.77	100.00	0.00
4	9648.00	47.23	4.84	52.07 PK	74.00	-21.93	100.00	0.00
5	2390.00	32.59	19.08	51.66 AV	54.00	-2.34	100.00	0.00
6	4824.00	37.82	-6.55	31.27 AV	54.00	-22.73	100.00	124.00
7	7236.00	44.64	-6.92	37.72 AV	54.00	-16.28	100.00	74.00
8	9648.00	47.23	-6.44	40.79 AV	54.00	-13.21	100.00	27.00

- REMARKS:**
1. Emission level (dBuV/m) = Raw Value (dBuV) + Correction Factor (dB/m).
 2. Correction Factor (dB/m) = Antenna Factor (dB/m) + Cable Factor (dB).
 3. The other emission levels were very low against the limit.
 4. Margin value = Emission level – Limit value.



EUT TEST CONDITION		MEASUREMENT DETAIL	
CHANNEL	Channel 6	FREQUENCY RANGE	1 ~ 25GHz
INPUT POWER (SYSTEM)	120Vac, 60 Hz	DETECTOR FUNCTION	Peak (PK) Average (AV)
ENVIRONMENTAL CONDITIONS	24deg. C, 70%RH 999hPa	TESTED BY	Rainy Wu

ANTENNA POLARITY & TEST DISTANCE: HORIZONTAL AT 3 M								
No.	Freq. (MHz)	Correction Factor (dB/m)	Raw Value (dBuV)	Emission Level (dBuV/m)	Limit (dBuV/m)	Margin (dB)	Antenna Height (cm)	Table Angle (Degree)
1	4874.00	38.00	4.35	42.35 PK	74.00	-31.65	100.00	20.00
2	7311.00	44.65	4.52	49.17 PK	74.00	-24.83	100.00	20.00
3	9748.00	47.48	5.23	52.72 PK	74.00	-21.28	100.00	20.00
4	4874.00	38.00	-6.56	31.45 AV	54.00	-22.55	100.00	20.00
5	7311.00	44.65	-7.13	37.52 AV	54.00	-16.48	100.00	20.00
6	9748.00	47.48	-6.49	40.99 AV	54.00	-13.01	100.00	20.00
ANTENNA POLARITY & TEST DISTANCE: VERTICAL AT 3 M								
No.	Freq. (MHz)	Correction Factor (dB/m)	Raw Value (dBuV)	Emission Level (dBuV/m)	Limit (dBuV/m)	Margin (dB)	Antenna Height (cm)	Table Angle (Degree)
1	4874.00	38.00	4.73	42.73 PK	74.00	-31.27	100.00	0.00
2	7311.00	44.65	4.21	48.87 PK	74.00	-25.13	100.00	0.00
3	9748.00	47.48	5.34	52.82 PK	74.00	-21.18	100.00	0.00
4	4874.00	38.00	-6.54	31.46 AV	54.00	-22.54	100.00	128.00
5	7311.00	44.65	-6.94	37.71 AV	54.00	-16.29	100.00	78.00
6	9748.00	47.48	-6.44	41.04 AV	54.00	-12.96	100.00	34.00

- REMARKS:**
1. Emission level (dBuV/m) = Raw Value (dBuV) + Correction Factor (dB/m).
 2. Correction Factor (dB/m) = Antenna Factor (dB/m) + Cable Factor (dB).
 3. The other emission levels were very low against the limit.
 4. Margin value = Emission level – Limit value.



EUT TEST CONDITION		MEASUREMENT DETAIL	
CHANNEL	Channel 11	FREQUENCY RANGE	1 ~ 25GHz
INPUT POWER (SYSTEM)	120Vac, 60 Hz	DETECTOR FUNCTION	Peak (PK) Average (AV)
ENVIRONMENTAL CONDITIONS	24deg. C, 70%RH 999hPa	TESTED BY	Rainy Wu

ANTENNA POLARITY & TEST DISTANCE: HORIZONTAL AT 3 M								
No.	Freq. (MHz)	Correction Factor (dB/m)	Raw Value (dBuV)	Emission Level (dBuV/m)	Limit (dBuV/m)	Margin (dB)	Antenna Height (cm)	Table Angle (Degree)
1	2483.50	32.76	32.13	64.88 PK	74.00	-9.12	100.00	0.00
2	4924.00	38.19	3.37	41.55 PK	74.00	-32.45	100.00	225.00
3	7386.00	44.64	4.06	48.70 PK	74.00	-25.30	100.00	348.00
4	9848.00	47.66	3.90	51.56 PK	74.00	-22.44	100.00	20.00
5	2483.50	32.76	17.42	50.18 AV	54.00	-3.82	100.00	0.00
6	4924.00	38.19	-7.07	31.12 AV	54.00	-22.88	100.00	20.00
7	7386.00	44.64	-6.78	37.86 AV	54.00	-16.14	100.00	20.00
8	9848.00	47.66	-6.43	41.23 AV	54.00	-12.77	100.00	20.00
ANTENNA POLARITY & TEST DISTANCE: VERTICAL AT 3 M								
No.	Freq. (MHz)	Correction Factor (dB/m)	Raw Value (dBuV)	Emission Level (dBuV/m)	Limit (dBuV/m)	Margin (dB)	Antenna Height (cm)	Table Angle (Degree)
1	2483.50	32.76	39.55	72.31 PK	74.00	-1.69	100.00	0.00
2	4924.00	38.19	4.03	42.22 PK	74.00	-31.78	100.00	202.00
3	7386.00	44.64	3.58	48.22 PK	74.00	-25.78	100.00	39.00
4	9848.00	47.66	4.81	52.47 PK	74.00	-21.53	100.00	0.00
5	2483.50	32.76	19.51	52.27 AV	54.00	-1.73	100.00	0.00
6	4924.00	38.19	-6.77	31.41 AV	54.00	-22.59	100.00	271.00
7	7386.00	44.64	-6.65	37.99 AV	54.00	-16.01	100.00	318.00
8	9848.00	47.66	-6.29	41.37 AV	54.00	-12.63	100.00	4.00

- REMARKS:**
1. Emission level (dBuV/m) = Raw Value (dBuV) + Correction Factor (dB/m).
 2. Correction Factor (dB/m) = Antenna Factor (dB/m) + Cable Factor (dB).
 3. The other emission levels were very low against the limit.
 4. Margin value = Emission level – Limit value.



BELOW 1GHz WORST-CASE DATA : 802.11b DSSS MODULATION

EUT TEST CONDITION		MEASUREMENT DETAIL	
CHANNEL	Channel 1	FREQUENCY RANGE	Below 1000MHz
INPUT POWER (SYSTEM)	120Vac, 60 Hz	DETECTOR FUNCTION	Quasi-Peak
ENVIRONMENTAL CONDITIONS	24deg. C, 70%RH 999hPa	TESTED BY	Sky Lan

ANTENNA POLARITY & TEST DISTANCE: HORIZONTAL AT 3 M								
No.	Freq. (MHz)	Correction Factor (dB/m)	Raw Value (dBuV)	Emission Level (dBuV/m)	Limit (dBuV/m)	Margin (dB)	Antenna Height (cm)	Table Angle (Degree)
1	240.00	14.75	20.96	35.71	46.00	-10.29	100.00	272.00
2	360.00	17.75	22.98	40.73	46.00	-5.27	100.00	18.00
3	480.00	20.58	18.98	39.57	46.00	-6.43	100.00	202.00
4	500.01	20.87	14.14	35.01	46.00	-10.99	100.00	127.00
5	720.00	24.99	18.20	43.19	46.00	-2.81	100.00	316.00
6	900.58	27.24	9.38	36.62	46.00	-9.38	100.00	56.00
ANTENNA POLARITY & TEST DISTANCE: VERTICAL AT 3 M								
No.	Freq. (MHz)	Correction Factor (dB/m)	Raw Value (dBuV)	Emission Level (dBuV/m)	Limit (dBuV/m)	Margin (dB)	Antenna Height (cm)	Table Angle (Degree)
1	55.89	15.06	20.81	35.87	40.00	-4.13	100.00	18.00
2	107.31	13.29	21.61	34.90	43.50	-8.60	100.00	228.00
3	240.00	14.75	22.78	37.53	46.00	-8.47	100.00	216.00
4	250.00	14.81	19.00	33.81	46.00	-12.19	101.00	121.00
5	360.00	17.75	18.75	36.50	46.00	-9.50	100.00	331.00
6	480.00	20.58	17.20	37.79	46.00	-8.21	101.00	121.00

- REMARKS:**
1. Emission level (dBuV/m) = Raw Value (dBuV) + Correction Factor (dB/m).
 2. Correction Factor (dB/m) = Antenna Factor (dB/m) + Cable Factor (dB).
 3. The other emission levels were very low against the limit.
 4. Margin value = Emission level – Limit value.



4.2 CONDUCTED EMISSION MEASUREMENT

4.2.1 LIMITS OF CONDUCTED EMISSION MEASUREMENT

FREQUENCY OF EMISSION (MHz)	CONDUCTED LIMIT (dB μ V)	
	Quasi-peak	Average
0.15 ~ 0.5	66 to 56	56 to 46
0.5 ~ 5	56	46
5 ~ 30	60	50

- NOTE:** 1. The lower limit shall apply at the transition frequencies.
 2. The limit decreases in line with the logarithm of the frequency in the range of 0.15 to 0.50MHz.
 3. All emanations from a class A/B digital device or system, including any network of conductors and apparatus connected thereto, shall not exceed the level of field strengths specified above.

4.2.2 TEST INSTRUMENTS

DESCRIPTION & MANUFACTURER	MODEL NO.	SERIAL NO.	CALIBRATED UNTIL
Receiver R&S	ESCS30	E1R1002	Oct. 31, 2008
LISN Schwarzbeck	NSLK8127	E1L1001	Jul. 31, 2009
RF signal cable Woken	RG-58	E1CBL09	May. 30, 2009
Software ADT	ADT_Cond_ V7.3.0	N/A	N/A

NOTE: The calibration interval of the above test instruments is 12 months.



4.2.3 TEST PROCEDURES

- a. The EUT was placed 0.4 meters from the conducting wall of the shielded room with EUT being connected to the power mains through a line impedance stabilization network (LISN). Other support units were connected to the power mains through another LISN. The two LISNs provide 50 ohm/ 50uH of coupling impedance for the measuring instrument.
- b. Both lines of the power mains connected to the EUT were checked for maximum conducted interference.
- c. The frequency range from 150kHz to 30MHz was searched. Emission levels under (Limit - 20dB) was not recorded.

NOTE: All modes of operation were investigated and the worst-case emissions are reported.

4.2.4 DEVIATION FROM TEST STANDARD

No deviation

4.2.5 TEST SETUP

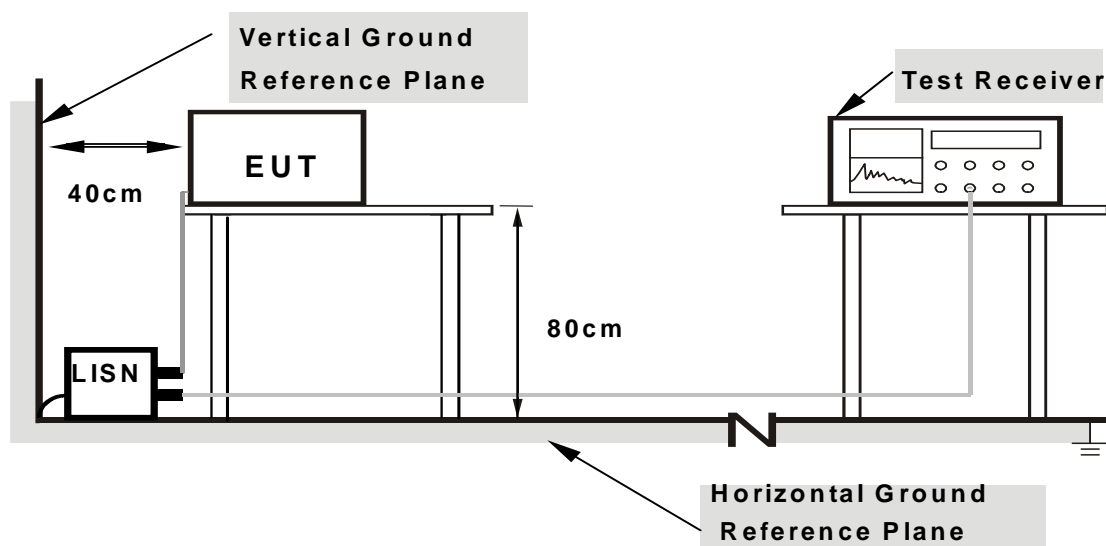

Note: 1. Support units were connected to second LISN.

2. Both of LISNs (AMN) are 80 cm from EUT and at least 80 from other units and other metal planes

For the actual test configuration, please refer to the attached file (Test Setup Photo).

4.2.6 EUT OPERATING CONDITIONS

Same as 4.1.6.

4.2.7 TEST RESULTS

CONDUCTED WORST-CASE DATA : 802.11b DSSS MODULATION

EUT TEST CONDITION		MEASUREMENT DETAIL	
CHANNEL	Channel 1	PHASE	Line 1
MODULATION TYPE	CCK	INPUT POWER (SYSTEM)	120Vac, 60Hz
TRANSFER RATE	1.0Mbps	6dB BANDWIDTH	9kHz
ENVIRONMENTAL CONDITIONS	21deg. C, 66%RH, 988hPa	TESTED BY	Ice Peng

No	Freq. [MHz]	Corr. Factor (dB)	Reading Value [dB (uV)]		Emission Level [dB (uV)]		Limit [dB (uV)]		Margin (dB)	
			Q.P.	AV.	Q.P.	AV.	Q.P.	AV.	Q.P.	AV.
1	0.15	1.77	34.68	11.81	36.45	13.58	65.92	55.92	-29.47	-42.34
2	0.31	0.69	34.51	25.98	35.20	26.67	59.86	49.86	-24.66	-23.19
3	0.37	0.61	34.18	25.60	34.79	26.21	58.44	48.44	-23.65	-22.23
4	6.26	0.58	45.59	42.78	46.17	43.36	60.00	50.00	-13.83	-6.64
5	9.30	0.59	43.10	35.83	43.69	36.42	60.00	50.00	-16.31	-13.58
6	24.23	0.94	21.32	16.15	22.26	17.09	60.00	50.00	-37.74	-32.91

- REMARKS:**
1. Q.P. and AV. are abbreviations of quasi-peak and average individually.
 2. "-": The Quasi-peak reading value also meets average limit and measurement with the average detector is unnecessary.
 3. The emission levels of other frequencies were very low against the limit.
 4. Margin value = Emission level - Limit value
 5. Correction factor = Insertion loss + Cable loss
 6. Emission Level = Correction Factor + Reading Value.

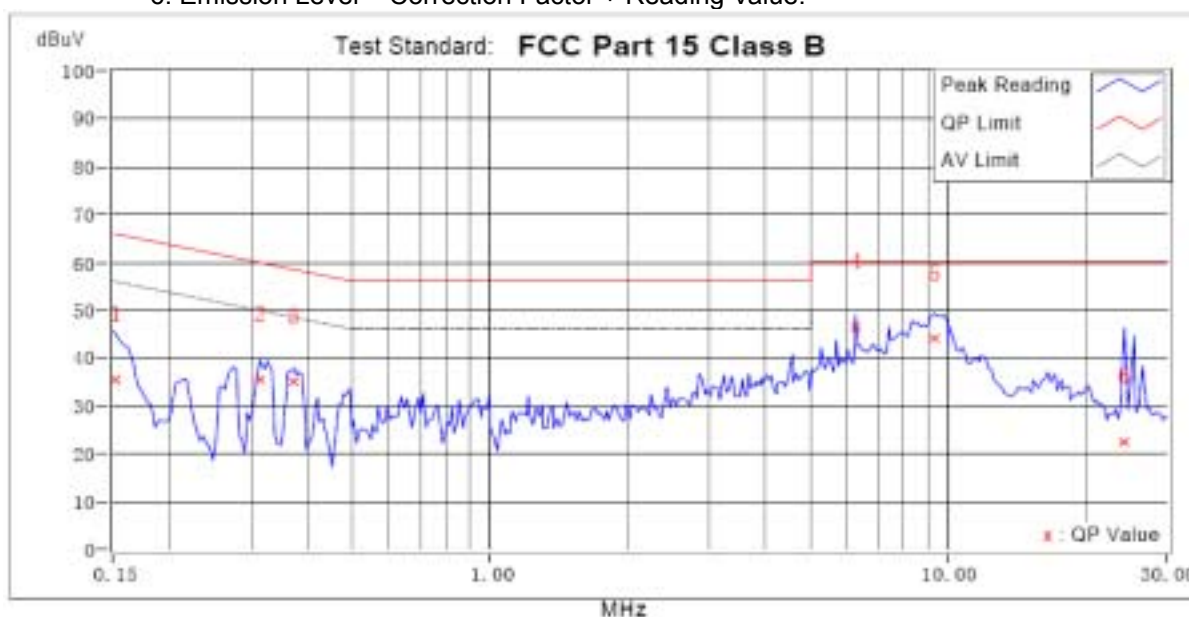



EUT TEST CONDITION		MEASUREMENT DETAIL	
CHANNEL	Channel 1	PHASE	Line 2
MODULATION TYPE	CCK	INPUT POWER (SYSTEM)	120Vac, 60Hz
TRANSFER RATE	1.0Mbps	6dB BANDWIDTH	9kHz
ENVIRONMENTAL CONDITIONS	21deg. C, 66%RH, 988hPa	TESTED BY	Ice Peng

No	Freq. [MHz]	Corr. Factor (dB)	Reading Value [dB (uV)]		Emission Level [dB (uV)]		Limit [dB (uV)]		Margin (dB)	
			Q.P.	AV.	Q.P.	AV.	Q.P.	AV.	Q.P.	AV.
			1	0.15	1.79	34.49	12.31	36.28	14.10	66.00
2	0.31	0.70	36.53	29.97	37.23	30.67	59.86	49.86	-22.63	-19.19
3	0.36	0.64	37.73	27.74	38.37	28.38	58.71	48.71	-20.34	-20.33
4	6.24	0.49	45.83	44.60	46.32	45.09	60.00	50.00	-13.68	-4.91
5	7.38	0.52	43.72	41.07	44.24	41.59	60.00	50.00	-15.76	-8.41
6	9.66	0.55	41.76	35.38	42.31	35.93	60.00	50.00	-17.69	-14.07

- REMARKS:**
1. Q.P. and AV. are abbreviations of quasi-peak and average individually.
 2. "-": The Quasi-peak reading value also meets average limit and measurement with the average detector is unnecessary.
 3. The emission levels of other frequencies were very low against the limit.
 4. Margin value = Emission level - Limit value
 5. Correction factor = Insertion loss + Cable loss
 6. Emission Level = Correction Factor + Reading Value.

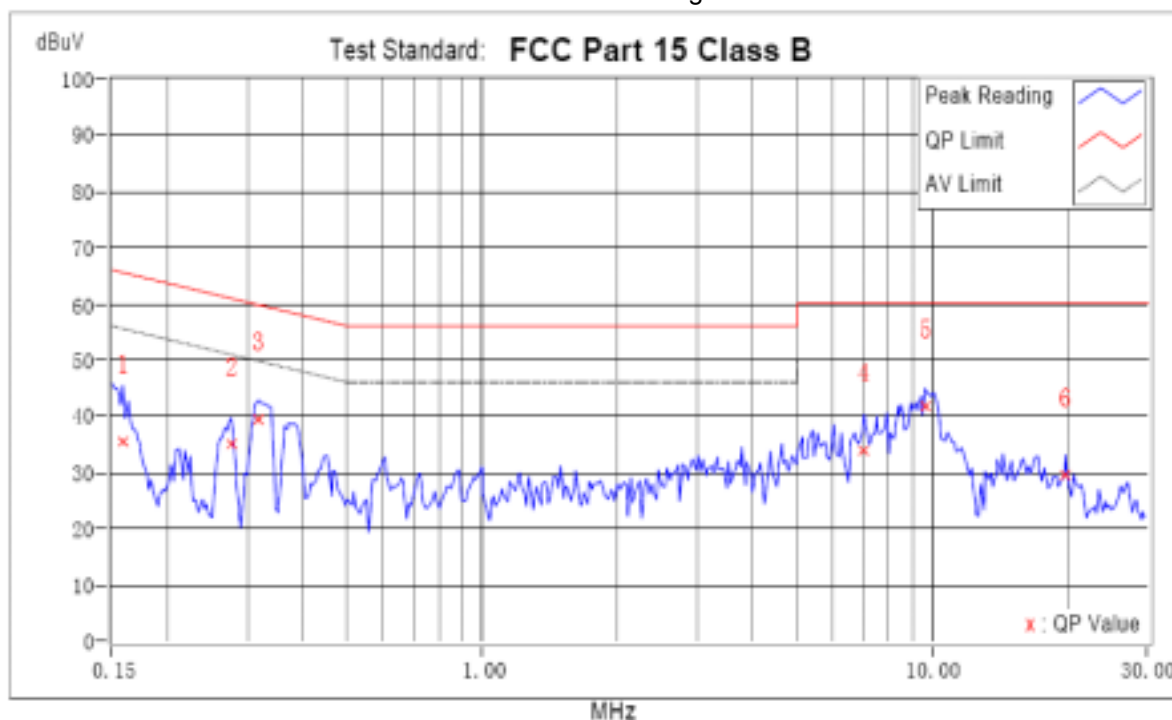



4.3 6dB BANDWIDTH MEASUREMENT

4.3.1 LIMITS OF 6dB BANDWIDTH MEASUREMENT

The minimum of 6dB Bandwidth Measurement is 0.5 MHz.

4.3.2 TEST INSTRUMENTS

DESCRIPTION & MANUFACTURER	MODEL NO.	SERIAL NO.	CALIBRATED UNTIL
Signal Analyzer ROHDE & SCHWARZ	FSP30	E1S1002	Jul. 31, 2009

NOTE: The calibration interval of the above test instruments is 12 months.

4.3.3 TEST PROCEDURE

The transmitter output was connected to the spectrum analyzer through an attenuator. The bandwidth of the fundamental frequency was measured by spectrum analyzer with 100kHz RBW and 300kHz VBW. The 6dB bandwidth is defined as the total spectrum the power of which is higher than peak power minus 6dB.

4.3.4 DEVIATION FROM TEST STANDARD

No deviation

4.3.5 TEST SETUP

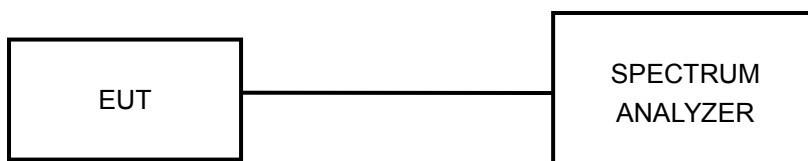

4.3.6 EUT OPERATING CONDITIONS

The software provided by client to enable the EUT under transmission condition continuously at lowest, middle and highest channel frequencies individually.



4.3.7 TEST RESULTS

802.11b DSSS MODULATION

MODULATION TYPE	CCK	TRANSFER RATE	1.0Mbps
INPUT POWER (SYSTEM)	120Vac, 60Hz	ENVIRONMENTAL CONDITIONS	25deg.C, 65%RH, 991hPa
TESTED BY	Ray Xue		

CHANNEL	CHANNEL FREQUENCY (MHz)	6dB BANDWIDTH (MHz)	MINIMUM LIMIT (MHz)	PASS / FAIL
1	2412	9.60	0.5	PASS
6	2437	9.52	0.5	PASS
11	2462	9.96	0.5	PASS

CH 1

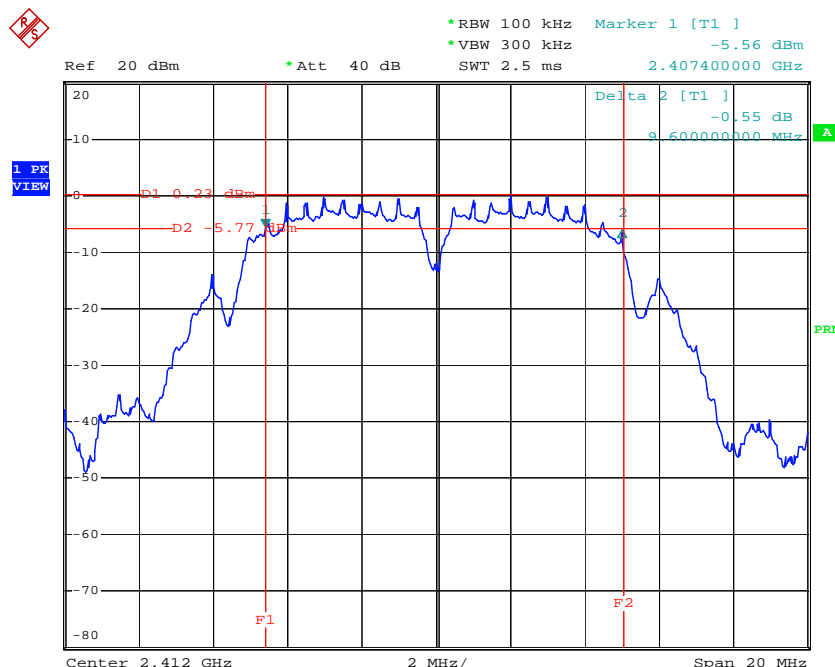

Date: 5.SEP.2008 02:56:00

CH 6

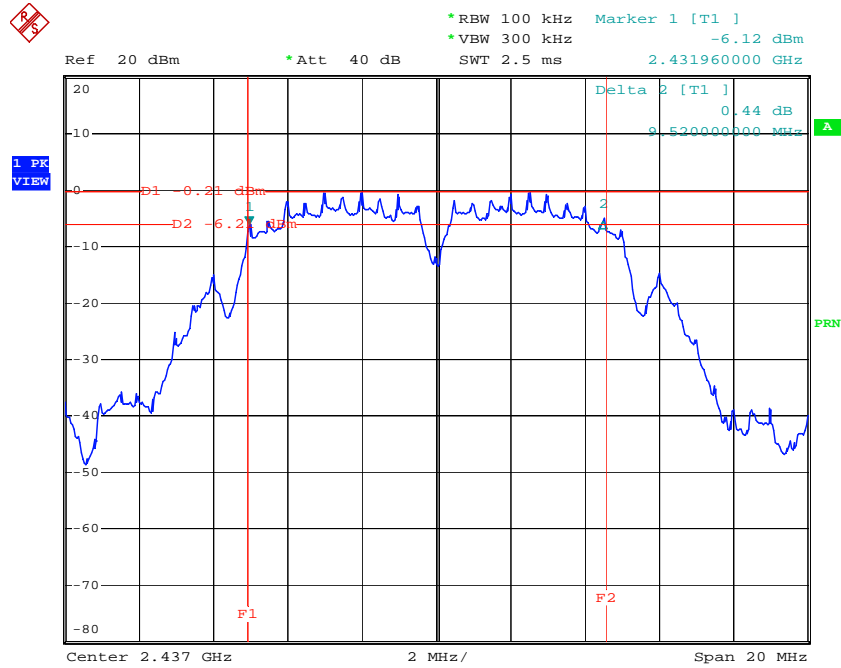

Date: 5.SEP.2008 02:58:21

CH 11

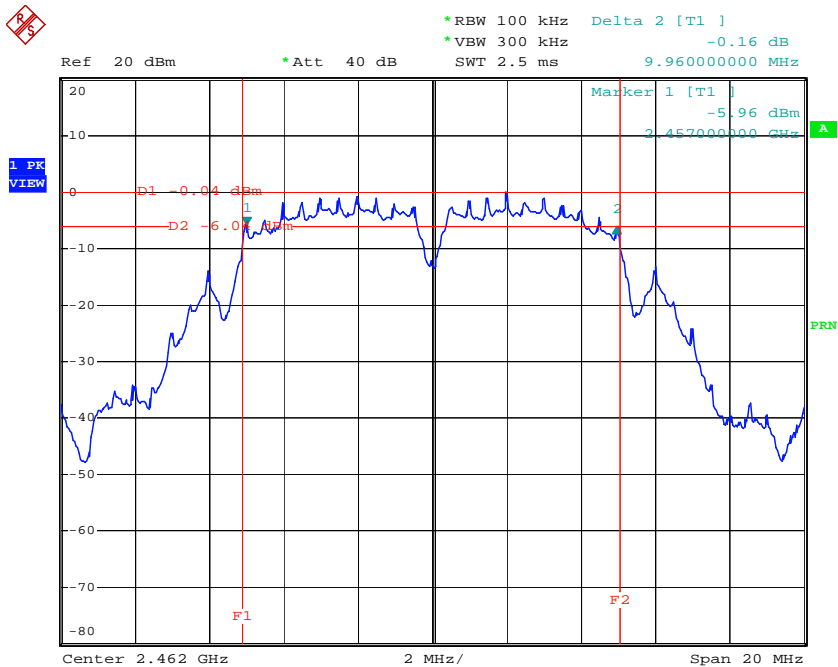

Date: 5.SEP.2008 03:00:46



802.11g OFDM MODULATION

MODULATION TYPE	BPSK	TRANSFER RATE	6.0Mbps
INPUT POWER (SYSTEM)	120Vac, 60Hz	ENVIRONMENTAL CONDITIONS	25deg.C, 65%RH, 991hPa
TESTED BY	Ray Xue		

CHANNEL	CHANNEL FREQUENCY (MHz)	6dB BANDWIDTH (MHz)	MINIMUM LIMIT (MHz)	PASS / FAIL
1	2412	15.08	0.5	PASS
6	2437	15.16	0.5	PASS
11	2462	15.04	0.5	PASS

CH 1

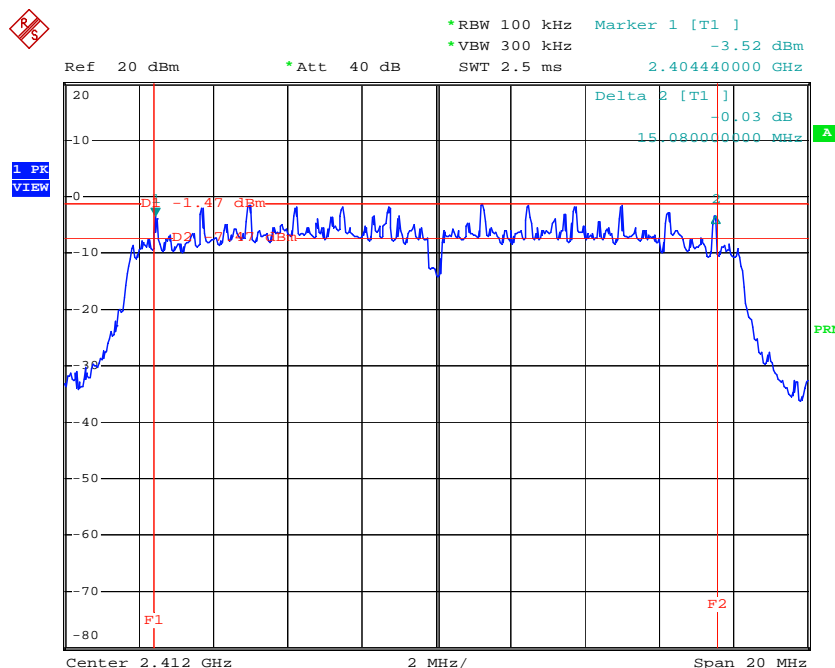

Date: 5.SEP.2008 02:52:05



CH 6

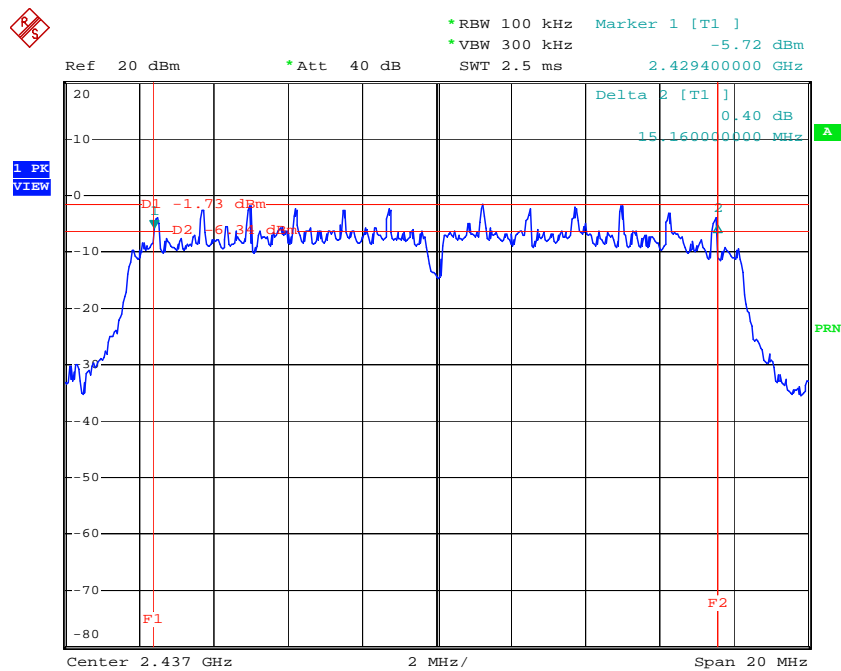

Date: 5.SEP.2008 02:49:58

CH 11

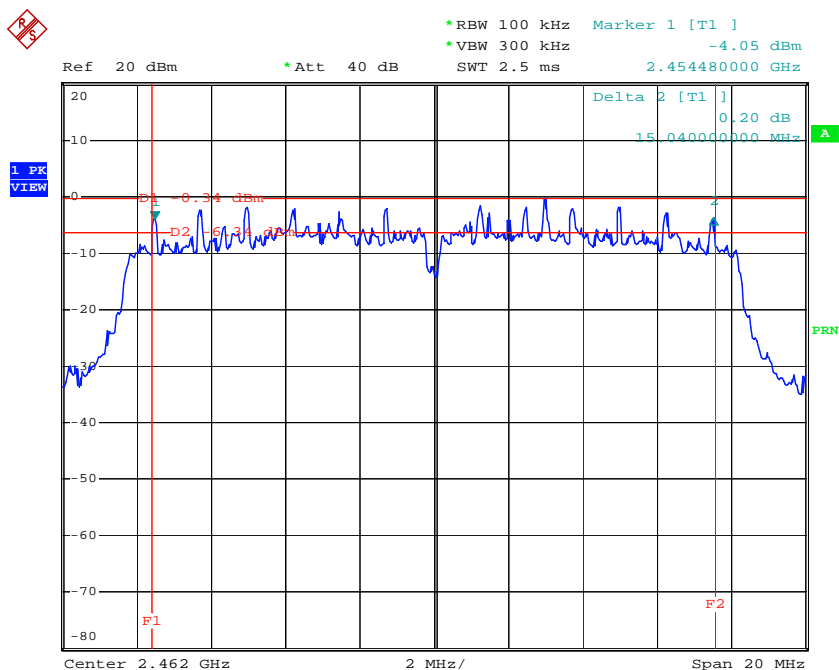

Date: 5.SEP.2008 02:47:43



4.4 MAXIMUM PEAK OUTPUT POWER

4.4.1 LIMITS OF MAXIMUM PEAK OUTPUT POWER MEASUREMENT

The Maximum Peak Output Power Measurement is 30dBm.

4.4.2 INSTRUMENTS

DESCRIPTION & MANUFACTURER	MODEL NO.	SERIAL NO.	CALIBRATED UNTIL
Signal Analyzer ROHDE & SCHWARZ	FSP30	E1S1002	Jul. 31, 2009

NOTE: The calibration interval of the above test instruments is 12 months.

4.4.3 TEST PROCEDURES

- a. A detector was used on the output port of the EUT. An oscilloscope was used to read the response of the detector.
- b. Replaced the EUT by the signal generator. The center frequency of the S.G was adjusted to the center frequency of the measured channel.
- c. Adjusted the power to have the same reading on oscilloscope. Record the power level.

4.4.4 DEVIATION FROM TEST STANDARD

No deviation

4.4.5 TEST SETUP



4.4.6 EUT OPERATING CONDITIONS

Same as Item 4.3.6



4.4.7 TEST RESULTS

802.11b DSSS MODULATION

MODULATION TYPE	CCK	TRANSFER RATE	1.0Mbps
INPUT POWER (SYSTEM)	120Vac, 60Hz	ENVIRONMENTAL CONDITIONS	25deg.C, 65%RH, 991hPa
TESTED BY	Ray Xue		

CHANNEL	CHANNEL FREQUENCY (MHz)	PEAK POWER OUTPUT (mW)	PEAK POWER OUTPUT (dBm)	PEAK POWER LIMIT (dBm)	PASS / FAIL
1	2412	20.989	13.22	30	PASS
6	2437	20.230	13.06	30	PASS
11	2462	18.923	12.77	30	PASS

802.11g OFDM MODULATION

MODULATION TYPE	BPSK	TRANSFER RATE	6.0Mbps
INPUT POWER (SYSTEM)	120Vac, 60Hz	ENVIRONMENTAL CONDITIONS	25 deg.C, 65 %RH, 991hPa
TESTED BY	Ray Xue		

CHANNEL	CHANNEL FREQUENCY (MHz)	PEAK POWER OUTPUT (mW)	PEAK POWER OUTPUT (dBm)	PEAK POWER LIMIT (dBm)	PASS / FAIL
1	2412	18.197	12.60	30	PASS
6	2437	17.219	12.36	30	PASS
11	2462	15.631	11.94	30	PASS



4.5 POWER SPECTRAL DENSITY MEASUREMENT

4.5.1 LIMITS OF POWER SPECTRAL DENSITY MEASUREMENT

The Maximum of Power Spectral Density Measurement is 8dBm.

4.5.2 TEST INSTRUMENTS

DESCRIPTION & MANUFACTURER	MODEL NO.	SERIAL NO.	CALIBRATED UNTIL
Signal Analyzer ROHDE & SCHWARZ	FSP30	E1S1002	Jul. 31, 2009

NOTE: The calibration interval of the above test instruments is 12 months.

4.5.3 TEST PROCEDURE

The transmitter output was connected to the spectrum analyzer through an attenuator, the bandwidth of the fundamental frequency was measured with the spectrum analyzer using 3kHz RBW and 30kHz VBW, set sweep time = span/3kHz. The power spectral density was measured and recorded.

The sweep time is allowed to be longer than span/3kHz for a full response of the mixer in the spectrum analyzer.

4.5.4 DEVIATION FROM TEST STANDARD

No deviation

4.5.5 TEST SETUP

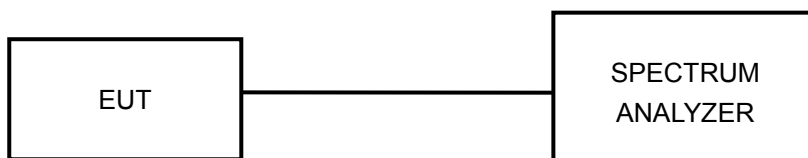

4.5.6 EUT OPERATING CONDITION

Same as Item 4.3.6



4.5.7 TEST RESULTS

802.11b DSSS MODULATION

MODULATION TYPE	CCK	TRANSFER RATE	1.0Mbps
INPUT POWER (SYSTEM)	120Vac, 60Hz	ENVIRONMENTAL CONDITIONS	25deg.C, 65%RH, 991hPa
TESTED BY	Ray Xue		

CHANNEL	CHANNEL FREQUENCY (MHz)	RF POWER LEVEL IN 3kHz BW (dBm)	MAXIMUM LIMIT (dBm)	PASS / FAIL
1	2412	-10.04	8	PASS
6	2437	-13.13	8	PASS
11	2462	-11.19	8	PASS

CH1

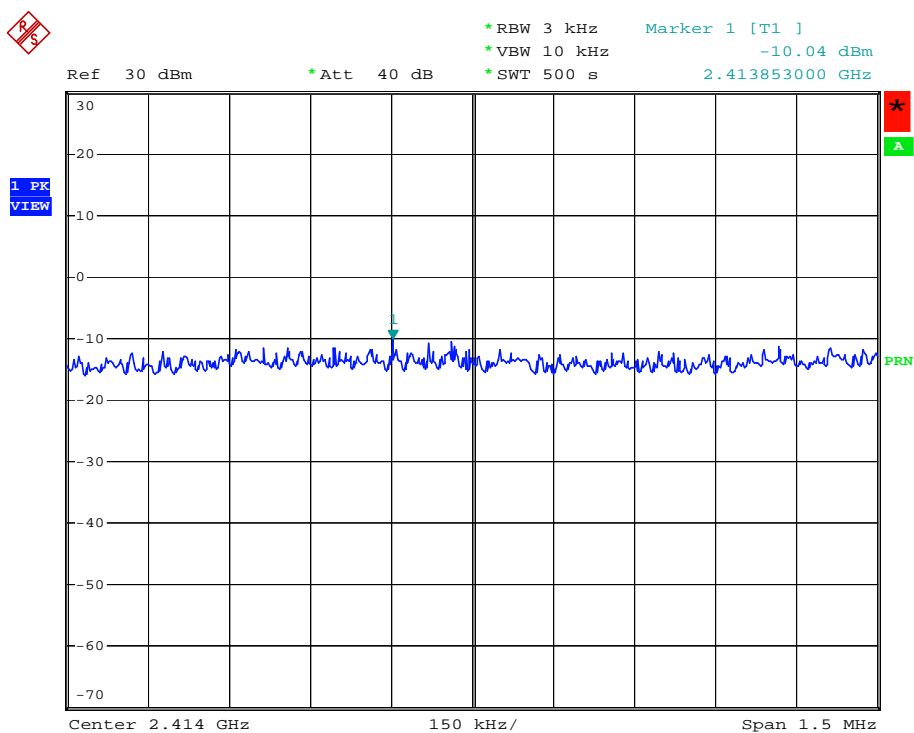

Date: 13.AUG.2008 17:06:52



802.11g OFDM MODULATION

MODULATION TYPE	BPSK	TRANSFER RATE	6.0Mbps
INPUT POWER (SYSTEM)	120Vac, 60Hz	ENVIRONMENTAL CONDITIONS	25deg.C, 65%RH, 991hPa
TESTED BY	Ray Xue		

CHANNEL	CHANNEL FREQUENCY (MHz)	RF POWER LEVEL IN 3kHz BW (dBm)	MAXIMUM LIMIT (dBm)	PASS / FAIL
1	2412	-17.44	8	PASS
6	2437	-15.44	8	PASS
11	2462	-16.30	8	PASS

CH1

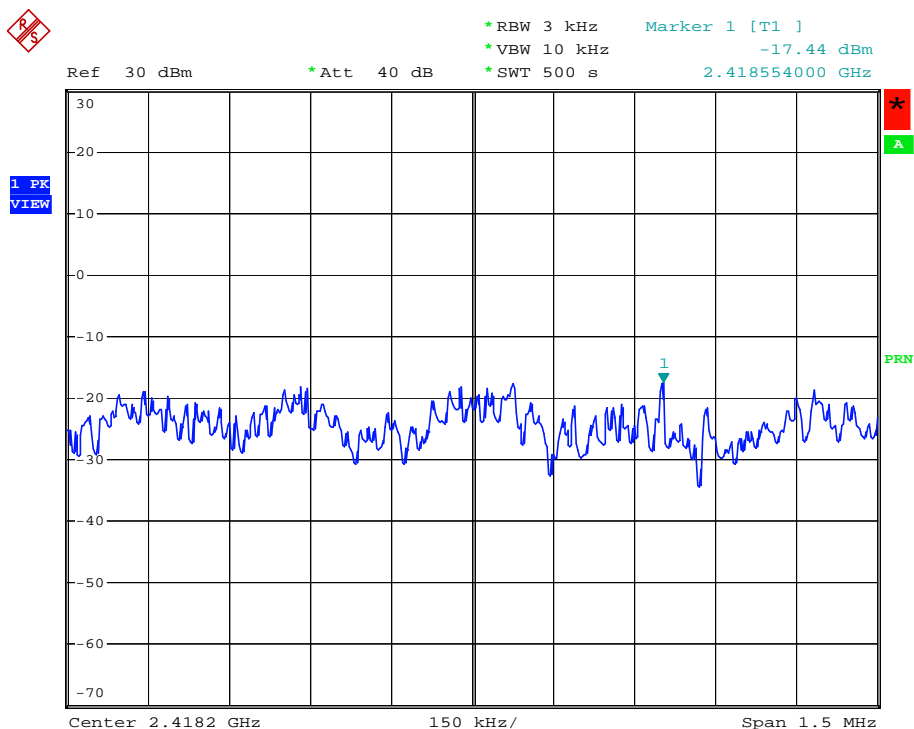

Date: 13.AUG.2008 16:35:17



CH6



Ref 30 dBm *Att 40 dB *RBW 3 kHz Marker 1 [T1]
*VBW 10 kHz -19.53 dBm
*SWT 500 s 2.438253000 GHz

1 AV
VIEW

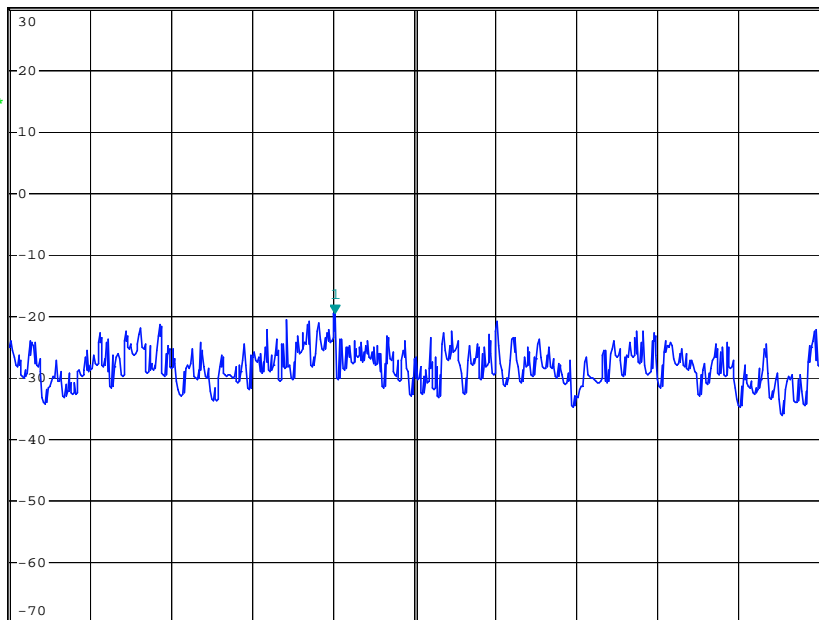

Center 2.4384 GHz 150 kHz/ Span 1.5 MHz

Date: 13.AUG.2008 16:46:51

CH11



Ref 30 dBm *Att 40 dB *RBW 3 kHz Marker 1 [T1]
*VBW 10 kHz -16.30 dBm
*SWT 500 s 2.463251000 GHz

1 PK
VIEW

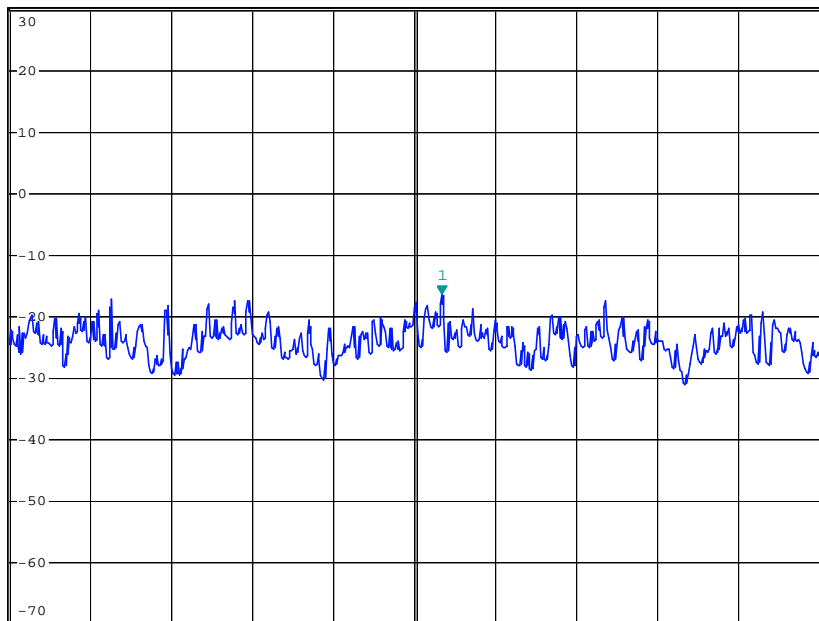

Center 2.4632 GHz 150 kHz/ Span 1.5 MHz

Date: 13.AUG.2008 16:55:55



4.6 BAND EDGES MEASUREMENT

4.6.1 LIMITS OF BAND EDGES MEASUREMENT

Below -20dB of the highest emission level of operating band (in 100kHz Resolution Bandwidth).

4.6.2 TEST INSTRUMENTS

DESCRIPTION & MANUFACTURER	MODEL NO.	SERIAL NO.	CALIBRATED UNTIL
Signal Analyzer ROHDE & SCHWARZ	FSP30	E1S1002	Jul. 31, 2009

NOTE: The calibration interval of the above test instruments is 12 months.



4.6.3 TEST PROCEDURE

FOR CONDUCTED MEASUREMENT:

The transmitter output was connected to the spectrum analyzer via a low loss cable. Set both RBW and VBW of spectrum analyzer to 100kHz and 300kHz with suitable frequency span including 100MHz bandwidth from band edge. The band edges was measured and recorded.

The spectrum plots (Peak RBW = 100kHz, VBW = 300kHz) are attached on the following pages.

FOR RADIATED MEASUREMENT:

- a. The EUT was placed on the top of a rotating table 0.8 meters above the ground at a 3 meter semi-anechoic chamber. The table was rotated 360 degrees to determine the position of the highest radiation.
- b. The EUT was set 3 meters away from the interference-receiving antenna, which was mounted on the top of a variable-height antenna tower.
- c. The antenna is a broadband antenna, and its height is varied from one meter to four meters above the ground to determine the maximum value of the field strength. Both horizontal and vertical polarizations of the antenna are set to make the measurement.
- d. For each suspected emission, the EUT was arranged to its worst case and then the antenna was tuned to heights from 1 meter to 4 meters and the rotatable table was turned from 0 degrees to 360 degrees to find the maximum reading.
- e. Set both RBW and VBW of spectrum analyzer to 100kHz and 300kHz with suitable frequency span including 100MHz bandwidth from band edge. The band edges was measured and recorded.

The spectrum plots (Peak RBW = 100kHz, VBW = 300kHz) are attached on the following pages.

NOTE: The resolution bandwidth of test receiver/spectrum analyzer is 1MHz and the video bandwidth is 10Hz for Average detection (AV) at frequency above 1GHz.

4.6.4 DEVIATION FROM TEST STANDARD

No deviation

4.6.5 EUT OPERATING CONDITION

Same as Item 4.3.6



4.6.6 TEST RESULTS

The spectrum plots are attached on the following pages. D1 line indicates the highest level, and D2 line indicates the 20dB offset below D1. It shows compliance with the requirement in part 15.247(d).

802.11b DSSS MODULATION

CH 1

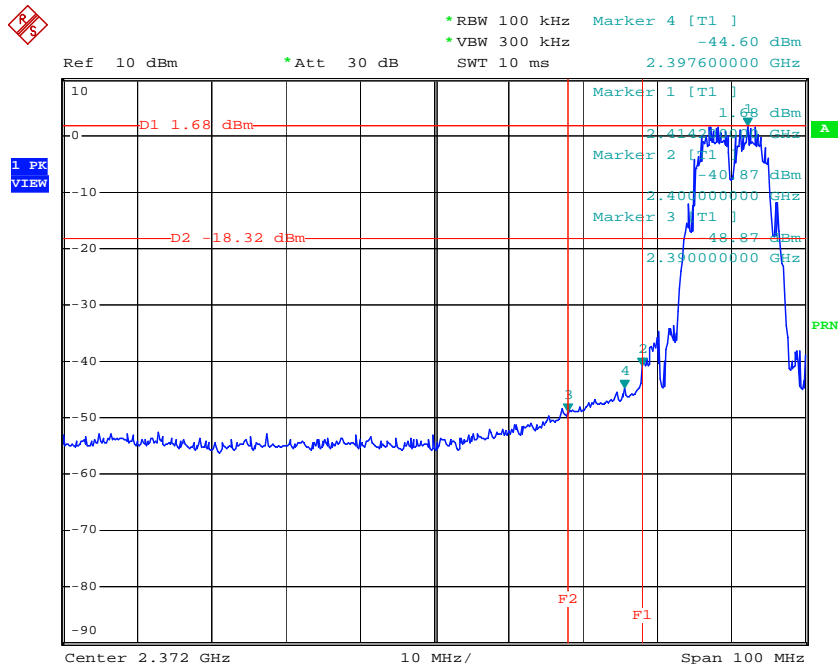

Date: 4.SEP.2008 22:33:47

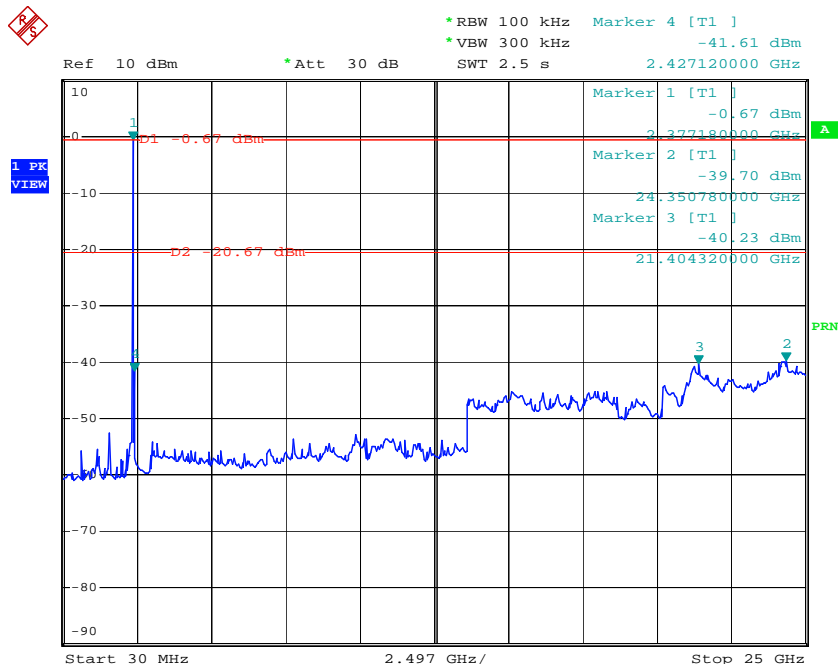

Date: 4.SEP.2008 22:35:45



CH 11



Ref 10 dBm *Att 30 dB *RBW 100 kHz Marker 4 [T1]
*VBW 300 kHz -51.07 dBm
SWT 20 ms 2.483500000 GHz

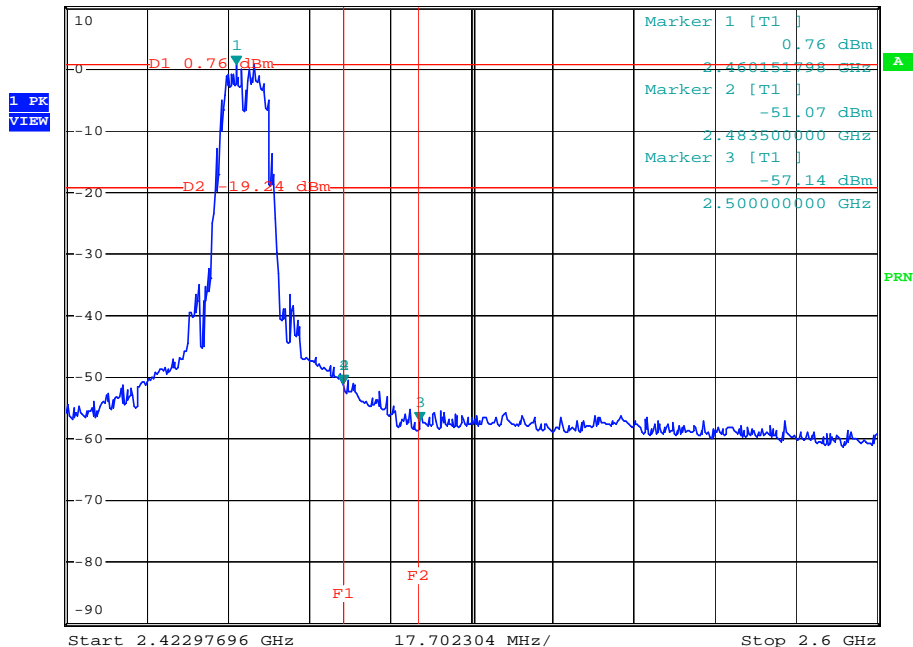

Date: 4.SEP.2008 22:40:56



Ref 10 dBm *Att 30 dB *RBW 100 kHz Marker 4 [T1]
*VBW 300 kHz -43.81 dBm
SWT 2.5 s 18.258100000 GHz

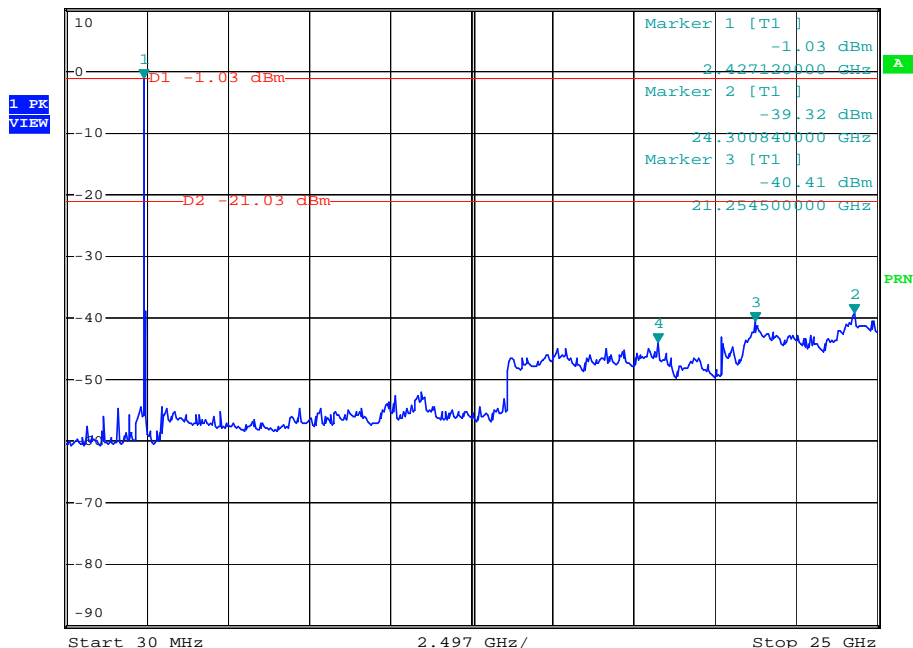

Date: 4.SEP.2008 22:37:51



802.11g OFDM MODULATION

CH 1

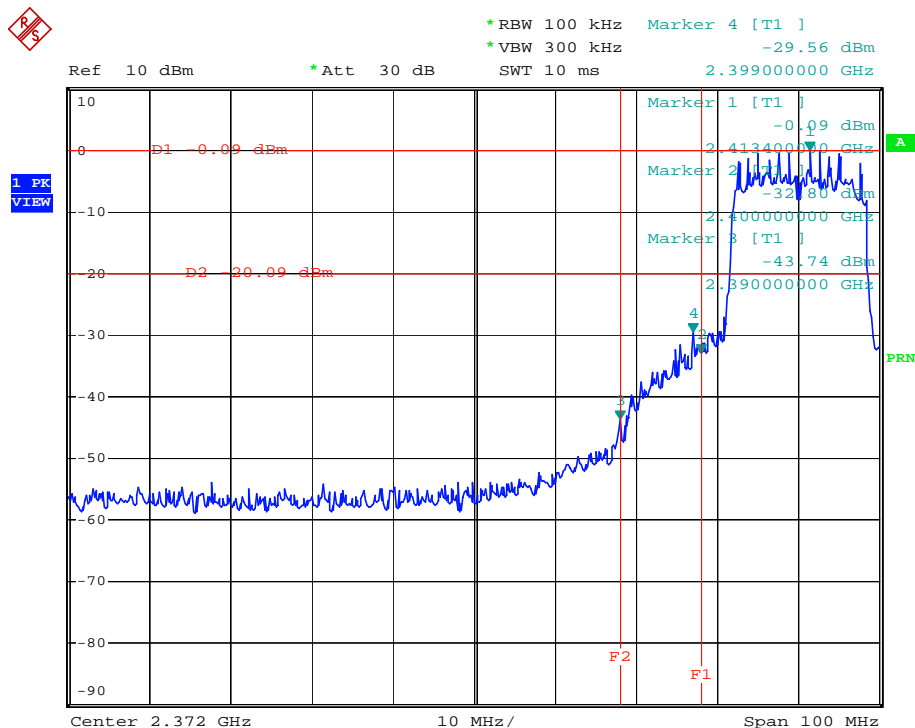

Date: 4.SEP.2008 22:51:51

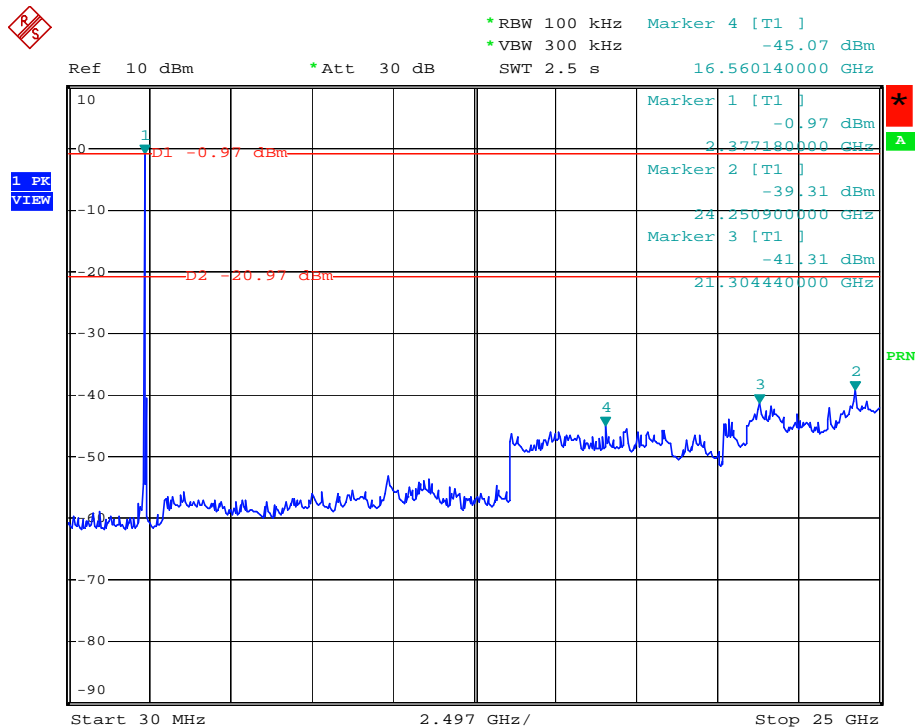

Date: 4.SEP.2008 22:48:10



CH 11



Ref 10 dBm *Att 30 dB *RBW 100 kHz Marker 4 [T1]
*VBW 300 kHz -43.90 dBm
SWT 20 ms 2.483500000 GHz

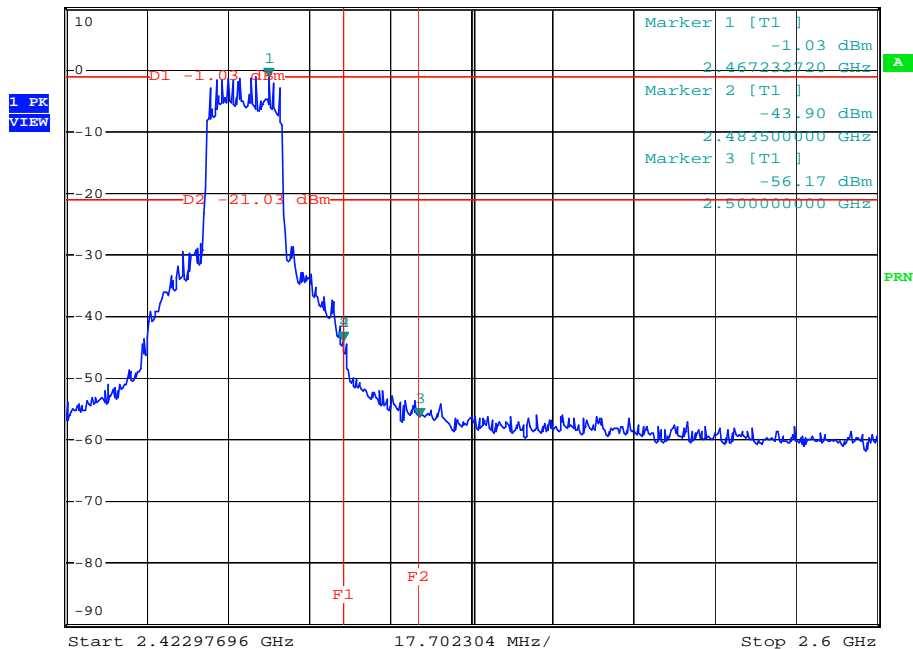

Date: 4.SEP.2008 22:44:48



Ref 10 dBm *Att 30 dB *RBW 100 kHz Marker 4 [T1]
*VBW 300 kHz -45.61 dBm
SWT 2.5 s 15.461460000 GHz

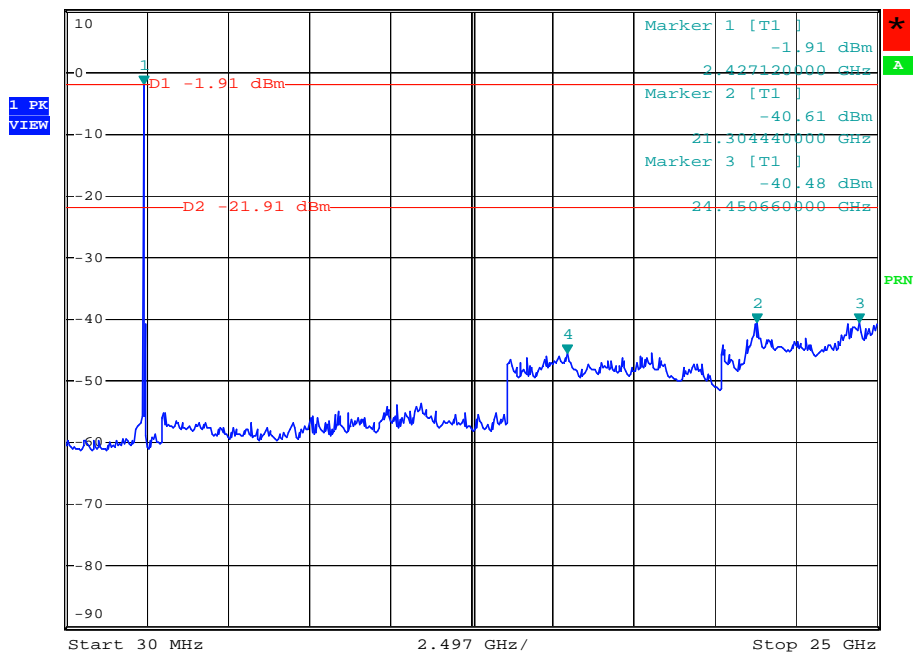

Date: 4.SEP.2008 22:56:51



4.7 ANTENNA REQUIREMENT

4.7.1 STANDARD APPLICABLE

For intentional device, according to FCC 47 CFR Section 15.203, an intentional radiator shall be designed to ensure that no antenna other than that furnished by the responsible party shall be used with the device.

And according to FCC 47 CFR Section 15.247 (b), if transmitting antennas of directional gain greater than 6dBi are used, the power shall be reduced by the amount in dB that the directional gain of the antenna exceeds 6dBi.

4.7.2 ANTENNA CONNECTED CONSTRUCTION

The antenna used in this product is Monopole antenna. The maximum Gain of the antenna is 2dBi.

5. PHOTOGRAPHS OF THE TEST CONFIGURATION

RADIATED EMISSION MEASUREMENT

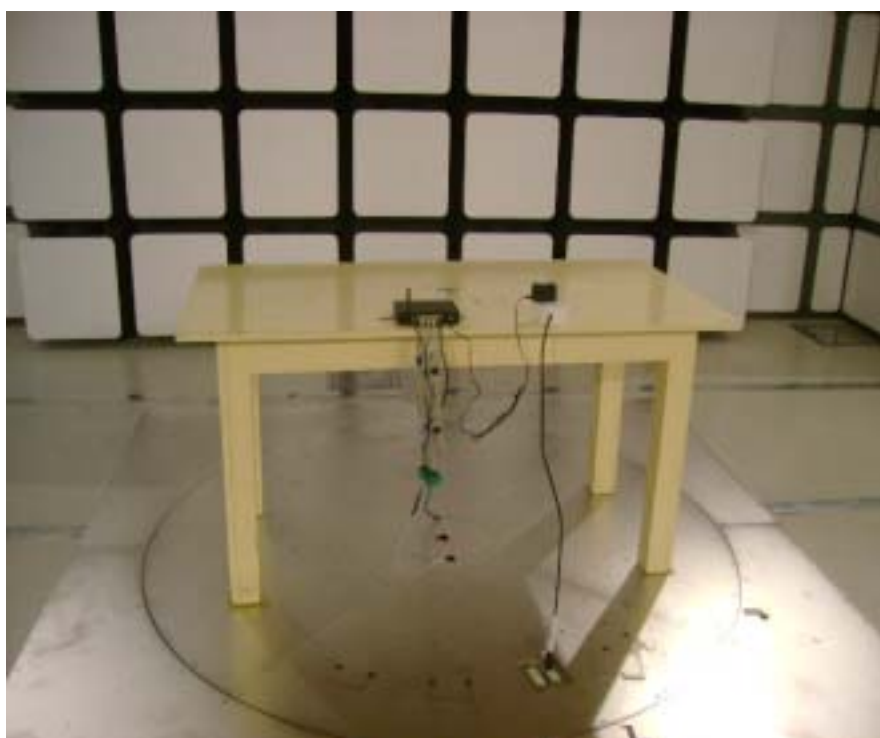
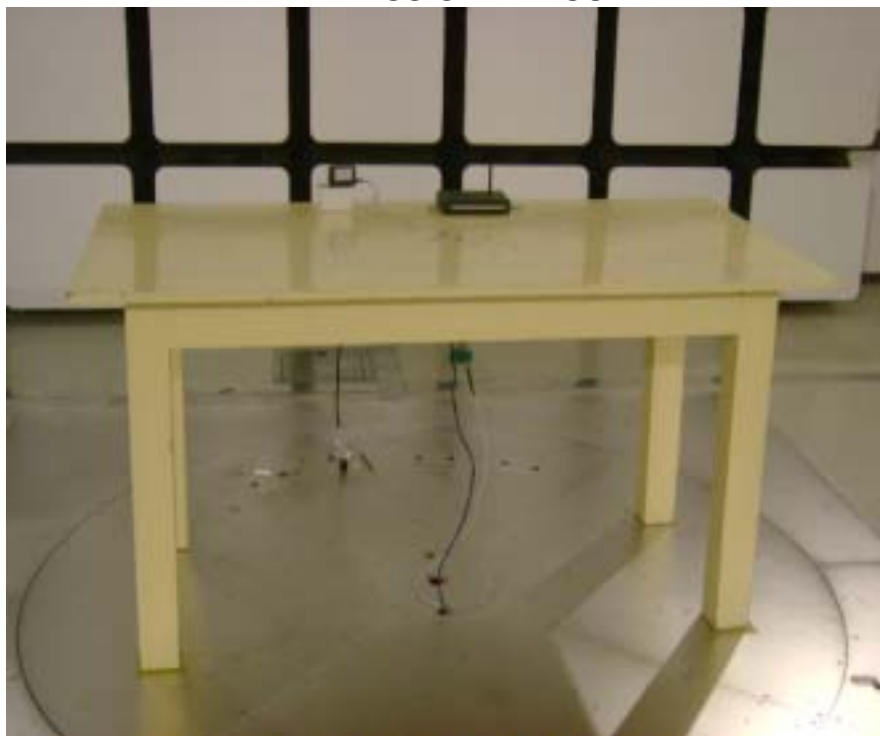

CONDUCTED EMISSION MEASUREMENT



6. PHOTOGRAPHS OF THE EUT







Adapter



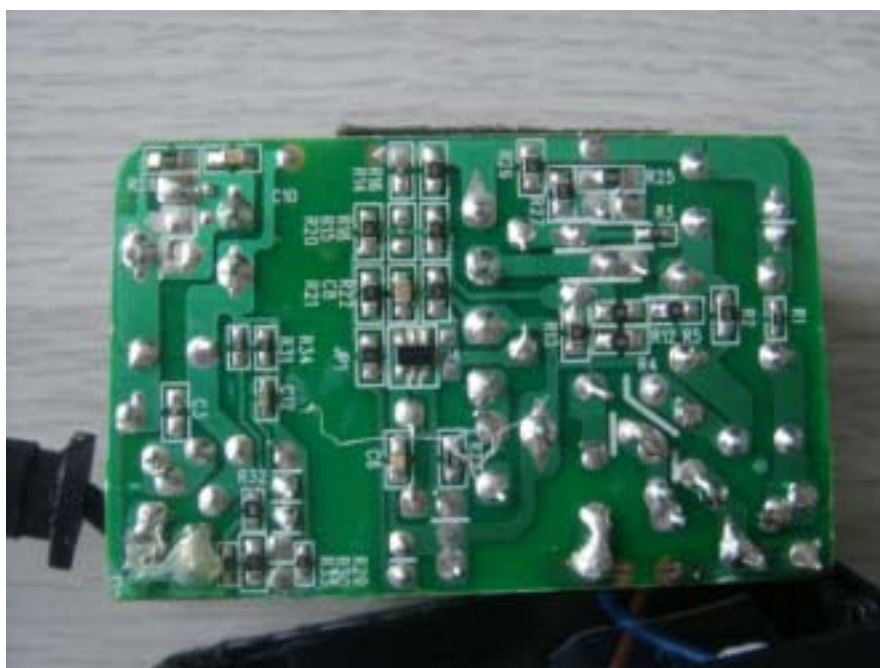



7. APPENDIX A - INFORMATION ON THE TESTING LABORATORY

We, ADT (Shanghai) Corp., was founded in 2003 to provide our best service in EMC, Radio, Telecom and Safety consultation. Our laboratory is accredited and approved by the following approval agencies according to ISO / IEC 17025 (2005).

The client should not use it to claim product endorsement by CNAS, A2LA, or any government agency.

Japan	VCCI
USA	FCC, A2LA
Norway	DNV
China	CNAS



Copies of accreditation certificates of our laboratory obtained from approval agencies can be downloaded from our web site: www.cnadt.com

If you have any comments, please feel free to contact us at the following:

ADT (Shanghai) Corporation

TEL :86-21-6465-9091

Fax : 86-21-6465-9092

Email: service@adt-sh.com

Web Site: www.cnadt.com

8. APPENDIX B - UNCERTAINTY IN EMC MEASUREMENT

As specified in CISPR 16-4-2, measurement instrumentation uncertainty shall be taken into account when determining compliance or non-compliance with a disturbance limit. A disturbance limit shall be determined in the following manner:

If U_{lab} is less than or equal to U_{cispr} in table 1, then:

Compliance is deemed to occur if no measured disturbance exceeds the disturbance limit;

Non-compliance is deemed to occur if any measured disturbance exceeds the disturbance limit.

If U_{lab} is greater than or equal to U_{cispr} in table 1, then:

Compliance is deemed to occur if no measured disturbance, increased by $(U_{lab} - U_{cispr})$, exceeds the disturbance limit;

Non-compliance is deemed to occur if any measured disturbance, increased by $(U_{lab} - U_{cispr})$, exceeds the disturbance limit.

Table 1 – Values of U_{cispr}

Measurement		U_{cispr}
Conducted disturbance (mains port)	(9kHz – 150kHz) (150kHz – 30MHz)	4,0 dB 3,6 dB
Disturbance power	(30MHz – 300MHz)	4,5 dB
Radiated disturbance (electric field strength on an open area test site or alternative test site)	(30MHz – 1000MHz)	5,2 dB
Other		Under consideration

ADT Shanghai hereby declare the U lab value are as the following:

Conducted test performed at SR1 shielded room with U_{lab} values: +/- 2.55 dB

Radiated test performed at SAC Chamber with U_{lab} values: +/- 2.98 dB

Based on the above specification, the U_{lab} values of our sites are less than U_{cispr} in table 1 and compliance is deemed to occur if no measured disturbance exceeds the disturbance limit.