



A D T

# FCC TEST REPORT (PART 22)

**REPORT NO.:** RF990108H03-1

**MODEL NO.:** DIR-456

**RECEIVED:** Jan. 08, 2010

**TESTED:** Jan. 21 to 29, 2010

**ISSUED:** Mar. 29, 2010

**APPLICANT:** D-Link Co.

**ADDRESS:** No.289, Shinhu 3rd Rd., Neihu District, Taipei City  
114, Taiwan, R.O.C.

**ISSUED BY:** Bureau Veritas Consumer Products Services (H.K.)  
Ltd., Taoyuan Branch Hsin Chu Laboratory

**ADDRESS:** No. 81-1, Lu Liao Keng, 9th Ling, Wu Lung Tsuen,  
Chiung Lin Hsiang, Hsin Chu Hsien 307, Taiwan

This test report consists of 83 pages in total. It may be duplicated completely for legal use with the approval of the applicant. It should not be reproduced except in full, without the written approval of our laboratory. The client should not use it to claim product endorsement by any government agencies. The test results in the report only apply to the tested sample.





## TABLE OF CONTENTS

1	CERTIFICATION .....	4
2	SUMMARY OF TEST RESULTS .....	5
2.1	MEASUREMENT UNCERTAINTY .....	6
3	GENERAL INFORMATION .....	7
3.1	GENERAL DESCRIPTION OF EUT .....	7
3.2	DESCRIPTION OF TEST MODES .....	10
3.2.1	TEST MODE APPLICABILITY AND TESTED CHANNEL DETAIL .....	12
3.3	GENERAL DESCRIPTION OF APPLIED STANDARDS .....	15
3.4	DESCRIPTION OF SUPPORT UNITS.....	16
3.5	CONFIGURATION OF SYSTEM UNDER TEST .....	17
4	TEST TYPES AND RESULTS .....	18
4.1	OUTPUT POWER MEASUREMENT .....	18
4.1.1	LIMITS OF OUTPUT POWER MEASUREMENT.....	18
4.1.2	TEST INSTRUMENTS.....	19
4.1.3	TEST PROCEDURES .....	20
4.1.4	TEST SETUP .....	21
4.1.5	EUT OPERATING CONDITIONS .....	22
4.1.6	TEST RESULTS .....	23
4.2	FREQUENCY STABILITY MEASUREMENT .....	31
4.2.1	LIMITS OF FREQUENCY STABILITY MEASUREMENT .....	31
4.2.2	TEST INSTRUMENTS.....	31
4.2.3	TEST PROCEDURE.....	32
4.2.4	TEST SETUP .....	32
4.2.5	TEST RESULTS .....	33
4.3	OCCUPIED BANDWIDTH MEASUREMENT.....	35
4.3.1	LIMITS OF OCCUPIED BANDWIDTH MEASUREMENT .....	35
4.3.2	TEST INSTRUMENTS.....	35
4.3.3	TEST SETUP .....	35
4.3.4	TEST PROCEDURES .....	36
4.3.5	EUT OPERATING CONDITION.....	36
4.3.6	TEST RESULTS .....	37
4.4	BAND EDGE MEASUREMENT .....	45
4.4.1	LIMITS OF BAND EDGE MEASUREMENT.....	45
4.4.2	TEST INSTRUMENTS.....	45
4.4.3	TEST SETUP .....	45
4.4.4	TEST PROCEDURES .....	46
4.4.5	EUT OPERATING CONDITION.....	46
4.4.6	TEST RESULTS .....	47
4.5	CONDUCTED SPURIOUS EMISSIONS.....	51
4.5.1	LIMITS OF CONDUCTED SPURIOUS EMISSIONS MEASUREMENT .....	51
4.5.2	TEST INSTRUMENTS.....	51
4.5.3	TEST PROCEDURE.....	52



4.5.4	TEST SETUP .....	52
4.5.5	EUT OPERATING CONDITIONS .....	52
4.5.6	TEST RESULTS .....	53
4.6	RADIATED EMISSION MEASUREMENT (BELOW 1GHZ) .....	65
4.6.1	LIMITS OF RADIATED EMISSION MEASUREMENT .....	65
4.6.2	TEST INSTRUMENTS.....	66
4.6.3	TEST PROCEDURES .....	67
4.6.4	DEVIATION FROM TEST STANDARD .....	68
4.6.5	TEST SETUP .....	68
4.6.6	EUT OPERATING CONDITIONS .....	68
4.6.7	TEST RESULTS .....	69
4.7	RADIATED EMISSION MEASUREMENT (ABOVE 1GHZ) .....	71
4.7.1	LIMITS OF RADIATED EMISSION MEASUREMENT .....	71
4.7.2	TEST INSTRUMENTS.....	72
4.7.3	TEST PROCEDURES .....	73
4.7.4	DEVIATION FROM TEST STANDARD .....	73
4.7.5	TEST SETUP .....	74
4.7.6	EUT OPERATING CONDITIONS .....	74
4.7.7	TEST RESULTS .....	75
5	PHOTOGRAPHS OF THE TEST CONFIGURATION.....	81
6	INFORMATION ON THE TESTING LABORATORIES .....	82
7	APPENDIX A – MODIFICATIONS RECORDERS FOR ENGINEERING CHANGES TO THE EUT BY THE LAB .....	83



A D T

## 1 CERTIFICATION

**PRODUCT :** Residential USIM Embedded HSDPA 3G Router  
**BRAND :** D-Link  
**MODEL NO.:** DIR-456  
**APPLICANT :** D-Link Co.  
**TESTED :** Jan. 21 to 29, 2010  
**TEST SAMPLE :** MASS-PRODUCTION  
**STANDARDS :** **FCC Part 22, Subpart H**  
ANSI C63.4-2003

The above equipment (model: DIR-456) has been tested by **Bureau Veritas Consumer Products Services (H.K.) Ltd., Taoyuan Branch**, and found compliance with the requirement of the above standards. The test record, data evaluation & Equipment Under Test (EUT) configurations represented herein are true and accurate accounts of the measurements of the sample's EMC characteristics under the conditions specified in this report.

**PREPARED BY :** Midoli Peng , **DATE:** Mar. 29, 2010  
( Midoli Peng, Specialist )

**TECHNICAL ACCEPTANCE :** Hank Chung , **DATE:** Mar. 29, 2010  
( Hank Chung, Deputy Manager )

**APPROVED BY :** May Chen , **DATE:** Mar. 29, 2010  
( May Chen, Deputy Manager )



A D T

## 2 SUMMARY OF TEST RESULTS

The EUT has been tested according to the following specifications:

APPLIED STANDARD: FCC Part 22 & Part 2			
STANDARD SECTION	TEST TYPE AND LIMIT	RESULT	REMARK
2.1047 (d)	Modulation Characteristics	PASS	Meet the requirement of limit.
2.1046 22.913 (a)	Maximum Peak Output Power Limit: max. 7 watts e.r.p peak power	PASS	Meet the requirement of limit.
2.1055	Frequency Stability AFC Freq. Error vs. Voltage AFC Freq. Error vs. Temperature Limit: max. $\pm 2.5$ ppm	PASS	Meet the requirement of limit.
2.1049 (h)	Occupied Bandwidth	PASS	Meet the requirement of limit.
22.917	Band Edge Measurements	PASS	Meet the requirement of limit.
2.1051 22.917	Conducted Spurious Emissions	PASS	Meet the requirement of limit.
2.1053 22.917	Radiated Spurious Emissions	PASS	Meet the requirement of limit. Minimum passing margin is -43.92dB at 2509.2MHz.

## 2.1 MEASUREMENT UNCERTAINTY

Where relevant, the following measurement uncertainty levels have been estimated for tests performed on the EUT as specified in CISPR 16-4-2:

This uncertainty represents an expanded uncertainty expressed at approximately the 95% confidence level using a coverage factor of  $k=2$ .

Measurement	Value
Conducted emissions	2.45 dB
Radiated emissions (30MHz-1GHz)	3.94 dB
Radiated emissions (1GHz -18GHz)	2.49 dB
Radiated emissions (18GHz -40GHz)	2.70 dB



A D T

### 3 GENERAL INFORMATION

#### 3.1 GENERAL DESCRIPTION OF EUT

<b>PRODUCT</b>	Residential USIM Embedded HSDPA 3G Router
<b>MODEL NO.</b>	DIR-456
<b>FCC ID</b>	KA2DIR456A1
<b>POWER SUPPLY</b>	12V from power adapter
<b>MODULATION TYPE</b>	GMSK / 8PSK / BPSK
<b>OPERATING FREQUENCY</b>	824MHz ~ 849MHz
<b>NUMBER OF CHANNEL</b>	124 (GSM band) / 102 (WCDMA band)
<b>MAX. ERP POWER</b>	GSM Mode: 30.2dBm (1.0411Watts) GPRS Mode: 30.1dBm (1.0315Watts) E-GPRS Mode: 28.0dBm (0.6351Watts) WCDMA Mode: 24.1dBm (0.2546Watts)
<b>ANTENNA TYPE</b>	Please see note 1
<b>MAX. ANTENNA GAIN</b>	Please see note 1
<b>DATA CABLE</b>	RJ-11 Cable (Unshielded, 1.8m) Ethernet cable (Unshielded, 1.5m)
<b>I/O PORTS</b>	WAN Port x1 (Ethernet (10,100Mbps)) LAN Port x1 (Ethernet (10,100Mbps)) PHONE Port x1 3G SIM Port x1
<b>ACCESSORY DEVICES</b>	Adapter x1

**NOTE:**

- There are two antennas provided to this EUT, please refer to the following table:

Ant.	Manufacture	ANT Type	ANT Model	Connector
Main	Auden Techno Corp.	PCB Antenna	H-0124-1	I-PEX
Aux	Auden Techno Corp.	PCB Antenna	H-0124-2	I-PEX

**Antenna Gain**

Ant.	Peak Gain	CELL850 (dBi)	EGSM900 (dBi)	DCS1800 (dBi)	DCS1900 (dBi)	WCDMA2100 (dBi)
Main	TX	0	0.3	1.9	3.0	3.2
	RX	0.4	-0.1	2.7	3.1	1.2
Ant.	Peak Gain	CELL850 (dBi)	EGSM900 (dBi)	DCS1800 (dBi)	DCS1900 (dBi)	WCDMA2100 (dBi)
Aux	TX	NA	NA	NA	NA	NA
	RX	0.6	-1.5	0.3	0.1	-1.4

- The EUT's appearance has two different colors (black and white).
- The EUT must be supplied with a power adapter and following two different models could be chosen:

<b>Adapter 1</b>	
<b>Brand:</b>	D-Link
<b>Model No.:</b>	AMS4-1202000SU
<b>Input power :</b>	100-240V, 0.8A, 60Hz
<b>Output power :</b>	+12V, 2.0A DC Power cord: 1.5m/ Without core/ Non shielded
<b>Adapter 2</b>	
<b>Brand:</b>	D-Link
<b>Model No.:</b>	CG2412-B
<b>Input power :</b>	100-240V, 0.5A, 50/60Hz
<b>Output power :</b>	+12V, 2.0A DC Power cord: 1.5m/ Without core/ Non shielded

The EUT was pre-tested in chamber with above adapters, the radiated emission worst case was found in model: **AMS4-1202000SU**. Therefore only the test data of the mode was recorded in this report.

- The EUT is a Residential USIM Embedded HSDPA 3G Router. The functions of EUT listed as below table:

FUNCTIONS	TEST STANDARD	REFERENCE REPORT
WLAN 802.11b/g	FCC Part 15	RF990108H03
GSM 850 / WCDMA 850	FCC Part 22	RF990108H03-1
PCS 1900 / WCDMA 1900	FCC Part 24	RF990108H03-2





A D T

5. The communicated functions of EUT listed as below:

		GSM850MHz	PCS1900MHz	WCDMA850MHz	WCDMA1900MHz
2G	GSM	√	√		
	GPRS	√	√		
	E-GPRS	√	√		
3G	WCDMA			√	√
	Release 5 HSDPA			√	√

6. The EUT was pre-tested under the following modes:

Test Mode	Description
Mode A	Level-set
<b>Mode B</b>	<b>Tower-set</b>

From the above modes, the radiated emission worst case was found in **Mode B**. Therefore only the test data of the mode was recorded in this report.

7. The above EUT information was declared by manufacturer and for more detailed features description, please refer to the manufacturer's specifications or user's manual.

## 3.2 DESCRIPTION OF TEST MODES

### FOR GSM BAND:

124 channels are provided to this EUT in the GSM850 band. Therefore, the low, middle and high channels are chosen for testing.

	CHANNEL	FREQUENCY	TX MODE
LOW	128	824.2 MHz	GSM, GPRS, E-GPRS
MIDDLE	190	836.6 MHz	GSM, GPRS, E-GPRS
HIGH	251	848.8 MHz	GSM, GPRS, E-GPRS

#### NOTE:

1. Below 1 GHz, the channel 128, 190, and 251 were pre-tested in chamber. The channel 128 was chosen for final test.
2. Above 1 GHz, the channel 128, 190, and 251 were tested individually.
3. The worst case for final test is chosen when the power control level set 5.
4. The channel space is 0.2MHz.
5. The EUT is a GPRS class 12 device, which provide 4 up-link. After pre-tested both functions, found up-link with 1 time slot is worse, therefore, test results of output power, frequency stability, occupied bandwidth and band edge tests came out from this.
6. The EUT is an E-GPRS class 12 device, which provide 4 up-link. After pre-tested both functions, found up-link with 1 time slot is worse, therefore, test results of output power, frequency stability, occupied bandwidth and band edge tests came out from this.
7. The EUT has GSM, GPRS, E-GPRS functions. After pre-testing, GSM function is the worst case for all the emission tests.



A D T

### FOR WCDMA BAND:

102 channels are provided to this EUT in the WCDMA850 band. Therefore, the low, middle and high channels are chosen for testing.

	CHANNEL	FREQUENCY	TX MODE
LOW	4132	826.4 MHz	WCDMA
MIDDLE	4182	836.4 MHz	WCDMA
HIGH	4233	846.6 MHz	WCDMA

#### NOTE:

1. Below 1 GHz, the channel 4132, 4182 and 4233 were pre-tested in chamber. The channel 4132 was chosen for final test.
2. Above 1 GHz, the channel 4132, 4182 and 4233 were tested individually.
3. The channel space is 0.2MHz.
4. (RMC, WCDMA Inactive) mode has been chosen for the worst case to do the final test and record.

### 3.2.1 TEST MODE APPLICABILITY AND TESTED CHANNEL DETAIL

EUT CONFIGURE MODE	APPLICABLE TO							DESCRIPTION
	OP	FS	OB	BE	CE	RE<1G	RE≥1G	
A	√	√	√	√	√	√	√	GSM BAND
B	√	√	√	√	√	√	√	WCDMA BAND

Where **OP**: Output power **FS**: Frequency stability  
**OB**: Occupied bandwidth **BE**: Band edge  
**CE**: Conducted spurious emissions **RE<1G**: Radiated emission below 1GHz  
**RE≥1G**: Radiated emission above 1GHz

#### **OUTPUT POWER MEASUREMENT:**

- Pre-Scan has been conducted to determine the worst-case mode from all possible combinations between available modulations, data rates, xyz axis and antenna ports (if EUT with antenna diversity architecture).
- Following channel(s) was (were) selected for the final test as listed below.

AVAILABLE CHANNEL	TESTED CHANNEL	MODULATION TECHNOLOGY
128 to 251	128, 190, 251	GSM, GPRS, E-GPRS
4132 to 4233	4132, 4182, 4233	WCDMA

#### **FREQUENCY STABILITY MEASUREMENT:**

- Pre-Scan has been conducted to determine the worst-case mode from all possible combinations between available modulations, data rates, and antenna ports (if EUT with antenna diversity architecture).
- Following channel(s) was (were) selected for the final test as listed below.

AVAILABLE CHANNEL	TESTED CHANNEL	MODULATION TECHNOLOGY
128 to 251	190	GSM
4132 to 4233	4182	WCDMA



**OCCUPIED BANDWIDTH MEASUREMENT:**

- Pre-Scan has been conducted to determine the worst-case mode from all possible combinations between available modulations, data rates, and antenna ports (if EUT with antenna diversity architecture).
- Following channel(s) was (were) selected for the final test as listed below.

AVAILABLE CHANNEL	TESTED CHANNEL	MODULATION TECHNOLOGY
128 to 251	128, 190, 251	GSM, GPRS, E-GPRS
4132 to 4233	4132, 4182, 4233	WCDMA

**BAND EDGE MEASUREMENT:**

- Pre-Scan has been conducted to determine the worst-case mode from all possible combinations between available modulations, data rates, and antenna ports (if EUT with antenna diversity architecture).
- Following channel(s) was (were) selected for the final test as listed below.

AVAILABLE CHANNEL	TESTED CHANNEL	MODULATION TECHNOLOGY
128 to 251	128, 251	GSM, GPRS, E-GPRS
4132 to 4233	4132, 4233	WCDMA

**CONDUCTED SPURIOUS EMISSIONS MEASUREMENT:**

- Pre-Scan has been conducted to determine the worst-case mode from all possible combinations between available modulations, data rates, and antenna ports (if EUT with antenna diversity architecture).
- Following channel(s) was (were) selected for the final test as listed below.

AVAILABLE CHANNEL	TESTED CHANNEL	MODULATION TECHNOLOGY
128 to 251	128, 190, 251	GSM
4132 to 4233	4132, 4182, 4233	WCDMA



**RADIATED EMISSION MEASUREMENT (BELOW 1 GHz):**

- Pre-Scan has been conducted to determine the worst-case mode from all possible combinations between available modulations, data rates, xyz axis and antenna ports (if EUT with antenna diversity architecture).
- Following channel(s) was (were) selected for the final test as listed below.

AVAILABLE CHANNEL	TESTED CHANNEL	MODULATION TECHNOLOGY
128 to 251	251	GSM
4132 to 4233	4233	WCDMA

**RADIATED EMISSION MEASUREMENT (ABOVE 1 GHz):**

- Pre-Scan has been conducted to determine the worst-case mode from all possible combinations between available modulations, data rates, xyz axis and antenna ports (if EUT with antenna diversity architecture).
- Following channel(s) was (were) selected for the final test as listed below.

AVAILABLE CHANNEL	TESTED CHANNEL	MODULATION TECHNOLOGY
128 to 251	128, 190, 251	GSM
4132 to 4233	4132, 4182, 4233	WCDMA

### **3.3 GENERAL DESCRIPTION OF APPLIED STANDARDS**

The EUT is a RF product. According to the specifications of the manufacturer, it must comply with the requirements of the following standards:

**FCC 47 CFR Part 2**

**FCC 47 CFR Part 22**

**IC RSS-132**

**ANSI C63.4-2003**

**ANSI/TIA/EIA-603-C 2004**

**NOTE:** All test items have been performed and recorded as per the above standards.



### 3.4 DESCRIPTION OF SUPPORT UNITS

The EUT has been tested as an independent unit together with other necessary accessories or support units. The following support units or accessories were used to form a representative test configuration during the tests.

NO.	PRODUCT	BRAND	MODEL NO.	SERIAL NO.	FCC ID
1	NOTEBOOK COMPUTER	DELL	PP18L	6976685584	FCC DoC
2	NOTEBOOK COMPUTER	DELL	PP17L	CN-ONF743-48643-7AV-0124	FCC DoC
3	NOTEBOOK COMPUTER	DELL	D531	CN-0XM006-48643-86L-4472	QDS-BRCM1019
4	TELEPHONE	Romeo	TE-812	97280926	NA
5	Universal Radio Communication Tester	R&S	CMU200	101095	NA
6	HUB	ZyXEL	ES-116P	S060H02000215	FCC DoC

NO.	SIGNAL CABLE DESCRIPTION OF THE ABOVE SUPPORT UNITS
1	UTP cable (Unshielded, 10m)
2	UTP cable (Unshielded, 10m)
3	NA
4	RJ-11 cable (Unshielded, 10m)
5	NA
6	UTP cable (Unshielded, 10m)

**NOTE:** All power cords of the above support units are non shielded (1.8m).



### 3.5 CONFIGURATION OF SYSTEM UNDER TEST

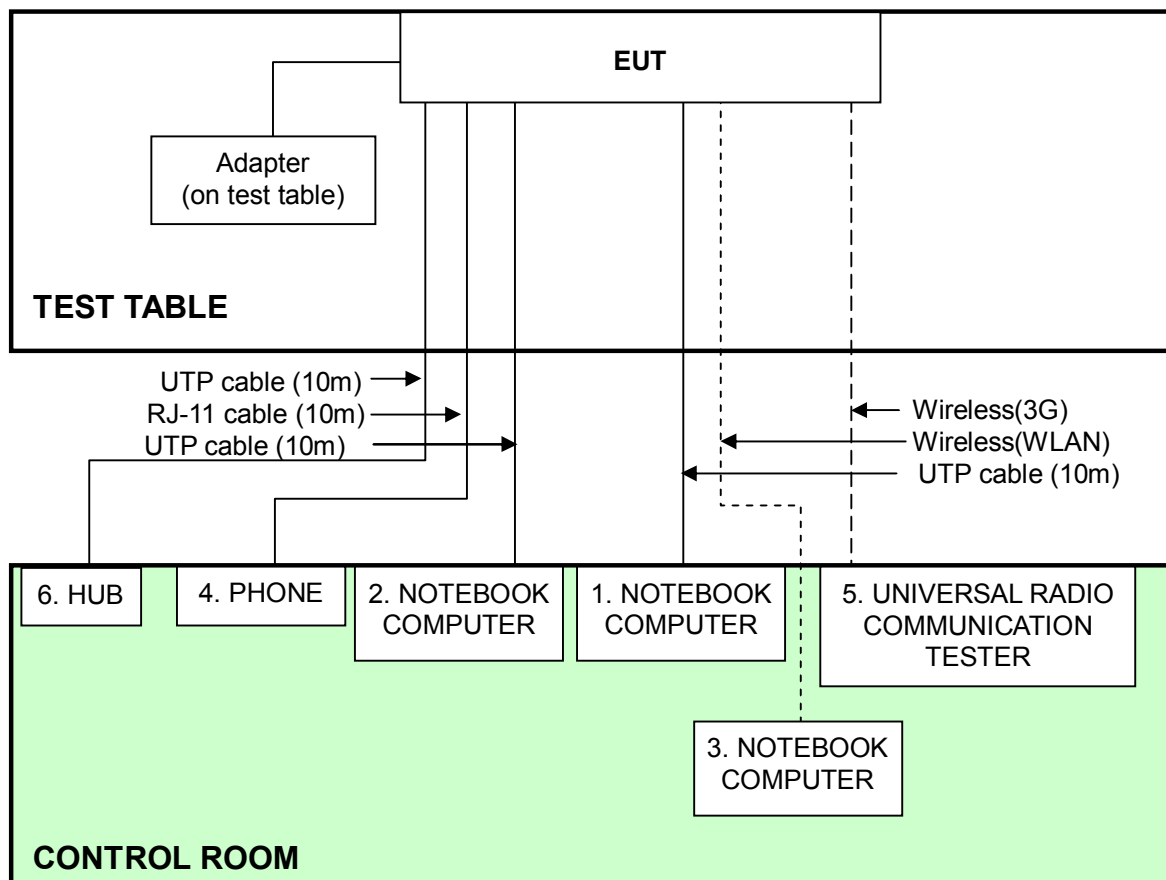

## **4 TEST TYPES AND RESULTS**

### **4.1 OUTPUT POWER MEASUREMENT**

#### **4.1.1 LIMITS OF OUTPUT POWER MEASUREMENT**

The radiated peak output power shall be according to the specific rule Part 22.913 (a) that “Mobile / Portable station are limited to 7 watts e.r.p”.



A D T

#### 4.1.2 TEST INSTRUMENTS

DESCRIPTION & MANUFACTURER	MODEL NO.	SERIAL NO.	CALIBRATED DATE	CALIBRATED UNTIL
ROHDE & SCHWARZ Spectrum Analyzer	FSP40	100036	Dec. 18, 2009	Dec. 17, 2010
Agilent PSA Spectrum Analyzer	E4446A	MY46180622	Apr. 24 , 2009	Apr. 23 , 2010
HP Pre_Amplifier	8449B	300801923	Nov. 02, 2009	Nov. 01, 2010
ROHDE & SCHWARZ Test Receiver	ESCS30	847124/029	Aug. 28, 2009	Aug. 27, 2010
SCHWARZBECK TRILOG Broadband Antenna	VULB 9168	138	April 29, 2009	April 28, 2010
Schwarzbeck Horn_Antenna	BBHA9120	D124	Dec. 18, 2009	Dec. 17, 2010
Schwarzbeck Horn_Antenna	BBHA 9170	BBHA9170153	Jan. 21, 2010	Jan. 20, 2011
RF Switches	EMH-011	1001	NA	NA
RF CABLE (Chaintek)	Sucoflex 106	28077	Aug. 14, 2009	Aug. 13, 2010
RF Cable	8DFB	STCCAB-30M-1GHz	NA	NA
Software	ADT_Radiated_V7.6.15.9.2	NA	NA	NA
CT Antenna Tower & Turn Table	NA	NA	NA	NA

Note: 1. The calibration interval of the above test instruments is 12 months and the calibrations are traceable to NML/ROC and NIST/USA.

2. The horn antenna, HP preamplifier (model: 8449B) and Spectrum Analyzer (model: FSP40) are used only for the measurement of emission frequency above 1GHz if tested.

3. The test was performed in Open Site No. C.

4. The FCC Site Registration No. is 656396.

5. The VCCI Site Registration No. is R-1626.

6. The CANADA Site Registration No. is IC 7450G-3.

#### 4.1.3 TEST PROCEDURES

- a. The power was measured with R&S Spectrum Analyzer. All measurements were done at 3 channels, 128, 190 and 251 / 4132, 4182 and 4233 (low, middle and high operational frequency range.)
- b. The conducted peak output power used the power splitter via EUT RF power connector between simulation base station and spectrum analyzer. The path loss included the splitter loss, cable loss and 20dB pad loss. The spectrum set RB/VB 1MHz (GSM) and 5MHz (WCDMA), then read peak power value and record to the test. (All transmitted path loss shall be considered in the test report data.)
- c. E.I.R.P peak power measurement. In the open area test site, EUT placed on the 0.8m height of Turn Table, rotated the table around 360 degrees to search the maximum radiation power and receiver antenna shall be rotated vertical and horizontal polarization to find the maximum polar radiated power. The “Read Value” is the spectrum reading the maximum power value.
- d. The substitution horn antenna is substituted for EUT at the same position and signals generator export the CW signal to the calibration antenna. Rotated the Turn Table to find the maximum radiation power. “Raw” is the spectrum reading value, “SG” is signal generator export power, “TX Gain” is calibration antenna isotropic gain value, “TX cable” is the transmitted cable loss between the calibration antenna and signal generator. The “Factor” means that the transmission path loss is equal to “SG” - “TX cable” + “TX Gain” – “Raw”.
- e. Actually the real E.I.R.P peak power is equal to “Read Value” + “Factor”
- f. E.R.P power can be calculated form E.I.R.P power by subtracting the gain of dipole,  
 $E.R.P \text{ power} = E.I.P.R \text{ power} - 2.15\text{dBi}$ .

**NOTE:** The resolution bandwidth and video bandwidth of test receiver/spectrum analyzer is 3MHz for Peak detection (PK)

#### 4.1.4 TEST SETUP

##### EIRP POWER MEASUREMENT:

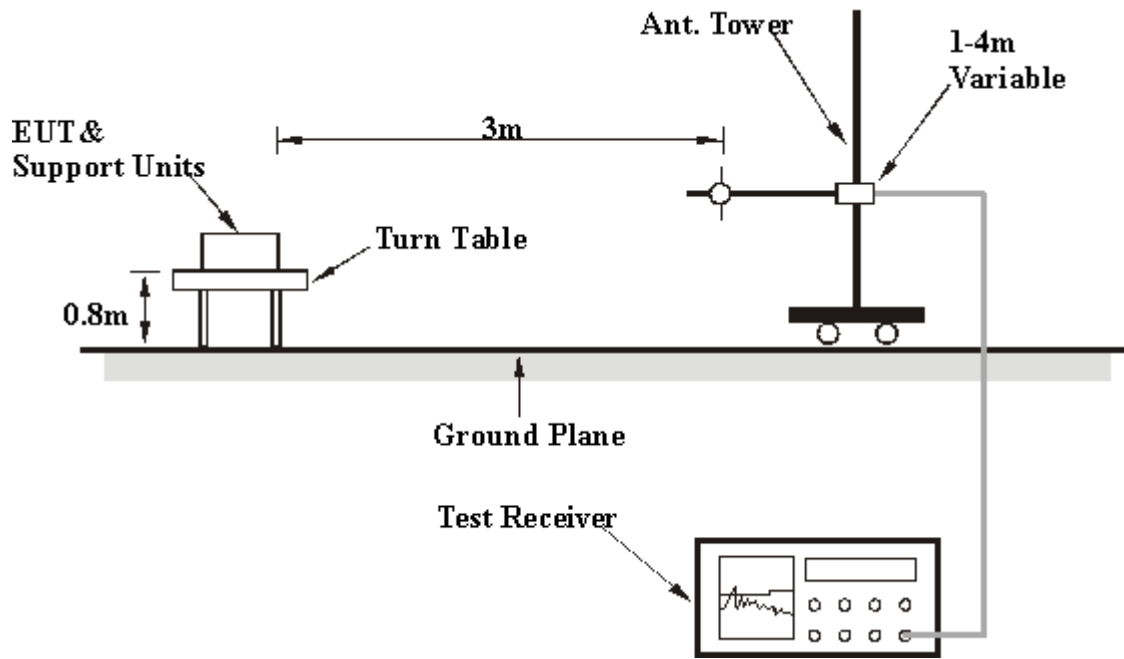

For the actual test configuration, please refer to the attached file (Test Setup Photo).

##### CONDUCTED POWER MEASUREMENT:

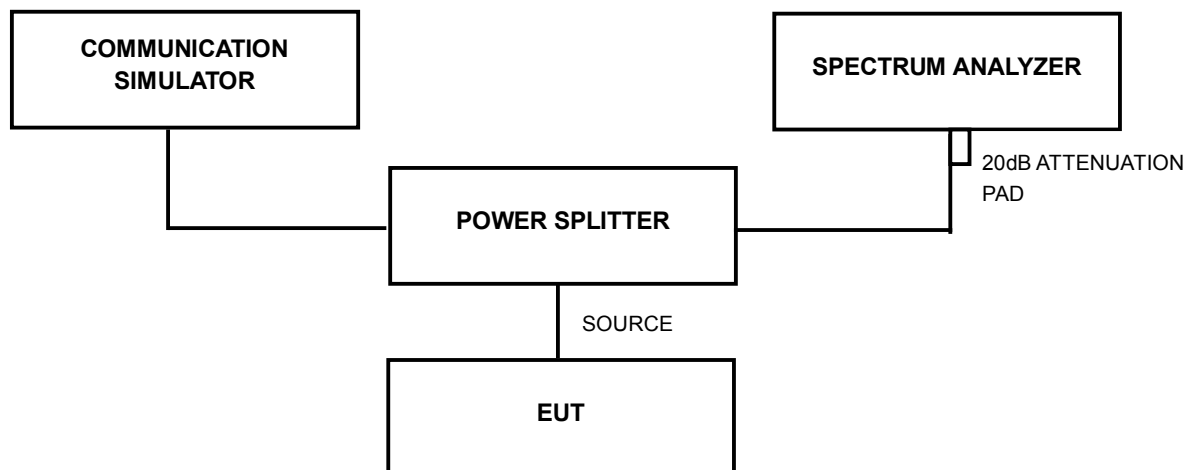

For the actual test configuration, please refer to the related item – Photographs of the Test Configuration.



A D T

#### 4.1.5 EUT OPERATING CONDITIONS

The communication simulator station system controlled a EUT to export maximum output power under transmission mode and specific channel frequency.

#### 4.1.6 TEST RESULTS

##### FOR GSM BAND:

<b>MODE</b>	TX connected	<b>POWER CONTROL LEVEL</b>	5
<b>INPUT POWER</b>	120Vac, 60 Hz	<b>DETECTOR FUNCTION</b>	Peak / RMS
<b>ENVIRONMENTAL CONDITIONS</b>	18deg. C, 63%RH, 1024hPa	<b>TESTED BY</b>	Wen Yu

##### FOR GSM MODE

CONDUCTED PEAK OUTPUT POWER					
CHANNEL NO.	FREQUENCY (MHz)	RAW VALUE (dBm)	CORRECTION FACTOR (dB)	PEAK OUTPUT POWER	
				dBm	Watt
128	824.2	27.0	5.0	32.0	1.5849
190	836.6	27.1	5.0	32.1	1.6218
251	848.8	27.2	5.0	32.2	1.6596

CONDUCTED RMS OUTPUT POWER					
CHANNEL NO.	FREQUENCY (MHz)	RAW VALUE (dBm)	CORRECTION FACTOR (dB)	RMS OUTPUT POWER	
				dBm	Watt
128	824.2	26.7	5.0	31.7	1479.1
190	836.6	26.8	5.0	31.8	1513.6
251	848.8	26.7	5.0	31.7	1479.1

**REMARKS:** 1. Peak Output Power (dBm) = Raw Value (dBm) + Correction Factor (dB).  
2. Correction Factor (dB) = Power Splitter Loss (dB) + Cable Loss (dB).



A D T

**FOR GPRS MODE (UP-LINK WITH 1 TIME SLOT)**

CONDUCTED PEAK OUTPUT POWER					
CHANNEL NO.	FREQUENCY (MHz)	RAW VALUE (dBm)	CORRECTION FACTOR (dB)	PEAK OUTPUT POWER	
				dBm	Watt
128	824.2	26.9	5.0	31.9	1.5488
190	836.6	27.0	5.0	32.0	1.5849
251	848.8	27.0	5.0	32.0	1.5849

CONDUCTED RMS OUTPUT POWER					
CHANNEL NO.	FREQUENCY (MHz)	RAW VALUE (dBm)	CORRECTION FACTOR (dB)	RMS OUTPUT POWER	
				dBm	Watt
128	824.2	26.6	5.0	31.6	1445.4
190	836.6	26.9	5.0	31.9	1548.8
251	848.8	26.9	5.0	31.9	1548.8

**REMARKS:** 1. Peak Output Power (dBm) = Raw Value (dBm) + Correction Factor (dB).  
2. Correction Factor (dB) = Power Splitter Loss (dB) + Cable Loss (dB).

**FOR E-GPRS MODE (UP-LINK WITH 1 TIME SLOT)**

CONDUCTED PEAK OUTPUT POWER					
CHANNEL NO.	FREQUENCY (MHz)	RAW VALUE (dBm)	CORRECTION FACTOR (dB)	PEAK OUTPUT POWER	
				dBm	Watt
128	824.2	25.1	5.0	30.1	1.0233
190	836.6	25.2	5.0	30.2	1.0471
251	848.8	25.5	5.0	30.5	1.1220

CONDUCTED RMS OUTPUT POWER					
CHANNEL NO.	FREQUENCY (MHz)	RAW VALUE (dBm)	CORRECTION FACTOR (dB)	RMS OUTPUT POWER	
				dBm	Watt
128	824.2	24.8	5.0	29.8	955.0
190	836.6	24.9	5.0	29.9	977.2
251	848.8	25.2	5.0	30.2	1047.1

**REMARKS:** 1. Peak Output Power (dBm) = Raw Value (dBm) + Correction Factor (dB).  
2. Correction Factor (dB) = Power Splitter Loss (dB) + Cable Loss (dB).





A D T

<b>MODE</b>	TX connected	<b>POWER CONTROL LEVEL</b>	5
<b>INPUT POWER</b>	120Vac, 60 Hz	<b>DETECTOR FUNCTION</b>	Peak
<b>ENVIRONMENTAL CONDITIONS</b>	18deg. C, 63%RH, 1024hPa	<b>TESTED BY</b>	Wen Yu

**FOR GSM MODE**

ERP POWER					
CHANNEL NO.	FREQUENCY (MHz)	RAW VALUE (dBm)	CORRECTION FACTOR (dB)	PEAK OUTPUT POWER	
				dBm	Watt
128	824.2	28.4	1.3	29.7	0.9393
190	836.6	29.0	1.2	30.2	1.0396
251	848.8	29.2	1.0	30.2	1.0411

**FOR GPRS MODE (UP-LINK WITH 1 TIME SLOT)**

ERP POWER					
CHANNEL NO.	FREQUENCY (MHz)	RAW VALUE (dBm)	CORRECTION FACTOR (dB)	PEAK OUTPUT POWER	
				dBm	Watt
128	824.2	28.7	1.3	30.0	1.0065
190	836.6	28.9	1.2	30.1	1.0301
251	848.8	29.1	1.0	30.1	1.0315

**FOR E-GPRS MODE (UP-LINK WITH 1 TIME SLOT)**

ERP POWER					
CHANNEL NO.	FREQUENCY (MHz)	RAW VALUE (dBm)	CORRECTION FACTOR (dB)	PEAK OUTPUT POWER	
				dBm	Watt
128	824.2	26.7	1.3	28.0	0.6351
190	836.6	26.7	1.1	27.9	0.6178
251	848.8	26.9	1.0	27.9	0.6201

- REMARKS:** 1. Peak Output Power (dBm) = Raw Value (dBm) + Correction Factor (dB).  
2. Correction Factor (dB) = Receiver Antenna Gain (dBi) + Cable Loss (dB) + Free Space Loss (dB).

### **FOR WCDMA BAND:**

The following procedures were followed according to FCC “SAR Measurement Procedures for 3G Devices”, October, 2007.

#### Output Power Verification

Maximum output power is verified on the High, Middle and Low channels according to the procedures described in section 5.2 of 3GPP TS 34.121, using the appropriate RMC or AMR with TPC (transmit power control) set to all “1”s for WCDMA/HSDPA or applying the required inner loop power control procedures to maintain maximum output power while HSUPA is active. Results for all applicable physical channel configurations (DPCCH, DPDCHn and spreading codes, HSDPA, HSPA) should be tabulated in the SAR report. All configurations that are not supported by the DUT or cannot be measured due to technical or equipment limitations should be clearly identified.



A D T

<b>MODE</b>	TX connected	<b>POWER CONTROL LEVEL</b>	0
<b>INPUT POWER</b>	120Vac, 60 Hz	<b>DETECTOR FUNCTION</b>	Peak / RMS
<b>ENVIRONMENTAL CONDITIONS</b>	18deg. C, 63%RH, 1024hPa	<b>TESTED BY</b>	Wen Yu

<b>CONDUCTED PEAK OUTPUT POWER (RMC, WCDMA INACTIVE)</b>					
<b>CHANNEL NO.</b>	<b>FREQUENCY (MHz)</b>	<b>RAW VALUE (dBm)</b>	<b>CORRECTION FACTOR (dB)</b>	<b>PEAK OUTPUT POWER</b>	
				<b>dBm</b>	<b>Watt</b>
4132	826.4	21.0	5.0	26.0	0.3981
4182	836.4	21.0	5.0	26.0	0.3981
4233	846.6	20.9	5.0	25.9	0.3890

<b>CONDUCTED RMS OUTPUT POWER (RMC, WCDMA INACTIVE)</b>					
<b>CHANNEL NO.</b>	<b>FREQUENCY (MHz)</b>	<b>RAW VALUE (dBm)</b>	<b>CORRECTION FACTOR (dB)</b>	<b>RMS OUTPUT POWER</b>	
				<b>dBm</b>	<b>Watt</b>
4132	826.4	17.7	5.0	22.7	0.1862
4182	836.4	17.7	5.0	22.7	0.1862
4233	846.6	17.6	5.0	22.6	0.1820

**REMARKS:** 1. Peak Output Power (dBm) = Raw Value (dBm) + Correction Factor (dB).  
2. Correction Factor (dB) = Power Splitter Loss (dB) + Cable Loss (dB).



A D T

<b>MODE</b>	TX connected	<b>POWER CONTROL LEVEL</b>	0
<b>INPUT POWER</b>	120Vac, 60 Hz	<b>DETECTOR FUNCTION</b>	Peak / RMS
<b>ENVIRONMENTAL CONDITIONS</b>	18deg. C, 63%RH, 1024hPa	<b>TESTED BY</b>	Wen Yu

CONDUCTED PEAK OUTPUT POWER (AMR, WCDMA INACTIVE)					
CHANNEL NO.	FREQUENCY (MHz)	RAW VALUE (dBm)	CORRECTION FACTOR (dB)	PEAK OUTPUT POWER	
				dBm	Watt
4132	826.4	20.8	5.0	25.8	0.3802
4182	836.4	21.0	5.0	26.0	0.3981
4233	846.6	20.5	5.0	25.5	0.3548

CONDUCTED RMS OUTPUT POWER (AMR, WCDMA INACTIVE)					
CHANNEL NO.	FREQUENCY (MHz)	RAW VALUE (dBm)	CORRECTION FACTOR (dB)	RMS OUTPUT POWER	
				dBm	Watt
4132	826.4	17.5	5.0	22.5	0.1778
4182	836.4	17.8	5.0	22.8	0.1905
4233	846.6	17.3	5.0	22.3	0.1698

**REMARKS:** 1. Peak Output Power (dBm) = Raw Value (dBm) + Correction Factor (dB).  
2. Correction Factor (dB) = Power Splitter Loss (dB) + Cable Loss (dB).



A D T

<b>MODE</b>	TX connected	<b>POWER CONTROL LEVEL</b>	0
<b>INPUT POWER</b>	120Vac, 60 Hz	<b>DETECTOR FUNCTION</b>	Peak / RMS
<b>ENVIRONMENTAL CONDITIONS</b>	18deg. C, 63%RH, 1024hPa	<b>TESTED BY</b>	Wen Yu

CONDUCTED PEAK OUTPUT POWER (RMC, HSDPA ACTIVE)					
CHANNEL NO.	FREQUENCY (MHz)	RAW VALUE (dBm)	CORRECTION FACTOR (dB)	PEAK OUTPUT POWER	
				dBm	Watt
4132	826.4	20.6	5.0	25.6	0.3631
4182	836.4	20.6	5.0	25.6	0.3631
4233	846.6	20.4	5.0	25.4	0.3467

CONDUCTED RMS OUTPUT POWER (RMC, HSDPA ACTIVE)					
CHANNEL NO.	FREQUENCY (MHz)	RAW VALUE (dBm)	CORRECTION FACTOR (dB)	RMS OUTPUT POWER	
				dBm	Watt
4132	826.4	16.7	5.0	21.7	0.1489
4182	836.4	16.6	5.0	21.6	0.1445
4233	846.6	16.4	5.0	21.4	0.1380

**REMARKS:** 1. Peak Output Power (dBm) = Raw Value (dBm) + Correction Factor (dB).  
2. Correction Factor (dB) = Power Splitter Loss (dB) + Cable Loss (dB).



A D T

<b>MODE</b>	TX connected	<b>POWER CONTROL LEVEL</b>	0
<b>INPUT POWER</b>	120Vac, 60 Hz	<b>DETECTOR FUNCTION</b>	Peak
<b>ENVIRONMENTAL CONDITIONS</b>	18deg. C, 63%RH, 1024hPa	<b>TESTED BY</b>	Wen Yu

ERP POWER					
CHANNEL NO.	FREQUENCY (MHz)	RAW VALUE (dBm)	CORRECTION FACTOR (dB)	PEAK OUTPUT POWER	
				dBm	Watt
4132	826.4	22.6	1.3	23.9	0.2465
4182	836.4	22.9	1.2	24.1	0.2546
4233	846.6	23.0	1.0	24.0	0.2509

**REMARKS:** 1. Peak Output Power (dBm) = Raw Value (dBm) + Correction Factor (dB).

2. Correction Factor (dB) = Receiver Antenna Gain (dBi) + Cable Loss (dB) + Free Space Loss (dB).

## 4.2 FREQUENCY STABILITY MEASUREMENT

### 4.2.1 LIMITS OF FREQUENCY STABILITY MEASUREMENT

According to the FCC part 2.4235 shall be tested the frequency stability. The rule is defined that "The frequency stability shall be sufficient to ensure that the fundamental emission stays within the authorized frequency block." The frequency error rate is according to the JTC standard that the frequency error rate shall be accurate to within 2.5ppm of the received frequency from the base station. The test extreme voltage is according to the 2.1055(d)(1) Vary primary supply voltage from 85 to 115 percent of the nominal value for other than hand carried battery equipment and the extreme temperature rule is comply with the 2.1055(a)(1)  $-30^{\circ}\text{C} \sim 50^{\circ}\text{C}$ .

### 4.2.2 TEST INSTRUMENTS

DESCRIPTION & MANUFACTURER	MODEL NO.	SERIAL NO.	CALIBRATED DATE	CALIBRATED UNTIL
R&S SPECTRUM ANALYZER	FSP40	100037	Aug. 03, 2009	Aug. 02, 2010
OVEN	MHU-225AU	911033	Dec. 17, 2009	Dec. 16, 2010
HUBER+SUHNER	SUCOFLEX104	222684/4	Aug. 15, 2009	Aug. 14, 2010
AC POWER SOURCE	6205	1140503	NA	NA

**NOTE:** The calibration interval of the above test instruments is 12 months. And the calibrations are traceable to NML/ROC and NIST/USA.

#### 4.2.3 TEST PROCEDURE

- a. Because of the measure the carrier frequency under the condition of the AFC lock, it shall be used the mobile station in the GSM / WCDMA link mode. This is accomplished with the use of the R&S CMU200 / JRC NJZ-2000 simulator station. The oven room could control the temperatures and humidity. The GSM link channel is the 190 and the WCDMA link channel is the 4182.
- b. Power must be removed when changing from one temperature to another or one voltage to another voltage. Power warm up is at least 15 min and power applied should perform before recording frequency error.
- c. EUT is connected the external power supply to control the AC input power. The various Volts from the minimum 138 Volts to 102 Volts. Each step shall be record the frequency error rate.
- d. The temperature range step is 10 degrees in this test items. All temperature levels shall be hold the  $\pm 0.5^{\circ}\text{C}$  during the measurement testing.
- e. The each temperature step shall be at least 0.5 hours, consider the EUT could be test under the stability condition.

#### 4.2.4 TEST SETUP

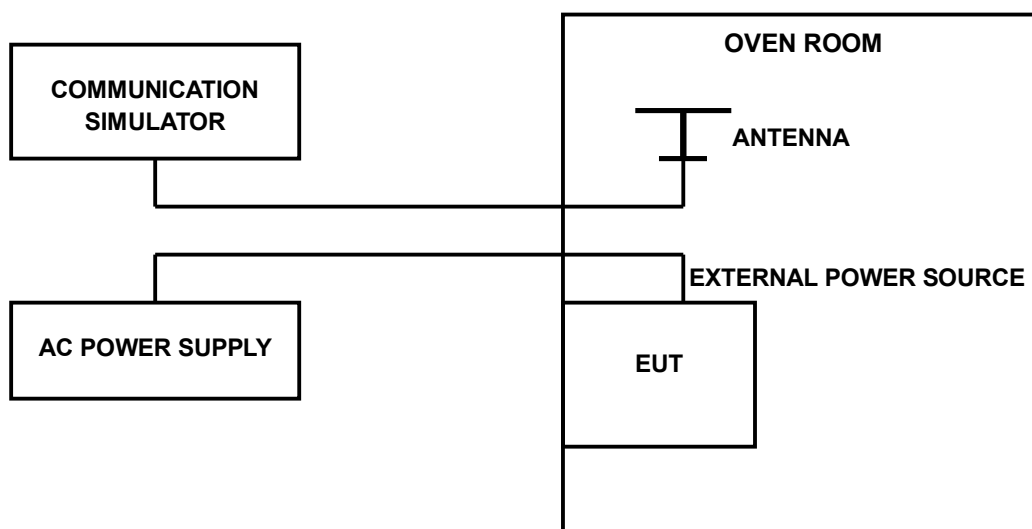





A D T

#### 4.2.5 TEST RESULTS

##### FOR GSM BAND:

<b>MODE</b>	TX Middle channel	<b>POWER CONTROL LEVEL</b>	5
<b>INPUT POWER</b>	120Vac, 60 Hz	<b>ENVIRONMENTAL CONDITIONS</b>	18deg. C, 63%RH, 1024hPa
<b>TESTED BY</b>	Wen Yu		

<b>AFC FREQUENCY ERROR vs. VOLTAGE</b>			
<b>VOLTAGE (Volts)</b>	<b>FREQUENCY ERROR (Hz)</b>	<b>FREQUENCY ERROR (ppm)</b>	<b>LIMIT (ppm)</b>
138	-51	-0.061	2.5
102	-49	-0.059	2.5

<b>AFC FREQUENCY ERROR vs. TEMP.</b>			
<b>TEMP. (°C)</b>	<b>FREQUENCY ERROR (Hz)</b>	<b>FREQUENCY ERROR (ppm)</b>	<b>LIMIT (ppm)</b>
50	-80	-0.096	2.5
40	-75	-0.090	2.5
30	-71	-0.085	2.5
20	-50	-0.060	2.5
10	-49	-0.059	2.5
0	-52	-0.062	2.5
-10	-59	-0.071	2.5



A D T

### FOR WCDMA BAND:

<b>MODE</b>	TX Middle channel	<b>POWER CONTROL LEVEL</b>	0
<b>INPUT POWER</b>	120Vac, 60 Hz	<b>ENVIRONMENTAL CONDITIONS</b>	18deg. C, 63%RH, 1024hPa
<b>TESTED BY</b>	Wen Yu		

<b>AFC FREQUENCY ERROR vs. VOLTAGE</b>			
<b>VOLTAGE (Volts)</b>	<b>FREQUENCY ERROR (Hz)</b>	<b>FREQUENCY ERROR (ppm)</b>	<b>LIMIT (ppm)</b>
138	-64	-0.077	2.5
102	-57	-0.068	2.5

<b>AFC FREQUENCY ERROR vs. TEMP.</b>			
<b>TEMP. (°C)</b>	<b>FREQUENCY ERROR (Hz)</b>	<b>FREQUENCY ERROR (ppm)</b>	<b>LIMIT (ppm)</b>
50	-78	-0.093	2.5
40	-72	-0.086	2.5
30	-56	-0.067	2.5
20	-58	-0.069	2.5
10	-48	-0.057	2.5
0	-65	-0.078	2.5
-10	-75	-0.090	2.5

### 4.3 OCCUPIED BANDWIDTH MEASUREMENT

#### 4.3.1 LIMITS OF OCCUPIED BANDWIDTH MEASUREMENT

According to FCC 2.1049 (h) specified that emission bandwidth is defined as the width of the signal between two points, one below the carrier center frequency and one above the carrier center frequency, outside of which all emissions are attenuated at least 26 dB below the transmitter power.

#### 4.3.2 TEST INSTRUMENTS

DESCRIPTION & MANUFACTURER	MODEL NO.	SERIAL NO.	CALIBRATED DATE	CALIBRATED UNTIL
R&S SPECTRUM ANALYZER	FSP40	100037	Aug. 03, 2009	Aug. 02, 2010
OVEN	MHU-225AU	911033	Dec. 17, 2009	Dec. 16, 2010
HUBER+SUHNER	SUCOFLEX104	222684/4	Aug. 15, 2009	Aug. 14, 2010
AC POWER SOURCE	6205	1140503	NA	NA

**NOTE:** The calibration interval of the above test instruments is 12 months. And the calibrations are traceable to NML/ROC and NIST/USA.

#### 4.3.3 TEST SETUP

Same as Item 4.2.4 (Conducted Power Setup)

#### 4.3.4 TEST PROCEDURES

- a. The EUT was set up for the maximum peak power with GSM / WCDMA link data modulation. The power was measured with R&S Spectrum Analyzer. All measurements were done at 3 channels, 128, 190 and 251 / 4132, 4182 and 4233 (low, middle and high operational frequency range.)
- b. The conducted occupied bandwidth used the power splitter via EUT RF power connector between simulation base station and spectrum analyzer. This splitter loss and cable loss is the worst loss 6dB (GSM band) / 6dB (WCDMA band) in the transmitted path track.
- c. FCC 2.1049 (h) required a measurement bandwidth is the fundamental emission below 26dB bandwidth.

#### 4.3.5 EUT OPERATING CONDITION

Same as Item 4.1.5

### 4.3.6 TEST RESULTS

**FOR GSM BAND:**

**FOR GSM MODE**

CHANNEL	MAX. OUTPUT POWER -26 dBc BANDWIDTH (kHz)
LOW	317
MIDDLE	307
HIGH	316

**LOW CHANNEL**

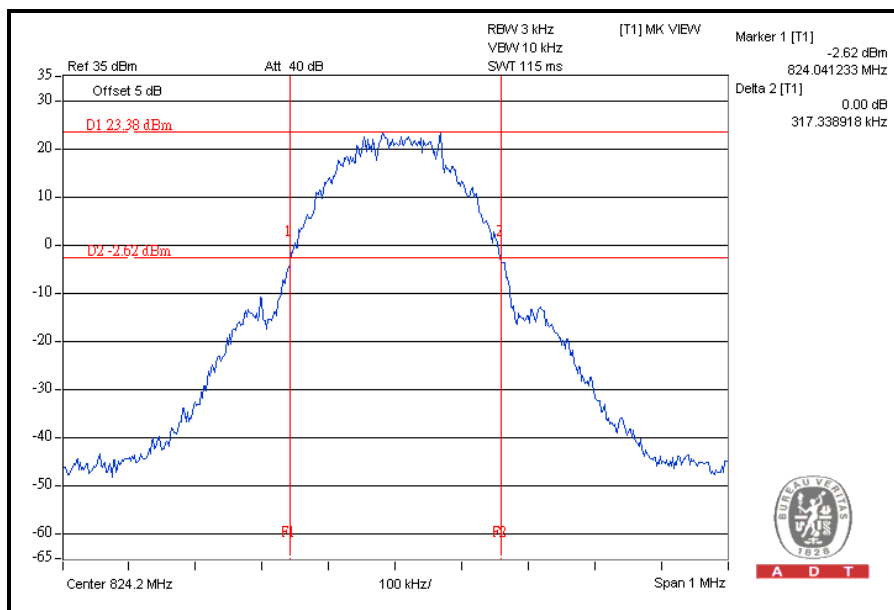



A D T

### MIDDLE CHANNEL

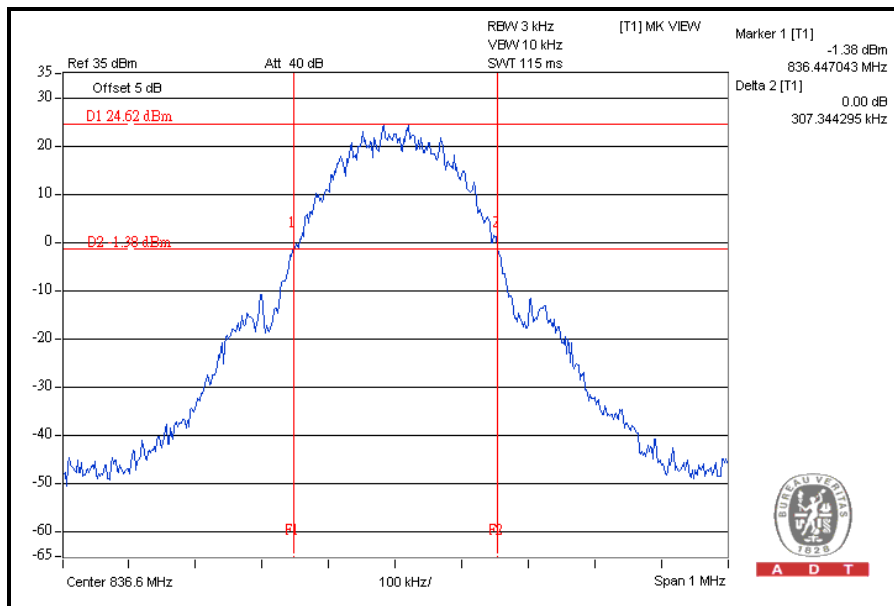

### HIGH CHANNEL

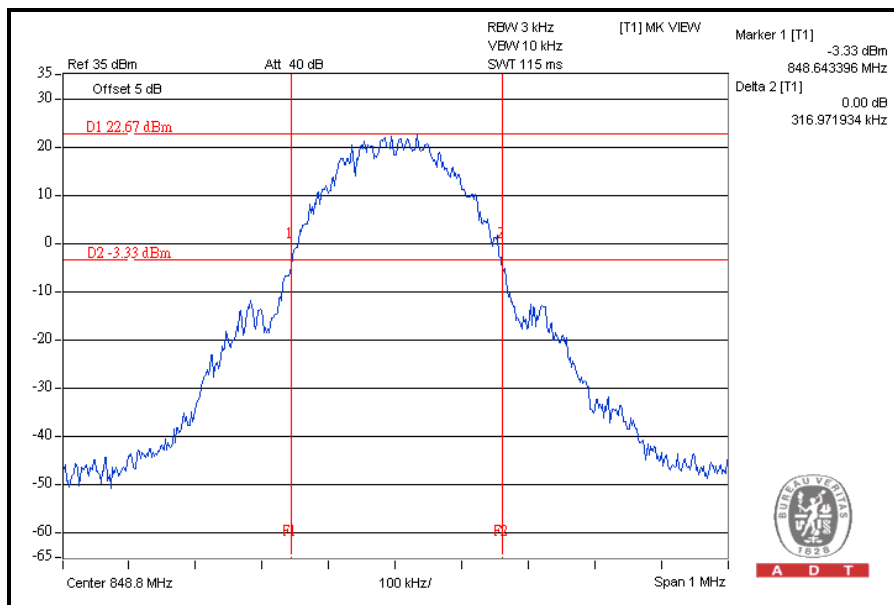



A D T

### FOR GPRS MODE (UP-LINK WITH 1 TIME SLOT)

CHANNEL	MAX. OUTPUT POWER -26 dBc BANDWIDTH (kHz)
LOW	313
MIDDLE	308
HIGH	317

### LOW CHANNEL

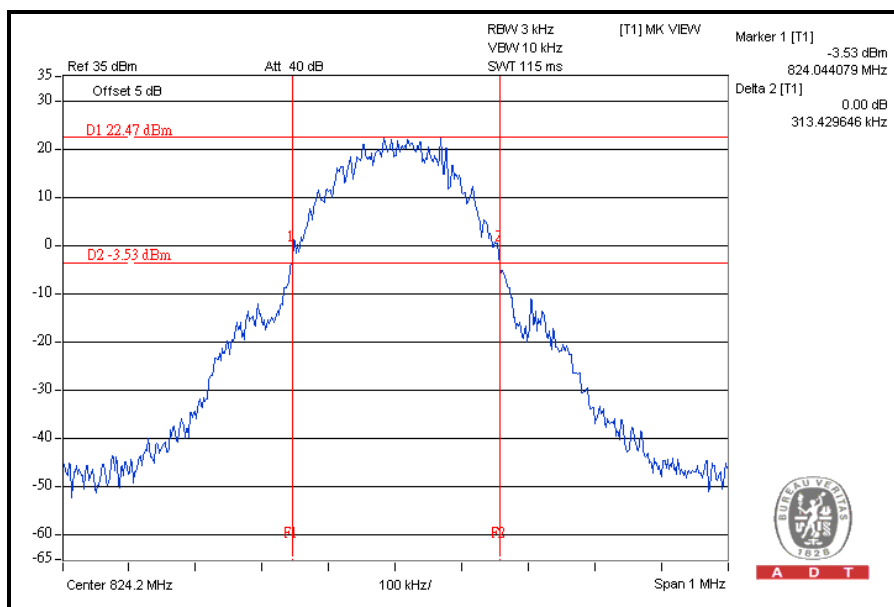



A D T

### MIDDLE CHANNEL

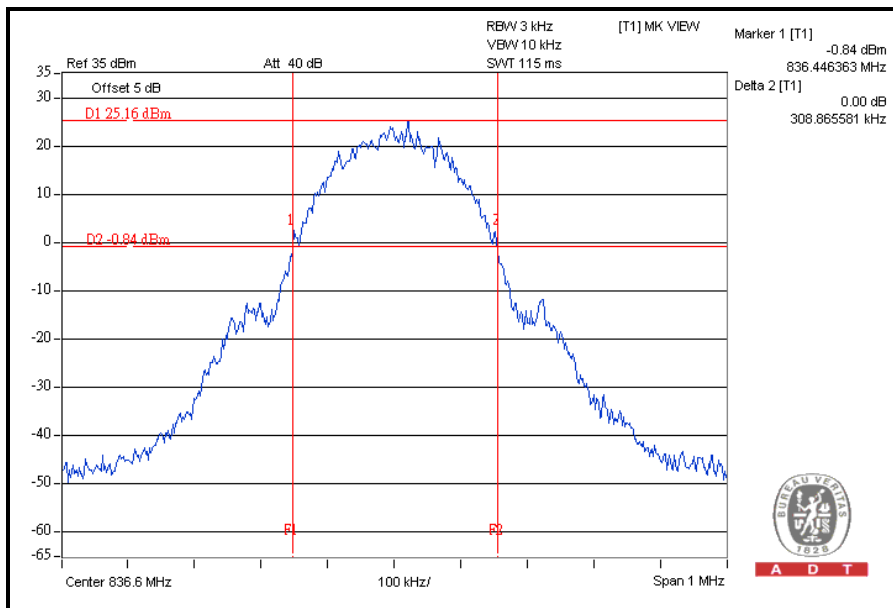

### HIGH CHANNEL

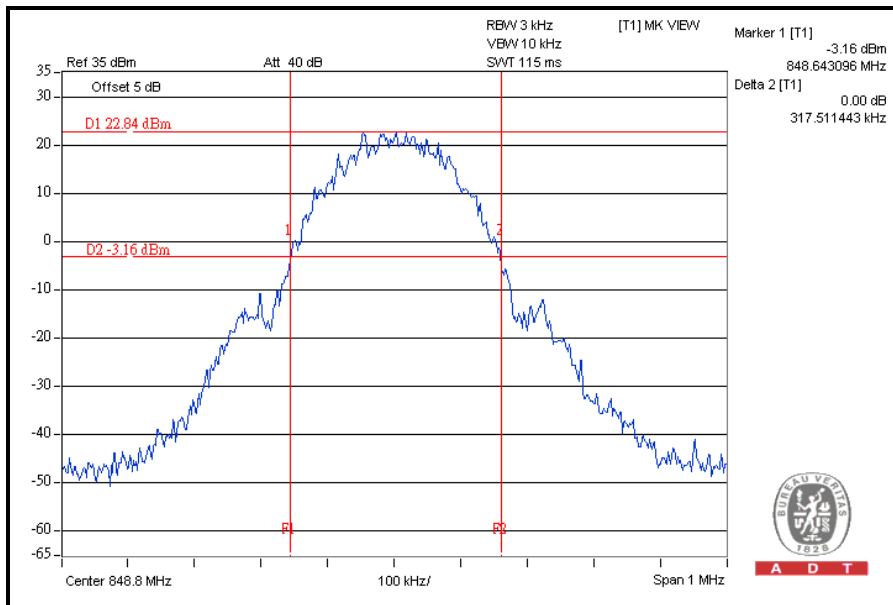





A D T

### FOR E-GPRS MODE (UP-LINK WITH 1 TIME SLOT)

CHANNEL	MAX. OUTPUT POWER -26 dBc BANDWIDTH (kHz)
LOW	315
MIDDLE	312
HIGH	312

### LOW CHANNEL

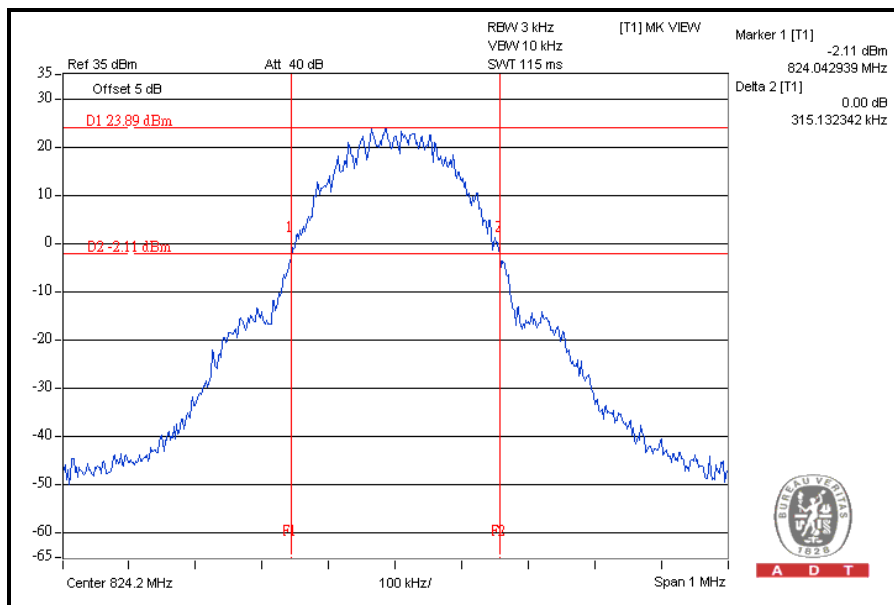



A D T

### MIDDLE CHANNEL

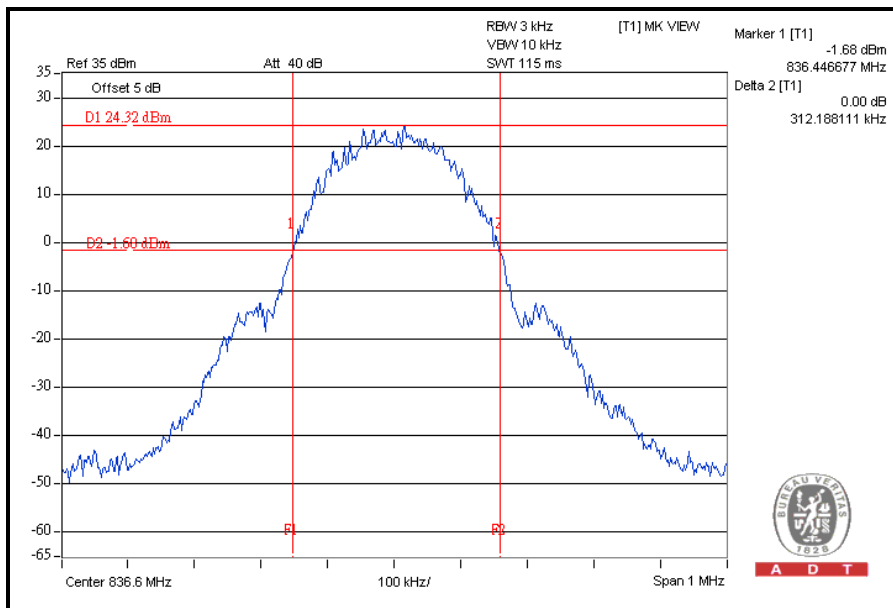

### HIGH CHANNEL

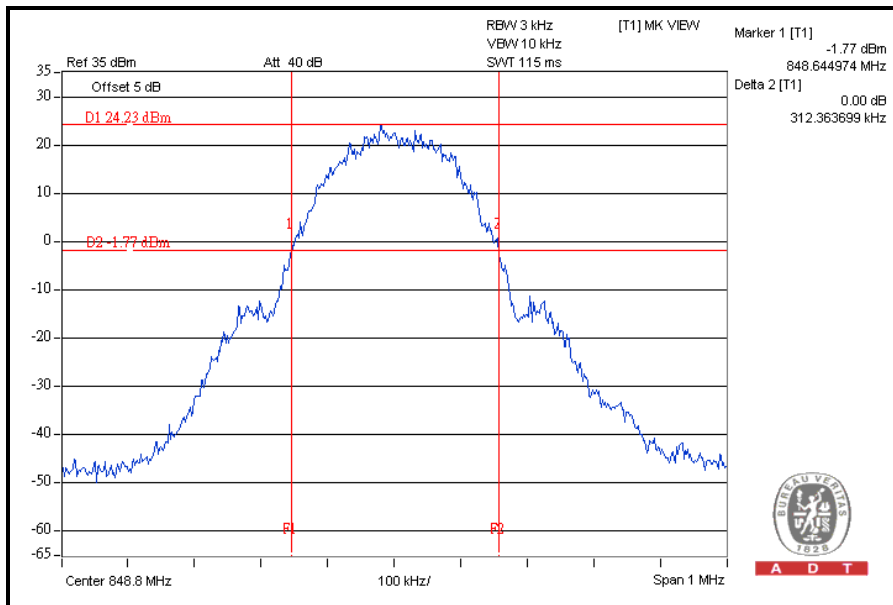

**FOR WCDMA BAND:**

CHANNEL	MAX. OUTPUT POWER -26 dBc BANDWIDTH (MHz)
LOW	4.689
MIDDLE	4.683
HIGH	4.701

**LOW CHANNEL**

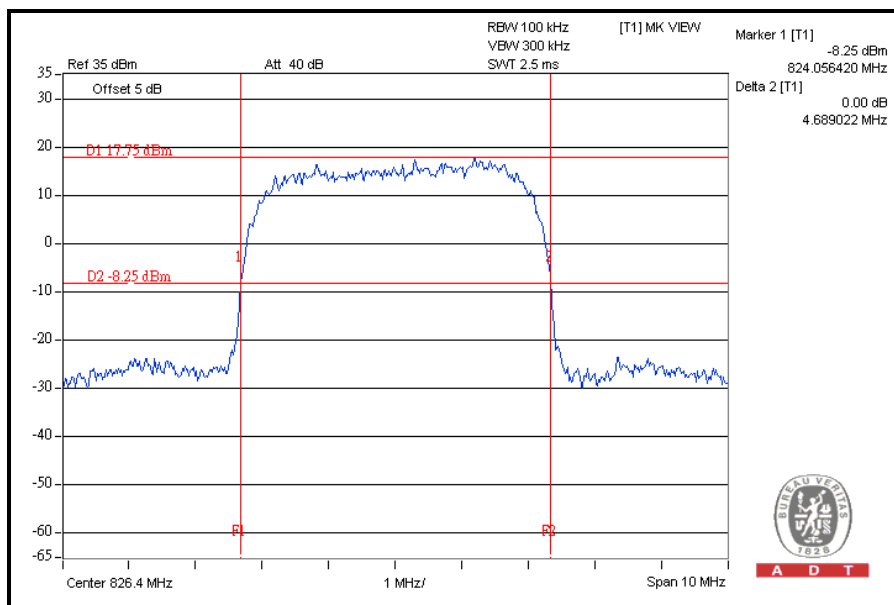



A D T

### MIDDLE CHANNEL

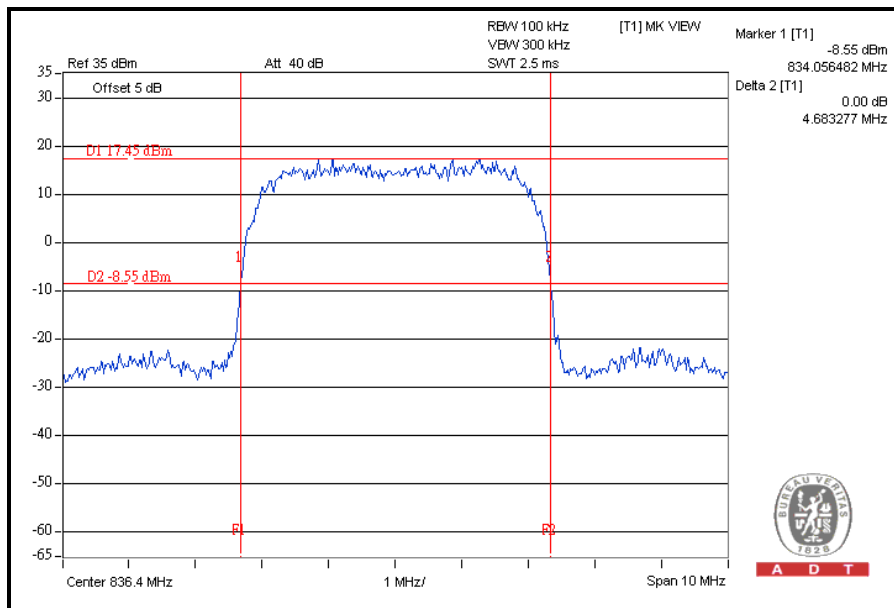

### HIGH CHANNEL

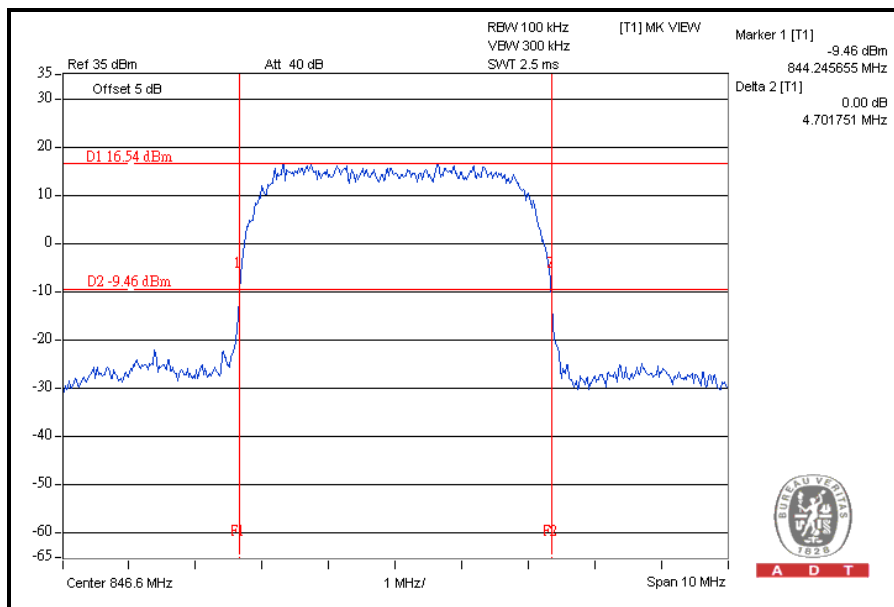

## 4.4 BAND EDGE MEASUREMENT

### 4.4.1 LIMITS OF BAND EDGE MEASUREMENT

According to FCC 22.917 specified that power of any emission outside of the authorized operating frequency ranges must be attenuated below the transmitting power (P) by a factor of at least  $43 + 10 \log(P)$  dB. In the 1 MHz bands immediately outside and adjacent to the frequency block a resolution bandwidth of at least one percent of the emission bandwidth of the fundamental emission of the transmitter may be employed.

### 4.4.2 TEST INSTRUMENTS

DESCRIPTION & MANUFACTURER	MODEL NO.	SERIAL NO.	CALIBRATED DATE	CALIBRATED UNTIL
R&S SPECTRUM ANALYZER	FSP40	100037	Aug. 03, 2009	Aug. 02, 2010
OVEN	MHU-225AU	911033	Dec. 17, 2009	Dec. 16, 2010
HUBER+SUHNER	SUCOFLEX104	222684/4	Aug. 15, 2009	Aug. 14, 2010
AC POWER SOURCE	6205	1140503	NA	NA

**NOTE:** The calibration interval of the above test instruments is 12 months. And the calibrations are traceable to NML/ROC and NIST/USA.

### 4.4.3 TEST SETUP

Same as Item 4.2.4 (Conducted Power Setup)

#### 4.4.4 TEST PROCEDURES

- a. The EUT was set up for the maximum peak power with GSM / WCDMA link data modulation. The power was measured with R&S Spectrum Analyzer. All measurements were done at 2 channels, 128 and 251 / 4132 and 4233 (low and high operational frequency range.)
- b. The band edge measurement used the power splitter via EUT RF power connector between simulation base station and spectrum analyzer. This splitter loss and cable loss is the worst loss 6dB (GSM band) / 6dB (WCDMA band) in the transmitted path track.
- c. The center frequency of spectrum is the band edge frequency and span is 1.5 MHz. RB of the spectrum is 3kHz and VB of the spectrum is 10kHz (for GSM band).
- d. The center frequency of spectrum is the band edge frequency and span is 10MHz. RB of the spectrum is 100kHz and VB of the spectrum is 300kHz (for WCDMA band).
- e. Record the max trace plot into the test report.

#### 4.4.5 EUT OPERATING CONDITION

Same as Item 4.1.5

### 4.4.6 TEST RESULTS

#### FOR GSM BAND:

#### FOR GSM MODE LOWER BAND EDGE

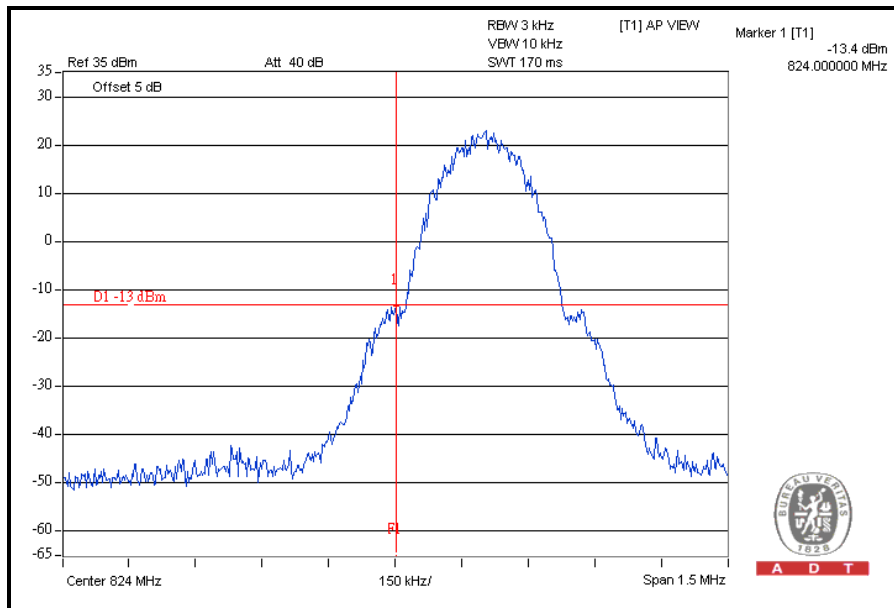

#### HIGHER BAND EDGE

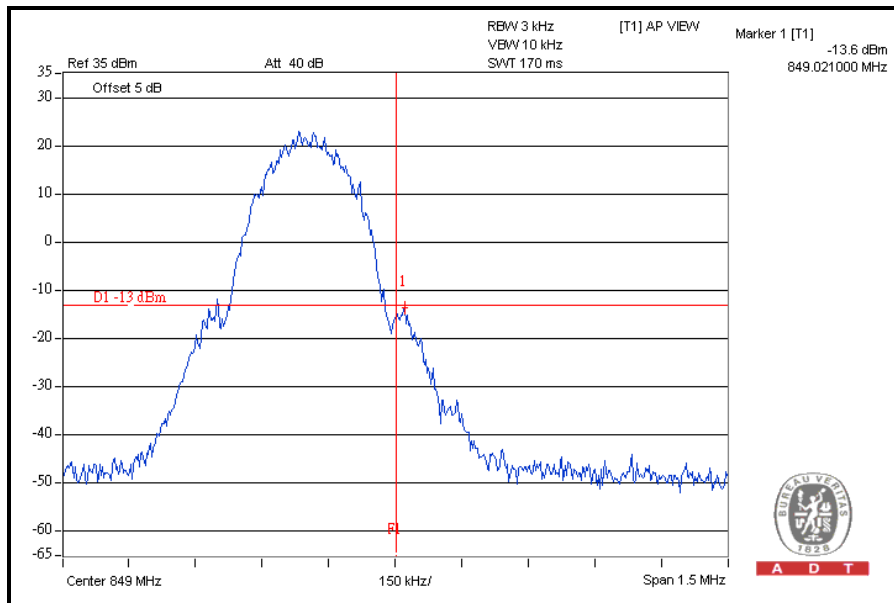



A D T

### FOR GPRS MODE (UP-LINK WITH 1 TIME SLOT) LOWER BAND EDGE

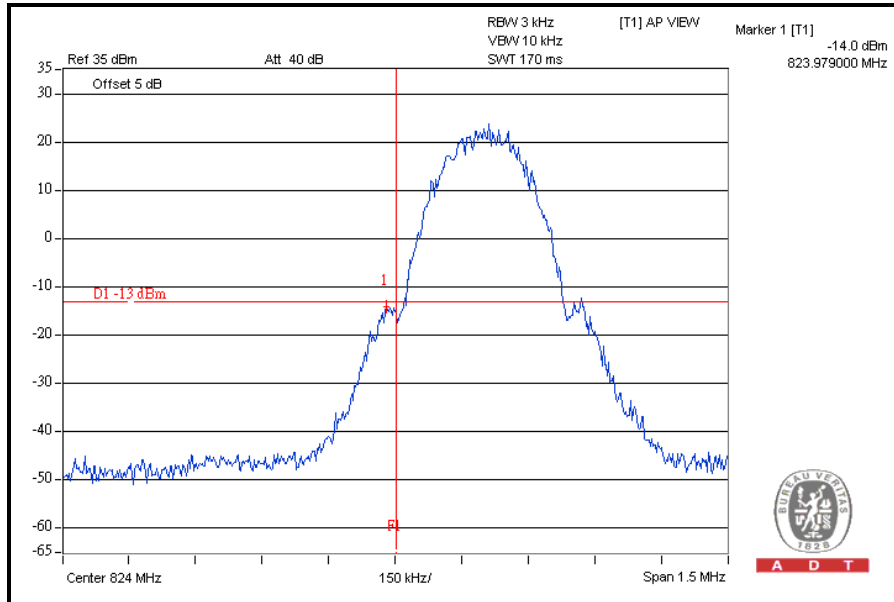

### HIGHER BAND EDGE

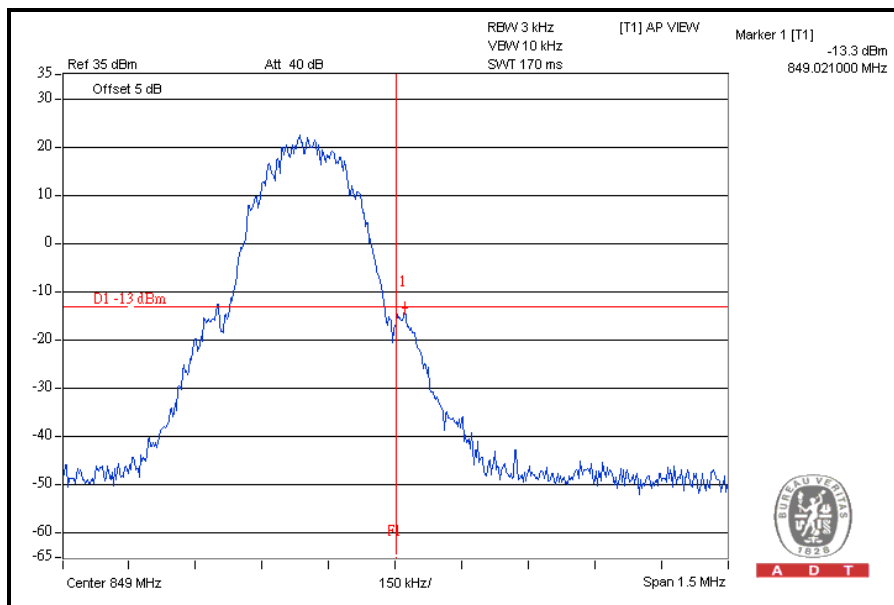





A D T

### FOR E-GPRS MODE (UP-LINK WITH 1 TIME SLOT)

#### LOWER BAND EDGE

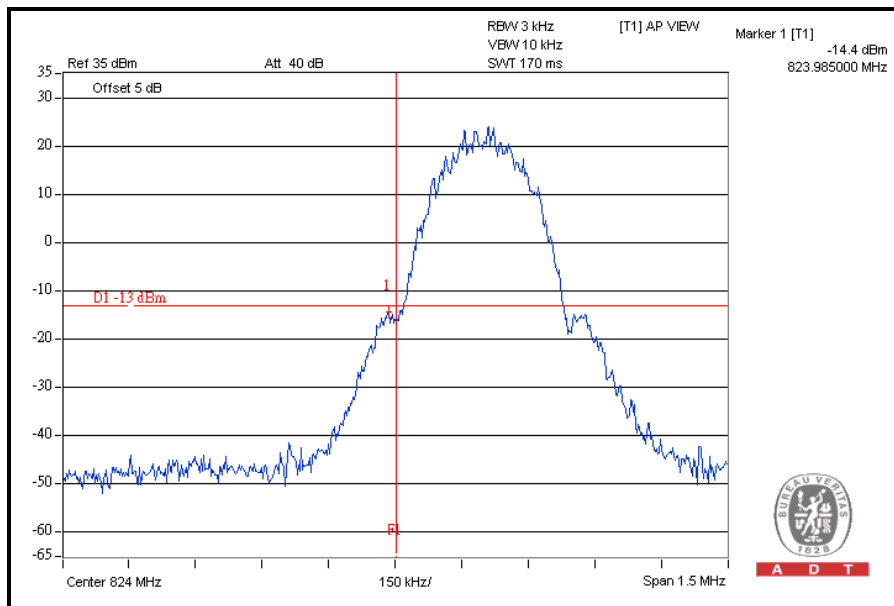

#### HIGHER BAND EDGE

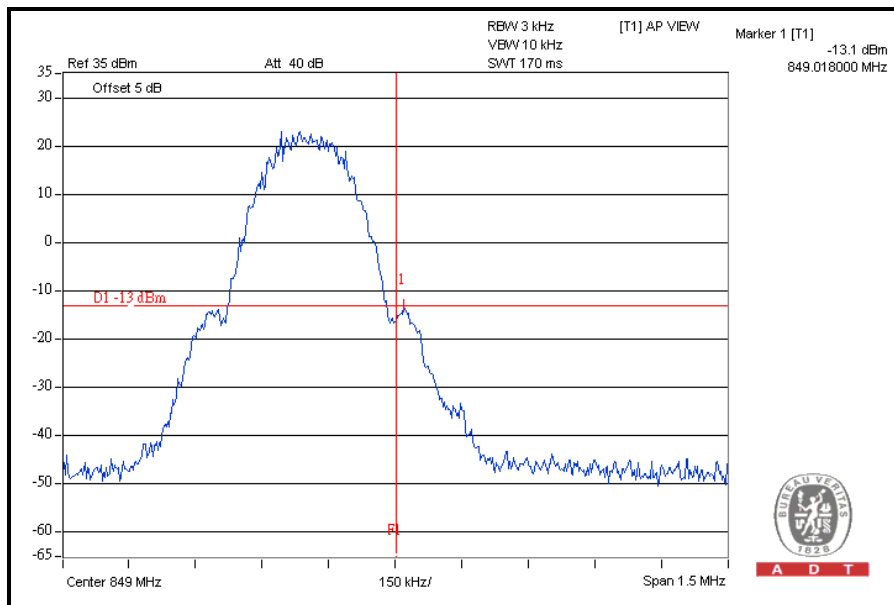

### FOR WCDMA BAND:

#### LOWER BAND EDGE

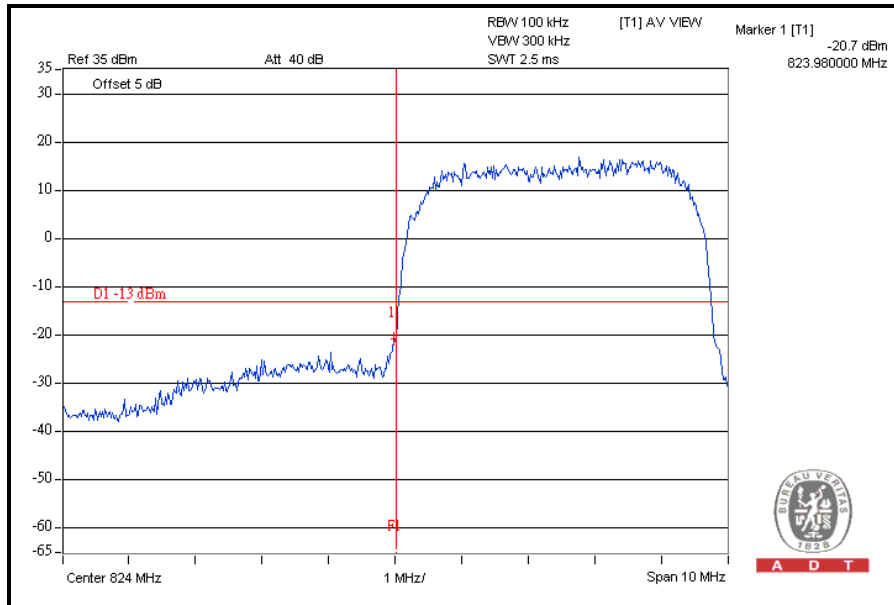

#### HIGHER BAND EDGE

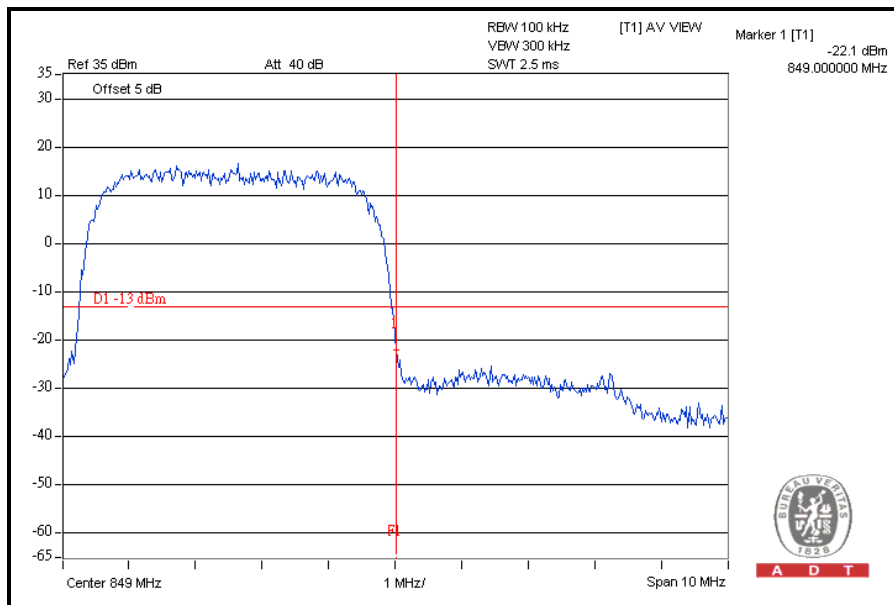

## 4.5 CONDUCTED SPURIOUS EMISSIONS

### 4.5.1 LIMITS OF CONDUCTED SPURIOUS EMISSIONS MEASUREMENT

In the FCC 22.917, On any frequency outside a licensee's frequency block within GSM spectrum, the power of any emission shall be attenuated below the transmitter power (P) by at least  $43 + 10 \log (P)$  dB. The limit of emission equal to  $-13\text{dBm}$ .

### 4.5.2 TEST INSTRUMENTS

DESCRIPTION & MANUFACTURER	MODEL NO.	SERIAL NO.	CALIBRATED DATE	CALIBRATED UNTIL
R&S SPECTRUM ANALYZER	FSP40	100037	Aug. 03, 2009	Aug. 02, 2010
OVEN	MHU-225AU	911033	Dec. 17, 2009	Dec. 16, 2010
HUBER+SUHNER	SUCOFLEX104	222684/4	Aug. 15, 2009	Aug. 14, 2010
AC POWER SOURCE	6205	1140503	NA	NA
Wainwright Instruments Band Reject Filter	WRCG1850/191 0-1830/1930-60/ 10SS	SN1	NA	NA
* Wainwright Instruments High Pass Filter	WHK3.1/18G-10 SS	SN1	NA	NA

**NOTE:** The calibration interval of the above test instruments is 12 months. And the calibrations are traceable to NML/ROC and NIST/USA.

#### 4.5.3 TEST PROCEDURE

- a. The EUT was set up for the maximum peak power with GSM / WCDMA link data modulation. The power was measured with R&S Spectrum Analyzer. All measurements were done at 3 channels, 128, 190 and 251 / 4132, 4182 and 4233 (low, middle and high operational frequency range.)
- b. The conducted spurious emission used the power splitter via EUT RF power connector between simulation base station and spectrum analyzer. This splitter loss and cable loss are the worst loss 6dB (GSM band) / 6dB (WCDMA band) in the transmitted path track.
- c. When the spectrum scanned from 9kHz to 1GHz, it shall be connected to the band reject filter attenuated the carried frequency. The spectrum set RB=1MHz, VB=3MHz (GSM band) / RB=1MHz, VB=1MHz (WCDMA band).
- d. When the spectrum scanned from 1GHz to 9GHz, it shall be connected to the high pass filter attenuated the carried frequency. The spectrum set RB=1MHz, VB=3MHz (GSM band) / RB=1MHz, VB=1MHz (WCDMA band).

#### 4.5.4 TEST SETUP

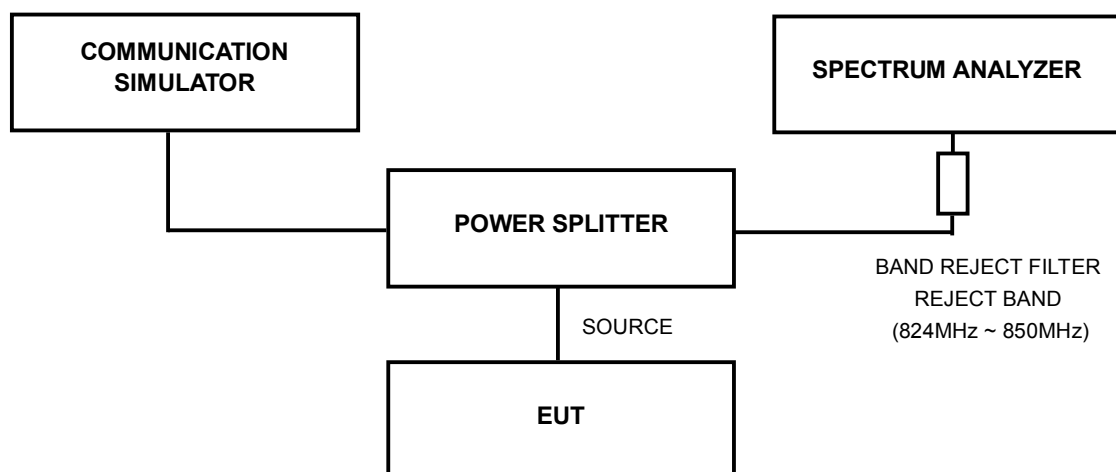

#### 4.5.5 EUT OPERATING CONDITIONS

Same as Item 4.1.5

### 4.5.6 TEST RESULTS

#### FOR GSM BAND:

##### CH 128: 9kHz ~ 1GHz

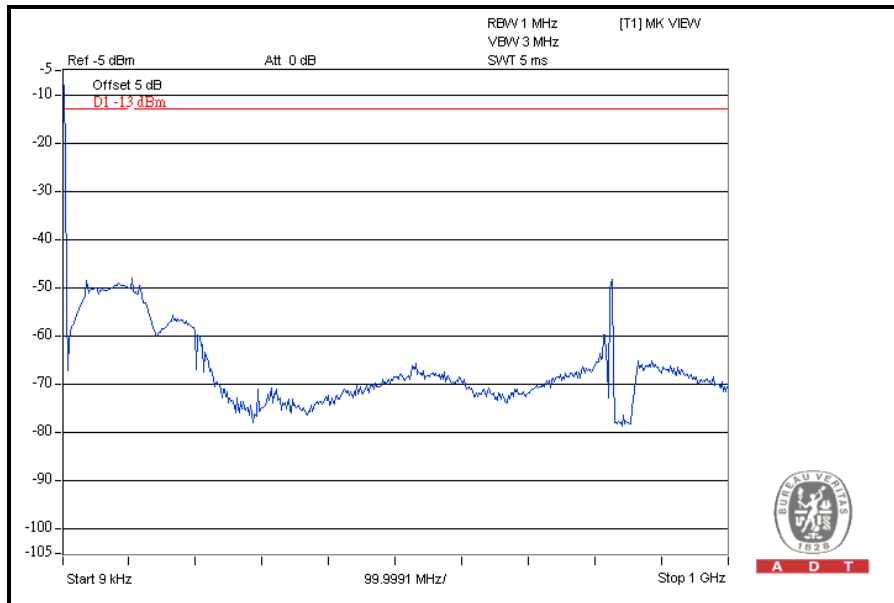

##### 1GHz ~ 4GHz

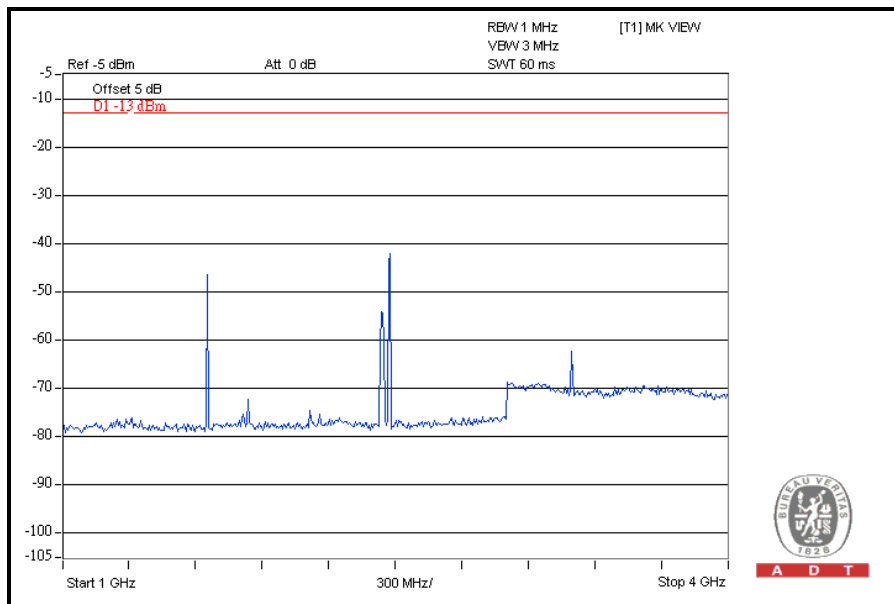



A D T

### 4GHz ~ 9GHz

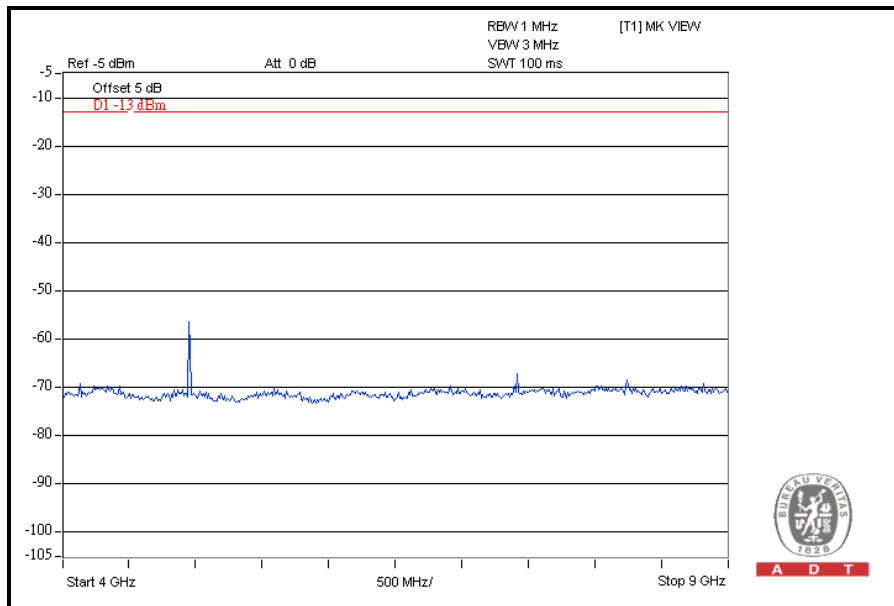



A D T

### CH 190: 9kHz ~ 1GHz

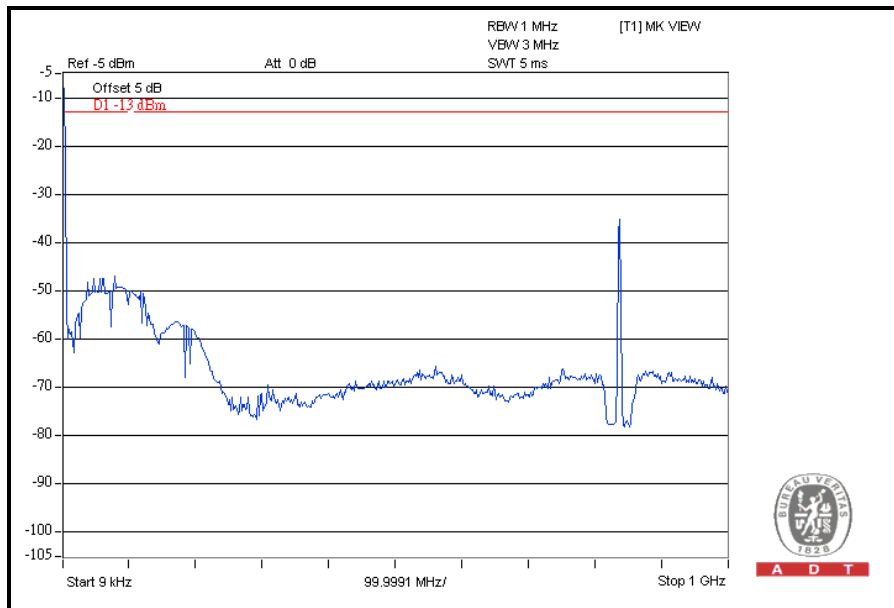

### 1GHz ~ 4GHz

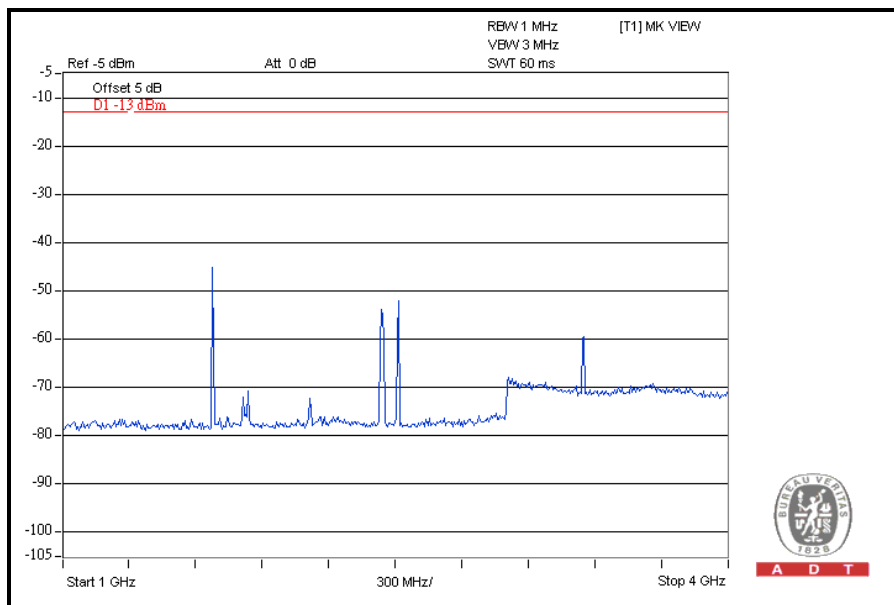



A D T

### 4GHz ~ 9GHz

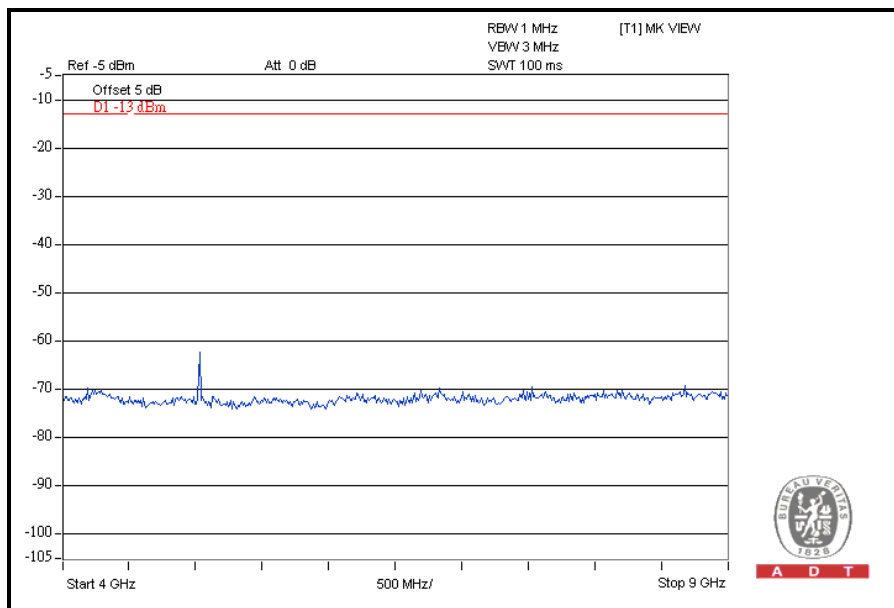





A D T

### CH 251: 9kHz ~ 1GHz

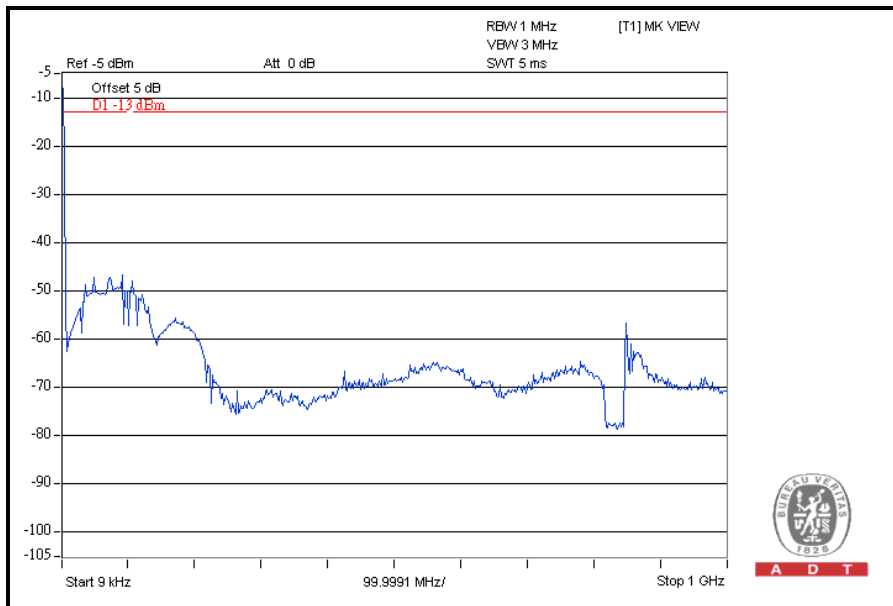

### CH 251: 1GHz ~ 4GHz

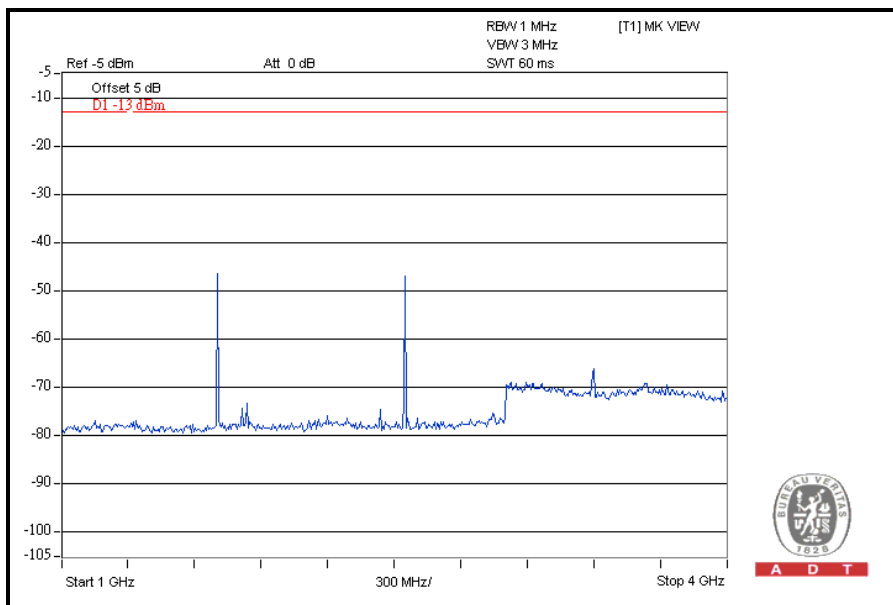



A D T

### CH 251: 4GHz ~ 9GHz

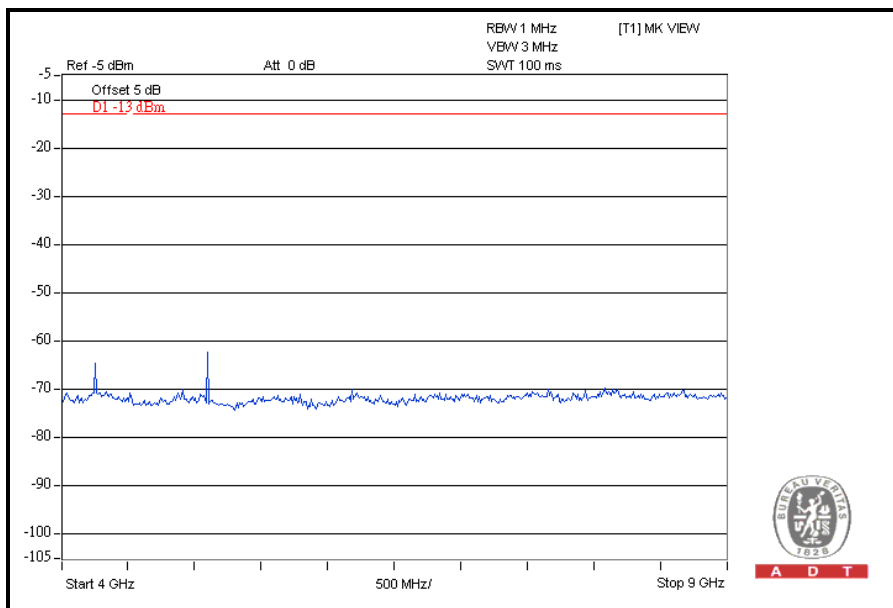



A D T

## FOR WCDMA BAND:

### CH 4132: 9kHz ~ 1GHz

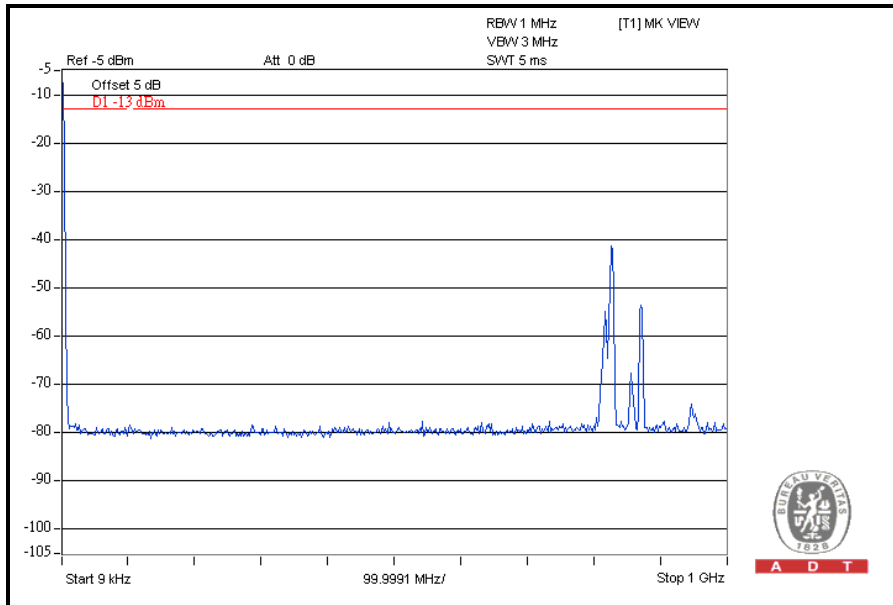

### CH 4132: 1GHz ~ 4GHz

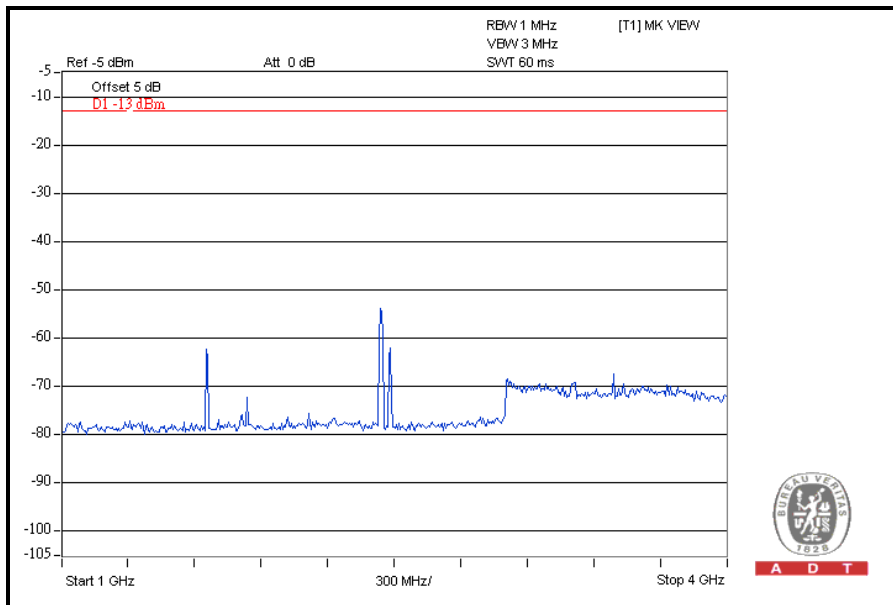



A D T

### CH 4132: 4GHz ~ 9GHz

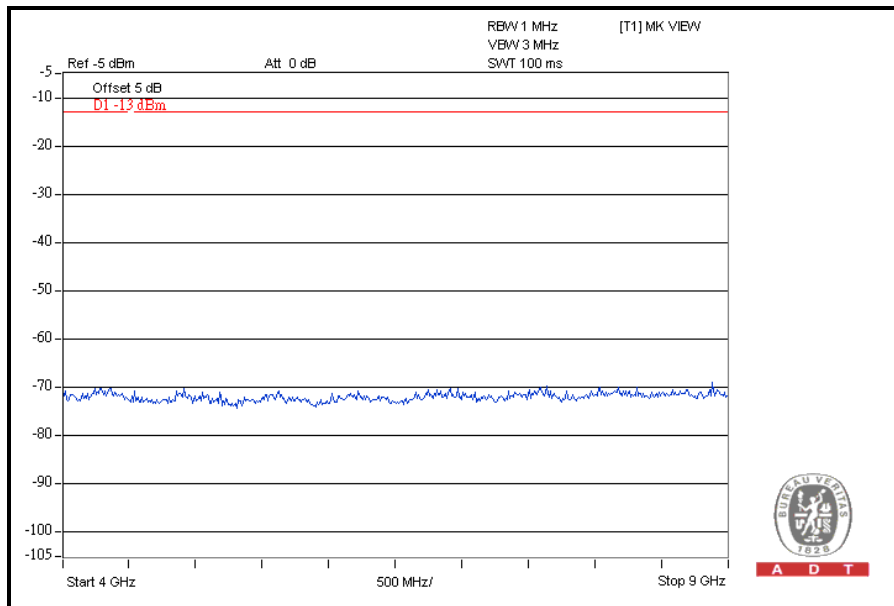



A D T

### CH 4182: 9kHz ~ 1GHz

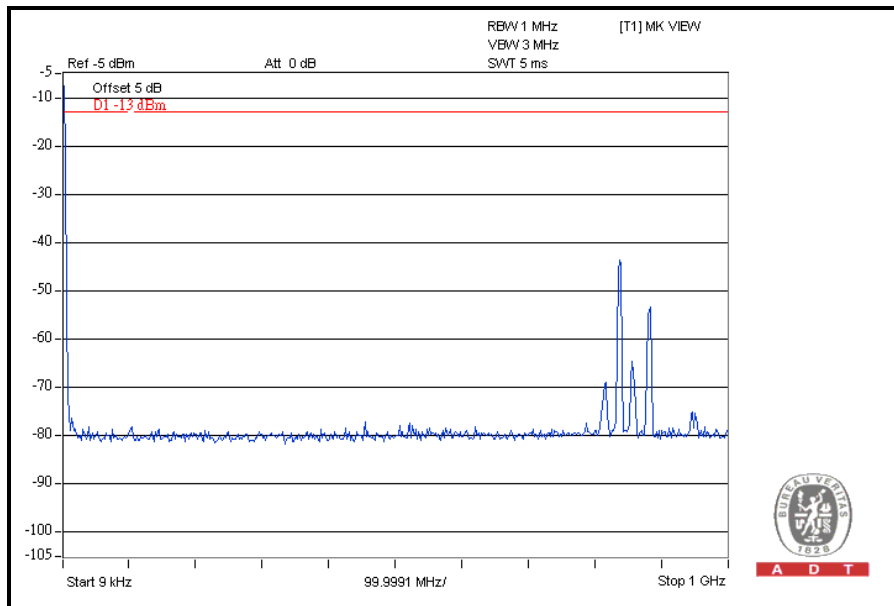

### CH 4182: 1GHz ~ 4GHz

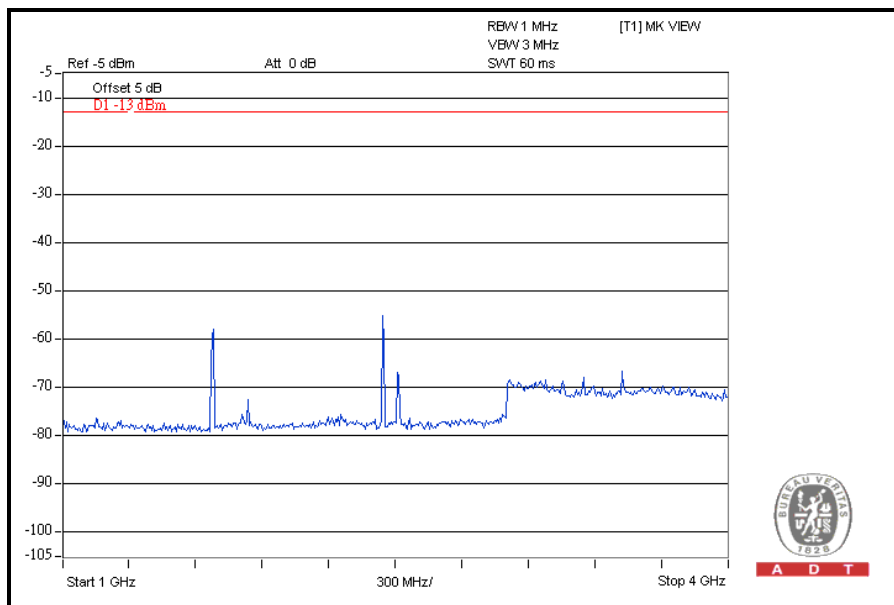



A D T

### CH 4182: 4GHz ~ 9GHz

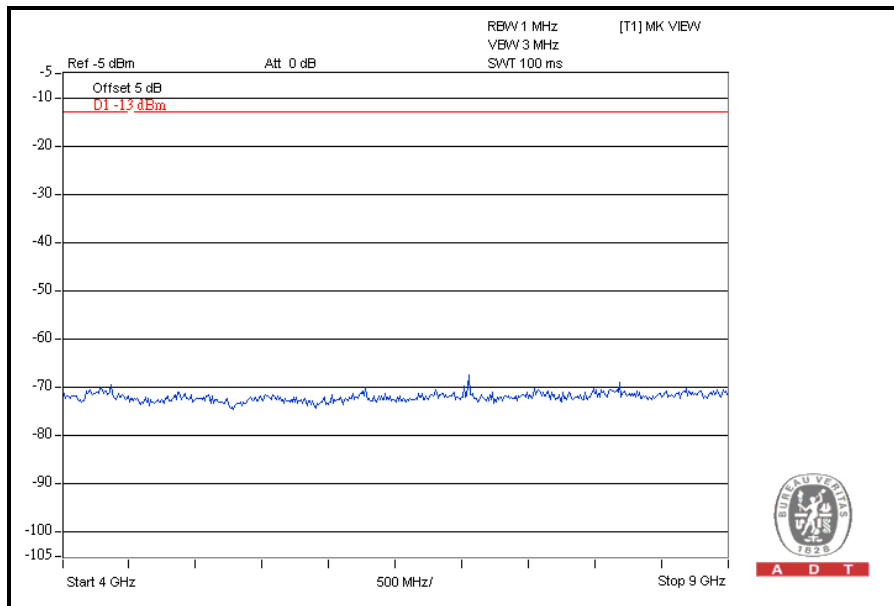



A D T

### CH 4233: 9kHz ~ 1GHz

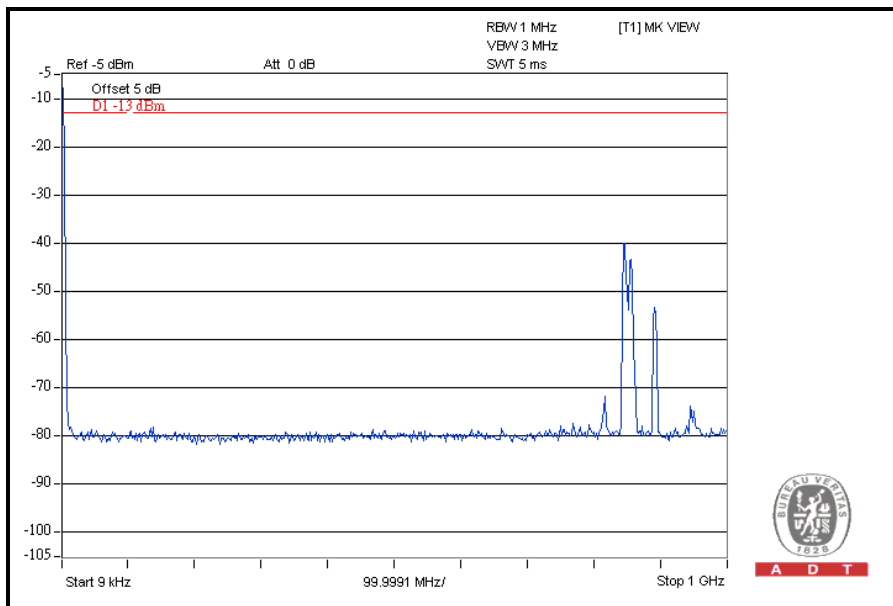

### CH 4233: 1GHz ~ 4GHz

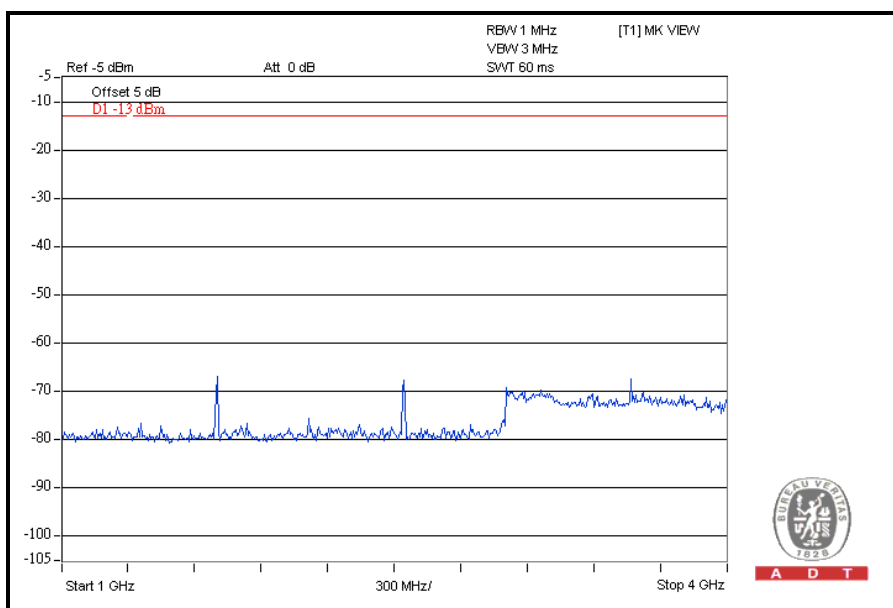



A D T

### CH 4233: 4GHz ~ 9GHz

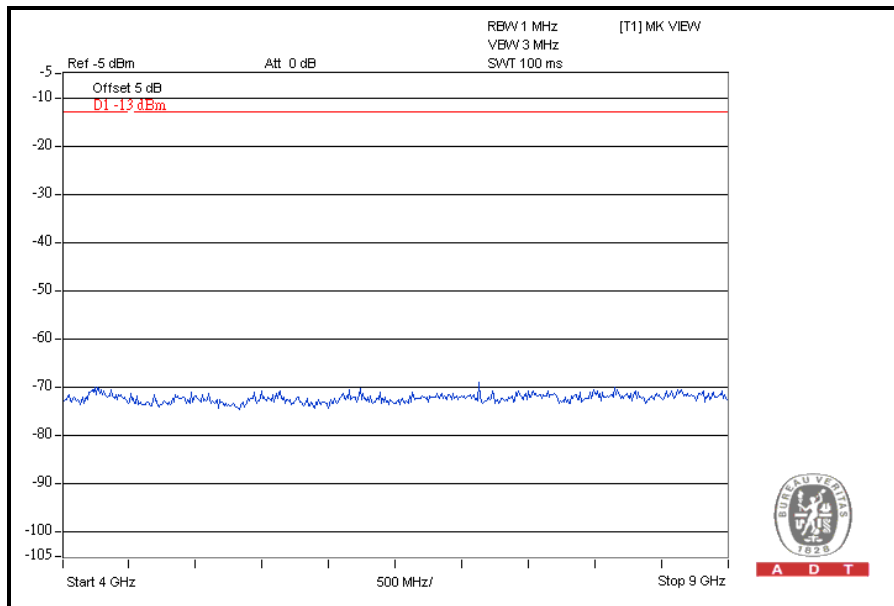



## 4.6 RADIATED EMISSION MEASUREMENT (BELOW 1GHz)

### 4.6.1 LIMITS OF RADIATED EMISSION MEASUREMENT

In the FCC 24.238(a), On any frequency outside a licensee's frequency block within USPCS spectrum, the power of any emission shall be attenuated below the transmitter power (P) by at least  $43 + 10 \log (P)$  dB. The emission of limit equal to  $-13$ dBm. So the limit of emission is the same absolute specified line.

LIMIT (dBm)	EQUIVALENT FIELD STRENGTH AT 3m (dBuV/m) (NOTE)
-13	82.22

**NOTE:** The following formula is used to convert the equipment radiated power to field strength.

$$E = [1000000\sqrt{(30P)}] / 3 \text{ uV/m, where P is Watts.}$$



A D T

#### 4.6.2 TEST INSTRUMENTS

DESCRIPTION & MANUFACTURER	MODEL NO.	SERIAL NO.	CALIBRATED DATE	CALIBRATED UNTIL
ADVANTEST Spectrum Analyzer	U3751	170100022	Nov. 18, 2009	Nov. 17, 2010
ADVANTEST Spectrum Analyzer	U3772	160100280	Sep. 21, 2009	Sep. 20, 2010
HP Pre_Amplifier	8449B	3008A01922	Sep. 25, 2009	Sep. 24, 2010
ROHDE & SCHWARZ Test Receiver	ESCS 30	100027	May 05, 2009	May 04, 2010
SCHWARZBECK Broadband Antenna	VULB-9168	263	April 29, 2009	April 28, 2010
Schwarzbeck Horn_Antenna	BBHA9120	D123	Sep. 21, 2009	Sep. 20, 2010
Schwarzbeck Horn_Antenna	BBHA 9170	BBHA9170153	Jan. 22, 2010	Jan. 21, 2011
RF Switches	EM-H-01-1	1009	Aug. 10, 2009	Aug. 09, 2010
RF Cable	8DFB	STACAB-30M-1GHz-091	Feb. 19, 2009	Feb. 18, 2010
Software	ADT_Radiated_V7.6.15.9.2	NA	NA	NA
CT Antenna Tower & Turn Table	TT100	ADT01	NA	NA
CORCOM AC Filter	MRI2030	107/108	NA	NA

Note: 1. The calibration interval of the above test instruments is 12 months and the calibrations are traceable to NML/ROC and NIST/USA.

2. The horn antenna, HP preamplifier (model: 8449B) and Spectrum Analyzer (model: FSP40) are used only for the measurement of emission frequency above 1GHz if tested.

3. The test was performed in Open Site No. C.

4. The FCC Site Registration No. is 656396.

5. The VCCI Site Registration No. is R-1626.

6. The CANADA Site Registration No. is IC 7450G-3.

#### 4.6.3 TEST PROCEDURES

- a. The EUT was placed on the top of a rotating table 0.8 meters above the ground. The table was rotated 360 degrees to determine the position of the highest radiation.
- b. The EUT was set 3 meters away from the receiving antenna, which was mounted on antenna tower and its position at 0.8 m above the ground.
- c. For each suspected emission, the EUT was arranged to its worst case and the rotatable table was turned from 0 degrees to 360 degrees to find the maximum reading and recorded the value.
- d. The EUT is replaced by a horn antenna connected to a signal generator tuned to the frequency of emission.
- e. The signal generator level has to be adjusted to have the same emission nature.
- f. The radiated power can be calculated via the factor and antenna gain.
- g. Repeat step a ~ f for horizontal polarization.

**NOTE:** The resolution bandwidth of spectrum analyzer is 1MHz and the video bandwidth is 3MHz.

#### 4.6.4 DEVIATION FROM TEST STANDARD

No deviation

#### 4.6.5 TEST SETUP

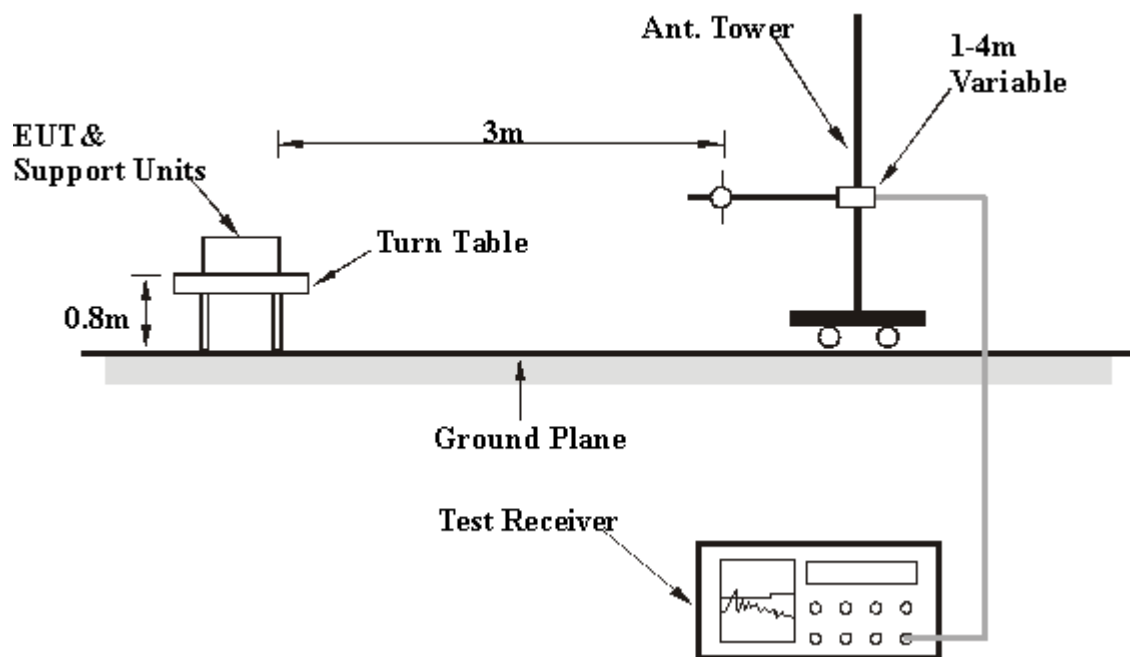

For the actual test configuration, please refer to the attached file (Test Setup Photo).

#### 4.6.6 EUT OPERATING CONDITIONS

Same as Item 4.1.5



A D T

#### 4.6.7 TEST RESULTS

##### FOR GSM BAND:

<b>MODE</b>	TX channel 251	<b>DETECTOR FUNCTION</b>	Quasi-Peak
<b>FREQUENCY RANGE</b>	Below 1000 MHz	<b>INPUT POWER</b>	120Vac, 60 Hz
<b>ENVIRONMENTAL CONDITIONS</b>	22deg. C, 69%RH, 1024hPa	<b>TESTED BY</b>	Wen Yu

ANTENNA POLARITY & TEST DISTANCE: HORIZONTAL AT 3 M						
No.	Freq. (MHz)	Emission Level (dBuV)	Limit (dBm)	S.G Power Value (dBm)	Correction Factor (dB)	Power Value (dBm)
1	212.5	29.85	-13	-65.60	4.18	-61.42
2	426.66	35.4	-13	-62.66	3.05	-59.61
3	500.03	34.1	-13	-61.42	2.89	-58.53
4	639.99	33.8	-13	-61.12	1.75	-59.37
5	853.32	39.8	-13	-55.12	1.00	-54.13
6	959.99	40.3	-13	-57.53	0.39	-57.14

ANTENNA POLARITY & TEST DISTANCE: VERTICAL AT 3 M						
No.	Freq. (MHz)	Emission Level (dBuV)	Limit (dBm)	S.G Power Value (dBm)	Correction Factor (dB)	Power Value (dBm)
1	213.33	32.4	-13	-63.05	4.17	-58.88
2	320	33.5	-13	-63.12	3.67	-59.45
3	375	30.5	-13	-67.35	3.46	-63.89
4	426.66	34.6	-13	-63.46	3.05	-60.41
5	500.03	29.7	-13	-65.82	2.89	-62.93
6	853.32	36.7	-13	-58.22	1.00	-57.23

**NOTE:** Power Value (dBum) = S.G Power Value (dBm) + Correction Factor (dB).



A D T

**FOR WCDMA BAND:**

<b>MODE</b>	TX channel 4233	<b>DETECTOR FUNCTION</b>	Quasi-Peak
<b>FREQUENCY RANGE</b>	Below 1000 MHz	<b>INPUT POWER</b>	120Vac, 60 Hz
<b>ENVIRONMENTAL CONDITIONS</b>	22deg. C, 69%RH, 1024hPa	<b>TESTED BY</b>	Wen Yu

**ANTENNA POLARITY & TEST DISTANCE: HORIZONTAL AT 3 M**

No.	Freq. (MHz)	Emission Level (dBuV)	Limit (dBm)	S.G Power Value (dBm)	Correction Factor (dB)	Power Value (dBm)
1	212.5	29.7	-13	-65.75	4.18	-61.57
2	426.66	35.3	-13	-62.76	3.05	-59.71
3	500.03	34.6	-13	-60.92	2.89	-58.03
4	639.99	33.4	-13	-61.52	1.75	-59.77
5	853.32	39.7	-13	-55.22	1.00	-54.23
6	959.99	40.5	-13	-57.33	0.39	-56.94

**ANTENNA POLARITY & TEST DISTANCE: VERTICAL AT 3 M**

No.	Freq. (MHz)	Emission Level (dBuV)	Limit (dBm)	S.G Power Value (dBm)	Correction Factor (dB)	Power Value (dBm)
1	213.33	32.5	-13	-62.95	4.17	-58.78
2	320	33.7	-13	-62.92	3.67	-59.25
3	375	30.6	-13	-67.25	3.46	-63.79
4	426.66	34.3	-13	-63.76	3.05	-60.71
5	500.03	29.8	-13	-65.72	2.89	-62.83
6	853.32	36.9	-13	-58.02	1.00	-57.03

**NOTE:** Power Value (dBum) = S.G Power Value (dBm) + Correction Factor (dB).

## 4.7 RADIATED EMISSION MEASUREMENT (ABOVE 1GHz)

### 4.7.1 LIMITS OF RADIATED EMISSION MEASUREMENT

In the FCC 22.917 (a), On any frequency outside a licensee's frequency block within GSM spectrum, the power of any emission shall be attenuated below the transmitter power (P) by at least  $43 + 10 \log (P)$  dB. The limit of emission equal to  $-13\text{dBm}$ .



A D T

#### 4.7.2 TEST INSTRUMENTS

DESCRIPTION & MANUFACTURER	MODEL NO.	SERIAL NO.	CALIBRATED DATE	CALIBRATED UNTIL
ADVANTEST Spectrum Analyzer	U3751	170100022	Nov. 18, 2009	Nov. 17, 2010
ADVANTEST Spectrum Analyzer	U3772	160100280	Sep. 21, 2009	Sep. 20, 2010
HP Pre_Amplifier	8449B	3008A01922	Sep. 25, 2009	Sep. 24, 2010
ROHDE & SCHWARZ Test Receiver	ESCS 30	100027	May 05, 2009	May 04, 2010
SCHWARZBECK Broadband Antenna	VULB-9168	263	April 29, 2009	April 28, 2010
Schwarzbeck Horn_Antenna	BBHA9120	D123	Sep. 21, 2009	Sep. 20, 2010
Schwarzbeck Horn_Antenna	BBHA 9170	BBHA9170153	Jan. 22, 2010	Jan. 21, 2011
RF Switches	EM-H-01-1	1009	Aug. 10, 2009	Aug. 09, 2010
RF Cable	8DFB	STACAB-30M-1GHz-091	Feb. 19, 2009	Feb. 18, 2010
Software	ADT_Radiated_V7.6.15.9.2	NA	NA	NA
CT Antenna Tower & Turn Table	TT100	ADT01	NA	NA
CORCOM AC Filter	MRI2030	107/108	NA	NA

Note: 1. The calibration interval of the above test instruments is 12 months and the calibrations are traceable to NML/ROC and NIST/USA.

2. The horn antenna, HP preamplifier (model: 8449B) and Spectrum Analyzer (model: FSP40) are used only for the measurement of emission frequency above 1GHz if tested.

3. The test was performed in Open Site No. C.

4. The FCC Site Registration No. is 656396.

5. The VCCI Site Registration No. is R-1626.

6. The CANADA Site Registration No. is IC 7450G-3.



#### 4.7.3 TEST PROCEDURES

- h. The EUT was placed on the top of a rotating table 0.8 meters above the ground. The table was rotated 360 degrees to determine the position of the highest radiation.
- i. The EUT was set 3 meters away from the receiving antenna, which was mounted on antenna tower and its position at 0.8 m above the ground.
- j. For each suspected emission, the EUT was arranged to its worst case and the rotatable table was turned from 0 degrees to 360 degrees to find the maximum reading and recorded the value.
- k. The EUT is replaced by a horn antenna connected to a signal generator tuned to the frequency of emission.
- l. The signal generator level has to be adjusted to have the same emission nature.
- m. The radiated power can be calculated via the factor and antenna gain.
- n. Repeat step a ~ f for horizontal polarization.

**NOTE:** The resolution bandwidth of spectrum analyzer is 1 MHz and the video bandwidth is 3 MHz.

#### 4.7.4 DEVIATION FROM TEST STANDARD

No deviation

#### 4.7.5 TEST SETUP

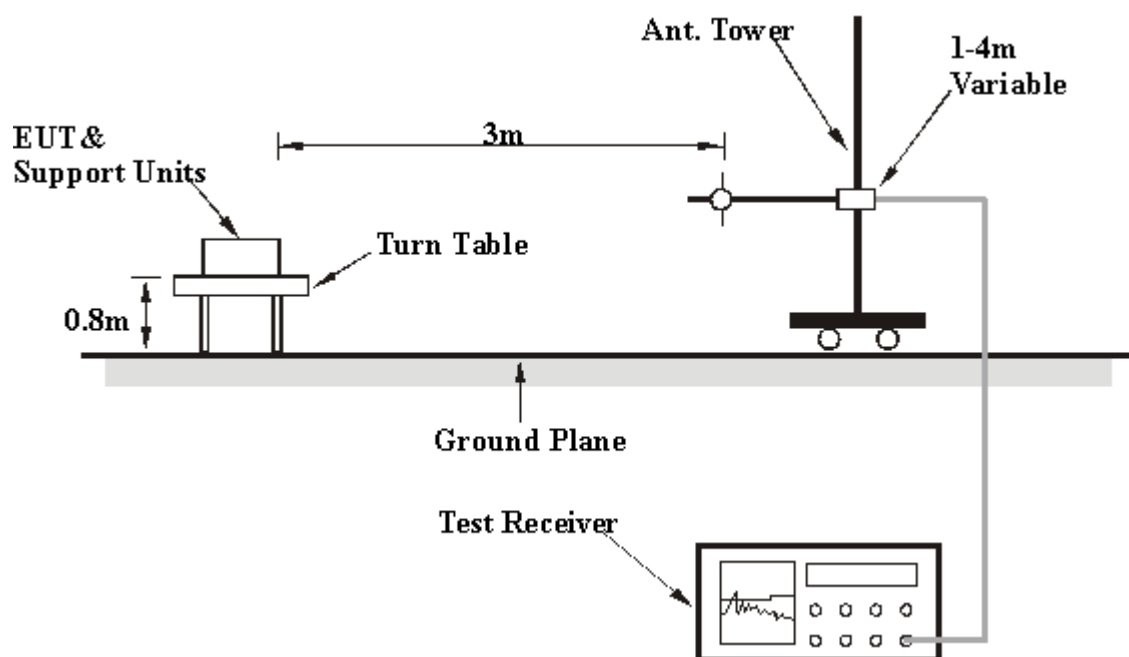

For the actual test configuration, please refer to the attached file (Test Setup Photo).

#### 4.7.6 EUT OPERATING CONDITIONS

Same as Item 4.1.5



A D T

#### 4.7.7 TEST RESULTS

##### FOR GSM BAND:

<b>MODE</b>	TX channel 128	<b>FREQUENCY RANGE</b>	Above 1000 MHz
<b>INPUT POWER</b>	120Vac, 60 Hz	<b>ENVIRONMENTAL CONDITIONS</b>	18deg. C, 63%RH, 1024hPa
<b>TESTED BY</b>	Wen Yu		

ANTENNA POLARITY & TEST DISTANCE: HORIZONTAL AT 3 M						
No.	Freq. (MHz)	Emission Level (dBuV)	Limit (dBm)	S.G Power Value (dBm)	Correction Factor (dB)	Power Value (dBm)
1	1648.4	52.9	-13	-49.85	6.26	-43.59
2	2472.6	44.5	-13	-54.08	6.66	-47.42
3	3296.8	40.2	-13	-62.75	7.56	-55.20
4	4121	43.7	-13	-61.21	7.47	-53.74

ANTENNA POLARITY & TEST DISTANCE: VERTICAL AT 3 M						
No.	Freq. (MHz)	Emission Level (dBuV)	Limit (dBm)	S.G Power Value (dBm)	Correction Factor (dB)	Power Value (dBm)
1	1648.4	51.2	-13	-51.55	6.26	-45.29
2	2472.6	40.4	-13	-58.18	6.66	-51.52
3	3296.8	35.6	-13	-67.35	7.56	-59.80
4	4121	41.26	-13	-63.65	7.47	-56.18

**NOTE:** Power Value (dBum) = S.G Power Value (dBm) + Correction Factor (dB).



A D T

<b>MODE</b>	TX channel 190	<b>FREQUENCY RANGE</b>	Above 1000 MHz
<b>INPUT POWER</b>	120Vac, 60 Hz	<b>ENVIRONMENTAL CONDITIONS</b>	18deg. C, 63%RH, 1024hPa
<b>TESTED BY</b>	Wen Yu		

<b>ANTENNA POLARITY &amp; TEST DISTANCE: HORIZONTAL AT 3 M</b>						
No.	Freq. (MHz)	Emission Level (dBuV)	Limit (dBm)	S.G Power Value (dBm)	Correction Factor (dB)	Power Value (dBm)
1	1673.2	51	-13	-51.63	6.31	-45.32
2	2509.8	47.49	-13	-51.03	6.66	-44.37
3	3346.4	40.6	-13	-62.41	7.63	-54.78
4	4183	41.3	-13	-63.54	7.44	-56.10

<b>ANTENNA POLARITY &amp; TEST DISTANCE: VERTICAL AT 3 M</b>						
No.	Freq. (MHz)	Emission Level (dBuV)	Limit (dBm)	S.G Power Value (dBm)	Correction Factor (dB)	Power Value (dBm)
1	1673.2	48.25	-13	-54.38	6.31	-48.07
2	2509.8	46.11	-13	-52.41	6.66	-45.75
3	3346.4	35.9	-13	-67.11	7.63	-59.48
4	4183	42.3	-13	-62.54	7.44	-55.10

**NOTE:** Power Value (dBum) = S.G Power Value (dBm) + Correction Factor (dB).



A D T

<b>MODE</b>	TX channel 251	<b>FREQUENCY RANGE</b>	Above 1000 MHz
<b>INPUT POWER</b>	120Vac, 60 Hz	<b>ENVIRONMENTAL CONDITIONS</b>	18deg. C, 63%RH, 1024hPa
<b>TESTED BY</b>	Wen Yu		

<b>ANTENNA POLARITY &amp; TEST DISTANCE: HORIZONTAL AT 3 M</b>						
No.	Freq. (MHz)	Emission Level (dBuV)	Limit (dBm)	S.G Power Value (dBm)	Correction Factor (dB)	Power Value (dBm)
1	1697.6	47.85	-13	-54.66	6.35	-48.30
2	2546.4	49.4	-13	-49.43	6.69	-42.73
3	3395.2	41.2	-13	-61.87	7.70	-54.17
4	4244	41.6	-13	-63.18	7.42	-55.76

<b>ANTENNA POLARITY &amp; TEST DISTANCE: VERTICAL AT 3 M</b>						
No.	Freq. (MHz)	Emission Level (dBuV)	Limit (dBm)	S.G Power Value (dBm)	Correction Factor (dB)	Power Value (dBm)
1	1697.6	46.4	-13	-56.11	6.35	-49.75
2	2546.4	48.2	-13	-50.63	6.69	-43.93
3	3395.2	36.2	-13	-66.87	7.70	-59.17
4	4244	42.7	-13	-62.08	7.42	-54.66

**NOTE:** Power Value (dBum) = S.G Power Value (dBm) + Correction Factor (dB).



A D T

**FOR WCDMA BAND:**

<b>MODE</b>	TX channel 4132	<b>FREQUENCY RANGE</b>	Above 1000 MHz
<b>INPUT POWER</b>	120Vac, 60 Hz	<b>ENVIRONMENTAL CONDITIONS</b>	18deg. C, 63%RH, 1024hPa
<b>TESTED BY</b>	Wen Yu		

**ANTENNA POLARITY & TEST DISTANCE: HORIZONTAL AT 3 M**

No.	Freq. (MHz)	Emission Level (dBuV)	Limit (dBm)	S.G Power Value (dBm)	Correction Factor (dB)	Power Value (dBm)
1	1652.8	40.4	-13	-62.33	6.27	-56.06
2	2479.2	53.56	-13	-44.99	6.66	-38.33
3	3305.6	44.6	-13	-58.36	7.57	-50.79
4	4132	44.2	-13	-60.70	7.47	-53.23

**ANTENNA POLARITY & TEST DISTANCE: VERTICAL AT 3 M**

No.	Freq. (MHz)	Emission Level (dBuV)	Limit (dBm)	S.G Power Value (dBm)	Correction Factor (dB)	Power Value (dBm)
1	1652.8	41.5	-13	-61.23	6.27	-54.96
2	2479.2	47.9	-13	-50.65	6.66	-43.99
3	3305.6	43.8	-13	-59.16	7.57	-51.59
4	4132	44.2	-13	-60.70	7.47	-53.23

**NOTE:** Power Value (dBum) = S.G Power Value (dBm) + Correction Factor (dB).



A D T

<b>MODE</b>	TX channel 4182	<b>FREQUENCY RANGE</b>	Above 1000 MHz
<b>INPUT POWER</b>	120Vac, 60 Hz	<b>ENVIRONMENTAL CONDITIONS</b>	18deg. C, 63%RH, 1024hPa
<b>TESTED BY</b>	Wen Yu		

<b>ANTENNA POLARITY &amp; TEST DISTANCE: HORIZONTAL AT 3 M</b>						
No.	Freq. (MHz)	Emission Level (dBuV)	Limit (dBm)	S.G Power Value (dBm)	Correction Factor (dB)	Power Value (dBm)
1	1672.8	41.8	-13	-60.83	6.31	-54.52
<b>2</b>	<b>2509.2</b>	<b>54.6</b>	<b>-13</b>	<b>-43.92</b>	<b>6.66</b>	<b>-37.26</b>
3	3345.6	45.7	-13	-57.31	7.63	-49.68
4	4182	45.3	-13	-59.54	7.44	-52.10

<b>ANTENNA POLARITY &amp; TEST DISTANCE: VERTICAL AT 3 M</b>						
No.	Freq. (MHz)	Emission Level (dBuV)	Limit (dBm)	S.G Power Value (dBm)	Correction Factor (dB)	Power Value (dBm)
1	1672.8	42.6	-13	-60.03	6.31	-53.72
2	2509.2	48.8	-13	-49.72	6.66	-43.06
3	3345.6	44.7	-13	-58.31	7.63	-50.68
4	4182	44.5	-13	-60.34	7.44	-52.90

**NOTE:** Power Value (dBum) = S.G Power Value (dBm) + Correction Factor (dB).



A D T

<b>MODE</b>	TX channel 4233	<b>FREQUENCY RANGE</b>	Above 1000 MHz
<b>INPUT POWER</b>	120Vac, 60 Hz	<b>ENVIRONMENTAL CONDITIONS</b>	18deg. C, 63%RH, 1024hPa
<b>TESTED BY</b>	Wen Yu		

<b>ANTENNA POLARITY &amp; TEST DISTANCE: HORIZONTAL AT 3 M</b>						
No.	Freq. (MHz)	Emission Level (dBuV)	Limit (dBm)	S.G Power Value (dBm)	Correction Factor (dB)	Power Value (dBm)
1	1693.2	41.8	-13	-60.73	6.34	-54.38
2	2539.8	54.7	-13	-44.07	6.69	-37.38
3	3386.4	45.9	-13	-57.16	7.69	-49.48
4	4233	45.7	-13	-59.09	7.42	-51.67

<b>ANTENNA POLARITY &amp; TEST DISTANCE: VERTICAL AT 3 M</b>						
No.	Freq. (MHz)	Emission Level (dBuV)	Limit (dBm)	S.G Power Value (dBm)	Correction Factor (dB)	Power Value (dBm)
1	1693.2	42.8	-13	-59.73	6.34	-53.38
2	2539.8	48.6	-13	-50.17	6.69	-43.48
3	3386.4	44.7	-13	-58.36	7.69	-50.68
4	4233	44.9	-13	-59.89	7.42	-52.47

**NOTE:** Power Value (dBum) = S.G Power Value (dBm) + Correction Factor (dB).





A D T

## 5 PHOTOGRAPHS OF THE TEST CONFIGURATION

Please refer to the attached file (Test Setup Photo).



A D T

## 6 INFORMATION ON THE TESTING LABORATORIES

We, Bureau Veritas Consumer Products Services (H.K.) Ltd., Taoyuan Branch, were founded in 1988 to provide our best service in EMC, Radio, Telecom and Safety consultation. Our laboratories are accredited and approved according to ISO/IEC 17025.

Copies of accreditation certificates of our laboratories obtained from approval agencies can be downloaded from our web site: [www.adt.com.tw/index.5/phtml](http://www.adt.com.tw/index.5/phtml). If you have any comments, please feel free to contact us at the following:

**Linko EMC/RF Lab:**

Tel: 886-2-26052180

Fax: 886-2-26051924

**Hsin Chu EMC/RF Lab:**

Tel: 886-3-5935343

Fax: 886-3-5935342

**Hwa Ya EMC/RF/Safety/Telecom Lab:**

Tel: 886-3-3183232

Fax: 886-3-3185050

**Web Site:** [www.adt.com.tw](http://www.adt.com.tw)

The address and road map of all our labs can be found in our web site also.



A D T

## **7 APPENDIX A – MODIFICATIONS RECORDERS FOR ENGINEERING CHANGES TO THE EUT BY THE LAB**

No any modifications are made to the EUT by the lab during the test.

**---END---**