

WHA YU INDUSTRIAL CO., LTD. (HEAD OFFICE)
 TAI HWA ELECTRONIC CO., LTD.(CHINA)
 SHANGHAI HUA YU ELECTRONIC CO., LTD.(CHINA)
 AEON TECH CO., LTD. (CHINA)

SPECIFICATION FOR APPROVAL

CUSTOMER: 明泰科技股份有限公司



PART NAME: RF Antenna Assembly

PART NO.:

REVISION:

W. Y. P/NO.: C037-510695-A

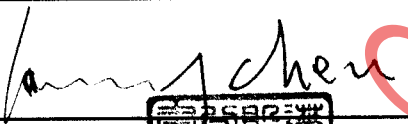
REV.: X3

	MANUFACTURER SIGNATURE	CUSTOMER SIGNATURE
APPROVED BY :		
DATE :	5/22, 	

WHA YU GROUP

WHA YU INDUSTRIAL CO., LTD.(HEAD OFFICE)

謙裕實業股份有限公司

Address: No.326, Sec 2, Kung Tao 5 Road, Hsin Chu City, Taiwan, R.O.C.

Tel:+886-3-5714225(REP.)

Fax:+ 886-3-5713853 · + 886-3-5723600

TAI HWA ELECTRONIC CO., LTD. (CHINA)

台樺電業製品廠

Address: Pak Ho District, Hiu Street Town, Dong Guan City, Guangdong, China

Tel: + 86-769-5599375 · + 86-769-5912375

Fax: + 86-769-5599376

HUA HONG INTERNATIONAL LTD.

華弘國際有限公司

Rm.1103A,President Commercial Centre,608 Nathan Road,Mong Kok,Kowloon,Hong Kong

Tel: + 86-852-27712210

Fax: + 86-852-23843747

SHANGHAI HUA YU ELECTRONIC CO., LTD. (CHINA)

上海謙裕電子有限公司

Address:3586,Wai Qing Song Road, Qing Pu County, Shanghai China

Tel: + 86-21-59741348 · + 86-21-59744101~4

Fax: + 86-21-59741347

SU ZHOU AEON TECH CO., LTD. (CHINA)

蘇州華廣電通有限公司

Address:Limin North Road, LiLi Town,LiLi Industrial Park,LinHu Economic Zone

Wujiang City, Jiangsu Province, China

Tel: + 86-512-63627980

Fax: + 86-512-63627981

Contents

Item	Description	Page
1.	天線規格表	1
2.	成品圖	2
3.	測試報告	3~5
4.	Cable 規格	6~7
5.	Connector 材質特性	8

REFERENCE ONLY

RF Antenna Cable Assembly

Specification

1. Electrical Properties :

- 1.1 Frequency Range..... 2.4GHz ~ 2.5GHz
- 1.2 Impedance 50Ω Nominal
- 1.3 VSWR 1.92 Max.
- 1.4 Return Loss..... -10 dB Maximum
- 1.5 Radiation Omni-directional
- 1.6 Gain(peak)..... 1.8dBi
- 1.7 Polarization..... Linear Vertical
- 1.8 Admitted Power..... 1W

2. Physical Properties :

- 2.1 Cable..... RG-178 Coaxial Cable
- 2.2 Antenna Cover..... TPU
- 2.3 Antenna Base..... PC
- 2.4 Antenna Base..... PBT
- 2.5 Operating Temp. -20 ~ +65
- 2.6 Storage Temp. -30 ~ +75
- 2.7 Color Black
- 2.8 Connector..... SMA Plug Reverse

CG-

REV	DATE	DESCRIPTION
X1	12/15-2005	New Issue

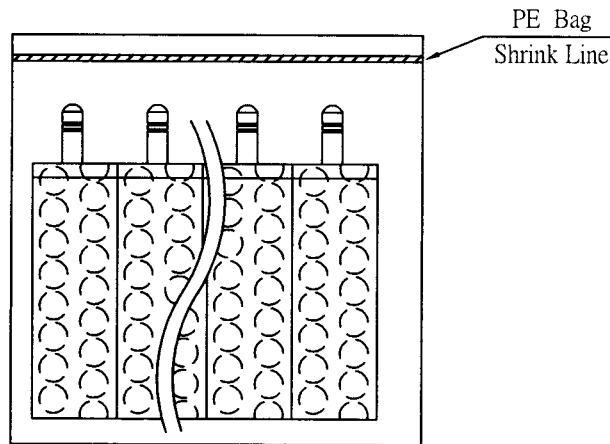
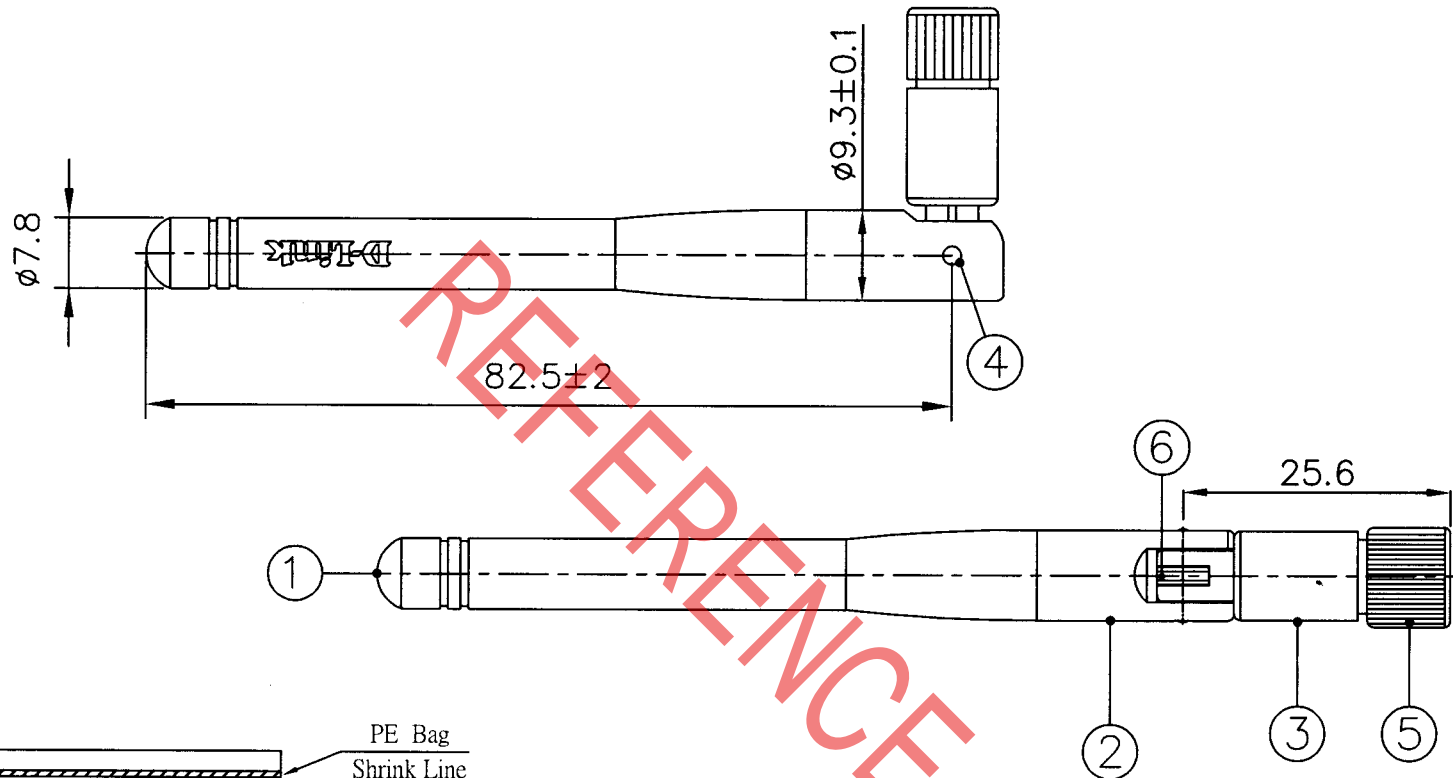

NO	DESCRIPTION	QTY	REMARK
6	Cable	RG-178 , Translucent Brown ; 50 Ω	1
5	Connector	SMA Straight Plug/Reverse	1
4	Rivet	Brass , Zn Plated (Black)	2
3	Antenna Base	PBT ; Color:Black	1
2	Antenna Base	PC ; Color:Black	1
1	Antenna Cover	TPU ; Color:Black	1

Packing : 20 pcs/bag

CUSTOMER'S SINGATURE

XX	± 5	APPROVED
X	± 1.0	胡超群
.X	± 0.1	CHECKED
.XX	± 0.01	林芸卉
.XXX	± 0.005	DRAWING
		程淑娟

CUSTOMER: 明泰科技股份有限公司		
PART NO :		
PARTNAME: RF Antenna Assembly		
W.Y P/NO : C037-510695-A		
REV	UNIT	FILE :
X1	m/m	SHEET : 1/1

Wha Yu INDUSTRIAL CO.,LTD.
譚裕實業股份有限公司
 THIS DRAWING, AND IT'S INHERANT DESIGN CONCEPTS, ARE THE PROPERTY OF WHA YU AND AS SUCH MAY NOT BE COPIED, REPRODUCED, OR GIVEN TO THIRD PARTIES WITHOUT THE WRITTEN CONSENT OF WHA YU.

- 5/13 -
7-5059240901176(E13723) B

RF Antenna Assembly
P/NO :C037-510695-A SPEC : 2.4GHz

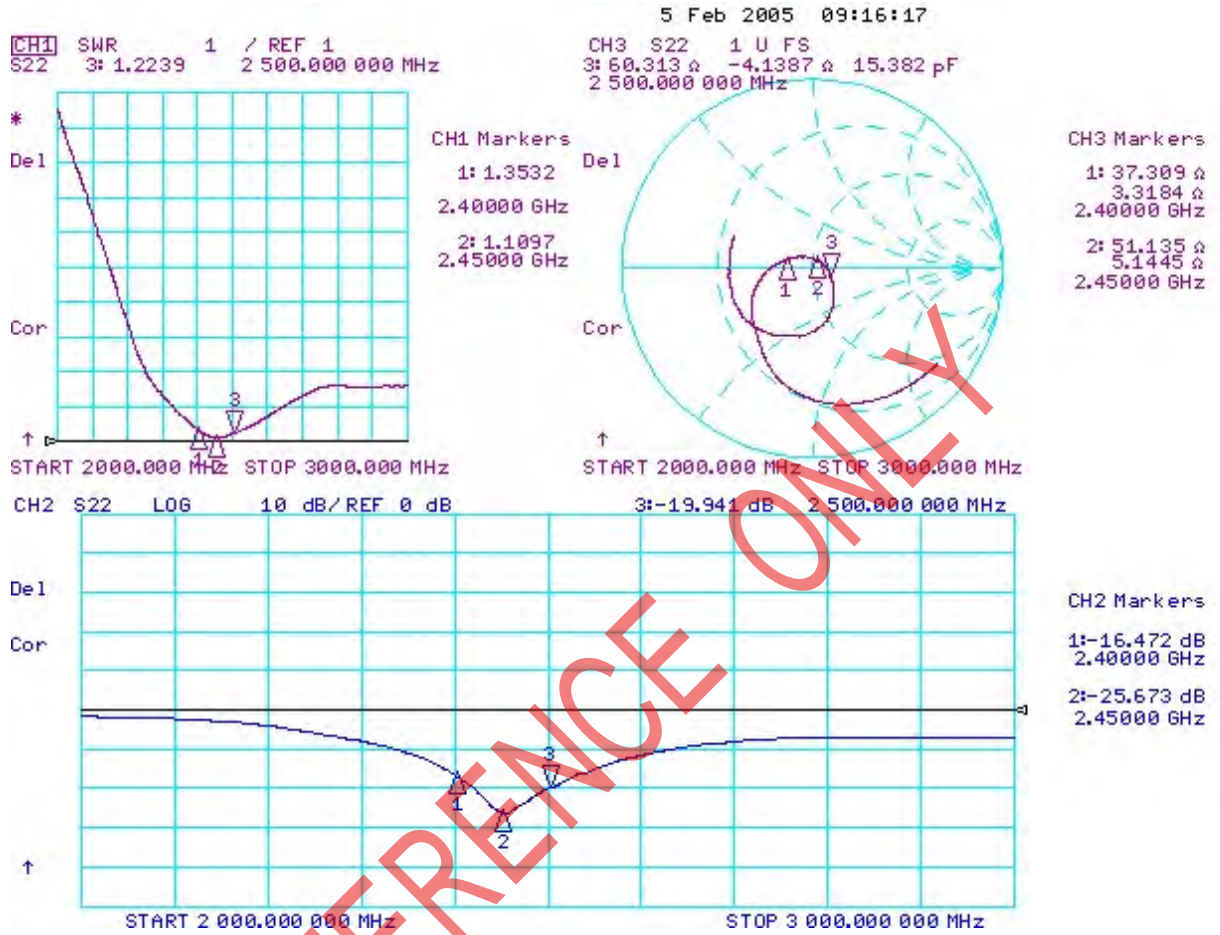

12/15/2005



譚裕實業股份有限公司

WHA YU INDUSTRIAL CO., LTD

Far-field amplitude of C037-510695-A-H.nsi

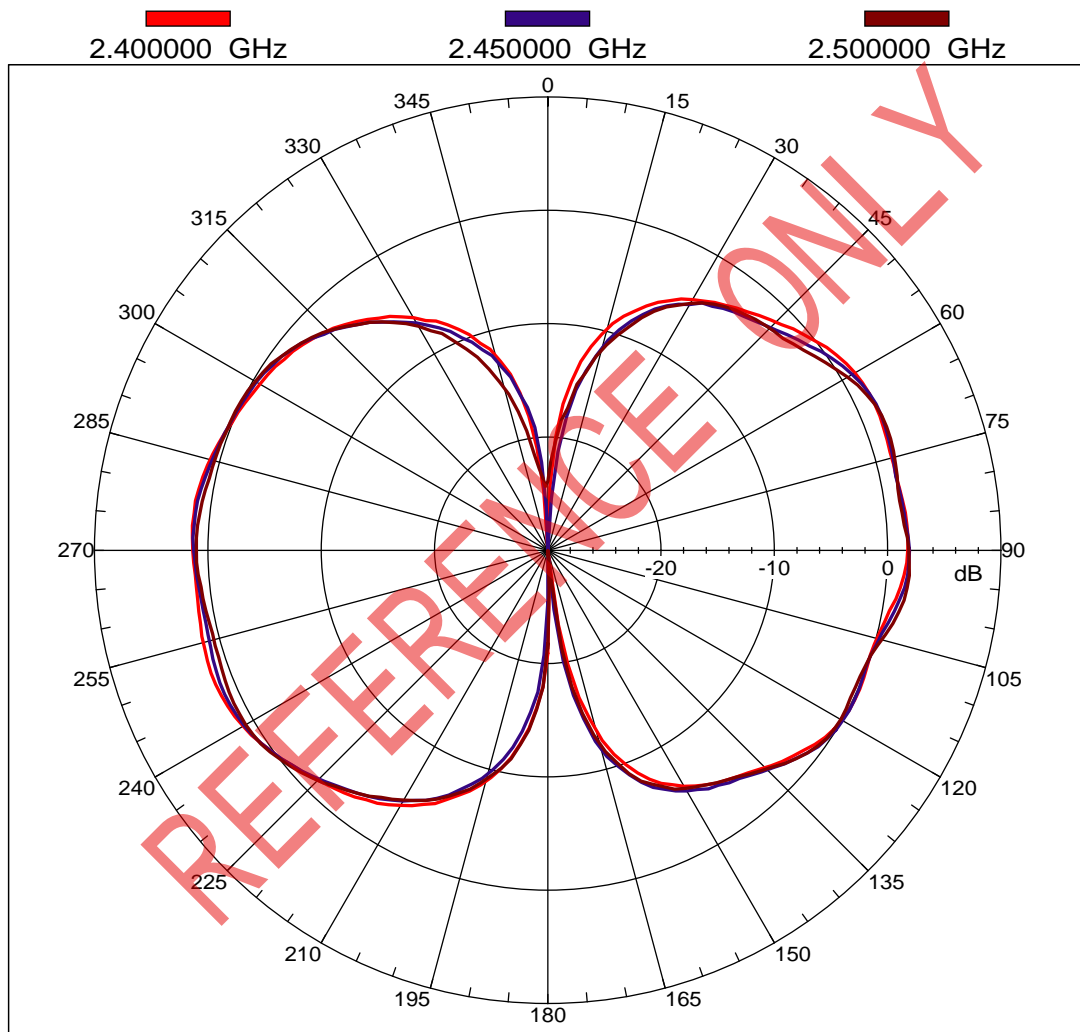



譚裕實業股份有限公司

WHA YU INDUSTRIAL CO., LTD

Far-field amplitude of C037-510695-A-V.nsi

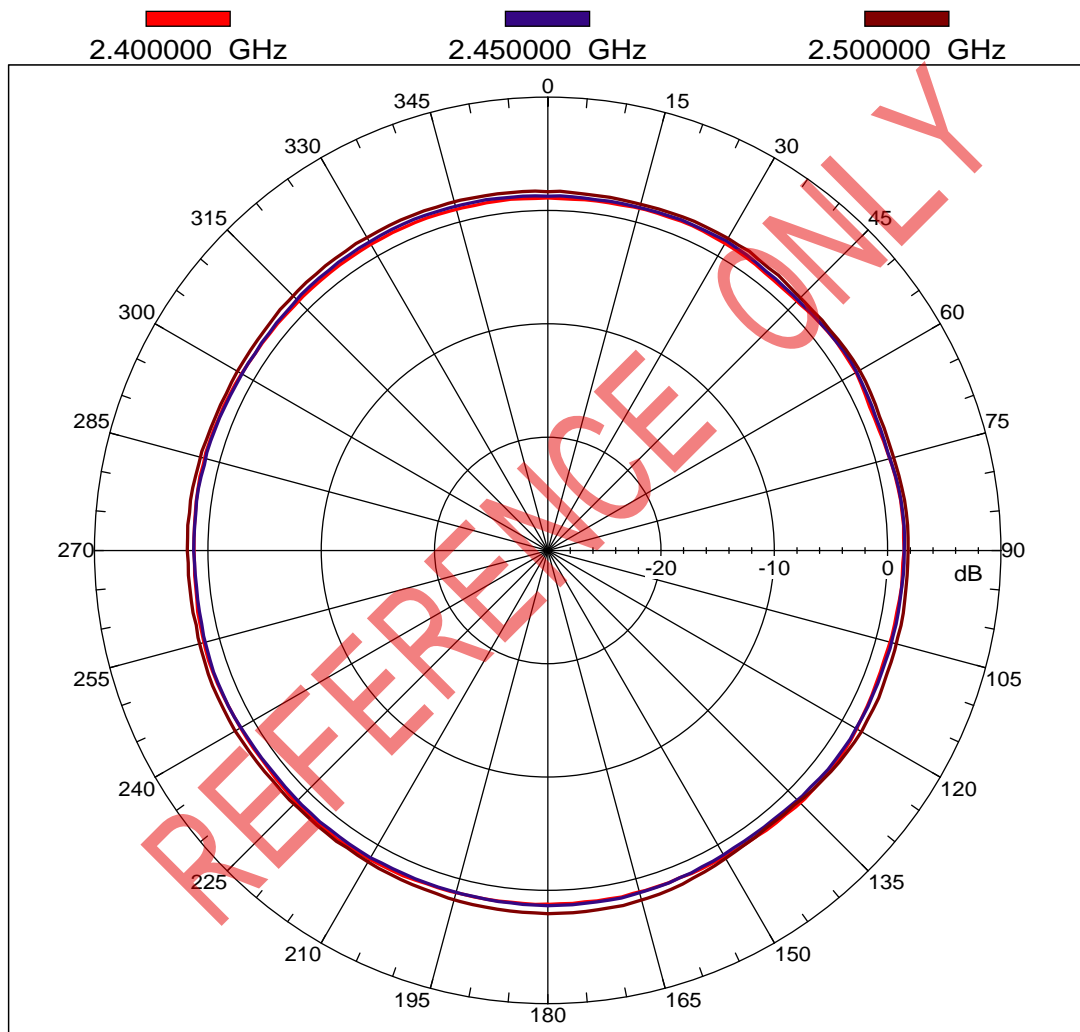

PRODUCT SPECIFICATION	ISSUED DATE	July.12, 2000	PAGE	1/2
	REVISION		REVISION NO.	

PRODUCT NAME : Coaxial Cable
RATING : -55°C ~ 200°C
ITEM : RG 178 B/U

REFERENCE ONLY

誠謙

No.	Revised Date	Revised Details	Page	Report

REPORTED BY :

APPROVED BY :



Q.C Engineer HOON LEE

Q.C Manager SOON-MOK SHIN

PRODUCT SPECIFICATION	ISSUED DATE	July.12, 2000	PAGE	2/2
	REVISION		REVISION NO.	

1. APPLICATIONS

This specification is applies to Coaxial Cable manufactured by the YOUNG CHANG SILICONE CO.,LTD

2. STRUCTURE

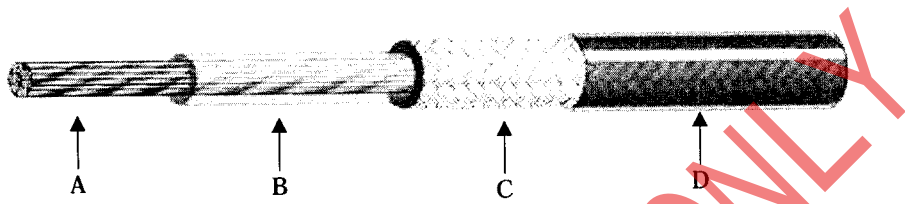

- A. Conductor: SCCS
- B. Insulation : PFA
- C. Shield : Silver-Plated Copper
- D. Jacket : FEP

3. DIMENSION

Conductor (SCCS)			Insulation		Shield		Jacket	
Structure	Cross sectional area	Diameter	Material	Diameter	Material	Diameter	Material	Diameter
Q'ty/mmφ	mm ² (SQ)	mmφ		mmφ		mmφ		mmφ
7/0.102	0.06	0.30	PFA	0.84±0.05	SPC	1.25	FEP	1.80±0.10

4. ELECTRIC PROPERTIES

Impedance	Capacitance	Maximum Attenuation (dB/100ft)				Dielectric Sterngth
		100Mhz	400Mhz	1Ghz	3Ghz	
ohms	pF/ft(Max)					V/1min
50 ± 2	32	16.0	33.0	52.0	94.0	2000



華裕實業股份有限公司

WHA YU INDUSTRIAL CO., LTD

Connector 材質證明書

華裕料號 Whyu P/N	100-2001150-AZ	產品名稱 Product Name	SMA Plug Reverse Straight For RG-178
------------------	----------------	----------------------	--------------------------------------

結構圖面

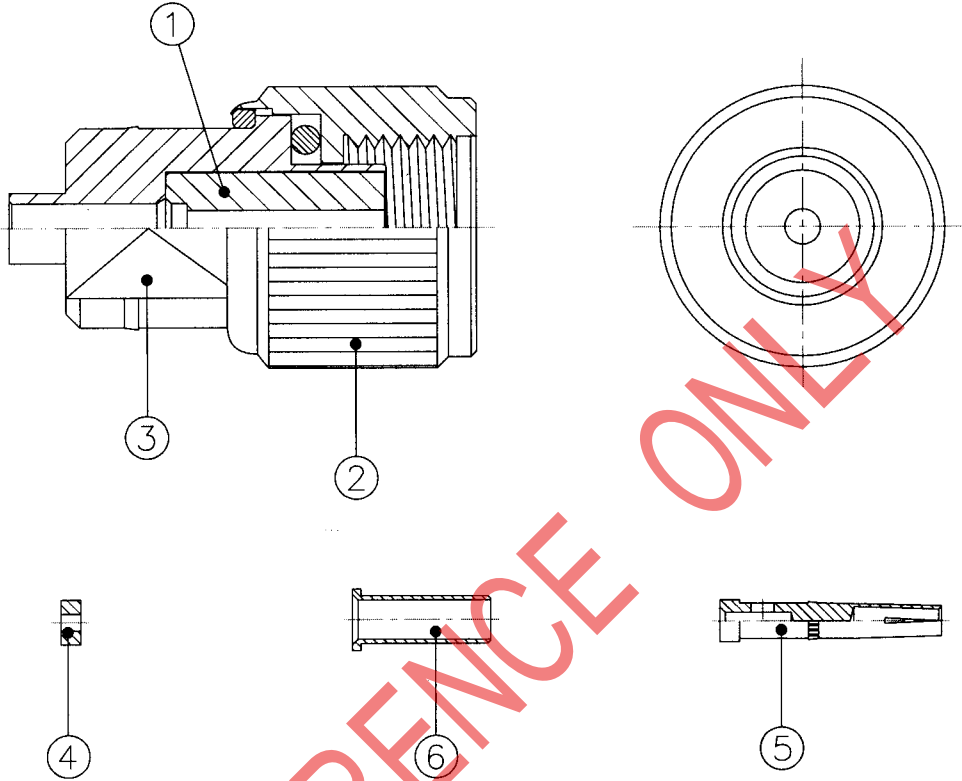

材質成份







表面處理

Part No.	Part Name	Material	Material Composition	Surface Treatment
1	絕緣體	Teflon	PTFE	N/A
2	外殼	Brass	Cu Pb Fe Fe+Sn Zn	電著
3	本體	Brass	Cu Pb Fe Fe+Sn Zn	鍍鎳
4	絕緣體	Teflon	PTFE	N/A
5	中心針	Phos. Bronze	Cu Sn P Zn Pb	鍍金
6	尾管	Brass	Cu Pb Fe Fe+Sn Zn	鍍鎳

Remark :



REFERENCE ONLY

Item	ALPHA P/N	原廠型號	品名(Description)	VENDOR CODE	原廠商	代理商	NO.	分離之均勻材質 (Homogeneous Material) Sub-parts	分離之均勻材質重量	零件重量 (mg)	物質宣告書 (Material Declaration)	ICP測定數據 mg/kg-ppm						分析報告號碼及(實驗室名稱)	第三公證單位化學分析報告 Attached test report
												鉛(Pb)	鎘(Cd)	汞(Hg)	六價鉻 (Cr+6)	PBB	PBDE		
1	C037-510695-A	RF Antenna Assembly	WHAYU	1-1	Cable	540.	11500	ND	ND	ND	ND	ND	ND	F690501/LF-CTS500034(SGS)					
								ND	ND	ND	ND	ND	ND	F690501/LF-CTS500035(SGS)					
								ND	ND	ND	ND	ND	6.1	F690501/LF-CTSGP06-0418(SGS)					
								ND	ND	ND	ND	ND	ND	F690501/LF-CTSGP05-5552(SGS)					
								ND	ND	ND	ND	ND	ND	CE/2005/45290A(SGS)					
								ND	ND	ND	ND	ND	ND	CE/2005/71420(SGS)					
								ND	ND	ND	ND	ND	ND	GZSCR050827860(SGS)					
								ND	ND	ND	ND	ND	ND	GZSCR05060707862/LP(SGS)					
								ND	ND	ND	ND	ND	ND	GZSCR050827860(SGS)					
								30,996.7	70.2	ND	ND	ND	ND	CE/2006/39133(SGS)					
								ND	ND	ND	ND	ND	ND	SH570049/CHEM(SGS)					
								31,000.	19.	ND	ND	ND	ND	GZML060201325(SGS)					
								ND	ND	ND	ND	ND	ND	GZ0602014138/CHEM(SGS)					
								ND	ND	ND	ND	ND	ND	KA/2006/20922A-01(SGS)					
ND	ND	ND	ND	ND	ND	KA/2006/20923A-01(SGS)													
34,463.3	42.	ND	ND	ND	ND	CE/2005/96120(SGS)													
ND	ND	ND	ND	ND	ND	CE/2005/96111(SGS)													

POWER B.O.M LIST FOR ROHS TEST REPORTS

物質成份調查表

ITEM	品名(Description)	廠商名稱	符合RoHS原廠型號	NO.	分離之均勻材質	零件單重(mg)	分離之均勻材質單重(mg)	物質宣告書	ICP測定數據mg/kg=ppm						MTBF (h)	耐溫條件(溫度/時間)	分析報告號碼(實驗室名稱)	第三公證單位化學分析測試報告			
									鉛(Pb)	鎘(Cd)	汞(Hg)	六價鉻(Cr+6)	PBB	PBDE							
1	RF Antenna Assembly	C037-510695-A		1-1	Cable		540.		ND	ND	ND	ND	ND	ND			F690501/LF-CTS500034(SGS)				
									ND	ND	ND	ND	ND	ND			F690501/LF-CTS500035(SGS)				
												ND	ND	ND	ND	ND	6.1			F690501/LF-CTSGP06-0418(SGS)	
												ND	ND	ND	ND	ND	ND			F690501/LF-CTSGP05-5552(SGS)	
				1-2	Antenna Body		3,200.	ND	ND	ND	ND	ND	ND	ND	ND			CE/2005/45290A(SGS)			
				1-3	Antenna Base							ND	ND	ND	ND	ND	ND			CE/2005/71420(SGS)	
												ND	ND	ND	ND	ND	ND			GZSCR050827860(SGS)	
				1-4	Antenna Base					11500		ND	ND	ND	ND	ND	ND			GZSCR05060707862/LP(SGS)	
												ND	ND	ND	ND	ND	ND			GZSCR050827860(SGS)	
				1-5	Rivet							30,996.7	70.2	ND	ND	ND	ND			CE/2006/39133(SGS)	RoHS排外條款(銅合金)
												ND	ND	ND	ND	ND	ND			SH570049/CHEM(SGS)	
				1-6	Connector							31,000.	19.	ND	ND	ND	ND			GZML060201325(SGS)	RoHS排外條款(銅合金)
												ND	ND	ND	ND	ND	ND			GZ0602014138/CHEM(SGS)	
												ND	ND	ND	ND	ND	ND			KA/2006/20922A-01(SGS)	
ND	ND	ND	ND									ND	ND			KA/2006/20923A-01(SGS)					
1-7	Ground Tube							34,463.3	42.	ND	ND	ND	ND			CE/2005/96120(SGS)	RoHS排外條款(銅合金)				
								ND	ND	ND	ND	ND	ND			CE/2005/96111(SGS)					

- 13/13 -

7-505924090117G(E13723) B

REFERENCE ONLY