



FCC TEST REPORT

REPORT NO.: RF960821H02A

MODEL NO.: DIR-280

RECEIVED: July 03, 2008

TESTED: July 03 to Aug. 05, 2008

ISSUED: Sep. 03, 2008

APPLICANT: D-Link Co.

ADDRESS: No.289, Shinhu 3rd Rd., Neihu District, Taipei
City 114, Taiwan, R.O.C.

ISSUED BY: Advance Data Technology Corporation

LAB ADDRESS: No. 81-1, Lu Liao Keng, 9 Ling, Wu Lung Tsuen,
Chiung Lin Hsiang, Hsin Chu Hsien,
Taiwan, R.O.C.

This test report consists of 62 pages in total. It may be duplicated completely for legal use with the approval of the applicant. It should not be reproduced except in full, without the written approval of our laboratory. The client should not use it to claim product endorsement by any government agencies. The test results in the report only apply to the tested sample.

Table of Contents

1.	CERTIFICATION	4
2.	SUMMARY OF TEST RESULTS	5
2.1	MEASUREMENT UNCERTAINTY	6
3.	GENERAL INFORMATION	7
3.1	GENERAL DESCRIPTION OF EUT	7
3.2	DESCRIPTION OF TEST MODES	8
3.2.1	TEST MODE APPLICABILITY AND TESTED CHANNEL DETAIL:	9
3.3	GENERAL DESCRIPTION OF APPLIED STANDARDS	11
3.4	DESCRIPTION OF SUPPORT UNITS	12
3.5	CONFIGURATION OF SYSTEM UNDER TEST	13
4.	TEST TYPES AND RESULTS	15
4.1	CONDUCTED EMISSION MEASUREMENT	15
4.1.1	LIMITS OF CONDUCTED EMISSION MEASUREMENT	15
4.1.2	TEST INSTRUMENTS	15
4.1.3	TEST PROCEDURES	16
4.1.4	DEVIATION FROM TEST STANDARD	16
4.1.5	TEST SETUP	17
4.1.6	EUT OPERATING CONDITIONS	17
4.1.7	TEST RESULTS	18
4.2	RADIATED EMISSION MEASUREMENT	20
4.2.1	LIMITS OF RADIATED EMISSION MEASUREMENT	20
4.2.2	TEST INSTRUMENTS	21
4.2.3	TEST PROCEDURES	22
4.2.4	DEVIATION FROM TEST STANDARD	22
4.2.5	TEST SETUP	23
4.2.6	EUT OPERATING CONDITIONS	23
4.2.7	TEST RESULTS	24
4.3	6DB BANDWIDTH MEASUREMENT	39
4.3.1	LIMITS OF 6DB BANDWIDTH MEASUREMENT	39
4.3.2	TEST INSTRUMENTS	39
4.3.3	TEST PROCEDURE	40
4.3.4	DEVIATION FROM TEST STANDARD	40
4.3.5	TEST SETUP	40
4.3.6	EUT OPERATING CONDITIONS	40
4.3.7	TEST RESULTS	41
4.4	MAXIMUM PEAK OUTPUT POWER	45
4.4.1	LIMITS OF MAXIMUM PEAK OUTPUT POWER MEASUREMENT	45
4.4.2	INSTRUMENTS	45



4.4.3	TEST PROCEDURES.....	46
4.4.4	DEVIATION FROM TEST STANDARD	46
4.4.5	TEST SETUP	46
4.4.6	EUT OPERATING CONDITIONS.....	46
4.4.7	TEST RESULTS.....	47
4.5	POWER SPECTRAL DENSITY MEASUREMENT.....	48
4.5.1	LIMITS OF POWER SPECTRAL DENSITY MEASUREMENT	48
4.5.2	TEST INSTRUMENTS	48
4.5.3	TEST PROCEDURE	49
4.5.4	DEVIATION FROM TEST STANDARD	49
4.5.5	TEST SETUP	49
4.5.6	EUT OPERATING CONDITION	49
4.5.7	TEST RESULTS.....	50
4.6	OUT-BAND EMISSION MEASUREMENT	54
4.6.1	LIMITS OF OUT-BAND EMISSION MEASUREMENT	54
4.6.2	TEST INSTRUMENTS	54
4.6.3	TEST PROCEDURE	54
4.6.4	DEVIATION FROM TEST STANDARD	55
4.6.5	EUT OPERATING CONDITION	55
4.6.6	TEST RESULTS.....	55
4.7	ANTENNA REQUIREMENT.....	60
4.7.1	STANDARD APPLICABLE	60
4.7.2	ANTENNA CONNECTED CONSTRUCTION.....	60
5.	INFORMATION ON THE TESTING LABORATORIES	61
6.	APPENDIX A - MODIFICATIONS RECORDERS FOR ENGINEERING CHANGES TO THE EUT BY THE LAB	62



1. CERTIFICATION

PRODUCT: Wireless G Router
BRAND NAME: D-Link
MODEL NO.: DIR-280
TEST SAMPLE: ENGINEERING SAMPLE
TESTED: July 03 to Aug. 05, 2008
APPLICANT: D-Link Co.
STANDARDS: FCC Part 15, Subpart C (Section 15.247),
ANSI C63.4-2003

The above equipment (Model: DIR-280) has been tested by **Advance Data Technology Corporation**, and found compliance with the requirement of the above standards. The test record, data evaluation & Equipment Under Test (EUT) configurations represented herein are true and accurate accounts of the measurements of the sample's EMC characteristics under the conditions specified in this report.

PREPARED BY : Claire Kuan , **DATE:** Sep. 03, 2008
(Claire Kuan, Specialist)

TECHNICAL ACCEPTANCE : Hank Chung , **DATE:** Sep. 03, 2008
Responsible for RF (Hank Chung, Deputy Manager)

APPROVED BY : May Chen , **DATE:** Sep. 03, 2008
(May Chen, Deputy Manager)

2. SUMMARY OF TEST RESULTS

The EUT has been tested according to the following specifications:

APPLIED STANDARD: FCC Part 15, Subpart C (Section 15.247)			
Standard Section	Test Type and Limit	Result	Remark
15.207	AC Power Conducted Emission	PASS	Meet the requirement of limit. Minimum passing margin is -3.49dB at 0.185MHz
15.247(a)(2)	Spectrum Bandwidth of a Direct Sequence Spread Spectrum System Limit: min. 500kHz	PASS	Meet the requirement of limit.
15.247(b)	Maximum Peak Output Power Limit: max. 30dBm	PASS	Meet the requirement of limit.
15.247(d)	Radiated Emissions Limit: Table 15.209	PASS	Meet the requirement of limit. Minimum passing margin is -0.96dB at 2360.00MHz & 7311.00MHz
15.247(e)	Power Spectral Density Limit: max. 8dBm	PASS	Meet the requirement of limit.
15.247(d)	Band Edge Measurement Limit: 20dB less than the peak value of fundamental frequency	PASS	Meet the requirement of limit.

2.1 MEASUREMENT UNCERTAINTY

Where relevant, the following measurement uncertainty levels have been estimated for tests performed on the EUT as specified in CISPR 16-4:

This uncertainty represents an expanded uncertainty expressed at approximately the 95% confidence level using a coverage factor of $k=2$.

Measurement	Value
Conducted emissions	2.44 dB
Radiated emissions (30MHz-1GHz)	3.94 dB
Radiated emissions (1GHz -18GHz)	2.33 dB
Radiated emissions (18GHz -40GHz)	2.55 dB

3. GENERAL INFORMATION

3.1 GENERAL DESCRIPTION OF EUT

PRODUCT	Wireless G Router
MODEL NO.	DIR-280
FCC ID	KA2DIR280A1
POWER SUPPLY	DC 12V from power adapter
MODULATION TYPE	CCK, DQPSK, DBPSK for DSSS 64QAM, 16QAM, QPSK, BPSK for OFDM
MODULATION TECHNOLOGY	DSSS, OFDM
TRANSFER RATE	802.11b: 11 / 5.5 / 2 / 1Mbps 802.11g: 54 / 48 / 36 / 24 / 18 / 12 / 9 / 6Mbps
FREQUENCY RANGE	2412 ~ 2462MHz
MAXIMUM OUTPUT POWER	802.11b: 109.648mW 802.11g: 275.423mW
ANTENNA TYPE	Dipole antenna with 1.1dBi antenna gain
DATA CABLE	RJ-45 (Unshielded, 1.5m)
I/O PORT	LAN port x 4 Internet port x1

NOTE:

- There is one antenna provided to this EUT, please refer to the following table:

Model No.	Gain (dBi)	Cable lose (dB)	Net Gain (dBi)	Antenna Type	Connector
C037-510843-A	2	0.9	1.1	Dipole	NA

- The EUT must be supplied with a power adapter as following:

Brand:	AMIGO
Model No.:	AM-121200A
Input power :	120VAC, 60Hz, 200mA
Output power :	12VAC, 1200mA Cable : Unshielded without core , 1.8m

- For radiated test, the EUT was pre-tested in chamber under the following modes:

Test Mode	Description
Mode A	Level-set (Put on tabletop)
Mode B	Tower-set (Wall-mounted)

From the above modes, worse case was found in **Mode B**. Therefore only the test data of the mode was recorded in this report.



4. The above EUT information was declared by the manufacturer and for more detailed features description, please refer to the manufacturer's specifications or User's Manual.

3.2 DESCRIPTION OF TEST MODES

Eleven channels are provided for 802.11b, 802.11g:

CHANNEL	FREQUENCY	CHANNEL	FREQUENCY
1	2412MHz	7	2442MHz
2	2417MHz	8	2447MHz
3	2422MHz	9	2452MHz
4	2427MHz	10	2457MHz
5	2432MHz	11	2462MHz
6	2437MHz		

3.2.1 TEST MODE APPLICABILITY AND TESTED CHANNEL DETAIL:

EUT CONFIGURE MODE	APPLICABLE TO				DESCRIPTION
	PLC	RE < 1G	RE ≥ 1G	APCM	
-	√	√	√	√	-

Where **PLC**: Power Line Conducted Emission **RE < 1G**: Radiated Emission below 1GHz
RE ≥ 1G: Radiated Emission above 1GHz **APCM**: Antenna Port Conducted Measurement

POWER LINE CONDUCTED EMISSION TEST:

- Pre-Scan has been conducted to determine the worst-case mode from all possible combinations between available modulations, data rates and antenna ports (if EUT with antenna diversity architecture).
- Following channel(s) was (were) selected for the final test as listed below.

MODE	AVAILABLE CHANNEL	TESTED CHANNEL	MODULATION TECHNOLOGY	MODULATION TYPE	DATA RATE (Mbps)
802.11b	1 to 11	1	DSSS	DBPSK	1

RADIATED EMISSION TEST (BELOW 1 GHZ):

- Pre-Scan has been conducted to determine the worst-case mode from all possible combinations between available modulations, data rates and antenna ports (if EUT with antenna diversity architecture).
- Following channel(s) was (were) selected for the final test as listed below.

MODE	AVAILABLE CHANNEL	TESTED CHANNEL	MODULATION TECHNOLOGY	MODULATION TYPE	DATA RATE (Mbps)
802.11g	1 to 11	1	DSSS	DBPSK	1

RADIATED EMISSION TEST (ABOVE 1 GHz):

- Pre-Scan has been conducted to determine the worst-case mode from all possible combinations between available modulations, data rates and antenna ports (if EUT with antenna diversity architecture).
- Following channel(s) was (were) selected for the final test as listed below.

MODE	AVAILABLE CHANNEL	TESTED CHANNEL	MODULATION TECHNOLOGY	MODULATION TYPE	DATA RATE (Mbps)
802.11b	1 to 11	1, 6, 11	DSSS	DBPSK	1
802.11g	1 to 11	1, 6, 11	OFDM	BPSK	6

BANDEDGE MEASUREMENT:

- Pre-Scan has been conducted to determine the worst-case mode from all possible combinations between available modulations, data rates and antenna ports (if EUT with antenna diversity architecture).
- Following channel(s) was (were) selected for the final test as listed below.

MODE	AVAILABLE CHANNEL	TESTED CHANNEL	MODULATION TECHNOLOGY	MODULATION TYPE	DATA RATE (Mbps)
802.11b	1 to 11	1, 11	DSSS	DBPSK	1
802.11g	1 to 11	1, 11	OFDM	BPSK	6

ANTENNA PORT CONDUCTED MEASUREMENT:

- Pre-Scan has been conducted to determine the worst-case mode from all possible combinations between available modulations, data rates and antenna ports (if EUT with antenna diversity architecture).
- Following channel(s) was (were) selected for the final test as listed below.

MODE	AVAILABLE CHANNEL	TESTED CHANNEL	MODULATION TECHNOLOGY	MODULATION TYPE	DATA RATE (Mbps)
802.11b	1 to 11	1, 6, 11	DSSS	DBPSK	1
802.11g	1 to 11	1, 6, 11	OFDM	BPSK	6



3.3 GENERAL DESCRIPTION OF APPLIED STANDARDS

The EUT is a Wireless G Router. According to the specifications of the manufacturer, it must comply with the requirements of the following standards:

FCC Part 15, Subpart C. (15.247)

ANSI C63.4-2003

All test items have been performed and recorded as per the above standards.

NOTE: The EUT is also considered as a kind of computer peripheral, because the connection to computer is necessary for typical use. It has been verified to comply with the requirements of FCC Part 15, Subpart B, Class B (DoC). The test report has been issued separately.



3.4 DESCRIPTION OF SUPPORT UNITS

The EUT has been tested as an independent unit together with other necessary accessories or support units. The following support units or accessories were used to form a representative test configuration during the tests.

NO.	PRODUCT	BRAND	MODEL NO.	SERIAL NO.	FCC ID
1	NOTEBOOK COMPUTER	DELL	PP18L	6976685584	FCC DoC
2	NOTEBOOK COMPUTER	HP	HSTNN-S19C	WFY93-WQ98K-BH87F-K D366-RB773	NA
3	NOTEBOOK COMPUTER (Only for conducted test)	DELL	D600(PP05L)	CN-0G5152-48643G-6504	NA
4	HUB	AVSYS	110H8	01-20E-000006	FCC DoC

NO.	SIGNAL CABLE DESCRIPTION OF THE ABOVE SUPPORT UNITS
1	NA
2	NA
3	NA
4	NA

NOTE: All power cords of the above support units are non shielded (1.8m).

3.5 CONFIGURATION OF SYSTEM UNDER TEST

For Conducted test:

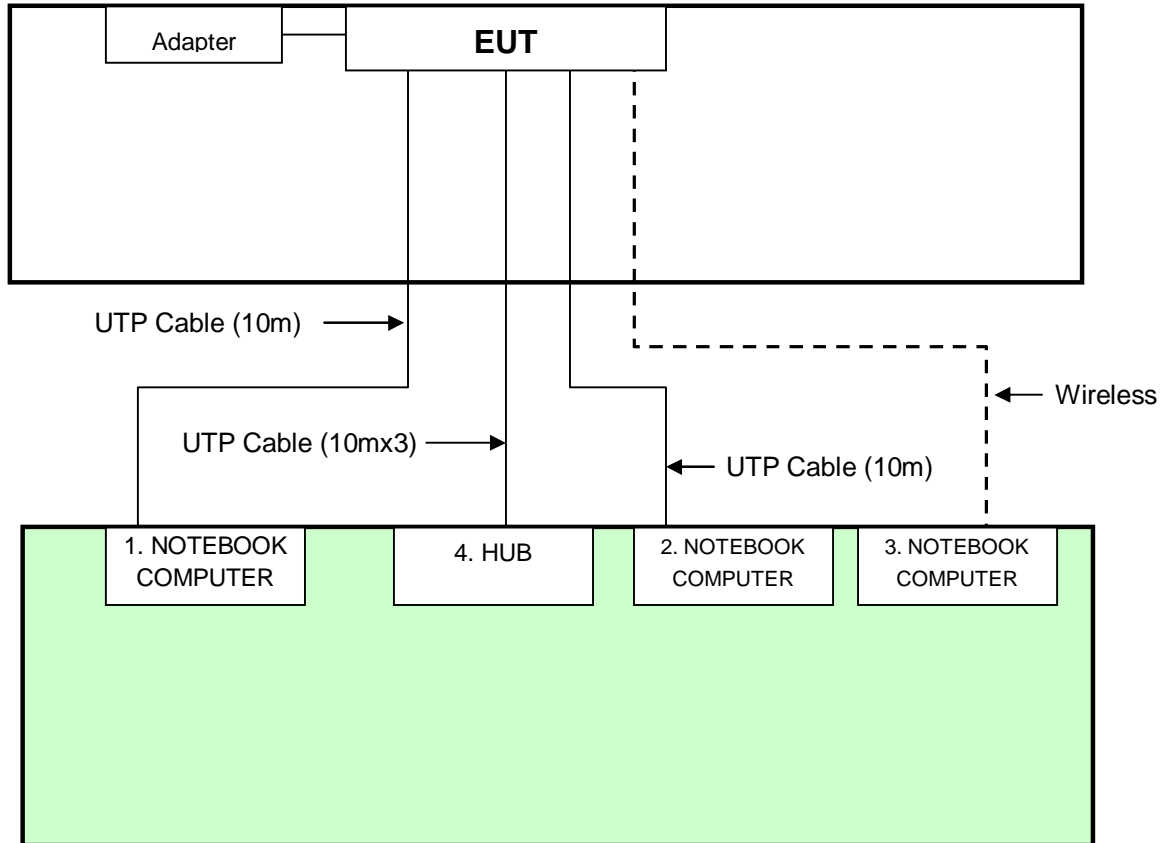

NOTE: 1. Support units 1 ~4 were kept in the control room during the test.

For Other test:

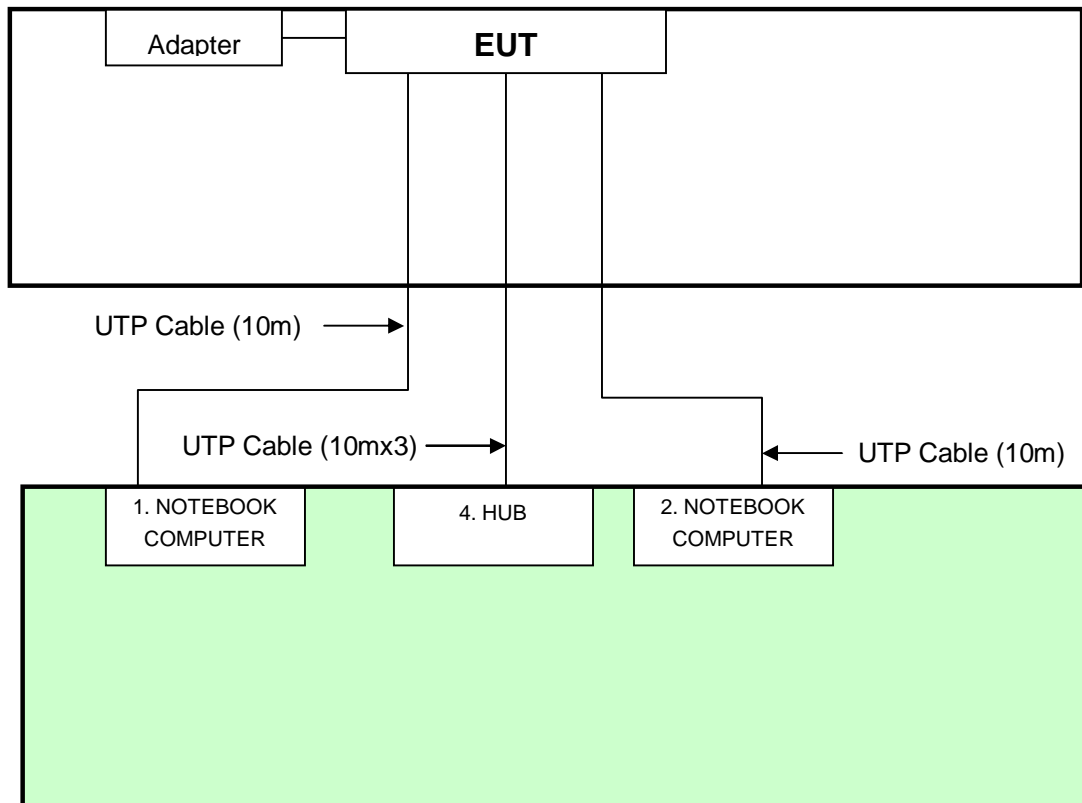

NOTE: 1. Support units 1~2, 4 were kept in the control room during the test.

4. TEST TYPES AND RESULTS

4.1 CONDUCTED EMISSION MEASUREMENT

4.1.1 LIMITS OF CONDUCTED EMISSION MEASUREMENT

FREQUENCY OF EMISSION (MHz)	CONDUCTED LIMIT (dB μ V)	
	Quasi-peak	Average
0.15-0.5	66 to 56	56 to 46
0.5-5	56	46
5-30	60	50

- NOTE:**
1. The lower limit shall apply at the transition frequencies.
 2. The limit decreases in line with the logarithm of the frequency in the range of 0.15 to 0.50 MHz.
 3. All emanations from a class A/B digital device or system, including any network of conductors and apparatus connected thereto, shall not exceed the level of field strengths specified above.

4.1.2 TEST INSTRUMENTS

DESCRIPTION & MANUFACTURER	MODEL NO.	SERIAL NO.	CALIBRATED UNTIL
ROHDE & SCHWARZ Test Receiver	ESCS 30	100287	Mar. 10, 2009
Line-Impedance Stabilization Network(for EUT)	KNW-407	8-1395-12	May. 06, 2009
Line-Impedance Stabilization Network(for Peripheral)	ENV-216	100072	Jun. 12, 2009
RF Cable (JYEBAO)	5DFB	COACAB-001	Jul. 23, 2009
50 ohms Terminator	50	3	Nov. 15, 2008
Software	ADT_Cond_V7.3.2	NA	NA

- NOTE:**
1. The calibration interval of the above test instruments is 12 months and the calibrations are traceable to NML/ROC and NIST/USA.
 2. The test was performed in ADT Shielded Room No. A.
 3. The VCCI Con A Registration No. is C-817.

4.1.3 TEST PROCEDURES

- a. The EUT was placed 0.4 meters from the conducting wall of the shielded room with EUT being connected to the power mains through a line impedance stabilization network (LISN). Other support units were connected to the power mains through another LISN. The two LISNs provide 50 ohm/ 50uH of coupling impedance for the measuring instrument.
- b. Both lines of the power mains connected to the EUT were checked for maximum conducted interference.
- c. The frequency range from 150kHz to 30MHz was searched. Emission levels under (Limit - 20dB) were not recorded.

4.1.4 DEVIATION FROM TEST STANDARD

No deviation

4.1.5 TEST SETUP

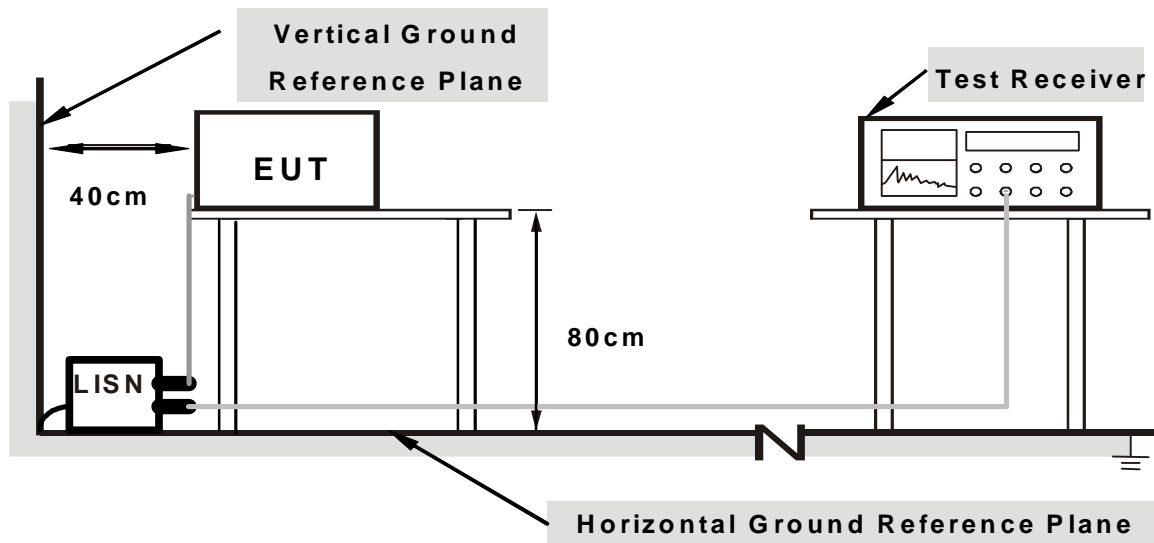

Note: 1. Support units were connected to second LISN.

2. Both of LISNs (AMN) are 80 cm from EUT and at least 80 from other units and other metal planes

For the actual test configuration, please refer to the related item – Photographs of the Test Configuration.

4.1.6 EUT OPERATING CONDITIONS

1. Placed the EUT on testing table.
2. Prepared other computer systems (support units 1 ~ 3) to act as communication partners and placed them outside of testing area.
3. The communication partners run test program "MP A/B/G TEST" to enable EUT under transmission/receiving condition continuously via UTP cables and wireless.

4.1.7 TEST RESULTS

802.11b DBPSK MODULATION

EUT TEST CONDITION		MEASUREMENT DETAIL	
CHANNEL	Channel 1	PHASE	Line (L)
MODULATION TYPE	DBPSK	6dB BANDWIDTH	9 kHz
TRANSFER RATE	1Mbps	INPUT POWER	120Vac, 60 Hz
ENVIRONMENTAL CONDITIONS	25deg. C, 66%RH, 955hPa	TESTED BY	Phoenix Huang

No	Freq. [MHz]	Corr. Factor (dB)	Reading Value [dB (uV)]		Emission Level [dB (uV)]		Limit [dB (uV)]		Margin (dB)	
			Q.P.	AV.	Q.P.	AV.	Q.P.	AV.	Q.P.	AV.
	1	0.158	0.40	60.22	31.13	60.62	31.53	65.58	55.58	-4.96
2	0.185	0.40	60.36	30.43	60.76	30.83	64.25	54.25	-3.49	-23.42
3	0.228	0.40	54.90	25.65	55.30	26.05	62.52	52.52	-7.22	-26.47
4	0.292	0.40	47.24	-	47.64	-	60.47	50.47	-12.83	-
5	9.629	0.79	45.88	-	46.67	-	60.00	50.00	-13.33	-
6	18.488	1.03	40.74	-	41.77	-	60.00	50.00	-18.23	-

- REMARKS:**
1. Q.P. and AV. are abbreviations of quasi-peak and average individually.
 2. "-": The Quasi-peak reading value also meets average limit and measurement with the average detector is unnecessary.
 3. The emission levels of other frequencies were very low against the limit.
 4. Margin value = Emission level - Limit value
 5. Correction factor = Insertion loss + Cable loss
 6. Emission Level = Correction Factor + Reading Value.

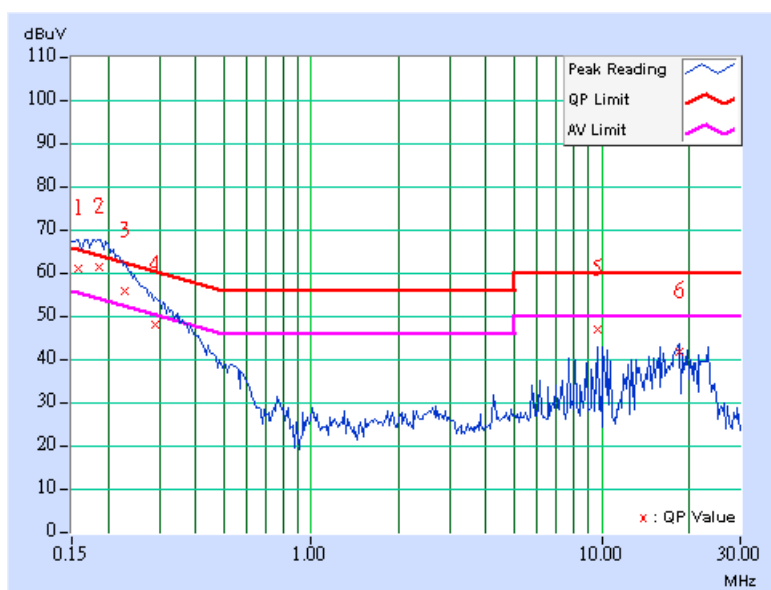

EUT TEST CONDITION		MEASUREMENT DETAIL	
CHANNEL	Channel 1	PHASE	Neutral (N)
MODULATION TYPE	DBPSK	6dB BANDWIDTH	9 kHz
TRANSFER RATE	1Mbps	INPUT POWER	120Vac, 60 Hz
ENVIRONMENTAL CONDITIONS	25deg. C, 66%RH, 955hPa	TESTED BY	Phoenix Huang

No	Freq. [MHz]	Corr. Factor (dB)	Reading Value [dB (uV)]		Emission Level [dB (uV)]		Limit [dB (uV)]		Margin (dB)	
			Q.P.	AV.	Q.P.	AV.	Q.P.	AV.	Q.P.	AV.
	1	0.177	0.20	60.02	30.70	60.22	30.90	64.61	54.61	-4.39
2	0.201	0.20	58.73	29.02	58.93	29.22	63.58	53.58	-4.65	-24.36
3	0.291	0.20	46.96	-	47.16	-	60.51	50.51	-13.35	-
4	0.416	0.20	37.25	-	37.45	-	57.54	47.54	-20.08	-
5	9.250	0.85	46.80	-	47.65	-	60.00	50.00	-12.35	-
6	18.242	1.26	44.20	-	44.42	-	60.00	50.00	-15.58	-

- REMARKS:**
1. Q.P. and AV. are abbreviations of quasi-peak and average individually.
 2. "-": The Quasi-peak reading value also meets average limit and measurement with the average detector is unnecessary.
 3. The emission levels of other frequencies were very low against the limit.
 4. Margin value = Emission level - Limit value
 5. Correction factor = Insertion loss + Cable loss
 6. Emission Level = Correction Factor + Reading Value.

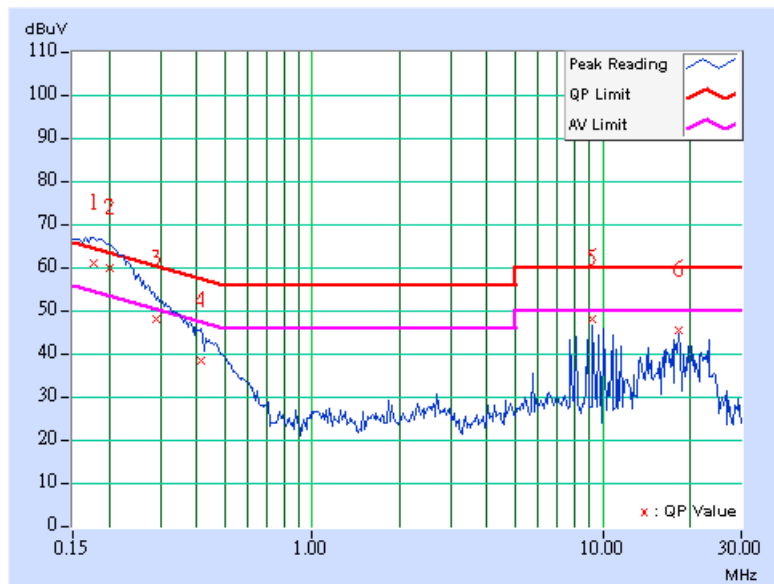

4.2 RADIATED EMISSION MEASUREMENT

4.2.1 LIMITS OF RADIATED EMISSION MEASUREMENT

Emissions radiated outside of the specified bands, shall be according to the general radiated limits in 15.209 as following:

Frequencies (MHz)	Field strength (microvolts/meter)	Measurement distance (meters)
0.009-0.490	2400/F(kHz)	300
0.490-1.705	24000/F(kHz)	30
1.705-30.0	30	30
30-88	100	3
88-216	150	3
216-960	200	3
Above 960	500	3

NOTE:

1. The lower limit shall apply at the transition frequencies.
2. Emission level (dBuV/m) = 20 log Emission level (uV/m).
3. As shown in 15.35(b), for frequencies above 1000MHz, the field strength limits are based on average detector, however, the peak field strength of any emission shall not exceed the maximum permitted average limits, specified above by more than 20dB under any condition of modulation.



4.2.2 TEST INSTRUMENTS

DESCRIPTION & MANUFACTURER	MODEL NO.	SERIAL NO.	CALIBRATED UNTIL
Agilent Spectrum Analyzer	E4446A	MY46180622	Apr. 17, 2009
HP Pre_Amplifier	8449B	3008A01922	Oct. 04, 2008
ROHDE & SCHWARZ Test Receiver	ESCS30	100375	Mar. 31, 2009
SCHWARZBECK TRILOG Broadband Antenna	VULB 9168	138	April 29, 2009
Schwarzbeck Horn_Antenna	BBHA9120	D124	Dec. 16, 2008
Schwarzbeck Horn_Antenna	BBHA 9170	BBHA9170153	Jan. 27, 2009
RF Switches (ARNITSU)	CS-201	1565157	Aug. 14, 2008
RF CABLE	SF102	22054-2	Dec. 06. 2008
RF Cable	8DFB	STCCAB-30M-1 GHz	Oct. 09, 2008
Software	ADT_Radiated_V 7.6.15.8	NA	NA
CHANCE MOST Antenna Tower	AT-100	0203	NA
CHANCE MOST Turn Table	TT-100	0203	NA

- Note: 1. The calibration interval of the above test instruments is 12 months and the calibrations are traceable to NML/ROC and NIST/USA.
2. The horn antenna, HP preamplifier (model: 8449B) and Spectrum Analyzer (model: R3271A) are used only for the measurement of emission frequency above 1GHz if tested.
3. The test was performed in ADT Open Site No. C.
4. The FCC Site Registration No. is 656396.
5. The VCCI Site Registration No. is R-1626.
6. The CANADA Site Registration No. is IC 3789C-3.

4.2.3 TEST PROCEDURES

- a. The EUT was placed on the top of a rotating table 0.8 meters above the ground at a 10-meter open field site. The table was rotated 360 degrees to determine the position of the highest radiation.
- b. The EUT was set 3 meters away from the interference-receiving antenna, which was mounted on the top of a variable-height antenna tower.
- c. The antenna is a broadband antenna, and its height is varied from one meter to four meters above the ground to determine the maximum value of the field strength. Both horizontal and vertical polarizations of the antenna are set to make the measurement.
- d. For each suspected emission, the EUT was arranged to its worst case and then the antenna was tuned to heights from 1 meter to 4 meters and the rotatable table was turned from 0 degrees to 360 degrees to find the maximum reading.
- e. The test-receiver system was set to Peak Detect Function and Specified Bandwidth with Maximum Hold Mode.
- f. If the emission level of the EUT in peak mode was 10 dB lower than the limit specified, then testing could be stopped and the peak values of the EUT would be reported. Otherwise the emissions that did not have 10 dB margin would be re-tested one by one using the quasi-peak method or average method as specified and then reported in Data sheet peak mode and QP mode.

NOTE:

1. The resolution bandwidth and video bandwidth of test receiver/spectrum analyzer is 120kHz for Peak detection (PK) and Quasi-peak detection (QP) at frequency below 1GHz.
2. The resolution bandwidth of test receiver/spectrum analyzer is 1 MHz and the video bandwidth is 3 MHz for Peak detection (PK) at frequency above 1GHz.
3. The resolution bandwidth of test receiver/spectrum analyzer is 1 MHz and the video bandwidth is 10 Hz for Average detection (AV) at frequency above 1GHz.

4.2.4 DEVIATION FROM TEST STANDARD

No deviation

4.2.5 TEST SETUP

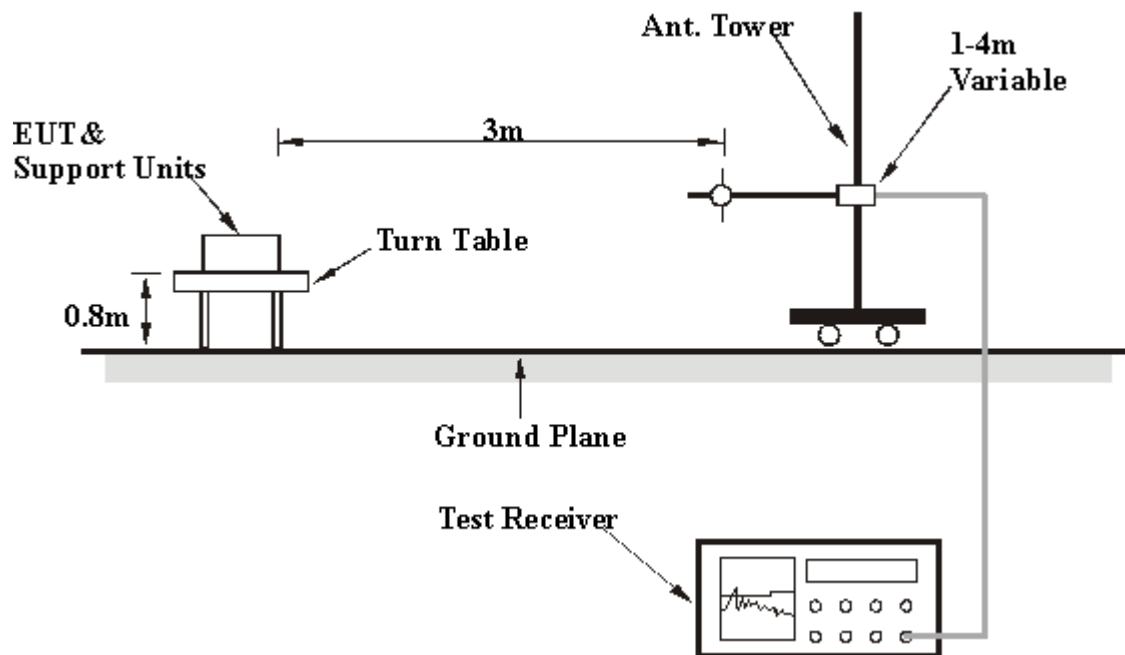

For the actual test configuration, please refer to the related item – Photographs of the Test Configuration.

4.2.6 EUT OPERATING CONDITIONS

1. Placed the EUT on testing table.
2. Prepared other computer systems (support units 1 ~ 2) to act as communication partners and placed them outside of testing area.
3. The communication partners run test program "MP A/B/G TEST" to enable EUT under transmission/receiving condition continuously via UTP cables.

4.2.7 TEST RESULTS

BELOW 1GHz WORST-CASE DATA : 802.11b DBPSK MODULATION

EUT TEST CONDITION		MEASUREMENT DETAIL	
CHANNEL	Channel 1	FREQUENCY RANGE	Below 1000MHz
INPUT POWER (SYSTEM)	120Vac, 60 Hz	DETECTOR FUNCTION	Quasi-Peak
ENVIRONMENTAL CONDITIONS	28deg. C, 70%RH 955hPa	TESTED BY	Phoenix Huang

ANTENNA POLARITY & TEST DISTANCE: HORIZONTAL AT 3 M								
NO.	FREQ. (MHz)	EMISSION LEVEL (dBuV/m)	LIMIT (dBuV/m)	MARGIN (dB)	ANTENNA HEIGHT (m)	TABLE ANGLE (Degree)	RAW VALUE (dBuV)	CORRECTION FACTOR (dB/m)
1	125.00	28.41 QP	43.50	-15.09	1.53 H	302	14.96	13.46
2	175.00	30.24 QP	43.50	-13.26	1.59 H	309	16.42	13.82
3	200.00	32.81 QP	43.50	-10.69	1.00 H	82	20.64	12.17
4	250.00	42.54 QP	46.00	-3.46	1.00 H	314	28.04	14.50
5	324.99	37.71 QP	46.00	-8.29	1.01 H	74	20.53	17.18
6	400.00	28.81 QP	46.00	-17.19	1.00 H	194	8.68	20.13
7	499.99	38.92 QP	46.00	-7.08	1.54 H	310	17.61	21.31
8	600.00	30.05 QP	46.00	-15.95	1.30 H	165	6.75	23.30
9	800.00	34.68 QP	46.00	-11.32	1.00 H	339	6.23	28.45
10	874.95	33.36 QP	46.00	-12.64	1.00 H	207	4.09	29.27
11	899.95	33.44 QP	46.00	-12.56	1.00 H	198	3.88	29.56
ANTENNA POLARITY & TEST DISTANCE: VERTICAL AT 3 M								
NO.	FREQ. (MHz)	EMISSION LEVEL (dBuV/m)	LIMIT (dBuV/m)	MARGIN (dB)	ANTENNA HEIGHT (m)	TABLE ANGLE (Degree)	RAW VALUE (dBuV)	CORRECTION FACTOR (dB/m)
1	53.84	35.28 QP	40.00	-4.72	1.00 V	181	21.63	13.65
2	74.57	31.13 QP	40.00	-8.87	1.00 V	11	19.34	11.79
3	124.99	28.41 QP	43.50	-15.09	1.00 V	215	14.96	13.45
4	174.99	31.26 QP	43.50	-12.24	1.00 V	323	17.44	13.82
5	187.50	32.49 QP	43.50	-11.01	1.00 V	309	19.31	13.18
6	199.99	33.91 QP	43.50	-9.59	1.00 V	283	21.74	12.17
7	250.00	42.77 QP	46.00	-3.23	1.65 V	38	28.27	14.50
8	266.98	29.10 QP	46.00	-16.90	1.00 V	114	13.96	15.14
9	325.00	34.15 QP	46.00	-11.85	1.00 V	276	16.97	17.18
10	400.00	32.25 QP	46.00	-13.75	1.00 V	74	12.12	20.13
11	500.03	38.25 QP	46.00	-7.75	1.00 V	72	16.94	21.31
12	875.00	33.77 QP	46.00	-12.23	1.40 V	294	4.50	29.27
13	999.94	35.39 QP	54.00	-18.61	1.02 V	247	4.10	31.29

REMARKS: 1. Emission level (dBuV/m) = Raw Value (dBuV) + Correction Factor (dB/m).

2. Correction Factor (dB/m) = Antenna Factor (dB/m) + Cable Factor (dB).

3. The other emission levels were very low against the limit.

4. Margin value = Emission level – Limit value.

802.11b DSSS MODULATION

EUT TEST CONDITION		MEASUREMENT DETAIL	
CHANNEL	Channel 1	FREQUENCY RANGE	1 ~ 25GHz
INPUT POWER (SYSTEM)	120Vac, 60 Hz	DETECTOR FUNCTION	Peak (PK) Average (AV)
ENVIRONMENTAL CONDITIONS	26deg. C, 72%RH 955hPa	TESTED BY	Sky Liao

ANTENNA POLARITY & TEST DISTANCE: HORIZONTAL AT 3 M								
NO.	FREQ. (MHz)	EMISSION LEVEL (dBuV/m)	LIMIT (dBuV/m)	MARGIN (dB)	ANTENNA HEIGHT (m)	TABLE ANGLE (Degree)	RAW VALUE (dBuV)	CORRECTION FACTOR (dB/m)
1	2386.00	57.48 PK	74.00	-16.52	1.00 H	98	27.18	30.30
2	2386.00	44.18 AV	54.00	-9.82	1.00 H	98	13.88	30.30
3	2412.00	101.18 PK			1.00 H	78	70.77	30.41
4	2412.00	96.24 AV			1.00 H	78	65.83	30.41
5	4824.00	46.10 PK	74.00	-27.90	1.05 H	348	10.31	35.79
6	4824.00	33.80 AV	54.00	-20.20	1.05 H	348	-1.99	35.79
7	7236.00	52.00 PK	74.00	-22.00	1.08 H	322	10.40	41.60
8	7236.00	38.30 AV	54.00	-15.70	1.08 H	322	-3.30	41.60
ANTENNA POLARITY & TEST DISTANCE: VERTICAL AT 3 M								
NO.	FREQ. (MHz)	EMISSION LEVEL (dBuV/m)	LIMIT (dBuV/m)	MARGIN (dB)	ANTENNA HEIGHT (m)	TABLE ANGLE (Degree)	RAW VALUE (dBuV)	CORRECTION FACTOR (dB/m)
1	2386.00	62.01 PK	74.00	-11.99	1.02 V	330	31.71	30.30
2	2386.00	50.84 AV	54.00	-3.16	1.02 V	330	20.54	30.30
3	*2412.00	114.20 PK			1.00 V	24	83.79	30.41
4	*2412.00	109.70 AV			1.00 V	24	79.29	30.41
5	4824.00	49.40 PK	74.00	-24.60	1.35 V	175	13.61	35.79
6	4824.00	43.30 AV	54.00	-10.70	1.35 V	175	7.51	35.79
7	7236.00	56.40 PK	74.00	-17.60	1.10 V	258	14.80	41.60
8	7236.00	46.40 AV	54.00	-7.60	1.10 V	258	4.80	41.60

- REMARKS:**
1. Emission level (dBuV/m) = Raw Value (dBuV) + Correction Factor (dB/m).
 2. Correction Factor (dB/m) = Antenna Factor (dB/m) + Cable Factor (dB).
 3. The other emission levels were very low against the limit.
 4. Margin value = Emission level – Limit value.
 5. “ * “: Fundamental frequency.



EUT TEST CONDITION		MEASUREMENT DETAIL	
CHANNEL	Channel 6	FREQUENCY RANGE	1 ~ 25GHz
INPUT POWER (SYSTEM)	120Vac, 60 Hz	DETECTOR FUNCTION	Peak (PK) Average (AV)
ENVIRONMENTAL CONDITIONS	26deg. C, 72%RH 955hPa	TESTED BY	Sky Liao

ANTENNA POLARITY & TEST DISTANCE: HORIZONTAL AT 3 M								
NO.	FREQ. (MHz)	EMISSION LEVEL (dBuV/m)	LIMIT (dBuV/m)	MARGIN (dB)	ANTENNA HEIGHT (m)	TABLE ANGLE (Degree)	RAW VALUE (dBuV)	CORRECTION FACTOR (dB/m)
1	*2437.00	102.20 PK			1.02 H	80	71.68	30.52
2	*2437.00	96.80 AV			1.02 H	80	66.28	30.52
3	4874.00	46.40 PK	74.00	-27.60	1.06 H	353	10.48	35.92
4	4874.00	34.10 AV	54.00	-19.90	1.06 H	353	-1.82	35.92
5	7311.00	51.90 PK	74.00	-22.10	1.10 H	315	10.09	41.81
6	7311.00	38.10 AV	54.00	-15.90	1.10 H	315	-3.71	41.81
ANTENNA POLARITY & TEST DISTANCE: VERTICAL AT 3 M								
NO.	FREQ. (MHz)	EMISSION LEVEL (dBuV/m)	LIMIT (dBuV/m)	MARGIN (dB)	ANTENNA HEIGHT (m)	TABLE ANGLE (Degree)	RAW VALUE (dBuV)	CORRECTION FACTOR (dB/m)
1	*2437.00	116.00 PK			1.00 V	24	85.48	30.52
2	*2437.00	110.80 AV			1.00 V	24	80.28	30.52
3	4874.00	50.20 PK	74.00	-23.80	1.33 V	186	14.28	35.92
4	4874.00	44.00 AV	54.00	-10.00	1.33 V	186	8.08	35.92
5	7311.00	53.50 PK	74.00	-20.50	1.08 V	250	11.69	41.81
6	7311.00	40.90 AV	54.00	-13.10	1.08 V	250	-0.91	41.81

- REMARKS:**
1. Emission level (dBuV/m) = Raw Value (dBuV) + Correction Factor (dB/m).
 2. Correction Factor (dB/m) = Antenna Factor (dB/m) + Cable Factor (dB).
 3. The other emission levels were very low against the limit.
 4. Margin value = Emission level – Limit value.
 5. “ * “: Fundamental frequency.

EUT TEST CONDITION		MEASUREMENT DETAIL	
CHANNEL	Channel 11	FREQUENCY RANGE	1 ~ 25GHz
INPUT POWER (SYSTEM)	120Vac, 60 Hz	DETECTOR FUNCTION	Peak (PK) Average (AV)
ENVIRONMENTAL CONDITIONS	26deg. C, 72%RH 955hPa	TESTED BY	Sky Liao

ANTENNA POLARITY & TEST DISTANCE: HORIZONTAL AT 3 M								
NO.	FREQ. (MHz)	EMISSION LEVEL (dBuV/m)	LIMIT (dBuV/m)	MARGIN (dB)	ANTENNA HEIGHT (m)	TABLE ANGLE (Degree)	RAW VALUE (dBuV)	CORRECTION FACTOR (dB/m)
1	*2462.00	101.30 PK			1.04 H	98	70.67	30.63
2	*2462.00	96.40 AV			1.04 H	98	65.77	30.63
3	2483.50	56.51 PK	74.00	-17.49	1.03 H	98	25.79	30.72
4	2483.50	43.81 AV	54.00	-10.19	1.03 H	98	13.09	30.72
5	4924.00	46.60 PK	74.00	-27.40	1.03 H	350	10.54	36.06
6	4924.00	34.20 AV	54.00	-19.80	1.03 H	350	-1.86	36.06
7	7386.00	52.20 PK	74.00	-21.80	1.07 H	328	10.19	42.01
8	7386.00	38.20 AV	54.00	-15.80	1.07 H	328	-3.81	42.01
ANTENNA POLARITY & TEST DISTANCE: VERTICAL AT 3 M								
NO.	FREQ. (MHz)	EMISSION LEVEL (dBuV/m)	LIMIT (dBuV/m)	MARGIN (dB)	ANTENNA HEIGHT (m)	TABLE ANGLE (Degree)	RAW VALUE (dBuV)	CORRECTION FACTOR (dB/m)
1	*2462.00	115.20 PK			1.26 V	202	84.57	30.63
2	*2462.00	110.40 AV			1.26 V	202	79.77	30.63
3	2487.19	62.24 PK	74.00	-11.76	1.00 V	268	31.51	30.73
4	2487.19	52.78 AV	54.00	-1.22	1.00 V	268	22.05	30.73
5	4924.00	49.70 PK	74.00	-24.30	1.45 V	152	13.64	36.06
6	4924.00	43.50 AV	54.00	-10.50	1.45 V	152	7.44	36.06
7	7386.00	52.80 PK	74.00	-21.20	1.08 V	260	10.79	42.01
8	7386.00	39.50 AV	54.00	-14.50	1.08 V	260	-2.51	42.01

- REMARKS:**
1. Emission level (dBuV/m) = Raw Value (dBuV) + Correction Factor (dB/m).
 2. Correction Factor (dB/m) = Antenna Factor (dB/m) + Cable Factor (dB).
 3. The other emission levels were very low against the limit.
 4. Margin value = Emission level – Limit value.
 5. “ * “: Fundamental frequency.

RESTRICTED BANDEDGE (802.11b MODE, CH1, VERTICAL)

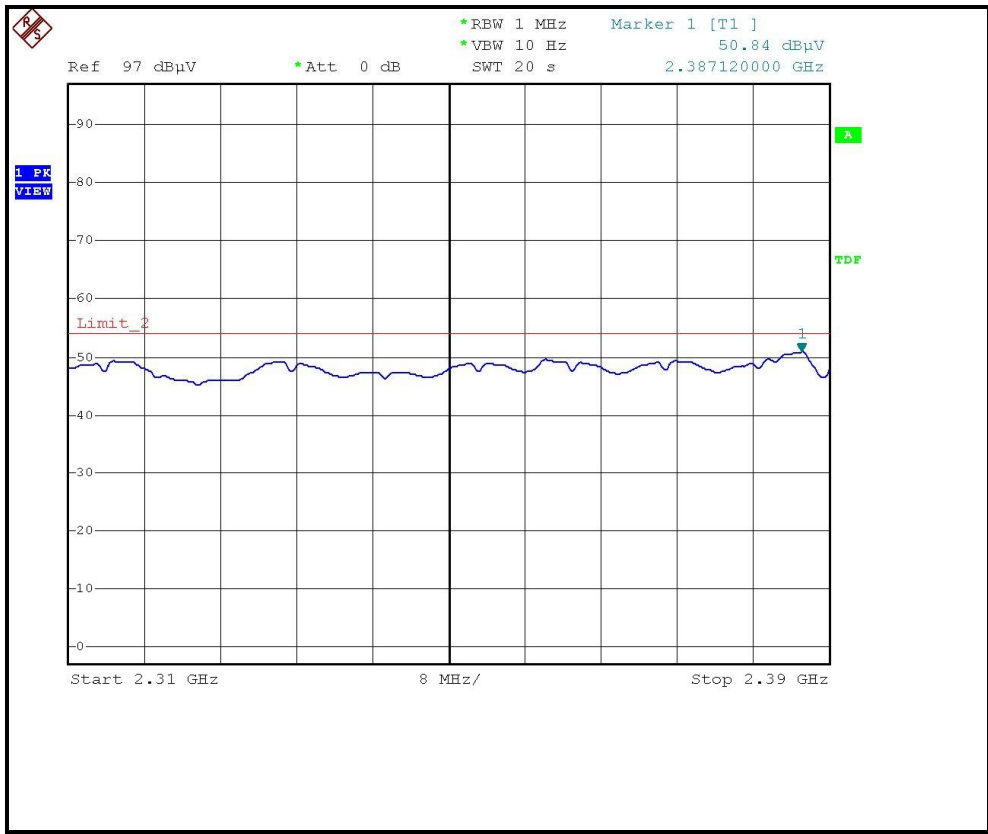
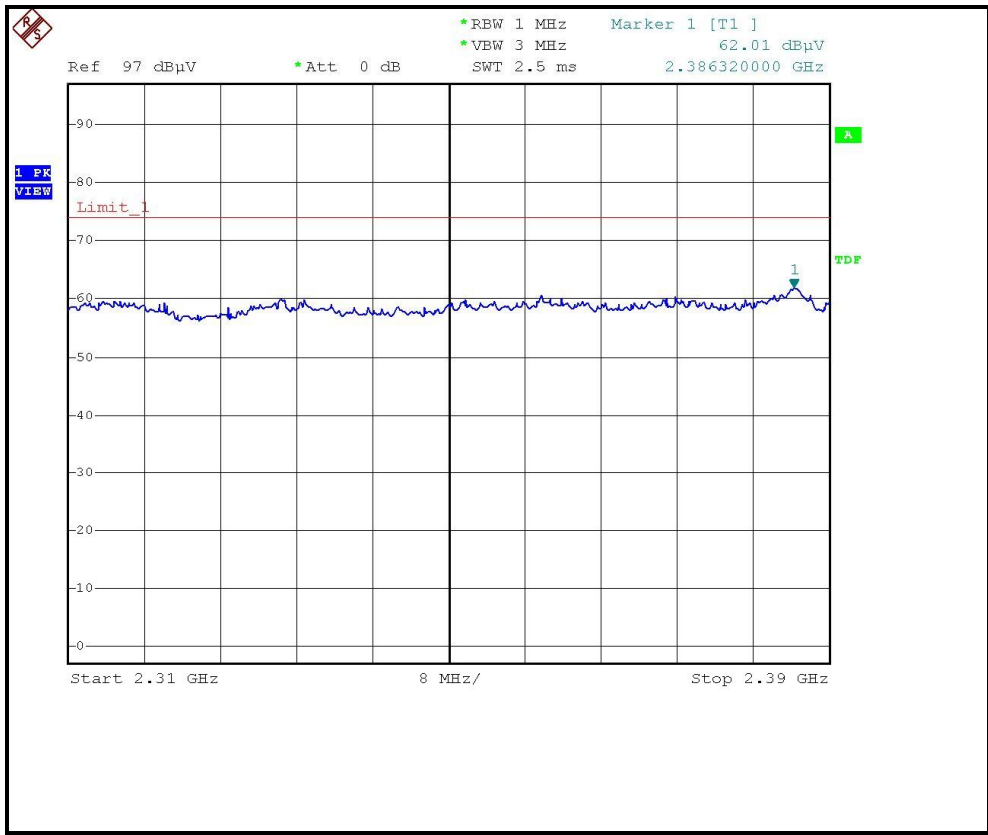



RESTRICTED BANDEDGE (802.11b MODE, CH11, HORIZONTAL)

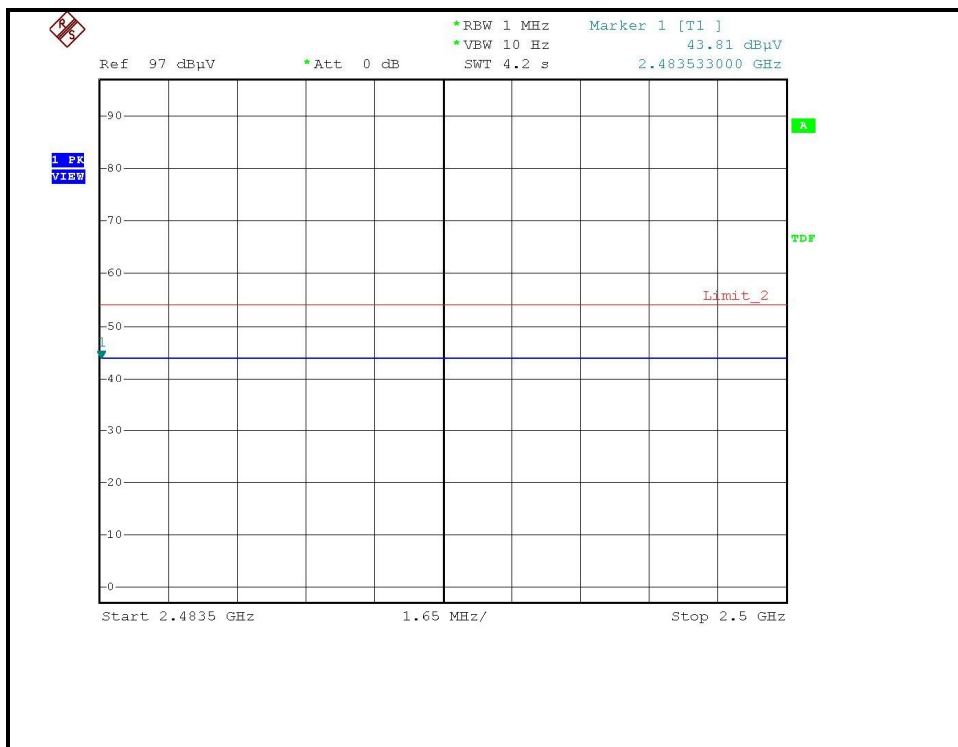
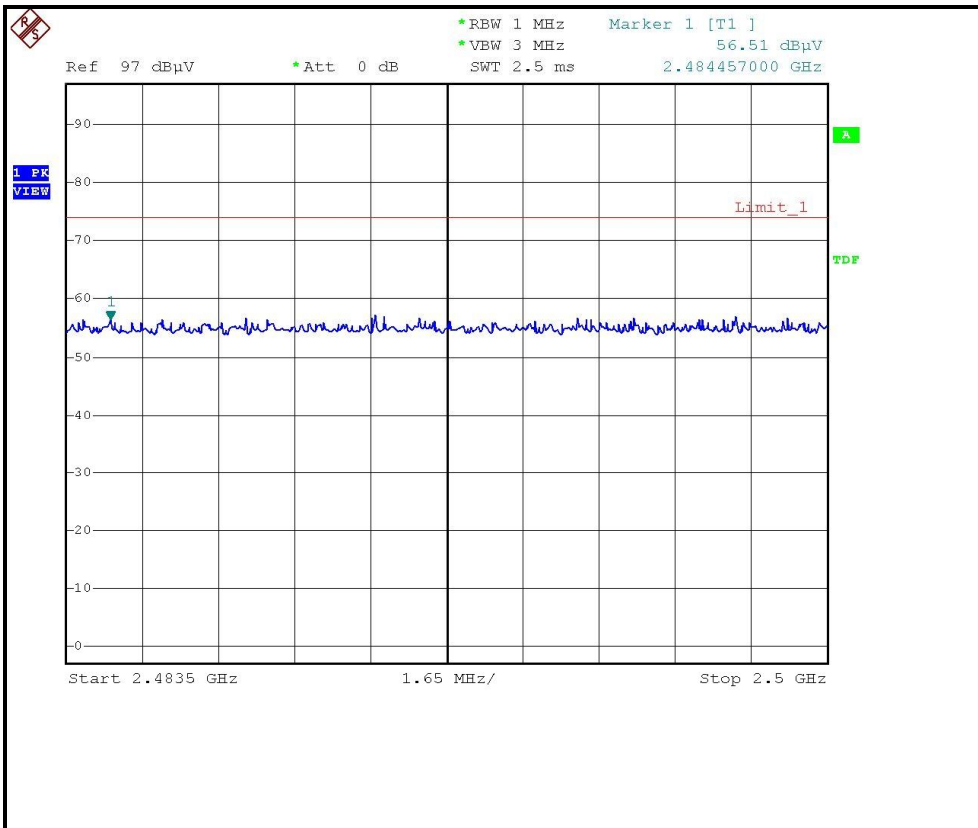



RESTRICTED BANDEDGE (802.11b MODE, CH11, VERTICAL)

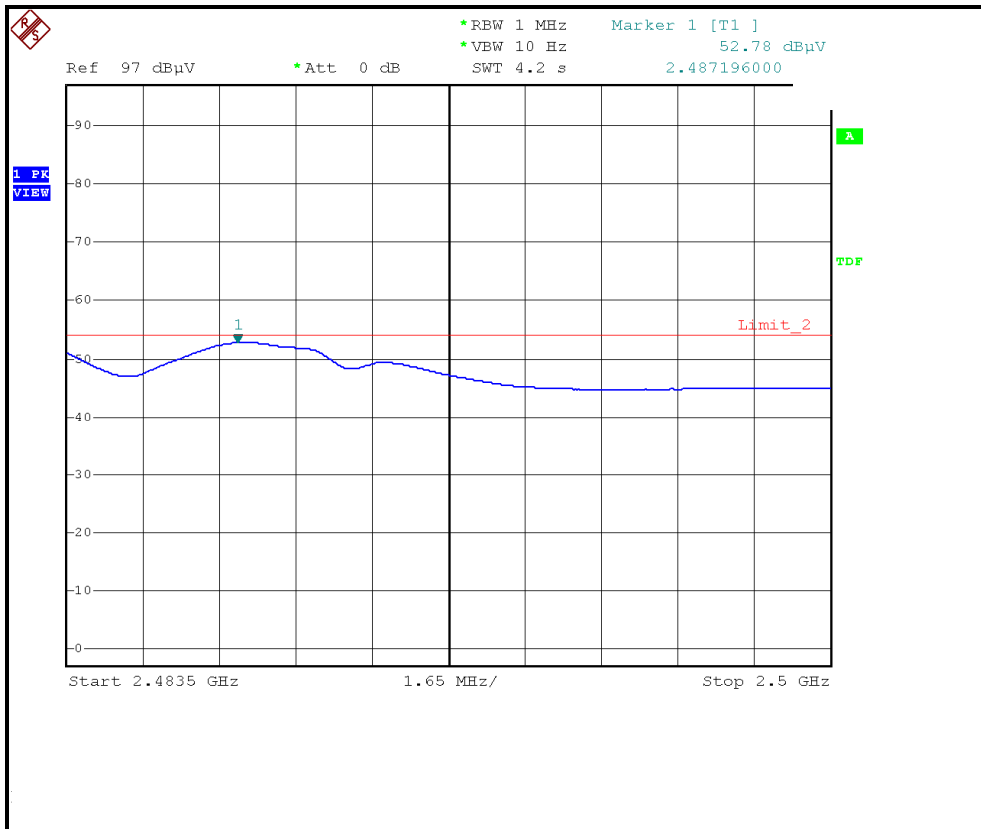
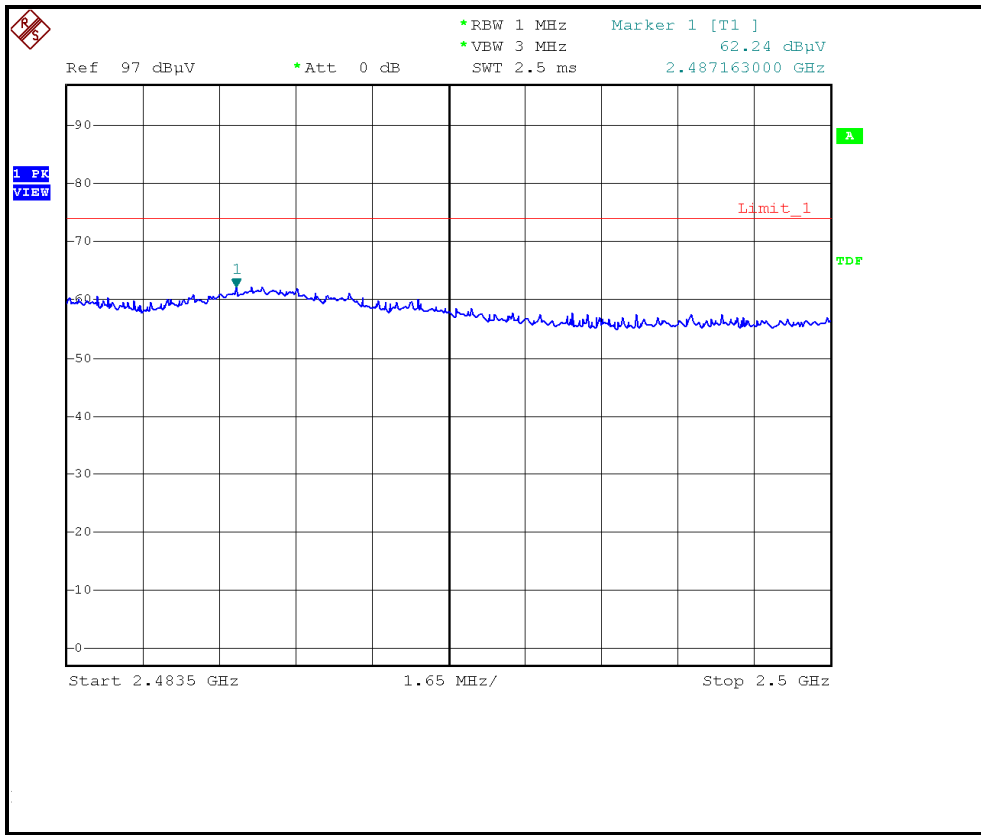



802.11g OFDM MODULATION

EUT TEST CONDITION		MEASUREMENT DETAIL	
CHANNEL	Channel 1	FREQUENCY RANGE	1 ~ 25GHz
INPUT POWER (SYSTEM)	120Vac, 60 Hz	DETECTOR FUNCTION	Peak (PK) Average (AV)
ENVIRONMENTAL CONDITIONS	26deg. C, 72%RH 955hPa	TESTED BY	Sky Liao

ANTENNA POLARITY & TEST DISTANCE: HORIZONTAL AT 3 M								
NO.	FREQ. (MHz)	EMISSION LEVEL (dBuV/m)	LIMIT (dBuV/m)	MARGIN (dB)	ANTENNA HEIGHT (m)	TABLE ANGLE (Degree)	RAW VALUE (dBuV)	CORRECTION FACTOR (dB/m)
1	2390.00	59.95 PK	74.00	-14.05	1.25 H	238	29.63	30.32
2	2390.00	45.20 AV	54.00	-8.80	1.25 H	238	14.88	30.32
3	*2412.00	102.20 PK			1.25 H	238	71.79	30.41
4	*2412.00	91.40 AV			1.25 H	238	60.99	30.41
5	4824.00	46.20 PK	74.00	-27.80	1.08 H	340	10.41	35.79
6	4824.00	32.20 AV	54.00	-21.80	1.08 H	340	-3.59	35.79
7	7236.00	52.40 PK	74.00	-21.60	1.08 H	320	10.80	41.60
8	7236.00	38.30 AV	54.00	-15.70	1.08 H	320	-3.30	41.60
ANTENNA POLARITY & TEST DISTANCE: VERTICAL AT 3 M								
NO.	FREQ. (MHz)	EMISSION LEVEL (dBuV/m)	LIMIT (dBuV/m)	MARGIN (dB)	ANTENNA HEIGHT (m)	TABLE ANGLE (Degree)	RAW VALUE (dBuV)	CORRECTION FACTOR (dB/m)
1	2390.00	70.80 PK	74.00	-3.20	1.74 V	80	40.48	30.32
2	2390.00	52.60 AV	54.00	-1.40	1.74 V	80	22.28	30.32
3	*2412.00	112.50 PK			1.04 V	24	82.09	30.41
4	*2412.00	101.60 AV			1.04 V	24	71.19	30.41
5	4824.00	48.20 PK	74.00	-25.80	1.48 V	174	12.41	35.79
6	4824.00	36.80 AV	54.00	-17.20	1.48 V	174	1.01	35.79
7	7236.00	61.80 PK	74.00	-12.20	1.10 V	284	20.20	41.60
8	7236.00	40.40 AV	54.00	-13.60	1.10 V	284	-1.20	41.60

- REMARKS:**
1. Emission level (dBuV/m) = Raw Value (dBuV) + Correction Factor (dB/m).
 2. Correction Factor (dB/m) = Antenna Factor (dB/m) + Cable Factor (dB).
 3. The other emission levels were very low against the limit.
 4. Margin value = Emission level – Limit value.
 5. “ * “: Fundamental frequency.

EUT TEST CONDITION		MEASUREMENT DETAIL	
CHANNEL	Channel 6	FREQUENCY RANGE	1 ~ 25GHz
INPUT POWER (SYSTEM)	120Vac, 60 Hz	DETECTOR FUNCTION	Peak (PK) Average (AV)
ENVIRONMENTAL CONDITIONS	26deg. C, 72%RH 955hPa	TESTED BY	Sky Liao

ANTENNA POLARITY & TEST DISTANCE: HORIZONTAL AT 3 M								
NO.	FREQ. (MHz)	EMISSION LEVEL (dBuV/m)	LIMIT (dBuV/m)	MARGIN (dB)	ANTENNA HEIGHT (m)	TABLE ANGLE (Degree)	RAW VALUE (dBuV)	CORRECTION FACTOR (dB/m)
1	2360.00	55.97 PK	74.00	-18.03	1.33 H	84	25.78	30.19
2	2360.00	46.32 AV	54.00	-7.68	1.33 H	84	16.13	30.19
3	*2437.00	104.86 PK			1.58 H	49	74.34	30.52
4	*2437.00	94.18 AV			1.58 H	49	63.66	30.52
5	4784.00	49.78 PK	74.00	-24.22	1.13 H	252	14.10	35.68
6	4784.00	34.26 AV	54.00	-19.74	1.13 H	252	-1.42	35.68
7	7311.00	59.88 PK	74.00	-14.12	1.37 H	148	18.07	41.81
8	7311.00	44.70 AV	54.00	-9.30	1.37 H	148	2.89	41.81
ANTENNA POLARITY & TEST DISTANCE: VERTICAL AT 3 M								
NO.	FREQ. (MHz)	EMISSION LEVEL (dBuV/m)	LIMIT (dBuV/m)	MARGIN (dB)	ANTENNA HEIGHT (m)	TABLE ANGLE (Degree)	RAW VALUE (dBuV)	CORRECTION FACTOR (dB/m)
1	2360.00	61.55 PK	74.00	-12.45	1.00 V	13	31.36	30.19
2	2360.00	53.04 AV	54.00	-0.96	1.00 V	13	22.85	30.19
3	*2437.00	116.04 PK			1.00 V	268	85.52	30.52
4	*2437.00	105.88 AV			1.00 V	268	75.36	30.52
5	4874.00	56.55 PK	74.00	-17.45	1.15 V	0	20.63	35.92
6	4874.00	40.00 AV	54.00	-14.00	1.15 V	0	4.08	35.92
7	7311.00	73.04 PK	74.00	-0.96	1.13 V	247	31.23	41.81
8	7311.00	51.30 AV	54.00	-2.70	1.13 V	247	9.49	41.81

- REMARKS:**
1. Emission level (dBuV/m) = Raw Value (dBuV) + Correction Factor (dB/m).
 2. Correction Factor (dB/m) = Antenna Factor (dB/m) + Cable Factor (dB).
 3. The other emission levels were very low against the limit.
 4. Margin value = Emission level – Limit value.
 5. “ * “: Fundamental frequency.



EUT TEST CONDITION		MEASUREMENT DETAIL	
CHANNEL	Channel 11	FREQUENCY RANGE	1 ~ 25GHz
INPUT POWER (SYSTEM)	120Vac, 60 Hz	DETECTOR FUNCTION	Peak (PK) Average (AV)
ENVIRONMENTAL CONDITIONS	26deg. C, 72%RH 955hPa	TESTED BY	Sky Liao

ANTENNA POLARITY & TEST DISTANCE: HORIZONTAL AT 3 M								
NO.	FREQ. (MHz)	EMISSION LEVEL (dBuV/m)	LIMIT (dBuV/m)	MARGIN (dB)	ANTENNA HEIGHT (m)	TABLE ANGLE (Degree)	RAW VALUE (dBuV)	CORRECTION FACTOR (dB/m)
1	*2462.00	101.40 PK			1.25 H	240	70.77	30.63
2	*2462.00	90.80 AV			1.25 H	240	60.17	30.63
3	2483.50	58.05 PK	74.00	-15.95	1.25 H	240	27.33	30.72
4	2483.50	44.60 AV	54.00	-9.40	1.25 H	240	13.88	30.72
5	4924.00	46.40 PK	74.00	-27.60	1.08 H	343	10.34	36.06
6	4924.00	32.20 AV	54.00	-21.80	1.08 H	343	-3.86	36.06
7	7386.00	52.80 PK	74.00	-21.20	1.05 H	322	10.79	42.01
8	7386.00	38.30 AV	54.00	-15.70	1.05 H	322	-3.71	42.01
ANTENNA POLARITY & TEST DISTANCE: VERTICAL AT 3 M								
NO.	FREQ. (MHz)	EMISSION LEVEL (dBuV/m)	LIMIT (dBuV/m)	MARGIN (dB)	ANTENNA HEIGHT (m)	TABLE ANGLE (Degree)	RAW VALUE (dBuV)	CORRECTION FACTOR (dB/m)
1	2360.00	58.70 PK	74.00	-15.30	1.00 V	25	28.51	30.19
2	2360.00	50.20 AV	54.00	-3.80	1.00 V	25	20.01	30.19
3	*2462.00	110.60 PK			1.44 V	7	79.97	30.63
4	*2462.00	100.20 AV			1.44 V	7	69.57	30.63
5	2483.50	65.35 PK	74.00	-8.65	1.24 V	154	34.63	30.72
6	2483.50	49.58 AV	54.00	-4.42	1.24 V	154	18.86	30.72
7	4924.00	48.80 PK	74.00	-25.20	1.48 V	150	12.74	36.06
8	4924.00	39.20 AV	54.00	-14.80	1.48 V	150	3.14	36.06
9	7386.00	56.80 PK	74.00	-17.20	1.05 V	262	14.79	42.01
10	7386.00	39.40 AV	54.00	-14.60	1.05 V	262	-2.61	42.01

- REMARKS:**
1. Emission level (dBuV/m) = Raw Value (dBuV) + Correction Factor (dB/m).
 2. Correction Factor (dB/m) = Antenna Factor (dB/m) + Cable Factor (dB).
 3. The other emission levels were very low against the limit.
 4. Margin value = Emission level – Limit value.
 5. “ * ”: Fundamental frequency.

RESTRICTED BANDEDGE (802.11g MODE, CH11, VERTICAL)

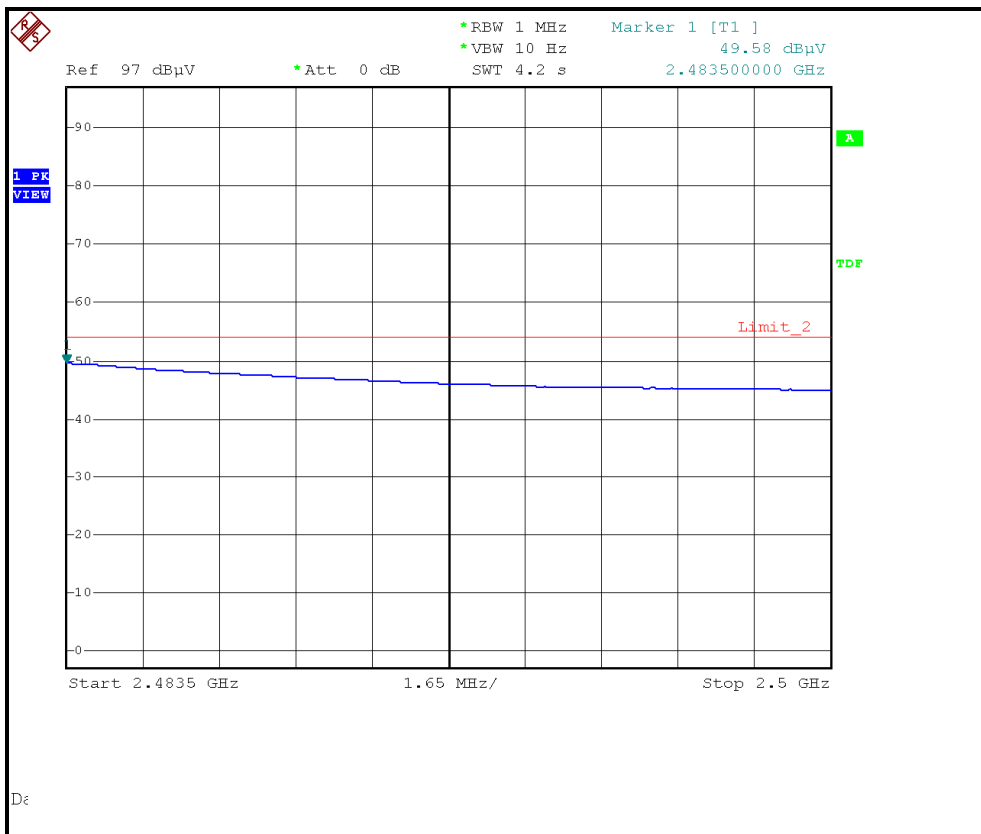
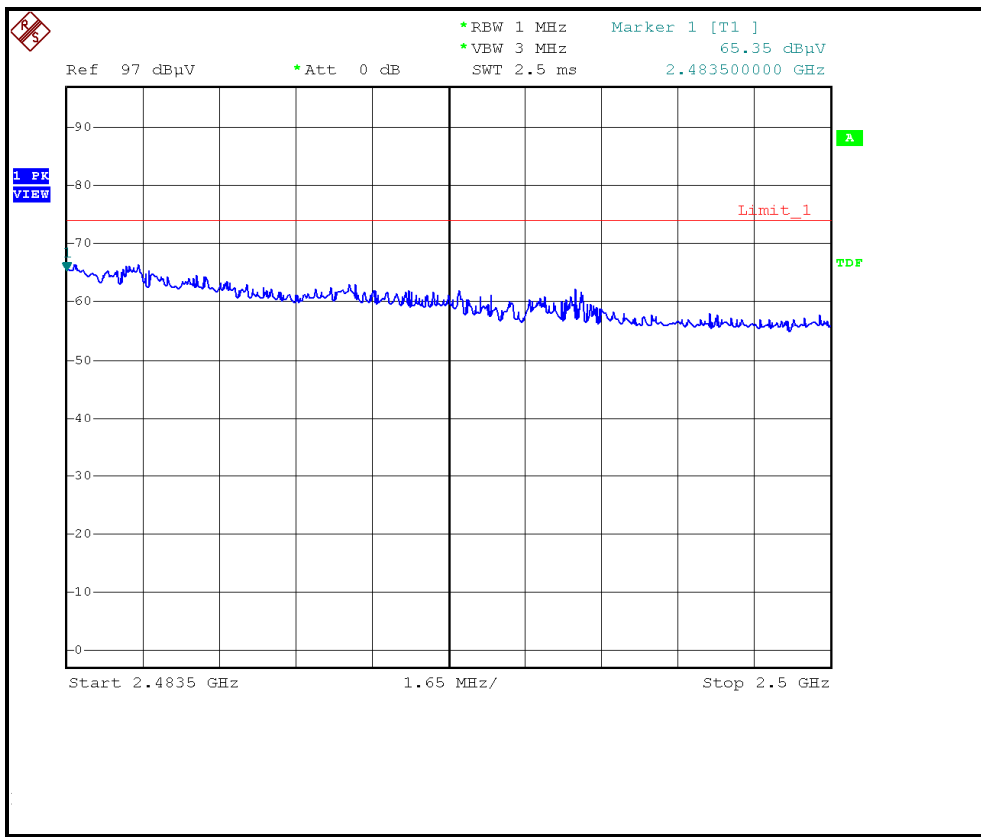



4.3 6DB BANDWIDTH MEASUREMENT

4.3.1 LIMITS OF 6dB BANDWIDTH MEASUREMENT

The minimum of 6dB Bandwidth Measurement is 0.5 MHz.

4.3.2 TEST INSTRUMENTS

Description & Manufacturer	Model No.	Serial No.	Calibrated Until
R&S SPECTRUM ANALYZER	FSP40	100036	Dec. 17, 2008

NOTE:

- 1.The measurement uncertainty is less than +/- 2.6dB, which is calculated as per the NAMAS document NIS81. This uncertainty represents an expanded uncertainty expressed at approximately the 95% confidence level using a coverage factor of k=2.
- 2.The calibration interval of the above test instruments is 12 months and the calibrations are traceable to NML/ROC and NIST/USA.

4.3.3 TEST PROCEDURE

The transmitter output was connected to the spectrum analyzer through an attenuator. The bandwidth of the fundamental frequency was measured by spectrum analyzer with 100kHz RBW and 100kHz VBW. The 6dB bandwidth is defined as the total spectrum the power of which is higher than peak power minus 6dB.

4.3.4 DEVIATION FROM TEST STANDARD

No deviation

4.3.5 TEST SETUP



4.3.6 EUT OPERATING CONDITIONS

The software provided by client to enable the EUT under transmission condition continuously at lowest, middle and highest channel frequencies individually.

4.3.7 TEST RESULTS

802.11b DSSS MODULATION:

MODULATION TYPE	DBPSK	TRANSFER RATE	1Mbps
INPUT POWER	120Vac, 60 Hz	ENVIRONMENTAL CONDITIONS	28deg.C, 62%RH, 972hPa
TESTED BY	Tony Chen		

CHANNEL	CHANNEL FREQUENCY (MHz)	6dB BANDWIDTH (MHz)	MINIMUM LIMIT (MHz)	PASS / FAIL
1	2412	10.10	0.5	PASS
6	2437	10.08	0.5	PASS
11	2462	10.08	0.5	PASS

CH1

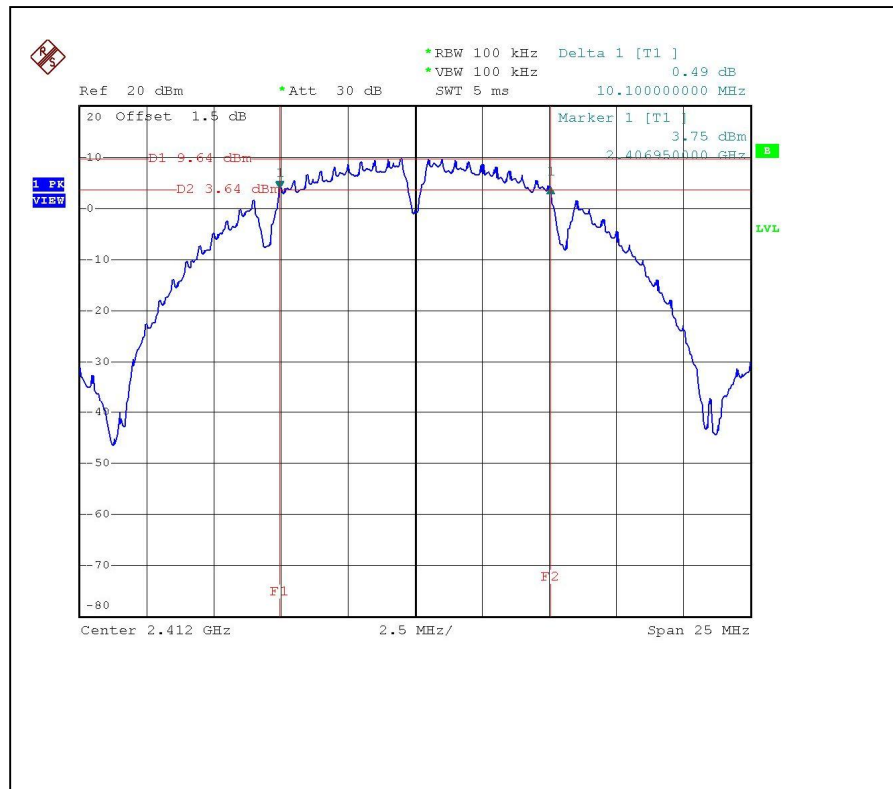

CH6

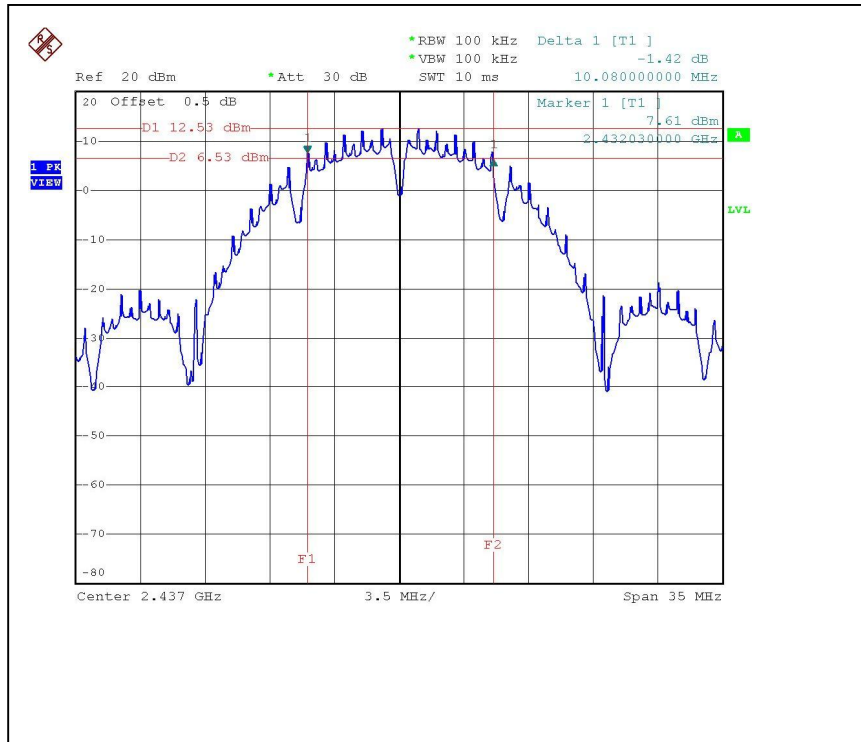

CH11

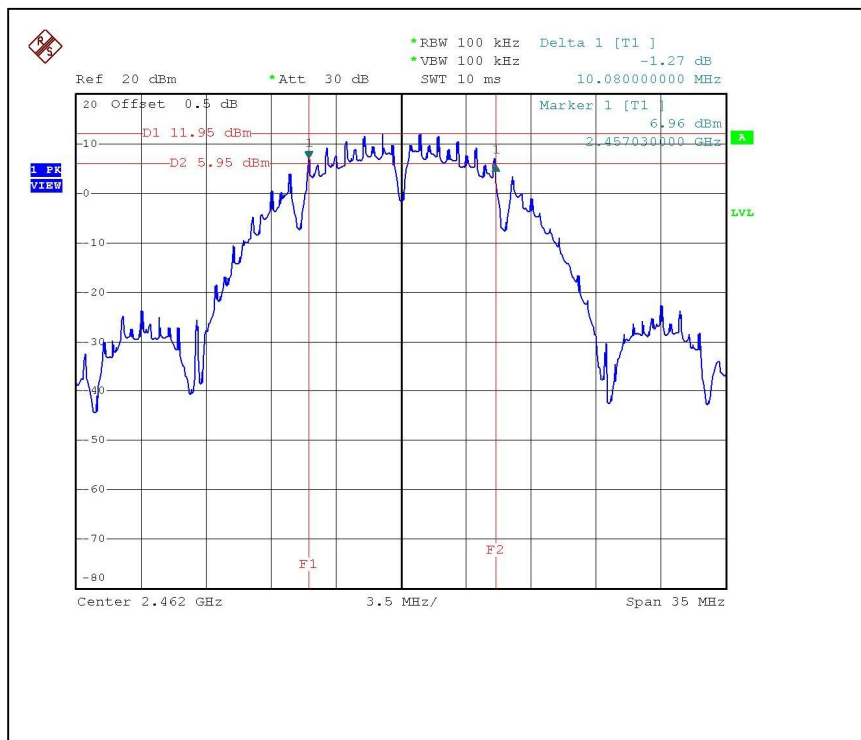

802.11g OFDM MODULATION:

MODULATION TYPE	BPSK	TRANSFER RATE	6Mbps
INPUT POWER	120Vac, 60 Hz	ENVIRONMENTAL CONDITIONS	25deg.C, 60%RH, 972hPa
TESTED BY	Phoenix Huang		

CHANNEL	CHANNEL FREQUENCY (MHz)	6dB BANDWIDTH (MHz)	MINIMUM LIMIT (MHz)	PASS / FAIL
1	2412	15.55	0.5	PASS
6	2437	15.70	0.5	PASS
11	2462	15.65	0.5	PASS

CH1

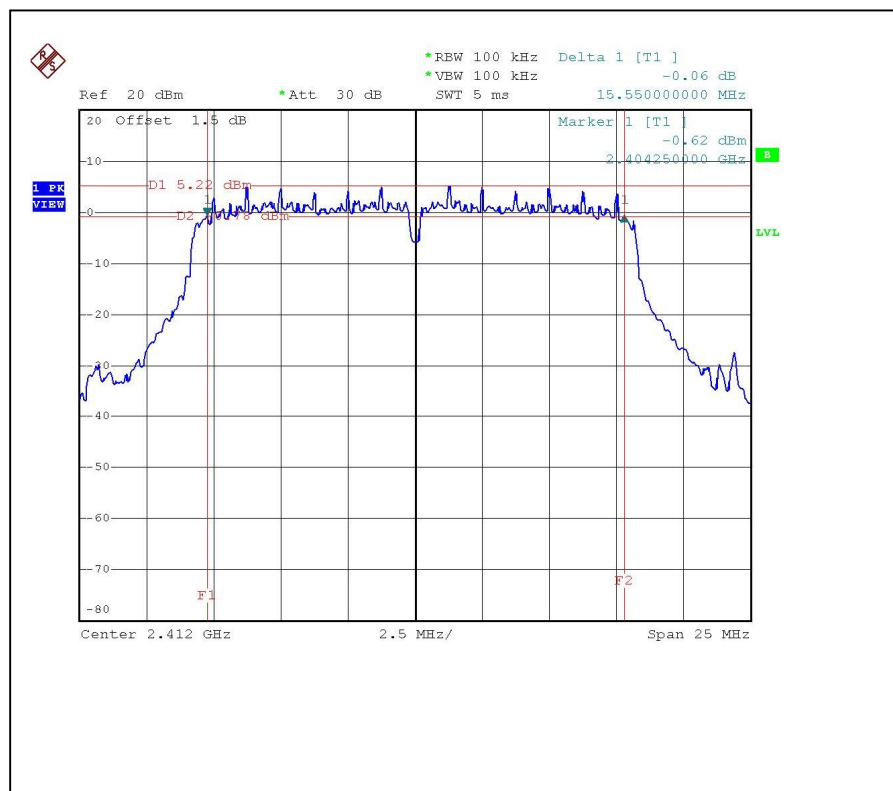

CH6

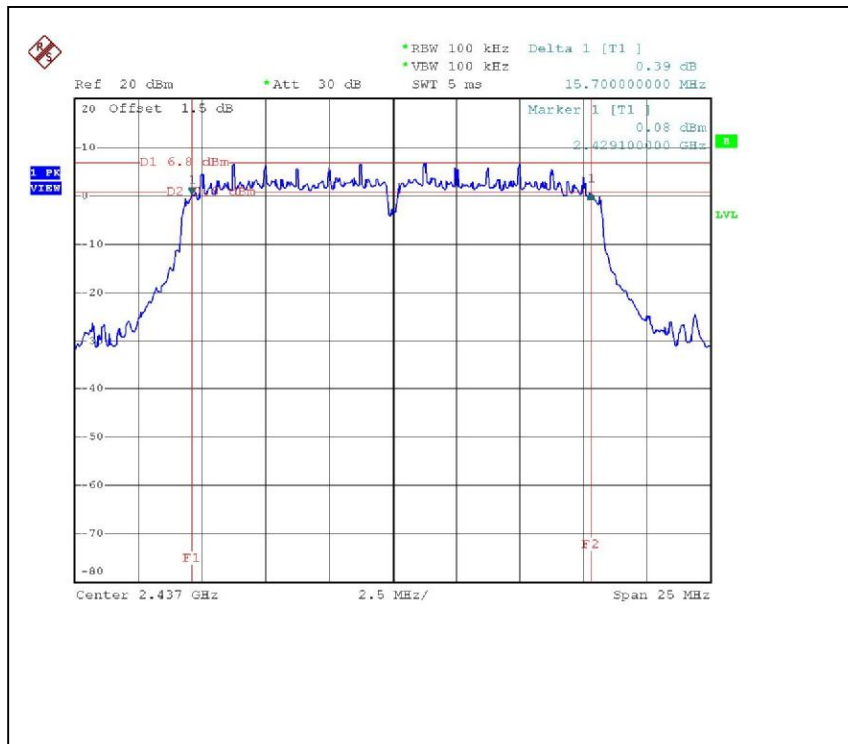

CH11

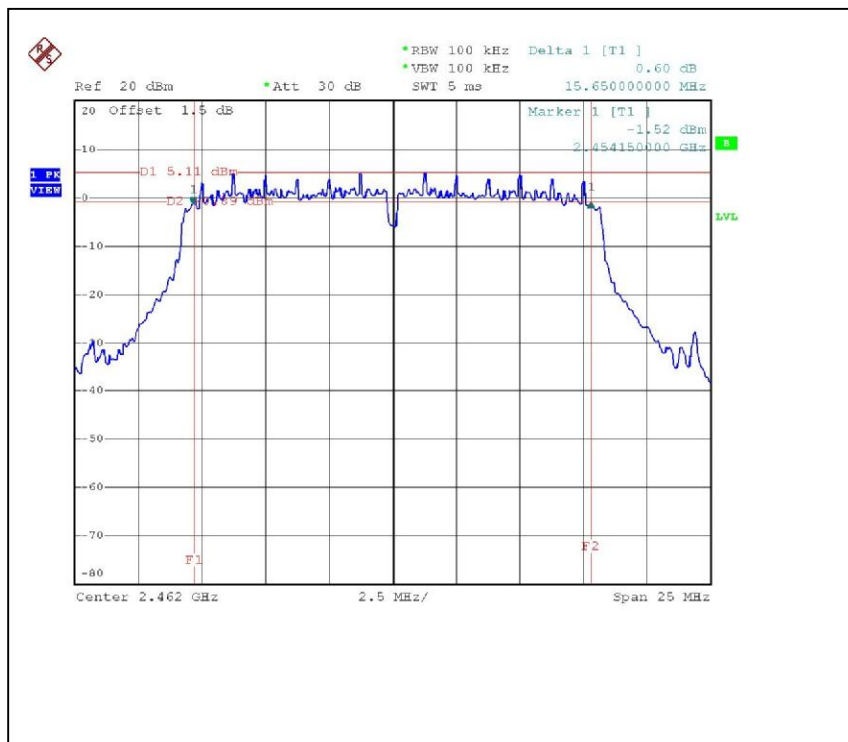



4.4 MAXIMUM PEAK OUTPUT POWER

4.4.1 LIMITS OF MAXIMUM PEAK OUTPUT POWER MEASUREMENT

The Maximum Peak Output Power Measurement is 30dBm.

4.4.2 INSTRUMENTS

Description & Manufacturer	Model No.	Serial No.	Calibrated Until
R&S SPECTRUM ANALYZER	FSP40	100036	Dec. 17, 2008
Agilent SIGNAL GENERATOR	E8257C	MY43320668	Dec. 25, 2008
TEKTRONIX OSCILLOSCOPE	TDS380	B016335	July 15, 2009
NARDA DETECTOR	4503A	FSCM99899	NA

NOTE:

The calibration interval of the above test instruments is 12 months and the calibrations are traceable to NML/ROC and NIST/USA.

4.4.3 TEST PROCEDURES

1. A detector was used on the output port of the EUT. An oscilloscope was used to read the response of the detector.
2. Replaced the EUT by the signal generator. The center frequency of the S.G was adjusted to the center frequency of the measured channel.
3. Adjusted the power to have the same reading on oscilloscope. Record the power level.

4.4.4 DEVIATION FROM TEST STANDARD

No deviation

4.4.5 TEST SETUP



4.4.6 EUT OPERATING CONDITIONS

Same as Item 4.3.6

4.4.7 TEST RESULTS

802.11b DSSS MODULATION:

MODULATION TYPE	DBPSK	TRANSFER RATE	1Mbps
INPUT POWER	120Vac, 60 Hz	ENVIRONMENTAL CONDITIONS	28deg.C, 62%RH, 955hPa
TESTED BY	Moris Lin		

CHANNEL	CHANNEL FREQUENCY (MHz)	PEAK POWER OUTPUT (mW)	PEAK POWER OUTPUT (dBm)	PEAK POWER LIMIT (dBm)	PASS / FAIL
1	2412	104.713	20.20	30	PASS
6	2437	109.648	20.40	30	PASS
11	2462	102.329	20.10	30	PASS

802.11g OFDM MODULATION:

MODULATION TYPE	BPSK	TRANSFER RATE	6Mbps
INPUT POWER	120Vac, 60 Hz	ENVIRONMENTAL CONDITIONS	28deg.C, 62%RH, 955hPa
TESTED BY	Moris Lin		

CHANNEL	CHANNEL FREQUENCY (MHz)	PEAK POWER OUTPUT (mW)	PEAK POWER OUTPUT (dBm)	PEAK POWER LIMIT (dBm)	PASS / FAIL
1	2412	105.682	20.24	30	PASS
6	2437	275.423	24.40	30	PASS
11	2462	114.815	20.60	30	PASS



4.5 POWER SPECTRAL DENSITY MEASUREMENT

4.5.1 LIMITS OF POWER SPECTRAL DENSITY MEASUREMENT

The Maximum of Power Spectral Density Measurement is 8dBm.

4.5.2 TEST INSTRUMENTS

Description & Manufacturer	Model No.	Serial No.	Calibrated Until
R&S SPECTRUM ANALYZER	FSP40	100036	Dec. 17, 2008

NOTE:

- 1.The measurement uncertainty is less than +/- 2.6dB, which is calculated as per the NAMAS document NIS81. This uncertainty represents an expanded uncertainty expressed at approximately the 95% confidence level using a coverage factor of k=2.
- 2.The calibration interval of the above test instruments is 12 months and the calibrations are traceable to NML/ROC and NIST/USA.

4.5.3 TEST PROCEDURE

The transmitter output was connected to the spectrum analyzer through an attenuator, the bandwidth of the fundamental frequency was measured with the spectrum analyzer using 3kHz RBW and 30kHz VBW, set sweep time = span/3kHz. The power spectral density was measured and recorded. The sweep time is allowed to be longer than span/3kHz for a full response of the mixer in the spectrum analyzer.

4.5.4 DEVIATION FROM TEST STANDARD

No deviation

4.5.5 TEST SETUP

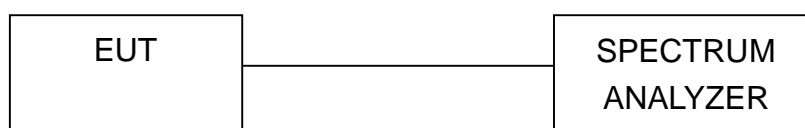

4.5.6 EUT OPERATING CONDITION

Same as Item 4.3.6

4.5.7 TEST RESULTS

802.11b DSSS MODULATION:

MODULATION TYPE	DBPSK	TRANSFER RATE	1Mbps
INPUT POWER	120Vac, 60 Hz	ENVIRONMENTAL CONDITIONS	25deg.C, 60%RH, 955hPa
TESTED BY	Tony Chen		

CHANNEL	CHANNEL FREQUENCY (MHz)	RF POWER LEVEL IN 3kHz BW (dBm)	MAXIMUM LIMIT (dBm)	PASS / FAIL
1	2412	-2.49	8	PASS
6	2437	-1.15	8	PASS
11	2462	-2.73	8	PASS

CH1

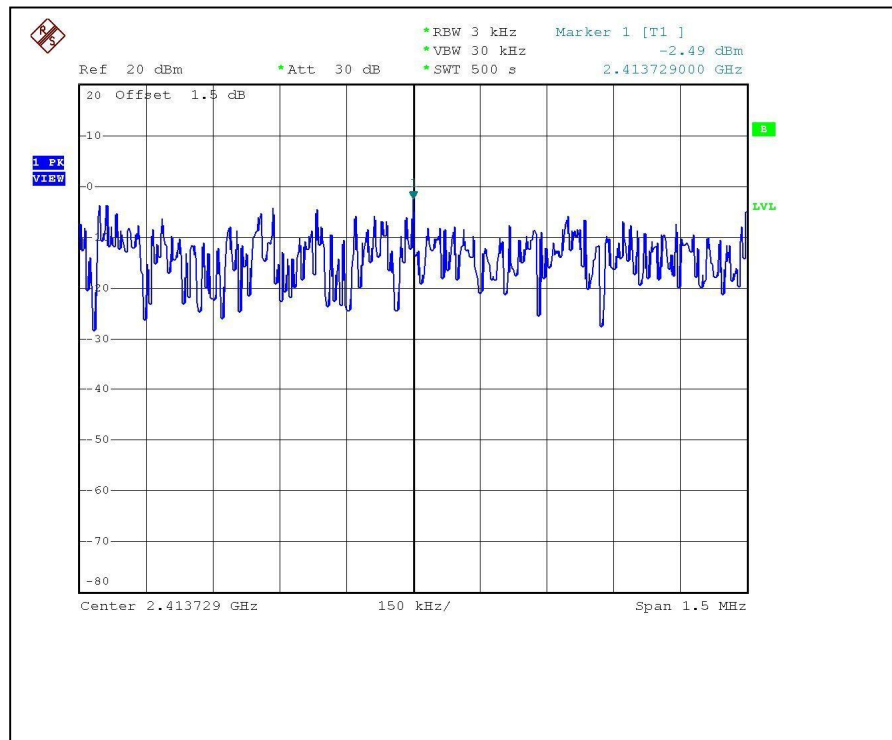

CH6

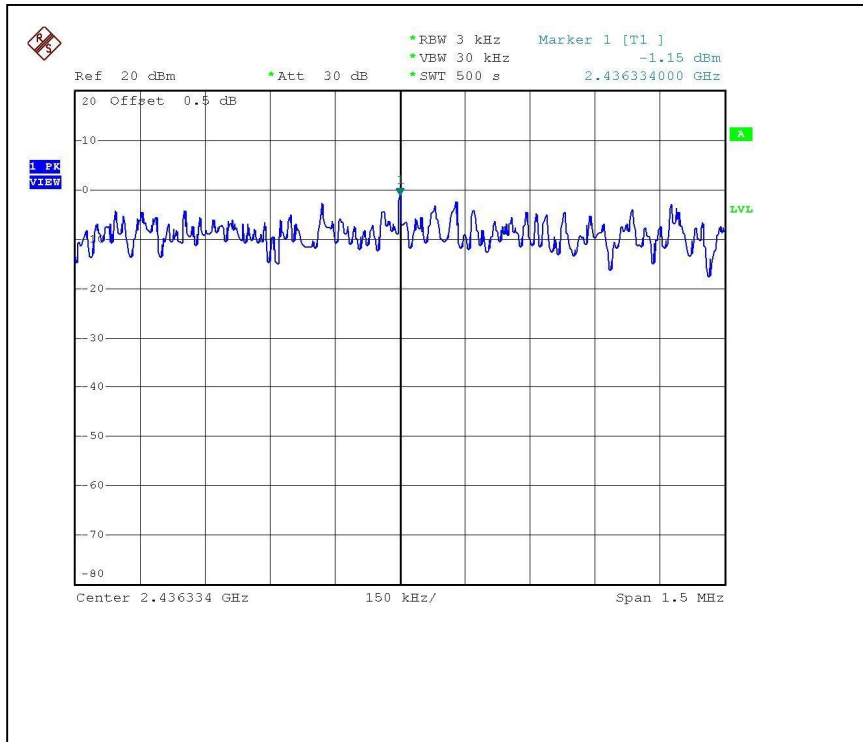

CH11

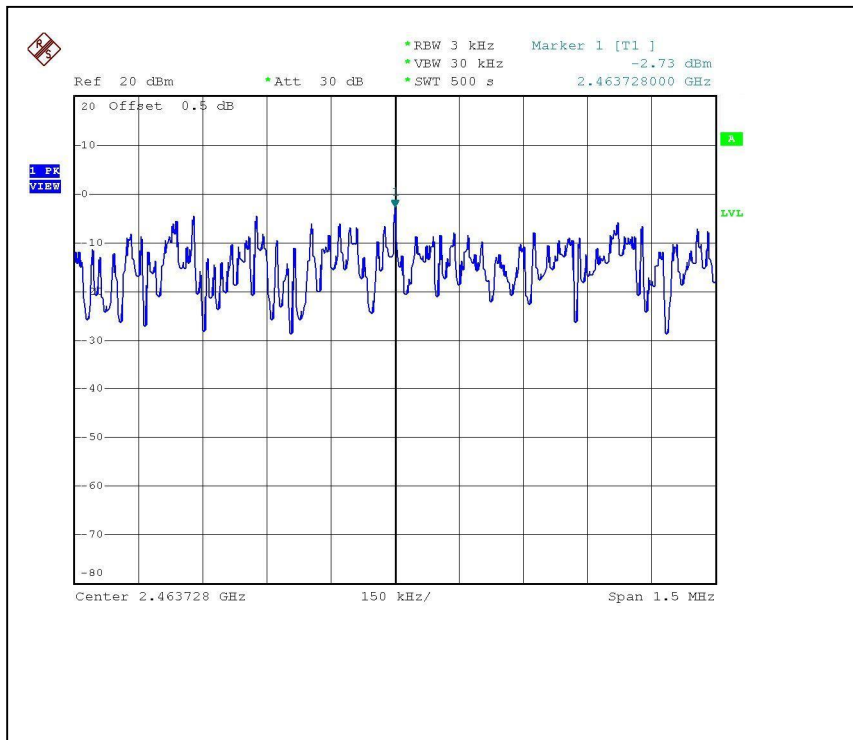

802.11g OFDM MODULATION:

MODULATION TYPE	BPSK	TRANSFER RATE	6Mbps
INPUT POWER	120Vac, 60 Hz	ENVIRONMENTAL CONDITIONS	25deg.C, 60%RH, 972hPa
TESTED BY	Phoenix Huang		

CHANNEL	CHANNEL FREQUENCY (MHz)	RF POWER LEVEL IN 3kHz BW (dBm)	MAXIMUM LIMIT (dBm)	PASS / FAIL
1	2412	-9.78	8	PASS
6	2437	-9.83	8	PASS
11	2462	-10.26	8	PASS

CH1

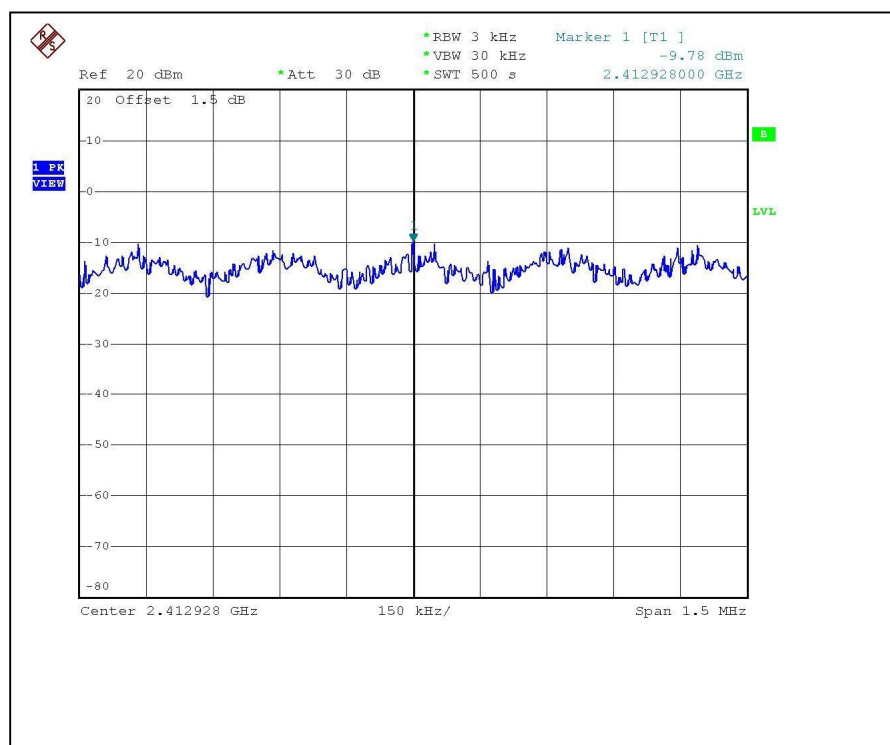

CH6

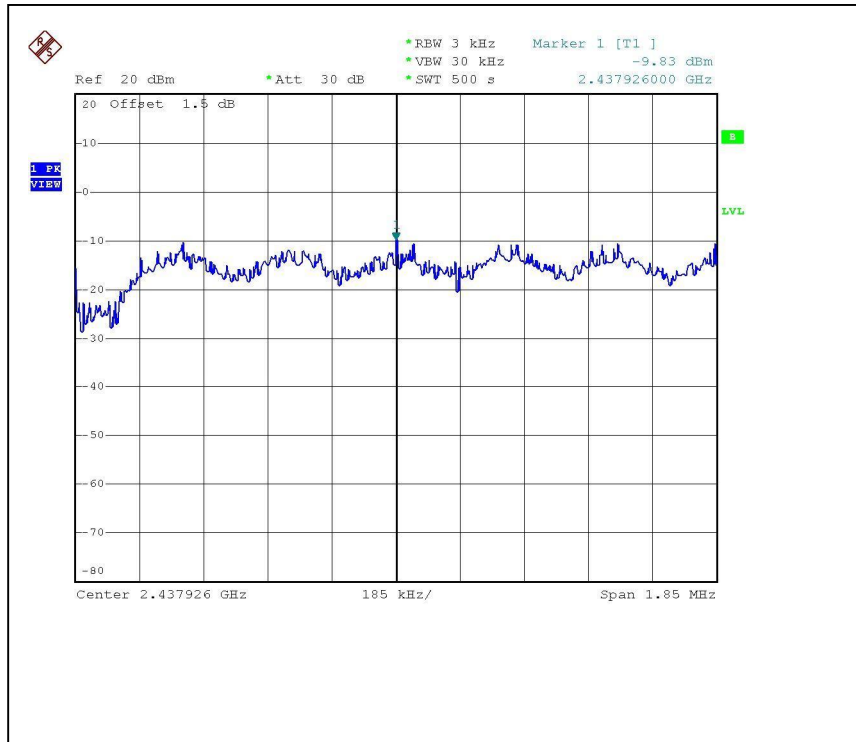

CH11

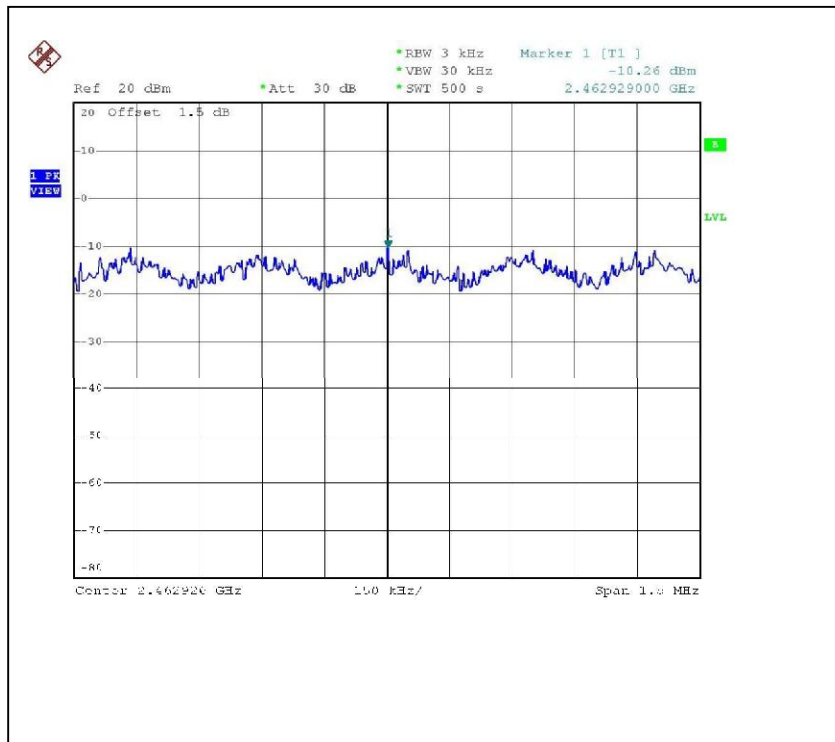

4.6 OUT-BAND EMISSION MEASUREMENT

4.6.1 LIMITS OF OUT-BAND EMISSION MEASUREMENT

Below -20dB of the highest emission level of operating band (in 100KHz Resolution Bandwidth).

4.6.2 TEST INSTRUMENTS

Description & Manufacturer	Model No.	Serial No.	Calibrated Until
R&S SPECTRUM ANALYZER	FSP40	100036	Dec. 17, 2008

NOTE:

- 1.The measurement uncertainty is less than +/- 2.6dB, which is calculated as per the NAMAS document NIS81. This uncertainty represents an expanded uncertainty expressed at approximately the 95% confidence level using a coverage factor of k=2.
- 2.The calibration interval of the above test instruments is 12 months and the calibrations are traceable to NML/ROC and NIST/USA.

4.6.3 TEST PROCEDURE

The transmitter output was connected to the spectrum analyzer via a low lose cable. Set both RBW of spectrum analyzer to 100kHz and VBW of spectrum analyzer to 100kHz with suitable frequency span including 100 MHz bandwidth from band edge. The band edges was measured and recorded.

The spectrum plots (RBW = 100kHz, VBW = 100kHz) are attached on the following pages.

4.6.4 DEVIATION FROM TEST STANDARD

No deviation

4.6.5 EUT OPERATING CONDITION

Same as Item 4.3.6

4.6.6 TEST RESULTS

The spectrum plots are attached on the following below images. D1 line indicates the highest level, and D2 line indicates the 20dB offset below D1. It shows compliance with the requirement in part 15.247(d).

802.11b DSSS MODULATION:

CH1

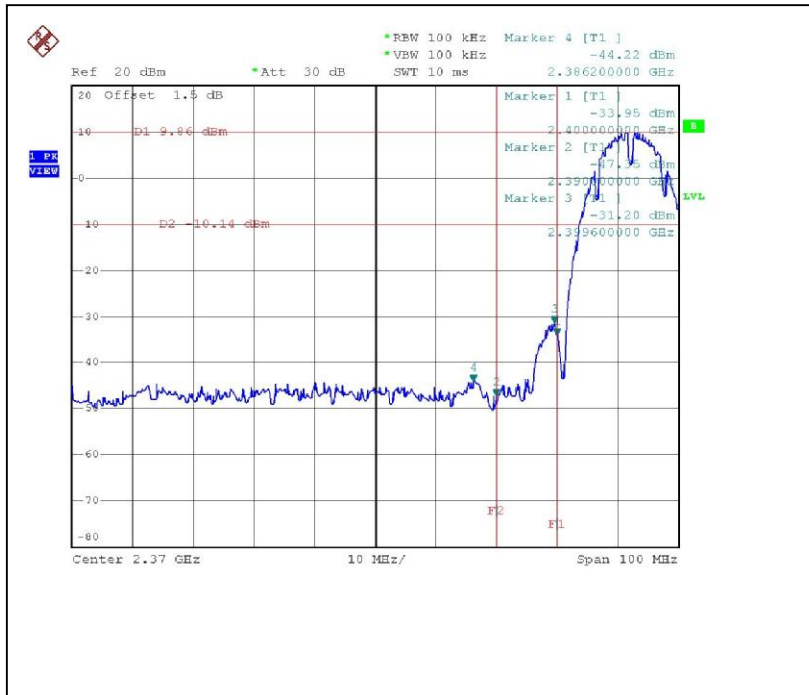

CH11

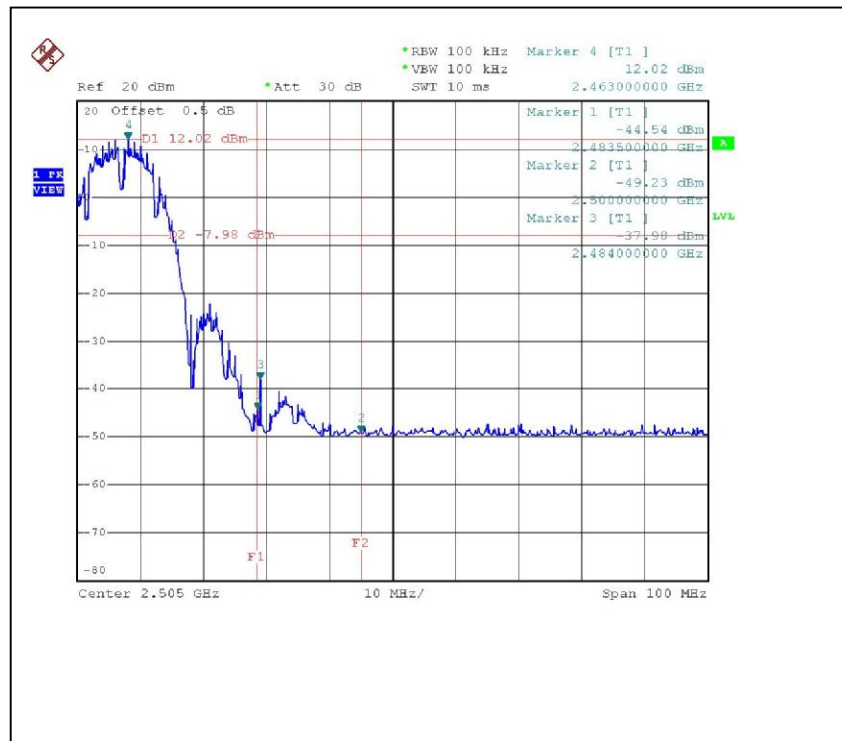

CH1

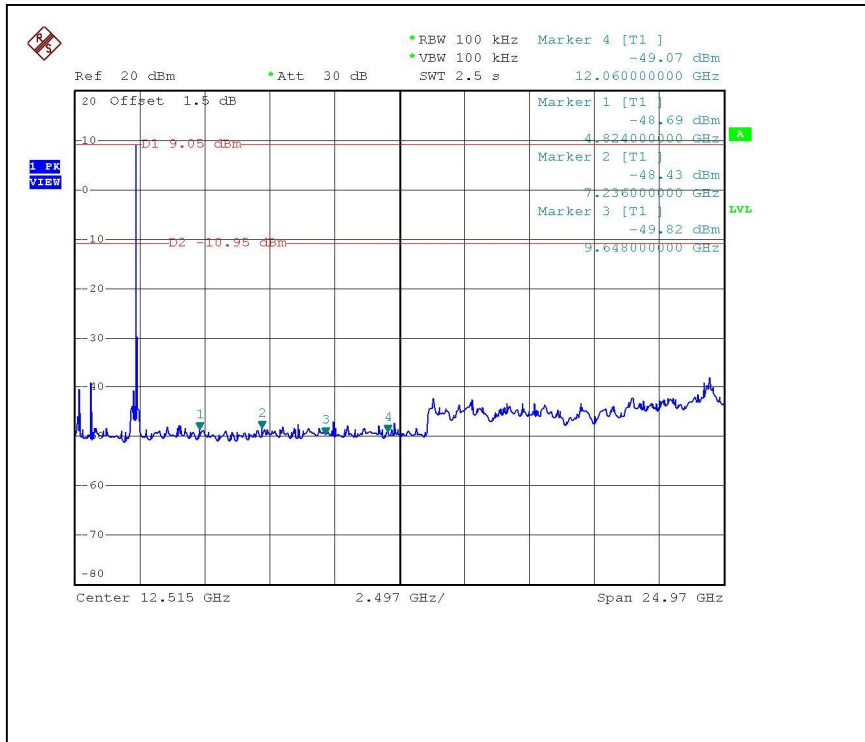

CH11

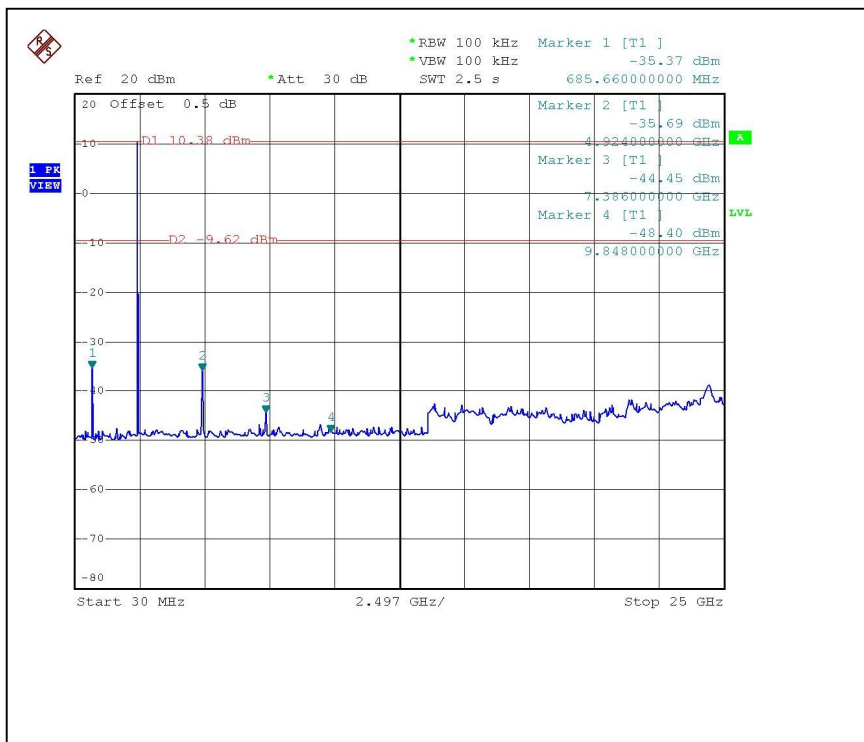

802.11g OFDM MODULATION: CH 1

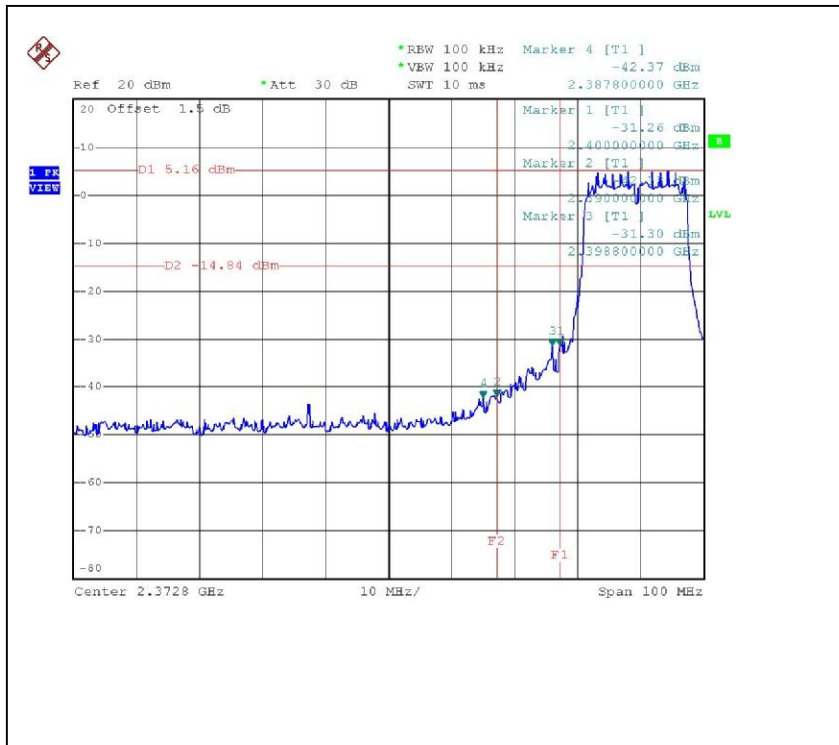

CH11

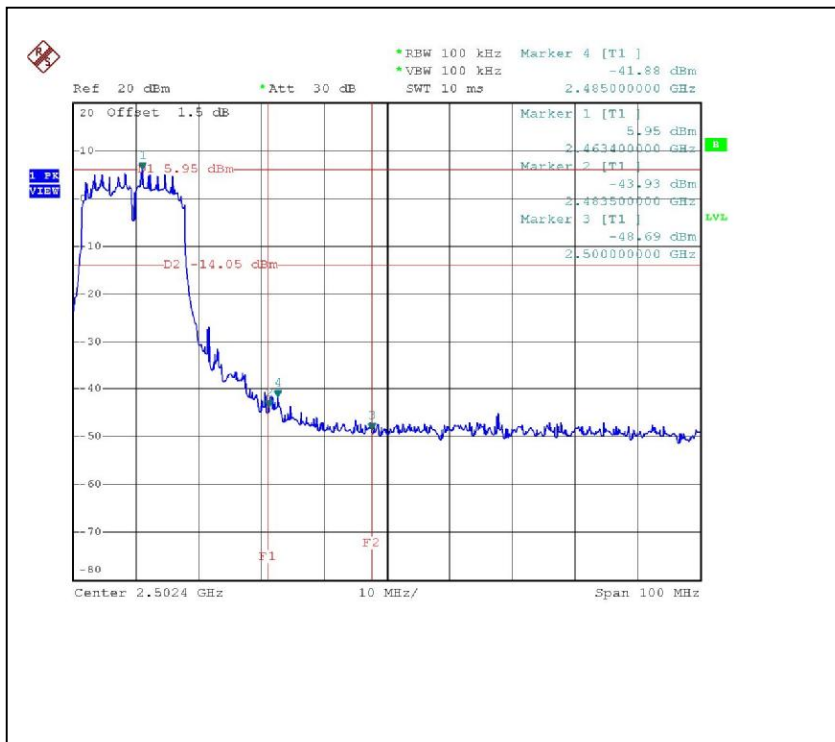

CH1

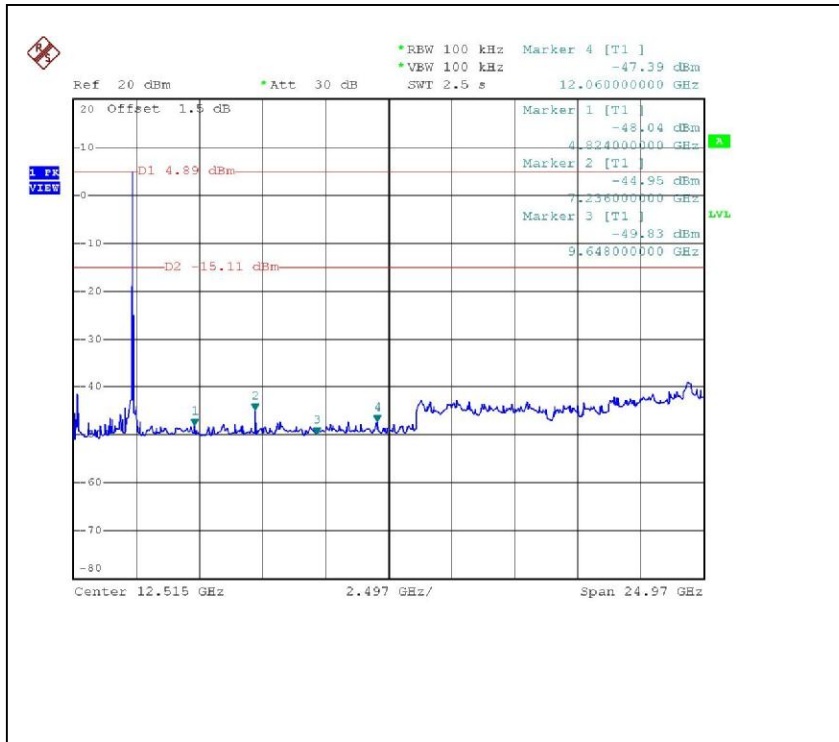

CH11

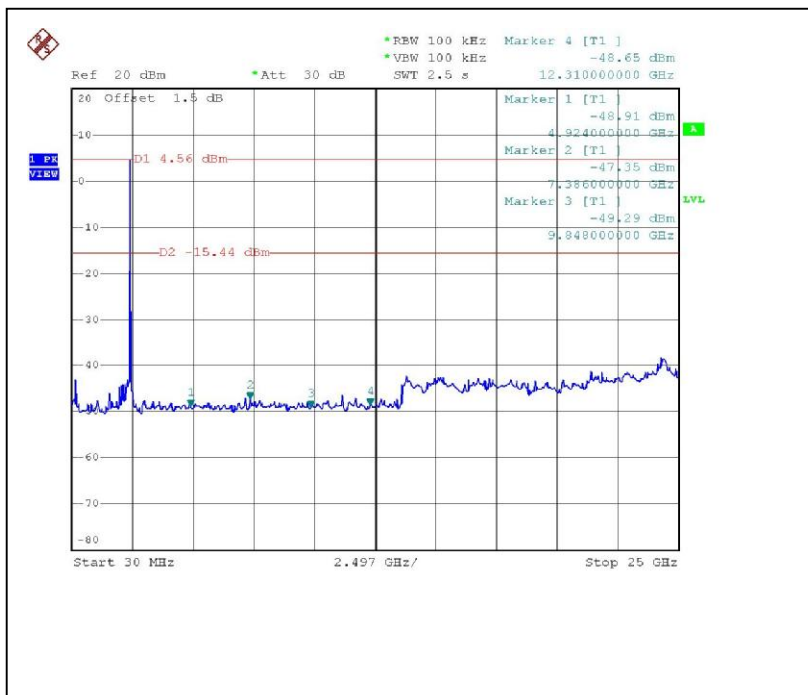



4.7 ANTENNA REQUIREMENT

4.7.1 STANDARD APPLICABLE

For intentional device, according to FCC 47 CFR Section 15.203, an intentional radiator shall be designed to ensure that no antenna other than that furnished by the responsible party shall be used with the device. And according to FCC 47 CFR Section 15.247 (b), if transmitting antennas of directional gain greater than 6dBi are used, the power shall be reduced by the amount in dB that the directional gain of the antenna exceeds 6dBi.

4.7.2 ANTENNA CONNECTED CONSTRUCTION

The antenna used in this product is dipole Antenna without Connector. The maximum Gain of the antenna is 1.1dBi.



5. INFORMATION ON THE TESTING LABORATORIES

We, ADT Corp., were founded in 1988 to provide our best service in EMC, Radio, Telecom and Safety consultation. Our laboratories are accredited and approved by the following approval agencies according to ISO/IEC 17025.

USA	FCC, UL
Germany	TUV Rheinland
Japan	VCCI
Norway	NEMKO
Canada	INDUSTRY CANADA, CSA
R.O.C.	TAF, BSMI, NCC
Netherlands	Telefication
Singapore	GOST-ASIA(MOU)
Russia	CERTIS(MOU)

Copies of accreditation certificates of our laboratories obtained from approval agencies can be downloaded from our web site:

www.adt.com.tw/index.5/phtml. If you have any comments, please feel free to contact us at the following:

Linko EMC/RF Lab:

Tel: 886-2-26052180

Fax: 886-2-26052943

Hsin Chu EMC/RF Lab:

Tel: 886-3-5935343

Fax: 886-3-5935342

Hwa Ya EMC/RF/Safety Telecom Lab:

Tel: 886-3-3183232

Fax: 886-3-3185050

Web Site: www.adt.com.tw

The address and road map of all our labs can be found in our web site also



6. APPENDIX A - MODIFICATIONS RECORDERS FOR ENGINEERING CHANGES TO THE EUT BY THE LAB

No any modifications are made to the EUT by the lab during the test.

--- END ---