



FCC TEST REPORT

REPORT NO.: RF921011R03

MODEL NO.: DI-624

RECEIVED: Oct. 8, 2003

TESTED: Oct. 9, 2003 ~ Oct. 13, 2003

APPLICANT: D-Link Corporation

ADDRESS: No. 8, Li-Hsin VII Road Science Based
Industrial Park, Hsin-Chu, Taiwan

ISSUED BY: Advance Data Technology Corporation

LAB LOCATION: 47 14th Lin, Chiapau Tsun, Linko, Taipei,
Taiwan, R.O.C.

This test report consists of 63 pages in total. It may be duplicated completely for legal use with the approval of the applicant. It should not be reproduced except in full, without the written approval of our laboratory. The client should not use it to claim product endorsement by CNLA, NVLAP or any government agencies. The test results in the report only apply to the tested sample.



0528
ILAC MRA



Lab Code: 200102-0



Table of Contents

1	CERTIFICATION	4
2	SUMMARY OF TEST RESULTS	5
3	GENERAL INFORMATION	6
3.1	GENERAL DESCRIPTION OF EUT	6
3.2	DESCRIPTION OF TEST MODES	7
3.3	GENERAL DESCRIPTION OF APPLIED STANDARDS	7
3.4	DESCRIPTION OF SUPPORT UNITS	8
3.5	CONFIGURATION OF SYSTEM UNDER TEST	9
4	TEST TYPES AND RESULTS	10
4.1	CONDUCTED EMISSION MEASUREMENT	10
4.1.1	LIMITS OF CONDUCTED EMISSION MEASUREMENT	10
4.1.2	TEST INSTRUMENTS	10
4.1.3	TEST PROCEDURES	11
4.1.4	DEVIATION FROM TEST STANDARD	11
4.1.5	TEST SETUP	12
4.1.6	EUT OPERATING CONDITIONS	13
4.1.7	TEST RESULTS	14
4.2	RADIATED EMISSION MEASUREMENT	20
4.2.1	LIMITS OF RADIATED EMISSION MEASUREMENT	20
4.2.2	TEST INSTRUMENTS	21
4.2.3	TEST PROCEDURES	22
4.2.4	DEVIATION FROM TEST STANDARD	22
4.2.5	TEST SETUP	23
4.2.6	EUT OPERATING CONDITIONS	23
4.2.7	TEST RESULTS	24
4.3	6dB BANDWIDTH MEASUREMENT	31
4.3.1	LIMITS OF 6dB BANDWIDTH MEASUREMENT	31
4.3.2	TEST INSTRUMENTS	31
4.3.3	TEST PROCEDURE	31
4.3.4	DEVIATION FROM TEST STANDARD	31
4.3.5	TEST SETUP	32



4.3.6 EUT OPERATING CONDITIONS.....32

4.3.7 TEST RESULTS..... 33

4.4 MAXIMUM PEAK OUTPUT POWER41

4.4.1 LIMITS OF MAXIMUM PEAK OUTPUT POWER MEASUREMENT41

4.4.2 TEST INSTRUMENTS41

4.4.3 TEST PROCEDURES.....42

4.4.4 DEVIATION FROM TEST STANDARD42

4.4.5 TEST SETUP42

4.4.6 EUT OPERATING CONDITIONS.....42

4.4.7 TEST RESULTS.....43

4.5 POWER SPECTRAL DENSITY MEASUREMENT44

4.5.1 LIMITS OF POWER SPECTRAL DENSITY MEASUREMENT44

4.5.2 TEST INSTRUMENTS44

4.5.3 TEST PROCEDURE45

4.5.4 DEVIATION FROM TEST STANDARD45

4.5.5 TEST SETUP45

4.5.6 EUT OPERATING CONDITIONS.....45

4.5.7 TEST RESULTS.....46

4.6 BAND EDGES MEASUREMENT54

4.6.1 LIMITS OF BAND EDGES MEASUREMENT54

4.6.2 TEST INSTRUMENTS54

4.6.3 TEST PROCEDURE54

4.6.4 DEVIATION FROM TEST STANDARD54

4.6.5 EUT OPERATING CONDITION55

4.6.6 TEST RESULTS.....55

4.7 ANTENNA REQUIREMENT60

4.7.1 STANDARD APPLICABLE60

4.7.2 ANTENNA CONNECTED CONSTRUCTION.....60

5 PHOTOGRAPHS OF THE TEST CONFIGURATION.....61

6 INFORMATION ON THE TESTING LABORATORIES63



1 CERTIFICATION

PRODUCT NAME : AirPlus Xtreme G™ Wireless Router
MODEL NO.: DI-624
BRAND NAME : D-Link
APPLICANT : D-Link Corporation
TEST ITEM : ENGINEERING SAMPLE
STANDARDS : 47 CFR Part 15, Subpart C (Section 15.247),
ANSI C63.4-1992

We, **Advance Data Technology Corporation**, hereby certify that two samples of the designation have been tested in our facility from Oct. 9, 2003 to Oct. 13, 2003. The test record, data evaluation and Equipment Under Test (EUT) configurations represented herein are true and accurate accounts of the measurements of the sample's EMC characteristics under the conditions herein specified.

PREPARED BY : Emely Lu , **DATE :** Oct. 15, 2003
Emely Lu

APPROVED BY : Ellis Wu , **DATE :** Oct. 15, 2003
Ellis Wu, Manager

2 SUMMARY OF TEST RESULTS

The EUT has been tested according to the following specifications:

APPLIED STANDARD: 47 CFR Part 15, Subpart C			
Standard Section	Test Type and Limit	Result	REMARK
15.207	AC Power Conducted Emission	PASS	Meet the requirement of limit Minimum passing margin is -11.62dB at 0.225MHz
15.247(a)(2)	Spectrum Bandwidth of a Direct Sequence Spread Spectrum System. Limit: min. 500kHz	PASS	Meet the requirement of limit
15.247(b)	Maximum Peak Output Power Limit: max. 30dBm	PASS	Meet the requirement of limit
15.247(c)	Transmitter Radiated Emissions Limit: Table 15.209	PASS	Meet the requirement of limit Minimum passing margin is -1.69dB at 2688.00MHz
15.247(d)	Power Spectral Density Limit: max. 8dBm	PASS	Meet the requirement of limit
15.247(c)	Band Edge Measurement Limit: 20dB less than the peak value of fundamental frequency	PASS	Meet the requirement of limit



3 GENERAL INFORMATION

3.1 GENERAL DESCRIPTION OF EUT

PRODUCT NAME	AirPlus Xtreme G™ Wireless Router
MODEL NO.	DI-624
POWER SUPPLY	5VDC from power adapter
MODULATION TYPE	BPSK, QPSK, CCK, 16QAM, 64QAM
RADIO TECHNOLOGY	DSSS, OFDM
TRANSFER RATE	1/2/5.5/6/9/11/12/18/24/36/48/54Mbps
FREQUENCY RANGE	2412MHz ~ 2462MHz
NUMBER OF CHANNEL	11
OUTPUT POWER	17.14dBm
ANTENNA TYPE	Dipole antenna with 2.0dBi gain
DATA CABLE	NA
I/O PORTS	RJ45
ASSOCIATED DEVICES	NA

NOTE:

1. The EUT was tested with the following adapter:

BRAND :	D-Link
MODEL :	SMP-T1178
INPUT :	100-120V--0.5A 50-60Hz
OUTPUT :	+5.0V—2.5A

2. The EUT operates in the 2.4GHz frequency spectrum and compatible with the draft 802.11g standard to provide a wireless data rate of up to 54Mbps.
3. For more detailed features description, please refer to the manufacturer's specifications or User's Manual.



3.2 DESCRIPTION OF TEST MODES

Eleven channels are provided to this EUT.

Channel	Frequency	Channel	Frequency
1	2412 MHz	7	2442 MHz
2	2417 MHz	8	2447 MHz
3	2422 MHz	9	2452 MHz
4	2427 MHz	10	2457 MHz
5	2432 MHz	11	2462 MHz
6	2437 MHz		

NOTE:

1. Below 1GHz, the channel 1, 6, and 11 were pre-tested in chamber. The channel 11, the worst case, was chosen for final test.
2. Above 1GHz, the channel 1, 6, and 11 were tested individually.
3. For radiated emission measurement, transfer rate at 11Mbps with CCK technique and 6Mbps with OFDM technique, worst cases, were chosen for final test.

3.3 GENERAL DESCRIPTION OF APPLIED STANDARDS

The EUT is the specifications of the manufacturer, it must comply with the requirements of the following standards:

FCC 47 CFR Part 15, Subpart C. (15.247)

ANSI C63.4: 1992

All tests have been performed and recorded as per the above standards.

NOTE: The EUT is also considered as a kind of computer peripheral, because the connection to computer is necessary for typical use. It has been verified to comply with the requirements of FCC Part 15, Subpart B, Class B (DoC). The test report has been issued separately.



3.4 DESCRIPTION OF SUPPORT UNITS

The EUT has been tested as an independent unit together with other necessary accessories or support units. The following support units or accessories were used to form a representative test configuration during the tests.

NO.	PRODUCT	BRAND	MODEL NO.	SERIAL NO.	FCC ID
1	MONITOR	HP	D2842A	KR93473113	BEJCB910
2	PERSONAL COMPUTER	HP	DTPC 27	SG21103587	FCC DoC
3	PS/2 KEYBOARD	BTC	5200T	F24800221	E5XKB5122WTH0110
4	PS/2 MOUSE	BTC	M851	N/A	E5XMSM860
5	MODEM	ACEEX	1414	980020514	IFAXDM1414
6	PRINTER	EPSON	LQ-300+	DCGY017054	FCC DoC
7	Notebook	Compaq	N800C	470048-515	FCC DoC

NO.	SIGNAL CABLE DESCRIPTION OF THE ABOVE SUPPORT UNITS
1	1.8 m braid shielded wire, terminated with VGA connector via metallic frame, w/o core.
2	NA
3	1.6 m foil shielded wire, terminated with PS/2 connector via metallic frame, w/o core.
4	1.5 m Non shielded wire, terminated with PS/2 connector via drain wire, w/o core.
5	1.2 m braid shielded wire, terminated with DB25 and DB9 connector via metallic frame, w/o core.
6	1.2m braid shielded wire, terminated with DB25 and Centronics connector via metallic frame, w/o core
7	NA

NOTE: All power cords of the above support units are non shielded (1.8m).

3.5 CONFIGURATION OF SYSTEM UNDER TEST

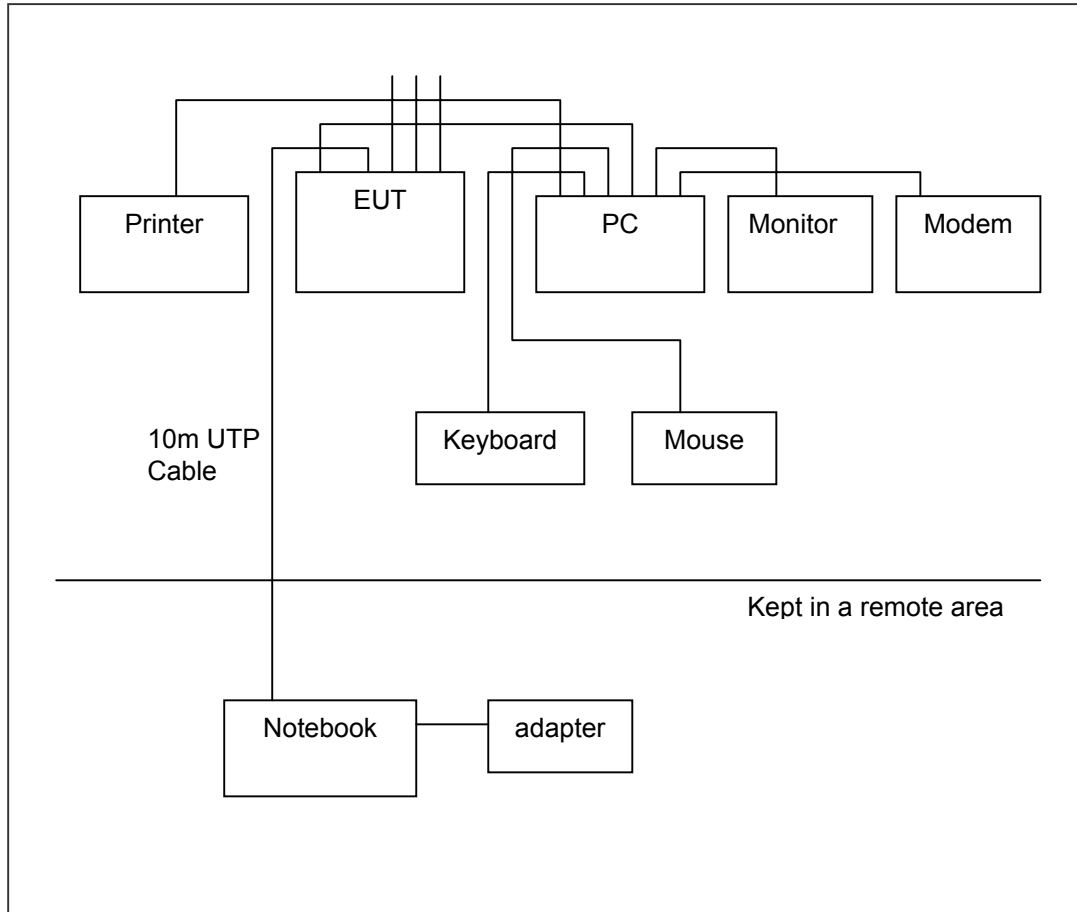



4 TEST TYPES AND RESULTS

4.1 CONDUCTED EMISSION MEASUREMENT

4.1.1 LIMITS OF CONDUCTED EMISSION MEASUREMENT

FREQUENCY OF EMISSION (MHz)	CONDUCTED LIMIT (dB μ V)	
	Quasi-peak	Average
0.15-0.5	66 to 56	56 to 46
0.5-5	56	46
5-30	60	50

- NOTE:**
1. The lower limit shall apply at the transition frequencies.
 2. The limit decreases in line with the logarithm of the frequency in the range of 0.15 to 0.50 MHz.
 3. All emanations from a class A/B digital device or system, including any network of conductors and apparatus connected thereto, shall not exceed the level of field strengths specified above.

4.1.2 TEST INSTRUMENTS

DESCRIPTION & MANUFACTURER	MODEL NO.	SERIAL NO.	CALIBRATED UNTIL
ROHDE & SCHWARZ Test Receiver	ESCS 30	838251/021	Jan. 20, 2004
ROHDE & SCHWARZ Artificial Mains Network (for EUT)	ESH3-Z5	100218	Dec. 18, 2003
ROHDE & SCHWARZ Artificial Mains Network (for peripherals)	ESH3-Z5	100219	Dec. 18, 2003
ROHDE & SCHWARZ Artificial Mains Network (for peripherals)	ESH3-Z5	100220	Dec. 18, 2003
ROHDE & SCHWARZ 4-wire ISN	ENY41	837032/016	Nov. 29 2003
ROHDE & SCHWARZ 2-wire ISN	ENY22	837497/016	Nov. 29 2003
Software	Cond-V2M3	NA	NA
RF cable (JYEBAO)	5D-FB	Cable-C10.01	May 01, 2004
SUHNER Terminator (For ROHDE & SCHWARZ LISN)	65BNC-5001	E1-010770	Mar. 24, 2004
SUHNER Terminator (For ROHDE & SCHWARZ LISN)	65BNC-5001	E1-010773	Apr. 06, 2004

- NOTE:**
1. The calibration interval of the above test instruments is 12 months and the calibrations are traceable to NML/ROC and NIST/USA.
 2. “*”: These equipment are used for conducted telecom port test only (if tested).
 3. The test was performed in ADT Shielded Room No. 10.
 4. The VCCI Site Registration No. is C-1312.



4.1.3 TEST PROCEDURES

- a. The EUT was placed 0.4 meters from the conducting wall of the shielded room with EUT being connected to the power mains through a line impedance stabilization network (LISN). Other support units were connected to the power mains through another LISN. The two LISNs provide 50 ohm/ 50uH of coupling impedance for the measuring instrument.
- b. Both lines of the power mains connected to the EUT were checked for maximum conducted interference.
- c. The frequency range from 150kHz to 30MHz was searched. Emission levels over 10dB under the prescribed limits could not be reported

4.1.4 DEVIATION FROM TEST STANDARD

No deviation

4.1.5 TEST SETUP

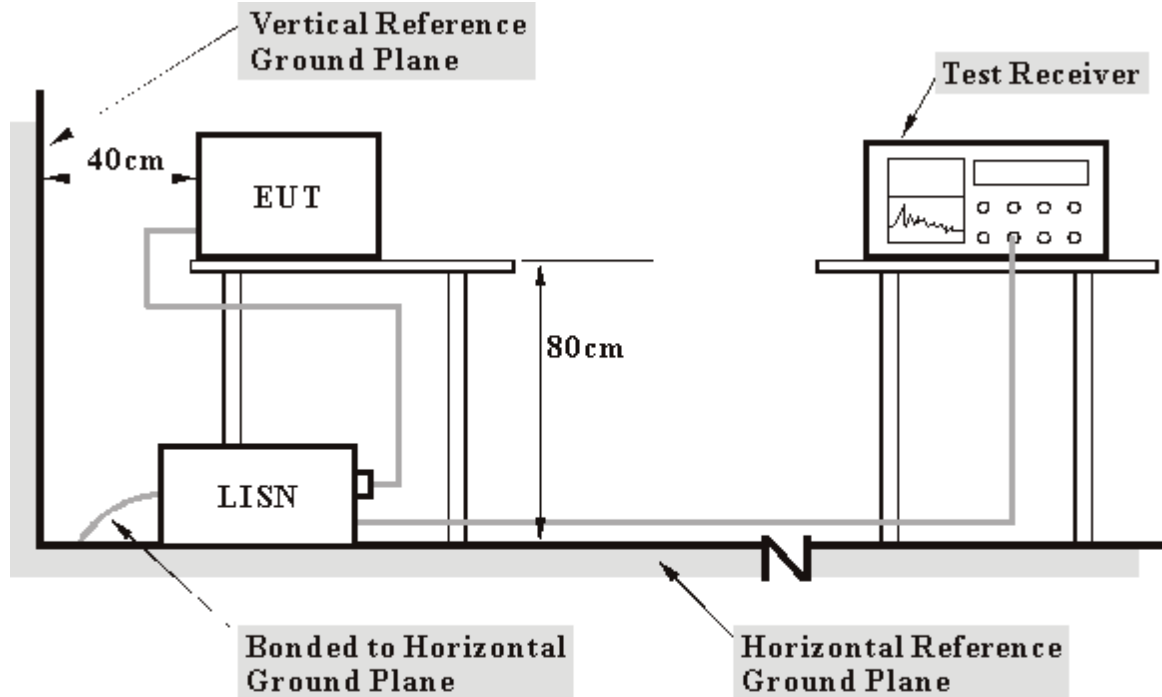

- Note:**
1. Support units were connected to second LISN.
 2. Both of LISNs (AMN) 80 cm from EUT and at the least 80 cm from other units and other metal planes support units.

For the actual test configuration, please refer to the related item – Photographs of the Test Configuration.



4.1.6 EUT OPERATING CONDITIONS

- a. Placed the EUT on the testing table.
- b. The computer system sent data to EUT by command "PIN" via RJ45 cable.
- c. The computer system sent "H" messages to Color Monitor and Monitor displayed "H" patterns on its screen.
- d. The computer system sent "H" messages to modem.
- e. The computer system sent "H" messages to the printer, and the printer prints them on paper.
- f. Prepared another computer system to act as a communication partner and placed it outside of testing area.
- g. The communication partner ran a test program to enable EUT under transmission/receiving condition continuously at specific channel frequency via RJ45 cable.
- h. The communication partner sent data to EUT by command "PIN".



4.1.7 TEST RESULTS

EUT	AirPlus Xtreme G™ Wireless Router	MODEL	DI-624
CHANNEL	Channel 1	6dB BANDWIDTH	9kHz
INPUT POWER (SYSTEM)	120Vac, 60 Hz	PHASE	Line (L)
ENVIRONMENTAL CONDITIONS	30deg.C, 60%RH, 991hPa	TESTED BY: Hardaway Lee	

No	Freq. [MHz]	Corr. Factor (dB)	Reading Value		Emission Level		Limit		Margin	
			[dB (uV)]		[dB (uV)]		[dB (uV)]		(dB)	
			Q.P.	AV.	Q.P.	AV.	Q.P.	AV.	Q.P.	AV.
1	0.150	0.05	54.12	-	54.17	-	66.00	56.00	-11.83	-
2	0.225	0.06	50.96	-	51.02	-	62.64	52.64	-11.62	-
3	0.377	0.06	40.35	-	40.41	-	58.35	48.35	-17.94	-
4	2.480	0.19	36.33	-	36.52	-	56.00	46.00	-19.48	-
5	4.289	0.23	34.32	-	34.55	-	56.00	46.00	-21.45	-
6	21.512	0.72	41.55	-	42.27	-	60.00	50.00	-17.73	-

- REMARKS:**
1. Q.P. and AV. are abbreviations of quasi-peak and average individually.
 2. "-": The Quasi-peak reading value also meets average limit and measurement with the average detector is unnecessary.
 3. The emission levels of other frequencies were very low against the limit.
 4. Margin value = Emission level - Limit value
 5. Correction factor = Insertion loss + Cable loss
 6. Emission Level = Correction Factor + Reading Value.

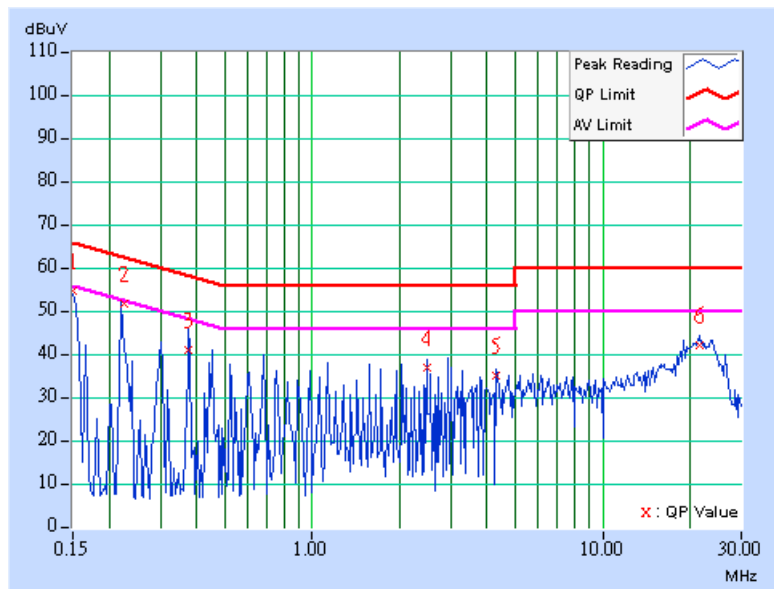



EUT	AirPlus Xtreme G™ Wireless Router	MODEL	DI-624
CHANNEL	Channel 1	6dB BANDWIDTH	9kHz
INPUT POWER (SYSTEM)	120Vac, 60 Hz	PHASE	Neutral (N)
ENVIRONMENTAL CONDITIONS	30deg.C, 60%RH, 991hPa	TESTED BY: Hardaway Lee	

No	Freq. [MHz]	Corr. Factor (dB)	Reading Value [dB (uV)]		Emission Level [dB (uV)]		Limit [dB (uV)]		Margin (dB)	
			Q.P.	AV.	Q.P.	AV.	Q.P.	AV.	Q.P.	AV.
			1	0.154	0.05	51.88	-	51.93	-	65.79
2	0.224	0.05	51.05	-	51.10	-	62.66	52.66	-11.56	-
3	0.300	0.05	43.41	-	43.46	-	60.25	50.25	-16.79	-
4	0.455	0.06	41.40	-	41.46	-	56.79	46.79	-15.33	-
5	1.582	0.17	34.45	-	34.62	-	56.00	46.00	-21.38	-
6	22.266	0.61	38.65	-	39.26	-	60.00	50.00	-20.74	-

- REMARKS:**
1. Q.P. and AV. are abbreviations of quasi-peak and average individually.
 2. "-": The Quasi-peak reading value also meets average limit and measurement with the average detector is unnecessary.
 3. The emission levels of other frequencies were very low against the limit.
 4. Margin value = Emission level - Limit value
 5. Correction factor = Insertion loss + Cable loss
 6. Emission Level = Correction Factor + Reading Value.

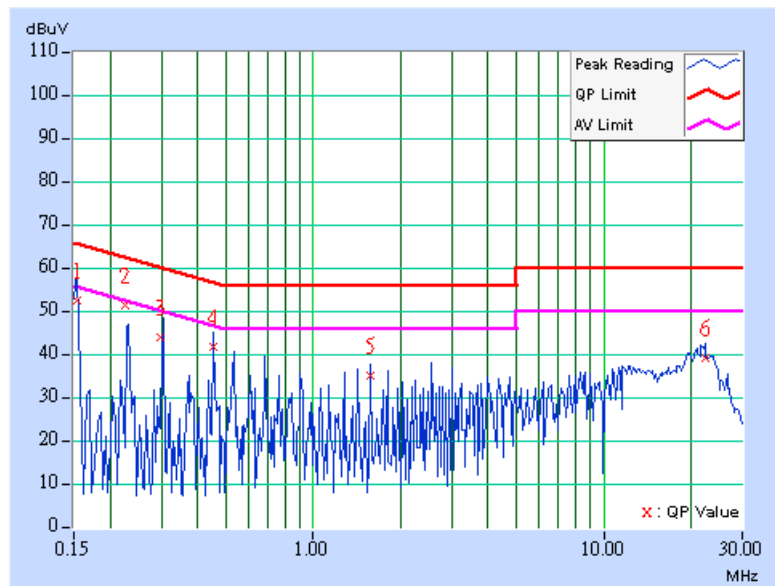



EUT	AirPlus Xtreme G™ Wireless Router	MODEL	DI-624
CHANNEL	Channel 6	6dB BANDWIDTH	9kHz
INPUT POWER (SYSTEM)	120Vac, 60 Hz	PHASE	Line (L)
ENVIRONMENTAL CONDITIONS	30deg.C, 60%RH, 991hPa	TESTED BY: Hardaway Lee	

No	Freq. [MHz]	Corr. Factor (dB)	Reading Value		Emission Level		Limit		Margin	
			[dB (uV)]		[dB (uV)]		[dB (uV)]		(dB)	
			Q.P.	AV.	Q.P.	AV.	Q.P.	AV.	Q.P.	AV.
1	0.158	0.06	47.66	-	47.72	-	65.58	55.58	-17.86	-
2	0.220	0.06	40.79	-	40.85	-	62.81	52.81	-21.96	-
3	0.455	0.07	41.91	-	41.98	-	56.79	46.79	-14.81	-
4	1.656	0.17	36.79	-	36.96	-	56.00	46.00	-19.04	-
5	7.820	0.34	32.89	-	33.23	-	60.00	50.00	-26.77	-
6	21.664	0.72	40.97	-	41.69	-	60.00	50.00	-18.31	-

- REMARKS:**
1. Q.P. and AV. are abbreviations of quasi-peak and average individually.
 2. "-": The Quasi-peak reading value also meets average limit and measurement with the average detector is unnecessary.
 3. The emission levels of other frequencies were very low against the limit.
 4. Margin value = Emission level - Limit value
 5. Correction factor = Insertion loss + Cable loss
 6. Emission Level = Correction Factor + Reading Value.

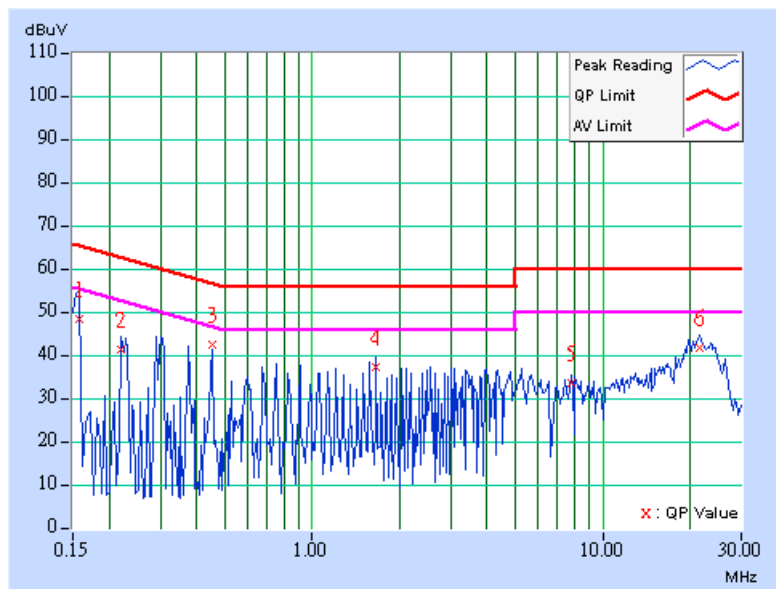



EUT	AirPlus Xtreme G™ Wireless Router	MODEL	DI-624
CHANNEL	Channel 6	6dB BANDWIDTH	9kHz
INPUT POWER (SYSTEM)	120Vac, 60 Hz	PHASE	Neutral (N)
ENVIRONMENTAL CONDITIONS	30deg.C, 60%RH, 991hPa	TESTED BY: Hardaway Lee	

No	Freq. [MHz]	Corr. Factor (dB)	Reading Value		Emission Level		Limit		Margin	
			[dB (uV)]		[dB (uV)]		[dB (uV)]		(dB)	
			Q.P.	AV.	Q.P.	AV.	Q.P.	AV.	Q.P.	AV.
1	0.162	0.05	37.58	-	37.63	-	65.38	55.38	-27.75	-
2	0.224	0.05	48.98	-	49.03	-	62.66	52.66	-13.63	-
3	0.298	0.05	42.01	-	42.06	-	60.29	50.29	-18.23	-
4	1.125	0.16	33.72	-	33.88	-	56.00	46.00	-22.12	-
5	2.930	0.19	33.32	-	33.51	-	56.00	46.00	-22.49	-
6	21.738	0.59	37.69	-	38.28	-	60.00	50.00	-21.72	-

- REMARKS:**
1. Q.P. and AV. are abbreviations of quasi-peak and average individually.
 2. "-": The Quasi-peak reading value also meets average limit and measurement with the average detector is unnecessary.
 3. The emission levels of other frequencies were very low against the limit.
 4. Margin value = Emission level - Limit value
 5. Correction factor = Insertion loss + Cable loss
 6. Emission Level = Correction Factor + Reading Value.

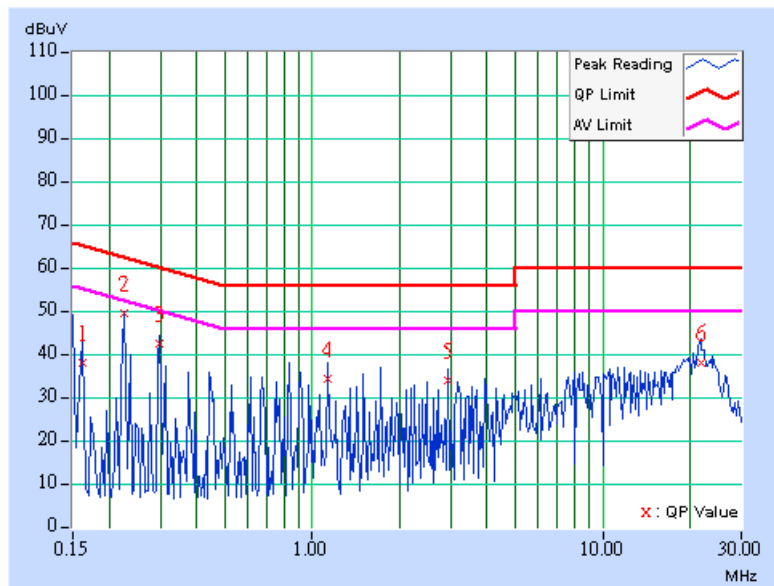



EUT	AirPlus Xtreme G™ Wireless Router	MODEL	DI-624
CHANNEL	Channel 11	6dB BANDWIDTH	9kHz
INPUT POWER (SYSTEM)	120Vac, 60 Hz	PHASE	Line (L)
ENVIRONMENTAL CONDITIONS	30deg.C, 60%RH, 991hPa	TESTED BY: Hardaway Lee	

No	Freq. [MHz]	Corr. Factor (dB)	Reading Value		Emission Level		Limit		Margin	
			[dB (uV)]		[dB (uV)]		[dB (uV)]		(dB)	
			Q.P.	AV.	Q.P.	AV.	Q.P.	AV.	Q.P.	AV.
1	0.154	0.06	52.91	-	52.97	-	65.79	55.79	-12.82	-
2	0.302	0.06	46.55	-	46.61	-	60.18	50.18	-13.57	-
3	0.451	0.07	42.87	-	42.94	-	56.86	46.86	-13.92	-
4	3.836	0.22	35.92	-	36.14	-	56.00	46.00	-19.86	-
5	16.844	0.59	35.68	-	36.27	-	60.00	50.00	-23.73	-
6	21.883	0.73	40.98	-	41.71	-	60.00	50.00	-18.29	-

- REMARKS:**
1. Q.P. and AV. are abbreviations of quasi-peak and average individually.
 2. "-": The Quasi-peak reading value also meets average limit and measurement with the average detector is unnecessary.
 3. The emission levels of other frequencies were very low against the limit.
 4. Margin value = Emission level - Limit value
 5. Correction factor = Insertion loss + Cable loss
 6. Emission Level = Correction Factor + Reading Value.

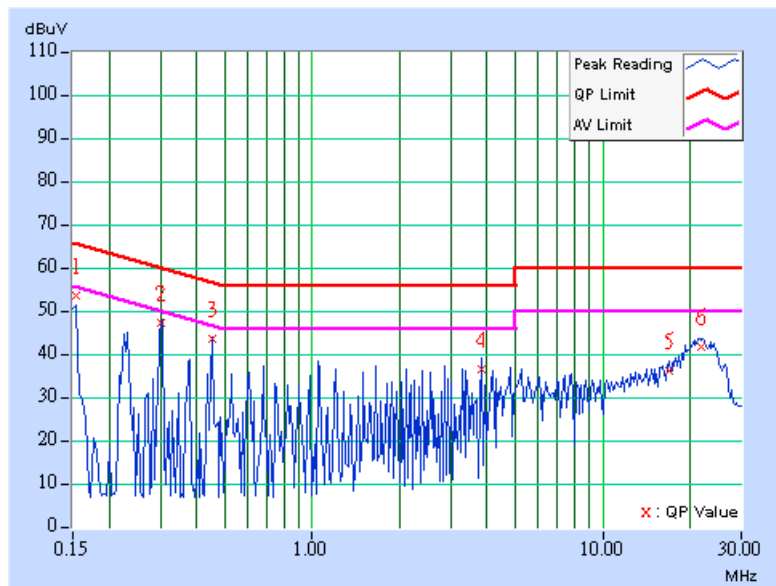



EUT	AirPlus Xtreme G™ Wireless Router	MODEL	DI-624
CHANNEL	Channel 11	6dB BANDWIDTH	9kHz
INPUT POWER (SYSTEM)	120Vac, 60 Hz	PHASE	Neutral (N)
ENVIRONMENTAL CONDITIONS	30deg.C, 60%RH, 991hPa	TESTED BY: Hardaway Lee	

No	Freq. [MHz]	Corr. Factor (dB)	Reading Value		Emission Level		Limit		Margin	
			[dB (uV)]		[dB (uV)]		[dB (uV)]		(dB)	
			Q.P.	AV.	Q.P.	AV.	Q.P.	AV.	Q.P.	AV.
1	0.150	0.05	53.55	-	53.60	-	66.00	56.00	-12.40	-
2	0.228	0.05	48.91	-	48.96	-	62.52	52.52	-13.56	-
3	0.380	0.05	40.77	-	40.82	-	58.27	48.27	-17.45	-
4	0.677	0.10	35.17	-	35.27	-	56.00	46.00	-20.73	-
5	11.207	0.41	34.63	-	35.04	-	60.00	50.00	-24.96	-
6	22.188	0.61	38.82	-	39.43	-	60.00	50.00	-20.57	-

- REMARKS:**
1. Q.P. and AV. are abbreviations of quasi-peak and average individually.
 2. "-": The Quasi-peak reading value also meets average limit and measurement with the average detector is unnecessary.
 3. The emission levels of other frequencies were very low against the limit.
 4. Margin value = Emission level - Limit value
 5. Correction factor = Insertion loss + Cable loss
 6. Emission Level = Correction Factor + Reading Value.

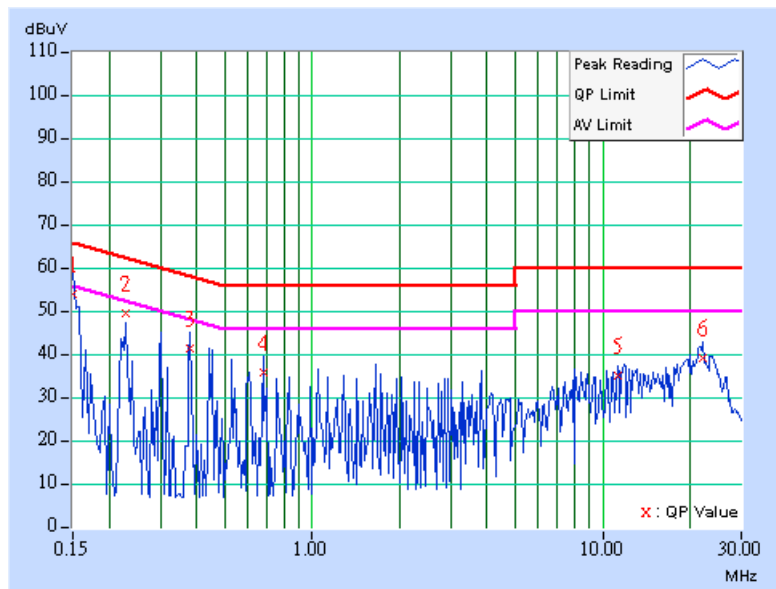



4.2 RADIATED EMISSION MEASUREMENT

4.2.1 LIMITS OF RADIATED EMISSION MEASUREMENT

Emissions radiated outside of the specified bands, shall be according to the general radiated limits in 15.209 as following:

Frequencies (MHz)	Field strength (microvolts/meter)	Measurement distance (meters)
0.009-0.490	2400/F(kHz)	300
0.490-1.705	24000/F(kHz)	30
1.705-30.0	30	30
30-88	100	3
88-216	150	3
216-960	200	3
Above 960	500	3

NOTE:

1. The lower limit shall apply at the transition frequencies.
2. Emission level (dBuV/m) = 20 log Emission level (uV/m).
3. As shown in 15.35(b), for frequencies above 1000MHz, the field strength limits are based on average detector, however, the peak field strength of any emission shall not exceed the maximum permitted average limits, specified above by more than 20dB under any condition of modulation.



4.2.2 TEST INSTRUMENTS

DESCRIPTION & MANUFACTURER	MODEL NO.	SERIAL NO.	CALIBRATED UNTIL
* HP Spectrum Analyzer	8590L	3520A00667	Aug. 28, 2004
* CHASE Preamplifier	CPA9231A/4	3215	Nov. 06, 2003
* HP Preamplifier	8449B	3008A01201	Dec. 01, 2003
* HP Preamplifier	8449B	3008A01292	Aug. 11, 2004
* ROHDE & SCHWARZ TEST RECEIVER	ESVS10	846285/012	Aug. 28, 2004
* ROHDE & SCHWARZ TEST RECEIVER	ESMI	839013/007 839379/002	Feb. 13, 2004
SCHAFFNER Tunable Dipole Antenna	VHBA 9123	459	Nov. 22, 2003
SCHWARZBECK Tunable Dipole Antenna	UHA 9105	977	
* CHASE BILOG Antenna	CBL6112B	2751	Mar. 21, 2004
* SCHWARZBECK Horn Antenna	BBHA9120-D1	D130	Jun. 30, 2004
* EMCO Horn Antenna	3115	9312-4192	Mar. 23, 2004
* CHANCE Turn Table & Tower Controller	ACS-I	NA	NA
* Software	ADT_Radiated_V5.14	NA	NA
* ANRITSU RF Switches	MP59B	M51167	Aug. 16, 2004
* TIMES RF cable	LMR-600	CABLE-ST6-01	Aug. 20, 2004

- NOTE:** 1. The calibration interval of the above test instruments is 12 months. And the calibrations are traceable to NML/ROC and NIST/USA.
2. "*" = These equipment are used for the final measurement.
3. The horn antenna and HP preamplifier (model: 8449B) are used only for the measurement of emission frequency above 1GHz if tested.
4. The test was performed in ADT Open Site No. 6.
5. The VCCI Site Registration No. is R-728.



4.2.3 TEST PROCEDURES

- a. The EUT was placed on the top of a rotating table 0.8 meters above the ground at a 10 meter open area test site. The table was rotated 360 degrees to determine the position of the highest radiation.
- b. The EUT was set 3 meters away from the interference-receiving antenna, which was mounted on the top of a variable-height antenna tower.
- c. The antenna is a broadband antenna, and its height is varied from one meter to four meters above the ground to determine the maximum value of the field strength. Both horizontal and vertical polarizations of the antenna are set to make the measurement.
- d. For each suspected emission, the EUT was arranged to its worst case and then the antenna was tuned to heights from 1 meter to 4 meters and the rotatable table was turned from 0 degrees to 360 degrees to find the maximum reading.
- e. The test-receiver system was set to Peak Detect Function and Specified Bandwidth with Maximum Hold Mode.
- f. If the emission level of the EUT in peak mode was 10 dB lower than the limit specified, then testing could be stopped and the peak values of the EUT would be reported. Otherwise the emissions that did not have 10 dB margin would be re-tested one by one using peak, quasi-peak or average method as specified and then reported in a data sheet.

NOTE:

1. The resolution bandwidth and video bandwidth of test receiver/spectrum analyzer is 120kHz for Peak detection (PK) and Quasi-peak detection (QP) at frequency below 1GHz.
2. The resolution bandwidth and video bandwidth of test receiver/spectrum analyzer is 1 MHz for Peak detection at frequency above 1GHz.
3. The resolution bandwidth of test receiver/spectrum analyzer is 1 MHz and the video bandwidth is 300 Hz for Average detection (AV) at frequency above 1GHz.

4.2.4 DEVIATION FROM TEST STANDARD

No deviation

4.2.5 TEST SETUP

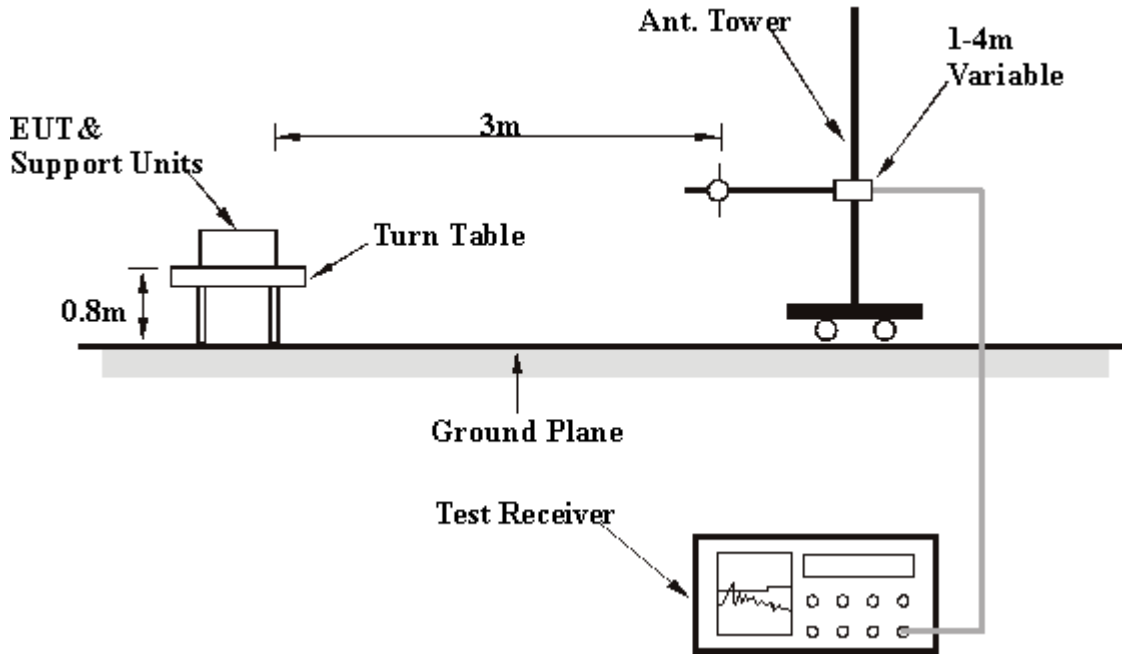

For the actual test configuration, please refer to the related item – Photographs of the Test Configuration.

4.2.6 EUT OPERATING CONDITIONS

Same as 4.1.6



4.2.7 TEST RESULTS

EUT	AirPlus Xtreme G™ Wireless Router	MODEL	DI-624
CHANNEL	Channel 11	FREQUENCY RANGE	Below 1000MHz
INPUT POWER (SYSTEM)	120Vac, 60 Hz	DETECTOR FUNCTION	Quasi-Peak
ENVIRONMENTAL CONDITIONS	25deg. C, 55%RH, 991hPa	TESTED BY: Steven Lu	

ANTENNA POLARITY & TEST DISTANCE: HORIZONTAL AT 3 M								
No.	Freq. (MHz)	Emission Level (dBuV/m)	Limit (dBuV/m)	Margin (dB)	Antenna Height (m)	Table Angle (Degree)	Raw Value (dBuV)	Correction Factor (dB/m)
1	250.94	30.2 QP	46.00	-15.79	1.50 H	286	16.81	13.40
2	351.18	37.0 QP	46.00	-8.96	1.00 H	88	20.59	16.45
3	375.97	35.3 QP	46.00	-10.70	1.50 H	166	18.21	17.09
4	451.41	33.1 QP	46.00	-12.89	1.00 H	220	13.79	19.32
5	500.99	36.8 QP	46.00	-9.18	1.00 H	160	16.78	20.03
6	540.87	30.4 QP	46.00	-15.61	1.50 H	208	9.47	20.92
7	576.43	29.4 QP	46.00	-16.56	1.50 H	208	7.54	21.90
8	775.82	32.6 QP	46.00	-13.40	1.00 H	244	7.11	25.49
9	811.39	40.2 QP	46.00	-5.84	1.00 H	166	14.42	25.74
10	900.84	34.5 QP	46.00	-11.46	1.00 H	262	7.39	27.15

ANTENNA POLARITY & TEST DISTANCE: VERTICAL AT 3 M								
No.	Freq. (MHz)	Emission Level (dBuV/m)	Limit (dBuV/m)	Margin (dB)	Antenna Height (m)	Table Angle (Degree)	Raw Value (dBuV)	Correction Factor (dB/m)
1	250.94	42.7 QP	46.00	-3.27	1.00 V	256	29.33	13.40
2	351.18	29.8 QP	46.00	-16.25	1.25 V	154	13.30	16.45
3	375.97	29.1 QP	46.00	-16.93	1.25 V	280	11.98	17.09
4	451.41	33.0 QP	46.00	-12.99	1.00 V	100	13.69	19.32
5	500.99	33.4 QP	46.00	-12.56	1.25 V	196	13.41	20.03
6	540.87	33.8 QP	46.00	-12.18	1.00 V	10	12.90	20.92
7	631.40	31.5 QP	46.00	-14.46	1.00 V	274	8.53	23.01
8	720.86	37.6 QP	46.00	-8.42	1.00 V	250	13.02	24.55
9	811.39	39.2 QP	46.00	-6.83	1.00 V	184	13.43	25.74
10	900.84	35.4 QP	46.00	-10.62	1.00 V	136	8.23	27.15
11	991.38	35.6 QP	54.00	-18.36	1.00 V	220	7.74	27.89

- REMARKS:**
1. Emission level(dBuV/m)=Raw Value(dBuV) + Correction Factor(dB/m)
 2. Correction Factor(dB/m) = Antenna Factor (dB/m) + Cable Factor (dB)
 3. The other emission levels were very low against the limit.
 4. Margin value = Emission level – Limit value.



EUT	AirPlus Xtreme G™ Wireless Router	MODEL	DI-624
CHANNEL	Channel 1	FREQUENCY RANGE	Above 1000MHz
MODE	CCK		
INPUT POWER (SYSTEM)	120Vac, 60 Hz	DETECTOR FUNCTION	Peak(PK) Average (AV)
ENVIRONMENTAL CONDITIONS	25deg. C, 55%RH, 991hPa	TESTED BY: Steven Lu	

ANTENNA POLARITY & TEST DISTANCE: HORIZONTAL AT 3 M

No.	Freq. (MHz)	Emission Level (dBuV/m)	Limit (dBuV/m)	Margin (dB)	Antenna Height (m)	Table Angle (Degree)	Raw Value (dBuV)	Correction Factor (dB/m)
1	2320.00	54.8 PK	74.00	-19.25	1.22 H	144	23.45	31.30
1	2320.00	38.4 AV	54.00	-15.63	1.22 H	144	7.07	31.30
2	*2412.00	104.3 PK			1.22 H	144	72.74	31.56
2	*2412.00	96.6 AV			1.22 H	144	65.01	31.56
3	2688.00	56.4 PK	74.00	-17.57	1.22 H	144	23.81	32.62
3	2688.00	40.1 AV	54.00	-13.86	1.22 H	144	7.52	32.62
4	4824.00	48.5 PK	74.00	-25.54	1.14 H	203	10.03	38.43
4	4824.00	35.50 AV	54.00	-18.50	1.14 H	203	-2.93	38.43

ANTENNA POLARITY & TEST DISTANCE: VERTICAL AT 3 M

No.	Freq. (MHz)	Emission Level (dBuV/m)	Limit (dBuV/m)	Margin (dB)	Antenna Height (m)	Table Angle (Degree)	Raw Value (dBuV)	Correction Factor (dB/m)
1	2320.00	56.7 PK	74.00	-17.35	1.24 V	118	25.35	31.30
1	2320.00	48.0 AV	54.00	-6.00	1.24 V	118	16.70	31.30
2	*2412.00	112.9 PK			1.24 V	118	81.37	31.56
2	*2412.00	106.2 AV			1.24 V	118	74.64	31.56
3	2688.00	65.1 PK	74.00	-8.94	1.24 V	118	32.44	32.62
3	2688.00	50.2 AV	54.00	-3.83	1.24 V	118	17.55	32.62
4	4824.00	50.2 PK	74.00	-23.80	1.57 V	324	11.76	38.43
4	4824.00	36.9 AV	54.00	-17.10	1.57 V	324	-1.54	38.43
5	7236.00	54.7 PK	74.00	-19.30	1.18 V	68	12.49	42.21
5	7236.00	41.4 AV	54.00	-12.58	1.18 V	68	-0.79	42.21
6	9648.00	59.1 PK	74.00	-14.89	1.47 V	253	14.87	44.24
6	9648.00	43.7 AV	54.00	-10.28	1.47 V	253	-0.52	44.24

- REMARKS:**
1. Emission level(dBuV/m)=Raw Value(dBuV) + Correction Factor(dB)
 2. Correction Factor(dB/m) = Antenna Factor (dB/m) + Cable Factor (dB)
 3. The other emission levels were very low against the limit.
 4. Margin value = Emission level – Limit value.
 5. “ * “ : Fundamental frequency.



EUT	AirPlus Xtreme G™ Wireless Router	MODEL	DI-624
CHANNEL	Channel 6	FREQUENCY RANGE	Above 1000MHz
MODE	CCK		
INPUT POWER (SYSTEM)	120Vac, 60 Hz	DETECTOR FUNCTION	Peak(PK) Average (AV)
ENVIRONMENTAL CONDITIONS	25deg. C, 55%RH, 991hPa	TESTED BY: Steven Lu	

ANTENNA POLARITY & TEST DISTANCE: HORIZONTAL AT 3 M

No.	Freq. (MHz)	Emission Level (dBuV/m)	Limit (dBuV/m)	Margin (dB)	Antenna Height (m)	Table Angle (Degree)	Raw Value (dBuV)	Correction Factor (dB/m)
1	*2437.00	103.6 PK			1.02 H	129	71.96	31.64
1	*2437.00	95.9 AV			1.02 H	129	64.25	31.64
2	2688.00	47.2 PK	74.00	-26.82	1.02 H	129	14.56	32.62
2	2688.00	39.5 AV	54.00	-14.53	1.02 H	129	6.85	32.62
3	4874.00	48.9 PK	74.00	-25.12	1.24 H	239	10.41	38.46
3	4874.00	35.0 AV	54.00	-18.99	1.24 H	239	-3.46	38.46

ANTENNA POLARITY & TEST DISTANCE: VERTICAL AT 3 M

No.	Freq. (MHz)	Emission Level (dBuV/m)	Limit (dBuV/m)	Margin (dB)	Antenna Height (m)	Table Angle (Degree)	Raw Value (dBuV)	Correction Factor (dB/m)
1	*2437.00	113.7 PK			1.20 V	204	82.01	31.64
1	*2437.00	106.2 AV			1.20 V	204	74.59	31.64
2	2688.00	57.2 PK	74.00	-16.82	1.20 V	204	24.56	32.62
2	2688.00	49.8 AV	54.00	-4.24	1.20 V	204	17.14	32.62
3	4874.00	52.4 PK	74.00	-21.63	1.44 V	125	13.91	38.46
3	4874.00	37.9 AV	54.00	-16.08	1.44 V	125	-0.54	38.46
4	7311.28	56.2 PK	74.00	-17.77	1.22 V	235	13.91	42.32
4	7311.28	40.2 AV	54.00	-13.77	1.22 V	235	-2.09	42.32
5	9748.00	61.4 PK	74.00	-12.65	1.00 V	196	16.78	44.57
5	9748.00	44.4 AV	54.00	-9.64	1.00 V	196	-0.21	44.57

- REMARKS:**
1. Emission level(dBuV/m)=Raw Value(dBuV) + Correction Factor(dB)
 2. Correction Factor(dB/m) = Antenna Factor (dB/m) + Cable Factor (dB)
 3. The other emission levels were very low against the limit.
 4. Margin value = Emission level – Limit value.
 5. “ * “ : Fundamental frequency.



EUT	AirPlus Xtreme G™ Wireless Router	MODEL	DI-624
CHANNEL	Channel 11	FREQUENCY RANGE	Above 1000MHz
MODE	CCK		
INPUT POWER (SYSTEM)	120Vac, 60 Hz	DETECTOR FUNCTION	Peak(PK) Average (AV)
ENVIRONMENTAL CONDITIONS	25deg. C, 55%RH, 991hPa	TESTED BY: Steven Lu	

ANTENNA POLARITY & TEST DISTANCE: HORIZONTAL AT 3 M

No.	Freq. (MHz)	Emission Level (dBuV/m)	Limit (dBuV/m)	Margin (dB)	Antenna Height (m)	Table Angle (Degree)	Raw Value (dBuV)	Correction Factor (dB/m)
1	*2462.00	103.7 PK			1.27 H	132	71.95	31.71
1	*2462.00	96.1 AV			1.27 H	132	64.43	31.71
2	2483.50	55.0 PK	74.00	-19.02	1.27 H	132	23.21	31.77
2	2483.50	36.8 AV	54.00	-17.18	1.27 H	132	5.05	31.77
3	2688.00	55.4 PK	74.00	-18.57	1.27 H	132	22.81	32.62
3	2688.00	42.3 AV	54.00	-11.67	1.27 H	132	9.71	32.62
4	4924.00	48.7 PK	74.00	-25.30	1.24 H	24	10.20	38.49
4	4924.00	35.4 AV	54.00	-18.59	1.24 H	24	-3.09	38.49

ANTENNA POLARITY & TEST DISTANCE: VERTICAL AT 3 M

No.	Freq. (MHz)	Emission Level (dBuV/m)	Limit (dBuV/m)	Margin (dB)	Antenna Height (m)	Table Angle (Degree)	Raw Value (dBuV)	Correction Factor (dB/m)
1	*2462.00	112.8 PK			1.10 V	123	81.13	31.71
1	*2462.00	106.2 AV			1.10 V	123	74.46	31.71
2	2483.50	64.2 PK	74.00	-9.84	1.10 V	123	32.39	31.77
2	2483.50	46.9 AV	54.00	-7.15	1.10 V	123	15.08	31.77
3	2688.00	64.6 PK	74.00	-9.39	1.10 V	123	31.99	32.62
3	2688.00	52.3 AV	54.00	-1.69	1.10 V	123	19.69	32.62
4	4924.00	52.7 PK	74.00	-21.30	1.22 V	155	14.21	38.49
4	4924.00	37.9 AV	54.00	-16.07	1.22 V	155	-0.56	38.49
5	7386.00	56.4 PK	74.00	-17.65	1.03 V	188	13.91	42.44
5	7386.00	41.0 AV	54.00	-13.05	1.03 V	188	-1.49	42.44
6	9848.11	61.2 PK	74.00	-12.85	1.82 V	132	16.39	44.76
6	9848.11	44.5 AV	54.00	-9.47	1.82 V	132	-0.23	44.76

- REMARKS:**
1. Emission level(dBuV/m)=Raw Value(dBuV) + Correction Factor(dB)
 2. Correction Factor(dB/m) = Antenna Factor (dB/m) + Cable Factor (dB)
 3. The other emission levels were very low against the limit.
 4. Margin value = Emission level – Limit value.
 5. “ * “ : Fundamental frequency.



EUT	AirPlus Xtreme G™ Wireless Router	MODEL	DI-624
CHANNEL	Channel 1	FREQUENCY RANGE	Above 1000MHz
MODE	OFDM		
INPUT POWER (SYSTEM)	120Vac, 60 Hz	DETECTOR FUNCTION	Peak(PK) Average (AV)
ENVIRONMENTAL CONDITIONS	25deg. C, 55%RH, 991hPa	TESTED BY: Steven Lu	

ANTENNA POLARITY & TEST DISTANCE: HORIZONTAL AT 3 M

No.	Freq. (MHz)	Emission Level (dBuV/m)	Limit (dBuV/m)	Margin (dB)	Antenna Height (m)	Table Angle (Degree)	Raw Value (dBuV)	Correction Factor (dB/m)
1	2320.00	57.5 PK	74.00	-16.54	1.08 H	227	26.16	31.30
1	2320.00	38.9 AV	54.00	-15.15	1.08 H	227	7.55	31.30
2	*2412.00	99.1 PK			1.08 H	227	67.52	31.56
2	*2412.00	88.4 AV			1.08 H	227	56.88	31.56
3	2688.00	53.2 PK	74.00	-20.85	1.08 H	227	20.53	32.62
3	2688.00	40.0 AV	54.00	-14.01	1.08 H	227	7.37	32.62
4	4924.00	47.1 PK	74.00	-26.86	1.14 H	225	8.64	38.49
4	4924.00	36.1 AV	54.00	-17.92	1.14 H	225	-2.42	38.49

ANTENNA POLARITY & TEST DISTANCE: VERTICAL AT 3 M

No.	Freq. (MHz)	Emission Level (dBuV/m)	Limit (dBuV/m)	Margin (dB)	Antenna Height (m)	Table Angle (Degree)	Raw Value (dBuV)	Correction Factor (dB/m)
1	2320.00	64.5 PK	74.00	-9.49	1.27 V	111	33.21	31.30
1	2320.00	46.9 AV	54.00	-7.09	1.27 V	111	15.61	31.30
2	*2412.00	106.1 PK			1.27 V	111	74.57	31.56
2	*2412.00	96.5 AV			1.27 V	111	64.94	31.56
3	2688.00	60.2 PK	74.00	-13.80	1.27 V	111	27.58	32.62
3	2688.00	48.1 AV	54.00	-5.95	1.27 V	111	15.43	32.62
4	4824.00	48.5 PK	74.00	-25.54	1.27 V	182	10.03	38.43
4	4824.00	36.4 AV	54.00	-17.65	1.27 V	182	-2.08	38.43

- REMARKS:**
1. Emission level(dBuV/m)=Raw Value(dBuV) + Correction Factor(dB)
 2. Correction Factor(dB/m) = Antenna Factor (dB/m) + Cable Factor (dB)
 3. The other emission levels were very low against the limit.
 4. Margin value = Emission level – Limit value.
 5. “ * “ : Fundamental frequency.



EUT	AirPlus Xtreme G™ Wireless Router	MODEL	DI-624
CHANNEL	Channel 6	FREQUENCY RANGE	Above 1000MHz
MODE	OFDM		
INPUT POWER (SYSTEM)	120Vac, 60 Hz	DETECTOR FUNCTION	Peak(PK) Average (AV)
ENVIRONMENTAL CONDITIONS	25deg. C, 55%RH, 991hPa	TESTED BY: Steven Lu	

ANTENNA POLARITY & TEST DISTANCE: HORIZONTAL AT 3 M

No.	Freq. (MHz)	Emission Level (dBuV/m)	Limit (dBuV/m)	Margin (dB)	Antenna Height (m)	Table Angle (Degree)	Raw Value (dBuV)	Correction Factor (dB/m)
1	*2437.00	98.6 PK			1.10 H	234	66.99	31.64
1	*2437.00	87.8 AV			1.10 H	234	56.12	31.64
2	2688.00	51.7 PK	74.00	-22.29	1.10 H	234	19.09	32.62
2	2688.00	39.6 AV	54.00	-14.38	1.10 H	234	7.00	32.62
3	4874.00	46.1 PK	74.00	-27.90	1.14 H	225	7.63	38.46
3	4874.00	34.8 AV	54.00	-19.22	1.14 H	225	-3.69	38.46

ANTENNA POLARITY & TEST DISTANCE: VERTICAL AT 3 M

No.	Freq. (MHz)	Emission Level (dBuV/m)	Limit (dBuV/m)	Margin (dB)	Antenna Height (m)	Table Angle (Degree)	Raw Value (dBuV)	Correction Factor (dB/m)
1	*2437.00	107.3 PK			1.28 V	114	75.62	31.64
1	*2437.00	97.6 AV			1.28 V	114	65.96	31.64
2	2688.00	60.3 PK	74.00	-13.66	1.28 V	114	27.72	32.62
2	2688.00	49.5 AV	54.00	-4.54	1.28 V	114	16.84	32.62
3	4874.00	49.5 PK	74.00	-24.48	1.44 V	122	11.05	38.46
3	4874.00	37.8 AV	54.00	-16.19	1.44 V	122	-0.66	38.46

- REMARKS:**
1. Emission level(dBuV/m)=Raw Value(dBuV) + Correction Factor(dB)
 2. Correction Factor(dB/m) = Antenna Factor (dB/m) + Cable Factor (dB)
 3. The other emission levels were very low against the limit.
 4. Margin value = Emission level – Limit value.
 5. “ * “ : Fundamental frequency.



EUT	AirPlus Xtreme G™ Wireless Router	MODEL	DI-624
CHANNEL	Channel 11	FREQUENCY RANGE	Above 1000MHz
MODE	OFDM		
INPUT POWER (SYSTEM)	120Vac, 60 Hz	DETECTOR FUNCTION	Peak(PK) Average (AV)
ENVIRONMENTAL CONDITIONS	25deg. C, 55%RH, 991hPa	TESTED BY: Steven Lu	

ANTENNA POLARITY & TEST DISTANCE: HORIZONTAL AT 3 M

No.	Freq. (MHz)	Emission Level (dBuV/m)	Limit (dBuV/m)	Margin (dB)	Antenna Height (m)	Table Angle (Degree)	Raw Value (dBuV)	Correction Factor (dB/m)
1	*2462.00	100.2 PK			1.07 H	227	68.49	31.71
1	*2462.00	89.2 AV			1.07 H	227	57.47	31.71
2	2483.50	59.8 PK	74.00	-14.18	1.07 H	227	28.05	31.77
2	2483.50	38.9 AV	54.00	-15.09	1.07 H	227	7.14	31.77
3	2688.00	54.5 PK	74.00	-19.49	1.07 H	227	21.89	32.62
3	2688.00	42.7 AV	54.00	-11.35	1.07 H	227	10.03	32.62
4	4924.00	47.9 PK	74.00	-26.08	1.24 H	220	9.42	38.49
4	4924.00	36.1 AV	54.00	-17.92	1.24 H	220	-2.42	38.49

ANTENNA POLARITY & TEST DISTANCE: VERTICAL AT 3 M

No.	Freq. (MHz)	Emission Level (dBuV/m)	Limit (dBuV/m)	Margin (dB)	Antenna Height (m)	Table Angle (Degree)	Raw Value (dBuV)	Correction Factor (dB/m)
1	*2462.00	107.2 PK			1.24 V	115	75.52	31.71
1	*2462.00	97.1 AV			1.24 V	115	65.34	31.71
2	2483.50	66.9 PK	74.00	-7.15	1.24 V	115	35.08	31.77
2	2483.50	46.8 AV	54.00	-7.22	1.24 V	115	15.01	31.77
3	2688.00	61.4 PK	74.00	-12.56	1.24 V	115	28.82	32.62
3	2688.00	50.5 AV	54.00	-3.50	1.24 V	115	17.88	32.62
4	4924.00	49.1 PK	74.00	-24.91	1.14 V	220	10.59	38.49
4	4924.00	37.13 AV	54.00	-16.87	1.14 V	220	-1.37	38.49

- REMARKS:**
1. Emission level(dBuV/m)=Raw Value(dBuV) + Correction Factor(dB)
 2. Correction Factor(dB/m) = Antenna Factor (dB/m) + Cable Factor (dB)
 3. The other emission levels were very low against the limit.
 4. Margin value = Emission level – Limit value.
 5. “ * “ : Fundamental frequency.

4.3 6dB BANDWIDTH MEASUREMENT

4.3.1 LIMITS OF 6dB BANDWIDTH MEASUREMENT

The minimum of 6dB Bandwidth Measurement is 0.5 MHz.

4.3.2 TEST INSTRUMENTS

Description & Manufacturer	Model No.	Serial No.	Calibrated Until
R&S SPECTRUM ANALYZER	FSEK30	100049	Aug. 12, 2004

NOTE: The calibration interval of the above test instruments is 12 months and the calibrations are traceable to NML/ROC and NIST/USA.

4.3.3 TEST PROCEDURE

The transmitter output was connected to the spectrum analyzer through an attenuator. The bandwidth of the fundamental frequency was measured by spectrum analyzer with 100kHz RBW and 100kHz VBW. The 6dB bandwidth is defined as the total spectrum the power of which is higher than peak power minus 6dB.

4.3.4 DEVIATION FROM TEST STANDARD

No deviation

4.3.5 TEST SETUP

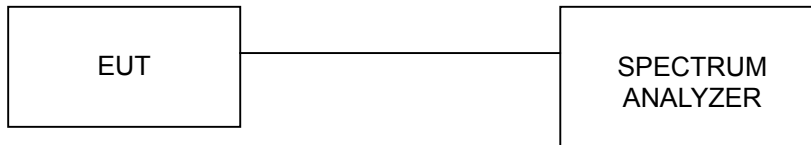

For the actual test configuration, please refer to the related Item – Photographs of the Test Configuration.

4.3.6 EUT OPERATING CONDITIONS

The software provided by client to enable the EUT under transmission condition continuously at lowest, middle and highest channel frequencies individually.



4.3.7 TEST RESULTS

EUT	AirPlus Xtreme G™ Wireless Router	MODEL	DI-624
MODE	CCK	INPUT POWER (SYSTEM)	120Vac, 60 Hz
ENVIRONMENTAL CONDITIONS	25deg. C, 60%RH, 991hPa	TESTED BY	Jamison Chan

CHANNEL	CHANNEL FREQUENCY (MHz)	6dB BANDWIDTH (MHz)	MINIMUM LIMIT (MHz)	PASS/FAIL
1	2412	12.60	0.5	PASS
6	2437	11.96	0.5	PASS
11	2462	11.96	0.5	PASS



CH1

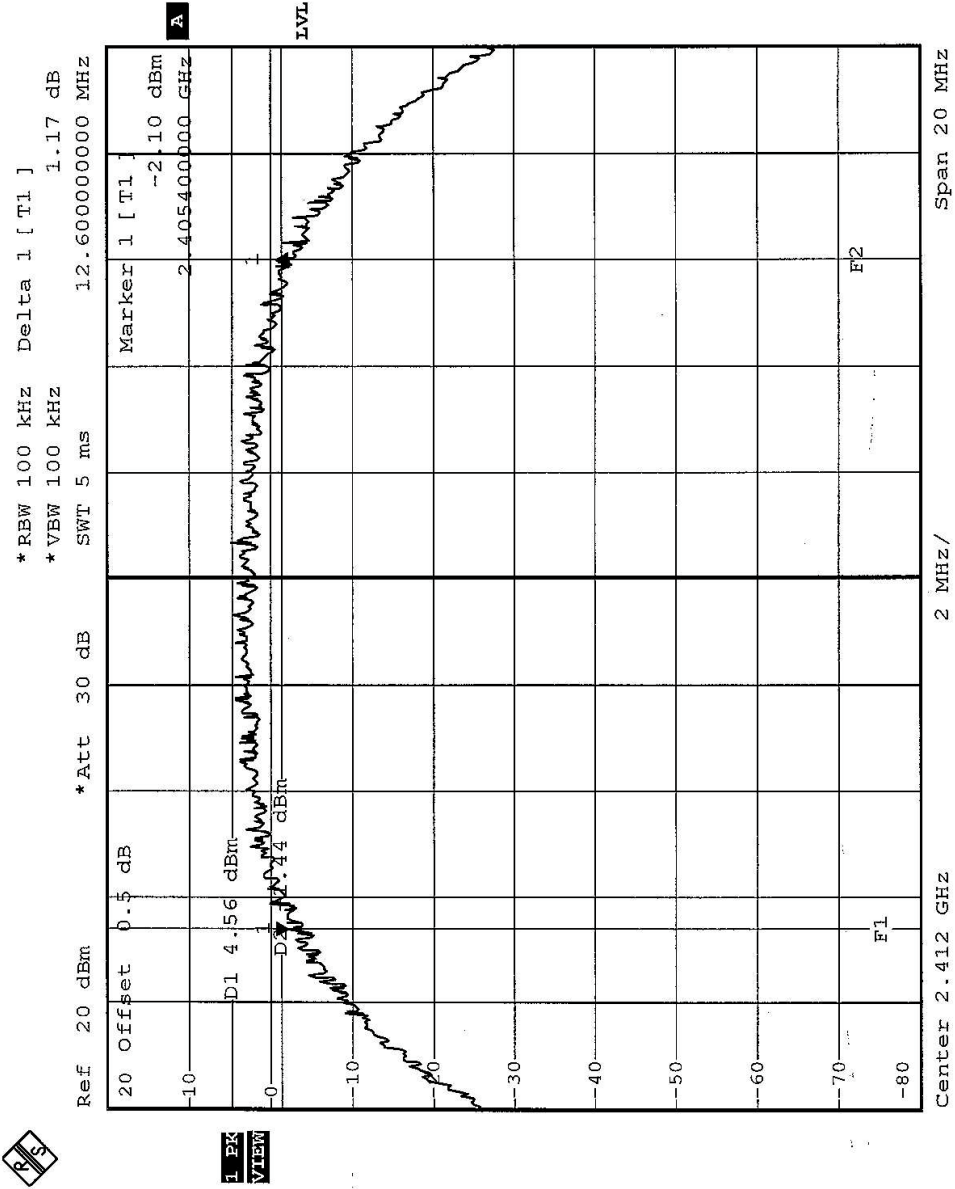



CH6

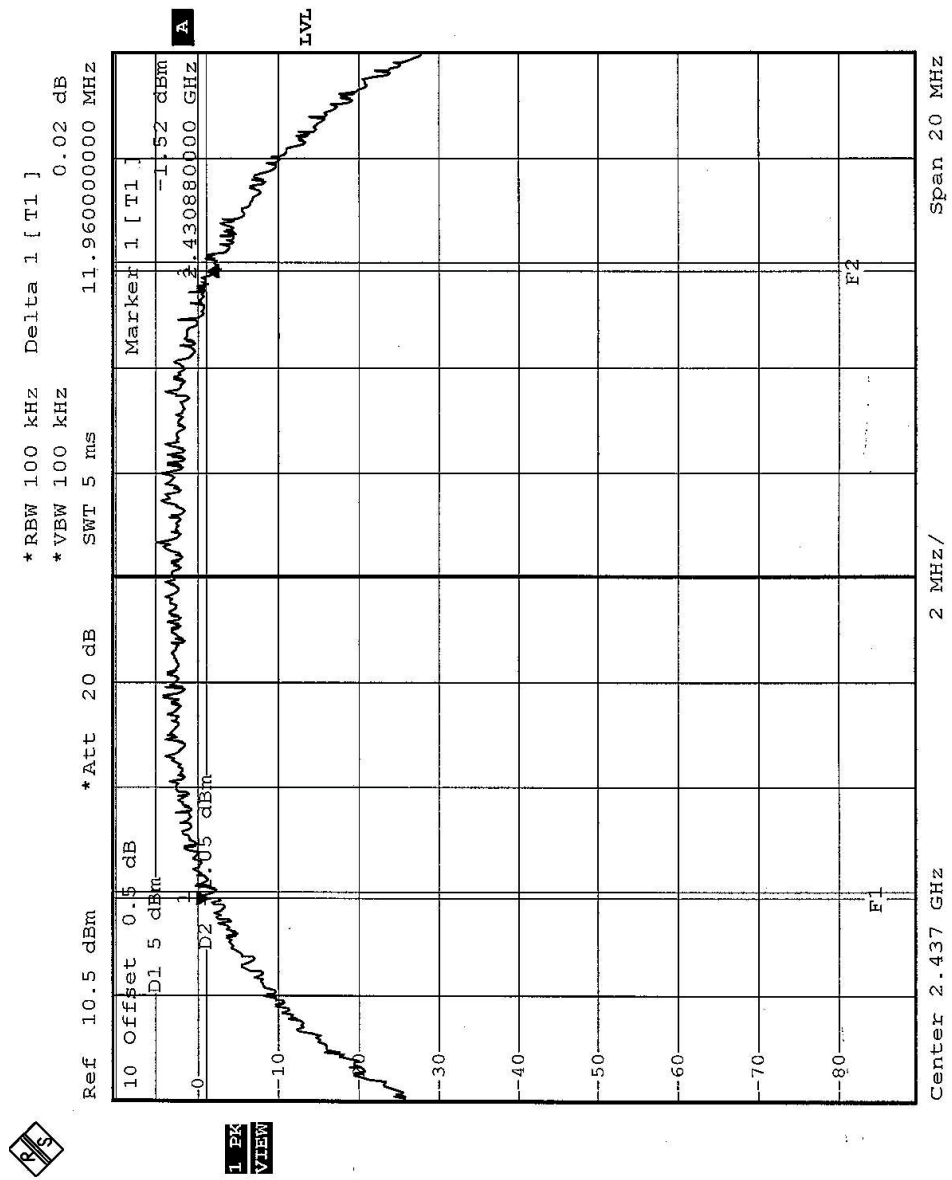



CH11

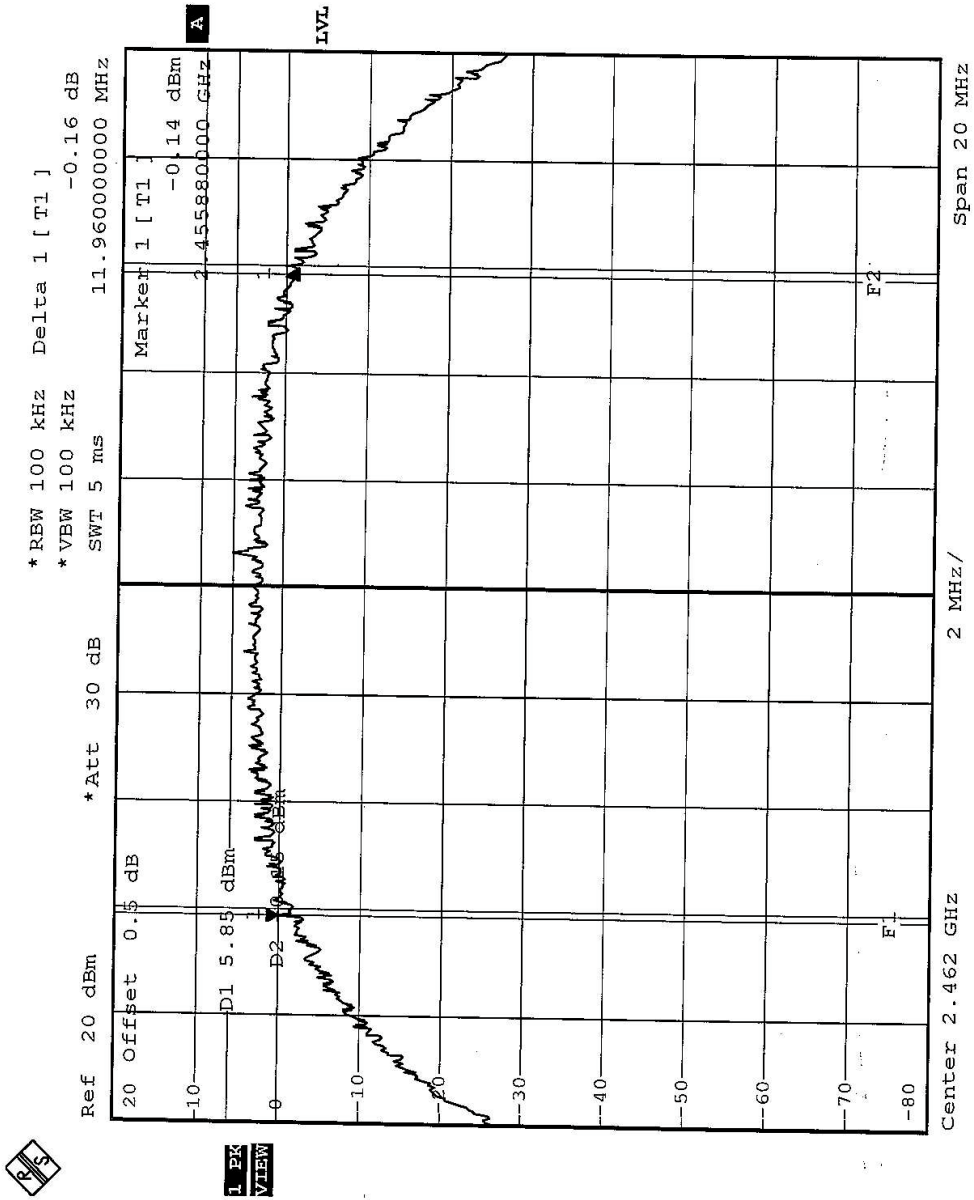

1 PK VIEW



EUT	AirPlus Xtreme G™ Wireless Router	MODEL	DI-624
MODE	OFDM	INPUT POWER (SYSTEM)	120Vac, 60 Hz
ENVIRONMENTAL CONDITIONS	25deg. C, 60%RH, 991hPa	TESTED BY	Jamison Chan

CHANNEL	CHANNEL FREQUENCY (MHz)	6dB BANDWIDTH (MHz)	MINIMUM LIMIT (MHz)	PASS/FAIL
1	2412	16.44	0.5	PASS
6	2437	16.48	0.5	PASS
11	2462	16.40	0.5	PASS



CH1

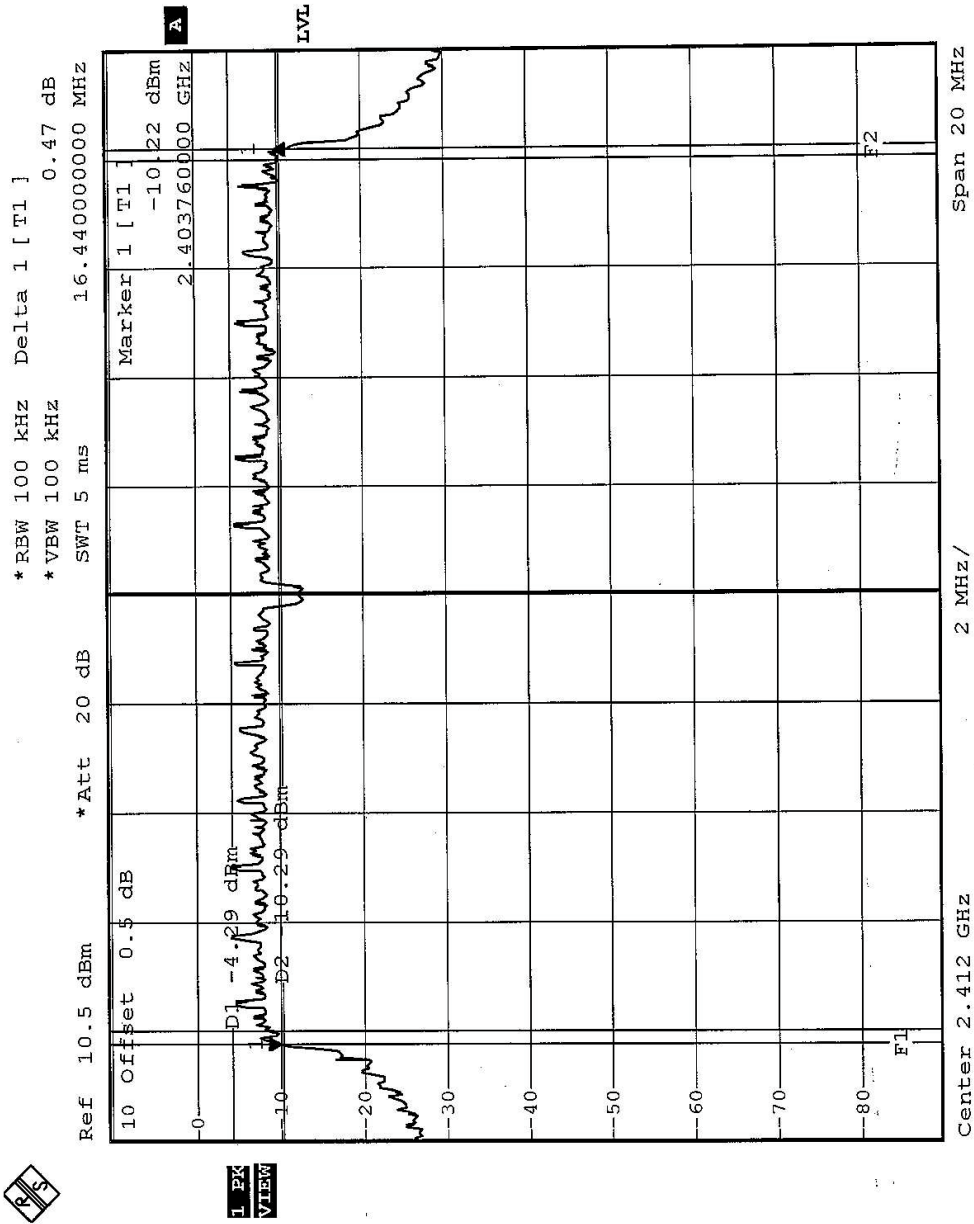

L PK VIEW



CH6

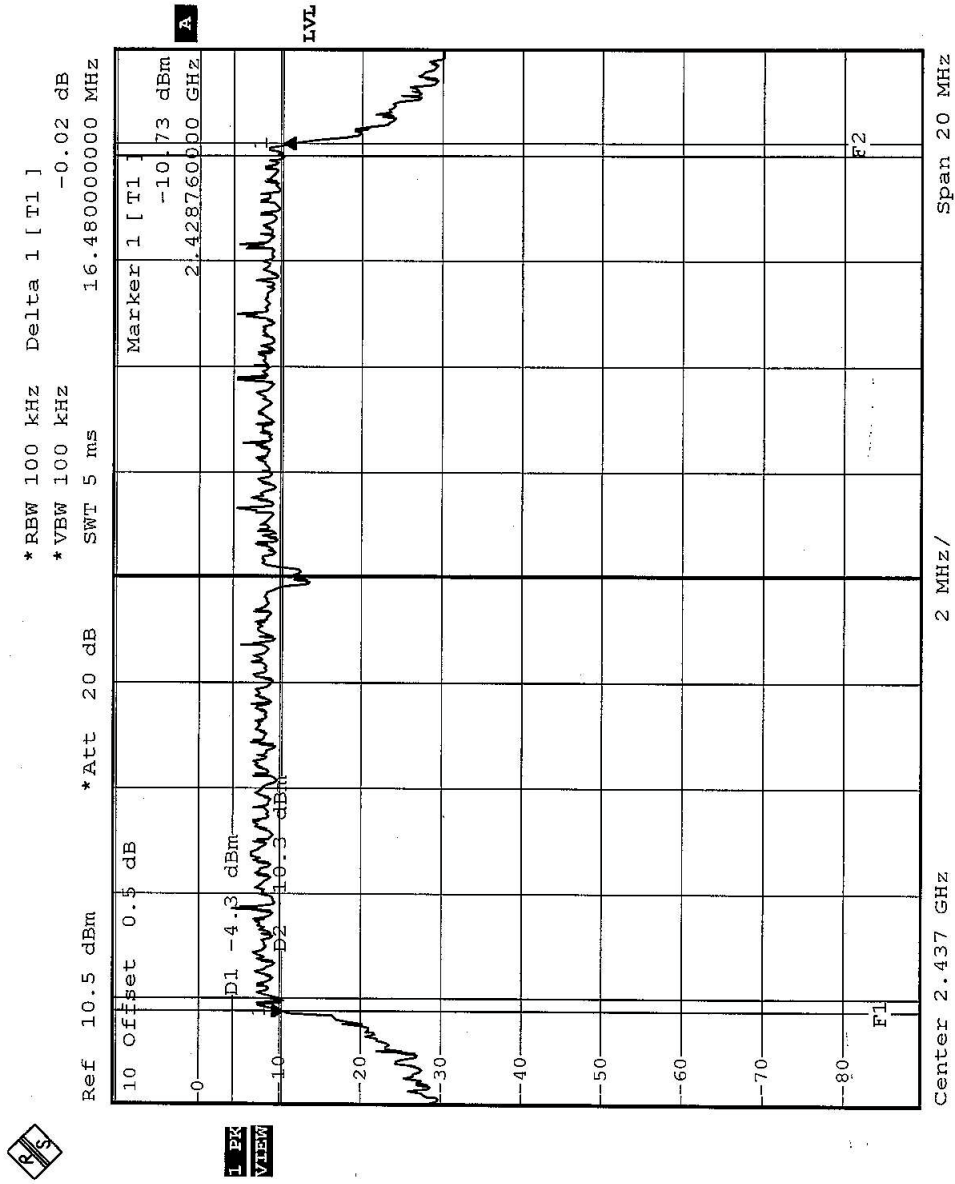



CH11

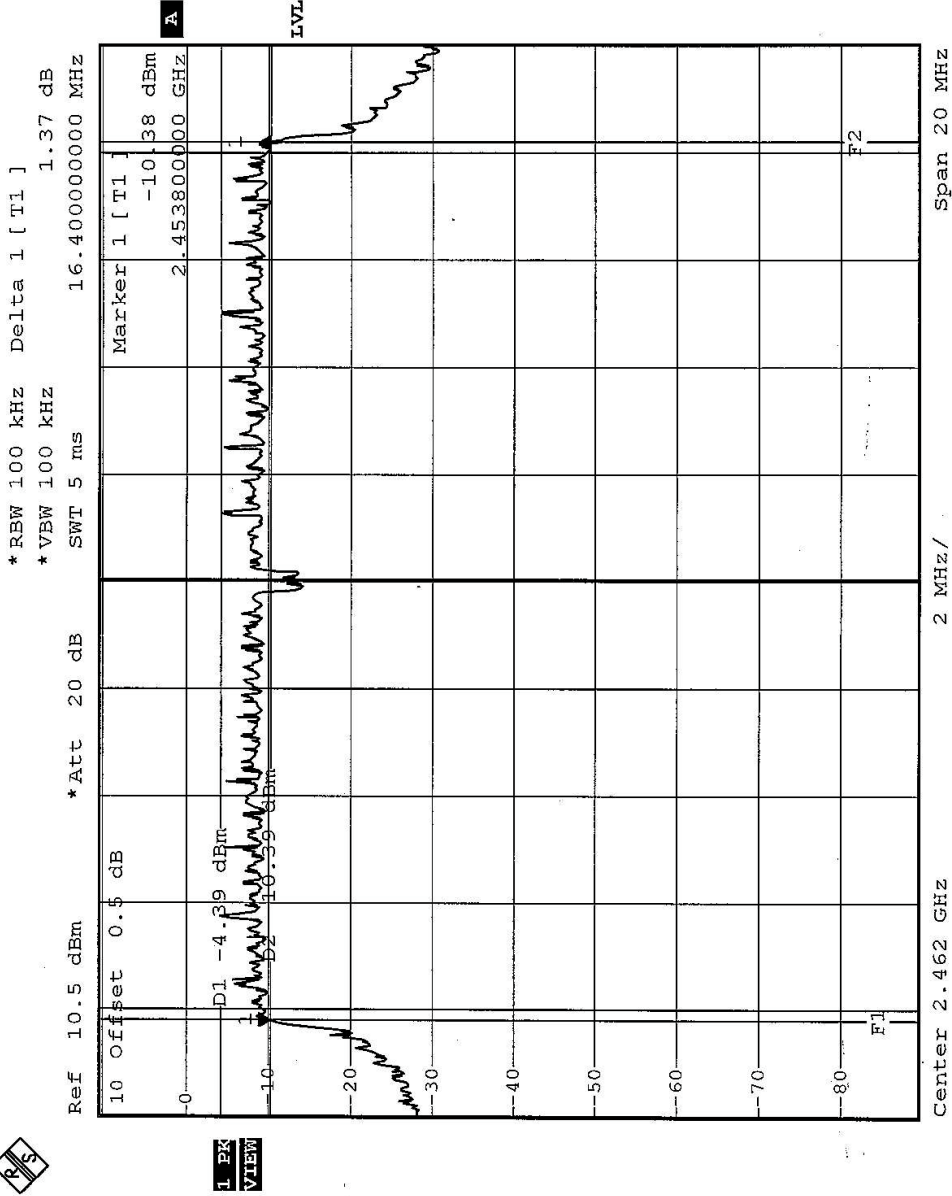



4.4 MAXIMUM PEAK OUTPUT POWER

4.4.1 LIMITS OF MAXIMUM PEAK OUTPUT POWER MEASUREMENT

The Maximum Peak Output Power Measurement is 30dBm.

4.4.2 TEST INSTRUMENTS

Description & Manufacturer	Model No.	Serial No.	Calibrated Until
R&S SPECTRUM ANALYZER	FSEK30	100049	Aug. 12, 2004
R&S SIGNAL GENERATOR	SMP04	100011	May 28, 2004
TEKTRONIX OSCILLOSCOPE	TDS 220	B048470	Mar. 05, 2004
NARDA DETECTOR	4503A	FSCM99899	NA

NOTE: The calibration interval of the above test instruments is 12 months and the calibrations are traceable to NML/ROC and NIST/USA..

4.4.3 TEST PROCEDURES

1. A detector was used on the output port of the EUT. An oscilloscope was used to read the response of the detector.
2. Replaced the EUT by the signal generator. The center frequency of the S.G was adjusted to the center frequency of the measured channel.
3. Adjusted the power to have the same reading on oscilloscope. Record the power level.

4.4.4 DEVIATION FROM TEST STANDARD

No deviation

4.4.5 TEST SETUP



4.4.6 EUT OPERATING CONDITIONS

Same as Item 4.3.6.



4.4.7 TEST RESULTS

EUT	AirPlus Xtreme G™ Wireless Router	MODEL	DI-624
MODE	CCK	INPUT POWER (SYSTEM)	120Vac, 60 Hz
ENVIRONMENTAL CONDITIONS	25deg. C, 60%RH, 991hPa	TESTED BY	Jamison Chan

CHANNEL	CHANNEL FREQUENCY (MHz)	PEAK POWER OUTPUT (dBm)	PEAK POWER LIMIT (dBm)	PASS/FAIL
1	2412	17.14	30	PASS
6	2437	17.00	30	PASS
11	2462	17.08	30	PASS

EUT	AirPlus Xtreme G™ Wireless Router	MODEL	DI-624
MODE	OFDM	INPUT POWER (SYSTEM)	120Vac, 60 Hz
ENVIRONMENTAL CONDITIONS	25deg. C, 60%RH, 991hPa	TESTED BY	Jamison Chan

CHANNEL	CHANNEL FREQUENCY (MHz)	PEAK POWER OUTPUT (dBm)	PEAK POWER LIMIT (dBm)	PASS/FAIL
1	2412	17.12	30	PASS
6	2437	17.04	30	PASS
11	2462	17.02	30	PASS



4.5 POWER SPECTRAL DENSITY MEASUREMENT

4.5.1 LIMITS OF POWER SPECTRAL DENSITY MEASUREMENT

The Maximum of Power Spectral Density Measurement is 8dBm.

4.5.2 TEST INSTRUMENTS

Description & Manufacturer	Model No.	Serial No.	Calibrated Until
R&S SPECTRUM ANALYZER	FSEK30	100049	Aug. 12, 2004

NOTE: The calibration interval of the above test instruments is 12 months and the calibrations are traceable to NML/ROC and NIST/USA.

4.5.3 TEST PROCEDURE

The transmitter output was connected to the spectrum analyzer through an attenuator, the bandwidth of the fundamental frequency was measured with the spectrum analyzer using 3kHz RBW and 30kHz VBW, set sweep time=span/3kHz. The power spectral density was measured and recorded. The sweep time is allowed to be longer than span/3KHz for a full response of the mixer in the spectrum analyzer.

4.5.4 DEVIATION FROM TEST STANDARD

No deviation

4.5.5 TEST SETUP

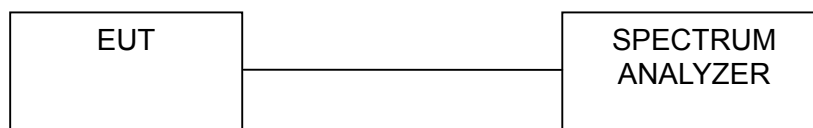

4.5.6 EUT OPERATING CONDITIONS

Same as 4.3.6



4.5.7 TEST RESULTS

EUT	AirPlus Xtreme G™ Wireless Router	MODEL	DI-624
MODE	CCK	INPUT POWER (SYSTEM)	120Vac, 60 Hz
ENVIRONMENTAL CONDITIONS	25deg. C, 60%RH, 991hPa	TESTED BY	Jamison Chan

CHANNEL	CHANNEL FREQUENCY (MHz)	RF POWER LEVEL IN 3kHz BW (dBm)	MAXIMUM LIMIT (dBm)	PASS/FAIL
1	2412	-5.65	8	PASS
6	2437	-7.01	8	PASS
11	2462	-4.63	8	PASS



CH1

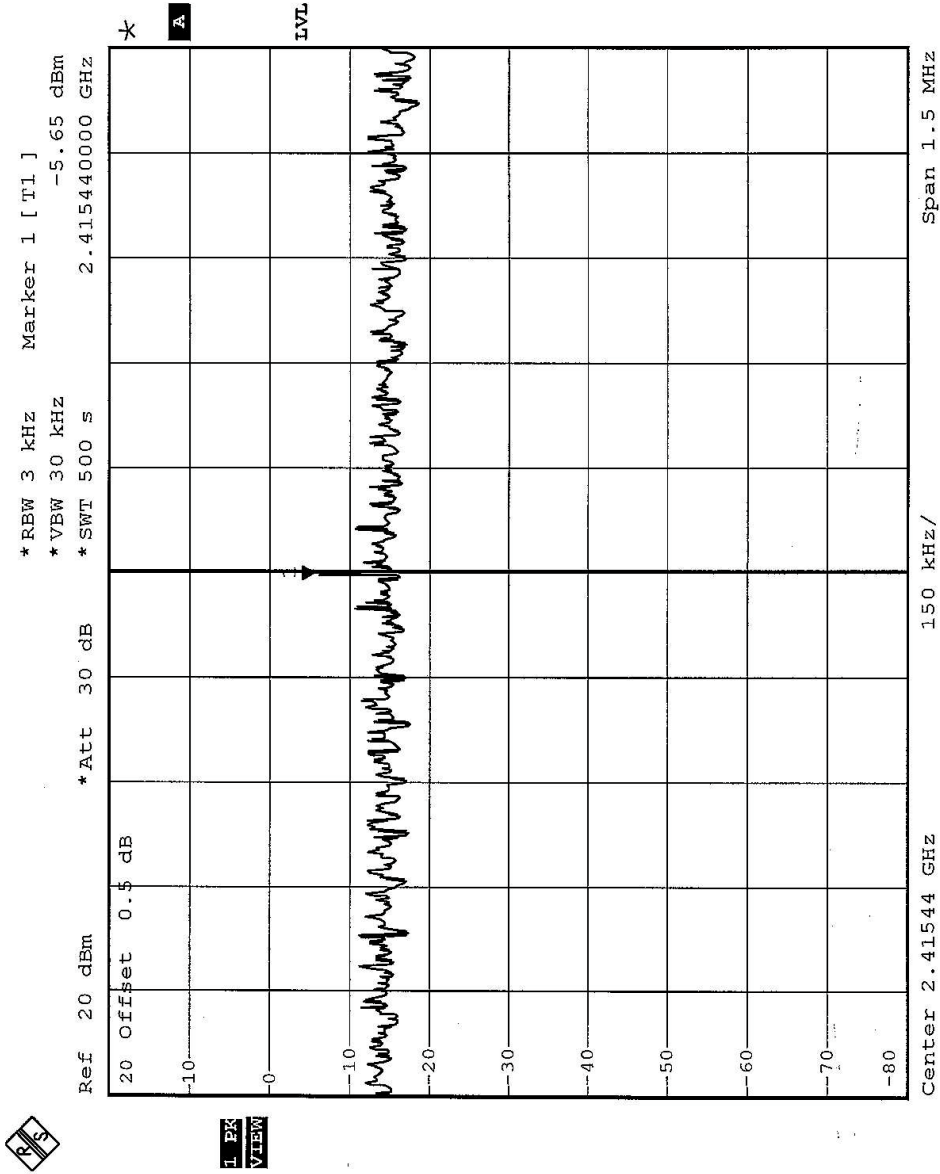



CH6

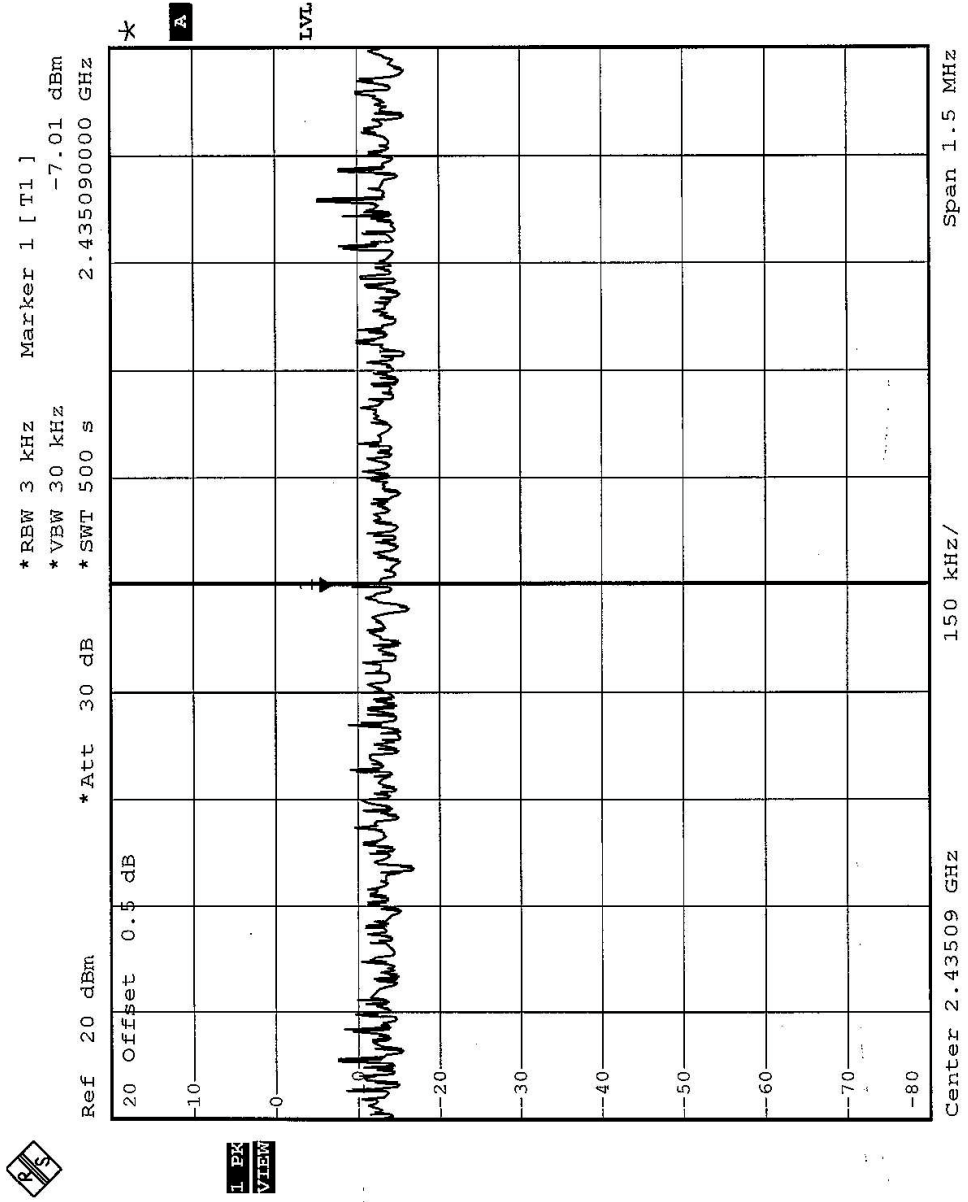



CH11

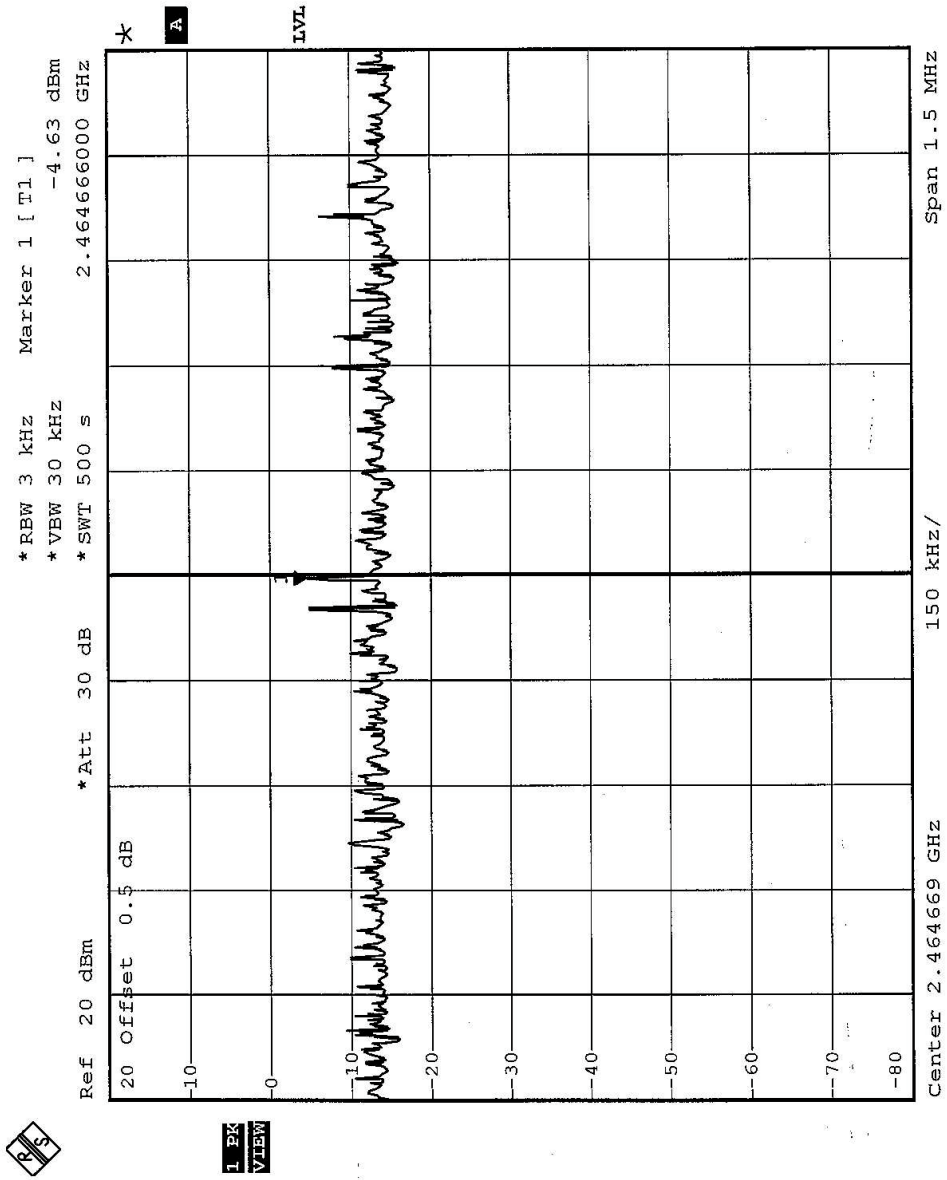



EUT	AirPlus Xtreme G™ Wireless Router	MODEL	DI-624
MODE	OFDM	INPUT POWER (SYSTEM)	120Vac, 60 Hz
ENVIRONMENTAL CONDITIONS	25deg. C, 60%RH, 991hPa	TESTED BY	Jamison Chan

CHANNEL	CHANNEL FREQUENCY (MHz)	RF POWER LEVEL IN 3kHz BW (dBm)	MAXIMUM LIMIT (dBm)	PASS/FAIL
1	2412	-18.43	8	PASS
6	2437	-17.28	8	PASS
11	2462	-18.76	8	PASS



CH1

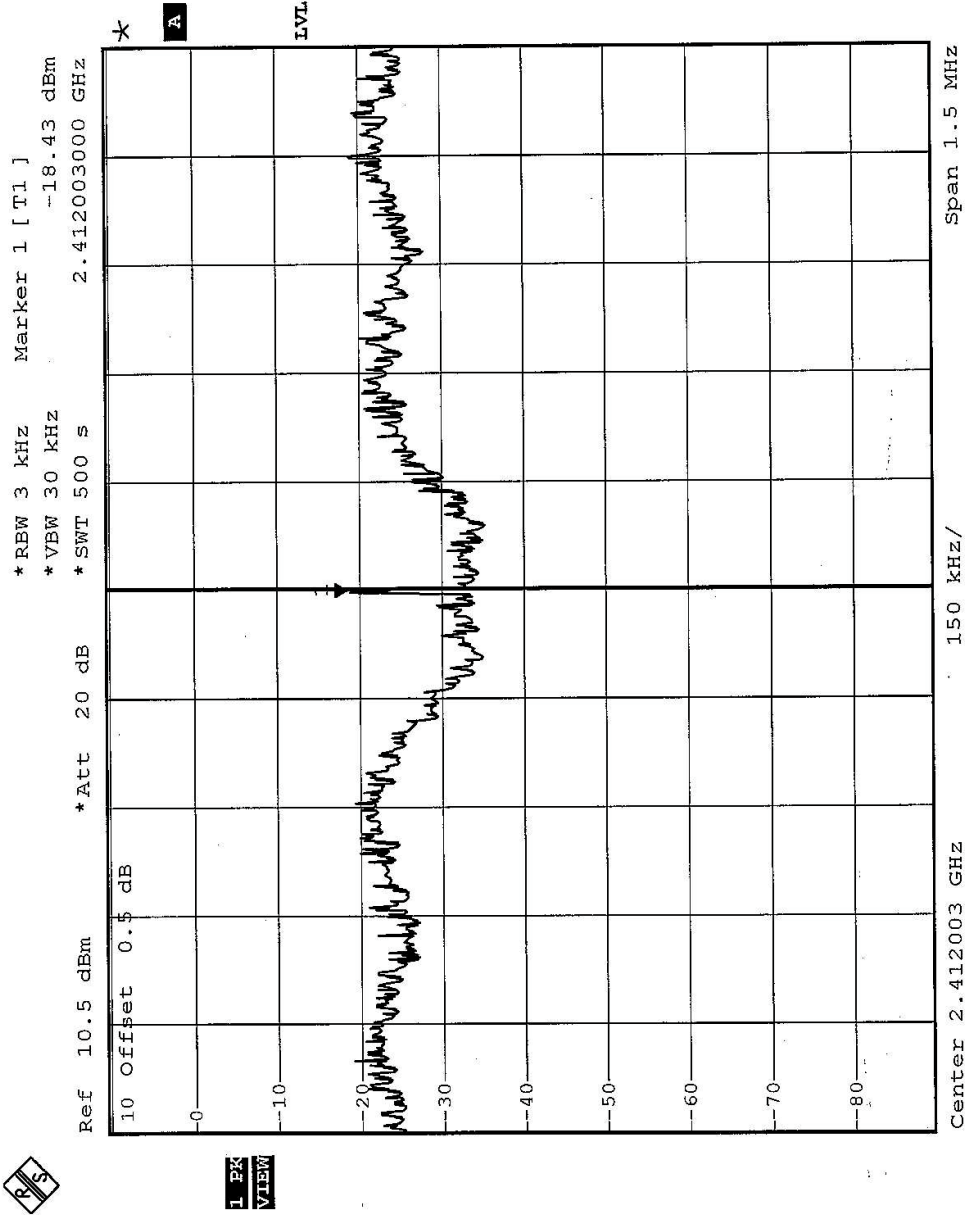



CH6

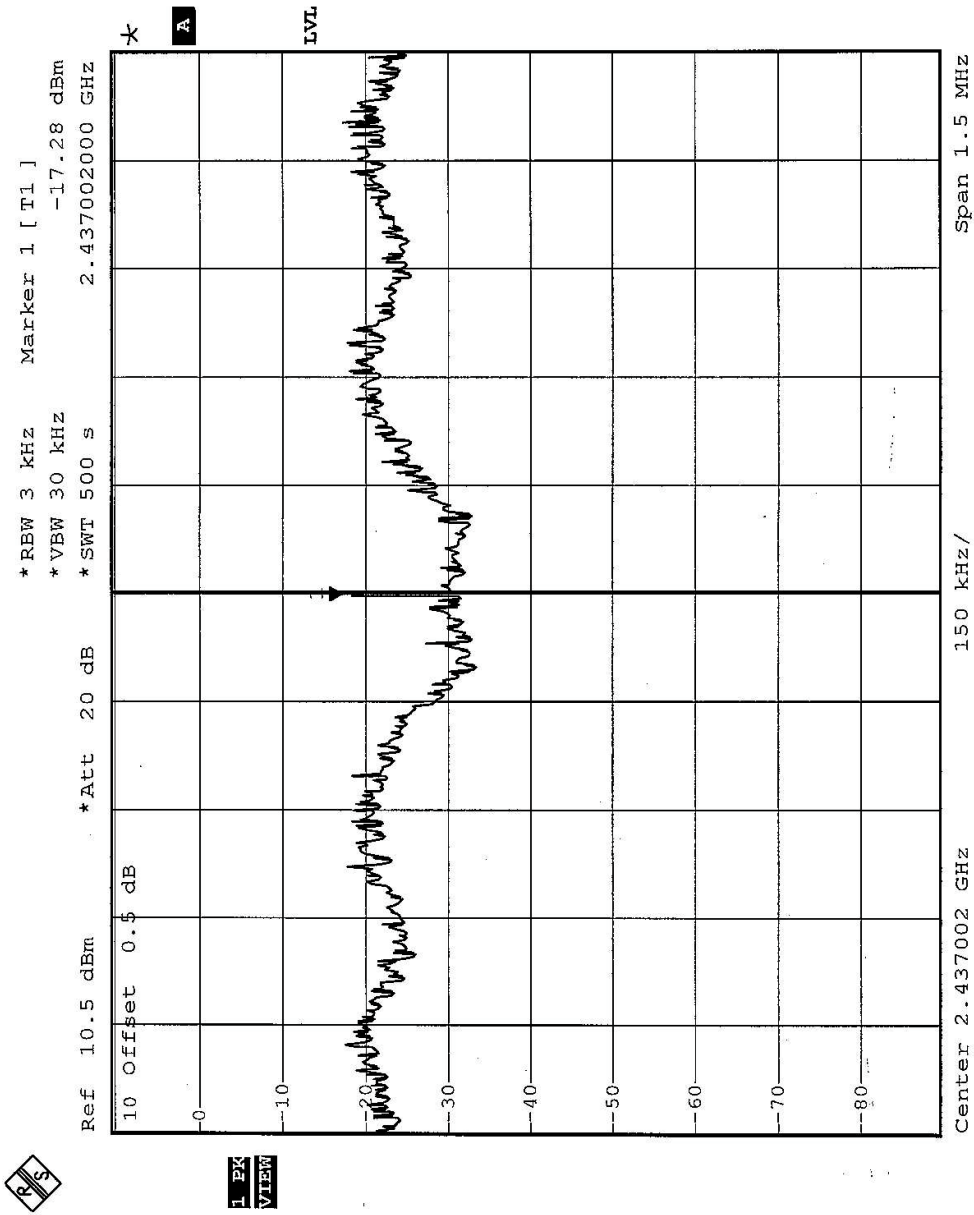



CH11

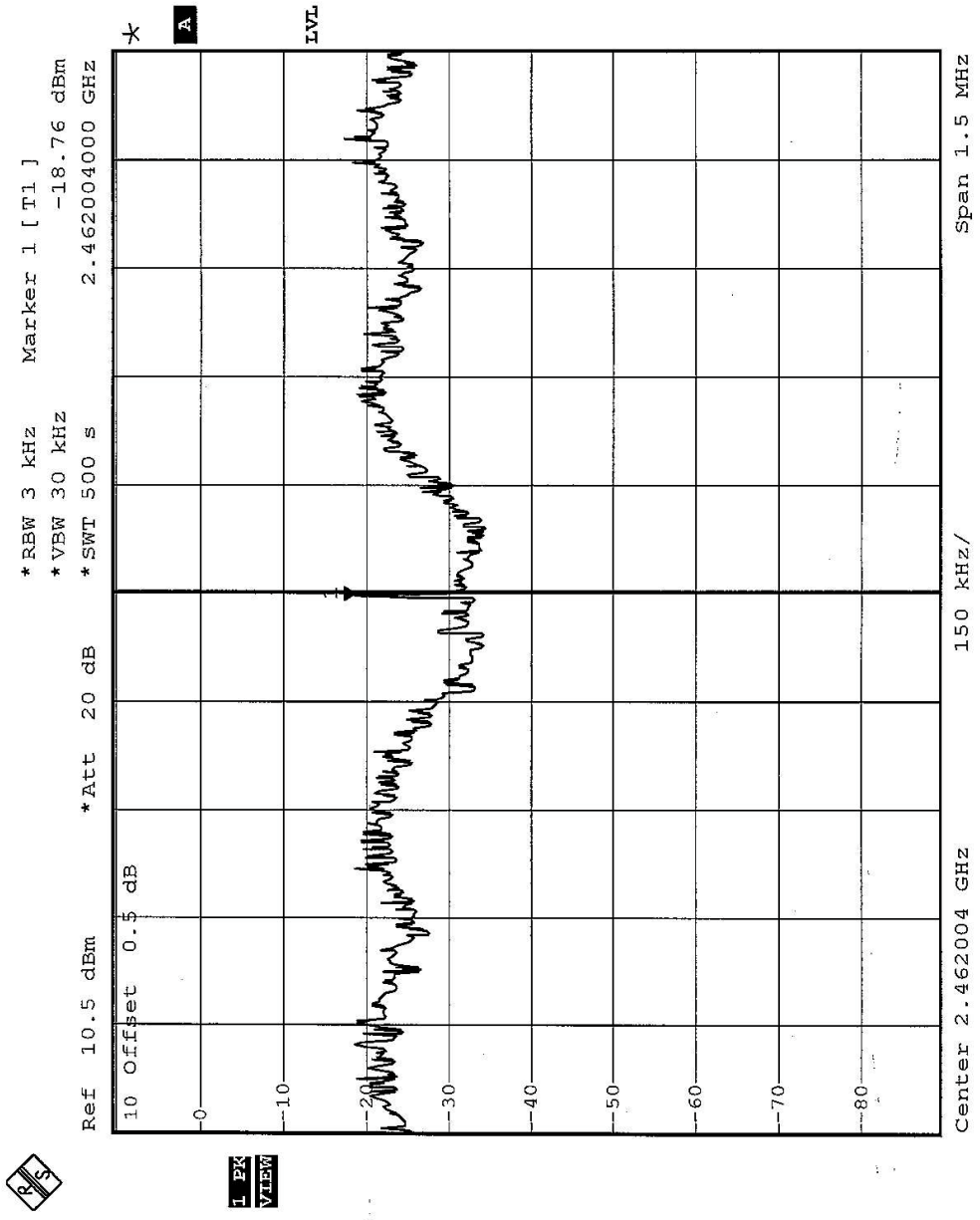



4.6 BAND EDGES MEASUREMENT

4.6.1 LIMITS OF BAND EDGES MEASUREMENT

Below -20dB of the highest emission level of operating band (in 100KHz Resolution Bandwidth).

4.6.2 TEST INSTRUMENTS

Description & Manufacturer	Model No.	Serial No.	Calibrated Until
R&S SPECTRUM ANALYZER	FSEK30	100049	Aug. 12, 2004

NOTE: The calibration interval of the above test instruments is 12 months and the calibrations are traceable to NML/ROC and NIST/USA.

4.6.3 TEST PROCEDURE

For CCK technique: The transmitter output was connected to the spectrum analyzer via a low lose cable. Set both RBW and VBW of spectrum analyzer to 1MHz and 300Hz with suitable frequency span including 100MHz bandwidth from band edge. The band edges was measured and recorded.

For OFDM technique: The transmitter output was connected to the spectrum analyzer via a low lose cable. Set both RBW and VBW of spectrum analyzer to 100kHz with suitable frequency span including 100MHz bandwidth from band edge. The band edges was measured and recorded.

4.6.4 DEVIATION FROM TEST STANDARD

No deviation



4.6.5 EUT OPERATING CONDITION

Same as Item 4.3.6

4.6.6 TEST RESULTS

The spectrum plots are attached on the following 2 pages. D2 line indicates the highest level, D1 line indicates the 20dB offset below D2. It shows compliance with the requirement in part 15.247(C).

NOTE 1: The band edge emission plot of the CCK technique on the following two pages show 57.87dB/58.93dB delta between carrier maximum power and local maximum emission in restrict band (2.3900GHz/2.4835GHz). The emission of carrier strength list in the test result of channel 1 and 11 at the item 4.2.7 are both of 106.2dBuV/m, so the maximum field strength in restrict band is $106.2 - 58.93 = 47.27$ dBuV/m which is under 54dBuV/m limit.

NOTE 2: The band edge emission plot of the OFDM technique on the following 3~4 pages show 50.1dB/48.86dB delta between carrier maximum power and local maximum emission in restrict band (2.3900GHz/2.4837GHz). The emission of carrier strength list in the test result of channel 1 and 11 at the item 4.2.7 are 96.5dBuV/m and 97.1dBuV/m, so the maximum field strength in restrict band is $97.1 - 48.86 = 48.24$ dBuV/m which is under 54dBuV/m limit.

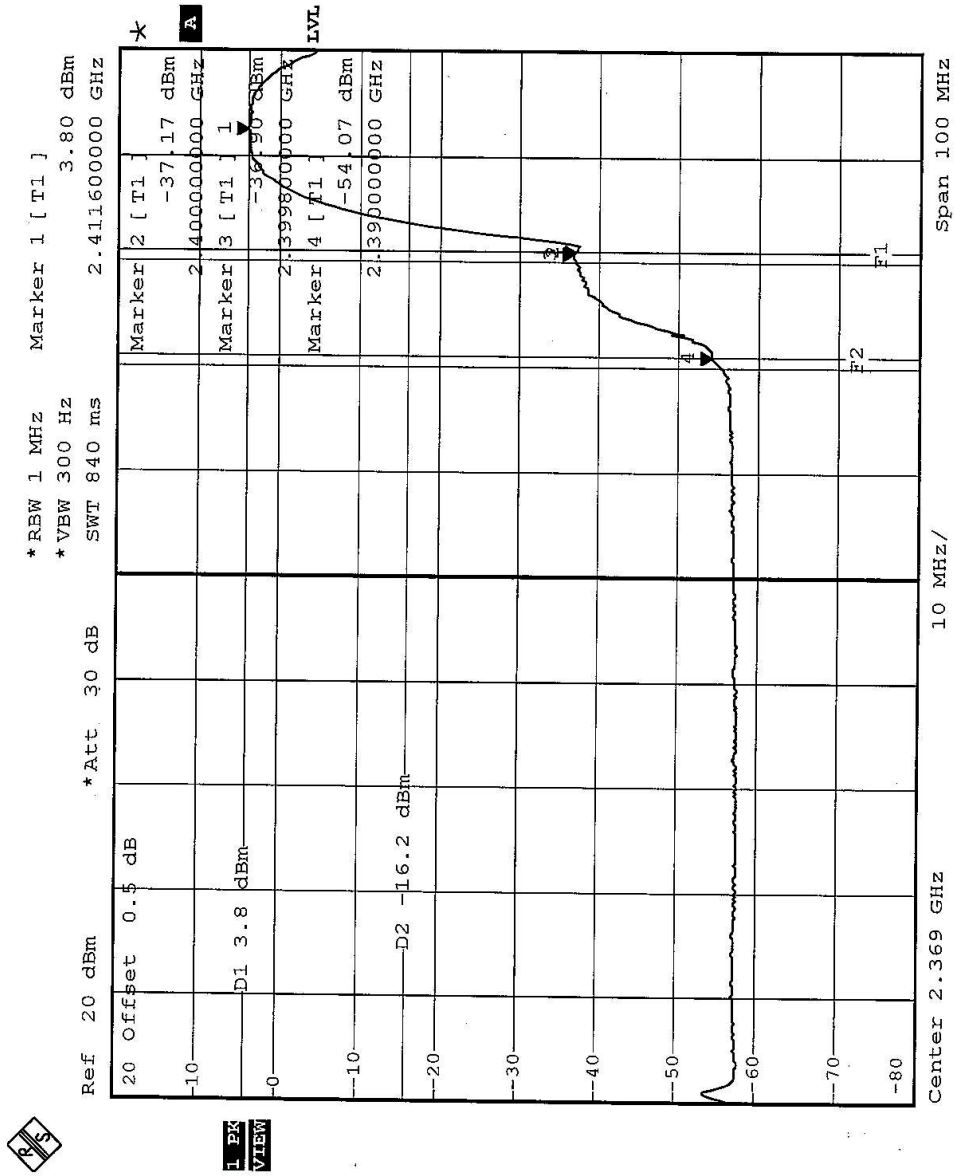

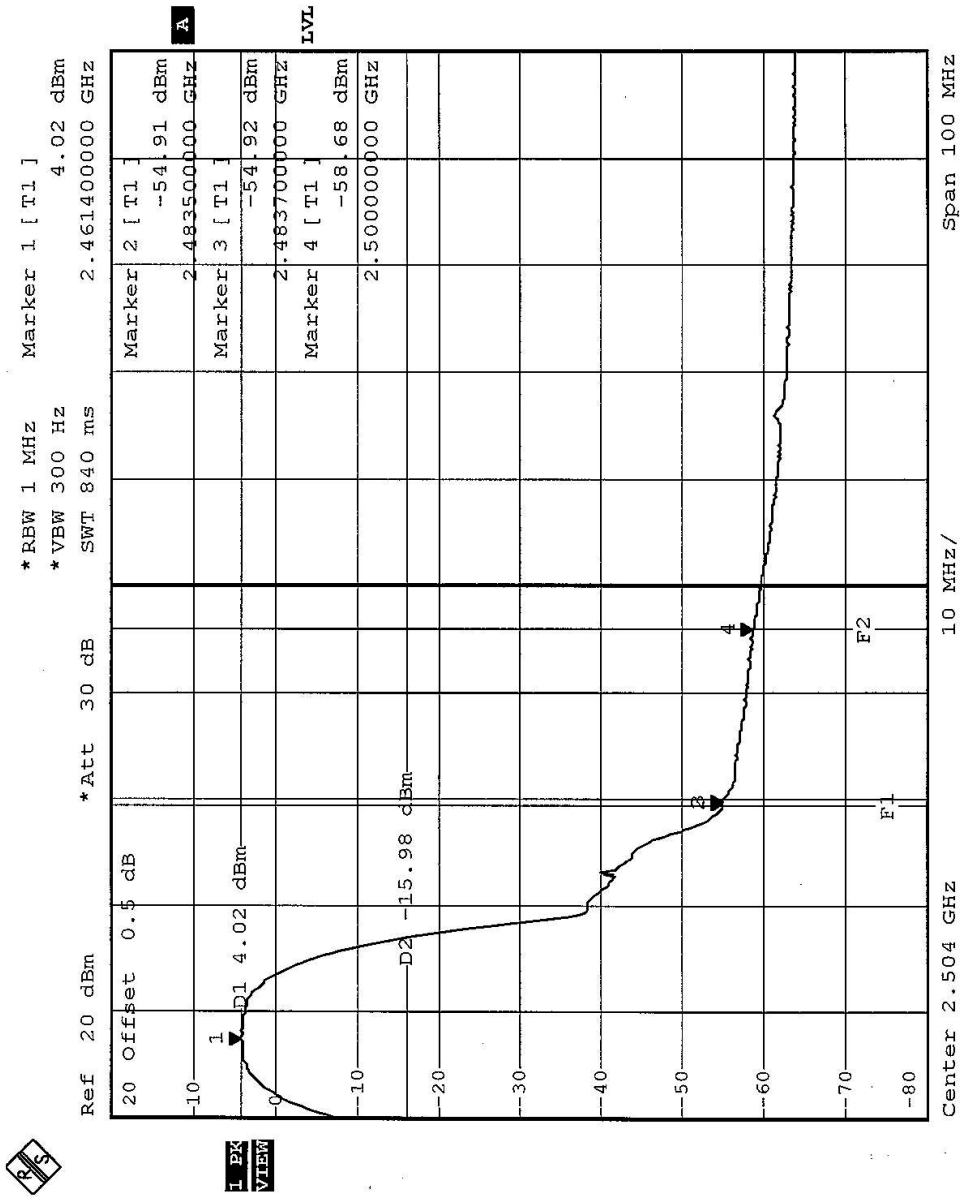

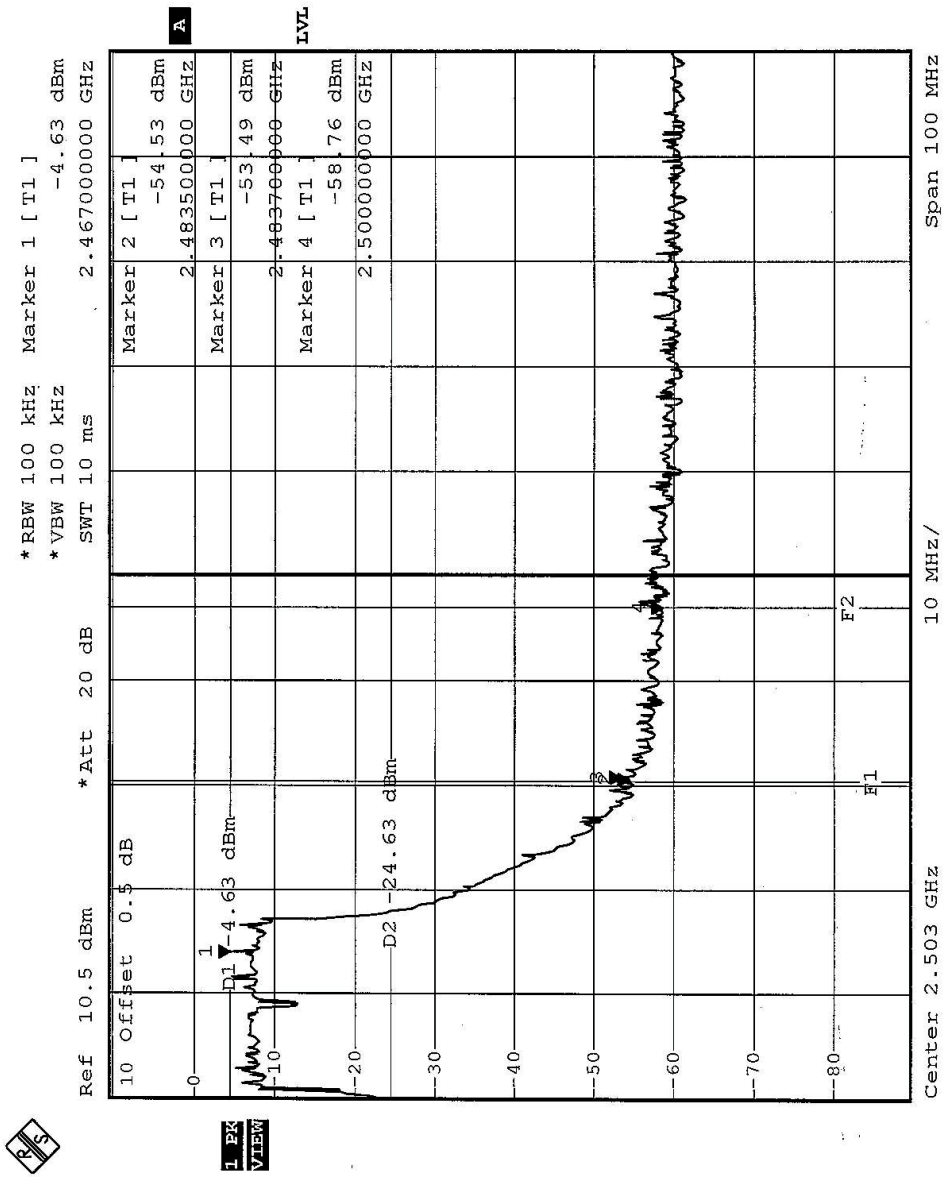

1 PK
VLEW



4.7 ANTENNA REQUIREMENT

4.7.1 STANDARD APPLICABLE

For intentional device, according to FCC 47 CFR Section 15.203, an intentional radiator shall be designed to ensure that no antenna other than that furnished by the responsible party shall be used with the device.

And according to FCC 47 CFR Section 15.247 (b), if transmitting antennas of directional gain greater than 6dBi are used, the power shall be reduced by the amount in dB that the directional gain of the antenna exceeds 6dBi.

4.7.2 ANTENNA CONNECTED CONSTRUCTION

The antenna type used in this product is Dipole Antenna with Reversed SMA antenna connector. The maximum Gain of this antenna is only 2dBi.

5 PHOTOGRAPHS OF THE TEST CONFIGURATION

CONDUCTED EMISSION TEST

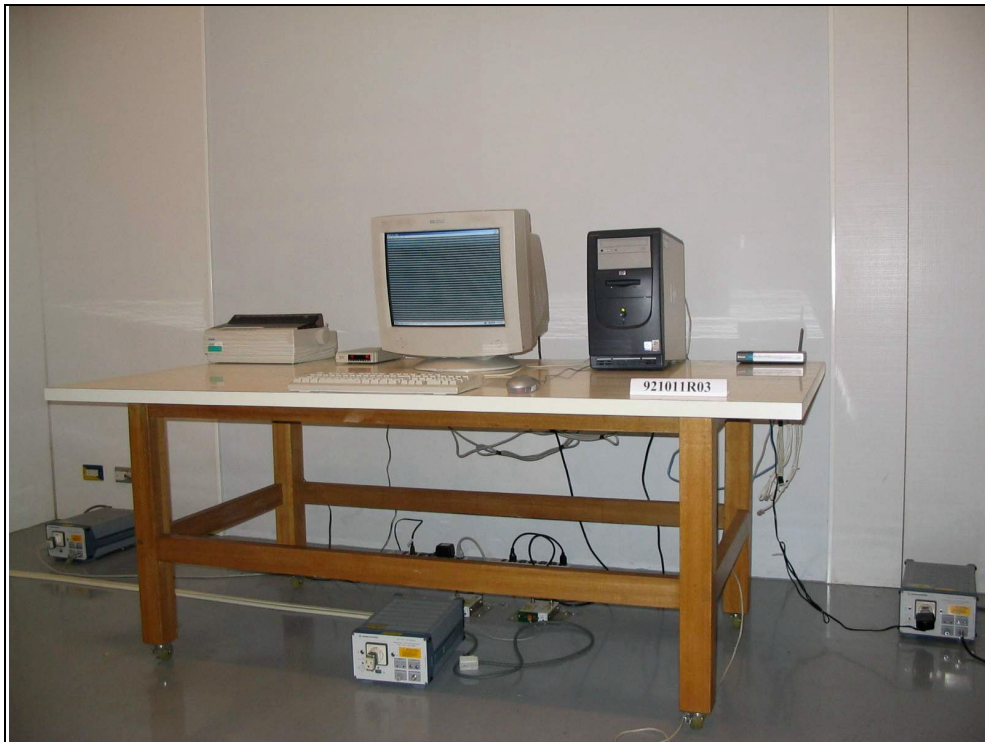

RADIATED EMISSION TEST





6 INFORMATION ON THE TESTING LABORATORIES

We, ADT Corp., were founded in 1988 to provide our best service in EMC and Safety consultation. Our laboratories are accredited and approved by the following approval agencies according to ISO/IEC 17025, Guide 25 or EN 45001:

USA	FCC, NVLAP
Germany	TUV Rheinland
Japan	VCCI
New Zealand	MoC
Norway	NEMKO
R.O.C.	BSMI, DGT, CNLA

Copies of accreditation certificates of our laboratories obtained from approval agencies can be downloaded from our web site:

www.adt.com.tw/index.5/phtml.

If you have any comments, please feel free to contact us at the following:

Lin Kou EMC Lab:

Tel: 886-2-26052180

Fax: 886-2-26052943

Hsin Chu EMC Lab:

Tel: 886-35-935343

Fax: 886-35-935342

Lin Kou Safety Lab:

Tel: 886-2-26093195

Fax: 886-2-26093184

Lin Kou RF&Telecom Lab

Tel: 886-3-3270910

Fax: 886-3-3270892

Email: service@mail.adt.com.tw

Web Site: www.adt.com.tw

The address and road map of all our labs can be found in our web site also.