

Troubleshooting

This Chapter provides solutions to problems that can occur during the installation and operation of the DI-524 Wireless Broadband Router. We cover various aspects of the network setup, including the network adapters. Please read the following if you are having problems.

Note: It is recommended that you use an Ethernet connection to configure the DI-524 Wireless Broadband Router.

1. The computer used to configure the DI-524 cannot access the Configuration menu.

- Check that the **Ethernet LED** on the DI-524 is **ON**. If the **LED** is not **ON**, check that the cable for the Ethernet connection is securely inserted.
- Check that the Ethernet Adapter is working properly. Please see item 3 (**Check that the drivers for the network adapters are installed properly**) in this **Troubleshooting** section to check that the drivers are loaded properly.
- Check that the **IP Address** is in the same range and subnet as the DI-524. Please see **Checking the IP Address in Windows XP** in the **Networking Basics** section of this manual.

Note: The IP Address of the DI-524 is 192.168.0.1. All the computers on the network must have a unique IP Address in the same range, e.g., 192.168.0.x. Any computers that have identical IP Addresses will not be visible on the network. They must all have the same subnet mask, e.g., 255.255.255.0

- Do a **Ping test** to make sure that the DI-524 is responding. Go to **Start>Run>Type Command>Type ping 192.168.0.1**. A successful ping will show four replies.

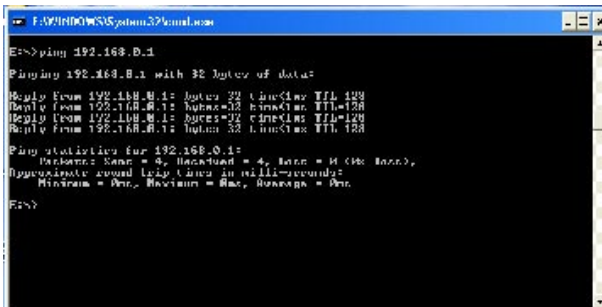

```
F:\WINDOWS\system32\cmd.exe
E->ping 192.168.0.1
Pinging 192.168.0.1 with 32 bytes of data:
Reply from 192.168.0.1: bytes=32 time=1ms TTL=128
Reply from 192.168.0.1: bytes=32 time=1ms TTL=128
Reply from 192.168.0.1: bytes=32 time=1ms TTL=128
Reply from 192.168.0.1: bytes=32 time=1ms TTL=128

Ping statistics for 192.168.0.1:
    Packets: Sent = 4, Received = 4, Loss = 0 (0% loss),
    Approximate round trip times in milliseconds:
    Minimum = 0ms, Maximum = 0ms, Average = 0ms

E->
```

Note: If you have changed the default IP Address, make sure to ping the correct IP Address assigned to the DI-524.

Troubleshooting

2. The wireless client cannot access the Internet in the Infrastructure mode.

Make sure the wireless client is associated and joined with the correct Access Point. To check this connection: **Right-click** on the **Local Area Connection icon** in the taskbar > select **View Available Wireless Networks**. The **Connect to Wireless Network** screen will appear. Please make sure you have selected the correct available network, as shown in the illustrations below.

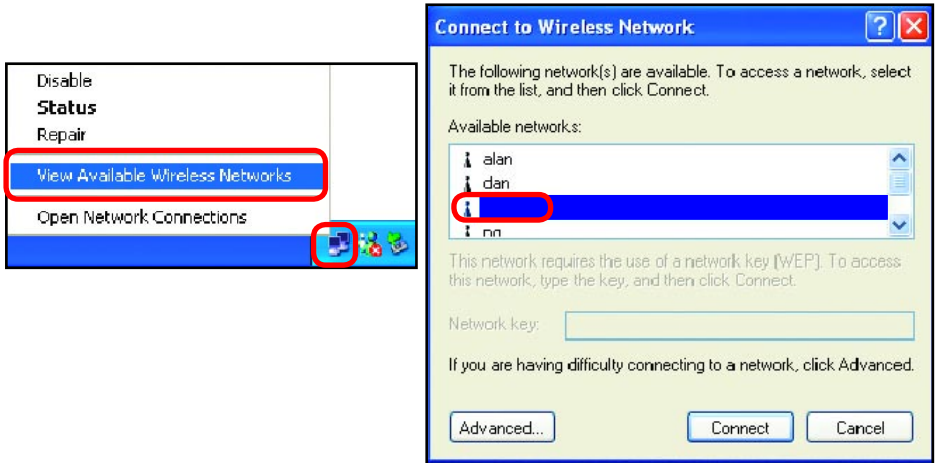

- Check that the **IP Address** assigned to the wireless adapter is within the same **IP Address range** as the access point and gateway. (Since the DI-524 has an IP Address of 192.168.0.1, wireless adapters must have an IP Address in the same range, e.g., 192.168.0.x. Each device must have a unique IP Address; no two devices may have the same IP Address. The subnet mask must be the same for all the computers on the network.) To check the **IP Address** assigned to the wireless adapter, **double-click** on the **Local Area Connection icon** in the taskbar > select the **Support tab** and the **IP Address** will be displayed. (Please refer to **Checking the IP Address in the Networking Basics** section of this manual.)
- If it is necessary to assign a **Static IP Address** to the wireless adapter, please refer to the appropriate section in **Networking Basics**. If you are entering a **DNS Server address** you must also enter the **Default Gateway Address**. (Remember that if you have a DHCP-capable router, you will not need to assign a Static IP Address. See **Networking Basics: Assigning a Static IP Address**.)

Troubleshooting

3. Check that the drivers for the network adapters are installed properly.

You may be using different network adapters than those illustrated here, but this procedure will remain the same, regardless of the type of network adapters you are using.

- Go to **Start > My Computer > Properties**

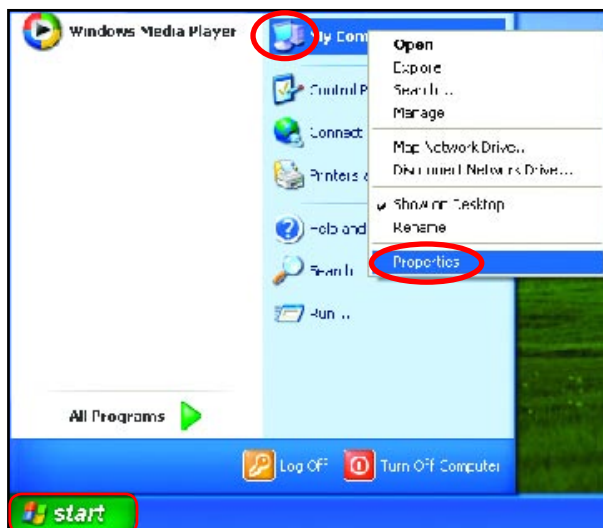

- Select the **Hardware** Tab

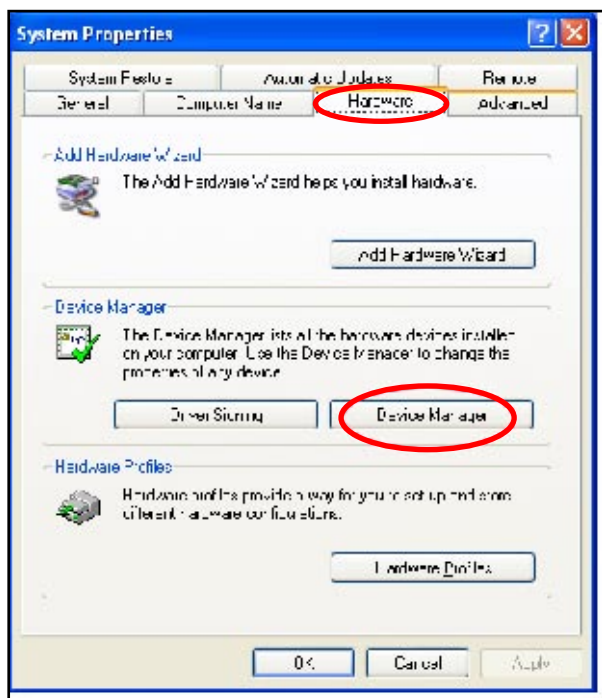

- Click **Device Manager**

Troubleshooting

- Double-click on **Network Adapters**
- Right-click on **D-Link AirPlus DWL-G650 Wireless Cardbus Adapter** (In this example we use the DWL-G650; you may be using other network adapters, but the procedure will remain the same.)

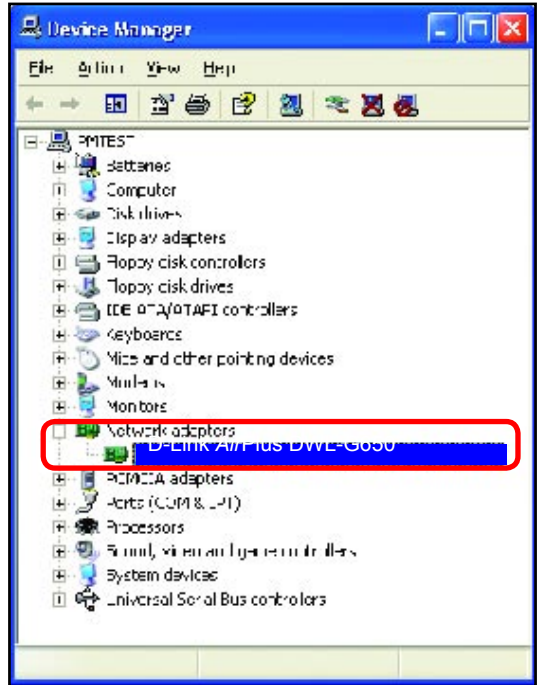

- Select **Properties** to check that the drivers are installed properly

- Look under **Device Status** to check that the device is working properly

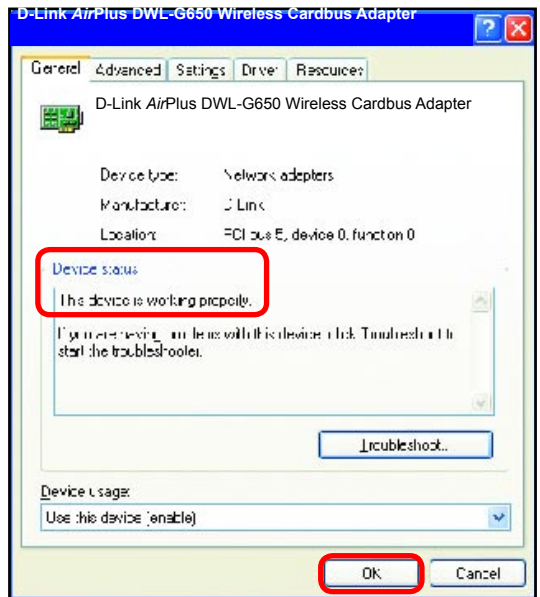

- Click **OK**

Troubleshooting

4. What variables may cause my wireless products to lose reception?

D-Link products let you access your network from virtually anywhere you want. However, the positioning of the products within your environment will affect the wireless range. Please refer to **Installation Considerations** in the **Wireless Basics** section of this manual for further information about the most advantageous placement of your D-Link wireless products.

5. Why does my wireless connection keep dropping?

- Antenna Orientation- Try different antenna orientations for the DI-524. Try to keep the antenna at least 6 inches away from the wall or other objects.
- If you are using 2.4GHz cordless phones, X-10 equipment or other home security systems, ceiling fans, and lights, your wireless connection will degrade dramatically or drop altogether. Try changing the Channel on your Router, Access Point and Wireless adapter to a different Channel to avoid interference.
- Keep your product away (at least 3-6 feet) from electrical devices that generate RF noise, like microwaves, Monitors, electric motors, etc.

6. Why can't I get a wireless connection?

If you have enabled Encryption on the DI-524, you must also enable encryption on all wireless clients in order to establish a wireless connection.

- For 802.11b, the Encryption settings are: 64, 128, or 256 bit. Make sure that the encryption bit level is the same on the Router and the Wireless Client.
- Make sure that the SSID on the Router and the Wireless Client are exactly the same. If they are not, wireless connection will not be established.
- Move the DI-524 and the wireless client into the same room and then test the wireless connection.
- Disable all security settings. (WEP, MAC Address Control)

Troubleshooting

6. Why can't I get a wireless connection? (continued)

- Turn off your DI-524 and the client. Turn the DI-524 back on again, and then turn on the client.
- Make sure that all devices are set to **Infrastructure** mode.
- Check that the LED indicators are indicating normal activity. If not, check that the AC power and Ethernet cables are firmly connected.
- Check that the IP Address, subnet mask, gateway and DNS settings are correctly entered for the network.
- If you are using 2.4GHz cordless phones, X-10 equipment or other home security systems, ceiling fans, and lights, your wireless connection will degrade dramatically or drop altogether. Try changing the Channel on your DI-524, and on all the devices in your network to avoid interference.
- Keep your product away (at least 3-6 feet) from electrical devices that generate RF noise, like microwaves, Monitors, electric motors, etc.

7. I forgot my encryption key.

- Reset the DI-524 to its factory default settings and restore the other devices on your network to their default settings. You may do this by pressing the Reset button on the back of the unit. You will lose the current configuration settings.

Troubleshooting

8. Resetting the DI-524 to Factory Default Settings

After you have tried other methods for troubleshooting your network, you may choose to **Reset** the DI-524 to the factory default settings. Remember that D-Link *AirPro* products network together, out of the box, at the factory default settings.



To hard-reset the DI-524 to Factory Default Settings, please do the following:

- Locate the **Reset** button on the back of the DI-524
- Use a paper clip to press the **Reset** button
- Hold for about 10 seconds and then release
- After the DI-524 reboots (this may take a few minutes) it will be reset to the factory **Default** settings

Technical Specifications

Standards

- IEEE 802.11g
- IEEE 802.11b
- IEEE 802.3
- IEEE 802.3u

VPN Pass Through/ Multi-Sessions

- PPTP
- L2TP
- IPSec

Device Management

- Web-Based- Internet Explorer v6 or later; Netscape Navigator v7 or later; or other Java-enabled browsers
- DHCP Server and Client

Advanced Firewall Features

- NAT with VPN Passthrough (Network Address Translation)
- MAC Filtering
- IP Filtering
- URL Filtering
- Domain Blocking
- Scheduling

Wireless Operating Range

- Indoors – up to 328 feet (100 meters)
- Outdoors – up to 984 feet (300 meters)

Operating Temperature

- 32°F to 131°F (0°C to 55°C)

Humidity:

- 95% maximum (non-condensing)

Safety and Emissions:

- FCC, CE

Wireless Frequency Range:

- 2.4GHz to 2.462GHz

Technical Specifications

LEDs:

- Power
- WAN
- LAN (10/100)
- WLAN (Wireless Connection)

Physical Dimensions:

- L = 5.6 inches (142mm)
- W = 4.3 inches (109mm)
- H = 1.2 inches (31mm)

Wireless Transmit Power:

- 14dBm

Security:

- 802.1x
- WEP
- WPA
- WPA-PSK

External Antenna Type:

- Single detachable reverse SMA

Modulation Technology:

- Orthogonal Frequency Division Multiplexing (OFDM)

Power Input:

- Ext. Power Supply DC 7.5V, 1.5A

Weight:

- 0.44 lbs. (200g)

Warranty:

- 1 year

Technical Specifications

Wireless Data Rates with Automatic Fallback:

- 54 Mbps
- 48 Mbps
- 36 Mbps
- 24 Mbps
- 18 Mbps
- 12 Mbps
- 11 Mbps
- 9 Mbps
- 6 Mbps
- 5.5 Mbps
- 2 Mbps
- 1 Mbps

Receiver Sensitivity:

- 54Mbps OFDM, 10% PER, -68dBm
- 48Mbps OFDM, 10% PER, -68dBm
- 36Mbps OFDM, 10% PER, -75dBm
- 24Mbps OFDM, 10% PER, -79dBm
- 18Mbps OFDM, 10% PER, -82dBm
- 12Mbps OFDM, 10% PER, -84dBm
- 11Mbps CCK, 8% PER, -82dBm
- 9Mbps OFDM, 10% PER, -87dBm
- 6Mbps OFDM, 10% PER, -88dBm
- 5.5Mbps CCK, 8% PER, -85dBm
- 2Mbps QPSK, 8% PER, -86dBm
- 1Mbps BPSK, 8% PER, -89dBm

Frequently Asked Questions

Why can't I access the web based configuration?

When entering the IP Address of the DI-524 (192.168.0.1), you are not connecting to the Internet or have to be connected to the Internet. The device has the utility built-in to a ROM chip in the device itself. Your computer must be on the same IP subnet to connect to the web-based utility.

To resolve difficulties accessing a web utility, please follow the steps below.

Step 1 Verify physical connectivity by checking for solid link lights on the device. If you do not get a solid link light, try using a different cable or connect to a different port on the device if possible. If the computer is turned off, the link light may not be on.

What type of cable should I be using?

The following connections require a Crossover Cable:

- Computer to Computer
- Computer to Uplink Port
- Computer to Access Point
- Computer to Print Server
- Computer/XBOX/PS2 to DWL-810
- Computer/XBOX/PS2 to DWL-900AP+
- Uplink Port to Uplink Port (hub/switch)
- Normal Port to Normal Port (hub/switch)

The following connections require a Straight-through Cable:

- Computer to Residential Gateway/Router
- Computer to Normal Port (hub/switch)
- Access Point to Normal Port (hub/switch)
- Print Server to Normal Port (hub/switch)
- Uplink Port to Normal Port (hub/switch)

Rule of Thumb:

"If there is a link light, the cable is right."

Frequently Asked Questions (continued)

Why can't I access the web based configuration? (continued)

What type of cable should I be using? (continued)

What's the difference between a crossover cable and a straight-through cable?

The wiring in crossover and straight-through cables are different. The two types of cable have different purposes for different LAN configurations. EIA/TIA 568A/568B define the wiring standards and allow for two different wiring color codes as illustrated in the following diagram.

**The wires with colored backgrounds may have white stripes and may be denoted that way in diagrams found elsewhere.*

How to tell straight-through cable from a crossover cable:

The main way to tell the difference between the two cable types is to compare the wiring order on the ends of the cable. If the wiring is the same on both sides, it is straight-through cable. If one side has opposite wiring, it is a crossover cable.

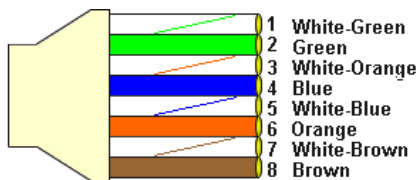

568A CABLE END

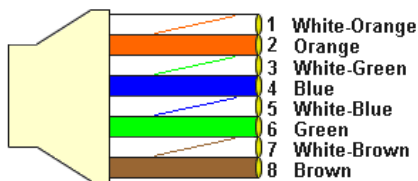

568B CABLE END

All you need to remember to properly configure the cables is the pinout order of the two cable ends and the following rules:

A straight-through cable has identical ends

A crossover cable has different ends

It makes no functional difference which standard you follow for straight-through cable ends, as long as both ends are the same. You can start a crossover cable with either standard as long as the other end is the other standard. It makes no functional difference which end is which. The order in which you pin the cable is important. Using a pattern other than what is specified in the above diagram could cause connection problems.

When to use a crossover cable and when to use a straight-through cable:

Computer to Computer – Crossover

Computer to an normal port on a Hub/Switch – Straight-through

Computer to an uplink port on a Hub/Switch - Crossover

Hub/Switch uplink port to another Hub/Switch uplink port – Crossover

Hub/Switch uplink port to another Hub/Switch normal port - Straight-through

Frequently Asked Questions (continued)

Why can't I access the web based configuration? (continued)

Step 2 Disable any Internet security software running on the computer. Software firewalls like Zone Alarm, Black Ice, Sygate, Norton Personal Firewall, etc. might block access to the configuration pages. Check the help files included with your firewall software for more information on disabling or configuring it.

Step 3 Configure your Internet settings.

Go to **Start>Settings>Control Panel**. Double click the **Internet Options** Icon. From the **Security** tab, click the button to restore the settings to their defaults.



Click to the **Connection** tab and set the dial-up option to **Never Dial a Connection**. Click the **LAN Settings** button

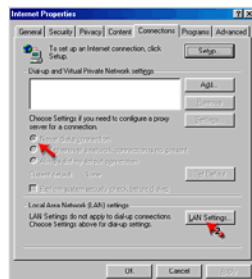

Nothing should be checked. Click **OK**

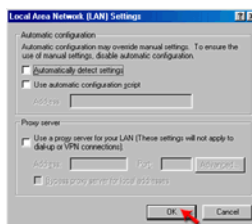

Go to the **Advanced** tab and click the button to restore these settings to their defaults

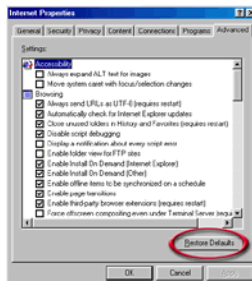

Click **OK**. Go to the desktop and close any open windows

Frequently Asked Questions (continued)

Why can't I access the web based configuration? (continued)

Step 4 Check your IP Address. Your computer must have an IP Address in the same range of the device you are attempting to configure. Most D-Link devices use the 192.168.0.X range.

How can I find my IP Address in Windows 95, 98, or ME?

Step 1 Click on **Start**, then click on **Run**.

Step 2 The Run Dialogue Box will appear. Type **winipcfg** in the window as shown then click **OK**.

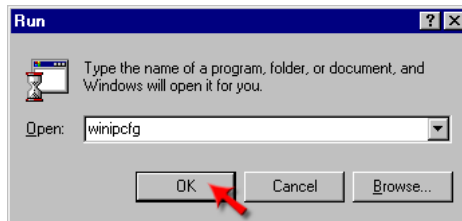

Step 3 The **IP Configuration** window will appear, displaying your **Ethernet Adapter Information**.

- Select your adapter from the drop down menu.
- If you do not see your adapter in the drop down menu, your adapter is not properly installed.

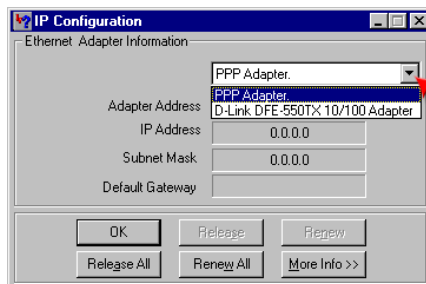

Step 4 After selecting your adapter, it will display your IP Address, subnet mask, and default gateway.

Step 5 Click **OK** to close the IP Configuration window

Frequently Asked Questions (continued)

Why can't I access the web based configuration? (continued)

Step 4 (continued) Check your IP Address. Your computer must have an IP Address in the same range of the device you are attempting to configure. Most D-Link devices use the 192.168.0.X range.

How can I find my IP Address in Windows 2000/XP?

Step 1 Click on **Start** and select **Run**.

Step 2 Type **cmd** then click **OK**.

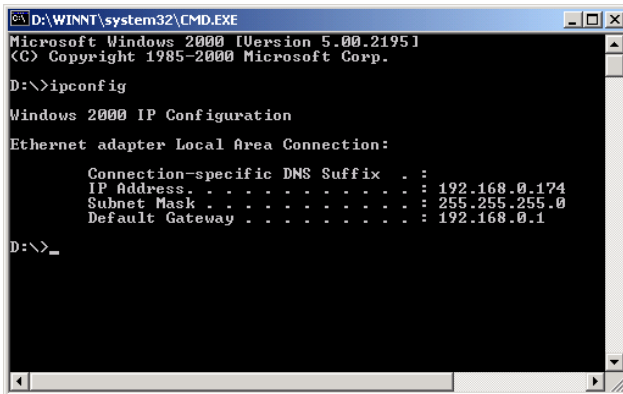

Step 3 From the Command Prompt, enter **ipconfig**. It will return your IP Address, subnet mask, and default gateway

A screenshot of a Windows Command Prompt window. The title bar reads 'D:\WINNT\system32\CMD.EXE'. The window content shows the following text:

```
Microsoft Windows 2000 [Version 5.00.2195]
(C) Copyright 1985-2000 Microsoft Corp.

D:\>ipconfig

Windows 2000 IP Configuration

Ethernet adapter Local Area Connection:

    Connection-specific DNS Suffix  . : 
    IP Address . . . . . : 192.168.0.174
    Subnet Mask . . . . . : 255.255.255.0
    Default Gateway . . . . . : 192.168.0.1

D:\>_
```

Step 4 Type **exit** to close the command prompt.

Frequently Asked Questions (continued)

Why can't I access the web based configuration? (continued)

Step 4 (continued) Check your IP Address. Your computer must have an IP Address in the same range of the device you are attempting to configure. Most D-Link devices use the 192.168.0.X range.

Make sure you take note of your computer's Default Gateway IP Address. The Default Gateway is the IP Address of the D-Link router. By default, it should be 192.168.0.1.

How can I assign a Static IP Address in Windows XP?

Step 1

Click on **Start > Control Panel > Network and Internet Connections > Network connections.**

Step 2 See [Step 2](#) for Windows 2000 and continue from there.

How can I assign a Static IP Address in Windows 2000?

Step 1 Right-click on **My Network Places** and select **Properties.**

Step 2 Right-click on the **Local Area Connection** which represents your network card and select **Properties.**

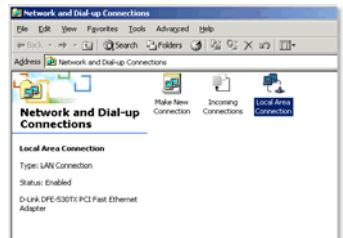

Highlight **Internet Protocol (TCP/IP)** and click **Properties.**

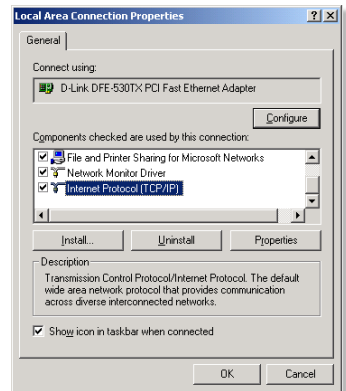

Frequently Asked Questions (continued)

Why can't I access the web based configuration? (continued)

How can I assign a Static IP Address in Windows 2000? (continued)

Click **Use the following IP Address** and enter an IP Address that is on the same subnet as the LAN IP Address on your router. Example: If the router's LAN IP Address is 192.168.0.1, make your IP Address 192.168.0.X where X = 2-99. Make sure that the number you choose is not in use on the network.

Set the **Default Gateway** to be the same as the LAN IP Address of your router (192.168.0.1).

Set the **Primary DNS** to be the same as the LAN IP address of your router (192.168.0.1).

The **Secondary DNS** is not needed or enter a DNS server from your ISP.

Click **OK** twice. You may be asked if you want to reboot your computer. Click **Yes**.

How can I assign a Static IP Address in Windows 98/Me?

Step 1 From the desktop, right-click on the **Network Neighborhood** icon (Win ME - My Network Places) and select **Properties**

Highlight **TCP/IP** and click the **Properties** button. If you have more than 1 adapter, then there will be a TCP/IP "Binding" for each adapter. Highlight **TCP/IP >** (**your network adapter**) and then click **Properties**.

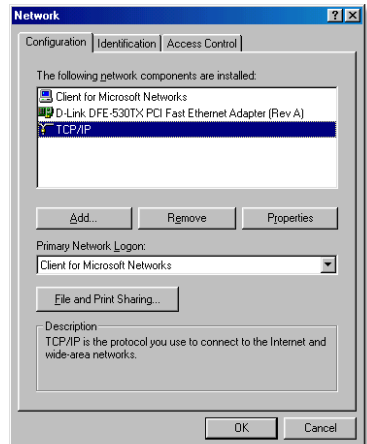
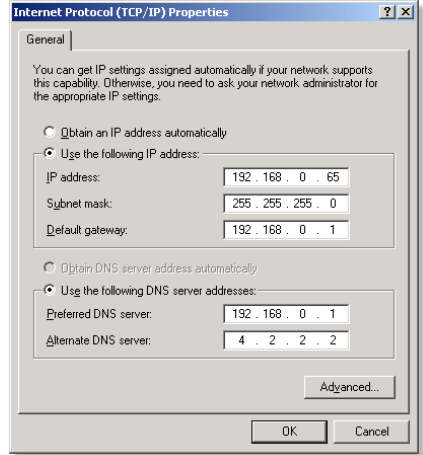

Frequently Asked Questions (continued)

Why can't I access the web based configuration? (continued)

How can I assign a Static IP Address in Windows 98/Me? (continued)

Step 2 Click **Specify an IP Address**.

Enter in an IP Address that is on the same subnet as the LAN IP Address on your router. **Example:** If the router's LAN IP Address is 192.168.0.1, make your IP Address 192.168.0.X where X is between 2-99. Make sure that the number you choose is not in use on the network.

Step 3 Click on the **Gateway** tab.

Enter the LAN IP Address of your router here (192.168.0.1).

Click **Add** when finished.

Step 4 Click on the **DNS Configuration** tab.

Click **Enable DNS**. Type in a **Host** (can be any word). Under DNS server search order, enter the LAN IP Address of your router (192.168.0.1). Click **Add**.

Step 5 Click **OK** twice.

When prompted to reboot your computer, click **Yes**.

After you reboot, the computer will now have a static, private IP Address.

Step 5 Access the web management. Open your web browser and enter the IP Address of your D-Link device in the address bar. This should open the login page for the web management. Follow instructions to login and complete the configuration.



Frequently Asked Questions (continued)

How can I setup my router to work with a Cable modem connection?

Dynamic Cable connection

(IE AT&T-BI, Cox, Adelphia, Rogers, Roadrunner, Charter, and Comcast).

Note: Please configure the router with the computer that was last connected directly to the cable modem.

Step 1 Log into the web based configuration by typing in the IP Address of the router (default:192.168.0.1) in your web browser. The username is **admin** (all lowercase) and the password is **blank** (nothing).

Step 2 Click the **Home** tab and click the **WAN** button. Dynamic IP Address is the default value, however, if Dynamic IP Address is not selected as the WAN type, select Dynamic IP Address by clicking on the radio button. Click **Clone Mac Address**. Click on **Apply** and then **Continue** to save the changes.



D-Link
Building Networks for People

AirPlus G
802.11g/2.4GHz Wireless Router

DI-524

Wizard
Wireless
WAN
LAN
DHCP

Home Advanced Tools Status Help

WAN Settings
Please select the appropriate option to connect to your ISP.

Dynamic IP Address Choose this option to obtain an IP address automatically from your ISP. (For most Cable modem users)

Static IP Address Choose this option to set static IP information provided to you by your ISP.

PPPoE Choose this option if your ISP uses PPPoE. (For most DSL users)

Others PPTP, BigPond Cable, L2TP and Telia.

Dynamic IP Address

Host Name (Optional)

MAC Address 00 50 18 21 B7 53

Primary DNS Address 0.0.0.0

Secondary DNS Address 0.0.0.0

MTU 1500

Auto-reconnect Enabled Disabled

Apply Cancel Help

Frequently Asked Questions (continued)

How can I setup my router to work with a Cable modem connection? (continued)

Step 3 Power cycle the cable modem and router:

Turn the cable modem off (first) . Turn the router off Leave them off for 2 minutes.** Turn the cable modem on (first). Wait until you get a solid cable light on the cable modem. Turn the router on. Wait 30 seconds.

** If you have a Motorola (Surf Board) modem, leave off for at least 5 minutes.

Step 4 Follow step 1 again and log back into the web configuration. Click the **Status** tab and click the **Device Info** button. If you do not already have a public IP Address under the **WAN** heading, click on the **DHCP Renew** and **Continue** buttons.

Static Cable Connection

Step 1 Log into the web based configuration by typing in the IP Address of the router (default:192.168.0.1) in your web browser. The username is **admin** (all lowercase) and the password is **blank** (nothing).



Step 2 Click the **Home** tab and click the **WAN** button. Select **Static IP Address** and enter your static settings obtained from the ISP in the fields provided.

If you do not know your settings, you must contact your ISP.

Step 3 Click on **Apply** and then click **Continue** to save the changes.

Step 4 Click the **Status** tab and click the **Device Info** button. Your IP Address information will be displayed under the **WAN** heading.



Frequently Asked Questions (continued)

How can I setup my router to work with Earthlink DSL or any PPPoE connection?

Make sure you disable or uninstall any PPPoE software such as WinPoet or Enternet 300 from your computer or you will not be able to connect to the Internet.

Step 1 Upgrade Firmware if needed.

(Please visit the D-Link tech support website at: <http://support.dlink.com> for the latest firmware upgrade information.)

Step 2 Take a paperclip and perform a hard reset. With the unit on, use a paperclip and hold down the reset button on the back of the unit for 10 seconds. Release it and the router will recycle, the lights will blink, and then stabilize.

Step 3 After the router stabilizes, open your browser and enter 192.168.0.1 into the address window and hit the **Enter** key. When the password dialog box appears, enter the username **admin** and leave the password blank. Click **OK**.

If the password dialog box does not come up repeat **Step 2**.

Note: Do not run Wizard.

Step 4 Click on the **WAN** tab on left-hand side of the screen. Select **PPPoE**.

Step 5 Select **Dynamic PPPoE** (unless your ISP supplied you with a static IP Address).

Step 6 In the username field enter **ELN/username@earthlink.net** and your password, where username is your own username.

For SBC Global users, enter **username@sbcglobal.net**.
For Ameritech users, enter **username@ameritech.net**.
For BellSouth users, enter **username@bellsouth.net**.
For Mindspring users, enter **username@mindspring.com**.
For most other ISPs, enter **username**.

Step 7 Maximum Idle Time should be set to zero. Set **MTU** to 1492, unless specified by your ISP, and set **Autoreconnect** to **Enabled**.

Note: If you experience problems accessing certain websites and/or email issues, please set the MTU to a lower number such as 1472, 1452, etc. Contact your ISP for more information and the proper MTU setting for your connection.

Frequently Asked Questions (continued)

How can I setup my router to work with Earthlink DSL or any PPPoE connection? (continued)

Step 8 Click **Apply**. When prompted, click **Continue**. Once the screen refreshes, unplug the power to the D-Link router.

Step 9 Turn off your DSL modem for 2-3 minutes. Turn back on. Once the modem has established a link to your ISP, plug the power back into the D-Link router. Wait about 30 seconds and log back into the router.

Step 10 Click on the **Status** tab in the web configuration where you can view the device info. Under **WAN**, click **Connect**. Click **Continue** when prompted. You should now see that the device info will show an IP Address, verifying that the device has connected to a server and has been assigned an IP Address.

Can I use my D-Link Broadband Router to share my Internet connection provided by AOL DSL Plus?

In most cases yes. AOL DSL+ may use PPPoE for authentication bypassing the client software. If this is the case, then our routers will work with this service. Please contact AOL if you are not sure.

To set up your router:

Step 1 Log into the web-based configuration (192.168.0.1) and configure the WAN side to use PPPoE.

Step 2 Enter your screen name followed by @aol.com for the user name. Enter your AOL password in the password box.

Step 3 You will have to set the MTU to 1400. AOL DSL does not allow for anything higher than 1400.

Step 4 Apply settings.

Step 5 Recycle the power to the modem for 1 minute and then recycle power to the router. Allow 1 to 2 minutes to connect.

If you connect to the Internet with a different internet service provider and want to use the AOL software, you can do that without configuring the router's firewall settings. You need to configure the AOL software to connect using TCP/IP.

Go to <http://www.aol.com> for more specific configuration information of their software.

Frequently Asked Questions (continued)

How do I open ports on my router?

To allow traffic from the internet to enter your local network, you will need to open up ports or the router will block the request.

Step 1 Open your web browser and enter the IP Address of your D-Link router (192.168.0.1). Enter username (admin) and your password (blank by default).

Step 2 Click on **Advanced** on top and then click **Virtual Server** on the left side.

Step 3 Check **Enabled** to activate entry.

Step 4 Enter a name for your virtual server entry.

Step 5 Next to **Private IP**, enter the IP Address of the computer on your local network that you want to allow the incoming service to.

Step 6 Choose **Protocol Type** - either TCP, UDP, or both. If you are not sure, select both.

Step 7 Enter the port information next to **Private Port** and **Public Port**. The private and public ports are usually the same. The public port is the port seen from the WAN side, and the private port is the port being used by the application on the computer within your local network.

Step 8 Enter the **Schedule** information.

Step 9 Click **Apply** and then click **Continue**.

Note: Make sure DMZ host is disabled. If DMZ is enabled, it will disable all Virtual Server entries.

Because our routers use NAT (Network Address Translation), you can only open a specific port to one computer at a time. For example: If you have 2 web servers on your network, you cannot open port 80 to both computers. You will need to configure 1 of the web servers to use port 81. Now you can open port 80 to the first computer and then open port 81 to the other computer.

The screenshot shows the 'Virtual Server' configuration page. At the top, it says 'Virtual Server is used to allow Internet users access to LAN services.' Below this, there are several fields and options:

- Enabled/Disabled:** Radio buttons for 'Enabled' (selected) and 'Disabled'.
- Name:** A text input field containing 'pccanywhere1' and a 'Clear' button.
- Private IP:** A text input field containing '192.168.0.100'.
- Protocol Type:** A dropdown menu showing 'UDP'.
- Private Port:** A text input field containing '22'.
- Public Port:** A text input field containing '22'.
- Schedule:** Radio buttons for 'Always' (selected) and 'From time'. The 'From time' option is further detailed with dropdown menus for hours (00), minutes (00), and AM/PM (AM), followed by 'to' and another set of dropdown menus for hours (00), minutes (00), and AM/PM (AM). Below this, there are dropdown menus for 'day' (Sun) and 'to' (Sun).

Frequently Asked Questions (continued)

What is DMZ?

Demilitarized Zone:

In computer networks, a DMZ (demilitarized zone) is a computer host or small network inserted as a neutral zone between a company's private network and the outside public network. It prevents outside users from getting direct access to a server that has company data. (The term comes from the geographic buffer zone that was set up between North Korea and South Korea following the UN police action in the early 1950s.) A DMZ is an optional and more secure approach to a firewall and effectively acts as a proxy server as well.

In a typical DMZ configuration for a small company, a separate computer (or host in network terms) receives requests from users within the private network for access to Web sites or other companies accessible on the public network. The DMZ host then initiates sessions for these requests on the public network. However, the DMZ host is not able to initiate a session back into the private network. It can only forward packets that have already been requested.

Users of the public network outside the company can access only the DMZ host. The DMZ may typically also have the company's Web pages so these could be served to the outside world. However, the DMZ provides access to no other company data. In the event that an outside user penetrated the DMZ hosts security, the Web pages might be corrupted but no other company information would be exposed. D-Link, a leading maker of routers, is one company that sells products designed for setting up a DMZ

How do I configure the DMZ Host?

The DMZ feature allows you to forward all incoming ports to one computer on the local network. The DMZ, or Demilitarized Zone, will allow the specified computer to be exposed to the Internet. DMZ is useful when a certain application or game does not work through the firewall. The computer that is configured for DMZ will be completely vulnerable on the Internet, so it is suggested that you try opening ports from the Virtual Server or Firewall settings before using DMZ.

Step 1 Find the IP address of the computer you want to use as the DMZ host.

To find out how to locate the IP Address of the computer in Windows XP/2000/ME/9x or Macintosh operating systems please refer to Step 4 of the first question in this section (Frequently Asked Questions).

Frequently Asked Questions (continued)

How do I configure the DMZ Host? (continued)

Step 2 Log into the web based configuration of the router by typing in the IP Address of the router (default:192.168.0.1) in your web browser. The username is **admin** (all lowercase) and the password is **blank** (nothing)



Step 3 Click the **Advanced** tab and then click on the **DMZ** button. Select **Enable** and type in the IP Address you found in step 1.

Step 4 Click **Apply** and then **Continue** to save the changes.

Note: When DMZ is enabled, Virtual Server settings will still be effective. Remember, you cannot forward the same port to multiple IP Addresses, so the Virtual Server settings will take priority over DMZ settings.

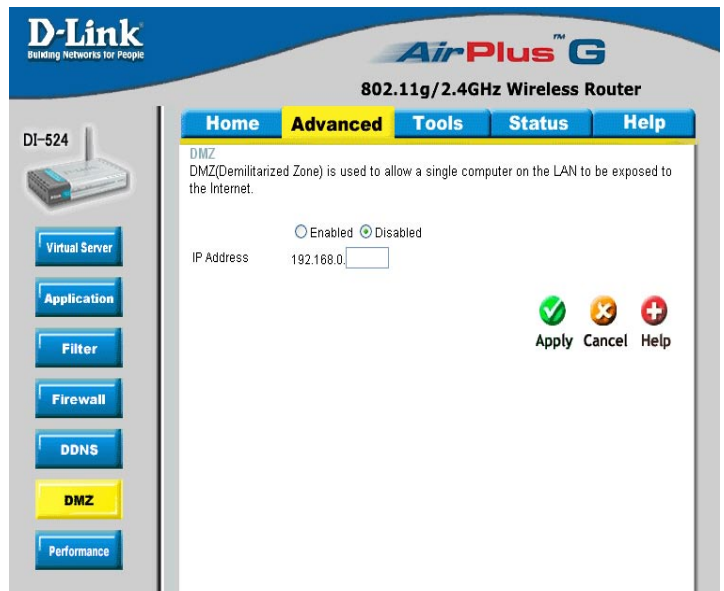

Frequently Asked Questions (continued)

How do I open a range of ports on my DI-524 using Firewall rules?

Step 1 Access the router's web configuration by entering the router's IP Address in your web browser. The default IP Address is **192.168.0.1**. Login using your password. The default username is "**admin**" and the password is blank.

If you are having difficulty accessing web management, please see the first question in this section.

Step 2 From the web management Home page, click the **Advanced** tab then click the **Firewall** button.

Step 3 Click on **Enabled** and type in a name for the new rule.

Step 4 Choose **WAN** as the **Source** and enter a range of IP Addresses out on the internet that you would like this rule applied to. If you would like this rule to allow all internet users to be able to access these ports, then put an **Asterisk** in the first box and leave the second box empty.

The screenshot shows the D-Link AirPlus G 802.11g/2.4GHz Wireless Router web management interface. The 'Advanced' tab is selected, and the 'Firewall' button is highlighted in the left sidebar. The 'Firewall Rules' configuration page is displayed, showing options to enable or disable the rule, set a name, and choose an action (Allow or Deny). The 'Source' field is set to '*' and the 'Destination' field is set to '*'. The 'Schedule' is set to 'Always'. The 'Apply', 'Cancel', and 'Help' buttons are visible at the bottom right. Below the configuration fields is a 'Firewall Rules List' table.

Action Name	Source	Destination	Protocol		
<input type="checkbox"/> Allow Allow to Ping WAN port	WAN,*	WAN,*	ICMP,8		
<input type="checkbox"/> Deny Default	**	LAN,*	**		
<input type="checkbox"/> Allow Default	LAN,*	**	**		

Step 5 Select **LAN** as the **Destination** and enter the IP Address of the computer on your local network that you want to allow the incoming service to. This will not work with a range of IP Addresses.

Step 6 Enter the port or range of ports that are required to be open for the incoming service.

Step 7 Click **Apply** and then click **Continue**.

Note: Make sure DMZ host is disabled.

Because our routers use NAT (Network Address Translation), you can only open a specific port to one computer at a time. For example: If you have 2 web servers on your network, you cannot open port 80 to both computers. You will need to configure 1 of the web servers to use port 81. Now you can open port 80 to the first computer and then open port 81 to the other computer.

Frequently Asked Questions (continued)

What are virtual servers?

A Virtual Server is defined as a service port, and all requests to this port will be redirected to the computer specified by the server IP. For example, if you have an FTP Server (port 21) at 192.168.0.5, a Web server (port 80) at 192.168.0.6, and a VPN server at 192.168.0.7, then you need to specify the following virtual server mapping table:

Server Port	Server IP	Enable
21	192.168.0.5	X
80	192.168.0.6	X
1723	192.168.0.7	X

How do I use *PC Anywhere* with my DI-524 router?

You will need to open 3 ports in the Virtual Server section of your D-Link router.

Step 1 Open your web browser and enter the IP Address of the router (192.168.0.1).

Step 2 Click on **Advanced** at the top and then click **Virtual Server** on the left side.

Step 3 Enter the information as seen below. The **Private IP** is the IP Address of the computer on your local network that you want to connect to.

Step 4 The first entry will read as shown here:

Step 5 Click **Apply** and then click **Continue**.

Virtual Server
Virtual Server is used to allow Internet users access to LAN services.

Enabled Disabled

Name:

Private IP:

Protocol Type:

Private Port:

Public Port:

Schedule: Always

From time : AM to : AM
day to

Frequently Asked Questions (continued)

How do I use *PC Anywhere* with my DI-524 router? (continued)

Step 6 Create a second entry as shown here:

Virtual Server
Virtual Server is used to allow Internet users access to LAN services.

Enabled Disabled

Name

Private IP

Protocol Type

Private Port

Public Port

Schedule Always

From time : AM to : AM
day to

Step 7 Click **Apply** and then click **Continue**.

Step 8 Create a third and final entry as shown here:

Virtual Server
Virtual Server is used to allow Internet users access to LAN services.

Enabled Disabled

Name

Private IP

Protocol Type

Private Port

Public Port

Schedule Always

From time : AM to : AM
day to

Step 9 Click **Apply** and then click **Continue**.

Step 10 Run *PCAnywhere* from the remote site and use the WAN IP Address of the router, not your computer's IP Address.

Frequently Asked Questions (continued)

How can I use eDonkey behind my D-Link Router?

You must open ports on your router to allow incoming traffic while using eDonkey.

eDonkey uses three ports (4 if using CLI):

4661 (TCP) To connect with a server

4662 (TCP) To connect with other clients

4665 (UDP) To communicate with servers other than the one you are connected to.

4663 (TCP) *Used with the command line (CLI) client when it is configured to allow remote connections. This is the case when using a Graphical Interface (such as the Java Interface) with the client.

Step 1 Open your web browser and enter the IP Address of your router (192.168.0.1). Enter username (admin) and your password (leave blank).

Step 2 Click on **Advanced** and then click **Firewall**.

Step 3 Create a new firewall rule: Click **Enabled**. Enter a name (edonkey). Click **Allow**. Next to Source, select **WAN** under interface. In the first box, enter an *. Leave the second box empty. Next to Destination, select **LAN** under interface. Enter the IP Address of the computer you are running eDonkey from. Leave the second box empty. Under Protocol, select *. In the port range boxes, enter **4661** in the first box and then **4665** in the second box. Click **Always** or set a schedule.

The screenshot shows the D-Link AirPlus G 802.11g/2.4GHz Wireless Router web interface. The 'Advanced' tab is selected, and the 'Firewall' sub-tab is active. The 'Firewall Rules' section is visible, showing a rule named 'edonkey' that is enabled and set to 'Allow'. The source is configured as 'WAN' with an IP range of '*' to '*'. The destination is 'LAN' with an IP of '192.168.0.100'. The protocol is set to '*' and the port range is '4661-4665'. The schedule is set to 'Always'. A table below shows the Firewall Rules List with columns for Action Name, Source, Destination, and Protocol.

Action Name	Source	Destination	Protocol
<input type="checkbox"/> Allow Allow to Ping WAN port	WAN,*	WAN,*	ICMP:8
<input type="checkbox"/> Deny Default	*,*	LAN,*	*,*
<input type="checkbox"/> Allow Default	LAN,*	*,*	*,*

Step 4 Click **Apply** and then **Continue**.

Frequently Asked Questions (continued)

How do I set up my router for SOCOM on my Playstation 2?

To allow you to play SOCOM and hear audio, you must download the latest firmware for the router (if needed), enable Game Mode, and open port 6869 to the IP Address of your Playstation.

Step 1 Upgrade firmware (follow link above).

Step 2 Open your web browser and enter the IP Address of the router (192.168.0.1). Enter username (admin) and your password (blank by default).

Step 3 Click on the **Advanced** tab and then click on **Virtual Server** on the left side.

Step 4 You will now create a new Virtual Server entry. Click **Enabled** and enter a name (socom). Enter the IP Address of your Playstation for **Private IP**.

Step 5 For **Protocol Type** select Both. Enter **6869** for both the **Private Port** and **Public Port**. Click **Always**. Click **Apply** to save changes and then **Continue**

The screenshot shows the D-Link AirPlus G 802.11g/2.4GHz Wireless Router web interface. The left sidebar contains navigation buttons: Virtual Server (highlighted), Application, Filter, Firewall, DDNS, DMZ, and Performance. The main content area is titled 'Virtual Server' and includes a description: 'Virtual Server is used to allow Internet users access to LAN services.' The configuration options are as follows:

- Enabled (selected) / Disabled
- Name: socom
- Private IP: 192.168.0.100
- Protocol Type: Both
- Private Port: 6869
- Public Port: 6869
- Schedule: Always (selected)
- From: Time 00:00 To 00:00, day Sun to Sun

Buttons for Apply, Cancel, and Help are visible. Below the configuration is a 'Virtual Server List' table:

Name	Private IP	Protocol	Schedule	
<input type="checkbox"/> Virtual Server FTP	0.0.0.0	TCP 21 / 21	always	
<input type="checkbox"/> Virtual Server HTTP	0.0.0.0	TCP 80 / 80	always	
<input type="checkbox"/> Virtual Server HTTPS	0.0.0.0	TCP 443 / 443	always	
<input type="checkbox"/> Virtual Server DNS	0.0.0.0	UDP 53 / 53	always	

Step 6 Click on the **Tools** tab and then **Misc** on the left side.

Step 7 Make sure **Gaming Mode** is Enabled. If not, click **Enabled**. Click **Apply** and then **Continue**.

Frequently Asked Questions (continued)

How can I use Gamespy behind my D-Link router?

Step 1 Open your web browser and enter the IP Address of the router (192.168.0.1). Enter admin for the username and your password (blank by default).

Step 2 Click on the Advanced tab and then click Virtual Server on the left side.

Step 3 You will create 2 entries.

Step 4 Click Enabled and enter Settings:

NAME - Gamespy1

PRIVATE IP - The IP Address of your computer that you are running Gamespy from.

PROTOCOL TYPE - Both

PRIVATE PORT - 3783

PUBLIC PORT - 3783

SCHEDULE - Always.

Name	Private IP	Protocol	Schedule
<input type="checkbox"/> Virtual Server FTP	0.0.0.0	TCP 21 / 21	always
<input type="checkbox"/> Virtual Server HTTP	0.0.0.0	TCP 80 / 80	always
<input type="checkbox"/> Virtual Server HTTPS	0.0.0.0	TCP 443 / 443	always
<input type="checkbox"/> Virtual Server DNS	0.0.0.0	UDP 53 / 53	always

Click **Apply** and then **continue**

Step 5 Enter 2nd entry:
Click Enabled

NAME - Gamespy2

PRIVATE IP - The IP Address of your computer that you are running Gamespy from.

PROTOCOL TYPE - Both

PRIVATE PORT - 6500

PUBLIC PORT - 6500

SCHEDULE - Always.

Name	Private IP	Protocol	Schedule
<input type="checkbox"/> Virtual Server FTP	0.0.0.0	TCP 21 / 21	always
<input type="checkbox"/> Virtual Server HTTP	0.0.0.0	TCP 80 / 80	always
<input type="checkbox"/> Virtual Server HTTPS	0.0.0.0	TCP 443 / 443	always
<input type="checkbox"/> Virtual Server DNS	0.0.0.0	UDP 53 / 53	always

Click **Apply** and then **continue**.

Frequently Asked Questions (continued)

How do I configure my router for KaZaA and Grokster?

The following is for KaZaA, Grokster, and others using the FastTrack P2P file sharing system.

In most cases, you do not have to configure anything on the router or on the Kazaa software. If you are having problems, please follow steps below:

Step 1 Enter the IP Address of your router in a web browser (192.168.0.1).

Step 2 Enter your username (admin) and your password (blank by default).

Step 3 Click on Advanced and then click Virtual Server.

Step 4 Click Enabled and then enter a Name (kazaa for example).

Step 5 Enter the IP Address of the computer you are running KaZaA from in the Private IP box. Select TCP for the Protocol Type.

Step 6 Enter 1214 in the Private and Public Port boxes. Click Always under schedule or set a time range. Click Apply.

The screenshot shows the 'Virtual Server' configuration page. At the top, there are navigation tabs: 'Home', 'Advanced' (highlighted in yellow), 'Tools', 'Status', and 'Help'. Below the tabs, the page title is 'Virtual Server' and a description reads: 'Virtual Server is used to allow Internet users access to LAN services.' The configuration options are as follows:

- Enabled: Enabled, Disabled
- Name:
- Private IP:
- Protocol Type: - Private Port:
- Public Port:
- Schedule: Always, From
- From Time: : To :
- day: to

Make sure that you did not enable proxy/firewall in the KaZaA software.

Frequently Asked Questions (continued)

How do I configure my router to play Warcraft 3?

You must open ports on your router to allow incoming traffic while hosting a game in Warcraft 3. To play a game, you do not have to configure your router.

Warcraft 3 (Battlenet) uses port 6112.

For the DI-604, DI-614+, DI-524, DI-754, DI-764, or DI-774:

Step 1 Open your web browser and enter the IP Address of your router (192.168.0.1). Enter username (admin) and your password (leave blank).

Step 2 Click on **Advanced** and then click **Virtual Server**.

Step 3 Create a new entry: Click **Enabled**. Enter a name (warcraft3). Private IP - Enter the IP Address of the computer you want to host the game. Select **Both** for Protocol Type Enter **6112** for both Private Port and Public Port Click **Always** or set a schedule.

Step 4 Click **Apply** and then **Continue**.

Note: If you want multiple computers from you LAN to play in the same game that you are hosting, then repeat the steps above and enter the IP Addresses of the other computers. You will need to change ports. Computer #2 can use port 6113, computer #3 can use 6114, and so on.

You will need to change the port information within the Warcraft 3 software for computers #2 and up.

Configure the Game Port information on each computer:

Start Warcraft 3 on each computer, click **Options** > **Gameplay**. Scroll down and you should see **Game Port**. Enter the port number as you entered in the above steps.

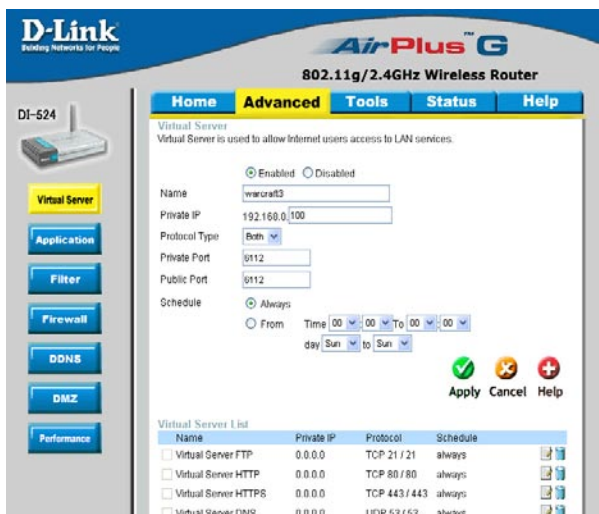

Frequently Asked Questions (continued)

How do I use NetMeeting with my D-Link Router?

Unlike most TCP/IP applications, NetMeeting uses **DYNAMIC PORTS** instead of STATIC PORTS. That means that each NetMeeting connection is somewhat different than the last. For instance, the HTTP web site application uses port 80. NetMeeting can use any of over 60,000 different ports.

All broadband routers using (only) standard NAT and all internet sharing programs like Microsoft ICS that use (only) standard NAT will NOT work with NetMeeting or other h.323 software packages.

The solution is to put the router in DMZ.

Note: A few hardware manufacturers have taken it on themselves to actually provide H.323 compatibility. This is not an easy task since the router must search each incoming packet for signs that it might be a netmeeting packet. This is a whole lot more work than a router normally does and may actually be a **weak point in the firewall**. D-Link is not one of the manufacturers.

To read more on this visit <http://www.HomenetHelp.com>

How do I set up my router to use iChat? -for Macintosh users-

You must open ports on your router to allow incoming traffic while using iChat.

iChat uses the following ports: 5060 (UDP) 5190 (TCP) File Sharing 16384-16403 (UDP) To video conference with other clients

Step 1 Open your web browser and enter the IP Address of your router (192.168.0.1). Enter username (admin) and your password (leave blank).

Step 2 Click on **Advanced** and then click **Firewall**.

Frequently Asked Questions (continued)

How do I set up my router to use iChat? -for Macintosh users- (continued)

Step 3 Create a new firewall rule:

Click **Enabled**.

Enter a name (ichat1).

Click **Allow**.

Next to Source, select **WAN** under interface.

In the first box, enter an *****.

Leave the second box empty.

Next to Destination, select **LAN** under interface.

Enter the IP Address of the computer you are running iChat from.

DI-524

Virtual Server
Application
Filter
Firewall
DDNS
DMZ
Performance

802.11g/2.4GHz Wireless Router

Home Advanced Tools Status Help

Firewall Rules
Firewall Rules can be used to allow or deny traffic from passing through the DI-524.

Enabled Disabled

Name:

Action: Allow Deny

Interface: WAN IP Start: * IP End: Protocol: Port Range:

Source: WAN * IP End: Protocol: Port Range:

Destination: LAN 192.168.0.100 IP End: Protocol: UDP 5060

Schedule: Always From Time 00:00 To 00:00 day Sun to Sun

Apply Cancel Help

Action Name	Source	Destination	Protocol
<input type="checkbox"/> Allow Allow to Ping WAN port	WAN,*	WAN,*	ICMP,S
<input type="checkbox"/> Deny Default	**	LAN,*	**
<input type="checkbox"/> Allow Default	LAN,*	**	**

Enter the IP Address of the computer you are running iChat from.

Leave the second box empty. Under Protocol, select **UDP**. In the port range boxes, enter **5060** in the first box and leave the second box empty. Click **Always** or set a schedule.

Step 4 Click **Apply** and then **Continue**.

Step 5

Repeat steps 3 and 4 enter **ichat2** and open ports **16384-16403** (UDP).

DI-524

Virtual Server
Application
Filter
Firewall
DDNS
DMZ
Performance

802.11g/2.4GHz Wireless Router

Home Advanced Tools Status Help

Firewall Rules
Firewall Rules can be used to allow or deny traffic from passing through the DI-524.

Enabled Disabled

Name:

Action: Allow Deny

Interface: WAN IP Start: * IP End: Protocol: Port Range:

Source: WAN * IP End: Protocol: Port Range:

Destination: LAN 192.168.0.100 IP End: Protocol: UDP 16384-16403

Schedule: Always From Time 00:00 To 00:00 day Sun to Sun

Apply Cancel Help

Action Name	Source	Destination	Protocol
<input type="checkbox"/> Allow Allow to Ping WAN port	WAN,*	WAN,*	ICMP,S
<input type="checkbox"/> Deny Default	**	LAN,*	**
<input type="checkbox"/> Allow Default	LAN,*	**	**

Frequently Asked Questions (continued)

How do I set up my router to use iChat? -for Macintosh users- (continued)

For File Sharing:

Step 1 Click on **Advanced** and then **Virtual Server**.

Step 2 Check **Enabled** to activate entry.

Step 3 Enter a name for your virtual server entry (ichat3).

Step 4 Next to Private IP, enter the IP Address of the computer on your local network that you want to allow the incoming service to.

Step 5 Select **TCP** for Protocol Type.

Step 6 Enter **5190** next to Private Port and Public Port.

Step 7 Click **Always** or configure a schedule.

Step 8 Click **Apply** and then **Continue**.

D-Link
Building Networks for People

AirPlus™ G
802.11g/2.4GHz Wireless Router

DI-524

Home **Advanced** Tools Status Help

Firewall Rules
Firewall Rules can be used to allow or deny traffic from passing through the DI-524.

Enabled Disabled

Name:

Action: Allow Deny

Interface: IP Start: IP End: Protocol: Port Range:

Source: Destination: 192.168.0.100

Schedule: Always From Time :00 To :00 day to

Apply Cancel Help

Firewall Rules List

Action Name	Source	Destination	Protocol	
<input type="checkbox"/> Allow Allow to Ping WAN port	WAN,*	WAN,*	ICMP,8	
<input type="checkbox"/> Deny Default	**	LAN,*	**	
<input type="checkbox"/> Allow Default	LAN,*	**	**	

If using Mac OS X Firewall, you may need to temporarily turn off the firewall in the Sharing preference pane on both computers.

To use the Mac OS X Firewall, you must open the same ports as in the router:

Step 1 Choose **Apple menu > System Preferences**.

Step 2 Choose **View > Sharing**.

Step 3 Click the **Firewall** tab.

Step 4 Click **New**.

Step 5 Choose **Other** from the Port Name pop-up menu.

Step 6 In the Port Number, Range or Series field, type in: **5060, 16384-16403**.

Step 7 In the Description field type in: **iChat AV**

Step 8 Click **OK**.

Frequently Asked Questions (continued)

How do I send or receive a file via iChat when the Mac OS X firewall is active? -for Macintosh users- Mac OS X 10.2 and later

The following information is from the online Macintosh AppleCare knowledge base:

“iChat cannot send or receive a file when the Mac OS X firewall is active in its default state. If you have opened the AIM port, you may be able to receive a file but not send them.

In its default state, the Mac OS X firewall blocks file transfers using iChat or America Online AIM software. If either the sender or receiver has turned on the Mac OS X firewall, the transfer may be blocked.

The simplest workaround is to temporarily turn off the firewall in the Sharing preference pane on both computers. This is required for the sender. However, the receiver may keep the firewall on if the AIM port is open. To open the AIM port:

Step 1 Choose Apple menu > System Preferences.

Step 2 Choose View > Sharing.

Step 3 Click the Firewall tab.

Step 4 Click New.

Step 5 Choose AOL IM from the Port Name pop-up menu. The number 5190 should already be filled in for you.

Step 6 Click OK.

If you do not want to turn off the firewall at the sending computer, a different file sharing service may be used instead of iChat. The types of file sharing available in Mac OS X are outlined in technical document 106461, “Mac OS X: File Sharing” in the *AppleCare Knowledge base* online.

Note: If you use a file sharing service when the firewall is turned on, be sure to click the Firewall tab and select the service you have chosen in the “Allow” list. If you do not do this, the firewall will also block the file sharing service. “

Frequently Asked Questions (continued)

What is NAT?

NAT stands for **Network Address Translator**. It is proposed and described in RFC-1631 and is used for solving the IP Address depletion problem. Basically, each NAT box has a table consisting of pairs of local IP Addresses and globally unique addresses, by which the box can “translate” the local IP Addresses to global address and vice versa. Simply put, it is a method of connecting multiple computers to the Internet (or any other IP network) using one IP Address.

D-Link’s broadband routers (ie: DI-604) support NAT. With proper configuration, multiple users can access the Internet using a single account via the NAT device.

For more information on RFC-1631: The IP Network Address Translator (NAT), visit <http://www.faqs.org/rfcs/rfc1631.html>

NOTE:THE MANUFACTURER IS NOT RESPONSIBLE FOR ANY RADIO OR TV INTERFERENCE CAUSED BY UNAUTHORIZED MODIFICATIONS TO THIS EQUIPMENT. SUCH MODIFICATIONS COULD VOID THE USER'S AUTHORITY TO OPERATE THE EQUIPMENT.

FCC RF exposure requirements: The antenna used for this transmitter must be installed to provide a separation distance of at least 20 cm from all persons and must not be co-located or operating in conjunction with any other antenna or transmitter.

Product Specification

DI-524

4-Port 802.11g Wireless Broadband Router

Revision 1.2 (2004/09/23)

Features List:

1. Integrate with 4 ports Fast Ethernet switch: 10/100Mbps MDI/MDIX auto-sensing.
2. Provide 10/100Mbps WAN interface to connect with DSL or cable modem for broadband Internet access.
3. Built-in NAT function: allow multiple PCs and devices to share one Internet connection.
4. Over 90Mbps wired routing speed.
5. Browser-based interface configuration and management: OS independent, easy-to-use for consumer install.
6. Built-in firewall to protect your Intranet.
7. VPN support: pass through of PPTP, L2TP, and IPSec.
8. Easy to upgrade: using Web or Windows Application to upgrade new version of firmware.
9. High speed for wireless LAN connection: support both IEEE 802.11b and 802.11g. Up to 54 Mbps data rate when operates in 802.11g mode.
10. Provide seamless roaming within the IEEE 802.11b and 802.11g WLAN infrastructure.
11. Data rate supported: 6/12/18/24/36/48/54 Mbps in 802.11g mode; 1/2/5.5/11Mbps in 802.11b mode.
12. WEP encryption and WPA supported.

Block Diagram:

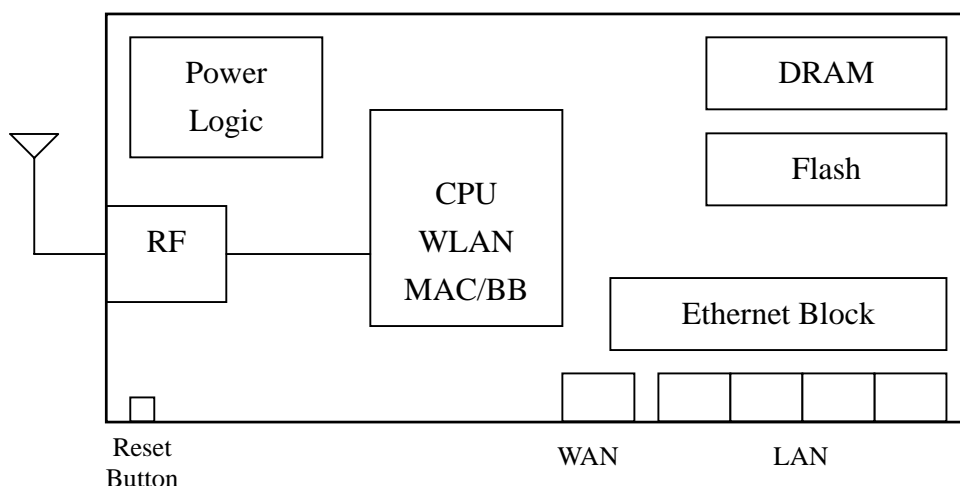

Specification Tables:

Hardware and Port Characteristic	
CPU	DL7500
Memory	Flash 1MB, DRAM 2MB
LAN Port	4 x RJ45, 10/100 Mbps with Auto-MDI/MDIX
WAN Port	1 x RJ45, 10/100 Mbps with Auto-MDI/MDIX
Input Power	DC 7.5V/1.5A
Operational & Functional Characteristic	
Firmware Platform	AMIT Proprietary Kernel
Management Method	Web-based
Supported WAN Type	Static IP Address
	Dynamic IP Address (DHCP Client)
	PPP over Ethernet
	Multi-session PPP over Ethernet (For Japan only)
	PPTP
	L2TP
Connection Scheme	Connect on Demand / Auto-Disconnect
	Manually Connect/Disconnect
	Auto Reconnect
NAT Functionality	One-to-Many NAT
	One-to-One NAT
	Virtual Server
	Special Application
	DMZ Host
Access Control	MAC-level Access Control
	Inbound/Outbound IP Filter
	Domain Access Control
Firewall	NAT Firewall with SPI mode
	DoS Detection
Event Logging	On-web logging
	Syslog supported
	Email Alert
VPN Supporting	IPSec, PPTP, LT2P Pass-Through
Routing	Static Route

Upgrade Method	Web-based
	Windows Application
Other Features	DDNS Supported
	UPnP Supported
	SNMP Supported
Wireless Support	
Solution	Ralink 802.11g on Board
Standard	IEEE 802.11b / 802.11g
Data Rate*	6/12/18/24/36/48/54Mbps in 802.11g mode 1/2/5.5/11Mbps in 802.11b mode
Operating Frequency	2.4GHz
Range Coverage	Per cell indoors approx. 35-100 meters Per cell outdoors up to 100-300 meters
Antenna	2 dBi dipole antenna x 1
Number of Channels	America/ FCC: 2.412~2.462GHz (11 Channels) Japan/ TELEC: 2.412~2.484GHz (14 Channels) Europe/ ETSI: 2.412~2.472GHz (13 Channels)
Security	WEP encryption and WPA supported
Environment, Certification and Reliability	
Operating Temperature	Temperature: 0~40°C, Humidity 10%~90% non-condensing
Storage Temperature	Temperature: -20~70°C, Humidity: 0~95% non-condensing
EMC/Safety	FCC, CE
Reliability	Stress Test; Vibration Test; Drop Test

** Maximum wireless signal rate based on IEEE 802.11 series standard specifications. Actual data throughput will vary. Network conditions and environmental factors lower actual data throughput rate.*