



# User Manual

## Full HD Wi-Fi Camera

DCS-8300LH

---

# Preface

D-Link reserves the right to revise this publication and to make changes in the content hereof without obligation to notify any person or organization of such revisions or changes. Information in this document may become obsolete as our services and websites develop and change. Please refer to the [www.mydlink.com](http://www.mydlink.com) website for the most current information.

## Manual Revisions

Revision	Date	Description
1.00	08/09/2016	DCS-8300LH Revision A1 with firmware version 1.00
1.01	3/21/2018	Technical specifications, mydlink app and other minor edits

## Trademarks

D-Link and the D-Link logo are trademarks or registered trademarks of D-Link Corporation or its subsidiaries in the United States or other countries. All other company or product names mentioned herein are trademarks or registered trademarks of their respective companies.

Copyright © 2018 D-Link Corporation.

All rights reserved. This publication may not be reproduced, in whole or in part, without prior expressed written permission from D-Link Corporation.

---

# Table of Contents

<b>Product Overview</b> .....	<b>4</b>
Package Contents.....	4
Introduction .....	5
System Requirements .....	5
Features.....	6
Hardware Overview .....	7
Front View.....	7
Rear View .....	8
<b>Installation</b> .....	<b>9</b>
Safety .....	9
Before you Begin.....	9
Wireless Installation Considerations.....	10
Setting up the Camera.....	11
Mounting the Camera.....	13
<b>mydlink</b> .....	<b>15</b>
Using the mydlink App.....	15
<b>Troubleshooting</b> .....	<b>18</b>
<b>Technical Specifications</b> .....	<b>19</b>
<b>Regulatory Information</b> .....	<b>21</b>

# Product Overview

## Package Contents



DCS-8300LH Full HD Wi-Fi Camera



Power adapter



Quick Installation Guide



If any of the above items are missing, please contact your reseller.

**Note:** Using a power supply with a different voltage than the one included with your product will cause damage and void the warranty for this product.

## Introduction

Congratulations on your purchase of the DCS-8300LH Full HD Wi-Fi Camera. The DCS-8300LH is a versatile and unique solution for your small office or home. Unlike a standard webcam, the DCS-8300LH boasts a 120-degree wide-angle lens that easily captures your entire room, wall-to-wall, in high definition 720p. The DCS-8300LH can be accessed from anywhere with Internet access through the new mydlink™ App. The simple installation and intuitive mobile app interface offer you a easy and convenient way to look after your family or check in on your office. The motion and sound level detection with built-in IR LEDs to capture video in low-light or completely dark environments combined with event notifications features will help bring you peace of mind when it comes the security or well-being of your home or small office.

## System Requirements

- iPhone, iPad, Android, or Windows smartphone or tablet (please refer to the mobile app's store page to check whether your device is compatible) with bluetooth 4.0
- latest version of mydlink app from your operating system's application store (available for iPhone, iPad and Android™ devices)
- 802.11n/g wireless router
- (optional) A MicroSD memory card is required for recording to onboard storage. SDHC Class 6 or above is recommended.
- broadband Internet connection
- e-mail account (required for mydlink service registration)

## Features

### **24/7 Complete Coverage**

The DCS-8300LH uses a 137° wide-angle lens and a 1080p HD sensor to give you a clear view of an entire room with a single camera. The DCS-8300LH enables round-the-clock monitoring with built-in infrared LEDs allowing up to 16 feet of night time viewing. The special fold-out design makes ceiling, wall, and counter-top installations a breeze while wireless 802.11n keeps cabling to a minimum.

### **Anytime Anywhere Notifications**

The DCS-8300LH helps you keep watch over the things that are important to you with built-in motion detection that can send push notifications to your mobile phone and automatically record snapshots and video clips to a microSD card or to your cloud account. Sound detection will notify you of loud noises, such as a baby crying or glass breaking, making it ideal for use as a baby monitor or office camera.

### **Do it All with the mydlink™ App**

Now enhanced with the new mydlink™ app, the DCS-8300LH makes it easier and more convenient for you to look after your family at home or check in on your office — from anywhere with Internet access. Simply install the app on your mobile device and you'll be able to set up, view, and manage your camera using your tablet or mobile phone.<sup>3</sup> With the mydlink™ app, you can always feel protected.

### **Automated Uploads Through mydlink™ Cloud Recording**

Enhanced with mydlink™ cloud recording support, the DCS-8300LH makes it easy and convenient for you to look after your family and check up on your home or office. With a mydlink™ cloud recording subscription, you can have peace of mind with your video recordings sent automatically to a cloud server. Play back recordings from the cloud or download video clips to your mobile device from anywhere, anytime through the Internet. Access real-time live views of your cameras using the mydlink™ mobile app and set automated schedules via your mobile device, no matter where you are.

## Hardware Overview Front View



1	<b>Microphone</b>	Records audio of the surrounding area
2	<b>Light Sensor</b>	The IR-Cut Removable sensor measures the lighting conditions
3	<b>Camera Lens</b>	Records video of the surrounding area
4	<b>IR LEDs</b>	Infrared LEDs illuminate the camera's field of view at night
5	<b>Camera Stand</b>	Used to mount the camera on flat surface

## Connections View



1	Speaker	Allows you to broadcast your voice remotely through the mobile app
2	Status LED	Indicates the camera's current status. <i>Solid Green: Successfully connected</i> <i>Blinking Green: Connection process in progress</i> <i>Solid Red: Camera is booting, or firmware upgrade is in progress</i>
3	MicroUSB Connector	Micro-USB connector for the supplied power adaptor (for power only)
4	microSD Slot	Slot to insert microSD card for video/still storage
5	Reset Button	Press and hold for 10 seconds to reset to factory default settings



# Safety

Please read all of the safety and operating instructions before using your device:

1. Do not open the device or attempt to repair or service it.
2. Use the device in a dry location, and avoid placing it in a humid environment.
3. Do not submerge the device in liquid or attempt to clean it with liquids or solvents. To clean the device, disconnect from the power outlet and use a damp towel.
4. This device should only be used indoors.

## Before you Begin

Plan the location of your cameras:

1. Connect cameras into electrical outlets that are not controlled by a wall switch. This will help you to avoid accidentally turning off power to the device.
2. Verify that your cameras are electrically rated to operate with the power available in your location.
3. Be sure to plug the power cables into properly grounded electrical outlets in order to help prevent against electrical shock.

## Wireless Installation Considerations

The DCS-8300LH connects to your network using a wireless connection from anywhere within the operating range of your wireless network. However, the number, thickness and location of walls, ceilings, or other objects that the wireless signals must pass through, may limit the range. Typical ranges vary depending on the types of materials and background RF (radio frequency) noise in your home or business. The key to maximizing wireless range is to follow these basic guidelines:

1. Minimize the number of walls and ceilings between your adapter and other network devices - each wall or ceiling can reduce your adapter's range from 3-90 feet (1-30 meters).
2. Be aware of the direct line between network devices. A wall that is 1.5 feet thick (.5 meters), at a 45-degree angle appears to be almost 3 feet (1 meter) thick. At a 2-degree angle, it looks over 42 feet (14 meters) thick. Position your devices so that the signal will travel straight through a wall or ceiling (instead of at an angle) for better reception.
3. Building materials make a difference. A solid metal door or aluminum studs may weaken the wireless signal. Try to position your access points, wireless routers, and other networking devices where the signal passes through drywall or open doorways. Materials and objects such as glass, steel, metal, walls with insulation, water (fish tanks), mirrors, file cabinets, brick, and concrete will degrade your wireless signal.
4. Keep your product at least 3-6 feet or 1-2 meters away from electrical devices or appliances that generate RF noise.
5. If you are using 2.4 GHz cordless phones or other radio frequency sources (such as microwave ovens), your wireless connection may degrade dramatically or drop completely. Make sure your 2.4 GHz phone base is as far away from your wireless devices as possible. The base transmits a signal even if the phone is not in use.

# Setting up the Camera

Please follow the instructions below to set up your Full HD Wi-Fi Camera.

## Step 1:

Download the **mydlink** app from the App Store (iPhone or iPad) or Google Play (Android).

**Note:** Ensure your device is connected wirelessly to the network that DCS-8300LH will be in.



## Step 2:

Launch the mydlink app and create a new account or sign in to your existing account.

**iOS:** If you are asked about allowing the app to access your location, select **Allow**.

**Android:** Make sure location services are turned on in your phone's settings.



### Step 3:

After logging in, tap the Menu icon  in the top-left corner, select **Add New Device** and follow the on-screen instructions to connect to your camera. Bluetooth needs to be enabled on your phone.

When you are asked to scan a QR code, use the code on the Quick Install Card in your package, or on the label attached to your device.

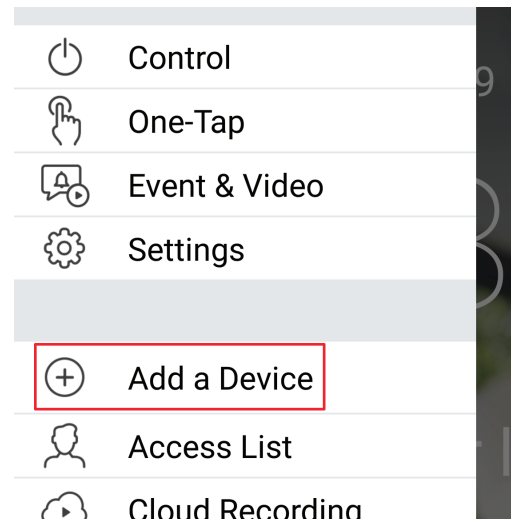

### Step 4:

Congratulations, your Full HD Wi-Fi Camera is now ready to use!

Be sure to check the **www.mydlink.com** website periodically for the latest firmware updates to keep your product secure and up to date with the latest features.

**Note:** If you experience issues registering this camera with your mydlink account, or if you purchased an open box or resold unit, perform a hard reset by pressing and holding the reset button on the device for 10 seconds while the device is powered on.

## Mounting the Camera

To mount your camera on a wall or ceiling, please follow the steps below. It is recommended that you configure the camera before mounting.

### Step 1

Rotate the baseplate counter-clockwise and remove it.

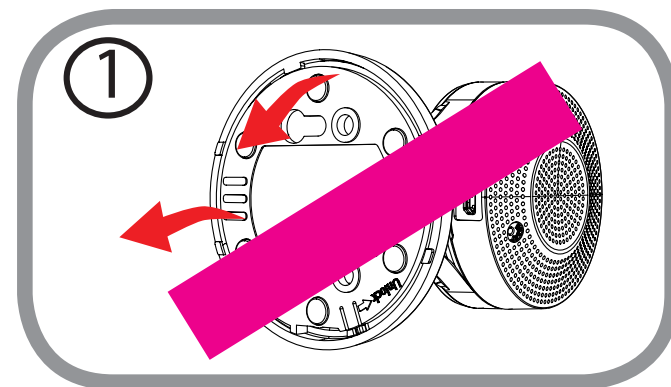

### Step 2

Place the baseplate where you want to position the camera and use a pencil to mark the holes. You can use the lower holes for a removable installation, or the top holes for a fixed one. Make sure that the arrow on the baseplate is pointing up.

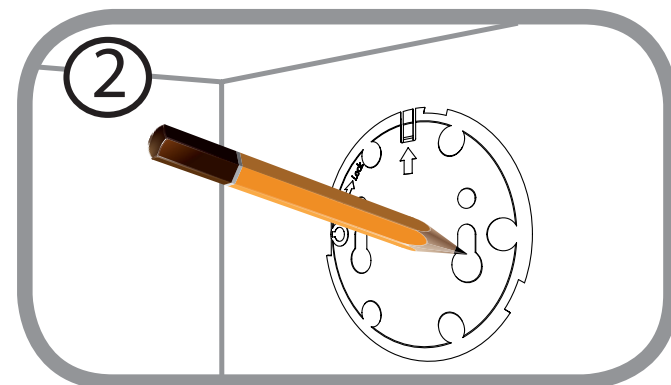

### Step 3

Depending on the material of the wall or ceiling, use proper tools to drill holes 25 mm deep with a 6 mm drill bit where you marked. If the wall is made out of concrete, drill the holes first, then insert the plastic anchors to support the screws.

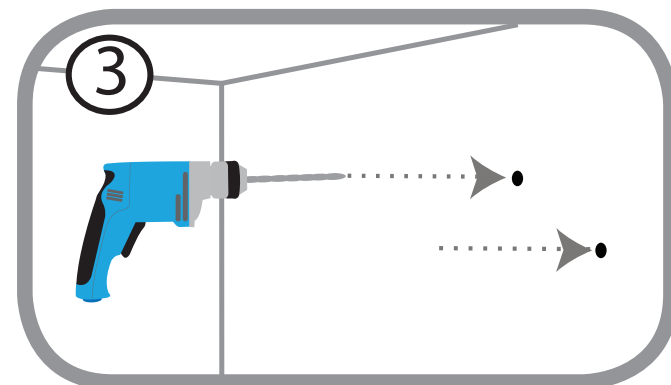

## Section 2: Installation

### Step 4

Place the baseplate over the holes that are in the wall. Make sure to align the baseplate holes with the holes in the wall. Use the supplied screws to attach the baseplate to the surface of the wall.

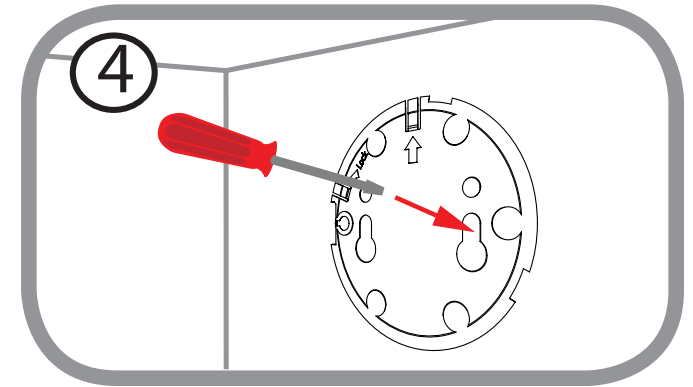

### Step 5

Place the camera over the baseplate with the alignment nub pointing left, then attach the camera by rotating it until the alignment nub points up.

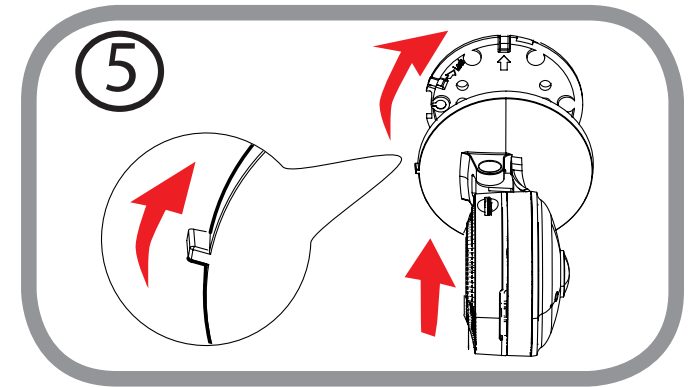

### Step 6

Adjust the angle and rotation of the camera as desired. You can also rotate the camera on the baseplate about 45° to the right or left.

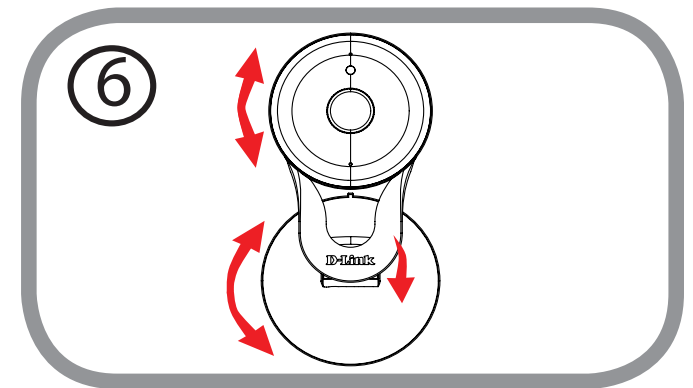

# Using the mydlink™ App

After setting up your DCS-8300LH camera with a mydlink account in the mydlink app, you will be able to remotely access your camera through the app. After signing in to your mydlink account, you will see a screen similar to the following.

If you have previously enabled "Add to shortcut" option while installing the camera, you will see a quick link to your camera directly on the home screen.

**Note:** Screenshots are representative only. The mydlink app is constantly improving and so may appear different.

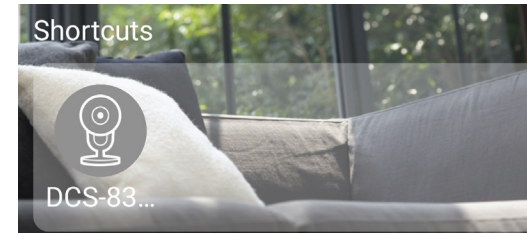

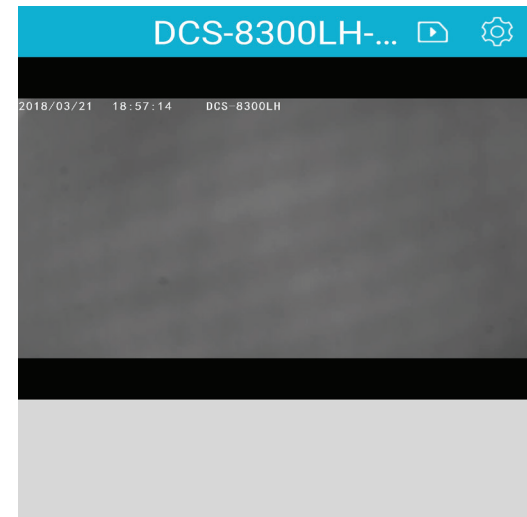

Click on the shortcut link to your camera on the home screen and by default you will see a live video feed of your camera on the top half of the app.



# Using the mydlink™ App

On the bottom half of the app you will see control options for your camera.



	<b>Options Toggle</b>	Click on this icon to review various live video options such as toggling microphone and speaker on-and-off and selecting the video quality
	<b>Recording</b>	Click on this button to enable recording of the video stream.
	<b>Snapshot</b>	Click on this button to take a snapshot from the video stream.

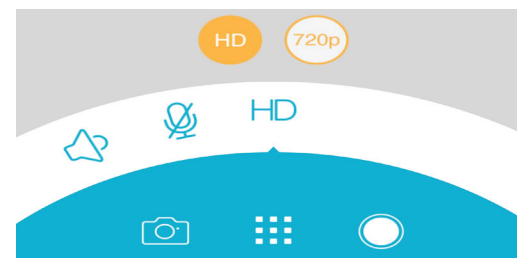
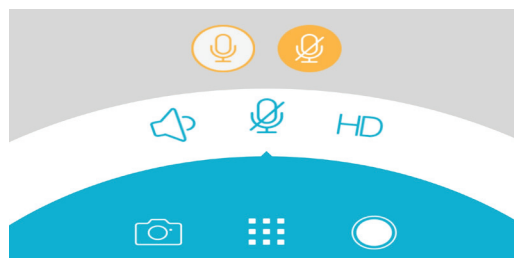
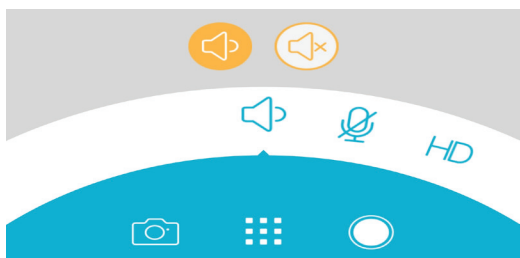

Note: Speaker is half-duplex only; it lets you hear and speak from the DCS-8300LH's microphone and speaker via the mydlink app, but only one-way at a time.



# Using the mydlink™ App

Upper right hand corner of the app is the settings button (gear icon). The Settings page contains several options for you to control how your DCS-8300LH operates.

**Device Name:** Click on the **name to change** how the camera name appears.

**Device location:** Click on the location to change the location of the camera.

**Wi-Fi:** Click on the Wi-Fi SSID to change which Wi-Fi network you want the camera to connect to.

**Microphone:** Toggle sound recording on and off.

**Motion Setting:** Click to further configure sensitivity and active area of motion detection of camera.

**Night Vision:** Click to change night vision detection to on/off/auto.

**Privacy Mode:** Click to enable Privacy Mode. Privacy mode will disable camera feed until you disable it again.

**Storage:** Click to change storage options from SD Card to Cloud. You can also subscribe to myDlink Cloud from here and view your current subscription plan.

**Upgrade Time:** Shows time of auto firmware upgrade. Click to change firmware upgrade options.

**Device ID:** Shows unique device ID number for your camera.

**Current Firmware Version:** Shows current firmware version of device.

Device Name	DCS-8300LH-7E03 >
Device Location	Great Room >
Wi-Fi	dlink-05AB >
 Camera	
Microphone	<input checked="" type="checkbox"/>
Motion Setting	>
Night Vision	Auto >
Privacy Mode	<input type="checkbox"/>
Storage	SD Card >
Upgrade Time	02:00 >
Device ID	44449844
Current Firmware Version	v1.00.01
<a href="#">Remove Device</a>	

Remove Device button will remove your device from the myDlink app.

# Troubleshooting

**1. How can I access my DCS-8300LH remotely through the Internet?**

In order to use your DCS-8300LH remotely through the Internet using the mydlink app, you must register your camera with a mydlink account. You can do this using the free mydlink app. Please go to **Using the mydlink™ App on page <?>** for more information.

**2. How do I update the firmware of my camera?**

You can update your camera's firmware by using the mydlink app. For more information, please see page 17.

**4: What do I need to do before I upgrade from the mydlink Lite app to the mydlink app?**

Please refer to the app's store page for device compatibility requirements.

**Note: You can use the same mydlink account to log into the mydlink app.**

**5: Do I have to sign up for a new mydlink account when transferring to the mydlink app?**

No, you don't need to sign up for a new mydlink account. You have to Sign In the mydlink app using your existing mydlink account and all your existing devices will show up in the mydlink app.

# Technical Specifications

Camera		
Hardware Profile	<ul style="list-style-type: none"> <li>• 1/2.7" Megapixel progressive CMOS sensor</li> <li>• 5 m (16 ft) IR illumination distance</li> <li>• Minimum illumination:               <ul style="list-style-type: none"> <li>• B/W (Night Mode), IR LEDs on: 0 lux</li> </ul> </li> <li>• Built-in Infrared-Cut Removable (ICR) Filter module</li> <li>• Fixed length 2.7 mm</li> </ul>	<ul style="list-style-type: none"> <li>• Aperture F2.4</li> <li>• Angle of view               <ul style="list-style-type: none"> <li>• Horizontal: 137°</li> <li>• Vertical: 71°</li> <li>• Diagonal: 167°</li> </ul> </li> <li>• Built-in microphone</li> <li>• Built-in speaker</li> </ul>
Image Features	<ul style="list-style-type: none"> <li>• Configurable image size</li> <li>• Configurable sound level detection</li> </ul>	<ul style="list-style-type: none"> <li>• Configurable motion detection windows</li> </ul>
Video Compression	<ul style="list-style-type: none"> <li>• Simultaneous H.264/MJPEG format compression</li> </ul>	<ul style="list-style-type: none"> <li>• JPEG for still images</li> </ul>
Video Resolution	<ul style="list-style-type: none"> <li>• Main Profile: 1080P (1920 x 1080) at up to 30 fps</li> </ul>	<ul style="list-style-type: none"> <li>• Second Profile: 720P (1280 x 720) at up to 15 fps</li> </ul>
Audio Support	<ul style="list-style-type: none"> <li>• MPEG-2 AAC LC</li> </ul>	
Network		
Connectivity	<ul style="list-style-type: none"> <li>• 802.11n/g/b wireless with WPA/WPA2 encryption<sup>1</sup></li> <li>• Operates on 2.4 GHz band</li> <li>• microSD card slot<sup>2</sup></li> </ul>	<ul style="list-style-type: none"> <li>• Single-band 2T2R mode supports a maximum data rate of 72.2 Mbps (PHY rate) using 20 MHz bandwidth<sup>1</sup></li> <li>• Bluetooth 2.1/3.0/4.0</li> </ul>
Network Protocols	<ul style="list-style-type: none"> <li>• IPv4, IPv6, ARP, TCP, UDP, ICMP</li> <li>• DHCP Client</li> <li>• DNS Client</li> </ul>	<ul style="list-style-type: none"> <li>• RTP, RTSP/SRTP</li> <li>• HTTPS</li> <li>• Bonjour</li> </ul>
System Integration		
Event Management	<ul style="list-style-type: none"> <li>• Motion detection</li> <li>• Sound detection</li> <li>• Cloud recording</li> </ul>	<ul style="list-style-type: none"> <li>• Manually taken snapshots and video clips are saved to mobile device</li> <li>• Push Notification</li> </ul>
Mobile Support	<ul style="list-style-type: none"> <li>• mylink™ app for iPhone, iPad, and Android phone and tablet</li> </ul>	<ul style="list-style-type: none"> <li>• Manually taken snapshots and video clips are saved to mobile device</li> <li>• Push Notification</li> </ul>

## Appendix A: Technical Specifications

General	
Environment	• For Indoor use Only
Weight	• 105 g (3.7 oz) ± 5%
Power Adapter	• Input: 100 to 240 V AC, 50/60 Hz • Output: 5 V DC 1.2A (Micro-USB)
Power Consumption	• Maximum 5 W ± 5%
Temperature	• Operating: 0 to 40 °C (32 to 104 °F) • Storage: -20 to 70 °C (-4 to 158 °F)
Humidity	• Operating: 20% to 80% non-condensing • Storage: 5% to 95% non-condensing
Certifications	• CE • CE LVD • RCM • FCC Class B • ICES
Dimensions	• 66 x 66 x 109.6 mm (2.6 x 2.6 x 4.31 in)
Dimensions Diagram	<p>The diagram illustrates the physical dimensions of the D-Link DCS-8300LH camera. It includes two views: a front view and a side view. The front view shows a circular lens assembly with a diameter of 60.7 mm and a total height of 109.6 mm. The side view shows the camera's profile with a lens width of 34.4 mm and a base diameter of 66 mm. The D-Link logo is visible on the front view.</p>

# Regulatory Information

## Federal Communication Commission Interference Statement

This equipment has been tested and found to comply with the limits for a Class B digital device, pursuant to Part 15 of the FCC Rules. These limits are designed to provide reasonable protection against harmful interference in a residential installation. This equipment generates, uses and can radiate radio frequency energy and, if not installed and used in accordance with the instructions, may cause harmful interference to radio communications. However, there is no guarantee that interference will not occur in a particular installation. If this equipment does cause harmful interference to radio or television reception, which can be determined by turning the equipment off and on, the user is encouraged to try to correct the interference by one of the following measures:

- Reorient or relocate the receiving antenna.
- Increase the separation between the equipment and receiver.
- Connect the equipment into an outlet on a circuit different from that to which the receiver is connected.
- Consult the dealer or an experienced radio/TV technician for help.

## Non-modifications Statement:

Any changes or modifications not expressly approved by the party responsible for compliance could void the user's authority to operate this equipment.

## Caution:

This device complies with Part 15 of the FCC Rules. Operation is subject to the following two conditions:

- (1) This device may not cause harmful interference, and
- (2) this device must accept any interference received, including interference that may cause undesired operation.

This device and its antenna(s) must not be co-located or operating in conjunction with any other antenna or transmitter except in accordance with FCC multi-transmitter product procedures. For product available in the USA/Canada market, only channel 1~11 can be operated. Selection of other channels is not possible.

## Note

The country code selection is for non-USA models only and is not available to all USA models. Per FCC regulations, all WiFi product marketed in the USA must be fixed to USA operational channels only.

### **IMPORTANT NOTICE:**

#### **FCC Radiation Exposure Statement**

This equipment complies with FCC radiation exposure limits set forth for an uncontrolled environment. This equipment should be installed and operated with minimum distance 20 cm between the radiator and your body.

#### **Innovation, Science and Economic Development Canada (ISED) Statement:**

This Class B digital apparatus complies with Canadian ICES-003.

Cet appareil numérique de la classe B est conforme à la norme NMB-003 du Canada.

#### **Innovation, Science and Economic Development Canada (ISED) Statement:**

This device complies with ISED licence-exempt RSS standard(s). Operation is subject to the following two conditions:

- (1) this device may not cause interference, and
- (2) this device must accept any interference, including interference that may cause undesired operation of the device.

Le présent appareil est conforme aux CNR d'ISED applicables aux appareils radio exempts de licence. L'exploitation est autorisée aux deux conditions suivantes :

- (1) l'appareil ne doit pas produire de brouillage, et
- (2) l'utilisateur de l'appareil doit accepter tout brouillage radioélectrique subi, même si le brouillage est susceptible d'en compromettre le fonctionnement.

#### **Radiation Exposure Statement**

This equipment complies with ISED radiation exposure limits set forth for an uncontrolled environment. This equipment should be installed and operated with minimum distance 20 cm between the radiator and your body.

#### **Déclaration d'exposition aux radiations**

Cet équipement est conforme aux limites d'exposition aux rayonnements ISED établies pour un environnement non contrôlé. Cet équipement doit être installé et utilisé avec un minimum de 20 cm de distance entre la source de rayonnement et votre corps.

## **NCC 警語：**

### **以下警語適用台灣地區**

依據 低功率電波輻射性電機管理辦法

第十二條: 經型式認證合格之低功率射頻電機，非經許可，公司、商號或使用者均不得擅自變更頻率、加大功率或變更原設計之特性及功能。

第十四條: 低功率射頻電機之使用不得影響飛航安全及干擾合法通信；經發現有干擾現象時，應立即停用，並改善至無干擾時方得繼續使用。前項合法通信，指依電信法規定作業之無線電通信。低功率射頻電機須忍受合法通信或工業、科學及醫療用電波輻射性電機設備之干擾。

電磁波曝露量MPE標準值(MPE)  $1 \text{ mW/cm}^2$ ，送測產品實值為  $<\text{mW/cm}^2> \text{ mW/cm}^2$

## European Community Declaration of Conformity:

Česky [Czech]	Tímto D-Link Corporation prohlašuje, že tento produkt, jeho příslušenství a software jsou v souladu se směrnicí 2014/53/EU. Celý text ES prohlášení o shodě vydaného EU a o firmwaru produktu lze stáhnout na stránkách k produktu <a href="http://www.dlink.com">www.dlink.com</a> .
Dansk [Danish]	D-Link Corporation erklærer herved, at dette produkt, tilbehør og software er i overensstemmelse med direktiv 2014/53/EU. Den fulde tekst i EU-overensstemmelseserklæringen og produktfirmware kan wnloades fra produktsiden hos <a href="http://www.dlink.com">www.dlink.com</a> .
Deutsch [German]	Hiermit erklärt die D-Link Corporation, dass dieses Produkt, das Zubehör und die Software der Richtlinie 2014/53/EU entsprechen. Der vollständige Text der Konformitätserklärung der Europäischen Gemeinschaft sowie die Firmware zum Produkt stehen Ihnen zum Herunterladen von der Produktseite im Internet auf <a href="http://www.dlink.com">www.dlink.com</a> zur Verfügung.
Eesti [Estonian]	Käesolevaga kinnitab D-Link Corporation, et see toode, tarvikud ja tarkvara on kooskõlas direktiiviga 2014/53/EL. Euroopa Liidu vastavusdeklaratsiooni täistekst ja toote püsivara on allalaadimiseks saadaval tootelehel <a href="http://www.dlink.com">www.dlink.com</a> .
English	Hereby, D-Link Corporation, declares that this product, accessories, and software are in compliance with directive 2014/53/EU. The full text of the EU Declaration of Conformity and product firmware are available for download from the product page at <a href="http://www.dlink.com">www.dlink.com</a>
Español [Spanish]	Por la presente, D-Link Corporation declara que este producto, accesorios y software cumplen con las directivas 2014/53/UE. El texto completo de la declaración de conformidad de la UE y el firmware del producto están disponibles y se pueden descargar desde la página del producto en <a href="http://www.dlink.com">www.dlink.com</a> .
Ελληνική [Greek]	Με την παρούσα, η D-Link Corporation δηλώνει ότι αυτό το προϊόν, τα αξεσουάρ και το λογισμικό συμμορφώνονται με την Οδηγία 2014/53/ΕΕ. Το πλήρες κείμενο της δήλωσης συμμόρφωσης της ΕΕ και το υλικολογισμικό του προϊόντος είναι διαθέσιμα για λήψη από τη σελίδα του προϊόντος στην τοποθεσία <a href="http://www.dlink.com">www.dlink.com</a> .
Français [French]	Par les présentes, D-Link Corporation déclare que ce produit, ces accessoires et ce logiciel sont conformes aux directives 2014/53/UE. Le texte complet de la déclaration de conformité de l'UE et le microprogramme du produit sont disponibles au téléchargement sur la page des produits à <a href="http://www.dlink.com">www.dlink.com</a> .
Italiano [Italian]	Con la presente, D-Link Corporation dichiara che questo prodotto, i relativi accessori e il software sono conformi alla direttiva 2014/53/UE. Il testo completo della dichiarazione di conformità UE e il firmware del prodotto sono disponibili per il download dalla pagina del prodotto su <a href="http://www.dlink.com">www.dlink.com</a> .



## Appendix B: Regulatory Information

Latviski [Latvian]	Ar šo uzņēmums D-Link Corporation apliecina, ka šis produkts, piederumi un programmatūra atbilst direktīvai 2014/53/ES. ES atbilstības deklarācijas pilno tekstu un produkta aparātprogrammatūru var lejupielādēt attiecīgā produkta lapā vietnē <a href="http://www.dlink.com">www.dlink.com</a> .
Lietuvių [Lithuanian]	Šiuo dokumentu „D-Link Corporation“ pareiškia, kad šis gaminys, priedai ir programinė įranga atitinka direktyvą 2014/53/ES. Visą ES atitikties deklaracijos tekstą ir gaminio programinę aparatinę įrangą galima atsisiųsti iš gaminio puslapio adresu <a href="http://www.dlink.com">www.dlink.com</a> .
Nederlands [Dutch]	Hierbij verklaart D-Link Corporation dat dit product, accessoires en software voldoen aan de richtlijnen 2014/53/EU. De volledige tekst van de EU conformiteitsverklaring en productfirmware is beschikbaar voor download van de productpagina op <a href="http://www.dlink.com">www.dlink.com</a> .
Malti [Maltese]	Bil-preżenti, D-Link Corporation tiddikjara li dan il-prodott, l-aċċessorji, u s-software huma konformi mad-Direttiva 2014/53/UE. Tista' tniżżel it-test sħiħ tad-dikjarazzjoni ta' konformità tal-UE u l-firmware tal-prodott mill-paġna tal-prodott fuq <a href="http://www.dlink.com">www.dlink.com</a> .
Magyar [Hungarian]	Ezennel a D-Link Corporation kijelenti, hogy a jelen termék, annak tartozékai és szoftvere megfelelnek a 2014/53/EU sz. rendeletnek. Az EU Megfelelőségi nyilatkozat teljes szövege és a termék firmware a termék oldaláról tölthető le a <a href="http://www.dlink.com">www.dlink.com</a> címen.
Polski [Polish]	D-Link Corporation niniejszym oświadcza, że ten produkt, akcesoria oraz oprogramowanie są zgodne z dyrektywami 2014/53/EU. Pełen tekst deklaracji zgodności UE oraz oprogramowanie sprzętowe do produktu można pobrać na stronie produktu w witrynie <a href="http://www.dlink.com">www.dlink.com</a> .
Português [Portuguese]	Desta forma, a D-Link Corporation declara que este produto, os acessórios e o software estão em conformidade com a diretiva 2014/53/UE. O texto completo da declaração de conformidade da UE e do firmware
Slovensko[Slovenian]	Podjetje D-Link Corporation s tem izjavlja, da so ta izdelek, dodatna oprema in programnska oprema skladni z direktivami 2014/53/EU. Celotno besedilo izjave o skladnosti EU in vdelana programska oprema sta na voljo za prenos na strani izdelka na <a href="http://www.dlink.com">www.dlink.com</a> .
Slovensky [Slovak]	Spoločnosť D-Link týmto vyhlasuje, že tento produkt, príslušenstvo a softvér sú v súlade so smernicou 2014/53/EÚ. Úplné znenie vyhlásenia EÚ o zhode a firmvéri produktu sú k dispozícii na prevzatie zo stránky produktu <a href="http://www.dlink.com">www.dlink.com</a> .
Suomi [Finnish]	D-Link Corporation täten vakuuttaa, että tämä tuote, lisävarusteet ja ohjelmisto ovat direktiivin 2014/53/EU vaatimusten mukaisia. Täydellinen EU-vaatimustenmukaisuusvakuutus samoin kuin tuotteen laiteohjelmisto ovat ladattavissa osoitteesta <a href="http://www.dlink.com">www.dlink.com</a> .

## Appendix B: Regulatory Information

---

Svenska [Swedish]	D-Link Corporation försäkrar härmed att denna produkt, tillbehör och programvara överensstämmer med direktiv 2014/53/EU. Hela texten med EU-försäkran om överensstämmelse och produkt-firmware kan hämtas från produktsidan på <a href="http://www.dlink.com">www.dlink.com</a> .
Íslenska [Icelandic]	Hér með lýsir D-Link Corporation því yfir að þessi vara, fylgihlutir og hugbúnaður eru í samræmi við tilskipun 2014/53/EB. Sækja má ESB-samræmisýfirlýsinguna í heild sinni og fastbúnað vörunnar af vefsíðu vörunnar á <a href="http://www.dlink.com">www.dlink.com</a> .
Norsk [Norwegian]	Herved erklærer D-Link Corporation at dette produktet, tilbehøret og programvaren er i samsvar med direktivet 2014/53/EU. Den fullstendige teksten i EU-erklæring om samsvar og produktets fastvare er tilgjengelig for nedlasting fra produktsiden på <a href="http://www.dlink.com">www.dlink.com</a> .

### **Warning Statement:**

The power outlet should be near the device and easily accessible.

### **NOTICE OF WIRELESS RADIO LAN USAGE IN THE EUROPEAN COMMUNITY (FOR WIRELESS PRODUCT ONLY):**

- This device is restricted to indoor use when operated in the European Community using channels in the 5.15-5.35 GHz band to reduce the potential for interference.
- This device is a 2.4 GHz wideband transmission system (transceiver), intended for use in all EU member states and EFTA countries. This equipment may be operated in AL, AD, BE, BG, DK, DE, FI, FR, GR, GW, IS, IT, HR, LI, LU, MT, MK, MD, MC, NL, NO, AT, PL, PT, RO, SM, SE, RS, SK, ES, CI, HU, and CY.

#### **Usage Notes:**

- To remain in conformance with European National spectrum usage regulations, frequency and channel limitations will be applied on the products according to the country where the equipment will be deployed.
- This device is restricted from functioning in Ad-hoc mode while operating in 5 GHz. Ad-hoc mode is direct peer-to-peer communication between two client devices without an Access Point.
- Access points will support DFS (Dynamic Frequency Selection) and TPC (Transmit Power Control) functionality as required when operating in 5 GHz band within the EU.
- Please refer to the product manual or datasheet to check whether your product uses 2.4 GHz and/or 5 GHz wireless.

### **HINWEIS ZUR VERWENDUNG VON DRAHTLOS-NETZWERK (WLAN) IN DER EUROPÄISCHEN GEMEINSCHAFT ( NUR FÜR EIN DRAHTLOSES PRODUKT )**

- Der Betrieb dieses Geräts in der Europäischen Gemeinschaft bei Nutzung von Kanälen im 5,15-5,35 GHz Frequenzband ist ausschließlich auf Innenräume beschränkt, um das Interferenzpotential zu reduzieren.
- Bei diesem Gerät handelt es sich um ein zum Einsatz in allen EU-Mitgliedsstaaten und in EFTA-Ländern - ausgenommen Frankreich. Der Betrieb dieses Geräts ist in den folgenden Ländern erlaubt: AL, AD, BE, BG, DK, DE, FI, FR, GR, GW, IS, IT, HR, LI, LU, MT, MK, MD, MC, NL, NO, AT, PL, PT, RO, SM, SE, RS, SK, ES, CI, HU, CY

#### **Gebrauchshinweise:**

- Um den in Europa geltenden nationalen Vorschriften zum Nutzen des Funkspektrums weiterhin zu entsprechen, werden Frequenz und Kanalbeschränkungen, dem jeweiligen Land, in dem das Gerät zum Einsatz kommt, entsprechend, auf die Produkte angewandt.
- Die Funktionalität im Ad-hoc-Modus bei Betrieb auf 5 GHz ist für dieses Gerät eingeschränkt. Bei dem Ad-hoc-Modus handelt es sich um eine Peer-to-Peer-Kommunikation zwischen zwei Client-Geräten ohne einen Access Point.
- Access Points unterstützen die Funktionen DFS (Dynamic Frequency Selection) und TPC (Transmit Power Control) wie erforderlich bei Betrieb auf 5 GHz innerhalb der EU.
- Bitte schlagen Sie im Handbuch oder Datenblatt nach, ob Ihr Gerät eine 2,4 GHz und / oder 5 GHz Verbindung nutzt.

## **AVIS CONCERNANT L'UTILISATION DE LA RADIO SANS FIL LAN DANS LA COMMUNAUTÉ EUROPÉENNE (UNIQUEMENT POUR LES PRODUITS SANS FIL)**

- Cet appareil est limité à un usage intérieur lorsqu'il est utilisé dans la Communauté européenne sur les canaux de la bande de 5,15 à 5,35 GHz afin de réduire les risques d'interférences.
- Cet appareil est un système de transmission à large bande (émetteur-récepteur) de 2,4 GHz, destiné à être utilisé dans tous les États-membres de l'UE et les pays de l'AELE. Cet équipement peut être utilisé dans les pays suivants : AL, AD, BE, BG, DK, DE, FI, FR, GR, GW, IS, IT, HR, LI, LU, MT, MK, MD, MC, NL, NO, AT, PL, PT, RO, SM, SE, RS, SK, ES, CI, HU, CY

### **Notes d'utilisation:**

- Pour rester en conformité avec la réglementation nationale européenne en matière d'utilisation du spectre, des limites de fréquence et de canal seront appliquées aux produits selon le pays où l'équipement sera déployé.
- Cet appareil ne peut pas utiliser le mode Ad-hoc lorsqu'il fonctionne dans la bande de 5 GHz. Le mode Adhoc fournit une communication directe pair à pair entre deux périphériques clients sans point d'accès.
- Les points d'accès prendront en charge les fonctionnalités DFS (Dynamic Frequency Selection) et TPC (Transmit Power Control) au besoin lors du fonctionnement dans la bande de 5 GHz au sein de l'UE.
- Merci de vous référer au guide d'utilisation ou de la fiche technique afin de vérifier si votre produit utilise 2.4 GHz et/ou 5 GHz sans fil.

## **AVISO DE USO DE LA LAN DE RADIO INALÁMBRICA EN LA COMUNIDAD EUROPEA (SOLO PARA EL PRODUCTO INALÁMBRICO)**

- El uso de este dispositivo está restringido a interiores cuando funciona en la Comunidad Europea utilizando canales en la banda de 5,15-5,35 GHz, para reducir la posibilidad de interferencias.
- Este dispositivo es un sistema de transmisión (transceptor) de banda ancha de 2,4 GHz, pensado para su uso en todos los estados miembros de la UE y en los países de la AELC. Este equipo se puede utilizar en AL, AD, BE, BG, DK, DE, FI, FR, GR, GW, IS, IT, HR, LI, LU, MT, MK, MD, MC, NL, NO, AT, PL, PT, RO, SM, SE, RS, SK, ES, CI, HU, CY

### **Notas de uso:**

- Para seguir cumpliendo las normas europeas de uso del espectro nacional, se aplicarán limitaciones de frecuencia y canal en los productos en función del país en el que se pondrá en funcionamiento el equipo.
- Este dispositivo tiene restringido el funcionamiento en modo Ad-hoc mientras funcione a 5 Ghz. El modo Ad-hoc es la comunicación directa de igual a igual entre dos dispositivos cliente sin un punto de acceso.
- Los puntos de acceso admitirán la funcionalidad DFS (Selección de frecuencia dinámica) y TPC (Control de la potencia de transmisión) si es necesario cuando funcionan a 5 Ghz dentro de la UE.
- Por favor compruebe el manual o la ficha de producto para comprobar si el producto utiliza las bandas inalámbricas de 2.4 GHz y/o la de 5 GHz.

### **AVVISO PER L'USO DI LAN RADIO WIRELESS NELLA COMUNITÀ EUROPEA (SOLO PER PRODOTTI WIRELESS)**

- Nella Comunità europea, l'uso di questo dispositivo è limitato esclusivamente agli ambienti interni sui canali compresi nella banda da 5,15 a 5,35 GHz al fine di ridurre potenziali interferenze. Questo dispositivo è un sistema di trasmissione a banda larga a 2,4 GHz (ricetrasmittente), destinato all'uso in tutti gli stati membri dell'Unione europea e nei paesi EFTA.
- Questo dispositivo può essere utilizzato in AL, AD, BE, BG, DK, DE, FI, FR, GR, GW, IS, IT, HR, LI, LU, MT, MK, MD, MC, NL, NO, AT, PL, PT, RO, SM, SE, RS, SK, ES, CI, HU, CY

#### **Note per l'uso**

- Al fine di mantenere la conformità alle normative nazionali europee per l'uso dello spettro di frequenze, saranno applicate limitazioni sulle frequenze e sui canali per il prodotto in conformità alle normative del paese in cui il dispositivo viene utilizzato.
- Questo dispositivo non può essere attivato in modalità Ad-hoc durante il funzionamento a 5 GHz. La modalità Ad-hoc è una comunicazione diretta peer-to-peer fra due dispositivi client senza un punto di accesso.
- I punti di accesso supportano le funzionalità DFS (Dynamic Frequency Selection) e TPC (Transmit Power Control) richieste per operare a 5 GHz nell'Unione europea.
- Ti invitiamo a fare riferimento al manuale del prodotto o alla scheda tecnica per verificare se il tuo prodotto utilizza le frequenze 2,4 GHz e/o 5 GHz.

### **KENNISGEVING VAN DRAADLOOS RADIO LAN-GEbruik IN DE EUROPESE GEMEENSCHAP (ALLEEN VOOR DRAADLOOS PRODUCT)**

- Dit toestel is beperkt tot gebruik binnenshuis wanneer het wordt gebruikt in de Europese Gemeenschap gebruik makend van kanalen in de 5.15-5.35 GHz band om de kans op interferentie te beperken.
- Dit toestel is een 2.4 GHz breedband transmissiesysteem (transceiver) dat bedoeld is voor gebruik in alle EU lidstaten en EFTA landen. Deze uitrusting mag gebruikt worden in AL, AD, BE, BG, DK, DE, FI, FR, GR, GW, IS, IT, HR, LI, LU, MT, MK, MD, MC, NL, NO, AT, PL, PT, RO, SM, SE, RS, SK, ES, CI, HU, CY

#### **Gebruiksaanwijzingen:**

- Om de gebruiksvoorschriften van het Europese Nationale spectrum na te leven, zullen frequentie- en kanaalbeperkingen worden toegepast op de producten volgens het land waar de uitrusting gebruikt zal worden.
- Dit toestel kan niet functioneren in Ad-hoc mode wanneer het gebruikt wordt in 5 GHz. Ad-hoc mode is directe peer-to-peer communicatie tussen twee klantenapparaten zonder een toegangspunt.
- Toegangspunten ondersteunen DFS (Dynamic Frequency Selection) en TPC (Transmit Power Control) functionaliteit zoals vereist bij gebruik in 5 GHz binnen de EU.
- Raadpleeg de handleiding of de datasheet om te controleren of uw product gebruik maakt van 2.4 GHz en/of 5 GHz.

### **SAFETY INSTRUCTIONS**

The following general safety guidelines are provided to help ensure your own personal safety and protect your product from potential damage. Remember to consult the product user instructions for more details.

- Static electricity can be harmful to electronic components. Discharge static electricity from your body (i.e. touching grounded bare metal) before touching the product.
- Do not attempt to service the product and never disassemble the product. For some products with a user replaceable battery, please read and follow the instructions in the user manual.
- Do not spill food or liquid on your product and never push any objects into the openings of your product.
- Do not use this product near water, areas with high humidity, or condensation unless the product is specifically rated for outdoor application.
- Keep the product away from radiators and other heat sources.
- Always unplug the product from mains power before cleaning and use a dry lint free cloth only.

### **SICHERHEITSVORSCHRIFTEN**

Die folgenden allgemeinen Sicherheitsvorschriften dienen als Hilfe zur Gewährleistung Ihrer eigenen Sicherheit und zum Schutz Ihres Produkts. Weitere Details finden Sie in den Benutzeranleitungen zum Produkt.

- Statische Elektrizität kann elektronischen Komponenten schaden. Um Schäden durch statische Aufladung zu vermeiden, leiten Sie elektrostatische Ladungen von Ihrem Körper ab, (z. B. durch Berühren eines geerdeten blanken Metallteils), bevor Sie das Produkt berühren.
- Unterlassen Sie jeden Versuch, das Produkt zu warten, und versuchen Sie nicht, es in seine Bestandteile zu zerlegen. Für einige Produkte mit austauschbaren Akkus lesen Sie bitte das Benutzerhandbuch und befolgen Sie die dort beschriebenen Anleitungen.
- Vermeiden Sie, dass Speisen oder Flüssigkeiten auf Ihr Produkt gelangen, und stecken Sie keine Gegenstände in die Gehäuseschlitze oder -öffnungen Ihres Produkts.
- Verwenden Sie dieses Produkt nicht in unmittelbarer Nähe von Wasser und nicht in Bereichen mit hoher Luftfeuchtigkeit oder Kondensation, es sei denn, es ist speziell zur Nutzung in Außenbereichen vorgesehen und eingestuft.
- Halten Sie das Produkt von Heizkörpern und anderen Quellen fern, die Wärme erzeugen.
- Trennen Sie das Produkt immer von der Stromzufuhr, bevor Sie es reinigen und verwenden Sie dazu ausschließlich ein trockenes fusselfreies Tuch.

### **CONSIGNES DE SÉCURITÉ**

Les consignes générales de sécurité ci-après sont fournies afin d'assurer votre sécurité personnelle et de protéger le produit d'éventuels dommages. Veuillez consulter les consignes d'utilisation du produit pour plus de détails.

- L'électricité statique peut endommager les composants électroniques. Déchargez l'électricité statique de votre corps (en touchant un objet en métal relié à la terre par exemple) avant de toucher le produit.
- N'essayez pas d'intervenir sur le produit et ne le démontez jamais. Pour certains produits contenant une batterie remplaçable par l'utilisateur, veuillez lire et suivre les consignes contenues dans le manuel d'utilisation.
- Ne renversez pas d'aliments ou de liquide sur le produit et n'insérez jamais d'objets dans les orifices.
- N'utilisez pas ce produit à proximité d'un point d'eau, de zones très humides ou de condensation sauf si le produit a été spécifiquement conçu pour une application extérieure.
- Éloignez le produit des radiateurs et autres sources de chaleur.
- Débranchez toujours le produit de l'alimentation avant de le nettoyer et utilisez uniquement un chiffon sec non pelucheux.

### **INSTRUCCIONES DE SEGURIDAD**

Las siguientes directrices de seguridad general se facilitan para ayudarle a garantizar su propia seguridad personal y para proteger el producto frente a posibles daños. No olvide consultar las instrucciones del usuario del producto para obtener más información.

- La electricidad estática puede resultar nociva para los componentes electrónicos. Descargue la electricidad estática de su cuerpo (p. ej., tocando algún metal sin revestimiento conectado a tierra) antes de tocar el producto.
- No intente realizar el mantenimiento del producto ni lo desmonte nunca. Para algunos productos con batería reemplazable por el usuario, lea y siga las instrucciones del manual de usuario.
- No derrame comida o líquidos sobre el producto y nunca deje que caigan objetos en las aberturas del mismo.
- No utilice este producto cerca del agua, en zonas con humedad o condensación elevadas a menos que el producto esté clasificado específicamente para aplicación en exteriores.
- Mantenga el producto alejado de los radiadores y de otras fuentes de calor.
- Desenchufe siempre el producto de la alimentación de red antes de limpiarlo y utilice solo un paño seco sin pelusa.

### **ISTRUZIONI PER LA SICUREZZA**

Le seguenti linee guida sulla sicurezza sono fornite per contribuire a garantire la sicurezza personale degli utenti e a proteggere il prodotto da potenziali danni. Per maggiori dettagli, consultare le istruzioni per l'utente del prodotto.

- L'elettricità statica può essere pericolosa per i componenti elettronici. Scaricare l'elettricità statica dal corpo (ad esempio toccando una parte metallica collegata a terra) prima di toccare il prodotto.
- Non cercare di riparare il prodotto e non smontarlo mai. Per alcuni prodotti dotati di batteria sostituibile dall'utente, leggere e seguire le istruzioni riportate nel manuale dell'utente.
- Non versare cibi o liquidi sul prodotto e non spingere mai alcun oggetto nelle aperture del prodotto.
- Non usare questo prodotto vicino all'acqua, in aree con elevato grado di umidità o soggette a condensa a meno che il prodotto non sia specificatamente approvato per uso in ambienti esterni.
- Tenere il prodotto lontano da caloriferi e altre fonti di calore.
- Scollegare sempre il prodotto dalla presa elettrica prima di pulirlo e usare solo un panno asciutto che non lasci filacce.

### **VEILIGHEIDSINFORMATIE**

De volgende algemene veiligheidsinformatie werd verstrekt om uw eigen persoonlijke veiligheid te waarborgen en uw product te beschermen tegen mogelijke schade. Denk eraan om de gebruikersinstructies van het product te raadplegen voor meer informatie.

- Statische elektriciteit kan schadelijk zijn voor elektronische componenten. Ontlaad de statische elektriciteit van uw lichaam (d.w.z. het aanraken van geaard bloot metaal) voordat u het product aanraakt.
- U mag nooit proberen het product te onderhouden en u mag het product nooit demonteren. Voor sommige producten met door de gebruiker te vervangen batterij, dient u de instructies in de gebruikershandleiding te lezen en te volgen.
- Mors geen voedsel of vloeistof op uw product en u mag nooit voorwerpen in de openingen van uw product duwen.
- Gebruik dit product niet in de buurt van water, gebieden met hoge vochtigheid of condensatie, tenzij het product specifiek geclassificeerd is voor gebruik buitenshuis.
- Houd het product uit de buurt van radiators en andere warmtebronnen.
- U dient het product steeds los te koppelen van de stroom voordat u het reinigt en gebruik uitsluitend een droge pluisvrije doek.



## Disposing of and Recycling Your Product

### ENGLISH

EN



This symbol on the product or packaging means that according to local laws and regulations this product should be not be disposed of in household waste but sent for recycling. Please take it to a collection point designated by your local authorities once it has reached the end of its life, some will accept products for free. By recycling the product and its packaging in this manner you help to conserve the environment and protect human health.

### D-Link and the Environment

At D-Link, we understand and are committed to reducing any impact our operations and products may have on the environment. To minimise this impact D-Link designs and builds its products to be as environmentally friendly as possible, by using recyclable, low toxic materials in both products and packaging.

D-Link recommends that you always switch off or unplug your D-Link products when they are not in use. By doing so you will help to save energy and reduce CO2 emissions.

To learn more about our environmentally responsible products and packaging please visit [www.dlinkgreen.com](http://www.dlinkgreen.com).

### DEUTSCH

DE



Dieses Symbol auf dem Produkt oder der Verpackung weist darauf hin, dass dieses Produkt gemäß bestehender örtlicher Gesetze und Vorschriften nicht über den normalen Hausmüll entsorgt werden sollte, sondern einer Wiederverwertung zuzuführen ist. Bringen Sie es bitte zu einer von Ihrer Kommunalbehörde entsprechend amtlich ausgewiesenen Sammelstelle, sobald das Produkt das Ende seiner Nutzungsdauer erreicht hat. Für die Annahme solcher Produkte erheben einige dieser Stellen keine Gebühren. Durch ein auf diese Weise durchgeführtes Recycling des Produkts und seiner Verpackung helfen Sie, die Umwelt zu schonen und die menschliche Gesundheit zu schützen.

### D-Link und die Umwelt

D-Link ist sich den möglichen Auswirkungen seiner Geschäftstätigkeiten und seiner Produkte auf die Umwelt bewusst und fühlt sich verpflichtet, diese entsprechend zu mindern. Zu diesem Zweck entwickelt und stellt D-Link seine Produkte mit dem Ziel größtmöglicher Umweltfreundlichkeit her und verwendet wiederverwertbare, schadstoffarme Materialien bei Produktherstellung und Verpackung.

D-Link empfiehlt, Ihre Produkte von D-Link, wenn nicht in Gebrauch, immer auszuschalten oder vom Netz zu nehmen. Auf diese Weise helfen Sie, Energie zu sparen und CO2-Emissionen zu reduzieren.

Wenn Sie mehr über unsere umweltgerechten Produkte und Verpackungen wissen möchten, finden Sie entsprechende Informationen im Internet unter [www.dlinkgreen.com](http://www.dlinkgreen.com).

## FRANÇAIS

FR



Ce symbole apposé sur le produit ou son emballage signifie que, conformément aux lois et réglementations locales, ce produit ne doit pas être éliminé avec les déchets domestiques mais recyclé. Veuillez le rapporter à un point de collecte prévu à cet effet par les autorités locales; certains accepteront vos produits gratuitement. En recyclant le produit et son emballage de cette manière, vous aidez à préserver l'environnement et à protéger la santé de l'homme.

### D-Link et l'environnement

Chez D-Link, nous sommes conscients de l'impact de nos opérations et produits sur l'environnement et nous engageons à le réduire. Pour limiter cet impact, D-Link conçoit et fabrique ses produits de manière aussi écologique que possible, en utilisant des matériaux recyclables et faiblement toxiques, tant dans ses produits que ses emballages.

D-Link recommande de toujours éteindre ou débrancher vos produits D-Link lorsque vous ne les utilisez pas. Vous réaliserez ainsi des économies d'énergie et réduirez vos émissions de CO<sub>2</sub>.

Pour en savoir plus sur les produits et emballages respectueux de l'environnement, veuillez consulter le [www.dlinkgreen.com](http://www.dlinkgreen.com).

## ESPAÑOL

ES



Este símbolo en el producto o el embalaje significa que, de acuerdo con la legislación y la normativa local, este producto no se debe desechar en la basura doméstica sino que se debe reciclar. Llévelo a un punto de recogida designado por las autoridades locales una vez que ha llegado al fin de su vida útil; algunos de ellos aceptan recogerlos de forma gratuita. Al reciclar el producto y su embalaje de esta forma, contribuye a preservar el medio ambiente y a proteger la salud de los seres humanos.

### D-Link y el medio ambiente

En D-Link, comprendemos y estamos comprometidos con la reducción del impacto que puedan tener nuestras actividades y nuestros productos en el medio ambiente. Para reducir este impacto, D-Link diseña y fabrica sus productos para que sean lo más ecológicos posible, utilizando materiales reciclables y de baja toxicidad tanto en los productos como en el embalaje.

D-Link recomienda apagar o desenchufar los productos D-Link cuando no se estén utilizando. Al hacerlo, contribuirá a ahorrar energía y a reducir las emisiones de CO<sub>2</sub>.

Para obtener más información acerca de nuestros productos y embalajes ecológicos, visite el sitio [www.dlinkgreen.com](http://www.dlinkgreen.com).

## ITALIANO

IT



La presenza di questo simbolo sul prodotto o sulla confezione del prodotto indica che, in conformità alle leggi e alle normative locali, questo prodotto non deve essere smaltito nei rifiuti domestici, ma avviato al riciclo. Una volta terminato il ciclo di vita utile, portare il prodotto presso un punto di raccolta indicato dalle autorità locali. Alcuni questi punti di raccolta accettano gratuitamente i prodotti da riciclare. Scegliendo di riciclare il prodotto e il relativo imballaggio, si contribuirà a preservare l'ambiente e a salvaguardare la salute umana.

### D-Link e l'ambiente

D-Link cerca da sempre di ridurre l'impatto ambientale dei propri stabilimenti e dei propri prodotti. Allo scopo di ridurre al minimo tale impatto, D-Link progetta e realizza i propri prodotti in modo che rispettino il più possibile l'ambiente, utilizzando materiali riciclabili a basso tasso di tossicità sia per i prodotti che per gli imballaggi.

D-Link raccomanda di spegnere sempre i prodotti D-Link o di scollegarne la spina quando non vengono utilizzati. In questo modo si contribuirà a risparmiare energia e a ridurre le emissioni di anidride carbonica.

Per ulteriori informazioni sui prodotti e sugli imballaggi D-Link a ridotto impatto ambientale, visitate il sito all'indirizzo [www.dlinkgreen.com](http://www.dlinkgreen.com).

## NEDERLANDS

NL



Dit symbool op het product of de verpakking betekent dat dit product volgens de plaatselijke wetgeving niet mag worden weggegooid met het huishoudelijk afval, maar voor recyclage moeten worden ingeleverd. Zodra het product het einde van de levensduur heeft bereikt, dient u het naar een inzamelpunt te brengen dat hiertoe werd aangeduid door uw plaatselijke autoriteiten, sommige autoriteiten accepteren producten zonder dat u hiervoor dient te betalen. Door het product en de verpakking op deze manier te recyclen helpt u het milieu en de gezondheid van de mens te beschermen.

### D-Link en het milieu

Bij D-Link spannen we ons in om de impact van onze handelingen en producten op het milieu te beperken. Om deze impact te beperken, ontwerpt en bouwt D-Link zijn producten zo milieuvriendelijk mogelijk, door het gebruik van recycleerbare producten met lage toxiciteit in product en verpakking.

D-Link raadt aan om steeds uw D-Link producten uit te schakelen of uit de stekker te halen wanneer u ze niet gebruikt. Door dit te doen bespaart u energie en beperkt u de CO<sub>2</sub>-emissies.

Breng een bezoek aan [www.dlinkgreen.com](http://www.dlinkgreen.com) voor meer informatie over onze milieuverantwoorde producten en verpakkingen.

**POLSKI****PL**

Ten symbol umieszczony na produkcie lub opakowaniu oznacza, że zgodnie z miejscowym prawem i lokalnymi przepisami niniejszego produktu nie wolno wyrzucać jak odpady czy śmieci z gospodarstwa domowego, lecz należy go poddać procesowi recyklingu. Po zakończeniu użytkowania produktu, niektóre odpowiednie do tego celu podmioty przyjmą takie produkty nieodpłatnie, dlatego prosimy dostarczyć go do punktu zbiórki wskazanego przez lokalne władze. Poprzez proces recyklingu i dzięki takiemu postępowaniu z produktem oraz jego opakowaniem, pomogą Państwo chronić środowisko naturalne i dbać o ludzkie zdrowie.

**D-Link i środowisko**

D-Link podchodzimy w sposób świadomy do ochrony otoczenia oraz jesteśmy zaangażowani w zmniejszanie wpływu naszych działań i produktów na środowisko naturalne. W celu zminimalizowania takiego wpływu firma D-Link konstruuje i wytwarza swoje produkty w taki sposób, aby były one jak najbardziej przyjazne środowisku, stosując do tych celów materiały nadające się do powtórnego wykorzystania, charakteryzujące się małą toksycznością zarówno w przypadku samych produktów jak i opakowań.

Firma D-Link zaleca, aby Państwo zawsze prawidłowo wyłączali z użytku swoje produkty D-Link, gdy nie są one wykorzystywane. Postępując w ten sposób pozwalają Państwo oszczędzać energię i zmniejszać emisje CO<sub>2</sub>.

Aby dowiedzieć się więcej na temat produktów i opakowań mających wpływ na środowisko prosimy zapoznać się ze stroną Internetową [www.dlinkgreen.com](http://www.dlinkgreen.com).

**ČESKY****CZ**

Tento symbol na výrobku nebo jeho obalu znamená, že podle místně platných předpisů se výrobek nesmí vyhazovat do komunálního odpadu, ale odeslat k recyklaci. Až výrobek doslouží, odneste jej prosím na sběrné místo určené místními úřady k tomuto účelu. Někteřá sběrná místa přijímají výrobky zdarma. Recyklací výrobku i obalu pomáháte chránit životní prostředí i lidské zdraví.

**D-Link a životní prostředí**

Ve společnosti D-Link jsme si vědomi vlivu našich provozů a výrobků na životní prostředí a snažíme se o minimalizaci těchto vlivů. Proto své výrobky navrhujeme a vyrábíme tak, aby byly co nejekologičtější, a ve výrobcích i obalech používáme recyklovatelné a nízkotoxické materiály.

Společnost D-Link doporučuje, abyste své výrobky značky D-Link vypnuli nebo vytáhli ze zásuvky vždy, když je nepoužíváte. Pomůžete tak šetřit energii a snížit emise CO<sub>2</sub>.

Více informací o našich ekologických výrobcích a obalech najdete na adrese [www.dlinkgreen.com](http://www.dlinkgreen.com).

## MAGYAR

HU



Ez a szimbólum a terméken vagy a csomagoláson azt jelenti, hogy a helyi törvényeknek és szabályoknak megfelelően ez a termék nem semmisíthető meg a háztartási hulladékkal együtt, hanem újrahasznosításra kell küldeni. Kérjük, hogy a termék élettartamának elteltét követően vigye azt a helyi hatóság által kijelölt gyűjtőhelyre. A termékek egyes helyeken ingyen elhelyezhetők. A termék és a csomagolás újrahasznosításával segíti védeni a környezetet és az emberek egészségét.

### A D-Link és a környezet

A D-Linknél megértjük és elköteleztük magunkat a műveleteink és termékeink környezetre gyakorolt hatásainak csökkentésére. Az ezen hatás csökkentése érdekében a D-Link a lehető leginkább környezetbarát termékeket tervez és gyárt azáltal, hogy újrahasznosítható, alacsony károsanyag-tartalmú termékeket gyárt és csomagolásokat alkalmaz.

A D-Link azt javasolja, hogy mindig kapcsolja ki vagy húzza ki a D-Link termékeket a tápforrásból, ha nem használja azokat. Ezzel segít az energia megtakarításában és a széndioxid kibocsátásának csökkentésében.

Környezetbarát termékeinkről és csomagolásainkról további információkat a [www.dlinkgreen.com](http://www.dlinkgreen.com) weboldalon tudhat meg.

## NORSK

NO



Dette symbolet på produktet eller forpakningen betyr at dette produktet ifølge lokale lover og forskrifter ikke skal kastes sammen med husholdningsavfall, men leveres inn til gjenvinning. Vennligst ta det til et innsamlingssted anvist av lokale myndigheter når det er kommet til slutten av levetiden. Noen steder aksepteres produkter uten avgift. Ved på denne måten å gjenvinne produktet og forpakningen hjelper du å verne miljøet og beskytte folks helse.

### D-Link og miljøet

Hos D-Link forstår vi oss på og er forpliktet til å minske innvirkningen som vår drift og våre produkter kan ha på miljøet. For å minimalisere denne innvirkningen designer og lager D-Link produkter som er så miljøvennlig som mulig, ved å bruke resirkulerbare, lav-toksiske materialer både i produktene og forpakningen.

D-Link anbefaler at du alltid slår av eller frakobler D-Link-produkter når de ikke er i bruk. Ved å gjøre dette hjelper du å spare energi og å redusere CO<sub>2</sub>-utslipp.

For mer informasjon angående våre miljøansvarlige produkter og forpakninger kan du gå til [www.dlinkgreen.com](http://www.dlinkgreen.com).

## DANSK

DK



Dette symbol på produktet eller emballagen betyder, at dette produkt i henhold til lokale love og regler ikke må bortskaffes som husholdningsaffald, mens skal sendes til genbrug. Indlever produktet til et indsamlingssted som angivet af de lokale myndigheder, når det er nået til slutningen af dets levetid. I nogle tilfælde vil produktet blive modtaget gratis. Ved at indlevere produktet og dets emballage til genbrug på denne måde bidrager du til at beskytte miljøet og den menneskelige sundhed.

### D-Link og miljøet

Hos D-Link forstår vi og bestræber os på at reducere enhver indvirkning, som vores aktiviteter og produkter kan have på miljøet. For at minimere denne indvirkning designer og producerer D-Link sine produkter, så de er så miljøvenlige som muligt, ved at bruge genanvendelige materialer med lavt giftighedsniveau i både produkter og emballage.

D-Link anbefaler, at du altid slukker eller frakobler dine D-Link-produkter, når de ikke er i brug. Ved at gøre det bidrager du til at spare energi og reducere CO<sub>2</sub>-udledningerne.

Du kan finde flere oplysninger om vores miljømæssigt ansvarlige produkter og emballage på [www.dlinkgreen.com](http://www.dlinkgreen.com).

## SUOMI

FI



Tämä symboli tuotteen pakkauksessa tarkoittaa, että paikallisten lakien ja säännösten mukaisesti tätä tuotetta ei pidä hävittää yleisen kotitalousjätteen seassa vaan se tulee toimittaa kierrätettäväksi. Kun tuote on elinkaarensa päässä, toimita se lähimpään viranomaisten hyväksymään kierrätyspisteeseen. Kierrättämällä käytetyn tuotteen ja sen pakkauksen autat tukemaan sekä ympäristön että ihmisten terveyttä ja hyvinvointia.

### D-Link ja ympäristö

D-Link ymmärtää ympäristönsuojelun tärkeyden ja on sitoutunut vähentämään tuotteistaan ja niiden valmistuksesta ympäristölle mahdollisesti aiheutuvia haittavaikutuksia. Nämä negatiiviset vaikutukset minimoidakseen D-Link suunnittelee ja valmistaa tuotteensa mahdollisimman ympäristöystävällisiksi käyttämällä kierrätettäviä, alhaisia pitoisuuksia haitallisia aineita sisältäviä materiaaleja sekä tuotteissaan että niiden pakkauksissa.

Suosittellemme, että irrotat D-Link-tuotteesi virtalähteestä tai sammutat ne aina, kun ne eivät ole käytössä. Toimimalla näin autat säästämään energiaa ja vähentämään hiilidioksiidipäästöjä.

Lue lisää ympäristöystävällisistä D-Link-tuotteista ja pakkauksistamme osoitteesta [www.dlinkgreen.com](http://www.dlinkgreen.com).

**SVENSKA****SE**

Den här symbolen på produkten eller förpackningen betyder att produkten enligt lokala lagar och föreskrifter inte skall kastas i hushållssoporna utan i stället återvinnas. Ta den vid slutet av dess livslängd till en av din lokala myndighet utsedd uppsamlingsplats, vissa accepterar produkter utan kostnad. Genom att på detta sätt återvinna produkten och förpackningen hjälper du till att bevara miljön och skydda människors hälsa.

**D-Link och miljön**

På D-Link förstår vi och är fast beslutna att minska den påverkan våra verksamheter och produkter kan ha på miljön. För att minska denna påverkan utformar och bygger D-Link sina produkter för att de ska vara så miljövänliga som möjligt, genom att använda återvinningsbara material med låg gifthalt i både produkter och förpackningar.

D-Link rekommenderar att du alltid stänger av eller kopplar ur dina D-Link produkter när du inte använder dem. Genom att göra detta hjälper du till att spara energi och minska utsläpp av koldioxid.

För mer information om våra miljöansvariga produkter och förpackningar [www.dlinkgreen.com](http://www.dlinkgreen.com).

**PORTUGUÊS****PT**

Este símbolo no produto ou embalagem significa que, de acordo com as leis e regulamentações locais, este produto não deverá ser eliminado juntamente com o lixo doméstico mas enviado para a reciclagem. Transporte-o para um ponto de recolha designado pelas suas autoridades locais quando este tiver atingido o fim da sua vida útil, alguns destes pontos aceitam produtos gratuitamente. Ao reciclar o produto e respectiva embalagem desta forma, ajuda a preservar o ambiente e protege a saúde humana.

**A D-Link e o ambiente**

Na D-Link compreendemos e comprometemo-nos com a redução do impacto que as nossas operações e produtos possam ter no ambiente. Para minimizar este impacto a D-Link concebe e constrói os seus produtos para que estes sejam o mais inofensivos para o ambiente possível, utilizando materiais recicláveis e não tóxicos tanto nos produtos como nas embalagens.

A D-Link recomenda que desligue os seus produtos D-Link quando estes não se encontrarem em utilização. Com esta acção ajudará a poupar energia e reduzir as emissões de CO<sub>2</sub>.

Para saber mais sobre os nossos produtos e embalagens responsáveis a nível ambiental visite [www.dlinkgreen.com](http://www.dlinkgreen.com).