

FCC Test Report

Product Name : HD 180 Degree Wi-Fi Camera

Trade Name : D-Link

Model No. : DCS-8100LH

FCC ID. : KA2CS8100LHA1

Applicant : D-Link Corporation

Address : No.289, Sinhu 3rd Rd., Neihu District, Taipei
City 114, Taiwan, R.O.C.

Tested : Feb. 07, 2017 ~ May 19, 2017

Issued Date : May 22, 2017

Report No. : 1740183R-RFUSP01V00-A

Report Version : V1.0



The test results relate only to the samples tested.

The test report shall not be reproduced except in full without the written approval of DEKRA Testing and Certification Co., Ltd.

Test Report Certification

Issued Date : May 22, 2017

Report No. : 1740183R-RFUSP01V00-A



Product Name : HD 180 Degree Wi-Fi Camera
Applicant : D-Link Corporation
Address : No.289, Sinhu 3rd Rd., Neihu District, Taipei City 114, Taiwan,
R.O.C.
Model No. : DCS-8100LH
FCC ID. : KA2CS8100LHA1
EUT Voltage : AC 100-240V, 50-60Hz
Testing Voltage : AC 120V/60Hz
Trade Name : D-Link
Applicable Standard : FCC CFR Title 47 Part 15 Subpart C Section 15.247: 2015
Test Lab : Hsin Chu Laboratory
Test Result : Complied

The test results relate only to the samples tested.

The test report shall not be reproduced except in full without the written approval of DEKRA Testing and Certification Co., Ltd.

Documented By : 

(Carol Tsai / Engineering Adm. Assistant)

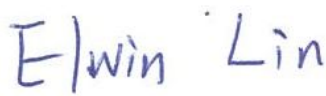
Tested By : 

(Elwin Lin / Assistant Engineer)

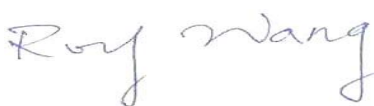
Approved By : 

(Roy Wang / Director)

Revision History

Report No.	Version	Description	Issued Date
1740183R-RFUSP01V00-A	V1.0	Initial issue of report	May 22, 2017

Laboratory Information

We, **DEKRA Testing and Certification Co., Ltd.**, are an independent RF consultancy that was established the whole facility in our laboratories. The test facility has been accredited/accepted (audited or listed) by the following related bodies in compliance with ISO 17025 specified testing scopes:

Taiwan R.O.C.	:	TAF, Accreditation Number: 3024
USA	:	FCC, Registration Number: 834100
Canada	:	IC, Submission No: 181665 IC Registration Number: 22397-1 / 22397-2 / 22397-3

The related certificate for our laboratories about the test site and management system can be downloaded from DEKRA Testing and Certification Co., Ltd. Web Site:

<http://www.dekra.com.tw/english/about/certificates.aspx?bval=5>

The address and introduction of DEKRA Testing and Certification Co., Ltd. laboratories can be founded in our Web site : http://www.dekra.com.tw/index_en.aspx

If you have any comments, Please don't hesitate to contact us. Our contact information is as below:

Hsin Chu Laboratory:

No.75-2, 3rd Lin, WangYe Keng, Yonghxing Tsuen, Qionglin Shiang, Hsinchu County 307, Taiwan (R.O.C.)

TEL:+886-3-592-8858 / FAX:+886-3-592-8859

No.372, Sec. 4, Zhongxing Rd., Zhudong Township, Hsinchu County 310, Taiwan

No.372-2, Sec. 4, Zhongxing Rd., Zhudong Township, Hsinchu County 310, Taiwan

TEL:+886-3-582-8001 / FAX:+886-3-5828-958 E-Mail : info.tw@dekra.com

Lin Kou Laboratory:

No. 5-22, Ruishukeng, Linkou Dist., New Taipei City 24451, Taiwan (R.O.C.)

TEL : +886-2-8601-3788 / FAX : +886-2-8601-3789

E-Mail : info.tw@dekra.com

TABLE OF CONTENTS

Description	Page
1. General Information.....	7
1.1. EUT Description	7
1.2. Test Mode	9
1.3. Tested System Details	10
1.4. Configuration of tested System	10
1.5. EUT Exercise Software	10
1.6. Test Facility.....	11
2. Conducted Emission	12
2.1. Test Equipment.....	12
2.2. Test Setup	12
2.3. Limits	13
2.4. Test Procedure	13
2.5. Test Specification.....	13
2.6. Uncertainty	13
2.7. Test Result.....	14
3. Peak Power Output	16
3.1. Test Equipment.....	16
3.2. Test Setup	16
3.3. Test procedures	16
3.4. Limits	16
3.5. Test Specification.....	16
3.6. Test Result.....	17
4. Radiated Emission	18
4.1. Test Equipment.....	18
4.2. Test Setup	19
4.3. Limits	20
4.4. Test Procedure	20
4.5. Test Specification.....	20
4.6. Test Result.....	21
5. RF antenna conducted test	41
5.1. Test Equipment.....	41
5.2. Test Setup	41
5.3. Limits	42
5.4. Test Procedure	42
5.5. Test Specification.....	42
5.6. Test Result.....	43
6. Band Edge.....	48
6.1. Test Equipment.....	48
6.2. Test Setup	48
6.3. Limits	49
6.4. Test Procedure	49

6.5.	Test Specification.....	49
6.6.	Test Result.....	50
7.	DTS Bandwidth	62
7.1.	Test Equipment.....	62
7.2.	Test Setup	62
7.3.	Limits	62
7.4.	Test Procedures	62
7.5.	Test Specification.....	62
7.6.	Test Result.....	63
8.	Power Density	66
8.1.	Test Equipment.....	66
8.2.	Test Setup	66
8.3.	Limits	66
8.4.	Test Procedures	66
8.5.	Test Specification.....	66
8.6.	Uncertainty	66
8.7.	Test Result.....	67
Attachment 1	70
	Test Setup Photograph.....	70
Attachment 2	75
	EUT External Photograph.....	75
Attachment 3	78
	EUT Internal Photograph.....	78

1. General Information

1.1. EUT Description

Product Name	HD 180 Degree Wi-Fi Camera
Trade Name	D-Link
Model No.	DCS-8100LH
Frequency Range/ Channel Number	2402~2480MHz / 40 Channels
Type of Modulation	Bluetooth 4.0(GFSK)

Antenna Information	
Antenna MFR./ Model	Advanced Ceramic X Corporation, AT3216-A2R4PAA
Antenna Type	Chip Antenna
Antenna Gain	1.5dBi

Accessories Information	
Power Adapter	D-Link, WB-10E05R I/P: 100-240V~, 50-60Hz, 0.4A Max. O/P: 5V \equiv 2A Cable Out: Non-Shielded, 1.5m

Working Frequency of Each Channel							
Channel	Frequency	Channel	Frequency	Channel	Frequency	Channel	Frequency
Channel 00	2402 MHz	Channel 10	2422 MHz	Channel 20	2442 MHz	Channel 30	2462 MHz
Channel 01	2404 MHz	Channel 11	2424 MHz	Channel 21	2444 MHz	Channel 31	2464 MHz
Channel 02	2406 MHz	Channel 12	2426 MHz	Channel 22	2446 MHz	Channel 32	2466 MHz
Channel 03	2408 MHz	Channel 13	2428 MHz	Channel 23	2448 MHz	Channel 33	2468 MHz
Channel 04	2410 MHz	Channel 14	2430 MHz	Channel 24	2450 MHz	Channel 34	2470 MHz
Channel 05	2412 MHz	Channel 15	2432 MHz	Channel 25	2452 MHz	Channel 35	2472 MHz
Channel 06	2414 MHz	Channel 16	2434 MHz	Channel 26	2454 MHz	Channel 36	2474 MHz
Channel 07	2416MHz	Channel 17	2436 MHz	Channel 27	2456 MHz	Channel 37	2476 MHz
Channel 08	2418 MHz	Channel 18	2438 MHz	Channel 28	2458 MHz	Channel 38	2478 MHz
Channel 09	2420 MHz	Channel 19	2440 MHz	Channel 29	2460 MHz	Channel 39	2480 MHz

Note:

1. This device is a HD 180 Degree Wi-Fi Camera including 2.4GHz b/g/n (1x1) and BT4.0 transmitting and receiving function.
2. Regards to the frequency band operation; the lowest , middle and highest frequency of channel were selected to perform the test, and then shown on this report.
3. The function of the 2.4GHz transmitting is measured and makes a test report of the number: 1720079R-RFUSP26V00.
4. This device is a composite device in accordance with Part 15 regulations. The receiving function was tested and its number is 1720079R-RFUSP01V00.
5. The Wall mount Mode,only show the worst case on the report .

1.2. Test Mode

DEKRA has verified the construction and function in typical operation. All the test modes were carried out with the EUT in transmitting operation, which was shown in this test report and defined as follows:

Test Mode	Mode 1: Transmit (Stand) Mode 2: Transmit (Wall mount)
-----------	---

Test Items	Modulation	Channel	Antenna	Result
Conducted Emission	GFSK	19	0	Complies
Peak Power Output	GFSK	00/19/39	0	Complies
Radiated Emission	GFSK	00/19/39	0	Complies
RF antenna conducted test	GFSK	00/19/39	0	Complies
Radiated Emission Band Edge	GFSK	00/39	0	Complies
DTS Bandwidth	GFSK	00/19/39	0	Complies
Power Density	GFSK	00/19/39	0	Complies

1.3. Tested System Details

The types for all equipments, plus descriptions of all cables used in the tested system (including inserted cards) are:

Product	Manufacturer	Model No.	Serial No.	FCC ID	Power Cord
1 Notebook PC	ACER	MS2296	LUSCV021391 150332C2000	DoC	Non-Shielded, 2.5m one ferrite core bonded

1.4. Configuration of tested System

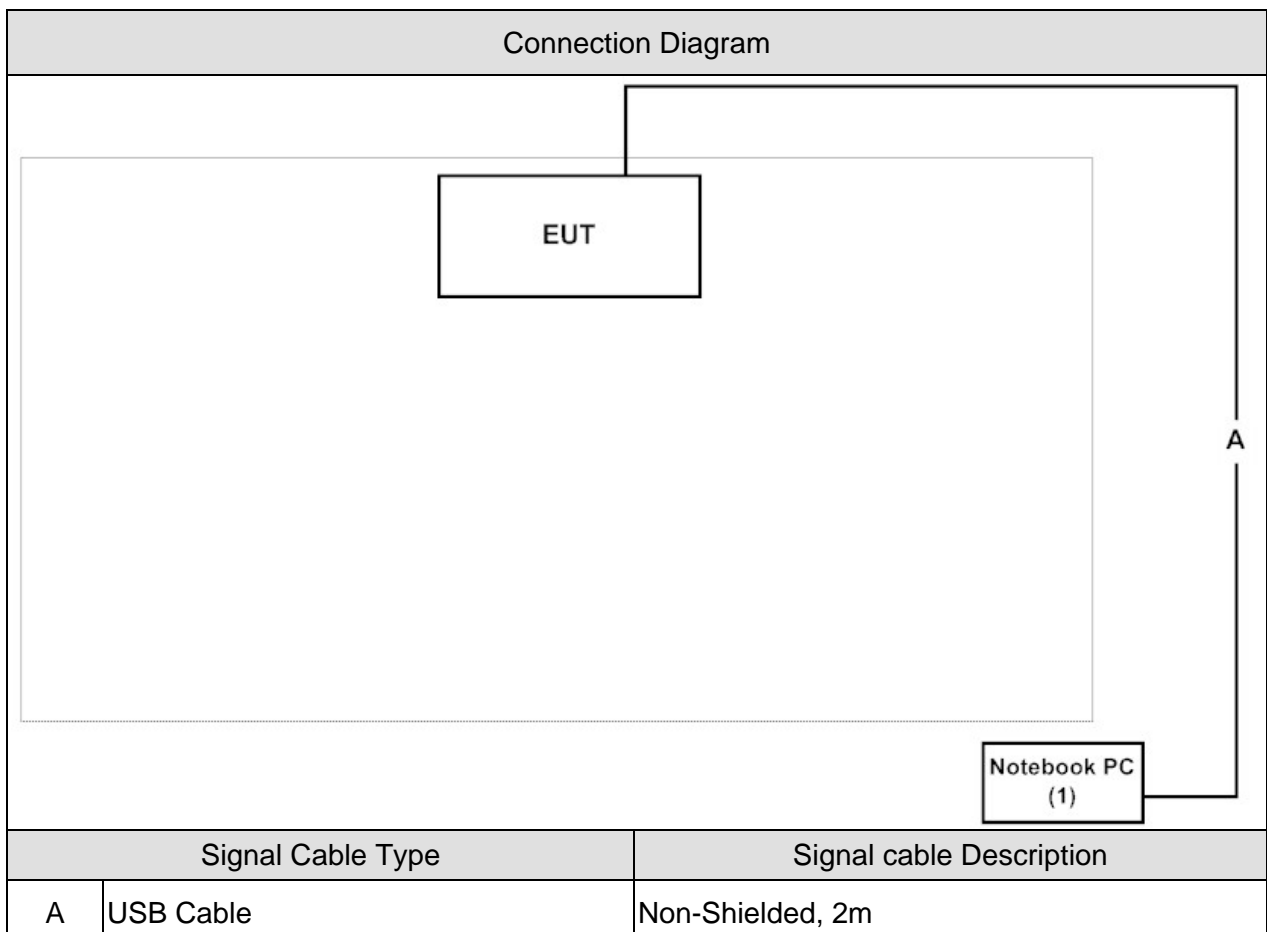

1.5. EUT Exercise Software

1	Setup the EUT as shown in Section 1.4.
2	Execute the test command on the Tera Term
3	Configure the test mode, the test channel, and the data rate.
4	Press “Start TX” to start the continuous transmitting.
5	Verify that the EUT works properly.

1.6. Test Facility

Ambient conditions in the laboratory:

Items	Test Item	Required (IEC 68-1)	Actual
Temperature (°C)	FCC PART 15 C 15.207 Conducted Emission	15 - 35	20
Humidity (%RH)		25 - 75	50
Barometric pressure (mbar)		860 - 1060	950-1000
Temperature (°C)	FCC PART 15 C 15.247 Peak Power Output	15 - 35	24
Humidity (%RH)		25 - 75	45
Barometric pressure (mbar)		860 - 1060	950-1000
Temperature (°C)	FCC PART 15 C 15.247 Radiated Emission	15 - 35	25
Humidity (%RH)		25 - 75	54
Barometric pressure (mbar)		860 - 1060	950-1000
Temperature (°C)	FCC PART 15 C 15.247 Band Edge	15 - 35	25
Humidity (%RH)		25 - 75	50
Barometric pressure (mbar)		860 - 1060	950-1000
Temperature (°C)	FCC PART 15 C 15.247 DTS Bandwidth	15 - 35	24
Humidity (%RH)		25 - 75	45
Barometric pressure (mbar)		860 - 1060	950-1000
Temperature (°C)	FCC PART 15 C 15.247 RF antenna conducted test	15 - 35	24
Humidity (%RH)		25 - 75	45
Barometric pressure (mbar)		860 - 1060	950-1000
Temperature (°C)	FCC PART 15 C 15.247 Power Density	15 - 35	24
Humidity (%RH)		25 - 75	45
Barometric pressure (mbar)		860 - 1060	950-1000

2. Conducted Emission

2.1. Test Equipment

The following test equipments are used during the test:

Conducted Emission / SR2-H

Instrument	Manufacturer	Model No.	Serial No	Next Cal. Date
Artificial Mains Network	R&S	ENV4200	848411/010	2018/02/05
LISN	R&S	ENV216	100092	2017/08/16
Test Receiver	R&S	ESCS 30	836858/022	2018/01/14

Note: All equipments that need to calibrate are with calibration period of 1 year.

2.2. Test Setup

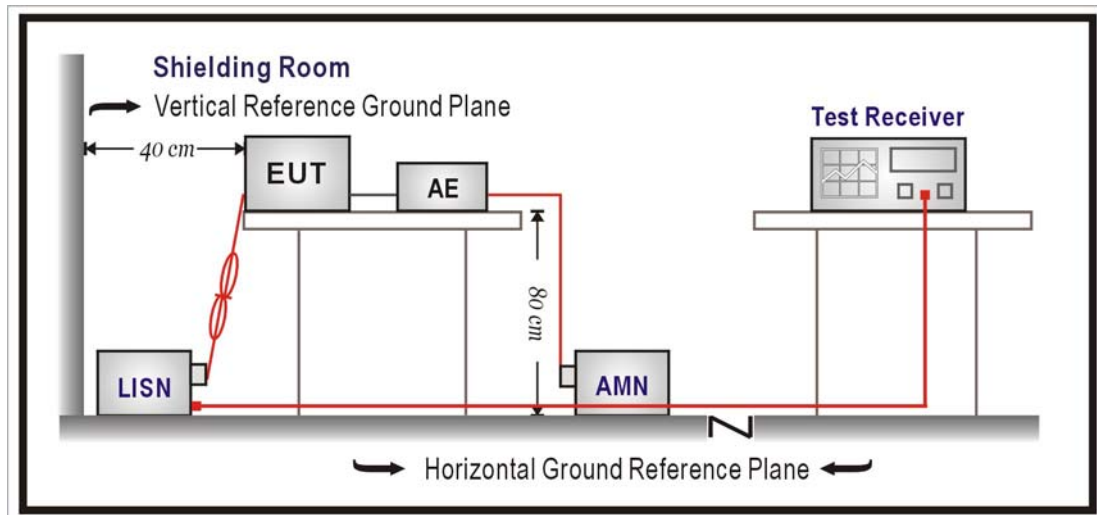

2.3. Limits

FCC Part 15 Subpart C Paragraph 15.207 Limits (dBUV)		
Frequency MHz	QP	AV
0.15 - 0.50	66-56	56-46
0.50 - 5.0	56	46
5.0 - 30	60	50

Remarks: In the above table, the tighter limit applies at the band edges.

2.4. Test Procedure

The EUT was setup according to ANSI C63.10:2013 and tested according to DTS test procedure of KDB558074 for compliance to FCC 47CFR 15.247 requirements.

The EUT was placed on a platform of nominal size, 1 m by 1.5 m, raised 80 cm above the conducting ground plane. The vertical conducting plane was located 40 cm to the rear of the EUT. All other surfaces of EUT were at least 80 cm from any other grounded conducting surface. The EUT and simulators are connected to the main power through a line impedance stabilization network (LISN). The LISN provides a 50 ohm /50uH coupling impedance for the measuring equipment. The peripheral devices are also connected to the main power through a LISN. (Please refer to the block diagram of the test setup and photographs.)

Each current-carrying conductor of the EUT power cord, except the ground (safety) conductor, was individually connected through a LISN to the input power source.

The excess length of the power cord between the EUT and the LISN receptacle were folded back and forth at the center of the lead to form a bundle not exceeding 40 cm in length.

Conducted emissions were investigated over the frequency range from 0.15MHz to 30MHz using a receiver bandwidth of 9 kHz.

2.5. Test Specification

According to FCC Part 15 Subpart C Paragraph 15.207: 2015

2.6. Uncertainty

The measurement uncertainty is defined as ± 2.26 dB.

2.7. Test Result

Site : SR2-H	Time : 2017/03/10
Limit : CISPR_B_00M_QP	Margin : 10
Probe : SR2-H_LISN(16A)-6_0712 - Line1	Power : AC 120V/60Hz
EUT : HD 180 Degree Wi-Fi Camera	Note : Mode 1: Transmit (Stand) 2440MHz

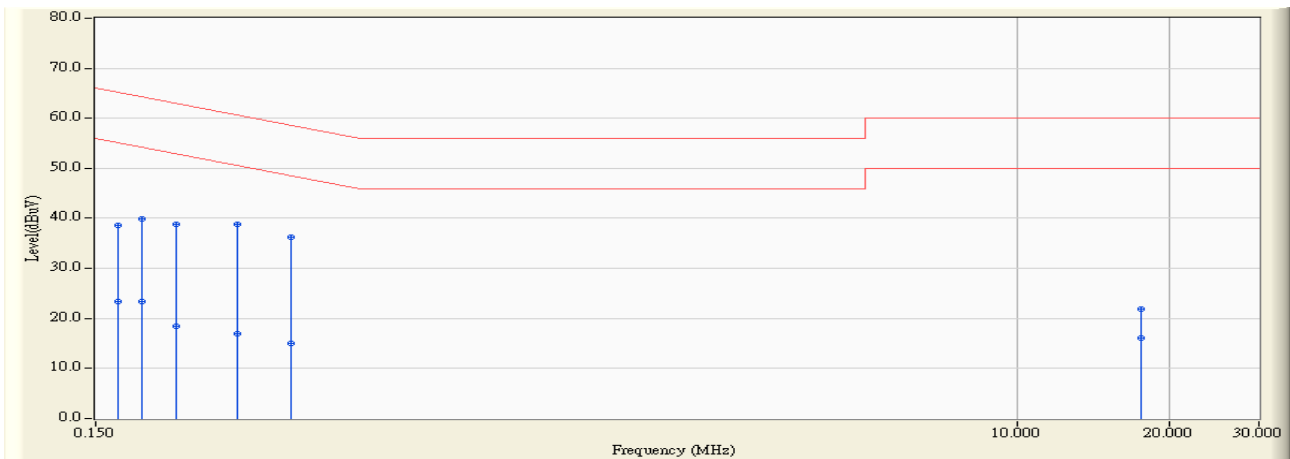

	Frequency (MHz)	Correct Factor (dB)	Reading Level (dBuV)	Measure Level (dBuV)	Margin (dB)	Limit (dBuV)	Detector Type
1	0.166	9.753	28.800	38.553	-26.624	65.177	QUASPEAK
2	0.166	9.753	13.540	23.293	-31.884	55.177	AVERAGE
3	0.185	9.751	30.140	39.891	-24.360	64.251	QUASPEAK
4	0.185	9.751	13.530	23.281	-30.970	54.251	AVERAGE
5	0.216	9.748	29.120	38.868	-24.087	62.956	QUASPEAK
6	0.216	9.748	8.780	18.528	-34.427	52.956	AVERAGE
7	* 0.287	9.741	29.020	38.761	-21.858	60.619	QUASPEAK
8	0.287	9.741	7.260	17.001	-33.618	50.619	AVERAGE
9	0.365	9.734	26.490	36.224	-22.394	58.617	QUASPEAK
10	0.365	9.734	5.210	14.944	-33.674	48.617	AVERAGE
11	17.529	10.281	11.520	21.801	-38.199	60.000	QUASPEAK
12	17.529	10.281	5.770	16.051	-33.949	50.000	AVERAGE

Note:

1. All Reading Levels are Quasi-Peak and average value.
2. " * ", means this data is the worst emission level.
3. Measurement Level = Reading Level + Correct Factor.

Site : SR2-H	Time : 2017/03/10
Limit : CISPR_B_00M_QP	Margin : 10
Probe : SR2-H_LISN(16A)-6_0712 - Line2	Power : AC 120V/60Hz
EUT : HD 180 Degree Wi-Fi Camera	Note : Mode 1: Transmit (Stand) 2440MHz

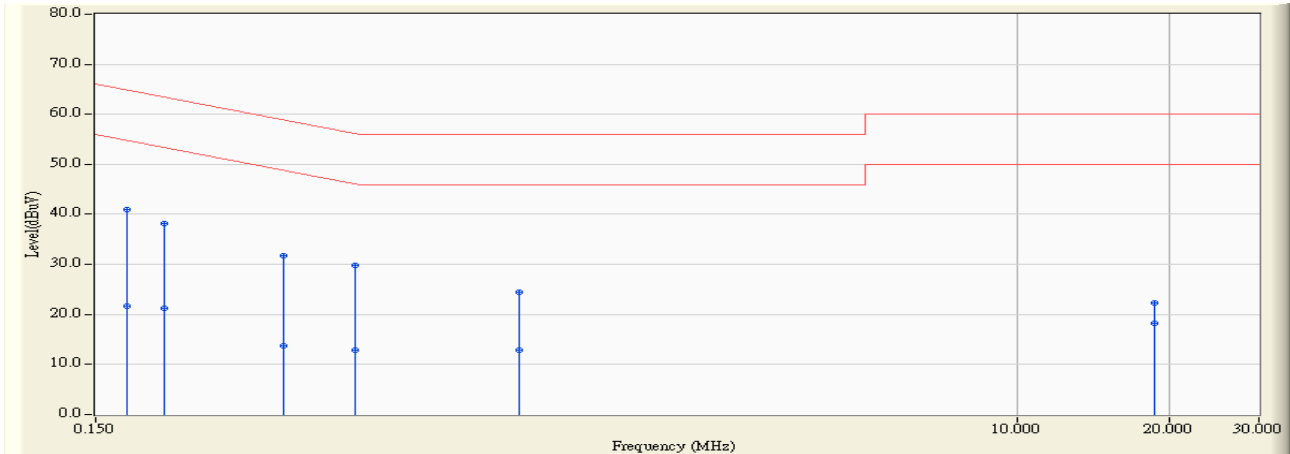

		Frequency (MHz)	Correct Factor (dB)	Reading Level (dBuV)	Measure Level (dBuV)	Margin (dB)	Limit (dBuV)	Detector Type
1	*	0.173	9.753	31.290	41.043	-23.751	64.794	QUASPEAK
2		0.173	9.753	11.890	21.643	-33.151	54.794	AVERAGE
3		0.205	9.751	28.530	38.281	-25.138	63.418	QUASPEAK
4		0.205	9.751	11.540	21.291	-32.128	53.418	AVERAGE
5		0.353	9.750	21.890	31.640	-27.249	58.889	QUASPEAK
6		0.353	9.750	3.980	13.730	-35.159	48.889	AVERAGE
7		0.490	9.745	20.080	29.826	-26.345	56.170	QUASPEAK
8		0.490	9.745	3.050	12.796	-33.375	46.170	AVERAGE
9		1.033	9.821	14.730	24.551	-31.449	56.000	QUASPEAK
10		1.033	9.821	2.960	12.781	-33.219	46.000	AVERAGE
11		18.638	10.448	11.870	22.318	-37.682	60.000	QUASPEAK
12		18.638	10.448	7.790	18.238	-31.762	50.000	AVERAGE

Note:

1. All Reading Levels are Quasi-Peak and average value.
2. " * ", means this data is the worst emission level.
3. Measurement Level = Reading Level + Correct Factor.

3. Peak Power Output

3.1. Test Equipment

The following test equipments are used during the test:

Peak Power Output / SR10-H

Instrument	Manufacturer	Model No.	Serial No	Next Cal. Date
High Speed Peak Power Meter Dual Input	Anritsu	ML2496A	1602004	2018/01/19
Pulse Power Sensor	Anritsu	MA2411B	1531043	2018/01/19
Pulse Power Sensor	Anritsu	MA2411B	1531044	2018/01/19

Note: All equipment upon which need to calibrated are with calibration period of 1 year.

3.2. Test Setup

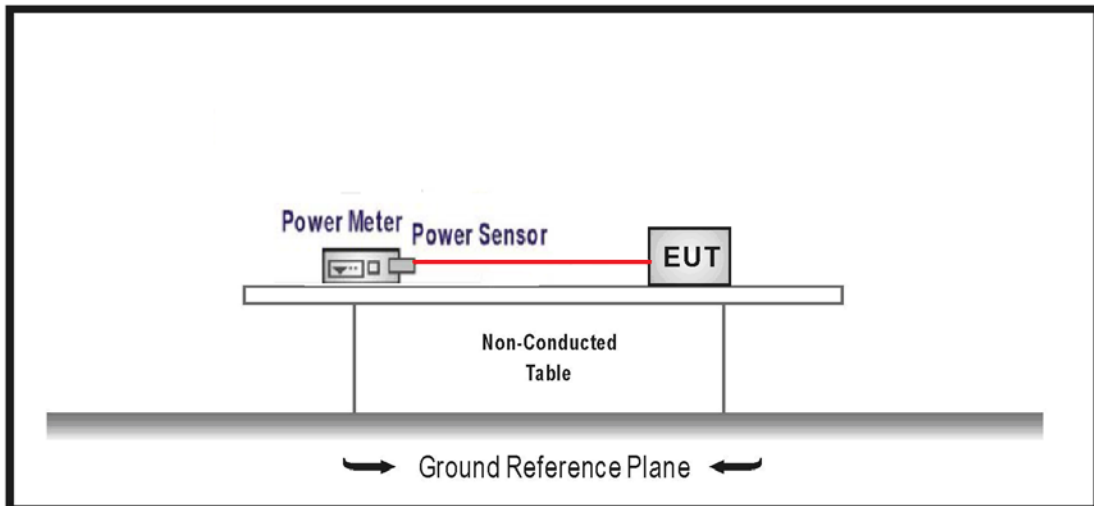

3.3. Test procedures

The EUT was setup according to ANSI C63.10:2013; tested according to DTS test procedure of KDB558074 V03R02 for compliance to FCC 47CFR 15.247 requirements.

3.4. Limits

The maximum peak power shall be less 1 Watt.

3.5. Test Specification

According to FCC Part 15 Subpart C Paragraph 15.247

3.6. Test Result

Product	HD 180 Degree Wi-Fi Camera		
Test Item	Peak Power Output		
Test Mode	Mode 1: Transmit (Stand)		
Date of Test	2017/03/01	Test Site	SR10-H

GFSK

Channel No.	Frequency (MHz)	Measure Level (dBm)	Limit (dBm)	Result
00	2402	2.61	≤ 30	Pass
19	2440	4.69	≤ 30	Pass
39	2480	6.18	≤ 30	Pass

4. Radiated Emission

4.1. Test Equipment

The following test equipments are used during the test:

Radiated Emission / CB4-H

Instrument	Manufacturer	Model No.	Serial No	Next Cal. Date
Bilog Antenna	Schaffner	CBL6112B	2891	2017/08/14
Horn Antenna	Schwarzbeck	BBHA 9120	D312	2017/10/25
Pre-Amplifier	EMCI	EMC0031835	980233	2018/02/02
Pre-Amplifier	Schwarzbeck	DBL-1840N506	013	2017/09/29
Pre-Amplifier	Miteq	JS41-00104000 0-58-5P	1573954	2017/10/04
Horn Antenna	Schwarzbeck	BBHA 9170	203	2017/08/28
Signal & Spectrum Analyzer	R&S	FSV40	101049	2018/01/22
Spectrum Analyzer	Agilent	E4440A	MY46187335	2017/12/21

Note: All equipments that need to calibrate are with calibration period of 1 year.

4.2. Test Setup

Under 1GHz Test Setup:

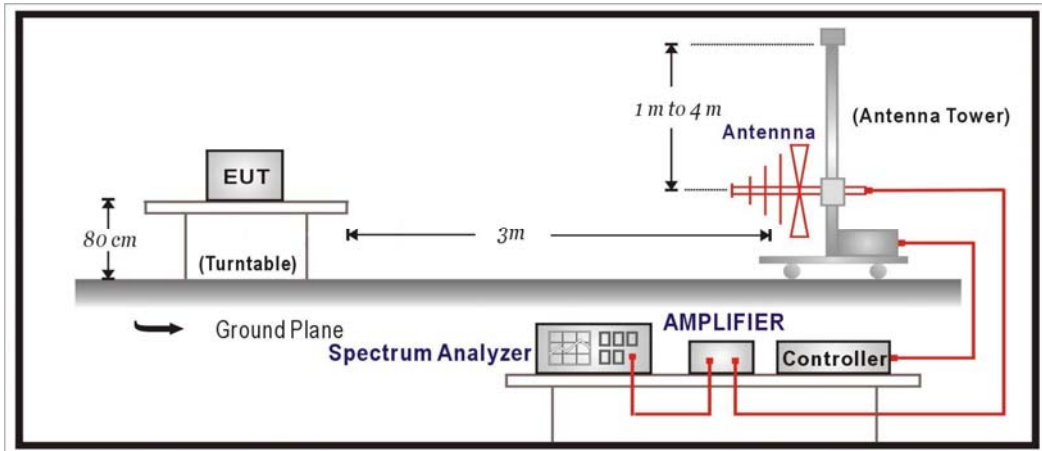

Above 1GHz Test Setup:

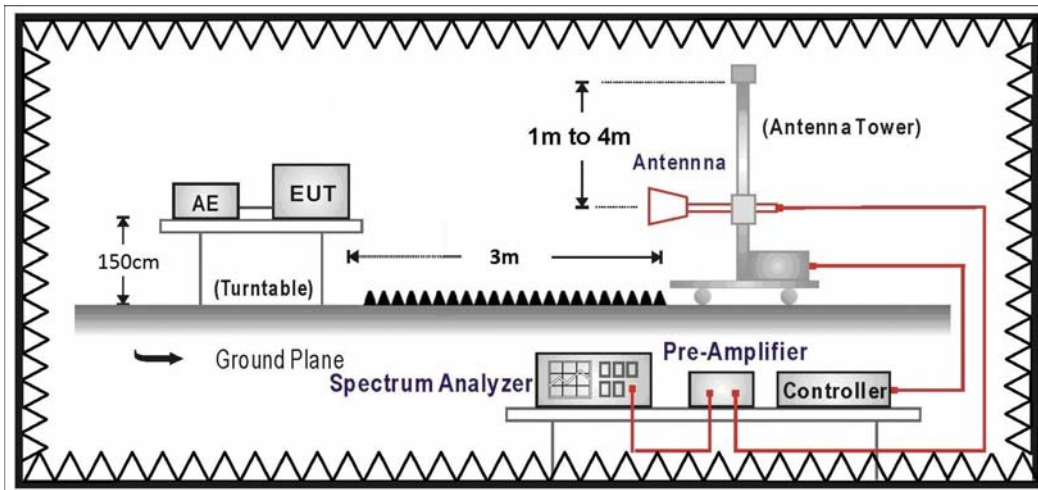

4.3. Limits

Emissions radiated outside of the specified frequency bands, except for harmonics, shall be attenuated by at least 20dB below the level of the fundamental or to the general radiated emission limits in paragraph 15.209, whichever is the lesser attenuation.

FCC Part 15 Subpart C Paragraph 15.209 Limits		
Frequency MHz	uV/m	dBuV/m
30-88	100	40
88-216	150	43.5
216-960	200	46
Above 960	500	54

Remarks : 1. RF Voltage (dBuV) = 20 log RF Voltage (uV)

2. In the Above Table, the tighter limit applies at the band edges.

3. Distance refers to the distance in meters between the measuring instrument antenna and the closed point of any part of the device or system.

4.4. Test Procedure

The EUT was setup according to ANSI C63.10:2013 and tested according to DTS test procedure of KDB558074 V03R02 for compliance to FCC 47CFR 15.247 requirements. The EUT and its simulators are placed on a turn table which is 0.8 or 1.5 meter above ground. The turn table can rotate 360 degrees to determine the position of the maximum emission level.

The antenna can move up and down between 1 meter and 4 meters to find out the maximum emission level.

Both horizontal and vertical polarization of the antenna are set on measurement. In order to find the maximum emission, all of the interface cables must be manipulated according to ANSI C63.10:2013 on radiated measurement.

On any frequency or frequencies below or equal to 1000 MHz, the limits shown are based on measuring equipment employing a quasi-peak detector function and on any frequency or frequencies above 1000 MHz the radiated limits shown are based upon the use of measurement instrumentation employing an average detector function. When average radiated emission measurement are included emission measurement below 1000 MHz, there also is a limit on the radio frequency emissions, as measured using instrumentation with a peak detector function, corresponding to 20 dB above the maximum permitted average limit. The bandwidth below 1GHz setting on the field strength meter is 120 kHz and above 1GHz is 1MHz.

4.5. Test Specification

According to FCC Part 15 Subpart C Paragraph 15.247

4.6. Test Result

30MHz-1GHz Spurious

Site : CB4-H	Time : 2017/03/01
Limit : FCC_CLASS_B_03M_QP	Margin : 6
Probe : CB4-H_FCC_EFS_S2_30M-1GHz_1116 - HORIZONTAL	Power : AC 120V/60Hz
EUT : HD 180 Degree Wi-Fi Camera	Note : Mode 1: Transmit (Stand) 2440MHz

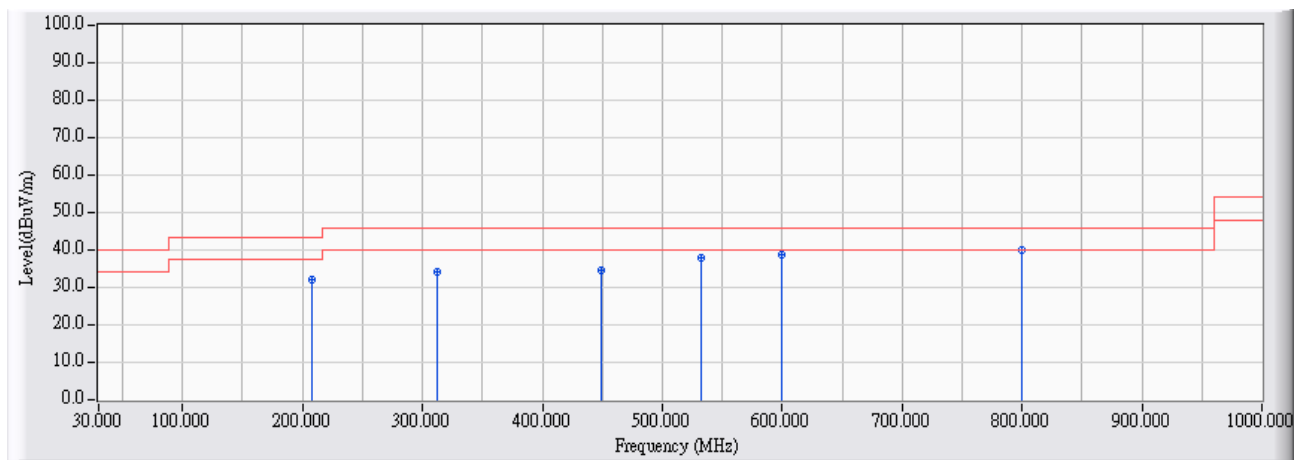

	Frequency (MHz)	Correct Factor (dB)	Reading Level (dBuV)	Measure Level (dBuV/m)	Margin (dB)	Limit (dBuV/m)	Detector Type
1	207.350	-22.784	54.931	32.148	-11.352	43.500	QUASPEAK
2	312.300	-19.375	53.360	33.985	-12.015	46.000	QUASPEAK
3	449.000	-15.052	49.586	34.534	-11.466	46.000	QUASPEAK
4	532.300	-14.214	52.239	38.025	-7.975	46.000	QUASPEAK
5	599.850	-13.140	52.065	38.925	-7.075	46.000	QUASPEAK
6	* 799.800	-10.963	50.861	39.898	-6.102	46.000	QUASPEAK

Note:

1. All Reading Levels are Quasi-Peak value.
2. “ * ”, means this data is the worst emission level.
3. Measurement Level = Reading Level + Correct Factor.

Site : CB4-H	Time : 2017/03/01
Limit : FCC_CLASS_B_03M_QP	Margin : 6
Probe : CB4-H_FCC_EFS_S2_30M-1GHz_1116 - VERTICAL	Power : AC 120V/60Hz
EUT : HD 180 Degree Wi-Fi Camera	Note : Mode 1: Transmit (Stand) 2440MHz

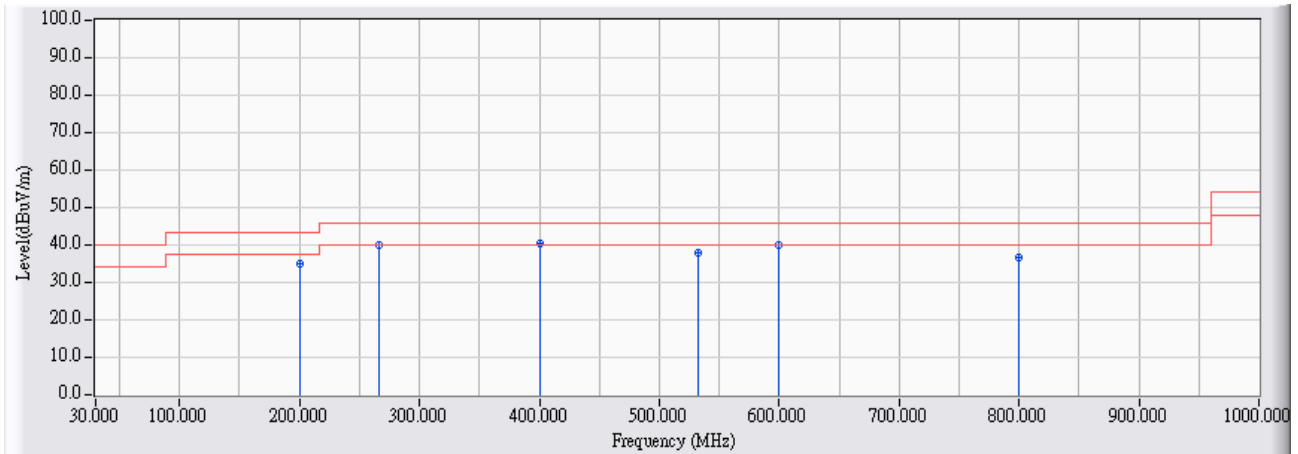

	Frequency (MHz)	Correct Factor (dB)	Reading Level (dBuV)	Measure Level (dBuV/m)	Margin (dB)	Limit (dBuV/m)	Detector Type
1	199.900	-23.339	58.323	34.984	-8.516	43.500	QUASPEAK
2	266.500	-20.252	60.111	39.859	-6.141	46.000	QUASPEAK
3	* 400.100	-16.011	56.549	40.537	-5.463	46.000	QUASPEAK
4	532.550	-14.200	51.967	37.766	-8.234	46.000	QUASPEAK
5	599.950	-13.134	52.968	39.833	-6.167	46.000	QUASPEAK
6	799.450	-10.944	47.493	36.549	-9.451	46.000	QUASPEAK

Note:

1. All Reading Levels are Quasi-Peak value.
2. “ * ”, means this data is the worst emission level.
3. Measurement Level = Reading Level + Correct Factor.

Site : CB4-H	Time : 2017/05/19
Limit : FCC_CLASS_B_03M_QP	Margin : 6
Probe : CB4-H_FCC_EFS_S2_30M-1GHz_1116 - HORIZONTAL	Power : AC 120V/60Hz
EUT : HD 180 Degree Wi-Fi Camera	Note : Mode 2: Transmit (Wall mount) 2440MHz

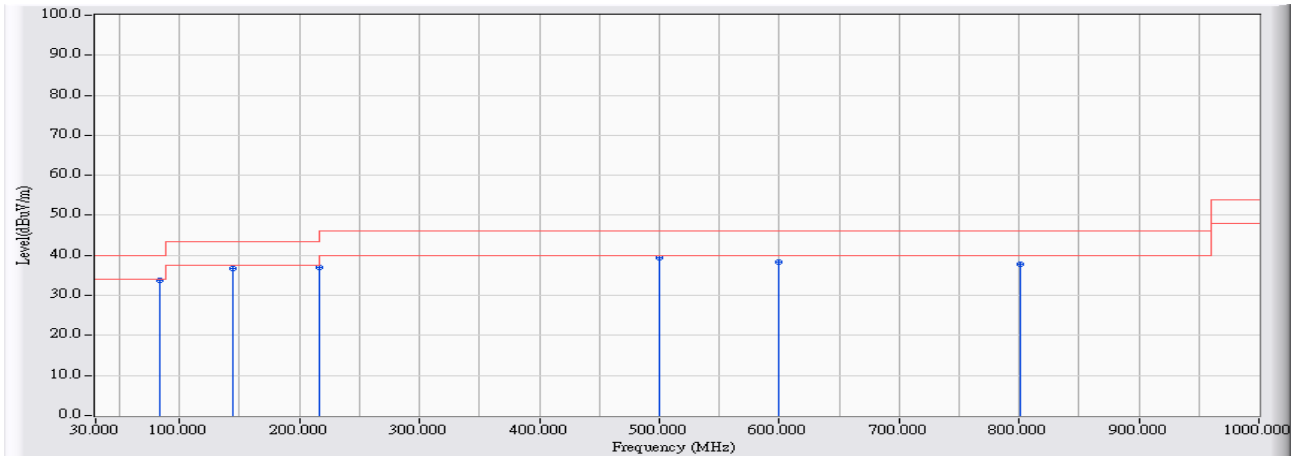

		Frequency (MHz)	Correct Factor (dB)	Reading Level (dBuV)	Measure Level (dBuV/m)	Margin (dB)	Limit (dBuV/m)	Detector Type
1	*	83.835	-26.449	60.154	33.705	-6.295	40.000	QUASPEAK
2		143.975	-21.836	58.697	36.861	-6.639	43.500	QUASPEAK
3		216.240	-22.211	59.305	37.093	-8.907	46.000	QUASPEAK
4		499.965	-14.040	53.525	39.485	-6.515	46.000	QUASPEAK
5		599.875	-12.694	51.099	38.405	-7.595	46.000	QUASPEAK
6		800.665	-10.475	48.167	37.692	-8.308	46.000	QUASPEAK

Note:

1. All Reading Levels are Quasi-Peak value.
2. “ * ”, means this data is the worst emission level.
3. Measurement Level = Reading Level + Correct Factor.

Site : CB4-H	Time : 2017/05/19
Limit : FCC_CLASS_B_03M_QP	Margin : 6
Probe : CB4-H_FCC_EFS_S2_30M-1GHz_1116 - VERTICAL	Power : AC 120V/60Hz
EUT : HD 180 Degree Wi-Fi Camera	Note : Mode 2: Transmit (Wall mount) 2440MHz

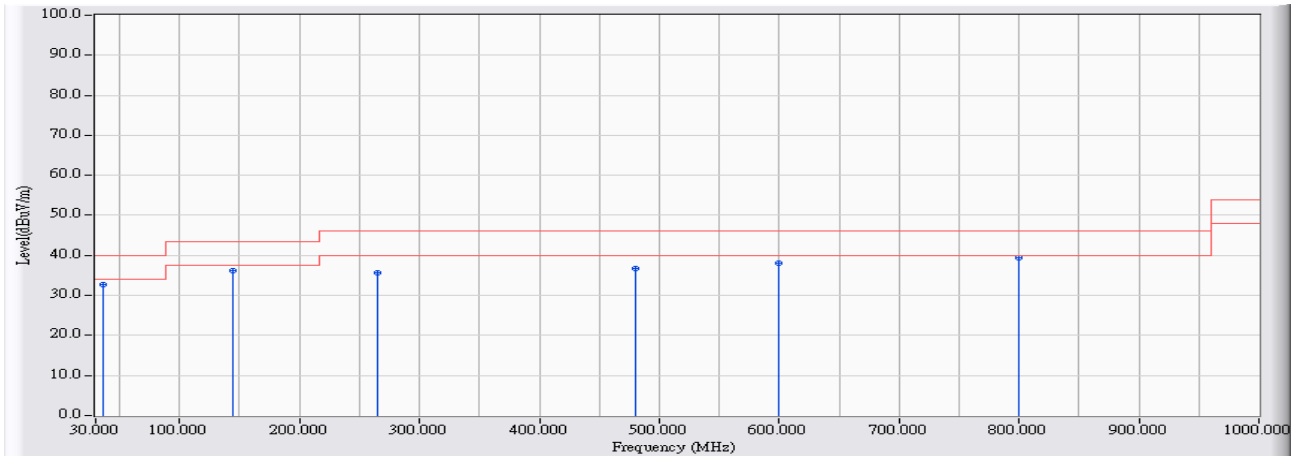

	Frequency (MHz)	Correct Factor (dB)	Reading Level (dBuV)	Measure Level (dBuV/m)	Margin (dB)	Limit (dBuV/m)	Detector Type
1	35.820	-16.715	49.494	32.778	-7.222	40.000	QUASPEAK
2	143.975	-21.836	58.026	36.190	-7.310	43.500	QUASPEAK
3	264.740	-20.104	55.742	35.638	-10.362	46.000	QUASPEAK
4	480.080	-14.513	51.162	36.649	-9.351	46.000	QUASPEAK
5	599.875	-12.694	50.893	38.199	-7.801	46.000	QUASPEAK
6	* 799.695	-10.451	49.860	39.409	-6.591	46.000	QUASPEAK

Note:

1. All Reading Levels are Quasi-Peak value.
2. “ * ”, means this data is the worst emission level.
3. Measurement Level = Reading Level + Correct Factor.

Above 1GHz Spurious

Site : CB4-H	Time : 2017/02/22
Limit : FCC_SpartC_15.209_03M_PK	Margin : 6
Probe : CB4-H_FCC_EFS_B432_1-18GHz_3M_1116 - HORIZONTAL	Power : AC 120V/60Hz
EUT : HD 180 Degree Wi-Fi Camera	Note : Mode 1: Transmit (Stand) 2402MHz

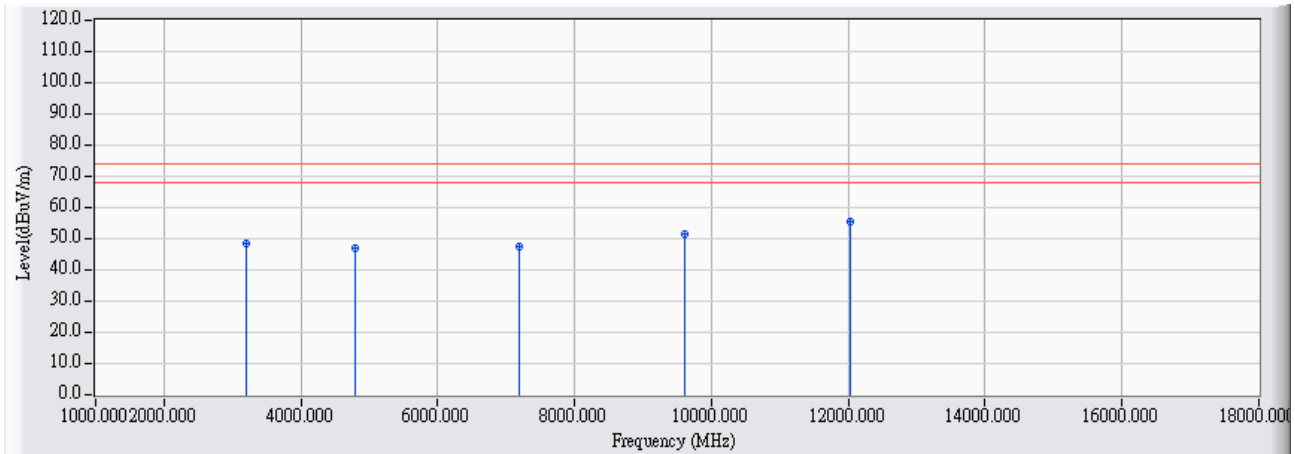

	Frequency (MHz)	Correct Factor (dB)	Reading Level (dBuV)	Measure Level (dBuV/m)	Margin (dB)	Limit (dBuV/m)	Detector Type
1	3203.000	1.694	46.560	48.253	-25.747	74.000	PEAK
2	4803.000	6.994	39.800	46.794	-27.206	74.000	PEAK
3	7196.000	15.069	32.520	47.589	-26.411	74.000	PEAK
4	9604.000	21.166	30.350	51.516	-22.484	74.000	PEAK
5	* 12019.000	25.214	30.110	55.324	-18.676	74.000	PEAK

Note:

1. All readings above 1GHz are performed with peak and/or average measurements as necessary.
2. Peak measurements: RBW = 1MHz, VBW = 3 MHz, Sweep: Auto.
3. Average measurements: RBW = 1MHz, VBW = 10 Hz, Sweep: Auto.
4. “ * ”, means this data is the worst emission level.
5. Measurement Level = Reading Level + Correct Factor.
6. The average measurement was not performed when the peak measured data under the limit of average detection.
7. The Emission above 13GHz were not included is because their levels are too low.

Site : CB4-H	Time : 2017/03/04
Limit : FCC_SpartC_15.209_03M_AV	Margin : 6
Probe : CB4-H_FCC_EFS_B432_1-18GHz_3M_1116 - HORIZONTAL	Power : AC 120V/60Hz
EUT : HD 180 Degree Wi-Fi Camera	Note : Mode 1: Transmit (Stand) 2402MHz

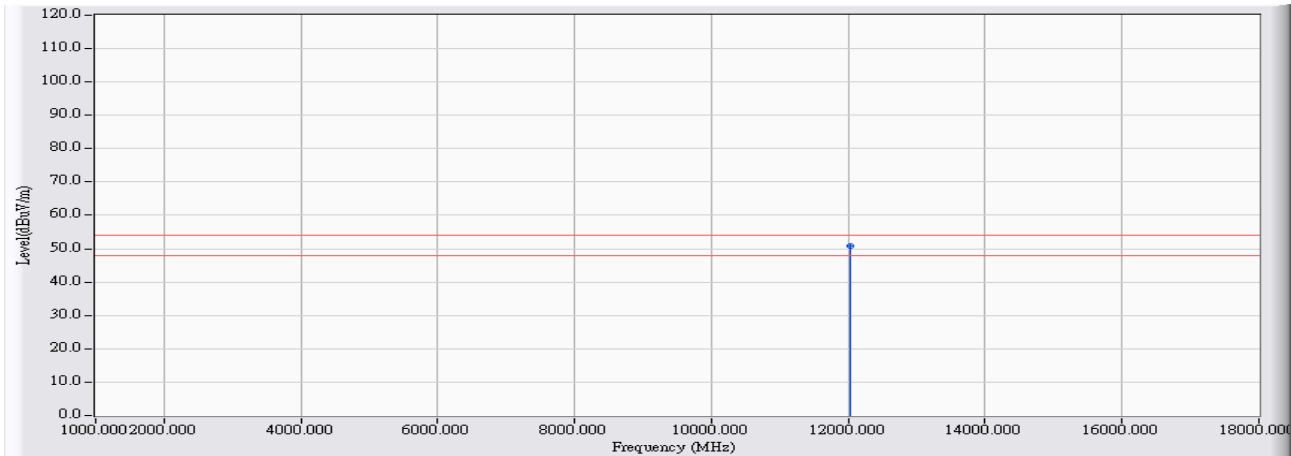

		Frequency (MHz)	Correct Factor (dB)	Reading Level (dBuV)	Measure Level (dBuV/m)	Margin (dB)	Limit (dBuV/m)	Detector Type
1	*	12019.000	25.214	25.613	50.827	-3.173	54.000	AVERAGE

Note:

1. All readings above 1GHz are performed with peak and/or average measurements as necessary.
2. Peak measurements: RBW = 1MHz, VBW = 3 MHz, Sweep: Auto.
3. Average measurements: RBW = 1MHz, VBW = 10 Hz, Sweep: Auto.
4. “ * ”, means this data is the worst emission level.
5. Measurement Level = Reading Level + Correct Factor.
6. The average measurement was not performed when the peak measured data under the limit of average detection.
7. The Emission above 13GHz were not included is because their levels are too low.

Site : CB4-H	Time : 2017/02/22
Limit : FCC_SpartC_15.209_03M_PK	Margin : 6
Probe : CB4-H_FCC_EFS_B432_1-18GHz_3M_1116 - VERTICAL	Power : AC 120V/60Hz
EUT : HD 180 Degree Wi-Fi Camera	Note : Mode 1: Transmit (Stand) 2402MHz

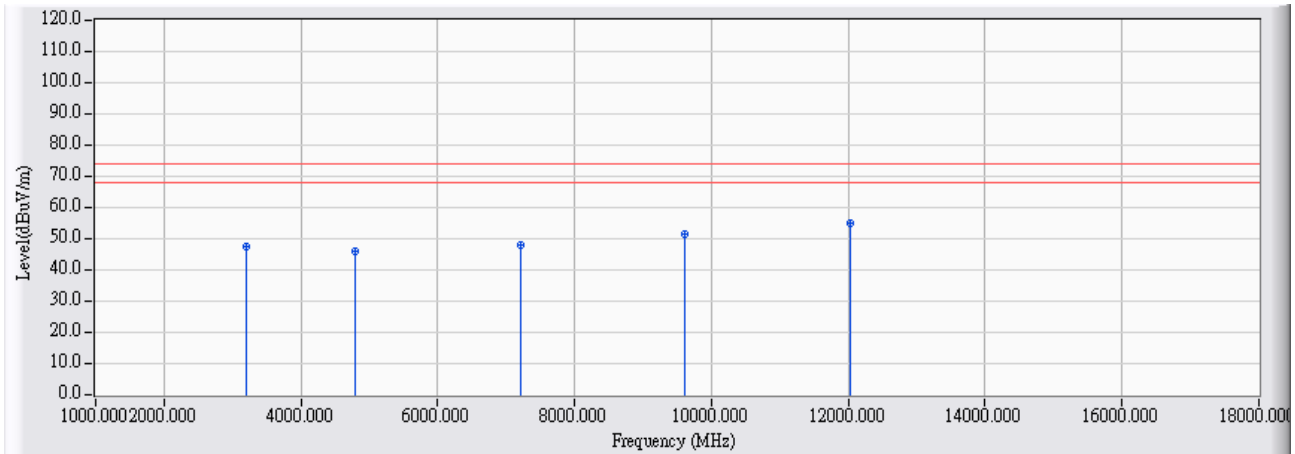

	Frequency (MHz)	Correct Factor (dB)	Reading Level (dBuV)	Measure Level (dBuV/m)	Margin (dB)	Limit (dBuV/m)	Detector Type
1	3199.000	1.687	45.580	47.266	-26.734	74.000	PEAK
2	4803.000	6.994	39.220	46.214	-27.786	74.000	PEAK
3	7208.000	15.131	32.790	47.922	-26.078	74.000	PEAK
4	9607.000	21.171	30.160	51.330	-22.670	74.000	PEAK
5	* 12018.000	25.217	29.740	54.956	-19.044	74.000	PEAK

Note:

1. All readings above 1GHz are performed with peak and/or average measurements as necessary.
2. Peak measurements: RBW = 1MHz, VBW = 3 MHz, Sweep: Auto.
3. Average measurements: RBW = 1MHz, VBW = 10 Hz, Sweep: Auto.
4. “ * ”, means this data is the worst emission level.
5. Measurement Level = Reading Level + Correct Factor.
6. The average measurement was not performed when the peak measured data under the limit of average detection.
7. The Emission above 13GHz were not included is because their levels are too low.

Site : CB4-H	Time : 2017/03/04
Limit : FCC_SpartC_15.209_03M_AV	Margin : 6
Probe : CB4-H_FCC_EFS_B432_1-18GHz_3M_1116 - VERTICAL	Power : AC 120V/60Hz
EUT : HD 180 Degree Wi-Fi Camera	Note : Mode 1: Transmit (Stand) 2402MHz

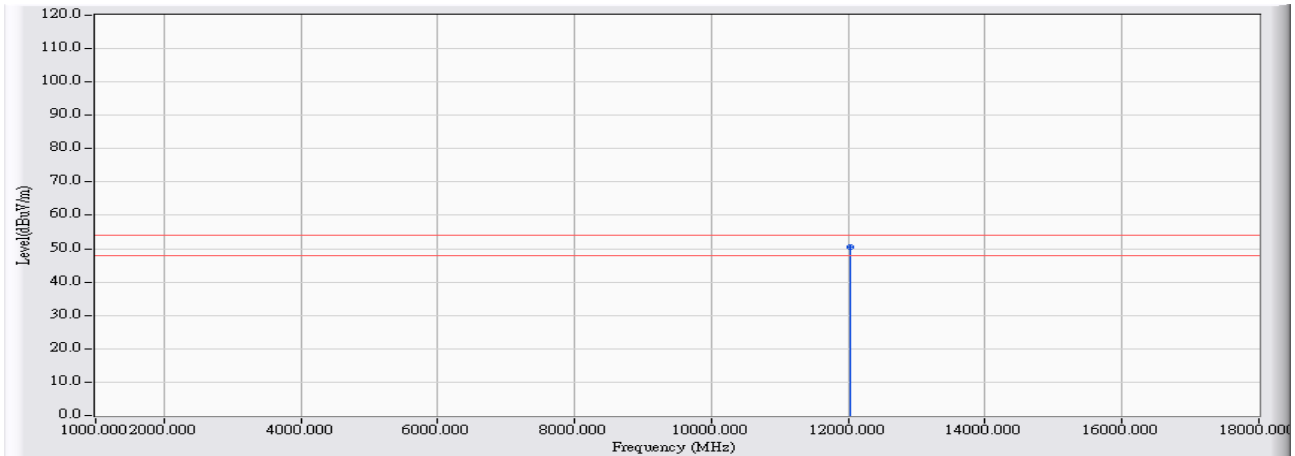

		Frequency (MHz)	Correct Factor (dB)	Reading Level (dBuV)	Measure Level (dBuV/m)	Margin (dB)	Limit (dBuV/m)	Detector Type
1	*	12018.000	25.217	25.243	50.459	-3.541	54.000	AVERAGE

Note:

1. All readings above 1GHz are performed with peak and/or average measurements as necessary.
2. Peak measurements: RBW = 1MHz, VBW = 3 MHz, Sweep: Auto.
3. Average measurements: RBW = 1MHz, VBW = 10 Hz, Sweep: Auto.
4. “ * ”, means this data is the worst emission level.
5. Measurement Level = Reading Level + Correct Factor.
6. The average measurement was not performed when the peak measured data under the limit of average detection.
7. The Emission above 13GHz were not included is because their levels are too low.

Site : CB4-H	Time : 2017/02/23
Limit : FCC_SpartC_15.209_03M_PK	Margin : 6
Probe : CB4-H_FCC_EFS_B432_1-18GHz_3M_1116 - HORIZONTAL	Power : AC 120V/60Hz
EUT : HD 180 Degree Wi-Fi Camera	Note : Mode 1: Transmit (Stand) 2440MHz

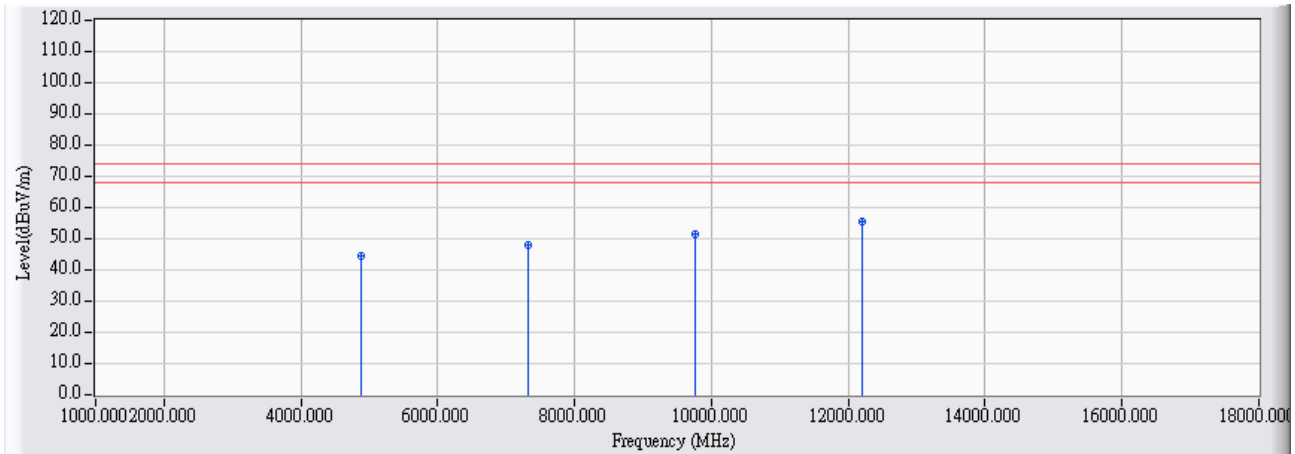

	Frequency (MHz)	Correct Factor (dB)	Reading Level (dBuV)	Measure Level (dBuV/m)	Margin (dB)	Limit (dBuV/m)	Detector Type
1	4880.000	7.238	37.270	44.508	-29.492	74.000	PEAK
2	7318.000	15.703	32.500	48.204	-25.796	74.000	PEAK
3	9759.000	21.399	29.870	51.269	-22.731	74.000	PEAK
4	* 12194.000	24.885	30.420	55.305	-18.695	74.000	PEAK

Note:

1. All readings above 1GHz are performed with peak and/or average measurements as necessary.
2. Peak measurements: RBW = 1MHz, VBW = 3 MHz, Sweep: Auto.
3. Average measurements: RBW = 1MHz, VBW = 10 Hz, Sweep: Auto.
4. “ * ”, means this data is the worst emission level.
5. Measurement Level = Reading Level + Correct Factor.
6. The average measurement was not performed when the peak measured data under the limit of average detection.
7. The Emission above 13GHz were not included is because their levels are too low.

Site : CB4-H	Time : 2017/03/04
Limit : FCC_SpartC_15.209_03M_AV	Margin : 6
Probe : CB4-H_FCC_EFS_B432_1-18GHz_3M_1116 - HORIZONTAL	Power : AC 120V/60Hz
EUT : HD 180 Degree Wi-Fi Camera	Note : Mode 1: Transmit (Stand) 2440MHz

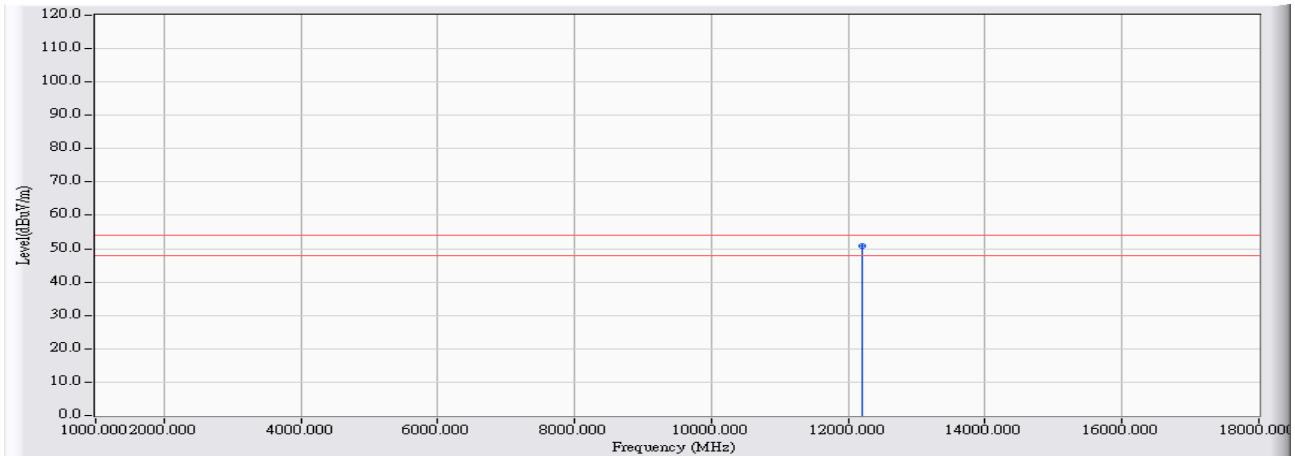

		Frequency (MHz)	Correct Factor (dB)	Reading Level (dBuV)	Measure Level (dBuV/m)	Margin (dB)	Limit (dBuV/m)	Detector Type
1	*	12194.000	24.885	25.804	50.689	-3.311	54.000	AVERAGE

Note:

1. All readings above 1GHz are performed with peak and/or average measurements as necessary.
2. Peak measurements: RBW = 1MHz, VBW = 3 MHz, Sweep: Auto.
3. Average measurements: RBW = 1MHz, VBW = 10 Hz, Sweep: Auto.
4. “ * ”, means this data is the worst emission level.
5. Measurement Level = Reading Level + Correct Factor.
6. The average measurement was not performed when the peak measured data under the limit of average detection.
7. The Emission above 13GHz were not included is because their levels are too low.

Site : CB4-H	Time : 2017/02/23
Limit : FCC_SpartC_15.209_03M_PK	Margin : 6
Probe : CB4-H_FCC_EFS_B432_1-18GHz_3M_1116 - VERTICAL	Power : AC 120V/60Hz
EUT : HD 180 Degree Wi-Fi Camera	Note : Mode 1: Transmit (Stand) 2440MHz

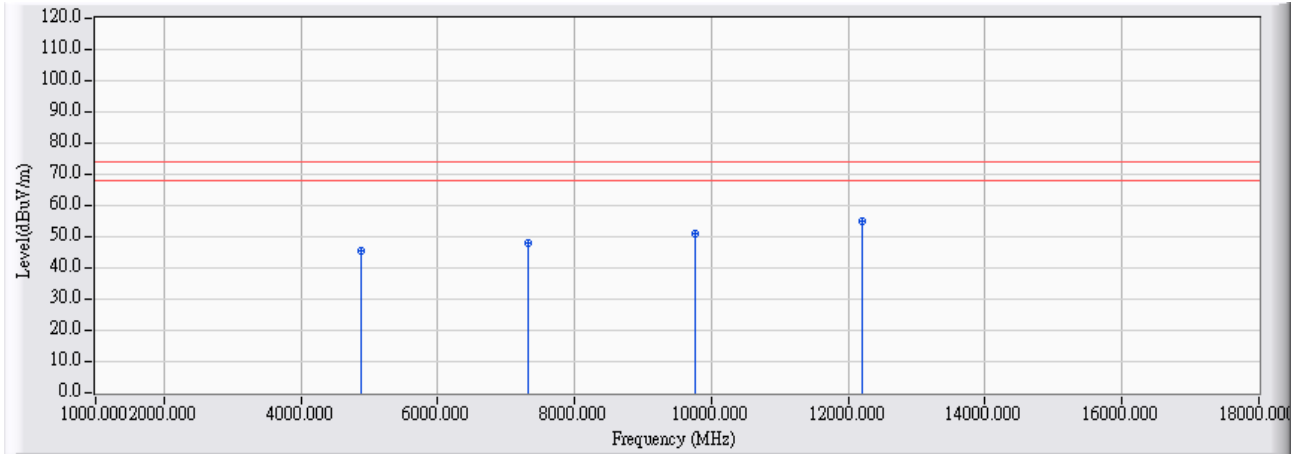

	Frequency (MHz)	Correct Factor (dB)	Reading Level (dBuV)	Measure Level (dBuV/m)	Margin (dB)	Limit (dBuV/m)	Detector Type
1	4879.000	7.236	38.180	45.415	-28.585	74.000	PEAK
2	7318.000	15.703	32.300	48.004	-25.996	74.000	PEAK
3	9752.000	21.389	29.610	50.998	-23.002	74.000	PEAK
4	* 12193.000	24.888	29.890	54.777	-19.223	74.000	PEAK

Note:

1. All readings above 1GHz are performed with peak and/or average measurements as necessary.
2. Peak measurements: RBW = 1MHz, VBW = 3 MHz, Sweep: Auto.
3. Average measurements: RBW = 1MHz, VBW = 10 Hz, Sweep: Auto.
4. “ * ”, means this data is the worst emission level.
5. Measurement Level = Reading Level + Correct Factor.
6. The average measurement was not performed when the peak measured data under the limit of average detection.
7. The Emission above 13GHz were not included is because their levels are too low.

Site : CB4-H	Time : 2017/03/04
Limit : FCC_SpartC_15.209_03M_AV	Margin : 6
Probe : CB4-H_FCC_EFS_B432_1-18GHz_3M_1116 - VERTICAL	Power : AC 120V/60Hz
EUT : HD 180 Degree Wi-Fi Camera	Note : Mode 1: Transmit (Stand) 2440MHz

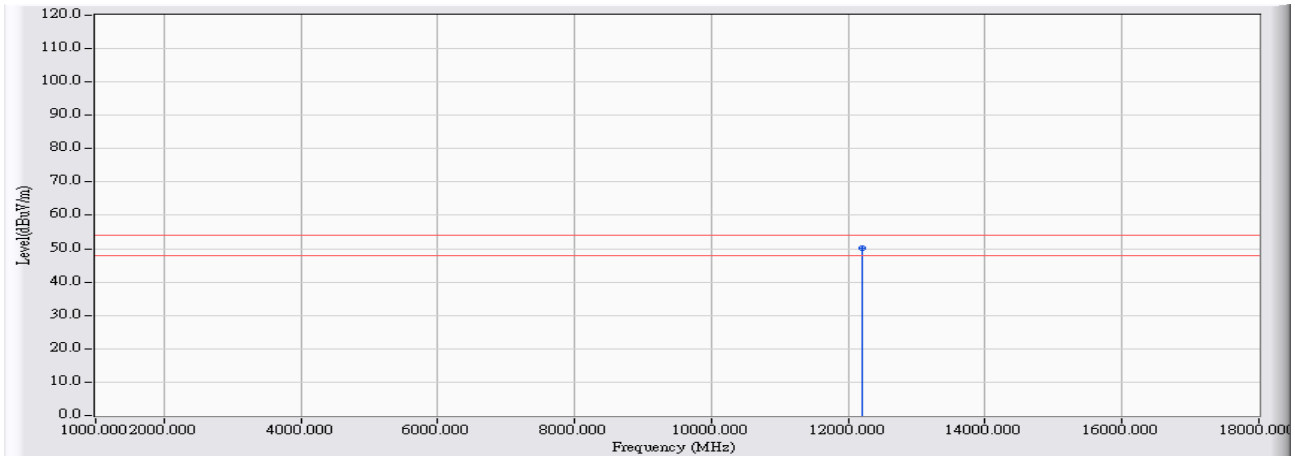

		Frequency (MHz)	Correct Factor (dB)	Reading Level (dBuV)	Measure Level (dBuV/m)	Margin (dB)	Limit (dBuV/m)	Detector Type
1	*	12193.000	24.888	25.274	50.161	-3.839	54.000	AVERAGE

Note:

1. All readings above 1GHz are performed with peak and/or average measurements as necessary.
2. Peak measurements: RBW = 1MHz, VBW = 3 MHz, Sweep: Auto.
3. Average measurements: RBW = 1MHz, VBW = 10 Hz, Sweep: Auto.
4. “ * ”, means this data is the worst emission level.
5. Measurement Level = Reading Level + Correct Factor.
6. The average measurement was not performed when the peak measured data under the limit of average detection.
7. The Emission above 13GHz were not included is because their levels are too low.

Site : CB4-H	Time : 2017/02/23
Limit : FCC_SpartC_15.209_03M_PK	Margin : 6
Probe : CB4-H_FCC_EFS_B432_1-18GHz_3M_1116 - HORIZONTAL	Power : AC 120V/60Hz
EUT : HD 180 Degree Wi-Fi Camera	Note : Mode 1: Transmit (Stand) 2480MHz

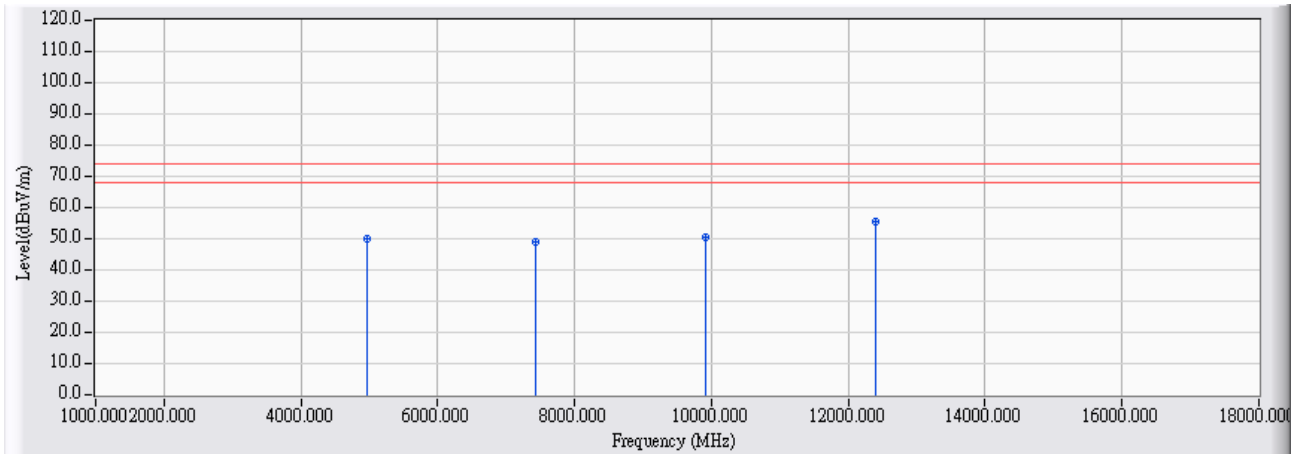

		Frequency (MHz)	Correct Factor (dB)	Reading Level (dBuV)	Measure Level (dBuV/m)	Margin (dB)	Limit (dBuV/m)	Detector Type
1		4959.000	7.490	42.570	50.060	-23.940	74.000	PEAK
2		7440.000	16.338	32.700	49.038	-24.962	74.000	PEAK
3		9924.000	21.646	28.780	50.426	-23.574	74.000	PEAK
4	*	12403.000	24.492	30.800	55.292	-18.708	74.000	PEAK

Note:

1. All readings above 1GHz are performed with peak and/or average measurements as necessary.
2. Peak measurements: RBW = 1MHz, VBW = 3 MHz, Sweep: Auto.
3. Average measurements: RBW = 1MHz, VBW = 10 Hz, Sweep: Auto.
4. “ * ”, means this data is the worst emission level.
5. Measurement Level = Reading Level + Correct Factor.
6. The average measurement was not performed when the peak measured data under the limit of average detection.
7. The Emission above 13GHz were not included is because their levels are too low.

Site : CB4-H	Time : 2017/03/04
Limit : FCC_SpartC_15.209_03M_AV	Margin : 6
Probe : CB4-H_FCC_EFS_B432_1-18GHz_3M_1116 - HORIZONTAL	Power : AC 120V/60Hz
EUT : HD 180 Degree Wi-Fi Camera	Note : Mode 1: Transmit (Stand) 2480MHz

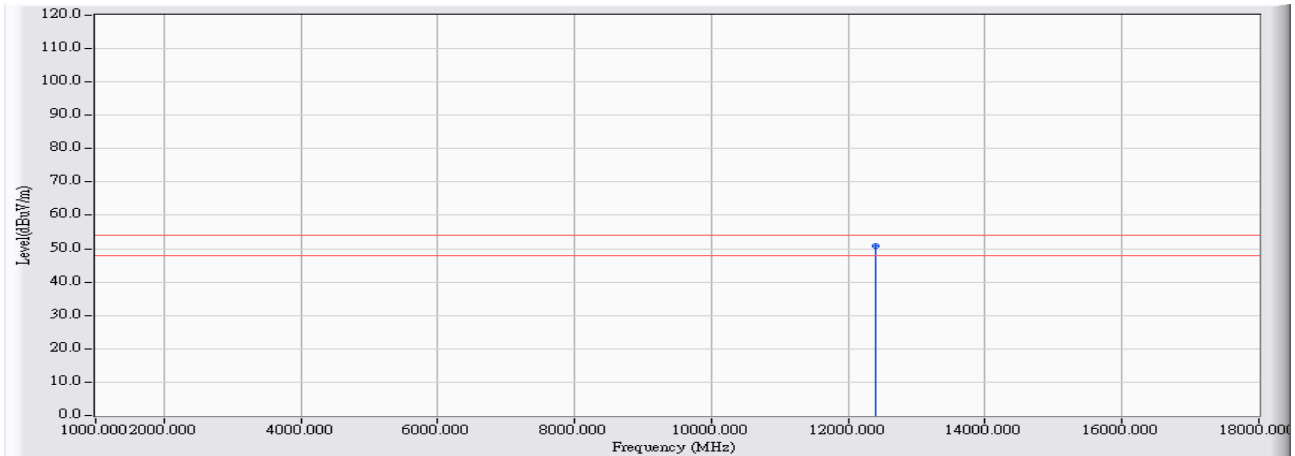

		Frequency (MHz)	Correct Factor (dB)	Reading Level (dBuV)	Measure Level (dBuV/m)	Margin (dB)	Limit (dBuV/m)	Detector Type
1	*	12403.000	24.492	26.309	50.801	-3.199	54.000	AVERAGE

Note:

1. All readings above 1GHz are performed with peak and/or average measurements as necessary.
2. Peak measurements: RBW = 1MHz, VBW = 3 MHz, Sweep: Auto.
3. Average measurements: RBW = 1MHz, VBW = 10 Hz, Sweep: Auto.
4. “ * ”, means this data is the worst emission level.
5. Measurement Level = Reading Level + Correct Factor.
6. The average measurement was not performed when the peak measured data under the limit of average detection.
7. The Emission above 13GHz were not included is because their levels are too low.

Site : CB4-H	Time : 2017/02/23
Limit : FCC_SpartC_15.209_03M_PK	Margin : 6
Probe : CB4-H_FCC_EFS_B432_1-18GHz_3M_1116 - VERTICAL	Power : AC 120V/60Hz
EUT : HD 180 Degree Wi-Fi Camera	Note : Mode 1: Transmit (Stand) 2480MHz

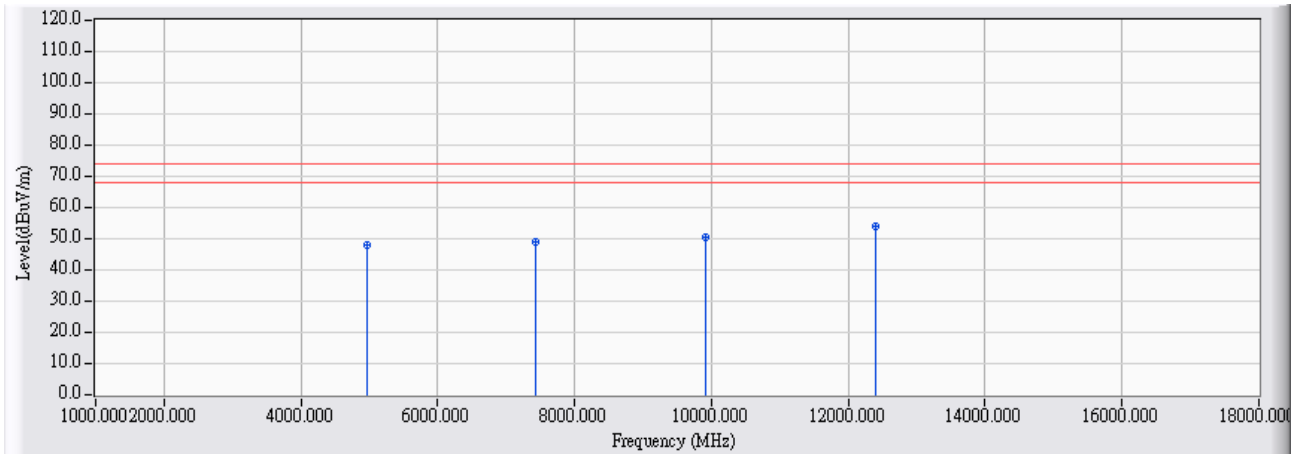

		Frequency (MHz)	Correct Factor (dB)	Reading Level (dBuV)	Measure Level (dBuV/m)	Margin (dB)	Limit (dBuV/m)	Detector Type
1		4959.000	7.490	40.560	48.050	-25.950	74.000	PEAK
2		7439.000	16.333	32.540	48.873	-25.127	74.000	PEAK
3		9916.000	21.634	29.080	50.714	-23.286	74.000	PEAK
4	*	12393.000	24.512	29.600	54.111	-19.889	74.000	PEAK

Note:

1. All readings above 1GHz are performed with peak and/or average measurements as necessary.
2. Peak measurements: RBW = 1MHz, VBW = 3 MHz, Sweep: Auto.
3. Average measurements: RBW = 1MHz, VBW = 10 Hz, Sweep: Auto.
4. “ * ”, means this data is the worst emission level.
5. Measurement Level = Reading Level + Correct Factor.
6. The average measurement was not performed when the peak measured data under the limit of average detection.
7. The Emission above 13GHz were not included is because their levels are too low.

Site : CB4-H	Time : 2017/03/04
Limit : FCC_SpartC_15.209_03M_AV	Margin : 6
Probe : CB4-H_FCC_EFS_B432_1-18GHz_3M_1116 - VERTICAL	Power : AC 120V/60Hz
EUT : HD 180 Degree Wi-Fi Camera	Note : Mode 1: Transmit (Stand) 2480MHz

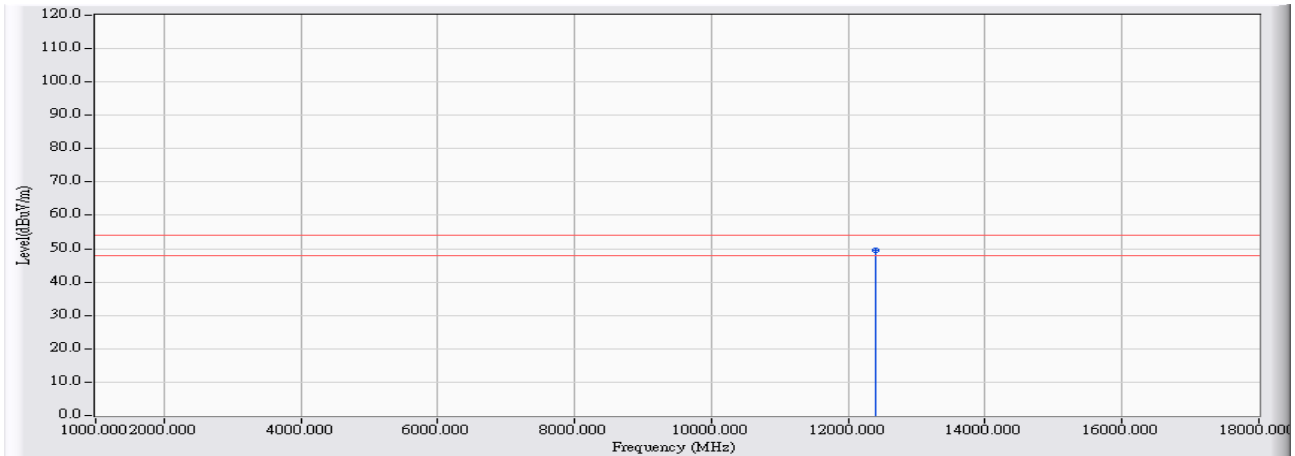

		Frequency (MHz)	Correct Factor (dB)	Reading Level (dBuV)	Measure Level (dBuV/m)	Margin (dB)	Limit (dBuV/m)	Detector Type
1	*	12393.000	24.512	25.109	49.620	-4.380	54.000	AVERAGE

Note:

1. All readings above 1GHz are performed with peak and/or average measurements as necessary.
2. Peak measurements: RBW = 1MHz, VBW = 3 MHz, Sweep: Auto.
3. Average measurements: RBW = 1MHz, VBW = 10 Hz, Sweep: Auto.
4. “ * ”, means this data is the worst emission level.
5. Measurement Level = Reading Level + Correct Factor.
6. The average measurement was not performed when the peak measured data under the limit of average detection.
7. The Emission above 13GHz were not included is because their levels are too low.

Site : CB4-H	Time : 2017/05/19
Limit : FCC_SpartC_15.209_03M_PK	Margin : 6
Probe : CB4-H_FCC_EFS_B432_1-18GHz_3M_1116 - HORIZONTAL	Power : AC 120V/60Hz
EUT : HD 180 Degree Wi-Fi Camera	Note : Mode 2: Transmit (Wall mount) 2480MHz

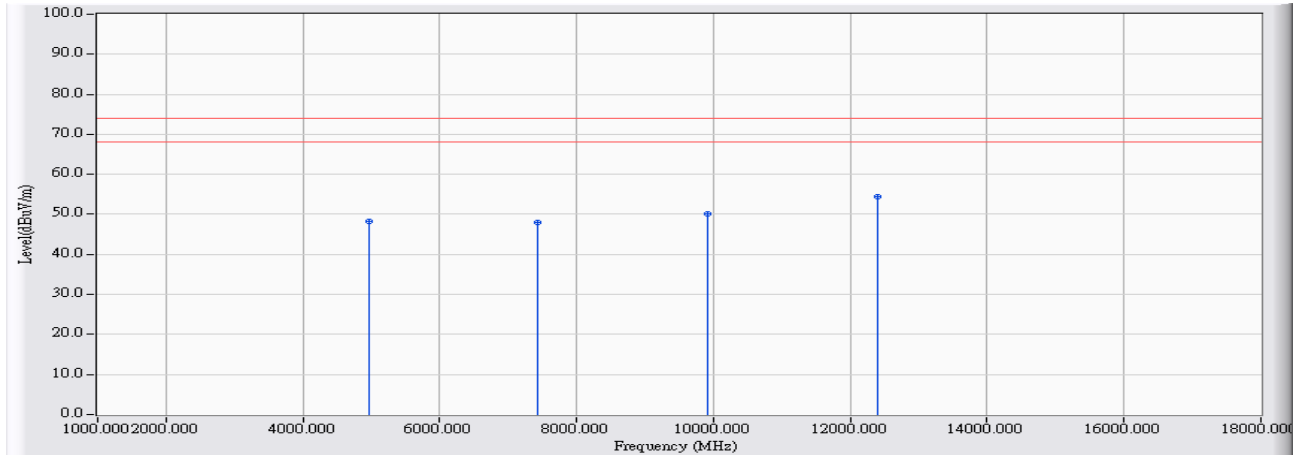

		Frequency (MHz)	Correct Factor (dB)	Reading Level (dBuV)	Measure Level (dBuV/m)	Margin (dB)	Limit (dBuV/m)	Detector Type
1		4960.000	7.771	40.585	48.356	-25.644	74.000	PEAK
2		7440.000	16.948	30.948	47.896	-26.104	74.000	PEAK
3		9920.000	22.512	27.500	50.012	-23.988	74.000	PEAK
4	*	12400.000	25.408	29.125	54.533	-19.467	74.000	PEAK

Note:

1. All readings above 1GHz are performed with peak and/or average measurements as necessary.
2. Peak measurements: RBW = 1MHz, VBW = 3 MHz, Sweep: Auto.
3. Average measurements: RBW = 1MHz, VBW = 10 Hz, Sweep: Auto.
4. “ * ”, means this data is the worst emission level.
5. Measurement Level = Reading Level + Correct Factor.
6. The average measurement was not performed when the peak measured data under the limit of average detection.
7. The Emission above 13GHz were not included is because their levels are too low.

Site : CB4-H	Time : 2017/05/19
Limit : FCC_SpartC_15.209_03M_AV	Margin : 6
Probe : CB4-H_FCC_EFS_B432_1-18GHz_3M_1116 - HORIZONTAL	Power : AC 120V/60Hz
EUT : HD 180 Degree Wi-Fi Camera	Note : Mode 2: Transmit (Wall mount) 2480MHz

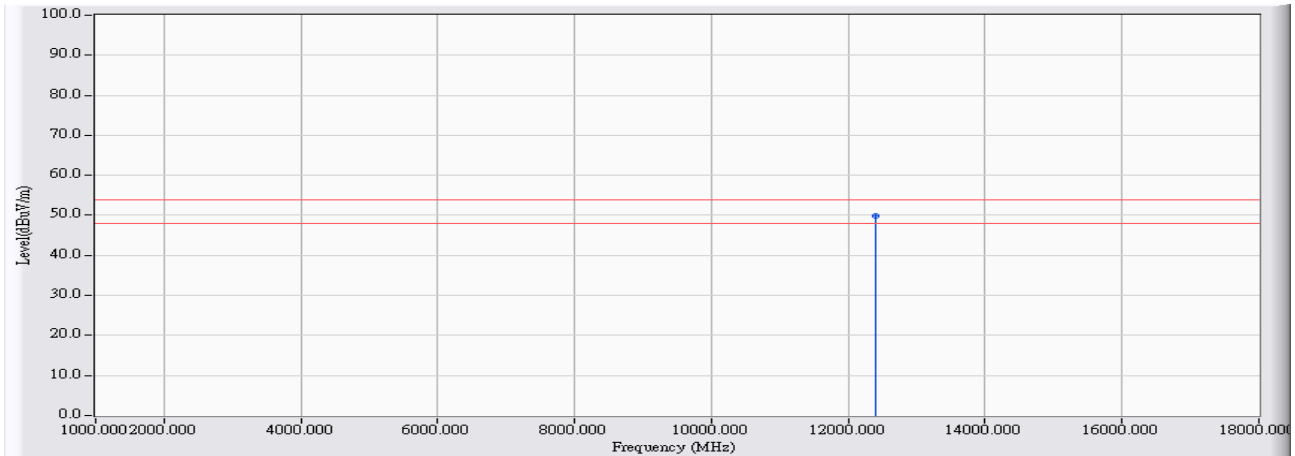

		Frequency (MHz)	Correct Factor (dB)	Reading Level (dBuV)	Measure Level (dBuV/m)	Margin (dB)	Limit (dBuV/m)	Detector Type
1	*	12400.000	25.408	24.534	49.942	-4.058	54.000	AVERAGE

Note:

1. All readings above 1GHz are performed with peak and/or average measurements as necessary.
2. Peak measurements: RBW = 1MHz, VBW = 3 MHz, Sweep: Auto.
3. Average measurements: RBW = 1MHz, VBW = 10 Hz, Sweep: Auto.
4. “ * ”, means this data is the worst emission level.
5. Measurement Level = Reading Level + Correct Factor.
6. The average measurement was not performed when the peak measured data under the limit of average detection.
7. The Emission above 13GHz were not included is because their levels are too low.

Site : CB4-H	Time : 2017/05/19
Limit : FCC_SpartC_15.209_03M_PK	Margin : 6
Probe : CB4-H_FCC_EFS_B432_1-18GHz_3M_1116 - VERTICAL	Power : AC 120V/60Hz
EUT : HD 180 Degree Wi-Fi Camera	Note : Mode 2: Transmit (Wall mount) 2480MHz

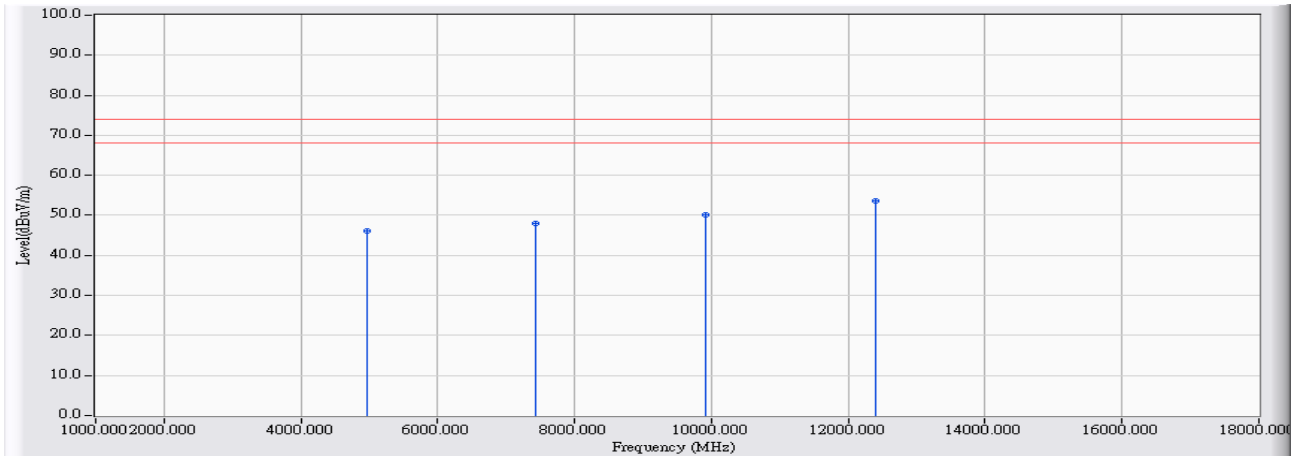

		Frequency (MHz)	Correct Factor (dB)	Reading Level (dBuV)	Measure Level (dBuV/m)	Margin (dB)	Limit (dBuV/m)	Detector Type
1		4960.000	7.771	38.460	46.231	-27.769	74.000	PEAK
2		7440.000	16.948	30.951	47.899	-26.101	74.000	PEAK
3		9920.000	22.512	27.512	50.024	-23.976	74.000	PEAK
4	*	12400.000	25.408	28.081	53.489	-20.511	74.000	PEAK

Note:

1. All readings above 1GHz are performed with peak and/or average measurements as necessary.
2. Peak measurements: RBW = 1MHz, VBW = 3 MHz, Sweep: Auto.
3. Average measurements: RBW = 1MHz, VBW = 10 Hz, Sweep: Auto.
4. “ * ”, means this data is the worst emission level.
5. Measurement Level = Reading Level + Correct Factor.
6. The average measurement was not performed when the peak measured data under the limit of average detection.
7. The Emission above 13GHz were not included is because their levels are too low.

Site : CB4-H	Time : 2017/05/19
Limit : FCC_SpartC_15.209_03M_AV	Margin : 6
Probe : CB4-H_FCC_EFS_B432_1-18GHz_3M_1116 - VERTICAL	Power : AC 120V/60Hz
EUT : HD 180 Degree Wi-Fi Camera	Note : Mode 2: Transmit (Wall mount) 2480MHz

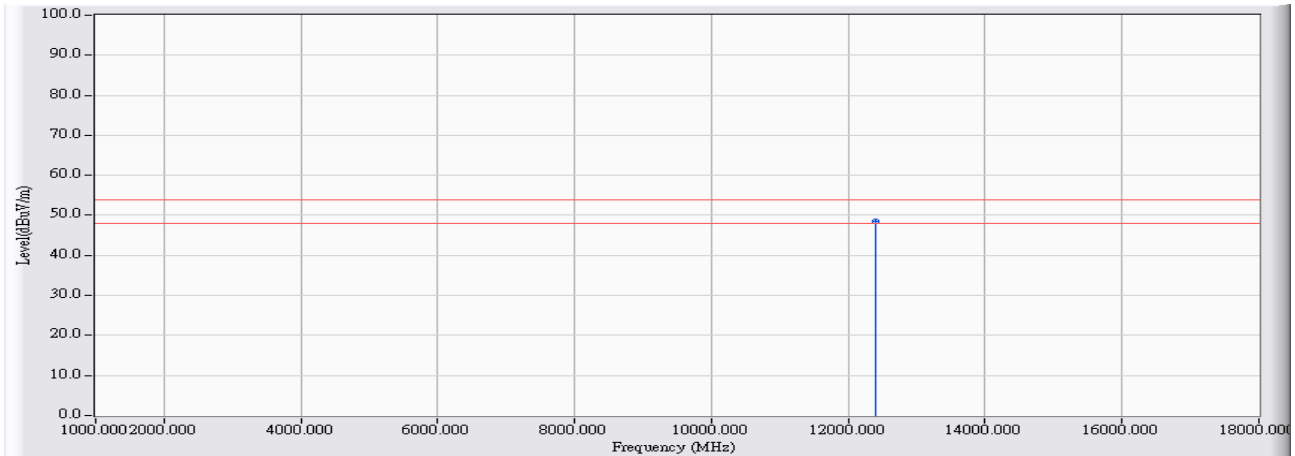

		Frequency (MHz)	Correct Factor (dB)	Reading Level (dBuV)	Measure Level (dBuV/m)	Margin (dB)	Limit (dBuV/m)	Detector Type
1	*	12400.000	25.408	23.234	48.642	-5.358	54.000	AVERAGE

Note:

1. All readings above 1GHz are performed with peak and/or average measurements as necessary.
2. Peak measurements: RBW = 1MHz, VBW = 3 MHz, Sweep: Auto.
3. Average measurements: RBW = 1MHz, VBW = 10 Hz, Sweep: Auto.
4. “ * ”, means this data is the worst emission level.
5. Measurement Level = Reading Level + Correct Factor.
6. The average measurement was not performed when the peak measured data under the limit of average detection.
7. The Emission above 13GHz were not included is because their levels are too low.

5. RF antenna conducted test

5.1. Test Equipment

The following test equipment is used during the test:

RF antenna conducted test / SR10-H

Instrument	Manufacturer	Model No.	Serial No	Next Cal. Date
Spectrum Analyzer	Agilent	N9010A	US47140172	2017/08/08

Note: All equipments that need to calibrate are with calibration period of 1 year.

5.2. Test Setup

RF Conducted Measurement:

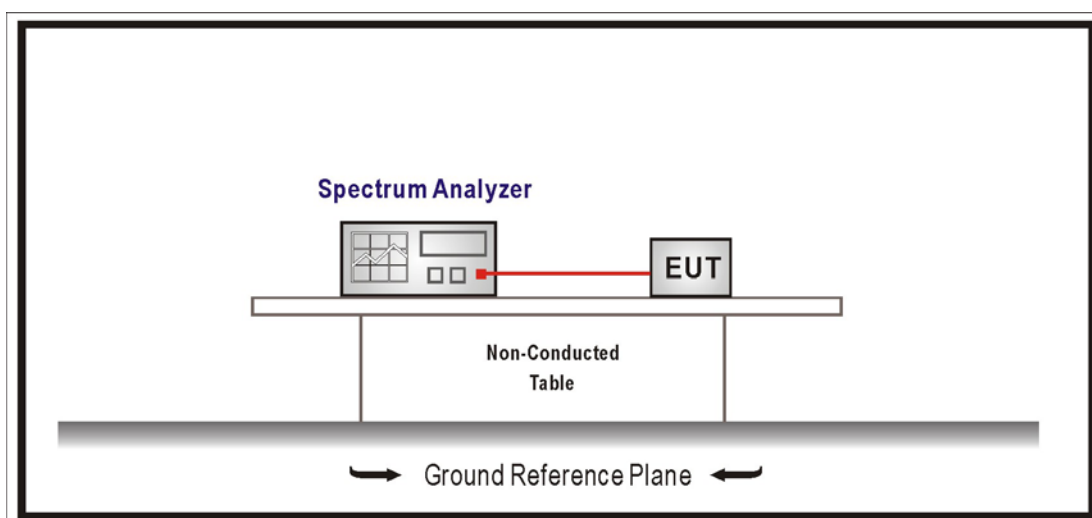

5.3. Limits

In any 100 kHz bandwidth outside the frequency band in which the spread spectrum intentional radiator is operating, the radio frequency power that is produced by the intentional radiator shall be at least 20 dB below that in the 100 kHz bandwidth within the band that contains the highest level of the desired power, based on an RF conducted or radiated measurement. Attenuation below the general limits specified in Section 15.209(a) is not required. In addition, radiated emissions which fall in the restricted bands, as defined in Section 15.205(a), must also comply with the radiated emission limits specified in Section 15.209(a) (see Section 15.205(c)).

5.4. Test Procedure

The EUT was setup according to ANSI C63.10:2013 and tested according to DTS test procedure of KDB558074 V03R02 for compliance to FCC 47CFR 15.247 requirements. Set RBW = 100 kHz, Set VBW > RBW, scan up through 10th harmonic.

5.5. Test Specification

According to FCC Part 15 Subpart C Paragraph 15.247

5.6. Test Result

Product	HD 180 Degree Wi-Fi Camera		
Test Item	RF antenna conducted test		
Test Mode	Mode 1: Transmit (Stand)		
Date of Test	2017/03/01	Test Site	SR10-H

GFSK

Channel	Frequency (MHz)	Measure Level (dBc)	Limit (dBc)	Result
00	2402	56.876	≥ 20	Pass
19	2440	66.281	≥ 20	Pass
39	2480	54.713	≥ 20	Pass

Channel 00

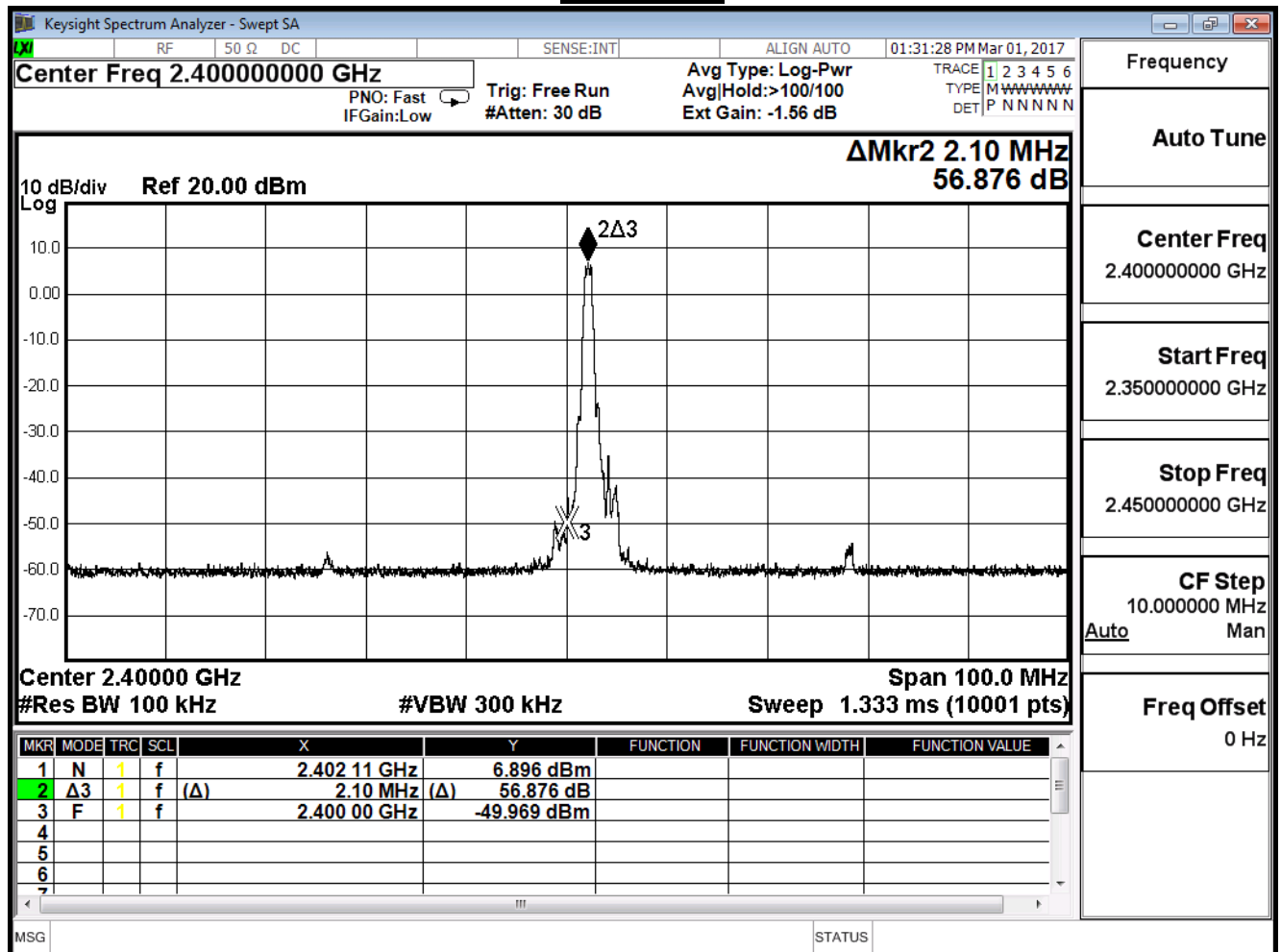

Channel 19

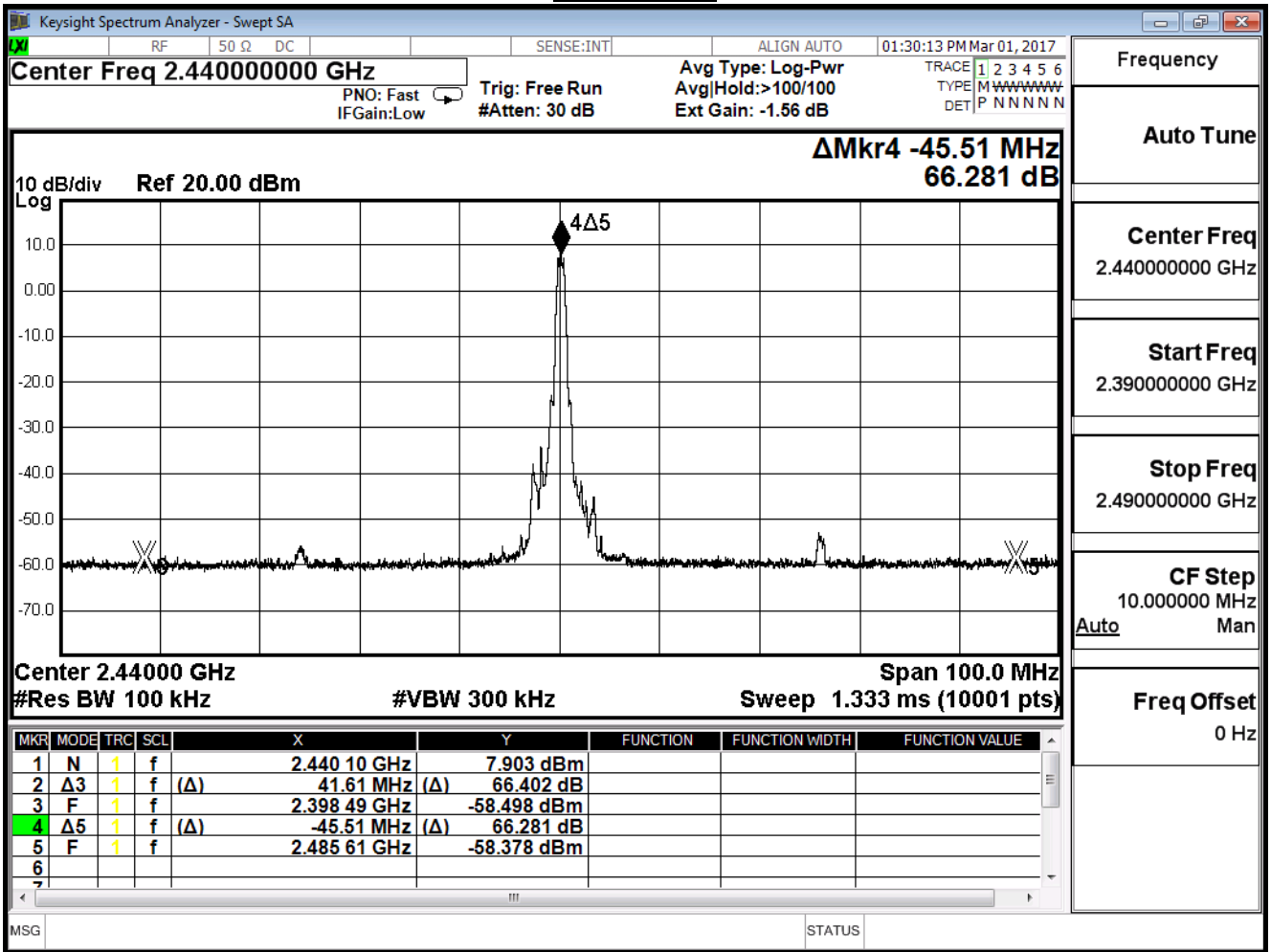

Channel 39

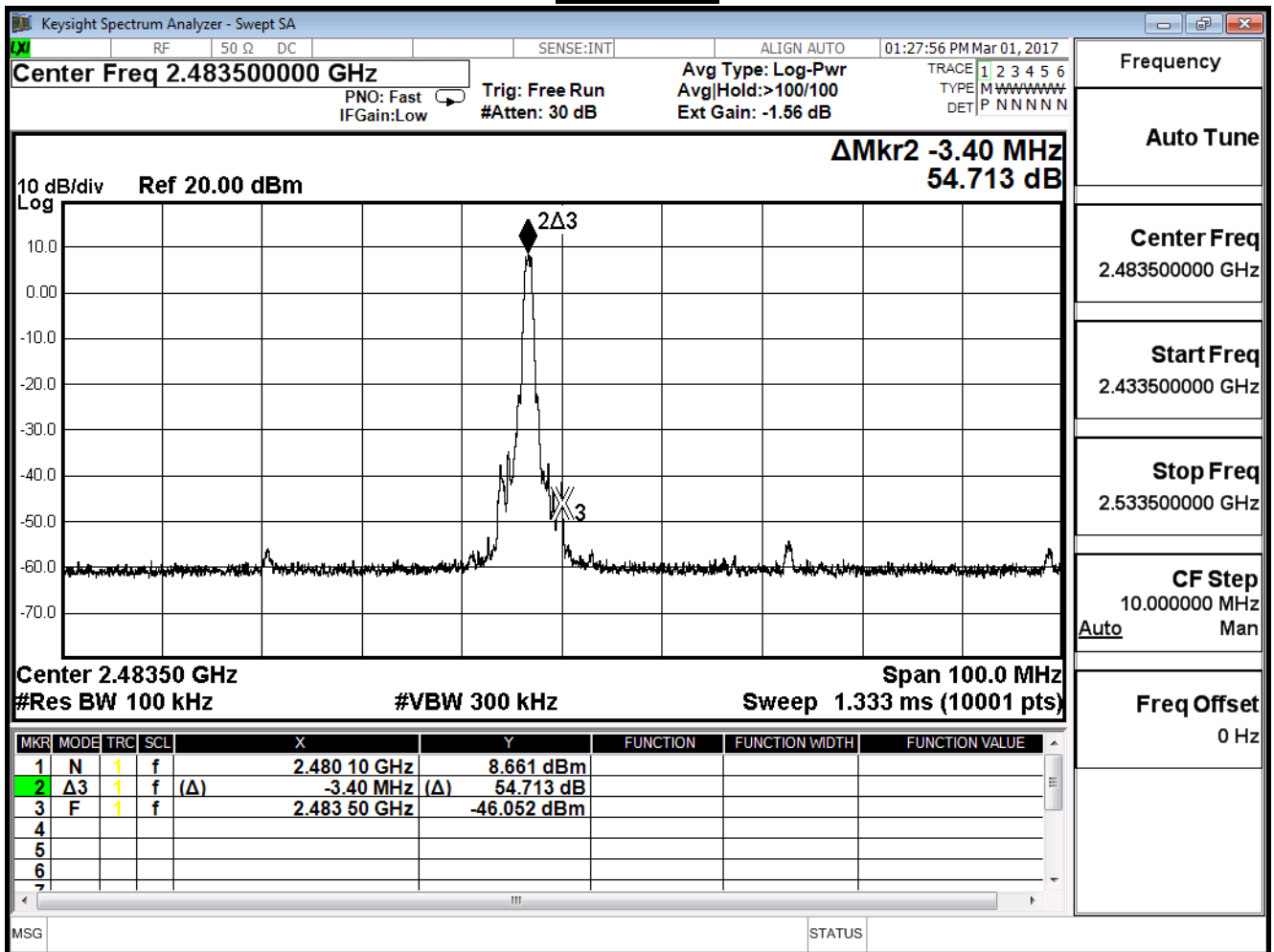

Product	HD 180 Degree Wi-Fi Camera		
Test Item	RF antenna conducted test		
Test Mode	Mode 1: Transmit (Stand)		
Date of Test	2017/03/01	Test Site	SR10-H

Channel 00 (30MHz-25GHz)- GFSK

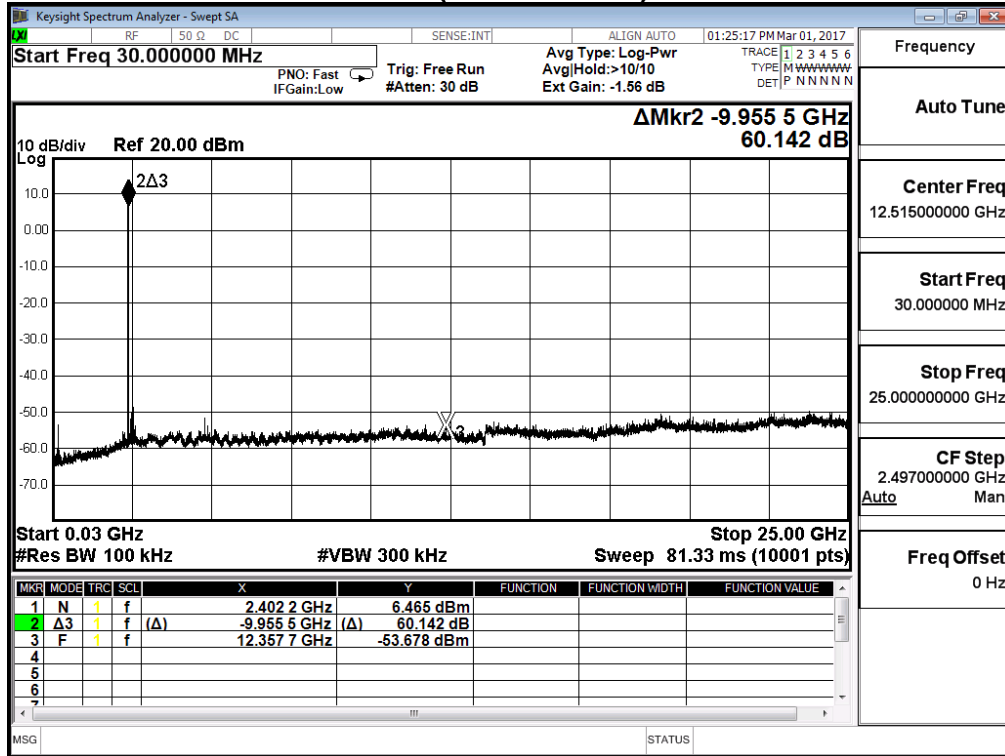

Channel 19 (30MHz-25GHz)- GFSK

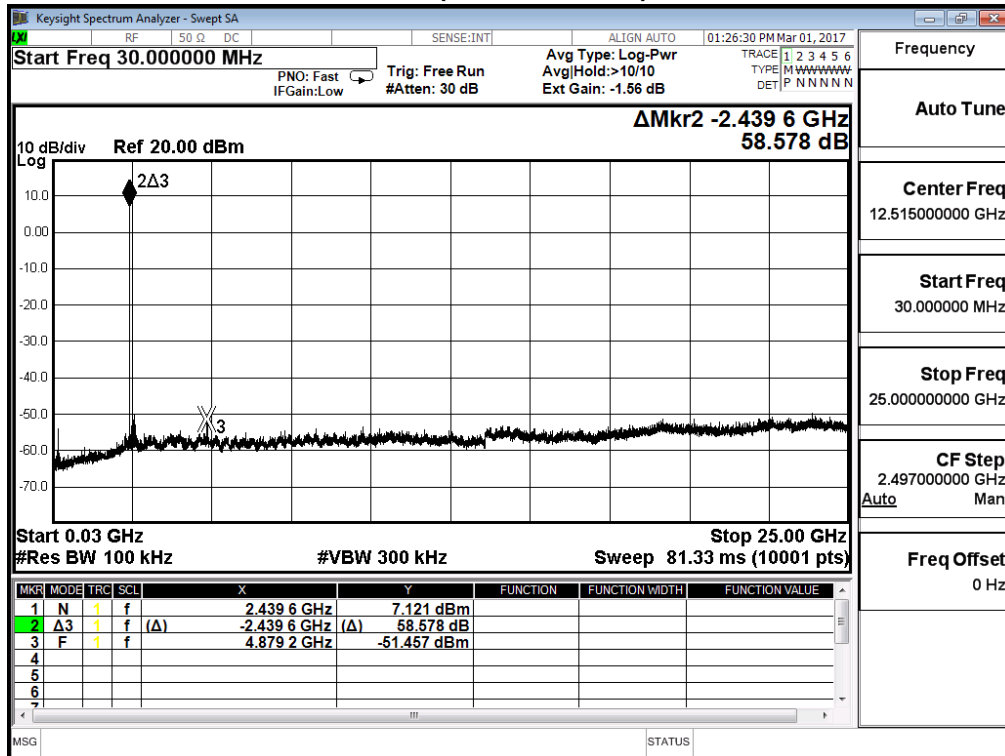

Channel 39 (30MHz-25GHz)- GFSK

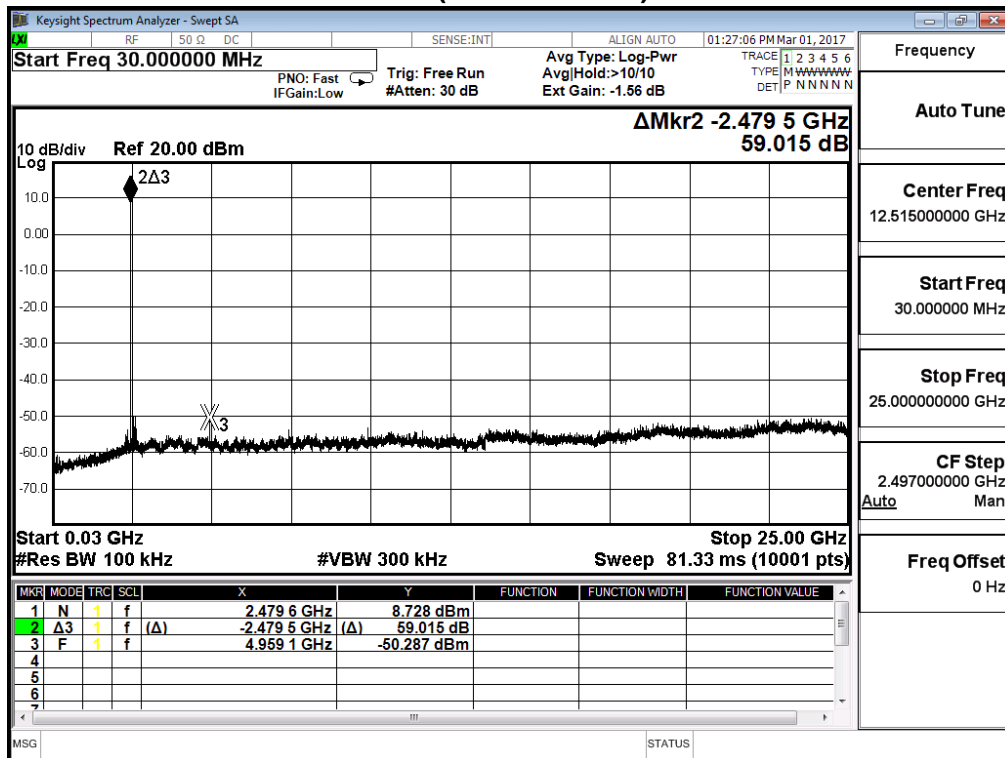

6. Band Edge

6.1. Test Equipment

The following test equipments are used during the test:

Band Edge / CB4-H

Instrument	Manufacturer	Model No.	Serial No	Next Cal. Date
Horn Antenna	Schwarzbeck	BBHA 9120	D312	2017/10/25
Signal & Spectrum Analyzer	R&S	FSV40	101049	2018/01/22
Pre-Amplifier	EMCI	EMC01820I	980364	2018/03/28
Spectrum Analyzer	Agilent	E4440A	MY46187335	2017/12/21

Note: All equipments that need to calibrate are with calibration period of 1 year.

6.2. Test Setup

RF Radiated Measurement:

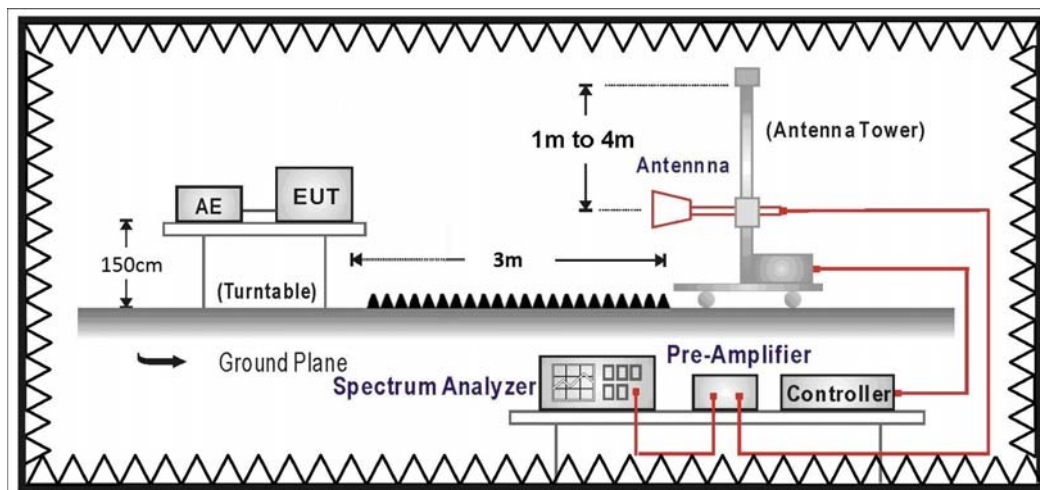

6.3. Limits

Emissions radiated outside of the specified frequency bands, except for harmonics, shall be attenuated by at least 20dB below the level of the fundamental or to the general radiated emission limits in paragraph 15.209, whichever is the lesser attenuation.

6.4. Test Procedure

The EUT was setup according to ANSI C63.10:2013 and tested according to DTS test procedure of KDB558074 V03R02 for compliance to FCC 47CFR 15.247 requirements. The EUT and its simulators are placed on a turn table which is 0.8 meter above ground. The turn table can rotate 360 degrees to determine the position of the maximum emission level. The EUT was positioned such that the distance from antenna to the EUT was 3 meters.

The antenna can move up and down between 1 meter and 4 meters to find out the maximum emission level.

Both horizontal and vertical polarization of the antenna are set on measurement. In order to find the maximum emission, all of the interface cables must be manipulated according to ANSI C63.10:2013 on radiated measurement.

6.5. Test Specification

According to FCC Part 15 Subpart C Paragraph 15.247

6.6. Test Result

Site : CB4-H	Time : 2017/03/16
Limit : FCC_SpartC_15.209_03M_PK	Margin : 6
Probe : CB4-H_FCC_EFS_B432_1-18GHz_3M_1116 - HORIZONTAL	Power : AC 120V/60Hz
EUT : HD 180 Degree Wi-Fi Camera	Note : Mode 1: Transmit (Stand) 2402MHz

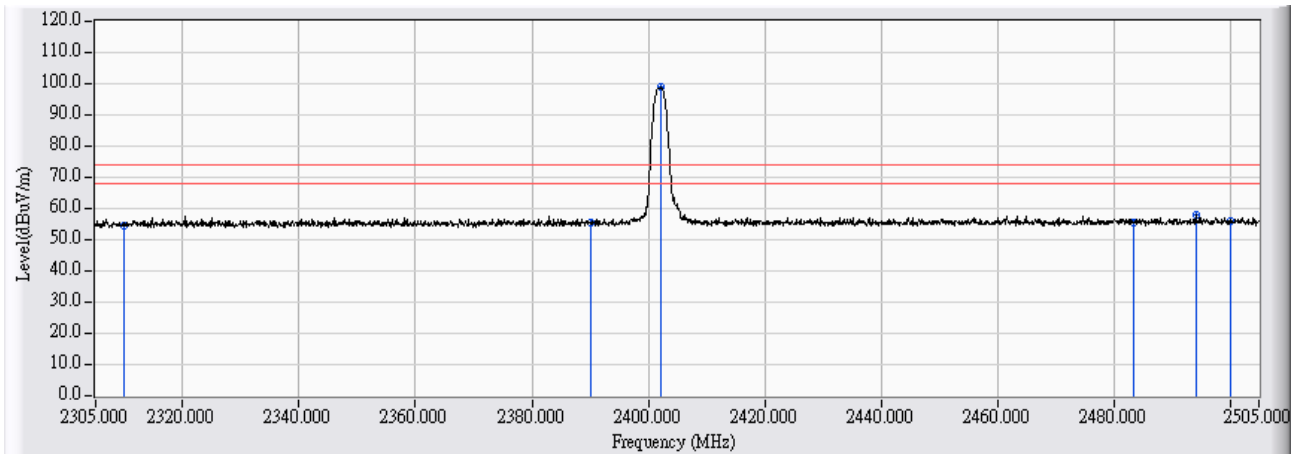

	Frequency (MHz)	Correct Factor (dB)	Reading Level (dBuV)	Measure Level (dBuV/m)	Margin (dB)	Limit (dBuV/m)	Detector Type
1	2310.000	-1.231	55.672	54.441	-19.559	74.000	PEAK
2	2390.000	-0.919	56.496	55.577	-18.423	74.000	PEAK
3	* 2402.200	-0.871	99.660	98.789	24.789	74.000	PEAK
4	2483.500	-0.555	56.284	55.730	-18.270	74.000	PEAK
5	2494.200	-0.513	58.314	57.801	-16.199	74.000	PEAK
6	2500.000	-0.491	56.684	56.193	-17.807	74.000	PEAK

Note:

1. All readings above 1GHz are performed with peak and/or average measurements as necessary.
2. Peak measurements: RBW = 1MHz, VBW = 3 MHz, Sweep: Auto.
3. Average measurements: RBW = 1MHz, VBW = 10 Hz, Sweep: Auto.
4. “ * ”, means this data is the worst emission level.
5. Measurement Level = Reading Level + Correct Factor.
6. The average measurement was not performed when the peak measured data under the limit of average detection. If the readings given are average, peak measurement should also be supplied.

Frequency	Peak	Duty Cycle	Measurement	Margin	Limit
MHz	Measurement	Factor	Level	dB	dBuV/m
	dBuV/m	dB	dBuV/m		
Horizontal					
Average Detector:					
2310.000	54.441	-4.497	49.944	-4.056	54.000
2390.000	55.577	-4.497	51.080	-2.920	54.000
2402.200	98.789	-4.497	94.292	40.292	54.000
2483.500	55.730	-4.497	51.233	-2.767	54.000
2494.200	57.801	-4.497	53.304	-0.696	54.000
2500.000	56.193	-4.497	51.696	-2.304	54.000

Site : CB4-H	Time : 2017/03/16
Limit : FCC_SpartC_15.209_03M_PK	Margin : 6
Probe : CB4-H_FCC_EFS_B432_1-18GHz_3M_1116 - VERTICAL	Power : AC 120V/60Hz
EUT : HD 180 Degree Wi-Fi Camera	Note : Mode 1: Transmit (Stand) 2402MHz

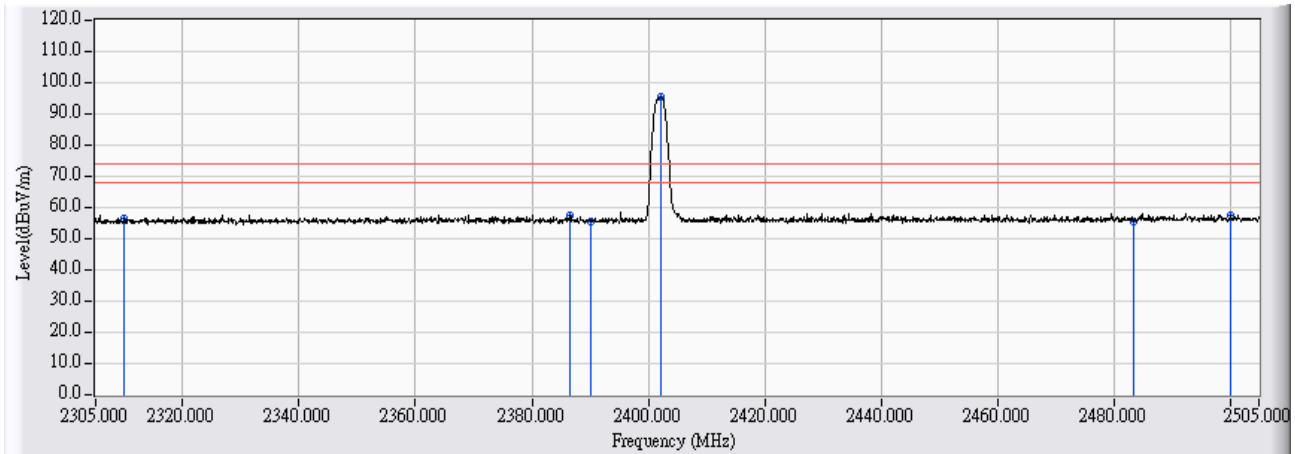

	Frequency (MHz)	Correct Factor (dB)	Reading Level (dBuV)	Measure Level (dBuV/m)	Margin (dB)	Limit (dBuV/m)	Detector Type
1	2310.000	-1.231	57.699	56.468	-17.532	74.000	PEAK
2	2386.500	-0.933	58.330	57.397	-16.603	74.000	PEAK
3	2390.000	-0.919	56.490	55.571	-18.429	74.000	PEAK
4	* 2402.300	-0.870	96.300	95.429	21.429	74.000	PEAK
5	2483.500	-0.555	56.117	55.563	-18.437	74.000	PEAK
6	2500.000	-0.491	57.869	57.378	-16.622	74.000	PEAK

Note:

1. All readings above 1GHz are performed with peak and/or average measurements as necessary.
2. Peak measurements: RBW = 1MHz, VBW = 3 MHz, Sweep: Auto.
3. Average measurements: RBW = 1MHz, VBW = 10 Hz, Sweep: Auto.
4. “ * ”, means this data is the worst emission level.
5. Measurement Level = Reading Level + Correct Factor.
6. The average measurement was not performed when the peak measured data under the limit of average detection. If the readings given are average, peak measurement should also be supplied.

Frequency	Peak	Duty Cycle	Measurement	Margin	Limit
MHz	Measurement	Factor	Level	dB	dBuV/m
	dBuV/m	dB	dBuV/m		
Vertical					
Average Detector:					
2310.000	56.468	-4.497	51.971	-2.029	54.000
2386.500	57.397	-4.497	52.900	-1.100	54.000
2390.000	55.571	-4.497	51.074	-2.926	54.000
2402.300	95.429	-4.497	90.932	36.932	54.000
2483.500	55.563	-4.497	51.066	-2.934	54.000
2500.000	57.378	-4.497	52.881	-1.119	54.000

Site : CB4-H	Time : 2017/03/16
Limit : FCC_SpartC_15.209_03M_PK	Margin : 6
Probe : CB4-H_FCC_EFS_B432_1-18GHz_3M_1116 - HORIZONTAL	Power : AC 120V/60Hz
EUT : HD 180 Degree Wi-Fi Camera	Note : Mode 1: Transmit (Stand) 2440MHz

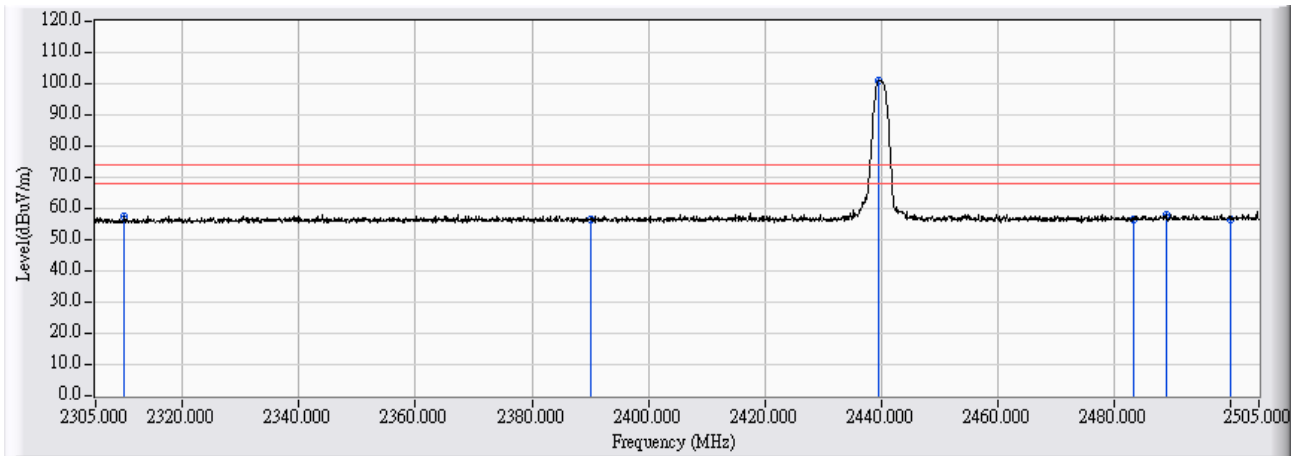

	Frequency (MHz)	Correct Factor (dB)	Reading Level (dBuV)	Measure Level (dBuV/m)	Margin (dB)	Limit (dBuV/m)	Detector Type
1	2310.000	-1.231	58.603	57.372	-16.628	74.000	PEAK
2	2390.000	-0.919	57.503	56.584	-17.416	74.000	PEAK
3	* 2439.700	-0.725	101.827	101.102	27.102	74.000	PEAK
4	2483.500	-0.555	57.257	56.703	-17.297	74.000	PEAK
5	2489.000	-0.532	58.427	57.894	-16.106	74.000	PEAK
6	2500.000	-0.491	56.976	56.485	-17.515	74.000	PEAK

Note:

1. All readings above 1GHz are performed with peak and/or average measurements as necessary.
2. Peak measurements: RBW = 1MHz, VBW = 3 MHz, Sweep: Auto.
3. Average measurements: RBW = 1MHz, VBW = 10 Hz, Sweep: Auto.
4. “ * ”, means this data is the worst emission level.
5. Measurement Level = Reading Level + Correct Factor.
6. The average measurement was not performed when the peak measured data under the limit of average detection. If the readings given are average, peak measurement should also be supplied.

Frequency	Peak	Duty Cycle	Measurement	Margin	Limit
MHz	Measurement	Factor	Level	dB	dBuV/m
	dBuV/m	dB	dBuV/m		
Horizontal					
Average Detector:					
2310.000	57.372	-4.497	52.875	-1.125	54.000
2390.000	56.584	-4.497	52.087	-1.913	54.000
2439.700	101.102	-4.497	96.605	42.605	54.000
2483.500	56.703	-4.497	52.206	-1.794	54.000
2489.000	57.894	-4.497	53.397	-0.603	54.000
2500.000	56.485	-4.497	51.988	-2.012	54.000

Site : CB4-H	Time : 2017/03/16
Limit : FCC_SpartC_15.209_03M_PK	Margin : 6
Probe : CB4-H_FCC_EFS_B432_1-18GHz_3M_1116 - VERTICAL	Power : AC 120V/60Hz
EUT : HD 180 Degree Wi-Fi Camera	Note : Mode 1: Transmit (Stand) 2440MHz

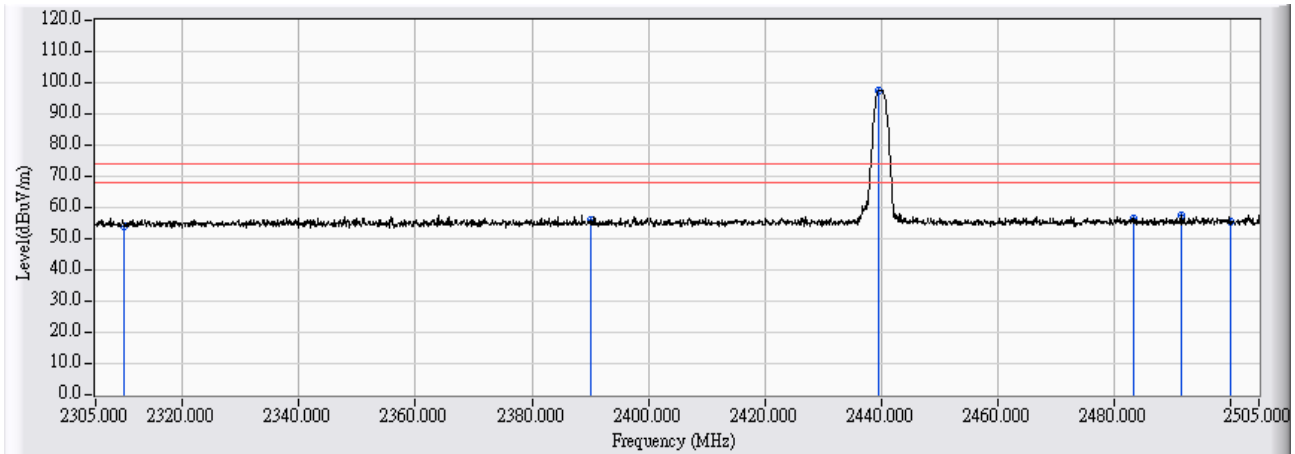

	Frequency (MHz)	Correct Factor (dB)	Reading Level (dBuV)	Measure Level (dBuV/m)	Margin (dB)	Limit (dBuV/m)	Detector Type
1	2310.000	-1.231	55.448	54.217	-19.783	74.000	PEAK
2	2390.000	-0.919	56.874	55.955	-18.045	74.000	PEAK
3	* 2439.700	-0.725	98.433	97.708	23.708	74.000	PEAK
4	2483.500	-0.555	56.844	56.290	-17.710	74.000	PEAK
5	2491.700	-0.523	57.991	57.469	-16.531	74.000	PEAK
6	2500.000	-0.491	56.121	55.630	-18.370	74.000	PEAK

Note:

1. All readings above 1GHz are performed with peak and/or average measurements as necessary.
2. Peak measurements: RBW = 1MHz, VBW = 3 MHz, Sweep: Auto.
3. Average measurements: RBW = 1MHz, VBW = 10 Hz, Sweep: Auto.
4. “ * ”, means this data is the worst emission level.
5. Measurement Level = Reading Level + Correct Factor.
6. The average measurement was not performed when the peak measured data under the limit of average detection. If the readings given are average, peak measurement should also be supplied.

Frequency	Peak	Duty Cycle	Measurement	Margin	Limit
MHz	Measurement	Factor	Level	dB	dBuV/m
	dBuV/m	dB	dBuV/m		
Vertical					
Average Detector:					
2310.000	54.217	-4.497	49.720	-4.280	54.000
2390.000	55.955	-4.497	51.458	-2.542	54.000
2439.700	97.708	-4.497	93.211	39.211	54.000
2483.500	56.290	-4.497	51.793	-2.207	54.000
2491.700	57.469	-4.497	52.972	-1.028	54.000
2500.000	55.630	-4.497	51.133	-2.867	54.000

Site : CB4-H	Time : 2017/03/16
Limit : FCC_SpartC_15.209_03M_PK	Margin : 6
Probe : CB4-H_FCC_EFS_B432_1-18GHz_3M_1116 - HORIZONTAL	Power : AC 120V/60Hz
EUT : HD 180 Degree Wi-Fi Camera	Note : Mode 1: Transmit (Stand) 2480MHz

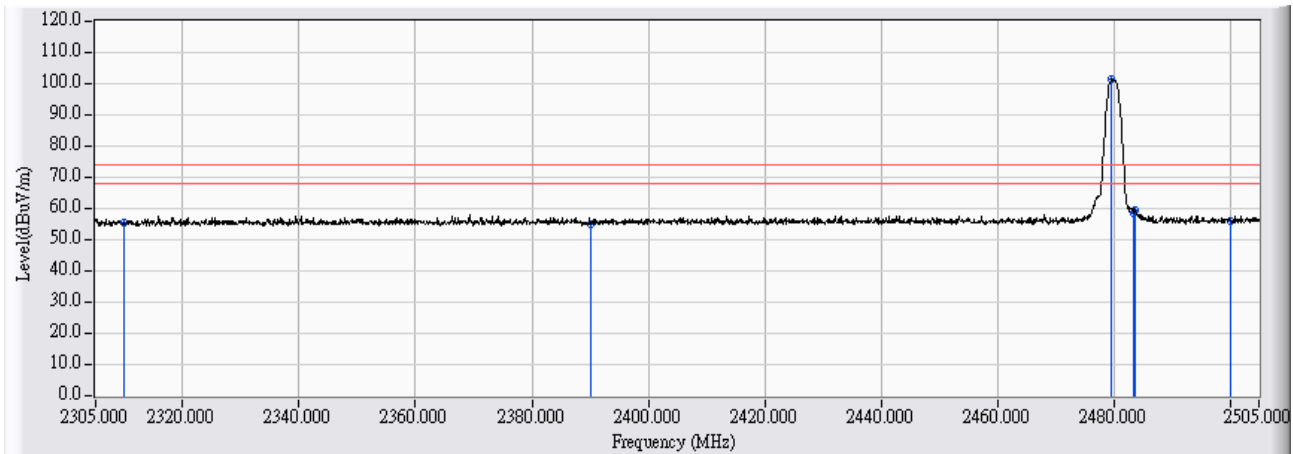

	Frequency (MHz)	Correct Factor (dB)	Reading Level (dBuV)	Measure Level (dBuV/m)	Margin (dB)	Limit (dBuV/m)	Detector Type
1	2310.000	-1.231	56.721	55.490	-18.510	74.000	PEAK
2	2390.000	-0.919	56.016	55.097	-18.903	74.000	PEAK
3	* 2479.700	-0.569	101.897	101.328	27.328	74.000	PEAK
4	2483.500	-0.555	59.200	58.646	-15.354	74.000	PEAK
5	2483.600	-0.554	59.990	59.436	-14.564	74.000	PEAK
6	2500.000	-0.491	56.491	56.000	-18.000	74.000	PEAK

Note:

1. All readings above 1GHz are performed with peak and/or average measurements as necessary.
2. Peak measurements: RBW = 1MHz, VBW = 3 MHz, Sweep: Auto.
3. Average measurements: RBW = 1MHz, VBW = 10 Hz, Sweep: Auto.
4. “ * ”, means this data is the worst emission level.
5. Measurement Level = Reading Level + Correct Factor.
6. The average measurement was not performed when the peak measured data under the limit of average detection. If the readings given are average, peak measurement should also be supplied.

Frequency	Peak	Duty Cycle	Measurement	Margin	Limit
MHz	Measurement	Factor	Level	dB	dBuV/m
	dBuV/m	dB	dBuV/m		
Horizontal					
Average Detector:					
2310.000	55.490	-4.497	50.993	-3.007	54.000
2390.000	55.097	-4.497	50.600	-3.400	54.000
2479.700	101.328	-4.497	96.831	42.831	54.000
2483.500	58.141	-4.497	53.644	-0.356	54.000
2483.600	58.214	-4.497	53.717	-0.283	54.000
2500.000	56.000	-4.497	51.503	-2.497	54.000

Site : CB4-H	Time : 2017/03/16
Limit : FCC_SpartC_15.209_03M_PK	Margin : 6
Probe : CB4-H_FCC_EFS_B432_1-18GHz_3M_1116 - VERTICAL	Power : AC 120V/60Hz
EUT : HD 180 Degree Wi-Fi Camera	Note : Mode 1: Transmit (Stand) 2480MHz

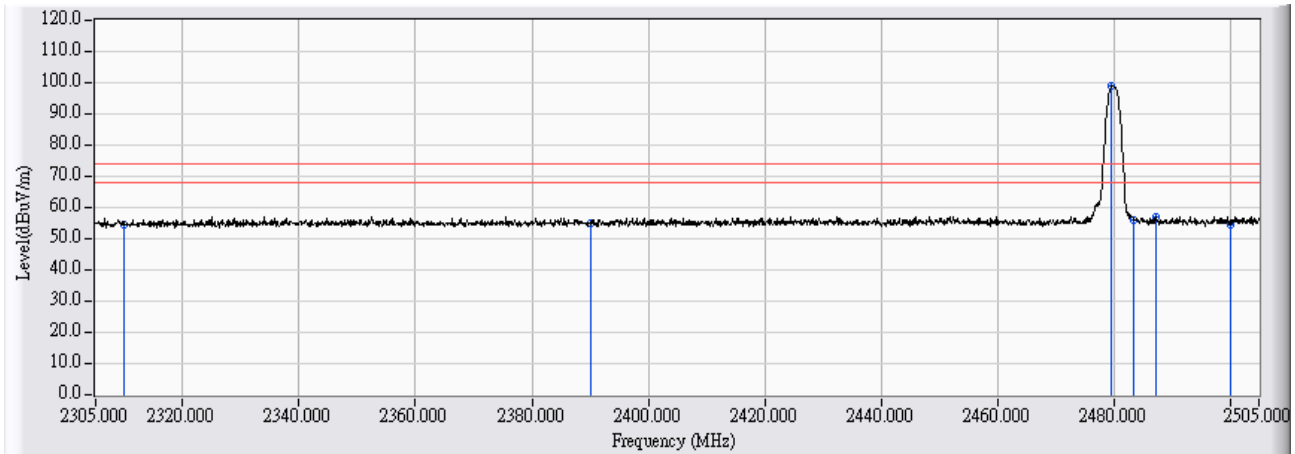

	Frequency (MHz)	Correct Factor (dB)	Reading Level (dBuV)	Measure Level (dBuV/m)	Margin (dB)	Limit (dBuV/m)	Detector Type
1	2310.000	-1.231	55.833	54.602	-19.398	74.000	PEAK
2	2390.000	-0.919	55.827	54.908	-19.092	74.000	PEAK
3	* 2479.700	-0.569	99.458	98.889	24.889	74.000	PEAK
4	2483.500	-0.555	56.574	56.020	-17.980	74.000	PEAK
5	2487.200	-0.541	57.491	56.951	-17.049	74.000	PEAK
6	2500.000	-0.491	54.899	54.408	-19.592	74.000	PEAK

Note:

1. All readings above 1GHz are performed with peak and/or average measurements as necessary.
2. Peak measurements: RBW = 1MHz, VBW = 3 MHz, Sweep: Auto.
3. Average measurements: RBW = 1MHz, VBW = 10 Hz, Sweep: Auto.
4. “ * ”, means this data is the worst emission level.
5. Measurement Level = Reading Level + Correct Factor.
6. The average measurement was not performed when the peak measured data under the limit of average detection. If the readings given are average, peak measurement should also be supplied.

Frequency	Peak	Duty Cycle	Measurement	Margin	Limit
MHz	Measurement	Factor	Level	dB	dBuV/m
	dBuV/m	dB	dBuV/m		
Vertical					
Average Detector:					
2310.000	54.602	-4.497	50.105	-3.895	54.000
2390.000	54.908	-4.497	50.411	-3.589	54.000
2479.700	98.889	-4.497	94.392	40.392	54.000
2483.500	56.020	-4.497	51.523	-2.477	54.000
2487.200	56.951	-4.497	52.454	-1.546	54.000
2500.000	54.408	-4.497	49.911	-4.089	54.000

7. DTS Bandwidth

7.1. Test Equipment

The following test equipment is used during the test:

DTS Bandwidth / SR10-H

Instrument	Manufacturer	Model No.	Serial No	Next Cal. Date
Spectrum Analyzer	Agilent	N9010A	US47140172	2017/08/08

Note: All equipments that need to calibrate are with calibration period of 1 year.

7.2. Test Setup

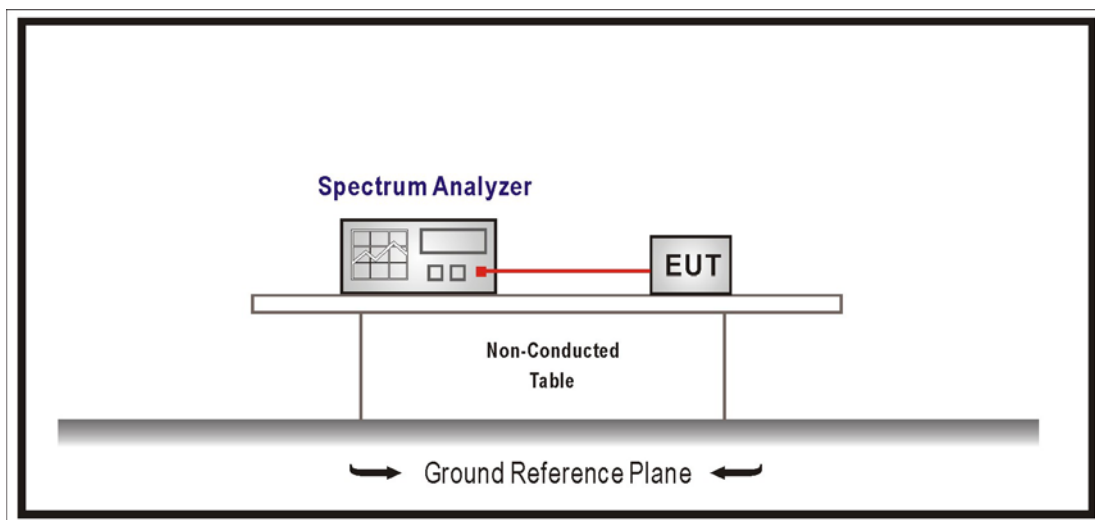

7.3. Limits

The 6 dB bandwidth must be greater than 500 kHz.

7.4. Test Procedures

The EUT was setup according to ANSI C63.10:2013; tested according to DTS test procedure of KDB558074 V03R02 for compliance to FCC 47CFR 15.247 requirements.

Set RBW = 1% of EBW, Span greater than RBW.

7.5. Test Specification

According to FCC Part 15 Subpart C Paragraph 15.247

7.6. Test Result

Product	HD 180 Degree Wi-Fi Camera		
Test Item	DTS Bandwidth		
Test Mode	Mode 1: Transmit (Stand)		
Date of Test	2017/03/01	Test Site	SR10-H

GFSK

Channel No.	Frequency (MHz)	Measure Level (KHz)	Limit (MHz)	Result
00	2402	0.700	≥ 0.5	Pass
19	2440	0.700	≥ 0.5	Pass
39	2480	0.697	≥ 0.5	Pass

Channel 00

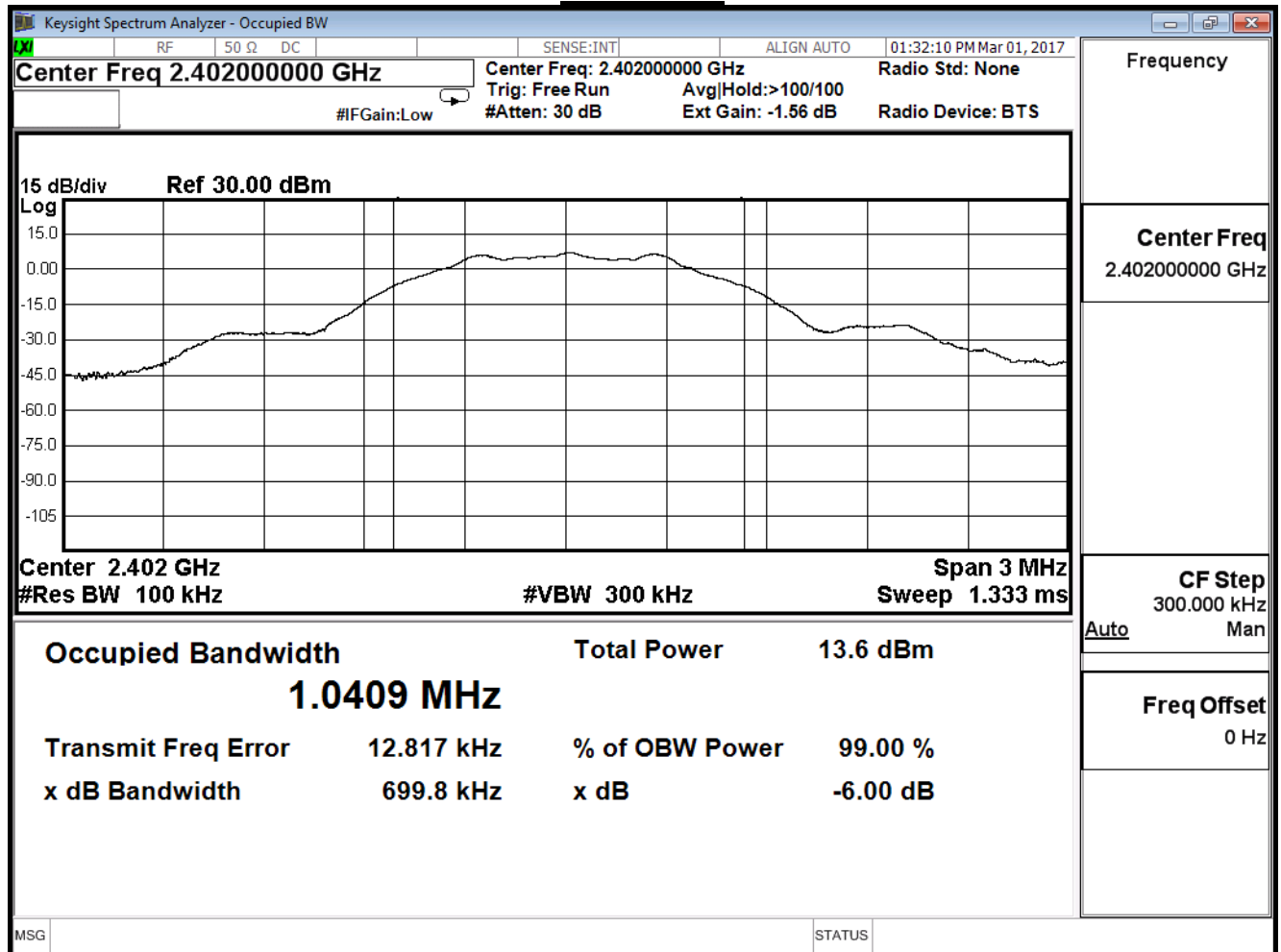

Channel 19

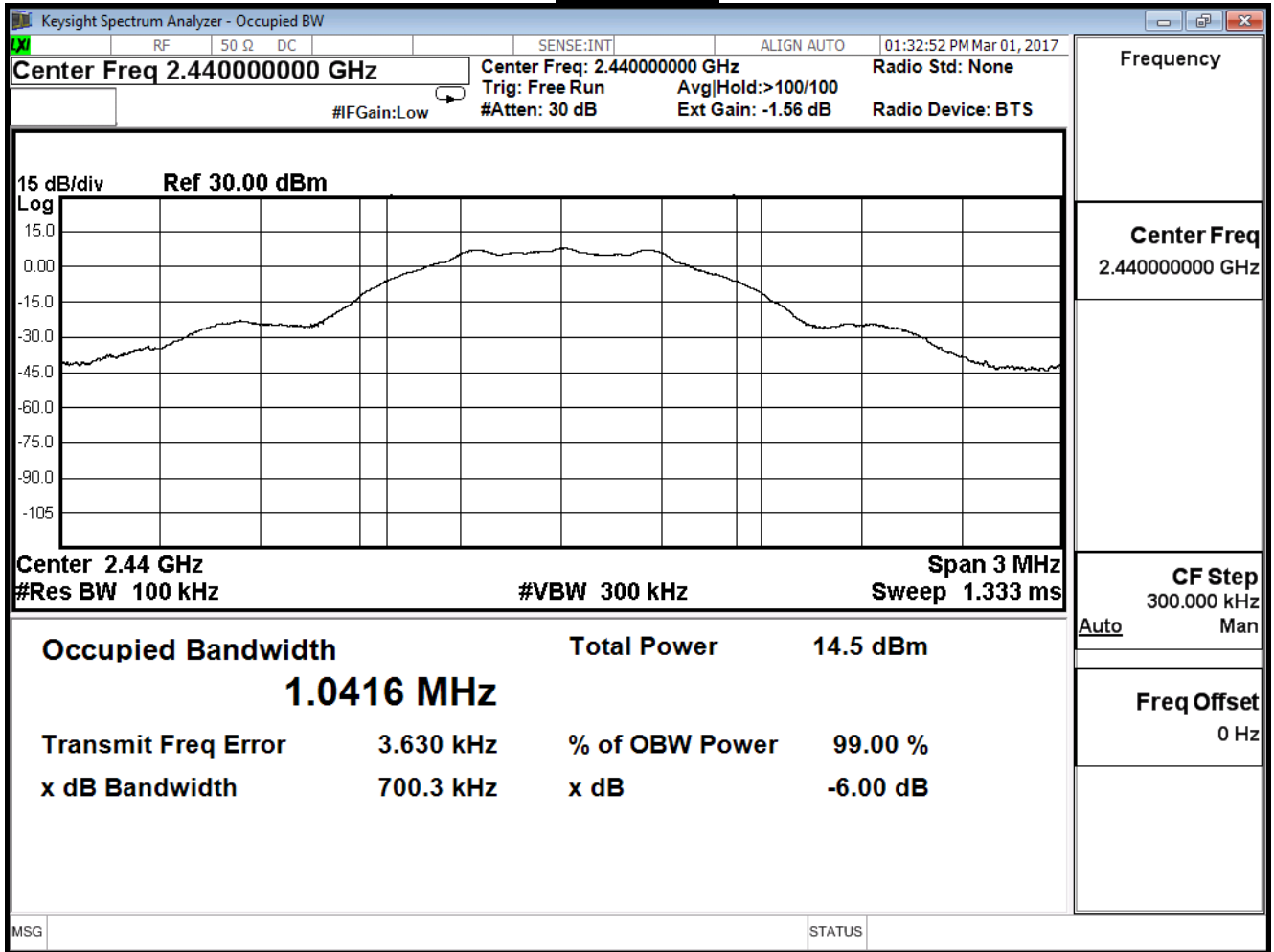

Channel 39

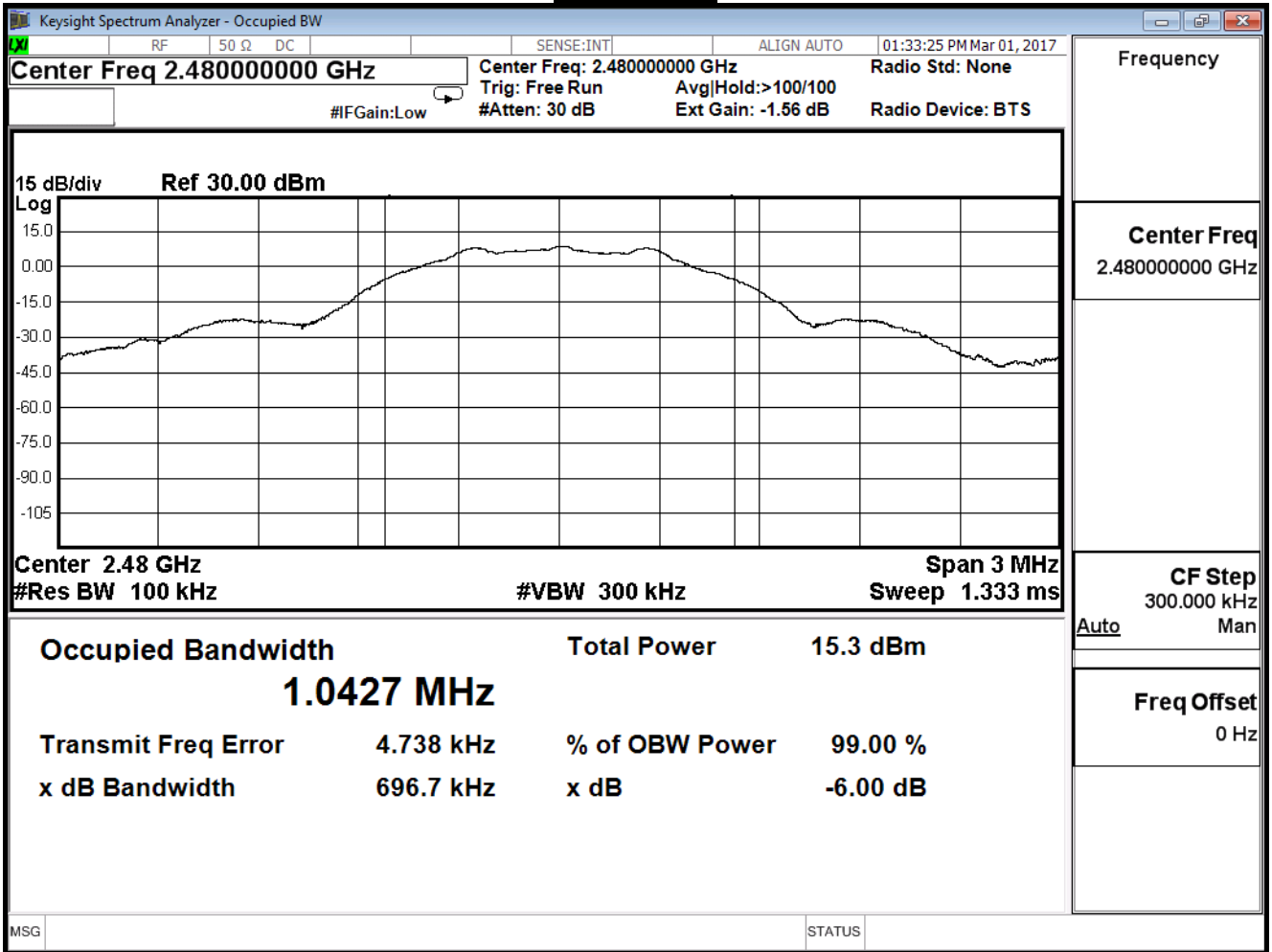

8. Power Density

8.1. Test Equipment

The following test equipment is used during the test:

Power Density / SR10-H

Instrument	Manufacturer	Model No.	Serial No	Next Cal. Date
Spectrum Analyzer	Agilent	N9010A	US47140172	2017/08/08

Note: All equipments that need to calibrate are with calibration period of 1 year.

8.2. Test Setup

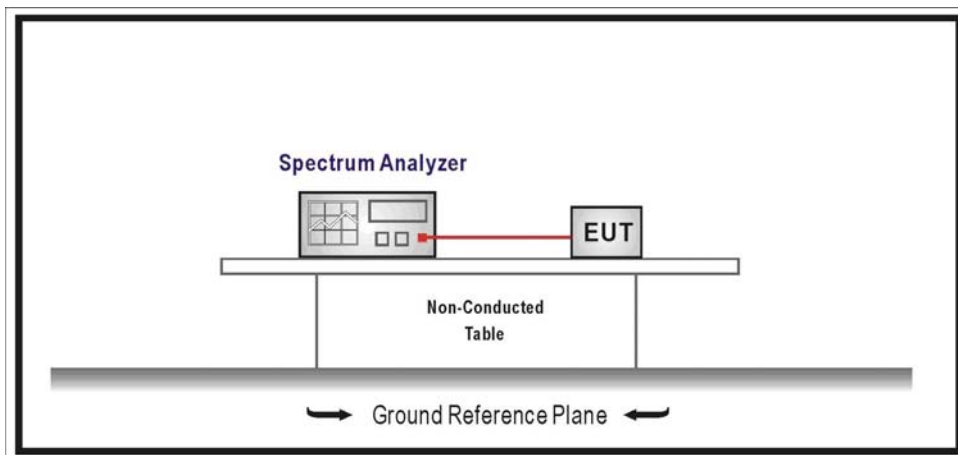

8.3. Limits

The peak power spectral density conducted from the intentional radiated to the antenna shall not be greater than +8dBm in any 3kHz band during any time interval of continuous transmission.

8.4. Test Procedures

The EUT was setup according to ANSI C63.10:2013; tested according to DTS test procedure of KDB558074 V03R02 for compliance to FCC 47CFR 15.247 requirements.

8.5. Test Specification

According to FCC Part 15 Subpart C Paragraph 15.247

8.6. Uncertainty

The measurement uncertainty is defined as $\pm 1.27\text{dB}$.

8.7. Test Result

Product	HD 180 Degree Wi-Fi Camera		
Test Item	Power Density		
Test Mode	Mode 1: Transmit (Stand)		
Date of Test	2017/03/01	Test Site	SR10-H

Channel No.	Frequency (MHz)	Measure Level(dBm)	Limit (dBm)	Result
00	2402	-2.727	≤ 8	Pass
19	2440	-1.621	≤ 8	Pass
39	2480	-0.800	≤ 8	Pass

Channel 00

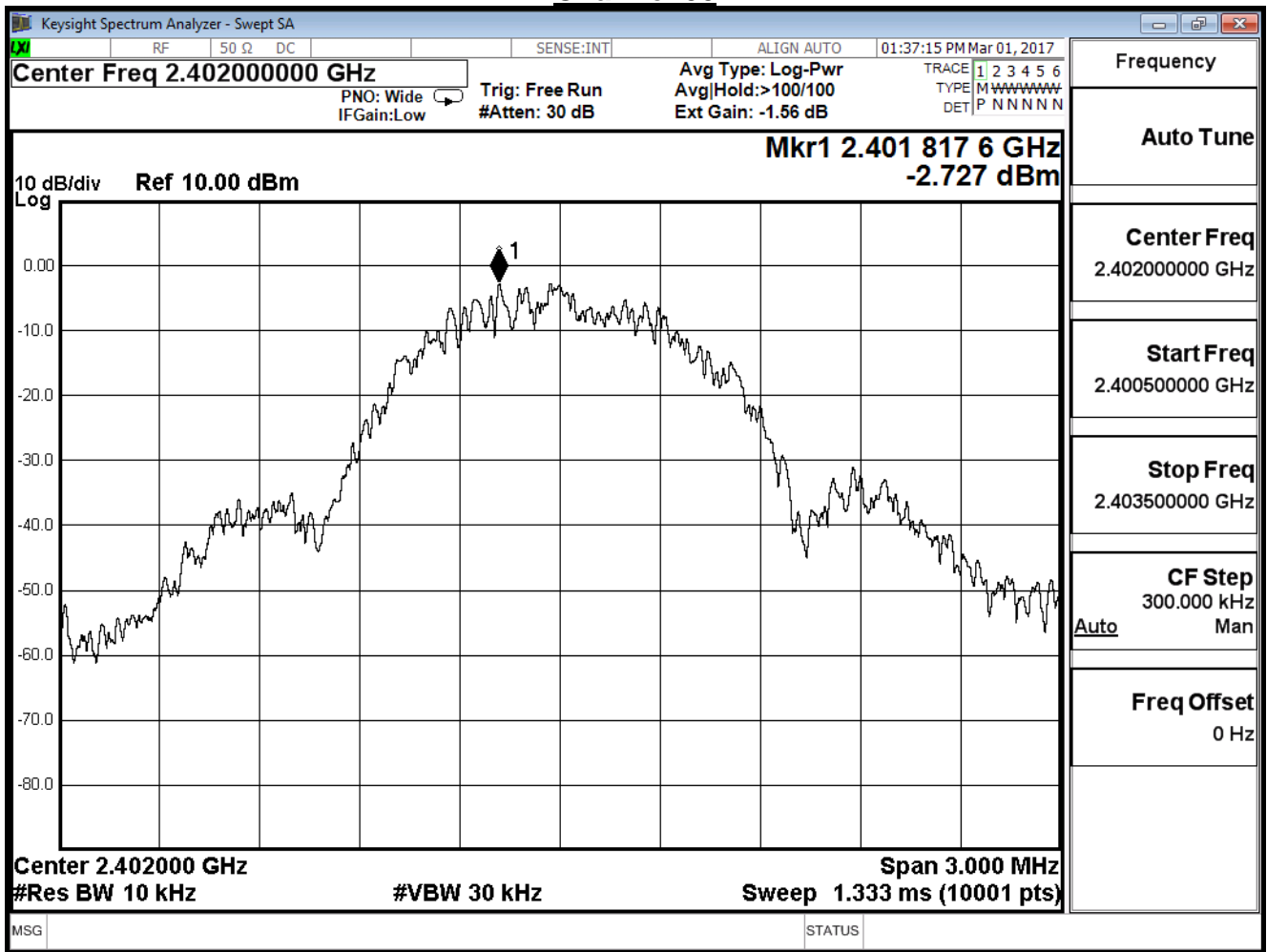

Channel 19

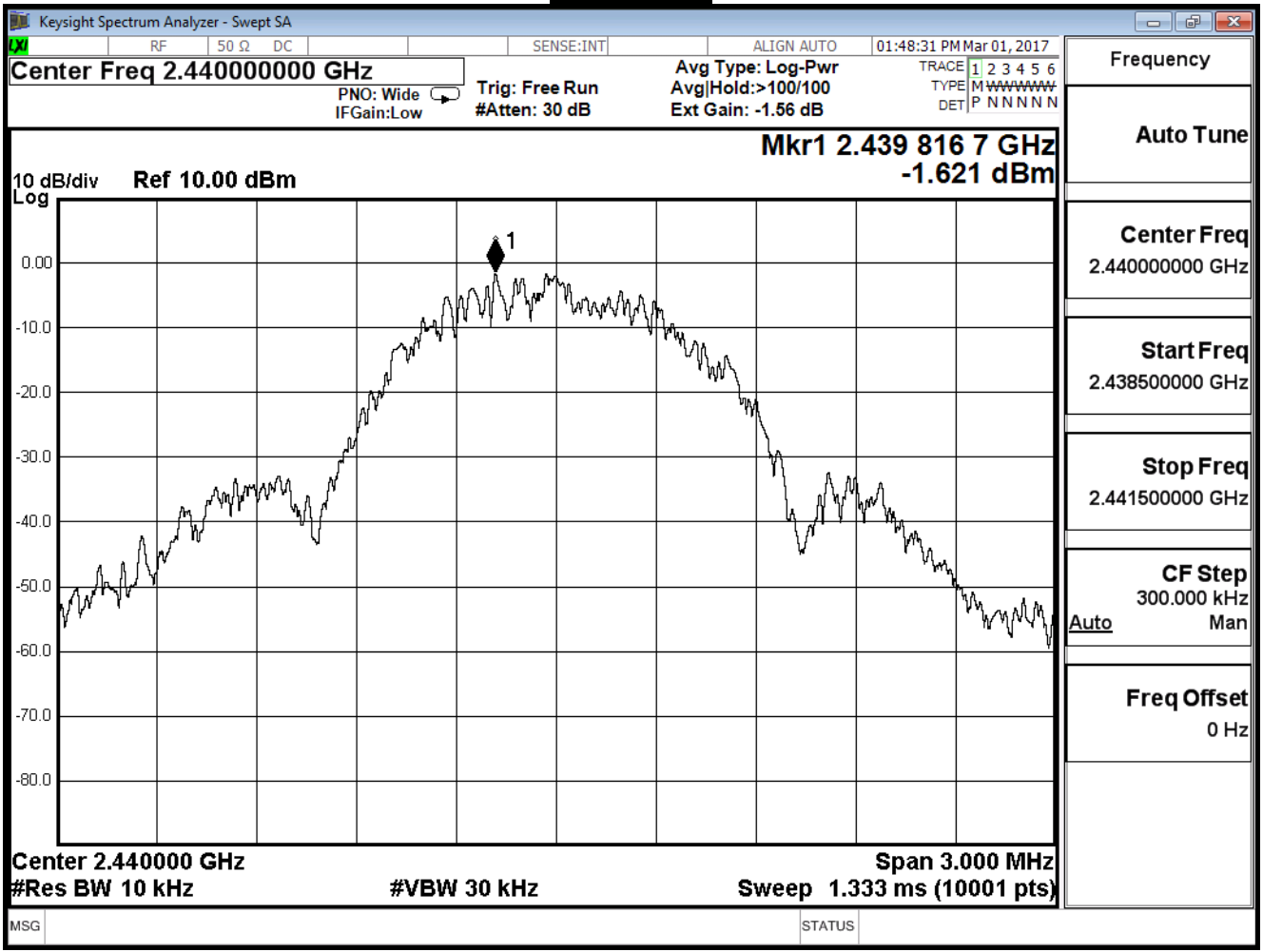

Channel 39

