



FCC 47 CFR PART 15 SUBPART C

TEST REPORT

For

HD Wireless N Outdoor Cloud Camera

Model: DCS-2330L

Trade Name: D-Link

Issued to

**D-Link Corporation
17595 Mt. Herrmann, Fountain Valley, California 92708, United States**

Issued by

**Compliance Certification Services Inc.
No.81-1, Lane 210, Bade 2nd Rd., Lujhu Township,
Taoyuan County 33841, Taiwan, R.O.C.
TEL: 886-3-324-0332
FAX: 886-3-324-5235
<http://www.ccsrf.com>
service@ccsrf.com**



Note: *This report shall not be reproduced except in full, without the written approval of Compliance Certification Services Inc. This document may be altered or revised by Compliance Certification Services Inc. personnel only, and shall be noted in the revision section of the document. The client should not use it to claim product endorsement by TAF, A2LA, NIST or any government agencies. The test results in the report only apply to the tested sample.*



Revision History

Rev.	Issue Date	Revisions	Effect Page	Revised By
00	December 26, 2013	Initial Issue	All	Landy Huang



TABLE OF CONTENTS

1	TEST RESULT CERTIFICATION	4
2	EUT DESCRIPTION	5
3	TEST METHODOLOGY	6
3.1	EUT CONFIGURATION	6
3.2	EUT EXERCISE	6
3.3	GENERAL TEST PROCEDURES	6
3.4	FCC PART 15.205 RESTRICTED BANDS OF OPERATIONS	7
3.5	DESCRIPTION OF TEST MODES.....	8
4	INSTRUMENT CALIBRATION	9
4.1	MEASURING INSTRUMENT CALIBRATION.....	9
4.2	MEASUREMENT EQUIPMENT USED	9
4.3	MEASUREMENT UNCERTAINTY	10
5	FACILITIES AND ACCREDITATIONS	11
5.1	FACILITIES.....	11
5.2	LABORATORY ACCREDITATIONS AND LISTING	11
5.3	TABLE OF ACCREDITATIONS AND LISTINGS.....	12
6	SETUP OF EQUIPMENT UNDER TEST	13
6.1	SETUP CONFIGURATION OF EUT.....	13
6.2	SUPPORT EQUIPMENT	13
7	FCC PART 15 REQUIREMENTS	14
7.1	6DB BANDWIDTH.....	14
7.2	PEAK POWER	22
7.3	AVERAGE POWER.....	24
7.4	BAND EDGES MEASUREMENT	26
7.5	PEAK POWER SPECTRAL DENSITY	50
7.6	SPURIOUS EMISSIONS.....	58
7.7	POWERLINE CONDUCTED EMISSIONS	83
8	APPENDIX I PHOTOGRAPHS OF TEST SETUP	88
9	APPENDIX II: PHOTOGRAPHS OF EUT	94



1 TEST RESULT CERTIFICATION

Applicant: **D-Link Corporation**
17595 Mt. Herrmann, Fountain Valley, California 92708, United States

Manufacturer: **APPRO Technology Inc.**
13F, No. 66, Zhongzheng Rd., Xinzhuang Dist., New Taipei City, Taiwan.

Equipment Under Test: HD Wireless N Outdoor Cloud Camera

Trade Name: D-Link

Model: DCS-2330L

Date of Test: December 17 ~ 23, 2013

APPLICABLE STANDARDS	
STANDARD	TEST RESULT
FCC 47 CFR Part 15 Subpart C	No non-compliance noted

We hereby certify that:

Compliance Certification Services Inc. tested the above equipment in accordance with the requirements set forth in the above standards. The test results show that the equipment tested is capable of demonstrating compliance with the requirements as documented in this report.

The test results of this report relate only to the tested sample identified in this report.

Approved by:

Reviewed by:



 Stan Lin
 Section Manager

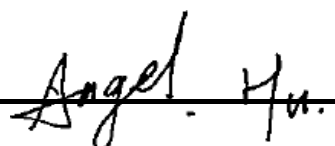

 Angel Hu
 Section Manager



2 EUT DESCRIPTION

Product	HD Wireless N Outdoor Cloud Camera		
Trade Name	D-Link		
Model Number	DCS-2330L		
Model Discrepancy	N/A		
EUT Power Rating	5VDC, 1.2A		
Received Date	December 6, 2013		
Power Adapter	D-Link	Model	AMS1-0501200FU
Power Adapter Power Rating	I/P: 100-240VAC, 50/60HZ, 0.2A O/P: 5VDC, 1.2A		
RF Module Manufacturer	Realtek	Model	RTL8188EUS
Frequency Range	IEEE 802.11b/g/ IEEE 802.11n HT20: 2412~2462MHz IEEE 802.11n HT40: 2422~2452MHz		
Transmit Power	IEEE 802.11b mode: 18.78 dBm (0.0755W) IEEE 802.11g mode: 23.02 dBm 0.2004W) IEEE 802.11n HT20 mode: 22.31 dBm (0.1702W) IEEE 802.11n HT40 mode: 21.50 dBm (0.1413W)		
Modulation Technique & Transmit Data Rate	IEEE 802.11b mode: DSSS (11, 5.5, 2, 1 Mbps) IEEE 802.11g mode: OFDM (54, 48, 36, 24, 18, 12, 11, 9, 6 Mbps) IEEE 802.11n HT20 mode: OFDM (130, 117, 104, 78, 65, 58.5, 52, 39, 26, 19.5, 13, 6.5 Mbps) IEEE 802.11n HT40 mode: OFDM (270, 243, 216, 162, 135, 121.5, 108, 81, 54, 40.5, 27, 13.5 Mbps)		
Number of Channels	IEEE 802.11b/g mode: 11 Channels IEEE 802.11n HT20 mode: 11 Channels IEEE 802.11n HT40 mode: 7 Channels		
Antenna Specification	Dipole Antenna / Gain: 2.7 dBi		

Remark:

1. The sample selected for test was production product and was provided by manufacturer.
2. This submittal(s) (test report) is intended for FCC ID: **KA2CS2330LA1** filing to comply with Section 15.207, 15.209 and 15.247 of the FCC Part 15, Subpart C Rules.
3. This report is compliance with the 558074 D01 DTS Meas Guidance v03r01 Requirement.



3 TEST METHODOLOGY

The tests documented in this report were performed in accordance with ANSI C63.4: 2009 and FCC CFR 47 Part 15.207, 15.209, 15.247.

3.1 EUT CONFIGURATION

The EUT configuration for testing is installed on RF field strength measurement to meet the Commissions requirement and operating in a manner that intends to maximize its emission characteristics in a continuous normal application.

3.2 EUT EXERCISE

The EUT was operated in the engineering mode to fix the TX frequency that was for the purpose of the measurements.

According to its specifications, the EUT must comply with the requirements of the Section 15.207, 15.209 and 15.247 under the FCC Rules Part 15 Subpart C.

3.3 GENERAL TEST PROCEDURES

Conducted Emissions

The EUT is placed on the turntable, which is 0.8 m above ground plane. According to the requirements in Section 13.1.4.1 of ANSI C63.4 Conducted emissions from the EUT measured in the frequency range between 0.15 MHz and 30MHz using CISPR Quasi-peak and average detector modes.

Radiated Emissions

The EUT is placed on a turn table, which is 0.8 m above ground plane. The turntable shall rotate 360 degrees to determine the position of maximum emission level. EUT is set 3m away from the receiving antenna, which varied from 1m to 4m to find out the highest emission. And also, each emission was to be maximized by changing the polarization of receiving antenna both horizontal and vertical. In order to find out the maximum emissions, exploratory radiated emission measurements were made according to the requirements in Section 13.1.4.1 of ANSI C63.4.



3.4 FCC PART 15.205 RESTRICTED BANDS OF OPERATIONS

(a) Except as shown in paragraph (d) of this section, only spurious emissions are permitted in any of the frequency bands listed below:

MHz	MHz	MHz	GHz
0.090 - 0.110	16.42 - 16.423	399.9 - 410	4.5 - 5.15
¹ 0.495 - 0.505	16.69475 - 16.69525	608 - 614	5.35 - 5.46
2.1735 - 2.1905	16.80425 - 16.80475	960 - 1240	7.25 - 7.75
4.125 - 4.128	25.5 - 25.67	1300 - 1427	8.025 - 8.5
4.17725 - 4.17775	37.5 - 38.25	1435 - 1626.5	9.0 - 9.2
4.20725 - 4.20775	73 - 74.6	1645.5 - 1646.5	9.3 - 9.5
6.215 - 6.218	74.8 - 75.2	1660 - 1710	10.6 - 12.7
6.26775 - 6.26825	108 - 121.94	1718.8 - 1722.2	13.25 - 13.4
6.31175 - 6.31225	123 - 138	2200 - 2300	14.47 - 14.5
8.291 - 8.294	149.9 - 150.05	2310 - 2390	15.35 - 16.2
8.362 - 8.366	156.52475 -	2483.5 - 2500	17.7 - 21.4
8.37625 - 8.38675	156.52525	2655 - 2900	22.01 - 23.12
8.41425 - 8.41475	156.7 - 156.9	3260 - 3267	23.6 - 24.0
12.29 - 12.293	162.0125 - 167.17	3332 - 3339	31.2 - 31.8
12.51975 - 12.52025	167.72 - 173.2	3345.8 - 3358	36.43 - 36.5
12.57675 - 12.57725	240 - 285	3600 - 4400	(²)
13.36 - 13.41	322 - 335.4		

¹ Until February 1, 1999, this restricted band shall be 0.490-0.510 MHz.

² Above 38.6

(b) Except as provided in paragraphs (d) and (e), the field strength of emissions appearing within these frequency bands shall not exceed the limits shown in Section 15.209. At frequencies equal to or less than 1000 MHz, compliance with the limits in Section 15.209 shall be demonstrated using measurement instrumentation employing a CISPR quasi-peak detector. Above 1000 MHz, compliance with the emission limits in Section 15.209 shall be demonstrated based on the average value of the measured emissions. The provisions in Section 15.35 apply to these measurements.



3.5 DESCRIPTION OF TEST MODES

The EUT (model: DCS-2330L) had been tested under operating condition.

Software used to control the EUT for staying in continuous transmitting and receiving mode was programmed.

The worst case data rate is determined as the data rate with highest output power.

After verification, all tests carried out are with the worst-case test modes as shown below except radiated spurious emission below 1GHz and power line conducted emissions, which worst case was in LAN mode and Wifi mode and receiving radiated spurious emission above 1GHz, which worst case was in CH Mid mode only.

The field strength of spurious emission was measured in the following position: EUT stand-up position (Y axis), lie-down position (X, Z axis). The worst emission was found in lie-down position (Y axis) and the worst case was recorded.

IEEE 802.11b mode:

Channel Low (2412MHz), Channel Mid (2437MHz) and Channel High (2462MHz) with 1Mbps data rate was chosen for full testing.

IEEE 802.11g mode:

Channel Low (2412MHz), Channel Mid (2437MHz) and Channel High (2462MHz) with 6Mbps data rate was chosen for full testing.

IEEE 802.11n HT20 mode:

Channel Low (2412MHz), Channel Mid (2437MHz) and Channel High (2462MHz) with 6.5Mbps data rate were chosen for full testing.

IEEE 802.11n HT40 mode:

Channel Low (2422MHz), Channel Mid (2437MHz) and Channel High (2452MHz) with 13.5Mbps data rate were chosen for full testing.



4 INSTRUMENT CALIBRATION

4.1 MEASURING INSTRUMENT CALIBRATION

The measuring equipment, which was utilized in performing the tests documented herein, has been calibrated in accordance with the manufacturer's recommendations for utilizing calibration equipment, which is traceable to recognized national standards.

4.2 MEASUREMENT EQUIPMENT USED

Equipment Used for Emissions Measurement

Conducted Emissions Test Site				
Name of Equipment	Manufacturer	Model	Serial Number	Calibration Due
Spectrum Analyzer	Agilent	E4446A	MY48250064	01/13/2014
Spectrum Analyzer	Agilent	N9010A	MY52220817	02/22/2014
Power meter	Anritsu	ML2495A	1033009	09/29/2014
Power Sensor	Anritsu	MA2411B	0917221	09/29/2014

3M Semi Anechoic Chamber				
Name of Equipment	Manufacturer	Model	Serial Number	Calibration Due
Spectrum Analyzer	Agilent	E4446A	MY48250064	01/13/2014
Pre-Amplifier	HP	8447D	2944A06530	04/23/2014
Pre-Amplifier	EMEC	EM01M26G	060570	07/25/2014
Pre-Amplifier	MITEQ	AMF-6F-26040 0-40-8P	985646	08/08/2014
Pre-Amplifier	Agilent	8449B	3008A01738	04/23/2014
EMI Test Receiver	SCHAFFNER	SCR 3501	430	03/24/2014
Loop Antenna	EMCO	6502	2356	06/12/2014
Bilog Antenna	TESEQ	CBL 6112D	35378	09/11/2014
Horn Antenna	EMCO	3115	00022250	08/04/2014
Horn Antenna	EMCO	3116	00026370	01/07/2014
Antenna Tower	CCS	CC-A-1F	N/A	N.C.R
Turn Table	CCS	CC-T-1F	N/A	N.C.R
Test S/W	EZ-EMC			

NOTE: 1. The calibration interval of the above test instruments is 12 months and the calibrations are traceable to NML/ROC and NIST/USA.
 2. N.C.R = No Calibration Request.



Powerline Conducted Emissions Test Site #4				
Name of Equipment	Manufacturer	Model	Serial Number	Calibration Due
EMI Test Receiver	R&S	ESCI	100782	06/14/2014
LISN	R&S	ENV216	100066	09/01/2014
LISN	R&S	ENV 4200	830326/016	05/30/2014
ISN	FCC	FCC-TLISN-T2-02	20587	08/01/2014
ISN	TESEQ	ISN-T8	30843	08/16/2014
Current Probe	FCC	F-35	506	07/19/2014
ISN	TESEQ	ISN ST08	27907	09/30/2014
Test S/W	EZ-EMC			

NOTE: 1. The calibration interval of the above test instruments is 12 months and the calibrations are traceable to NML/ROC and NIST/USA.
 2. N.C.R = No Calibration Request.

4.3 MEASUREMENT UNCERTAINTY

Parameter	Uncertainty
Powerline Conducted Emission	±0.9203
3M Semi Anechoic Chamber / 30MHz ~ 200MHz	±3.5921
3M Semi Anechoic Chamber / 200MHz ~ 1GHz	±3.5657
3M Semi Anechoic Chamber / 1 ~ 8GHz	±2.5873
3M Semi Anechoic Chamber / 8 ~ 18GHz	±2.6646
3M Semi Anechoic Chamber / 18 ~ 26GHz	±2.9617
3M Semi Anechoic Chamber / 26 ~ 40GHz	±3.4250

Remark: This uncertainty represents an expanded uncertainty expressed at approximately the 95% confidence level using a coverage factor of k=2.



5 FACILITIES AND ACCREDITATIONS

5.1 FACILITIES

All measurement facilities used to collect the measurement data are located at

- No. 163-1, Jhongsheng Rd., Sindien District, Taipei City 23151, Taiwan
Tel: 886-2-2217-0894 / Fax: 886-2-2217-1029
- No 11, Wugong 6th Rd, Wugu District, New Taipei City 24891, Taiwan (R.O.C)
Tel: 886-2-2299-9720 / Fax: 886-2-2298-4045
- No.81-1, Lane 210, Bade 2nd Rd., Lujhu Township, Taoyuan County 33841, Taiwan
Tel: 886-3-324-0332 / Fax: 886-3-324-5235

The sites are constructed in conformance with the requirements of ANSI C63.7, ANSI C63.4 and CISPR Publication 22.

All receiving equipment conforms to CISPR Publication 16-1, "Radio Interference Measuring Apparatus and Measurement Methods."

5.2 LABORATORY ACCREDITATIONS AND LISTING

The test facilities used to perform radiated and conducted emissions tests are accredited by American Association for Laboratory Accreditation Program for the specific scope accreditation under Lab Code: 0824-01 to perform Electromagnetic Interference tests according to FCC Part 15 and CISPR 22 requirements. In addition, the test facilities are listed with Industry Canada, Certification and Engineering Bureau, IC 2324G-1 for 3M Semi Anechoic Chamber A, IC 2324G-2 for 3M Semi Anechoic Chamber B.



5.3 TABLE OF ACCREDITATIONS AND LISTINGS

Country	Agency	Scope of Accreditation	Logo
USA	A2LA	CFR 47, FCC Part15/18, CISPR 22, EN 55022, ICES-003, AS/NZS CISPR 22, VCCI V-3, EN 55011, CISPR 11, IEC/EN 61000-4-2/3/4/5/6/8/11, EN 61000-6-1/2/3/4, EN 55024, CISPR 24, AS/NZS CISPR 24, AS/NZS 61000.6.2, EN 55014-1/-2, ETSI EN 300 386 v1.3.2/v1.3.3, IEC/EN 61000-3-2, AS/NZS 61000.3.2, IEC/EN 61000-3-3, AS/NZS 61000.3.3	
USA	FCC MRA	3 meter Open Area Test Sites to perform FCC Part 15/18 measurements	
Japan	VCCI	3/10 meter Open Area Test Sites and conducted test sites to perform radiated/conducted measurements	VCCI R-2882/2541/2798/725/1868 C-402/747/912 T-1930/1646
Taiwan	TAF	EN 55014-1, CISPR 14, CNS 13781-1, EN 55013, CISPR 13, CNS 13439, EN 55011, CISPR 11, CNS 13803, PLMN09, IS2045-0, LP0002 FCC Part 27/90, Part 15B/C/D/E, RSS-192/193/210/310 ETSI EN 300 328/ 300 220-1/ 300 220-2/ 301 893/ 301 489-01/ 301 489-03/ 301 489-07 / 301 489-17/ 300 440-1/ 300 440-2 AS/NZS 4268, AS/NZS 4771 CISPR 22, EN 55022, CNS 13438, AS/NZS CISPR 22, VCCI, IEC/EN 61000-4-2/3/4/5/6/8/11, CNS 14676-2/3/4/5/6/8, CNS 14934-2/3, CNS 13783-1, CNS 13439, CNS 13803	
Taiwan	BSMI	CNS 13438, CNS 13783-1, CNS 13439, CNS 14115	SL2-IS-E-0014 / IN-E-0014 /A1-E-0014 /R1-E-0014 /R2-E-0014 /L1-E-0014
Canada	Industry Canada	RSS-Gen Issue 3	

* No part of this report may be used to claim or imply product endorsement by A2LA or any agency of the US Government.



6 SETUP OF EQUIPMENT UNDER TEST

6.1 SETUP CONFIGURATION OF EUT

See test photographs attached in Appendix II for the actual connections between EUT and support equipment.

6.2 SUPPORT EQUIPMENT

For Radiated Emissions(Below 1GHz) and Powerline Conducted Emission (LAN Mode)							
No.	Device Type	Model	Series No.	FCC ID	Brand	Data Cable	Power Cord
1	Notebook PC (Remote)	TP00013A	LR-9XH2K	FCC DoC	LENOVO	LAN Cable: Unshielded, 10m	AC I/P: Unshielded, 1.8m DC O/P: Unshielded, 1.8m with a core

For Radiated Emissions(Below 1GHz) and Powerline Conducted Emission (Wifi Mode)							
No.	Device Type	Model	Series No.	FCC ID	Brand	Data Cable	Power Cord
1	AP	Dir-810L	N/A	FCC DoC	D-Link	N/A	Unshielded, 1.8m
2	Notebook PC (Remote)	TP00013A	LR-9XH2K	FCC DoC	LENOVO	LAN Cable: Unshielded, 10m	AC I/P: Unshielded, 1.8m DC O/P: Unshielded, 1.8m with a core

For Radiated Emissions(Above 1GHz) and Conducted Emission							
No.	Device Type	Model	Series No.	FCC ID	Brand	Data Cable	Power Cord
1	Notebook PC	PCG-6GFP	N/A	FCC DoC	Sony	USB Cable: Shielded, 0.3m	AC I/P: Unshielded, 1.8m DC O/P: Unshielded, 1.8m with a core

Remark: Grounding was established in accordance with the manufacturer's requirements and conditions for the intended use.



7 FCC PART 15 REQUIREMENTS

7.1 6DB BANDWIDTH

LIMIT

According to §15.247(a)(2), systems using digital modulation techniques may operate in the 902 - 928 MHz, 2400 - 2483.5 MHz, and 5725 - 5850 MHz bands. The minimum 6dB bandwidth shall be at least 500 kHz.

Test Configuration

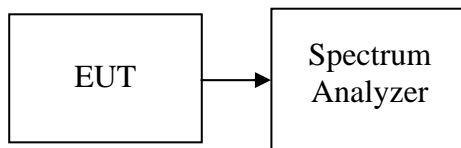

TEST PROCEDURE

1. Place the EUT on the table and set it in the transmitting mode.
2. Remove the antenna from the EUT and then connect a low loss RF cable from the antenna port to the spectrum analyzer.
3. Set the spectrum analyzer as RBW = 100kHz, VBW = 300kHz, Sweep = auto, Span = 30MHz (IEEE 802.11b, IEEE 802.11g, IEEE 802.11n HT20) or Span = 50MHz (IEEE 802.11n HT40).
4. Mark the peak frequency and -6dB (upper and lower) frequency.
5. Repeat until all the rest channels are investigated.

TEST RESULTS

No non-compliance noted



Test Data

Test mode: IEEE 802.11b mode

Channel	Frequency (MHz)	Bandwidth (MHz)	Limit (kHz)	Result
Low	2412	10.11	>500	PASS
Mid	2437	10.11		PASS
High	2462	10.08		PASS

Test mode: IEEE 802.11g mode

Channel	Frequency (MHz)	Bandwidth (MHz)	Limit (kHz)	Result
Low	2412	16.62	>500	PASS
Mid	2437	16.62		PASS
High	2462	16.62		PASS

Test mode: IEEE 802.11n HT20 mode

Channel	Frequency (MHz)	Bandwidth (MHz)	Limit (kHz)	Result
Low	2412	17.82	>500	PASS
Mid	2437	17.85		PASS
High	2462	17.85		PASS

Test mode: IEEE 802.11n HT40 mode

Channel	Frequency (MHz)	Bandwidth (MHz)	Limit (kHz)	Result
Low	2422	36.40	>500	PASS
Mid	2437	36.45		PASS
High	2452	36.45		PASS



Test Plot

IEEE 802.11b mode

6dB Bandwidth (CH Low)



6dB Bandwidth (CH Mid)





6dB Bandwidth (CH High)



IEEE 802.11g mode

6dB Bandwidth (CH Low)





6dB Bandwidth (CH Mid)



6dB 6dB Bandwidth (CH High)





IEEE 802.11n HT20 mode

6dB Bandwidth (CH Low)

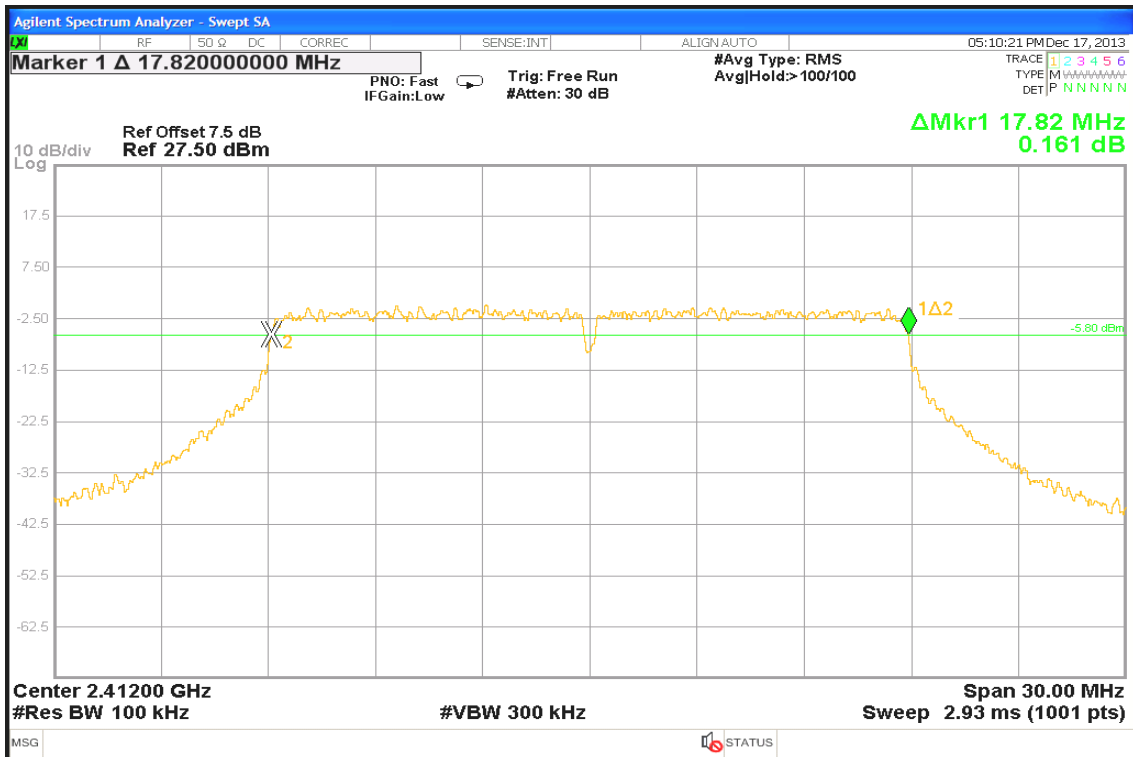

6dB Bandwidth (CH Mid)





6dB Bandwidth (CH High)



IEEE 802.11n HT40 mode

6dB Bandwidth (CH Low)

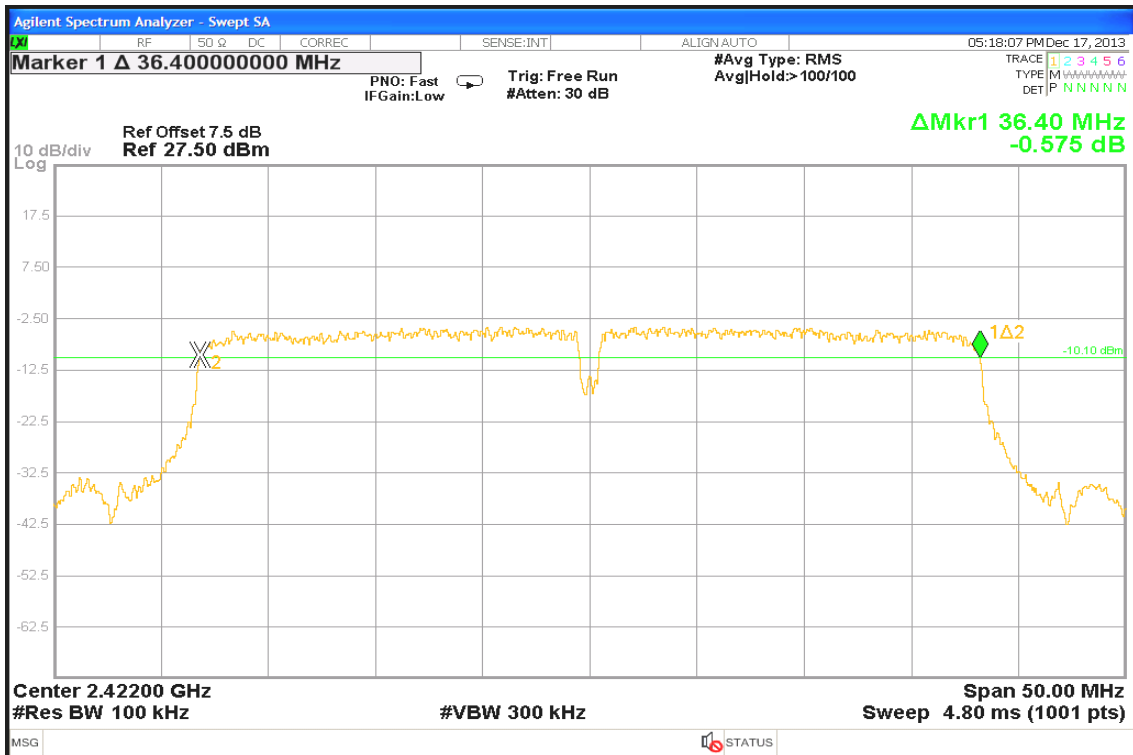



6dB Bandwidth (CH Mid)

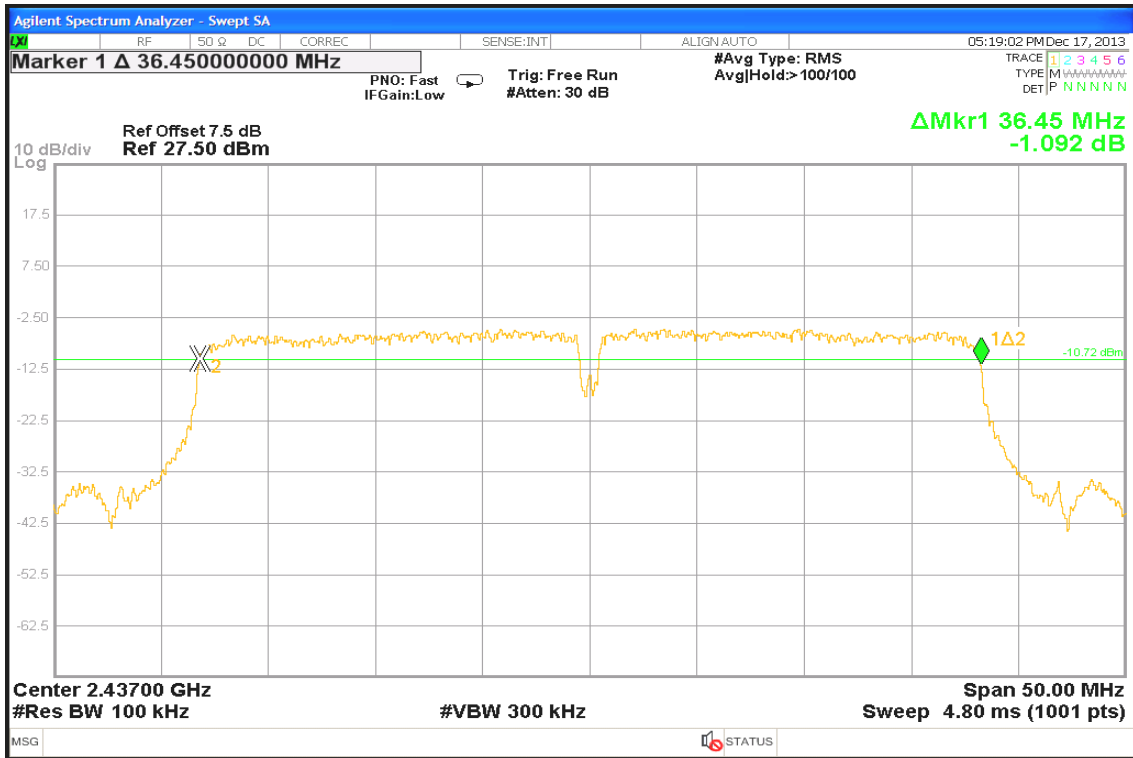

6dB Bandwidth (CH High)





7.2 PEAK POWER

LIMIT

The maximum peak output power of the intentional radiator shall not exceed the following:

1. According to §15.247(b)(3), for systems using digital modulation in the bands of 902-928 MHz, 2400-2483.5 MHz, and 5725-5850 MHz: 1 Watt.
2. According to §15.247(b)(4), the conducted output power limit specified in paragraph (b) of this section is based on the use of antennas with directional gains that do not exceed 6 dBi. Except as shown in paragraph (c) of this section, if transmitting antennas of directional gain greater than 6 dBi are used, the conducted output power from the intentional radiator shall be reduced below the stated values in paragraphs (b)(1), (b)(2), and (b)(3) of this section, as appropriate, by the amount in dB that the directional gain of the antenna exceeds 6 dBi.

Test Configuration

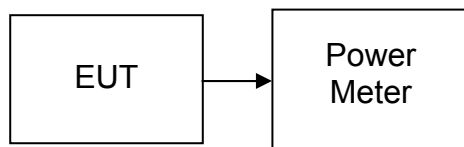

TEST PROCEDURE

Per KDB 558074 v03r01

The transmitter output is connected to the Power Meter. The Power Meter is set to the peak power detection.

TEST RESULTS

No non-compliance noted



Test Data

Test mode: IEEE 802.11b mode

Channel	Frequency (MHz)	Output Power (dBm)	Output Power (W)	Limit (W)	Test Result
Low	2412	18.78	0.0755	1	PASS
Mid	2437	18.58	0.0721		PASS
High	2462	18.73	0.0746		PASS

Test mode: IEEE 802.11g mode

Channel	Frequency (MHz)	Output Power (dBm)	Output Power (W)	Limit (W)	Test Result
Low	2412	23.02	0.2004	1	PASS
Mid	2437	22.38	0.1730		PASS
High	2462	22.60	0.1820		PASS

Test mode: IEEE 802.11n HT20 mode

Channel	Frequency (MHz)	Output Power (dBm)	Output Power (W)	Limit (W)	Test Result
Low	2412	22.31	0.1702	1	PASS
Mid	2437	21.89	0.1545		PASS
High	2462	21.49	0.1409		PASS

Test mode: IEEE 802.11n HT40 mode

Channel	Frequency (MHz)	Output Power (dBm)	Output Power (W)	Limit (W)	Test Result
Low	2422	21.50	0.1413	1	PASS
Mid	2437	21.31	0.1352		PASS
High	2452	21.20	0.1318		PASS



7.3 AVERAGE POWER

LIMIT

None; for reporting purposes only.

Test Configuration

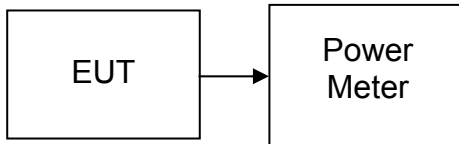

TEST PROCEDURE

Per KDB 558074 v03r01

The transmitter output is connected to the Power Meter. The Power Meter is set to the peak power detection.

TEST RESULTS

No non-compliance noted



Test Data

Test mode: IEEE 802.11b mode

Channel	Frequency (MHz)	Output Power (dBm)	Output Power (W)
Low	2412	16.37	0.0434
Mid	2437	16.15	0.0412
High	2462	16.37	0.0434

Test mode: IEEE 802.11g mode

Channel	Frequency (MHz)	Output Power (dBm)	Output Power (W)
Low	2412	13.66	0.0232
Mid	2437	13.22	0.0210
High	2462	13.59	0.0229

Test mode: IEEE 802.11n HT20 mode

Channel	Frequency (MHz)	Output Power (dBm)	Output Power (W)
Low	2412	13.56	0.0227
Mid	2437	13.10	0.0204
High	2462	12.42	0.0175

Test mode: IEEE 802.11n HT40 mode

Channel	Frequency (MHz)	Output Power (dBm)	Output Power (W)
Low	2422	12.57	0.0181
Mid	2437	12.30	0.0170
High	2452	11.93	0.0156



7.4 BAND EDGES MEASUREMENT

LIMIT

According to §15.247(d), in any 100 kHz bandwidth outside the frequency bands in which the spread spectrum intentional radiator is operating, the radio frequency power that is produced by the intentional radiator shall be at least 20 dB below that in the 100 kHz bandwidth within the band that contains the highest level of the desired power, based on either an RF conducted or a radiated measurement, provided the transmitter demonstrates compliance with the peak conducted power limits. In addition, radiated emissions which fall in the restricted bands, as defined in §15.205(a), must also comply with the radiated emission limits specified in 15.209(a) (see Section 15.205(c)).

Test Configuration

For Radiated

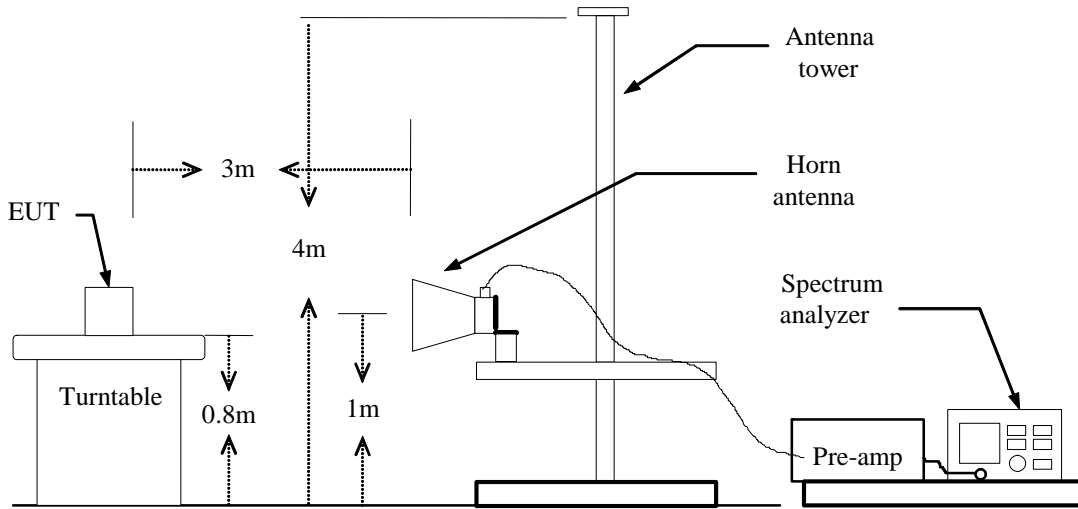

For Conducted

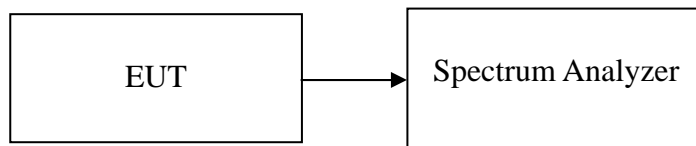



TEST PROCEDURE

For Radiated

1. The EUT is placed on a turntable, which is 0.8m above the ground plane.
2. The turntable shall be rotated for 360 degrees to determine the position of maximum emission level.
3. EUT is set 3m away from the receiving antenna, which is varied from 1m to 4m to find out the highest emission.
4. Set the spectrum analyzer in the following setting in order to capture the lower and upper band-edges of the emission:
 - (a) PEAK: RBW=1MHz / VBW=3MHz / Sweep=AUTO
 - (b) AVERAGE: RBW=1MHz / VBW=300Hz / Sweep=AUTO
5. Repeat the procedures until all the PEAK and AVERAGE versus POLARIZATION are measured.

For Conducted

Conducted RF measurements of the transmitter output were made to confirm that the EUT antenna port conducted emissions meet the specified limit and to identify any spurious signals that require further investigation or measurements on the radiated emissions site.

The transmitter output is connected to the spectrum analyzer. The resolution bandwidth is set to 100 kHz. The video bandwidth is set to 100 kHz.

TEST RESULTS

Refer to attach spectrum analyzer data chart.



IEEE 802.11n HT20 mode

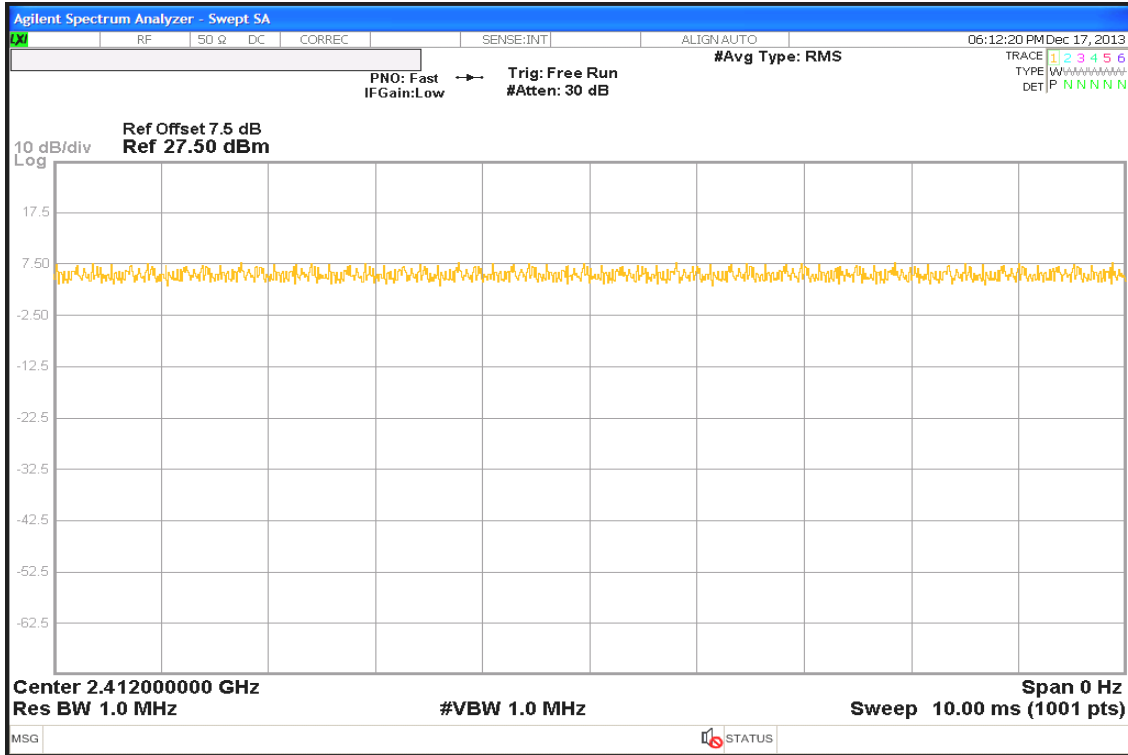

IEEE 802.11n HT40 mode

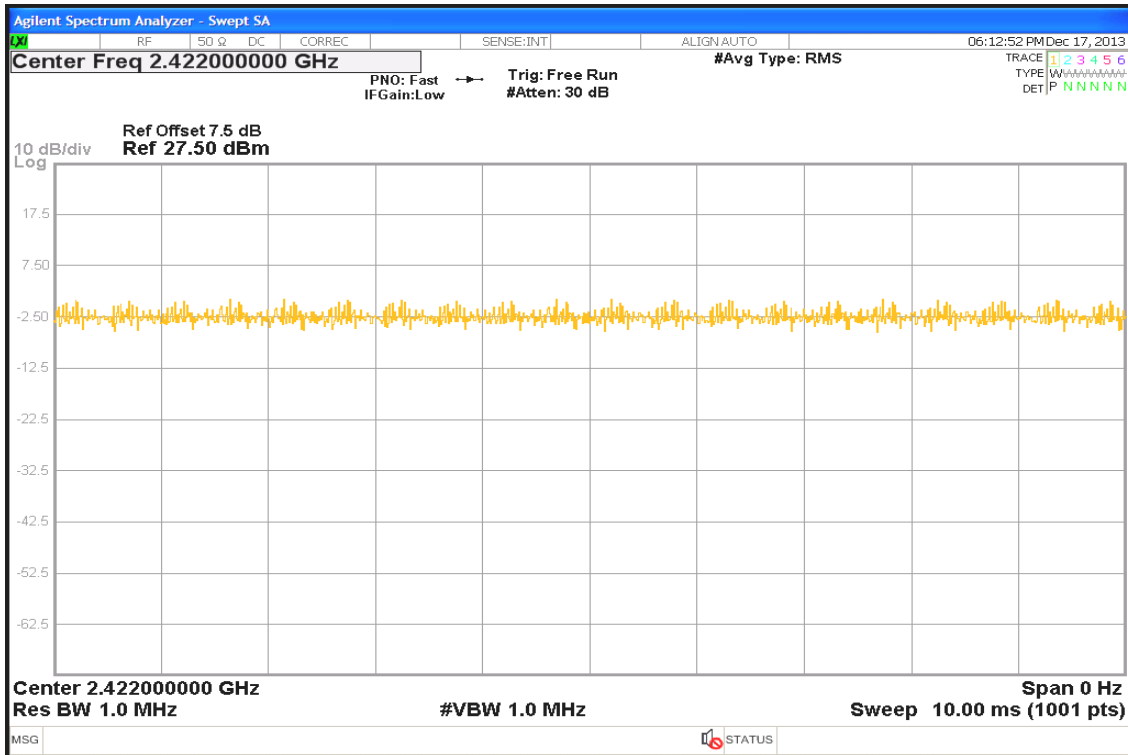



TEST DATA

Band Edges (IEEE 802.11b mode / CH Low)

Detector mode: Peak

Polarity: Vertical

Agilent

R T

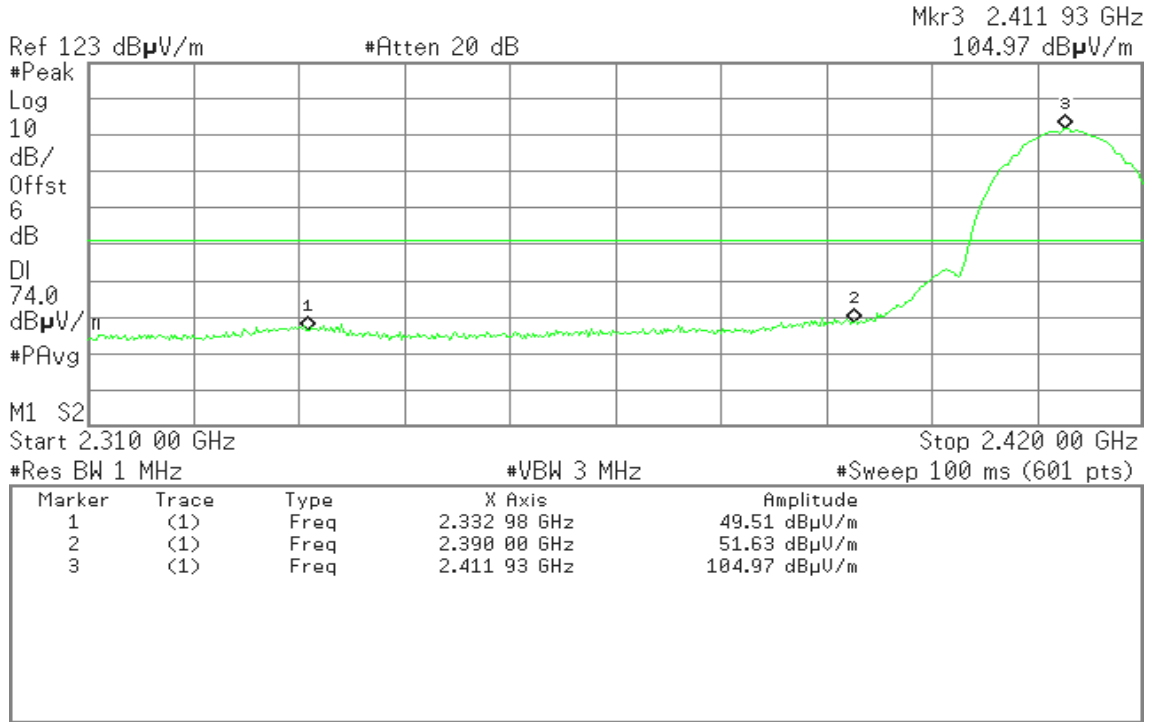

Detector mode: Average

Polarity: Vertical

Agilent

R T

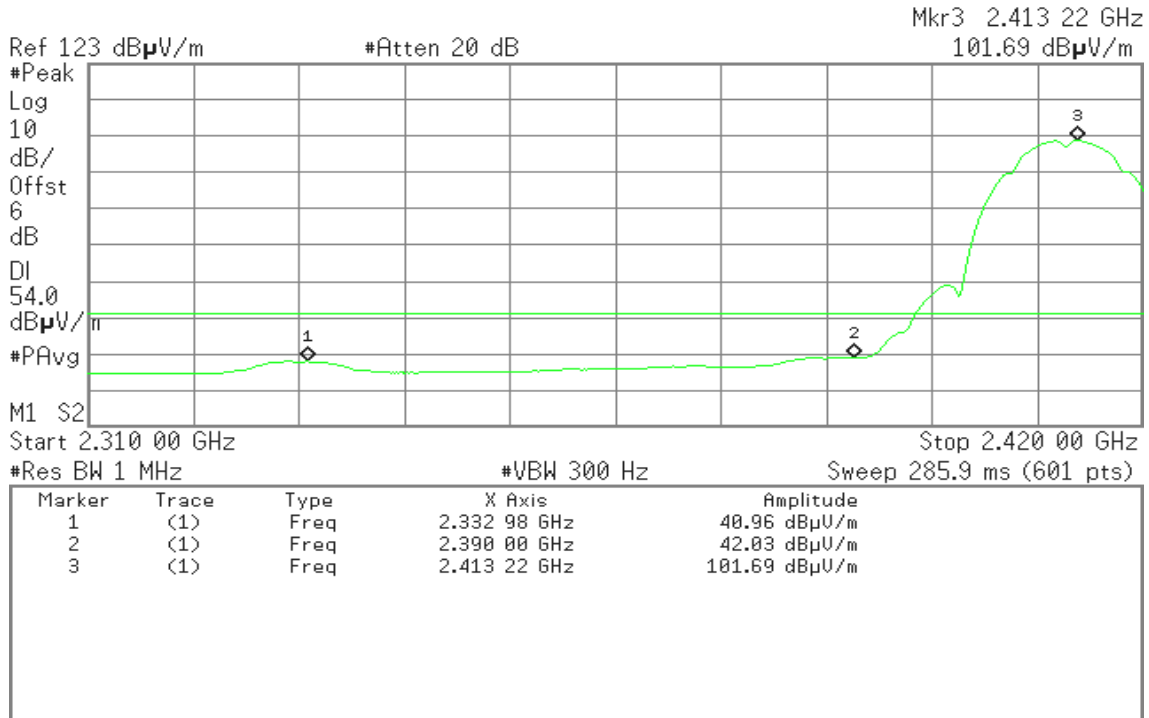



Detector mode: Peak

Polarity: Horizontal

Agilent

R T

Mkr3 2.412 12 GHz
100.30 dBµV/m

Ref 123 dBµV/m

#Atten 20 dB

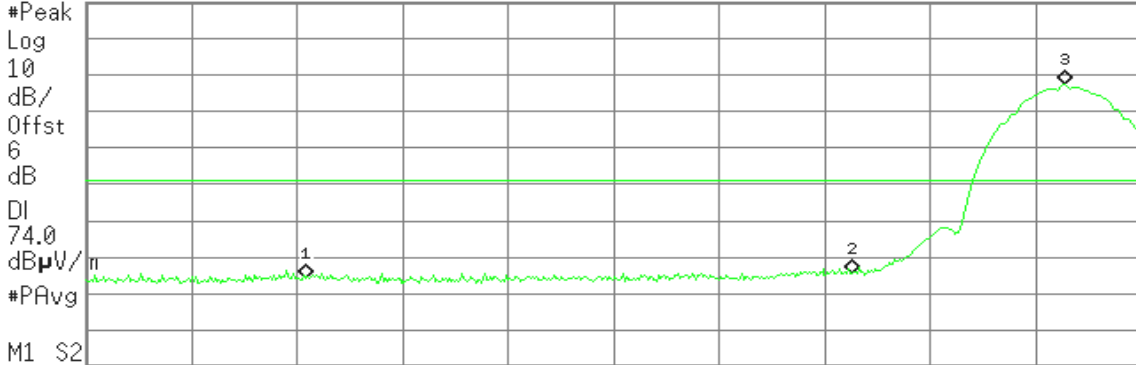

Start 2.310 00 GHz

Stop 2.420 00 GHz

#Res BW 1 MHz

#VBW 3 MHz

#Sweep 100 ms (601 pts)

Marker	Trace	Type	X Axis	Amplitude
1	(1)	Freq	2.332 98 GHz	47.15 dBµV/m
2	(1)	Freq	2.390 00 GHz	48.46 dBµV/m
3	(1)	Freq	2.412 12 GHz	100.30 dBµV/m

Detector mode: Average

Polarity: Horizontal

Agilent

R T

Mkr3 2.413 22 GHz
97.12 dBµV/m

Ref 123 dBµV/m

#Atten 20 dB



Start 2.310 00 GHz

Stop 2.420 00 GHz

#Res BW 1 MHz

#VBW 300 Hz

Sweep 285.9 ms (601 pts)

Marker	Trace	Type	X Axis	Amplitude
1	(1)	Freq	2.332 98 GHz	37.81 dBµV/m
2	(1)	Freq	2.390 00 GHz	39.10 dBµV/m
3	(1)	Freq	2.413 22 GHz	97.12 dBµV/m



Band Edges (IEEE 802.11b mode / CH High)

Detector mode: Peak

Polarity: Vertical

Agilent

R T

Mkr1 2.462 00 GHz

107.14 dBμV/m

Ref 123 dBμV/m

#Atten 20 dB

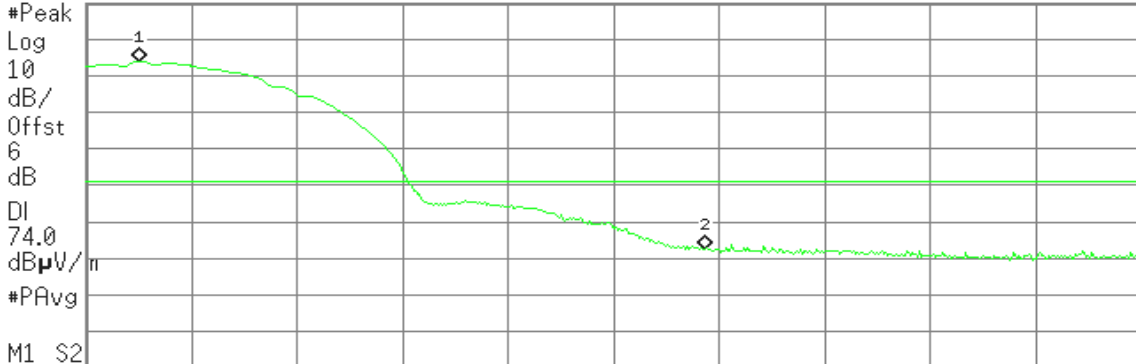

Start 2.460 00 GHz

Stop 2.500 00 GHz

#Res BW 1 MHz

#VBW 3 MHz

#Sweep 100 ms (601 pts)

Marker	Trace	Type	X Axis	Amplitude
1	(1)	Freq	2.462 00 GHz	107.14 dBμV/m
2	(1)	Freq	2.483 50 GHz	55.48 dBμV/m

Detector mode: Average

Polarity: Vertical

Agilent

R T

Mkr1 2.463 20 GHz

103.93 dBμV/m

Ref 123 dBμV/m

#Atten 20 dB

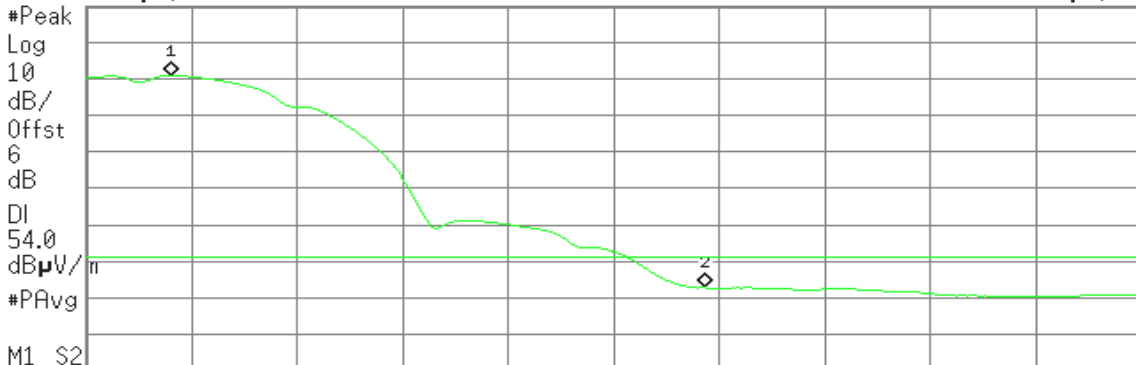

Start 2.460 00 GHz

Stop 2.500 00 GHz

#Res BW 1 MHz

#VBW 300 Hz

Sweep 104 ms (601 pts)

Marker	Trace	Type	X Axis	Amplitude
1	(1)	Freq	2.463 20 GHz	103.93 dBμV/m
2	(1)	Freq	2.483 50 GHz	45.75 dBμV/m



Detector mode: Peak

Polarity: Horizontal

Agilent

R T

Mkr1 2.462 00 GHz
102.49 dBµV/m

Ref 123 dBµV/m

#Atten 20 dB

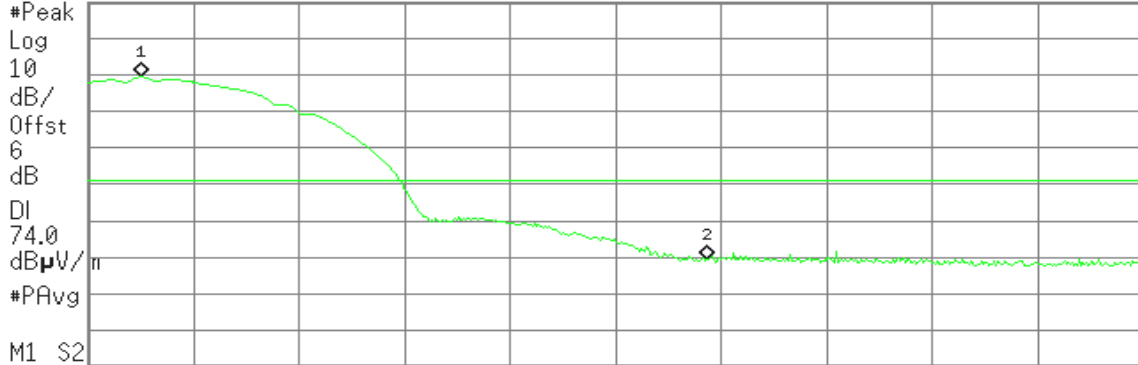

M1 S2
Start 2.460 00 GHz

Stop 2.500 00 GHz
#Sweep 100 ms (601 pts)

#Res BW 1 MHz

#VBW 3 MHz

Marker	Trace	Type	X Axis	Amplitude
1	(1)	Freq	2.462 00 GHz	102.49 dBµV/m
2	(1)	Freq	2.483 50 GHz	52.57 dBµV/m

Detector mode: Average

Polarity: Horizontal

Agilent

R T

Mkr1 2.461 00 GHz
99.09 dBµV/m

Ref 123 dBµV/m

#Atten 20 dB



M1 S2
Start 2.460 00 GHz

Stop 2.500 00 GHz
Sweep 104 ms (601 pts)

#Res BW 1 MHz

#VBW 300 Hz

Marker	Trace	Type	X Axis	Amplitude
1	(1)	Freq	2.461 00 GHz	99.09 dBµV/m
2	(1)	Freq	2.483 50 GHz	42.58 dBµV/m



Band Edges (IEEE 802.11g mode / CH Low)

Detector mode: Peak

Polarity: Vertical

Agilent

R T

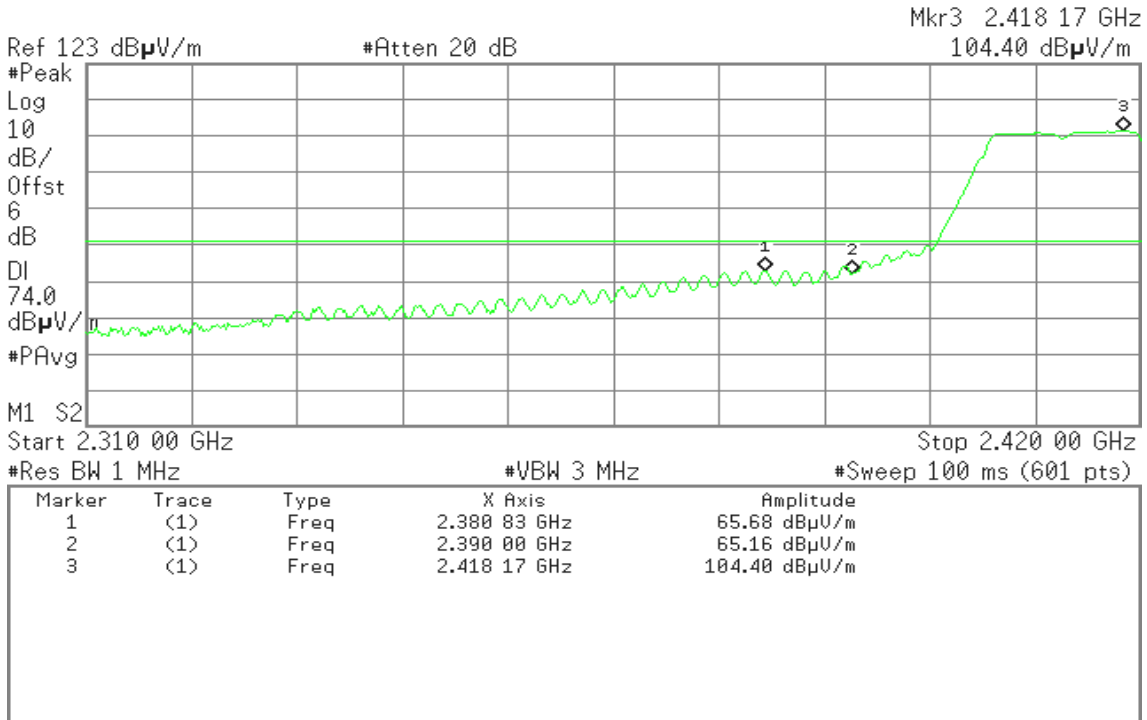

Detector mode: Average

Polarity: Vertical

Agilent

R T

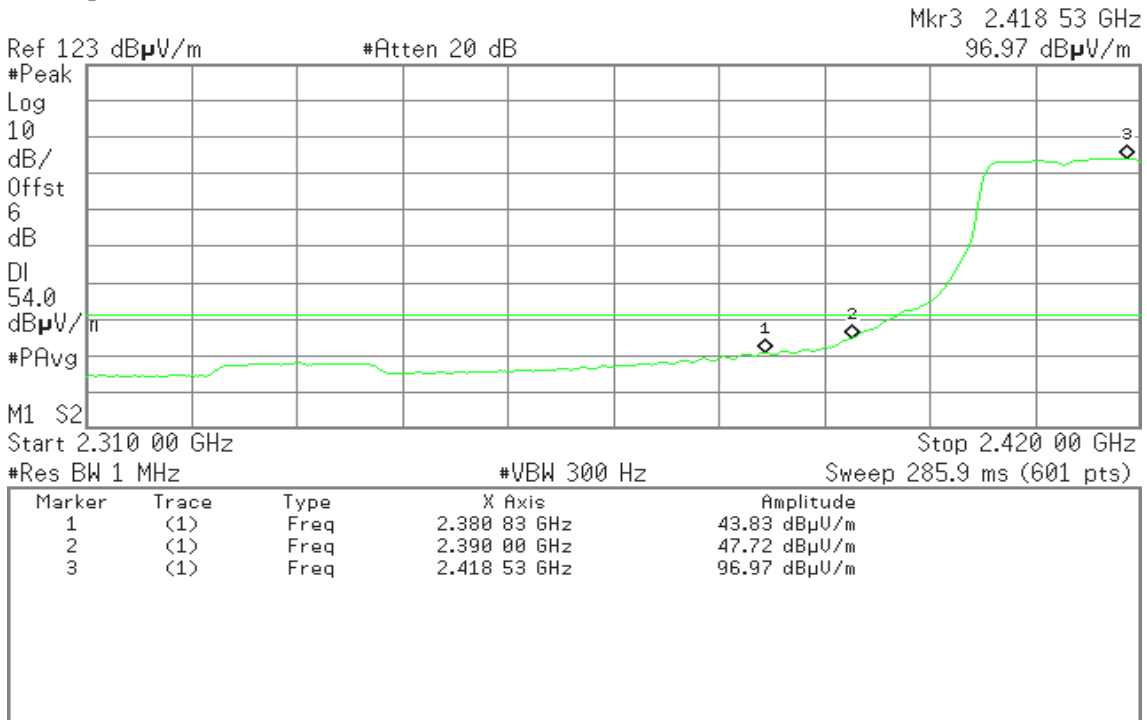



Detector mode: Peak

Polarity: Horizontal

Agilent

R T

Mkr3 2.418 35 GHz
99.55 dBµV/m

Ref 123 dBµV/m

#Atten 20 dB

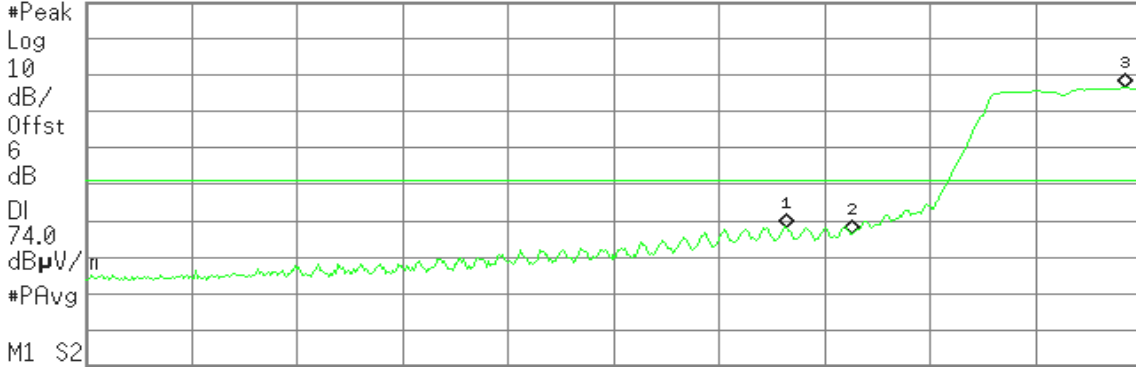

Start 2.310 00 GHz

Stop 2.420 00 GHz

#Res BW 1 MHz

#VBW 3 MHz

#Sweep 100 ms (601 pts)

Marker	Trace	Type	X Axis	Amplitude
1	(1)	Freq	2.383 03 GHz	61.19 dBµV/m
2	(1)	Freq	2.390 00 GHz	59.41 dBµV/m
3	(1)	Freq	2.418 35 GHz	99.55 dBµV/m

Detector mode: Average

Polarity: Horizontal

Agilent

R T

Mkr3 2.418 72 GHz
92.02 dBµV/m

Ref 123 dBµV/m

#Atten 20 dB

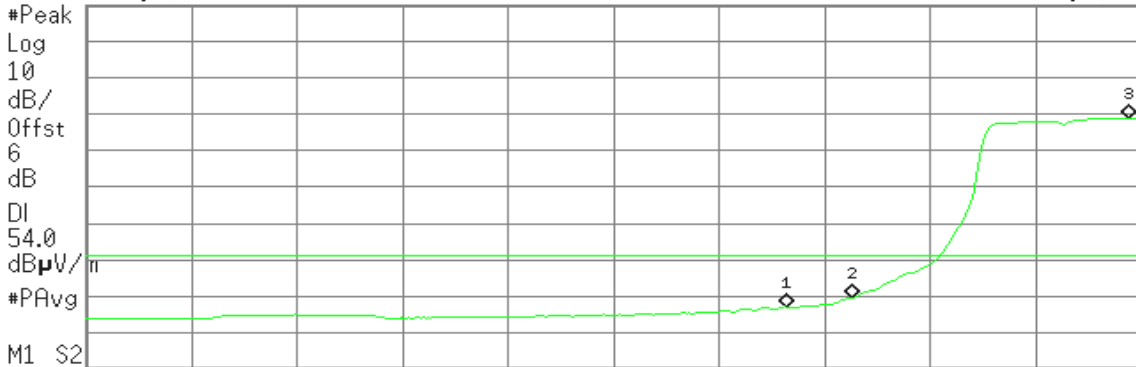

Start 2.310 00 GHz

Stop 2.420 00 GHz

#Res BW 1 MHz

#VBW 300 Hz

Sweep 285.9 ms (601 pts)

Marker	Trace	Type	X Axis	Amplitude
1	(1)	Freq	2.383 03 GHz	40.06 dBµV/m
2	(1)	Freq	2.390 00 GHz	42.57 dBµV/m
3	(1)	Freq	2.418 72 GHz	92.02 dBµV/m



Band Edges (IEEE 802.11g mode / CH High)

Detector mode: Peak

Polarity: Vertical

Agilent

R T

Mkr1 2.468 27 GHz

106.20 dB μ V/m

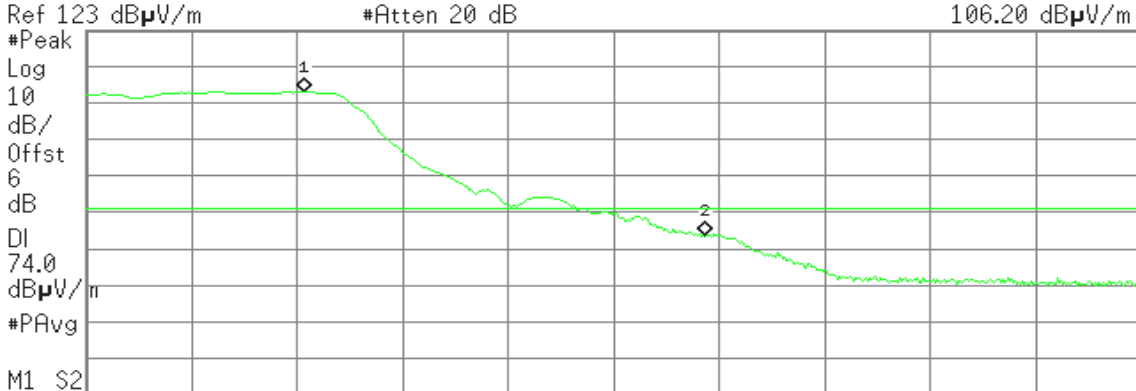

Ref 123 dB μ V/m #Atten 20 dB

Start 2.460 00 GHz Stop 2.500 00 GHz

#Res BW 1 MHz #VBW 3 MHz #Sweep 100 ms (601 pts)

Marker	Trace	Type	X Axis	Amplitude
1	(1)	Freq	2.468 27 GHz	106.20 dB μ V/m
2	(1)	Freq	2.483 50 GHz	66.50 dB μ V/m

Detector mode: Average

Polarity: Vertical

Agilent

R T

Mkr1 2.466 40 GHz

98.31 dB μ V/m

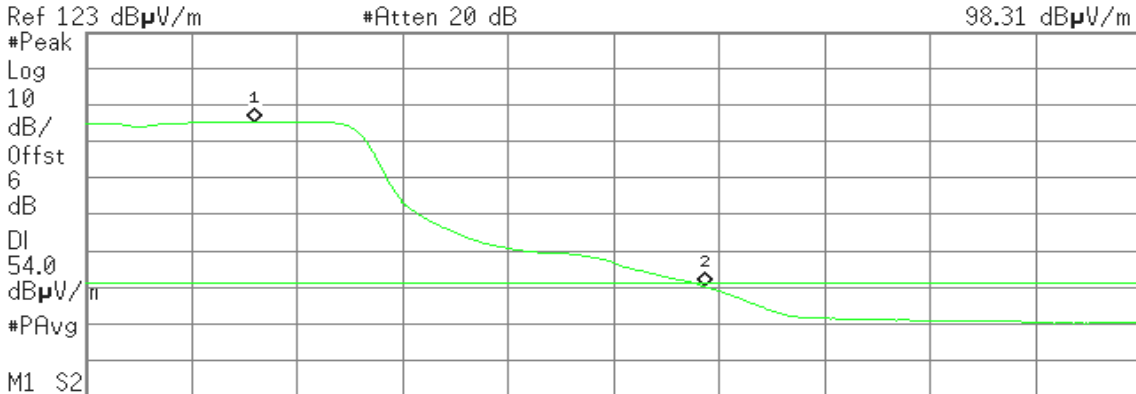

Ref 123 dB μ V/m #Atten 20 dB

Start 2.460 00 GHz Stop 2.500 00 GHz

#Res BW 1 MHz #VBW 300 Hz Sweep 104 ms (601 pts)

Marker	Trace	Type	X Axis	Amplitude
1	(1)	Freq	2.466 40 GHz	98.31 dB μ V/m
2	(1)	Freq	2.483 50 GHz	53.25 dB μ V/m



Detector mode: Peak

Polarity: Horizontal

Agilent

R T

Mkr1 2.463 60 GHz
100.72 dBµV/m

Ref 123 dBµV/m

#Atten 20 dB

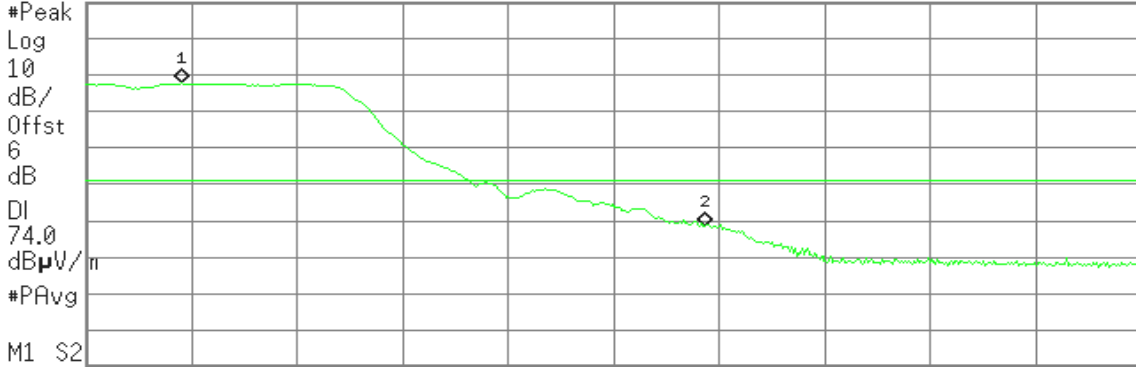

M1 S2
Start 2.460 00 GHz

Stop 2.500 00 GHz

#Res BW 1 MHz

#VBW 3 MHz

#Sweep 100 ms (601 pts)

Marker	Trace	Type	X Axis	Amplitude
1	(1)	Freq	2.463 60 GHz	100.72 dBµV/m
2	(1)	Freq	2.483 50 GHz	61.68 dBµV/m

Detector mode: Average

Polarity: Horizontal

Agilent

R T

Mkr1 2.464 67 GHz
93.38 dBµV/m

Ref 123 dBµV/m

#Atten 20 dB

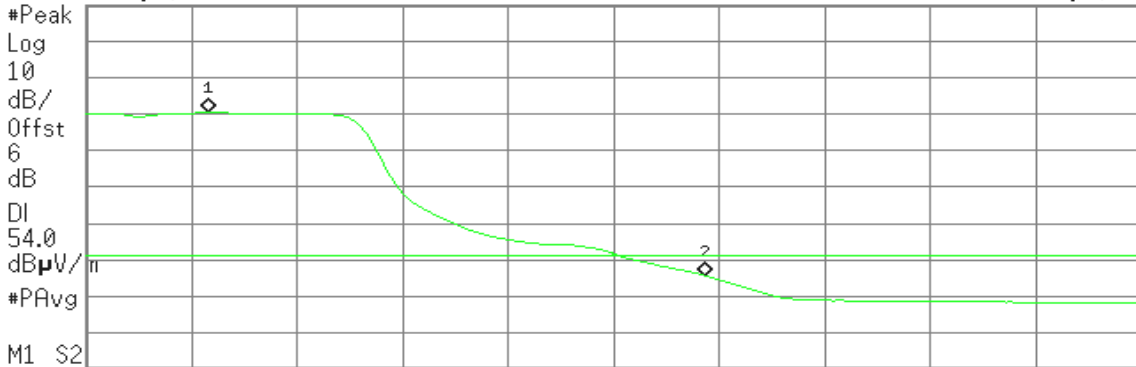

M1 S2
Start 2.460 00 GHz

Stop 2.500 00 GHz

#Res BW 1 MHz

#VBW 300 Hz

Sweep 104 ms (601 pts)

Marker	Trace	Type	X Axis	Amplitude
1	(1)	Freq	2.464 67 GHz	93.38 dBµV/m
2	(1)	Freq	2.483 50 GHz	48.60 dBµV/m



Band Edges (IEEE 802.11n HT20 mode / CH Low)

Detector mode: Peak

Polarity: Vertical

Agilent

R T

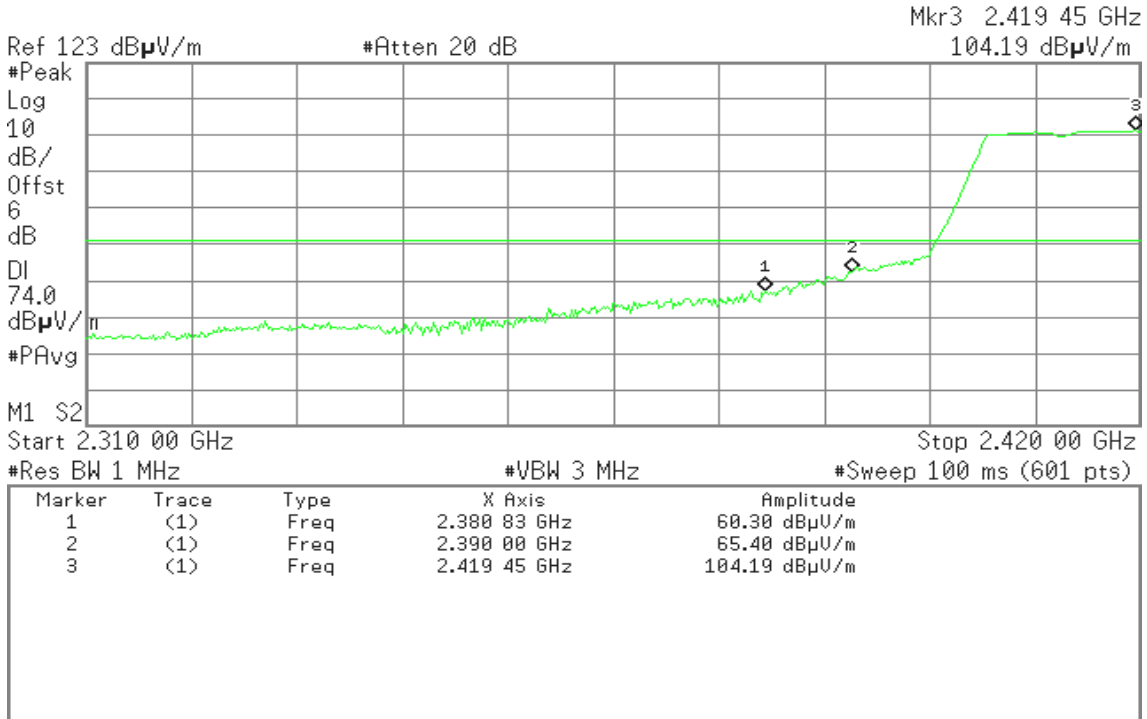

Detector mode: Average

Polarity: Vertical

Agilent

R T

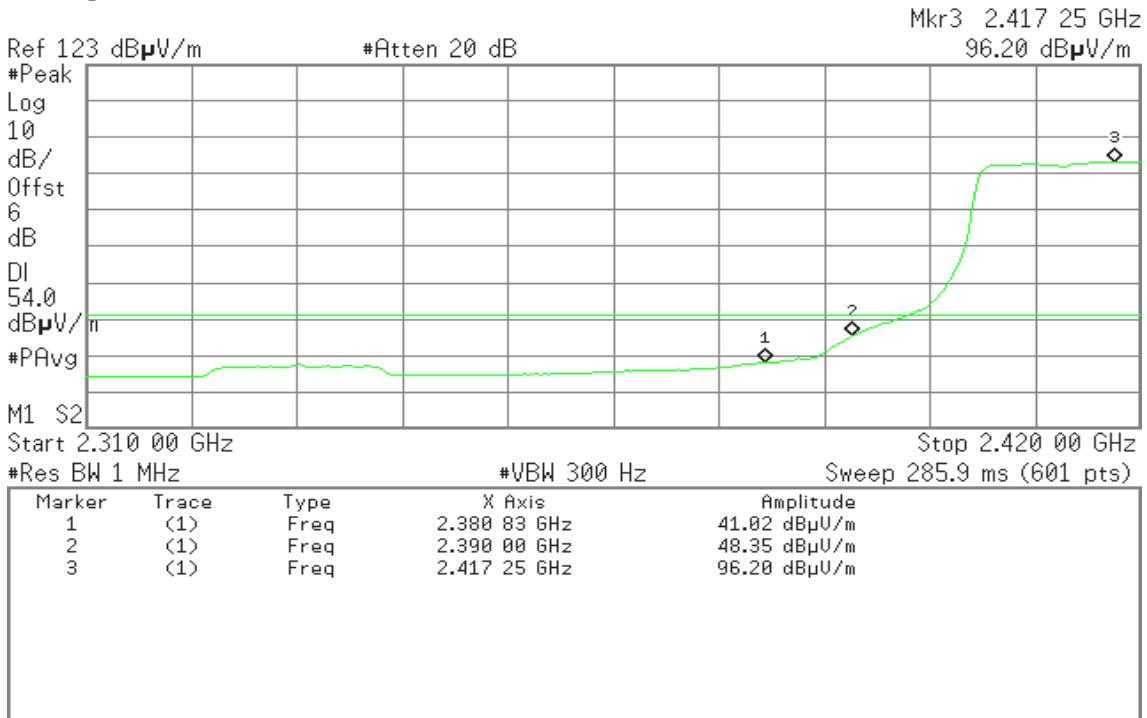



Detector mode: Peak

Polarity: Horizontal

Agilent

R T

Mkr3 2.419 45 GHz
98.73 dBµV/m

Ref 123 dBµV/m

#Atten 20 dB

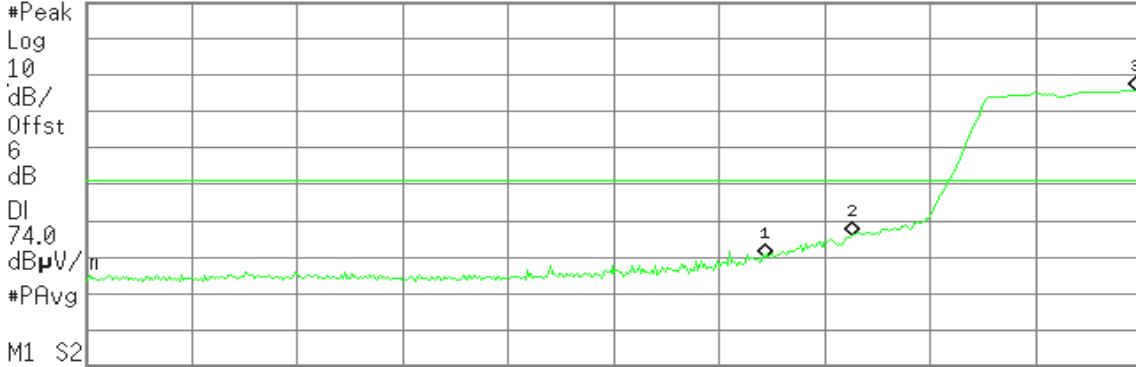

Start 2.310 00 GHz

Stop 2.420 00 GHz

#Res BW 1 MHz

#VBW 3 MHz

#Sweep 100 ms (601 pts)

Marker	Trace	Type	X Axis	Amplitude
1	(1)	Freq	2.380 83 GHz	52.79 dBµV/m
2	(1)	Freq	2.390 00 GHz	58.98 dBµV/m
3	(1)	Freq	2.419 45 GHz	98.73 dBµV/m

Detector mode: Average

Polarity: Horizontal

Agilent

R T

Mkr3 2.419 45 GHz
91.30 dBµV/m

Ref 123 dBµV/m

#Atten 20 dB

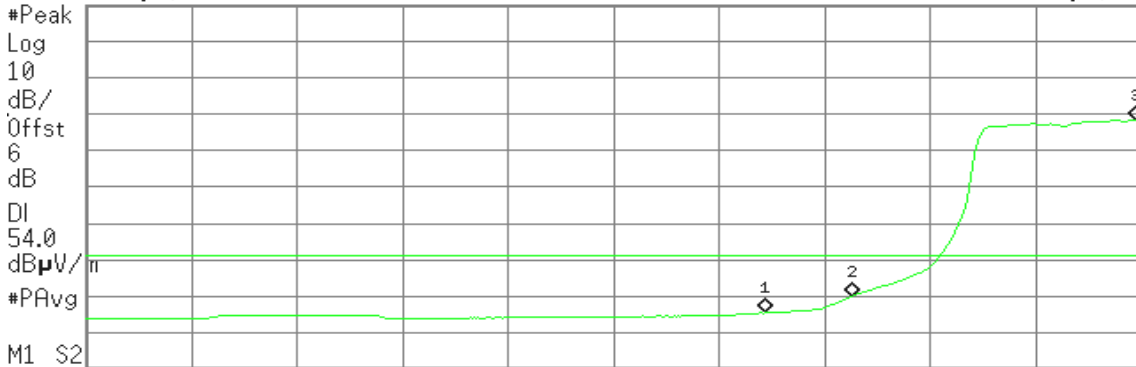

Start 2.310 00 GHz

Stop 2.420 00 GHz

#Res BW 1 MHz

#VBW 300 Hz

Sweep 285.9 ms (601 pts)

Marker	Trace	Type	X Axis	Amplitude
1	(1)	Freq	2.380 83 GHz	38.47 dBµV/m
2	(1)	Freq	2.390 00 GHz	42.97 dBµV/m
3	(1)	Freq	2.419 45 GHz	91.30 dBµV/m



Band Edges (IEEE 802.11n HT20 mode / CH High)

Detector mode: Peak

Polarity: Vertical

Agilent

R T

Mkr1 2.469 33 GHz

104.51 dBμV/m

Ref 123 dBμV/m

#Atten 20 dB



Start 2.460 00 GHz

Stop 2.500 00 GHz

#Res BW 1 MHz

#VBW 3 MHz

#Sweep 100 ms (601 pts)

Marker	Trace	Type	X Axis	Amplitude
1	(1)	Freq	2.469 33 GHz	104.51 dBμV/m
2	(1)	Freq	2.483 50 GHz	68.82 dBμV/m

Detector mode: Average

Polarity: Vertical

Agilent

R T

Mkr1 2.466 07 GHz

97.10 dBμV/m

Ref 123 dBμV/m

#Atten 20 dB

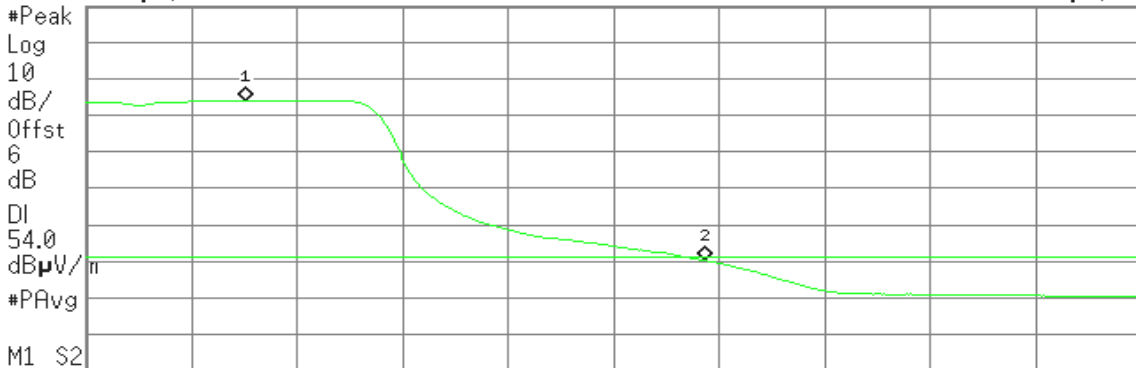

Start 2.460 00 GHz

Stop 2.500 00 GHz

#Res BW 1 MHz

#VBW 300 Hz

Sweep 104 ms (601 pts)

Marker	Trace	Type	X Axis	Amplitude
1	(1)	Freq	2.466 07 GHz	97.10 dBμV/m
2	(1)	Freq	2.483 50 GHz	53.25 dBμV/m



Detector mode: Peak

Polarity: Horizontal

Agilent

R T

Mkr1 2.465 60 GHz
99.58 dBµV/m

Ref 123 dBµV/m

#Atten 20 dB

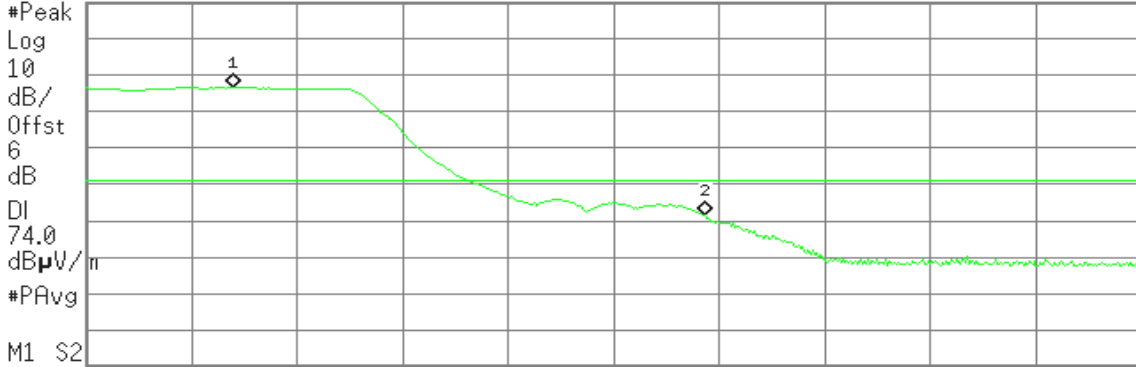

M1 S2
Start 2.460 00 GHz

Stop 2.500 00 GHz

#Res BW 1 MHz

#VBW 3 MHz

#Sweep 100 ms (601 pts)

Marker	Trace	Type	X Axis	Amplitude
1	(1)	Freq	2.465 60 GHz	99.58 dBµV/m
2	(1)	Freq	2.483 50 GHz	64.55 dBµV/m

Detector mode: Average

Polarity: Horizontal

Agilent

R T

Mkr1 2.465 33 GHz
92.09 dBµV/m

Ref 123 dBµV/m

#Atten 20 dB

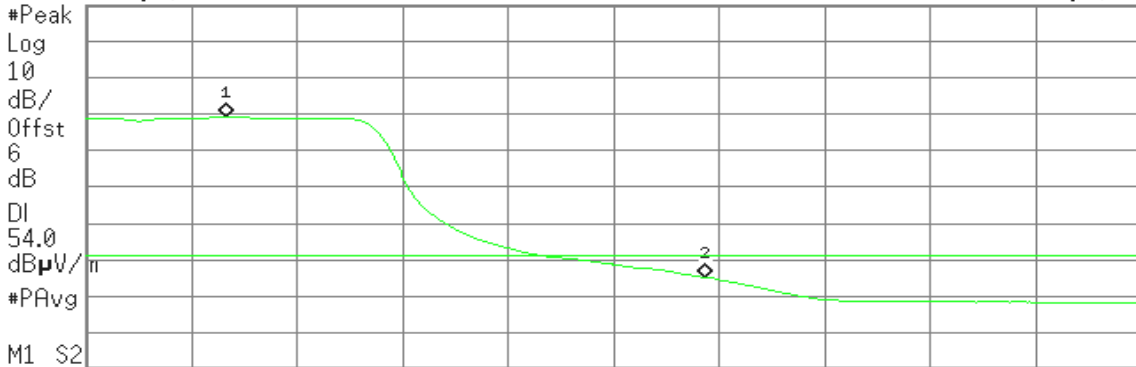

M1 S2
Start 2.460 00 GHz

Stop 2.500 00 GHz

#Res BW 1 MHz

#VBW 300 Hz

Sweep 104 ms (601 pts)

Marker	Trace	Type	X Axis	Amplitude
1	(1)	Freq	2.465 33 GHz	92.09 dBµV/m
2	(1)	Freq	2.483 50 GHz	48.17 dBµV/m



Band Edges (IEEE 802.11n HT40 mode / CH Low)

Detector mode: Peak

Polarity: Vertical

Agilent

R T

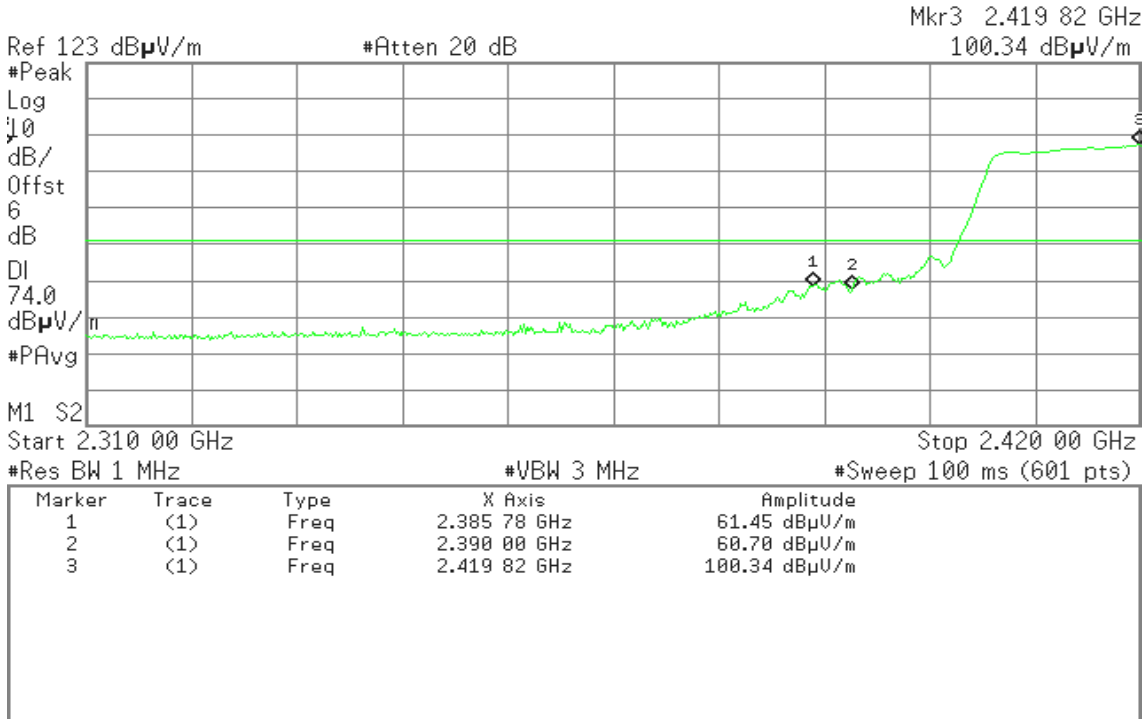

Detector mode: Average

Polarity: Vertical

Agilent

R T

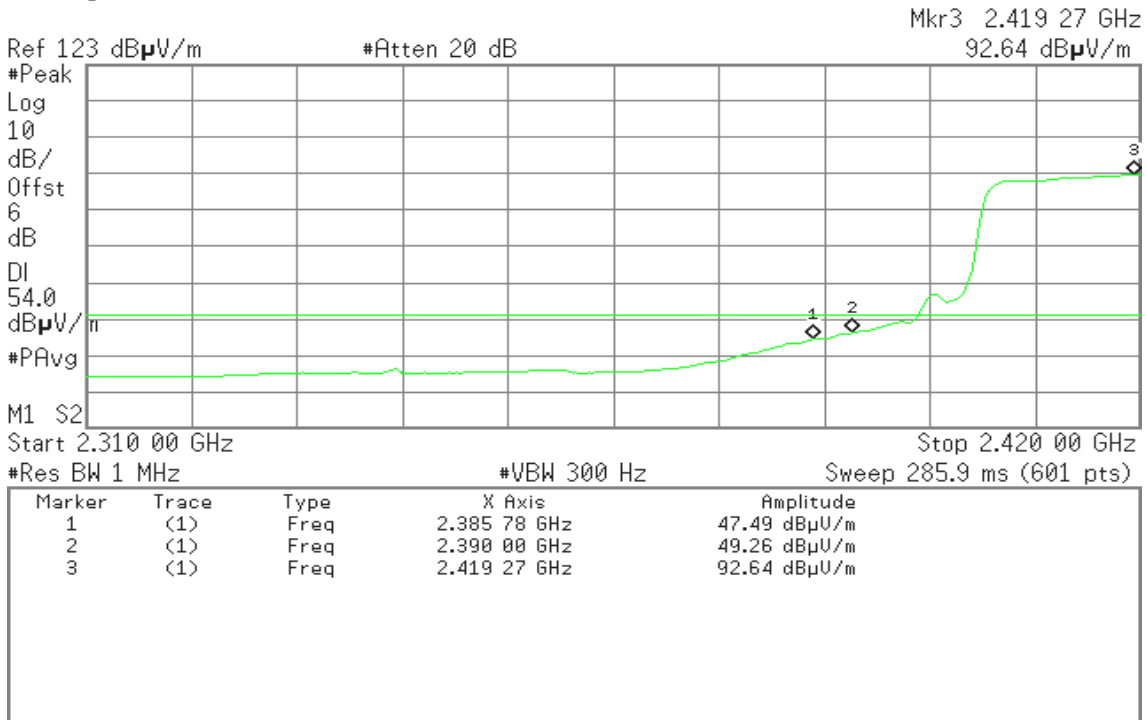



Detector mode: Peak

Polarity: Horizontal

Agilent

R T

Mkr3 2.419 63 GHz
95.57 dBµV/m

Ref 123 dBµV/m

#Atten 20 dB

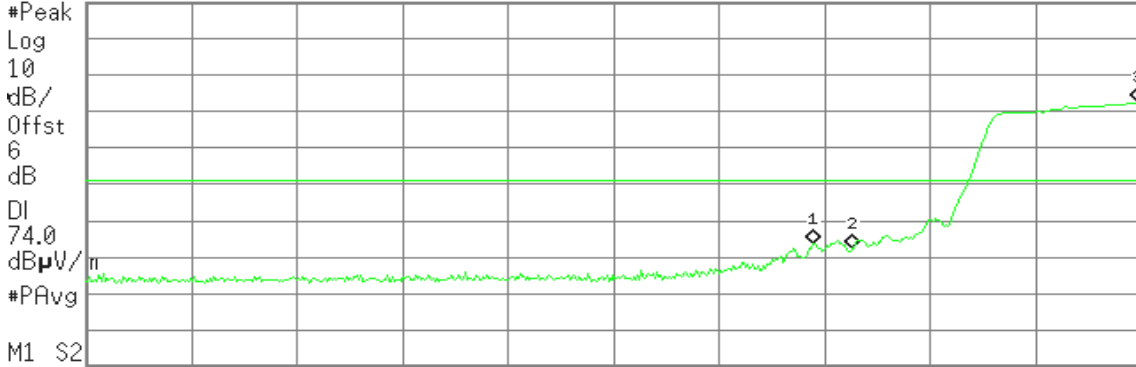

M1 S2
Start 2.310 00 GHz

Stop 2.420 00 GHz

#Res BW 1 MHz

#VBW 3 MHz

#Sweep 100 ms (601 pts)

Marker	Trace	Type	X Axis	Amplitude
1	(1)	Freq	2.385 78 GHz	56.56 dBµV/m
2	(1)	Freq	2.390 00 GHz	55.53 dBµV/m
3	(1)	Freq	2.419 63 GHz	95.57 dBµV/m

Detector mode: Average

Polarity: Horizontal

Agilent

R T

Mkr3 2.420 00 GHz
87.80 dBµV/m

Ref 123 dBµV/m

#Atten 20 dB

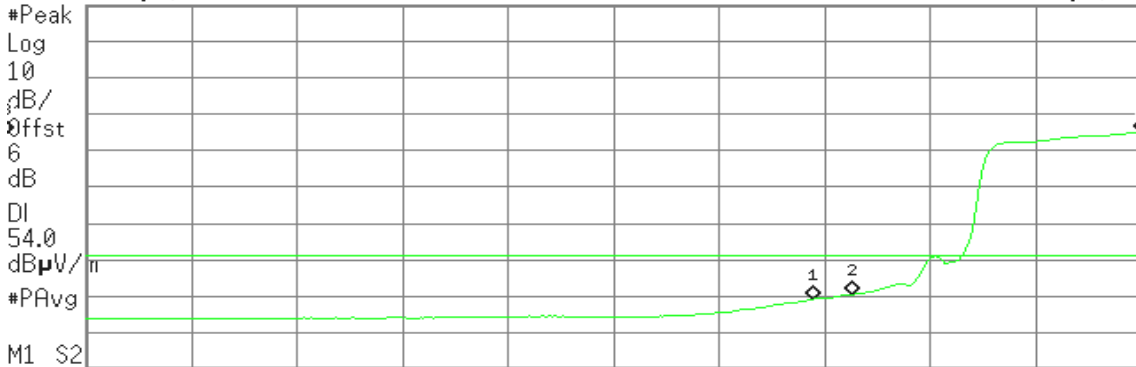

M1 S2
Start 2.310 00 GHz

Stop 2.420 00 GHz

#Res BW 1 MHz

#VBW 300 Hz

Sweep 285.9 ms (601 pts)

Marker	Trace	Type	X Axis	Amplitude
1	(1)	Freq	2.385 78 GHz	42.21 dBµV/m
2	(1)	Freq	2.390 00 GHz	43.43 dBµV/m
3	(1)	Freq	2.420 00 GHz	87.80 dBµV/m



Band Edges (IEEE 802.11n HT40 mode / CH High)

Detector mode: Peak

Polarity: Vertical

Agilent

R T

Mkr1 2.460 80 GHz

101.14 dB μ V/m

Ref 123 dB μ V/m

#Atten 20 dB

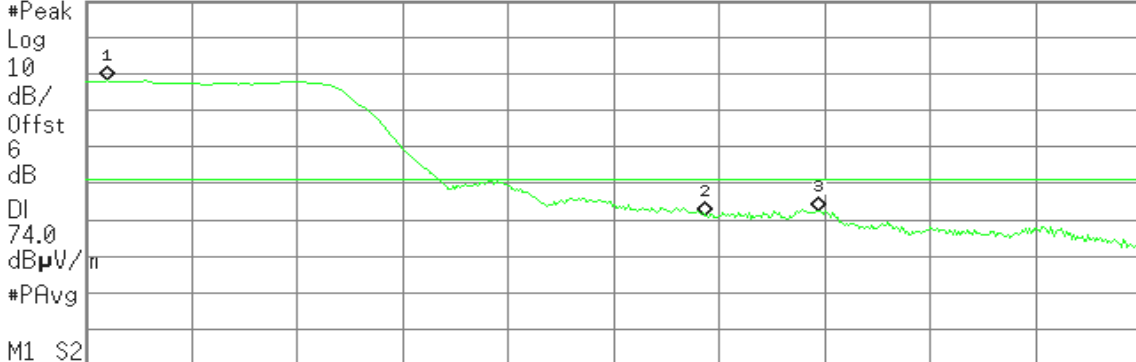

Start 2.460 00 GHz

Stop 2.500 00 GHz

#Res BW 1 MHz

#VBW 3 MHz

#Sweep 100 ms (601 pts)

Marker	Trace	Type	X Axis	Amplitude
1	(1)	Freq	2.460 80 GHz	101.14 dB μ V/m
2	(1)	Freq	2.483 50 GHz	64.02 dB μ V/m
3	(1)	Freq	2.487 73 GHz	65.31 dB μ V/m

Detector mode: Average

Polarity: Vertical

Agilent

R T

Mkr1 2.461 07 GHz

93.79 dB μ V/m

Ref 123 dB μ V/m

#Atten 20 dB

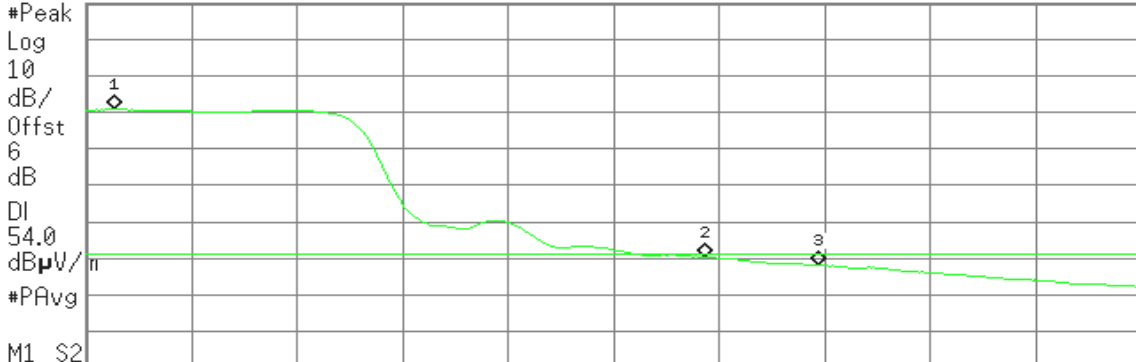

Start 2.460 00 GHz

Stop 2.500 00 GHz

#Res BW 1 MHz

#VBW 300 Hz

Sweep 104 ms (601 pts)

Marker	Trace	Type	X Axis	Amplitude
1	(1)	Freq	2.461 07 GHz	93.79 dB μ V/m
2	(1)	Freq	2.483 50 GHz	53.35 dB μ V/m
3	(1)	Freq	2.487 73 GHz	51.12 dB μ V/m



Detector mode: Peak

Polarity: Horizontal

Agilent

R T

Mkr1 2.462 33 GHz
97.66 dBµV/m

Ref 123 dBµV/m

#Atten 20 dB

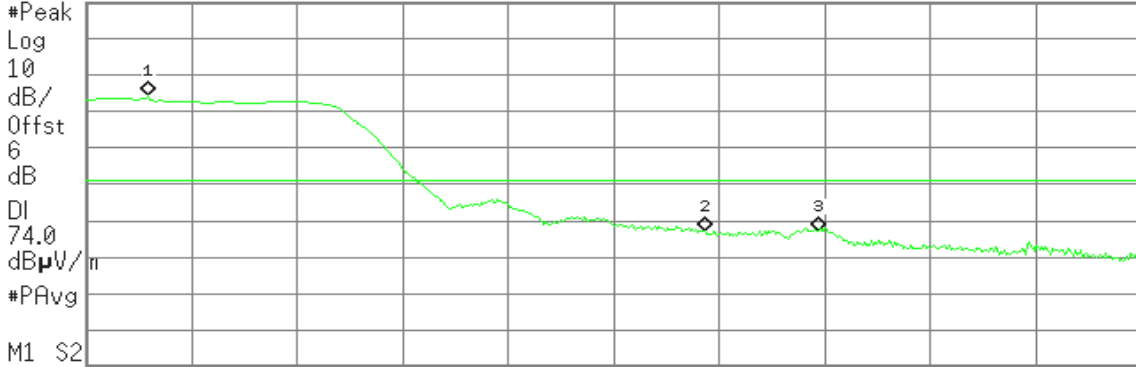

M1 S2
Start 2.460 00 GHz

Stop 2.500 00 GHz

#Res BW 1 MHz

#VBW 3 MHz

#Sweep 100 ms (601 pts)

Marker	Trace	Type	X Axis	Amplitude
1	(1)	Freq	2.462 33 GHz	97.66 dBµV/m
2	(1)	Freq	2.483 50 GHz	60.25 dBµV/m
3	(1)	Freq	2.487 73 GHz	60.03 dBµV/m

Detector mode: Average

Polarity: Horizontal

Agilent

R T

Mkr1 2.460 40 GHz
89.09 dBµV/m

Ref 123 dBµV/m

#Atten 20 dB

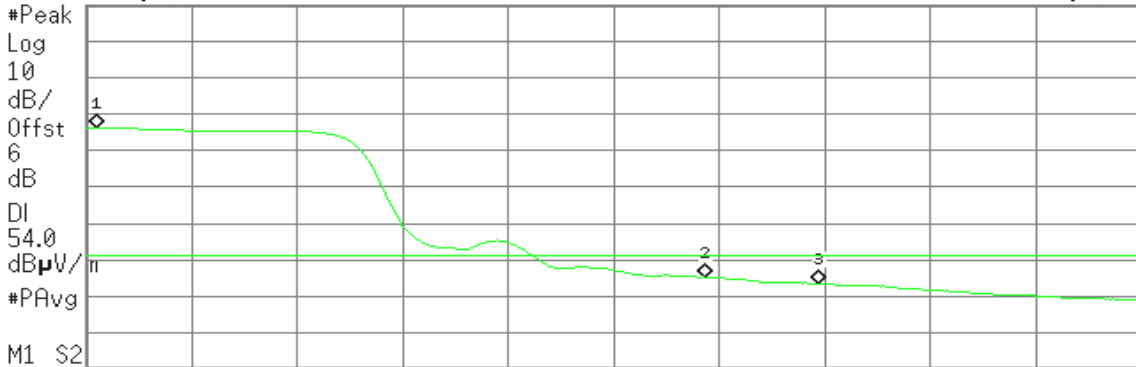

M1 S2
Start 2.460 00 GHz

Stop 2.500 00 GHz

#Res BW 1 MHz

#VBW 300 Hz

Sweep 104 ms (601 pts)

Marker	Trace	Type	X Axis	Amplitude
1	(1)	Freq	2.460 40 GHz	89.09 dBµV/m
2	(1)	Freq	2.483 50 GHz	48.25 dBµV/m
3	(1)	Freq	2.487 73 GHz	46.52 dBµV/m



Test Plot

Conducted Band Edges (IEEE 802.11b mode / CH Low)

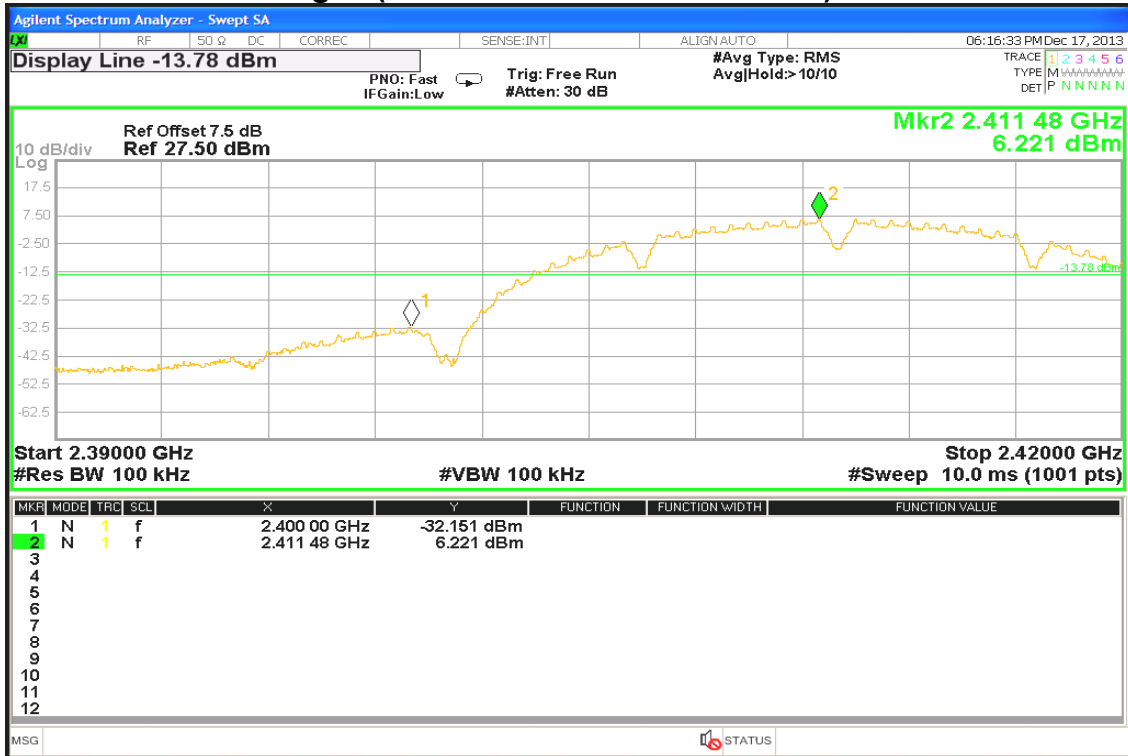

Conducted Band Edges (IEEE 802.11b mode / CH High)

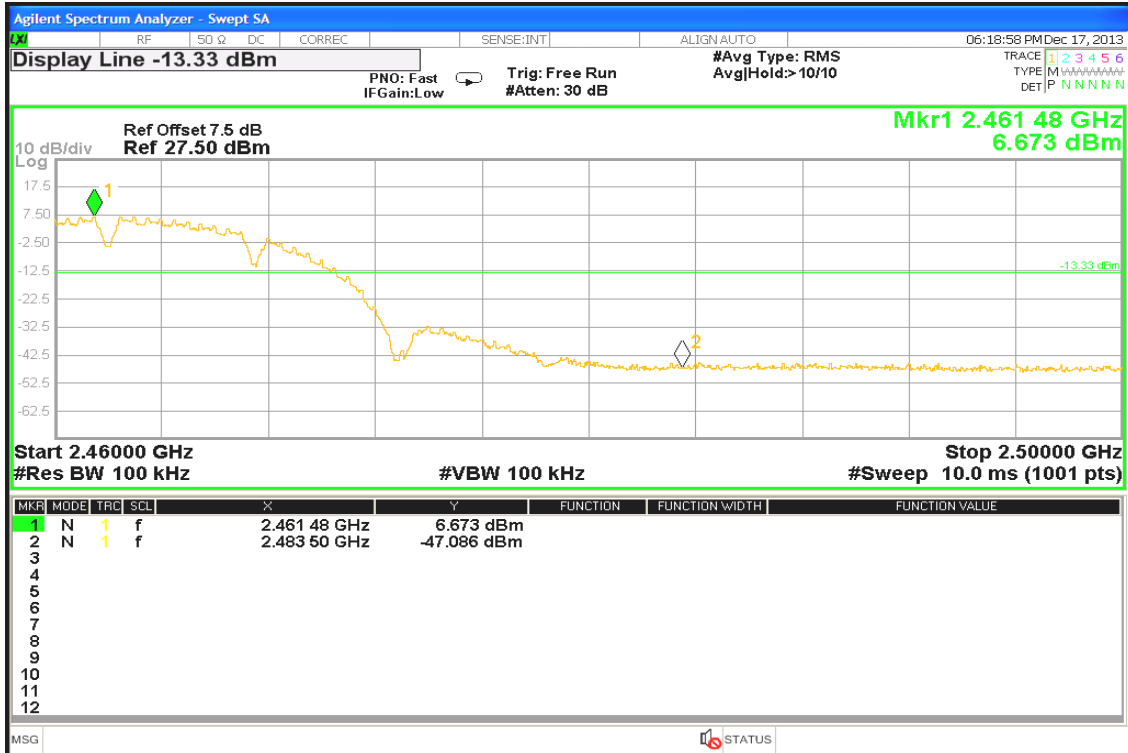



Conducted Band Edges (IEEE 802.11g mode / CH Low)

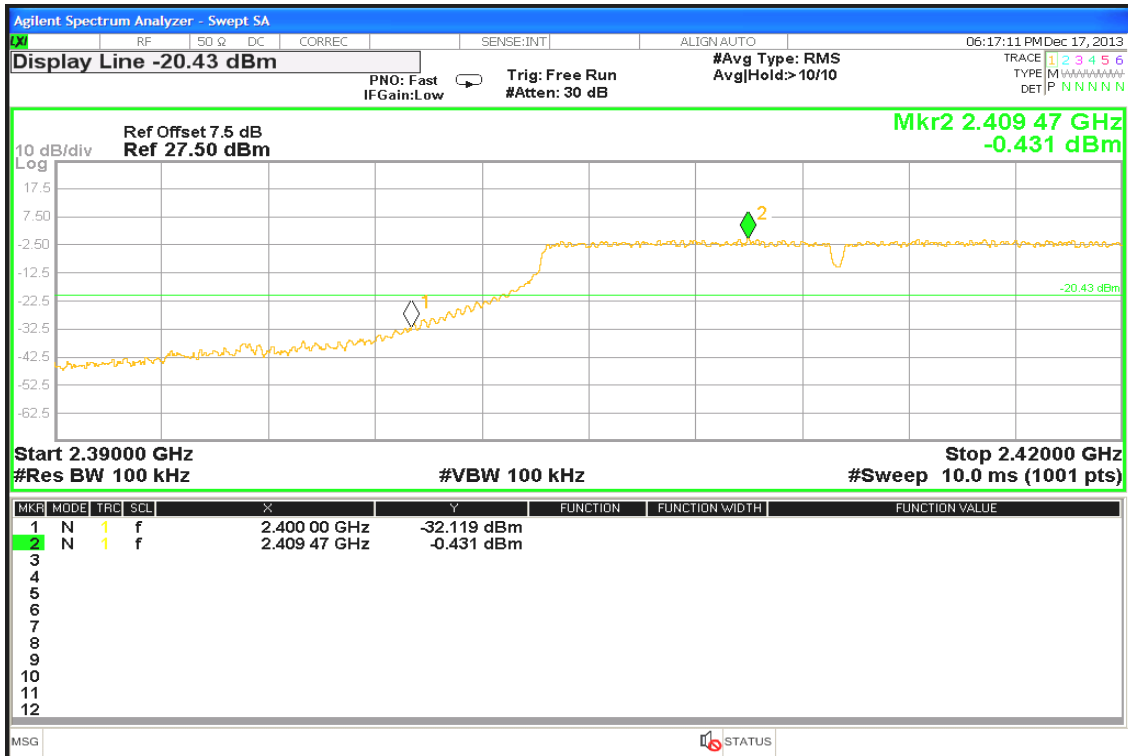

Conducted Band Edges (IEEE 802.11g mode / CH High)

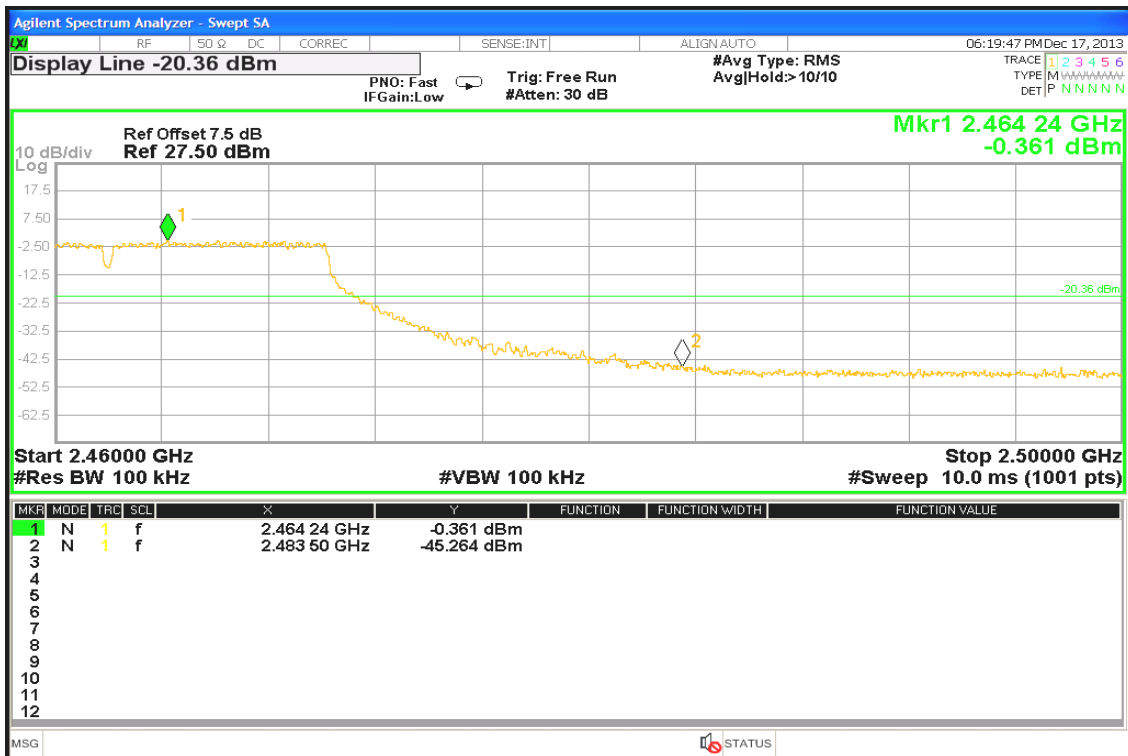



Conducted Band Edges (IEEE 802.11n HT20 mode / CH Low)

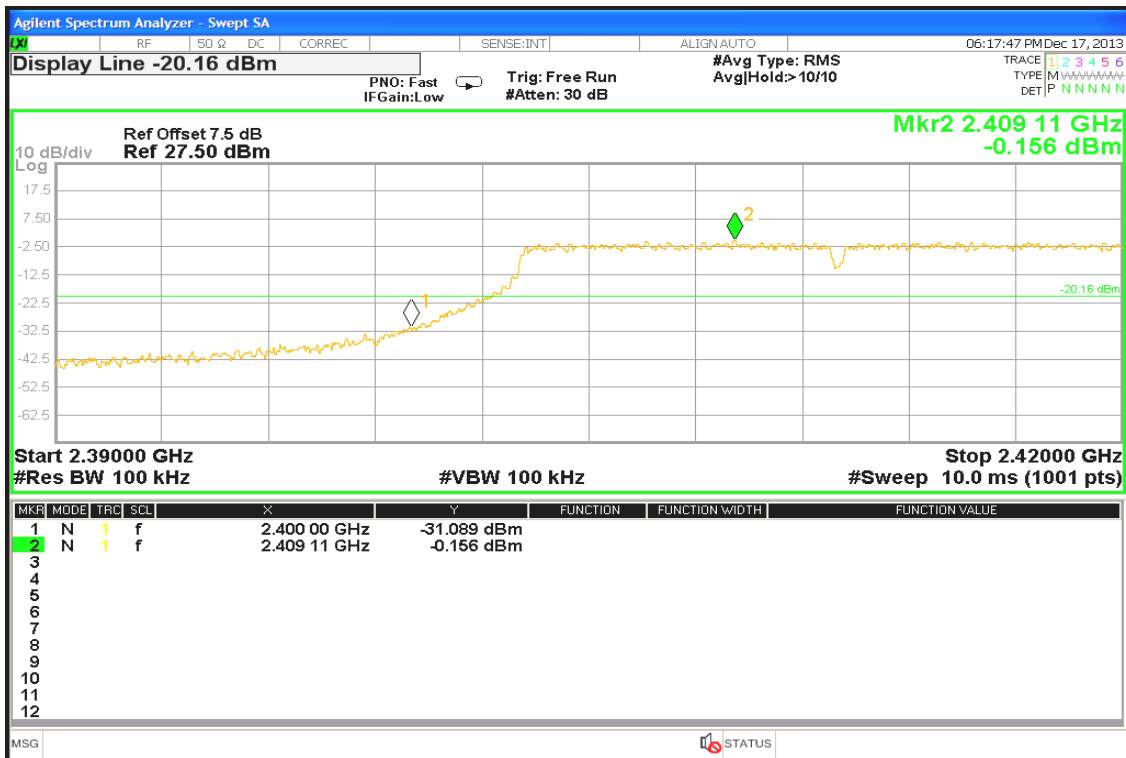

Conducted Band Edges (IEEE 802.11n HT20 mode / CH High)

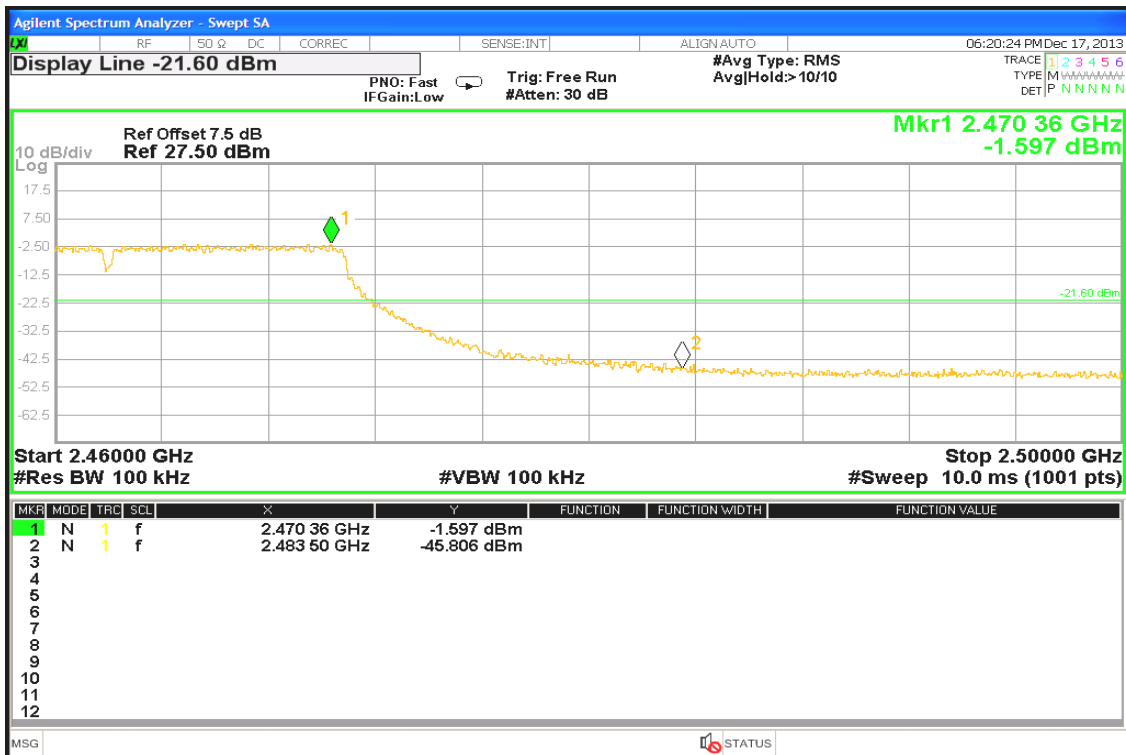



Conducted Band Edges (IEEE 802.11n HT40 mode / CH Low)

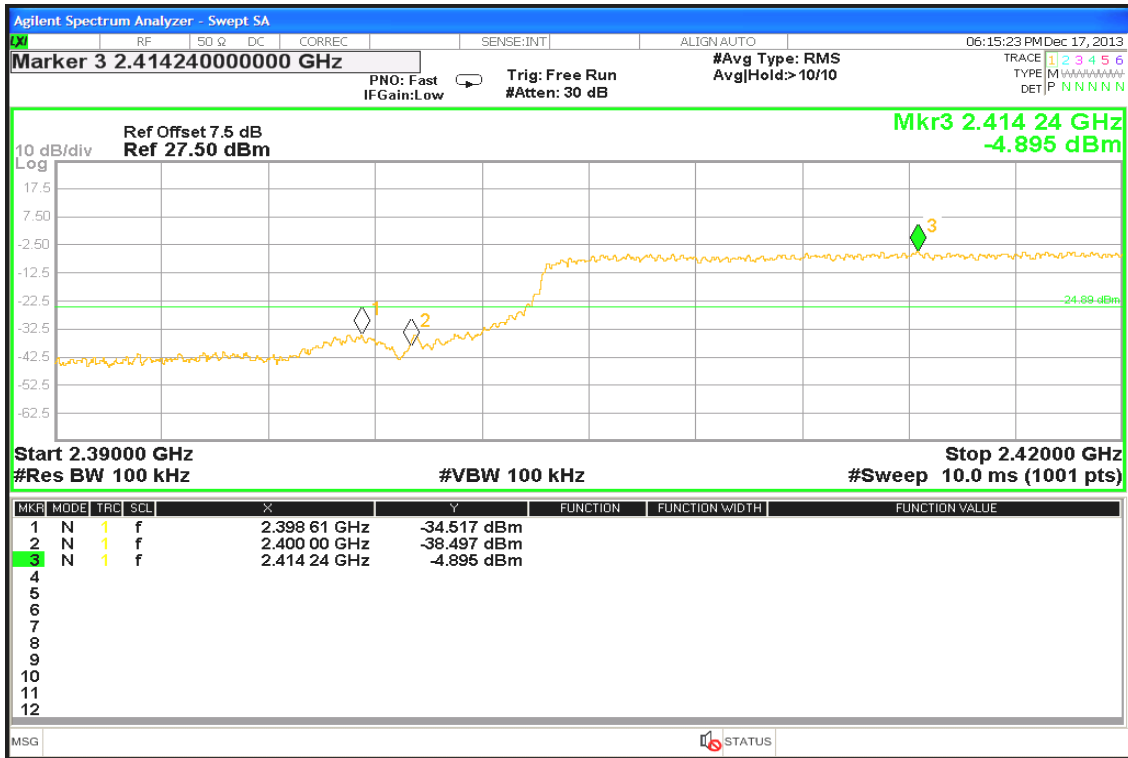

Conducted Band Edges (IEEE 802.11n HT40 mode / CH High)

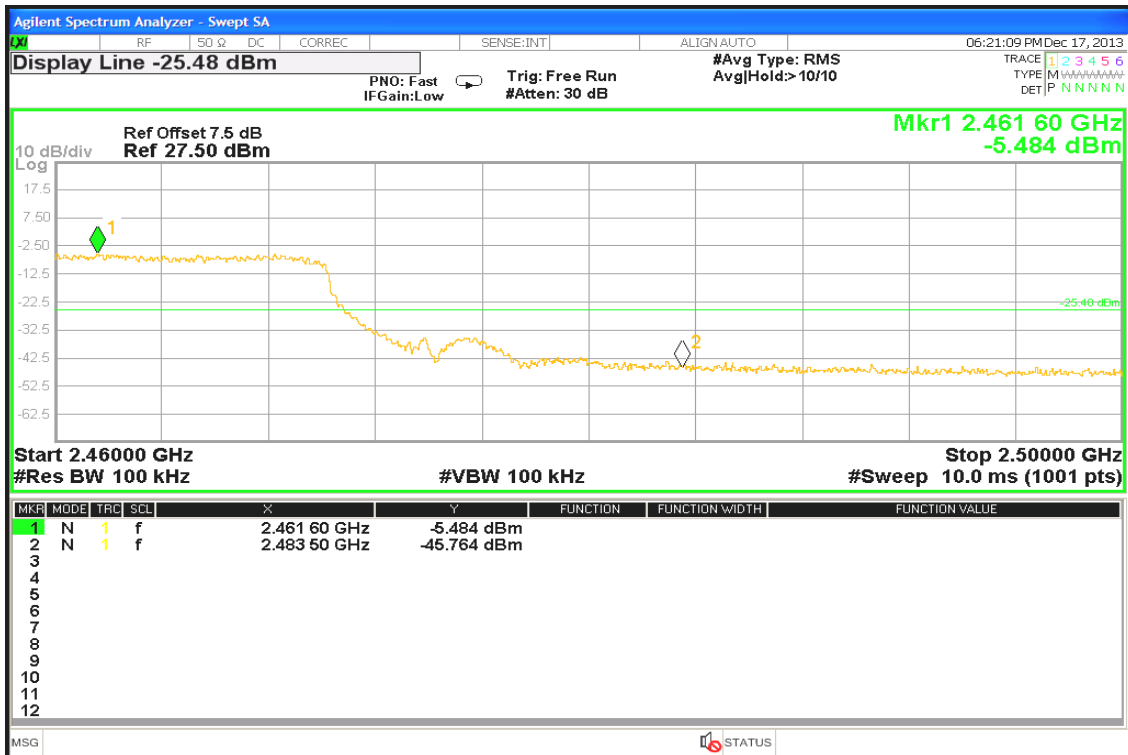



7.5 PEAK POWER SPECTRAL DENSITY

LIMIT

1. According to §15.247(e), for digitally modulated systems, the power spectral density conducted from the intentional radiator to the antenna shall not be greater than 8 dBm in any 3 kHz band during any time interval of continuous transmission.
2. According to §15.247(f), the digital modulation operation of the hybrid system, with the frequency hopping turned off, shall comply with the power density requirements of paragraph (d) of this section.

Test Configuration

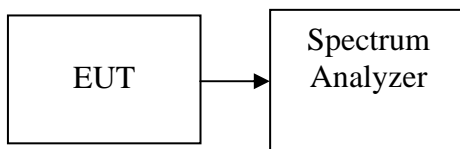

TEST PROCEDURE

Per KDB 558074 v03r01

This procedure must be used if maximum peak conducted output power was used to demonstrate compliance to the fundamental output power limit, and is optional if the maximum (average) conducted output power was used to demonstrate compliance.

1. Set analyzer center frequency to DTS channel center frequency.
2. Set the span to 1.5 times the DTS channel bandwidth.
3. Set the RBW \geq 3 kHz.
4. Set the VBW \geq 3 x RBW.
5. Detector = peak.
6. Sweep time = auto couple.
7. Trace mode = max hold.
8. Allow trace to fully stabilize.

Use the peak marker function to determine the maximum amplitude level.

If measured value exceeds limit, reduce RBW (no less than 3 kHz) and repeat

TEST RESULTS

No non-compliance noted



Test Data

Test mode: IEEE 802.11b mode

Channel	Frequency (MHz)	PPSD (dBm)	Limit (dBm)	Result
Low	2412	-13.231	8.00	PASS
Mid	2437	-13.107		PASS
High	2462	-12.956		PASS

Test mode: IEEE 802.11g mode

Channel	Frequency (MHz)	PPSD (dBm)	Limit (dBm)	Result
Low	2412	-14.560	8.00	PASS
Mid	2437	-15.326		PASS
High	2462	-14.505		PASS

Test mode: IEEE 802.11n HT20 mode

Channel	Frequency (MHz)	PPSD (dBm)	Limit (dBm)	Result
Low	2412	-14.509	8.00	PASS
Mid	2437	-15.094		PASS
High	2462	-15.313		PASS

Test mode: IEEE 802.11n HT40 mode

Channel	Frequency (MHz)	PPSD (dBm)	Limit (dBm)	Result
Low	2422	-15.811	8.00	PASS
Mid	2437	-15.561		PASS
High	2452	-15.655		PASS



Test Plot

IEEE 802.11b mode PPSD (CH Low)



PPSD (CH Mid)





PPSD (CH High)



IEEE 802.11g mode

PPSD (CH Low)

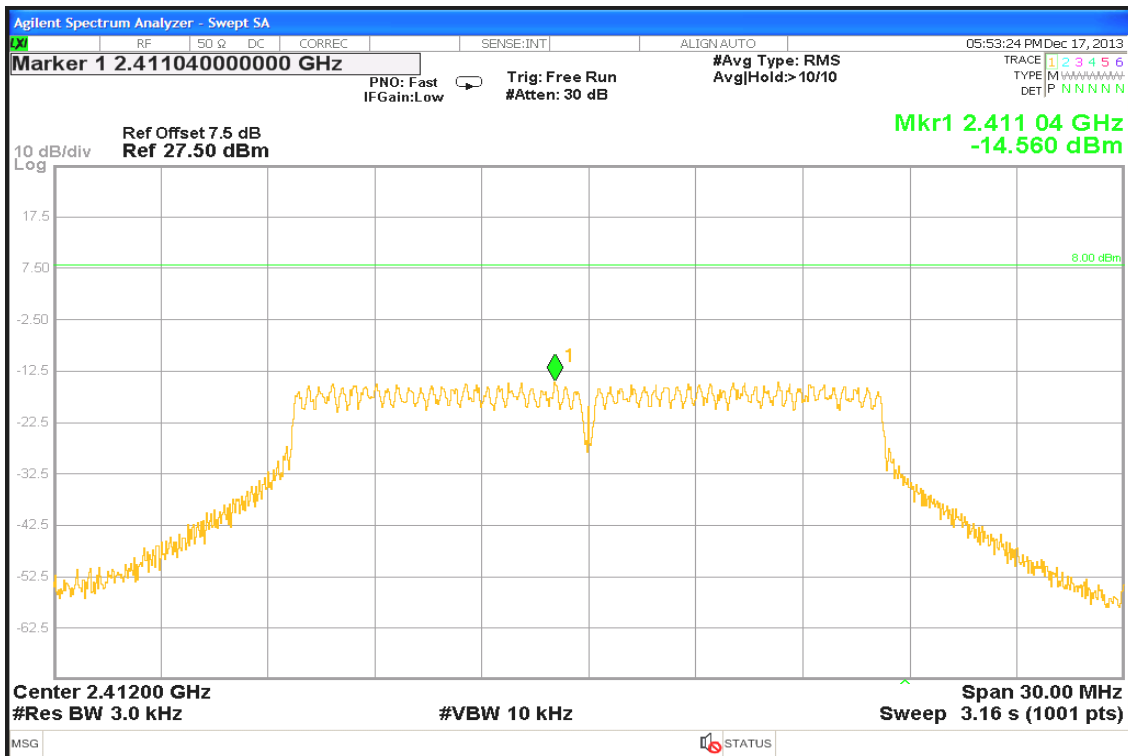



PPSD (CH Mid)

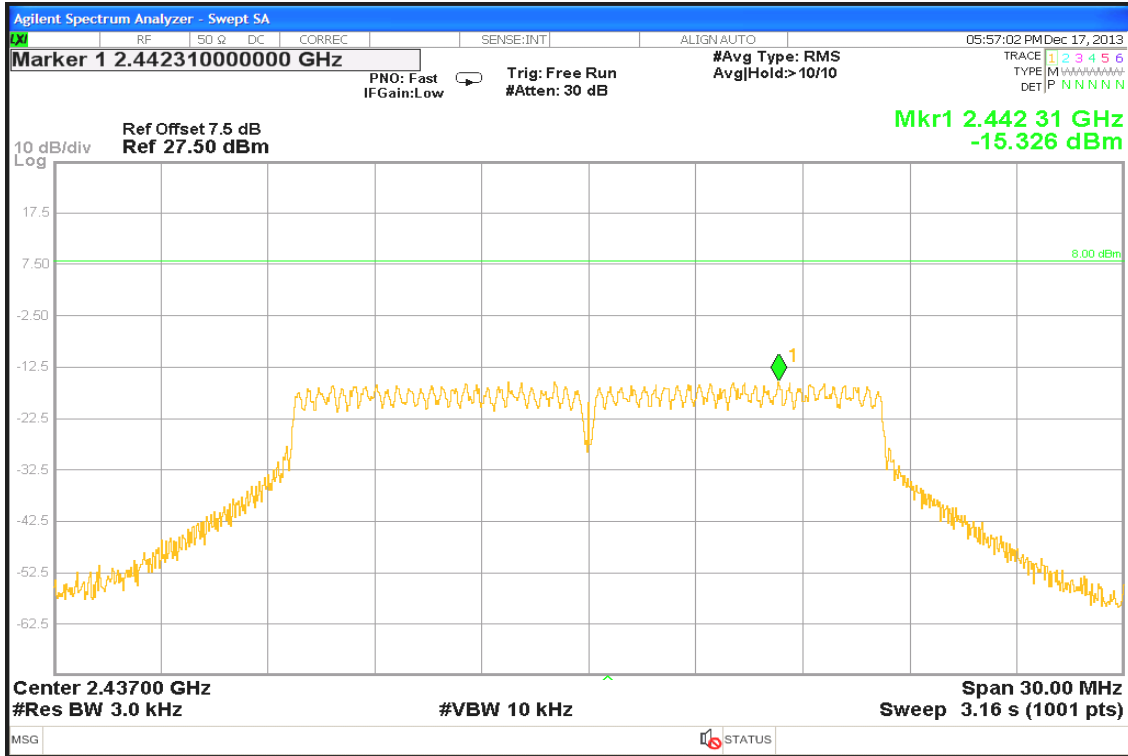

PPSD (CH High)

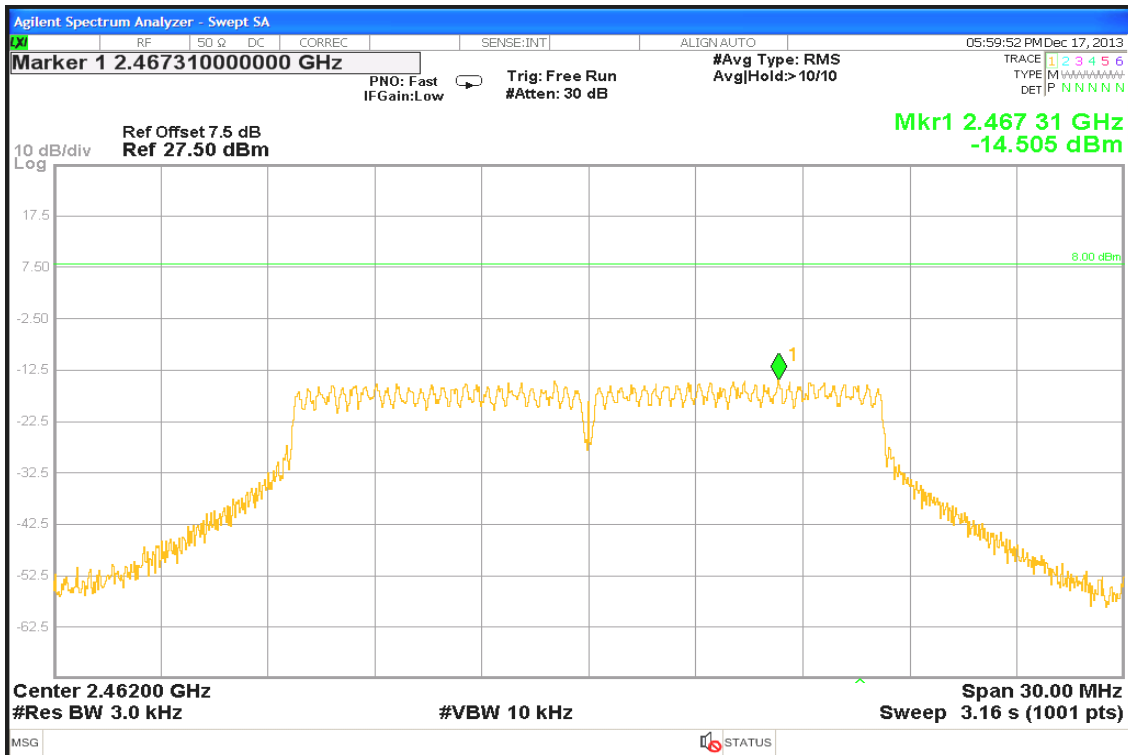



IEEE 802.11n HT20 mode

PPSD (CH Low)

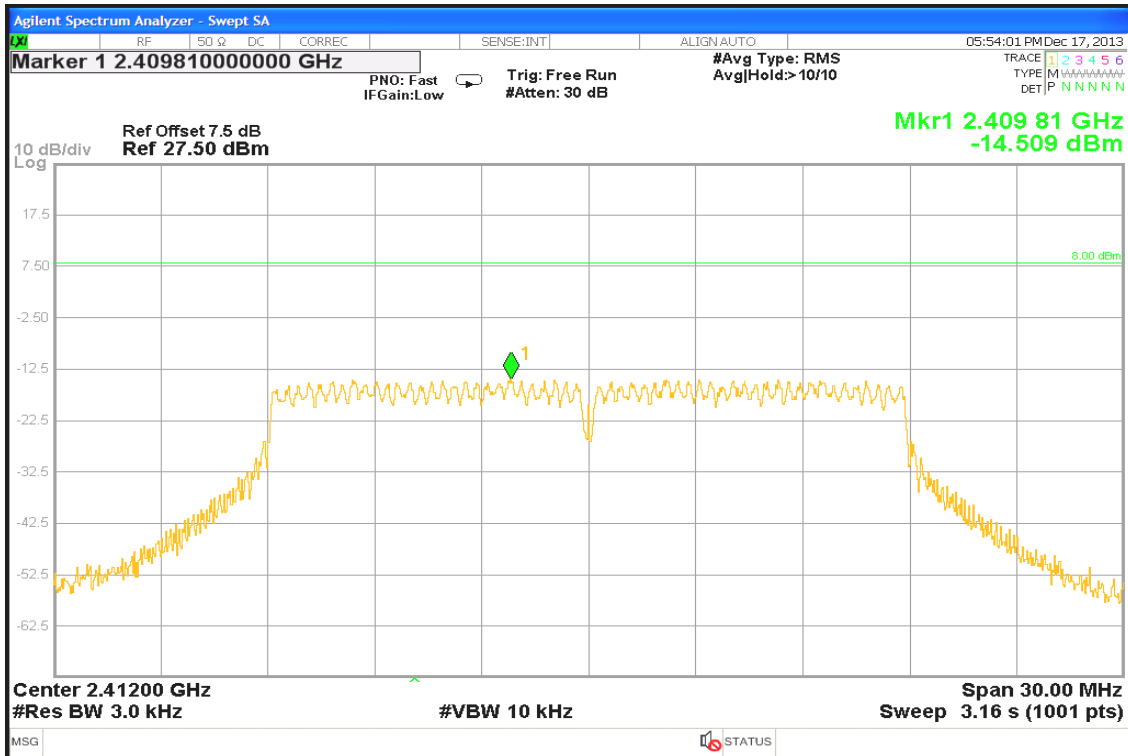

PPSD (CH Mid)

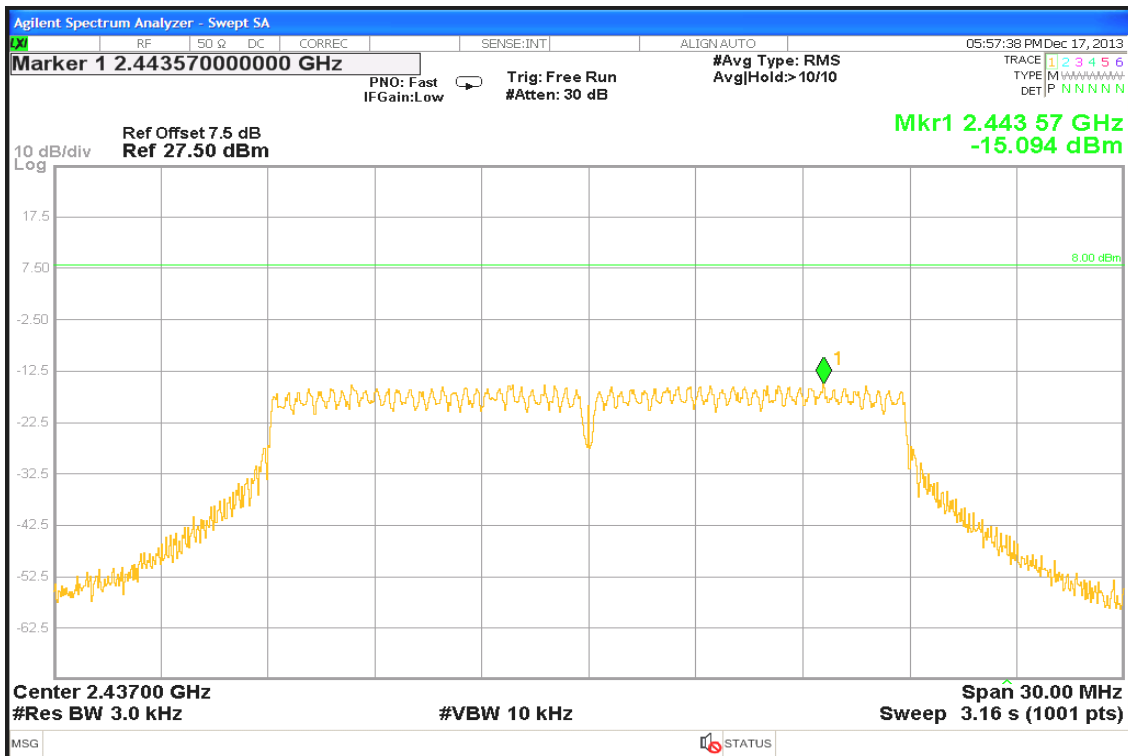



PPSD (CH High)

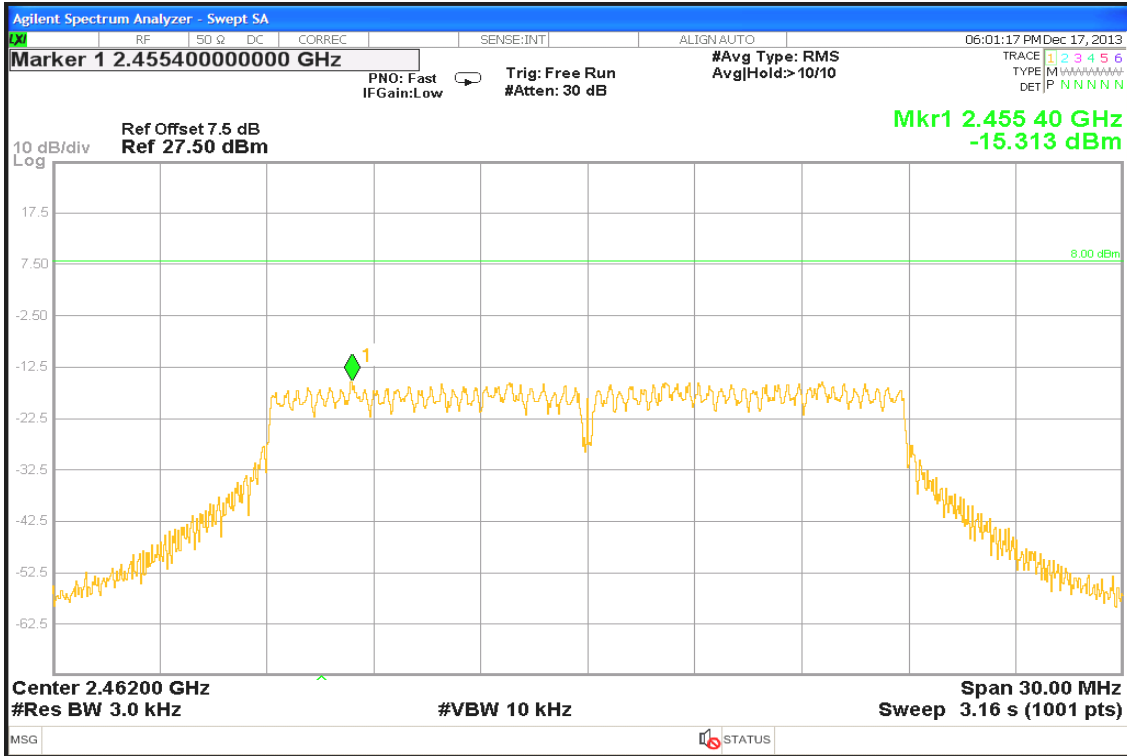

IEEE 802.11n HT40 mode

PPSD (CH Low)

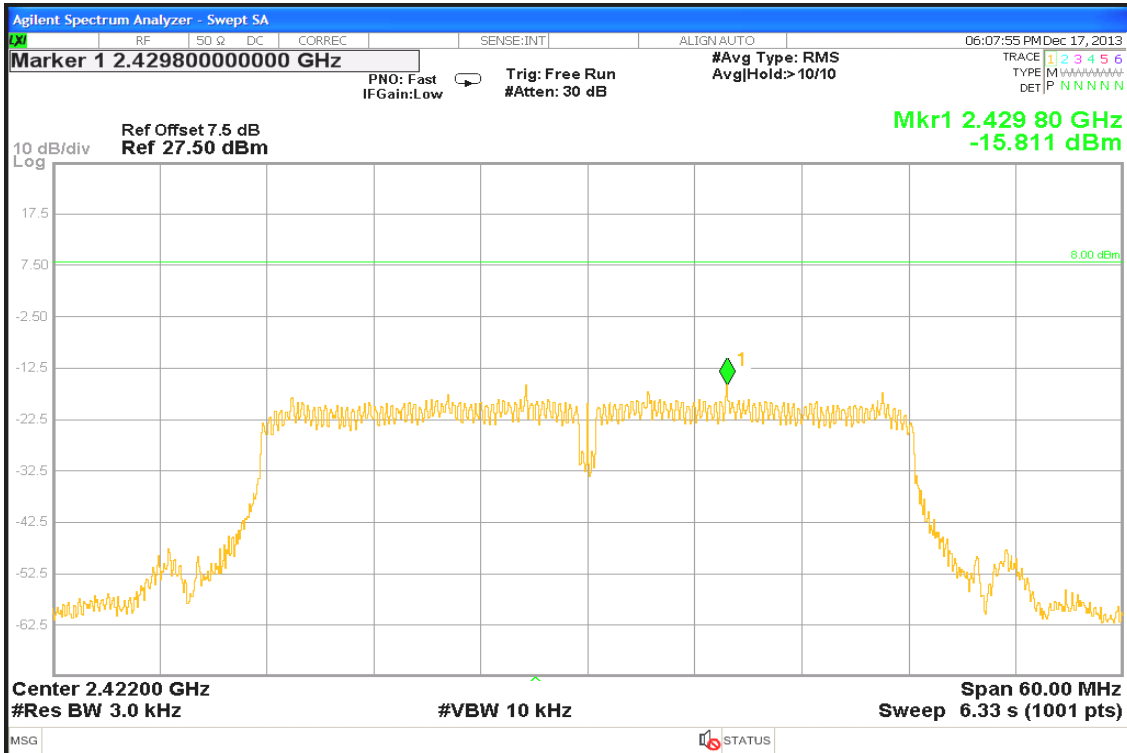



PPSD (CH Mid)

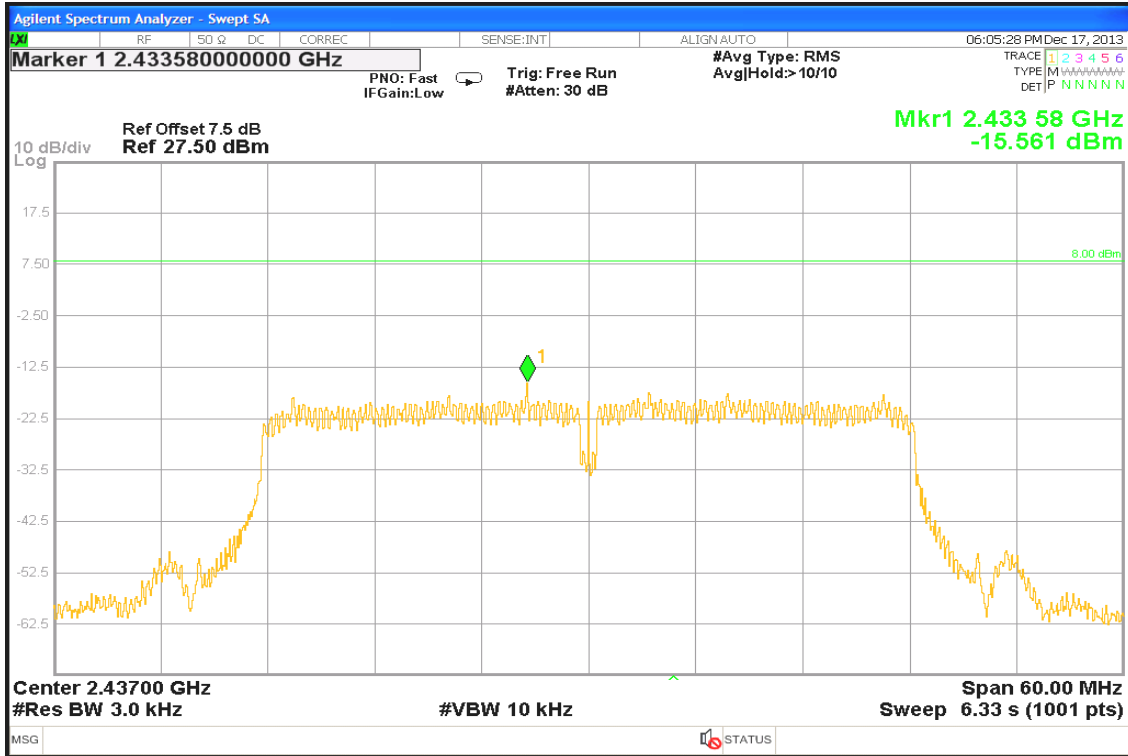

PPSD (CH High)

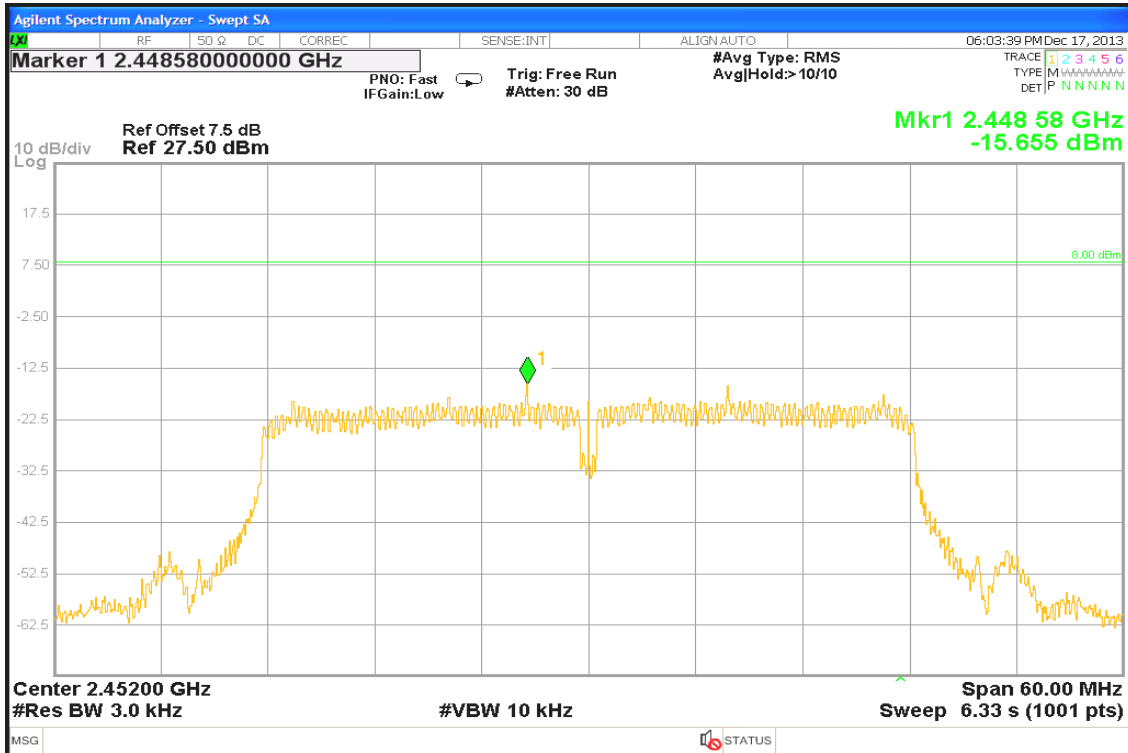



7.6 SPURIOUS EMISSIONS

7.6.1 Conducted Measurement

LIMIT

According to §15.247(d), in any 100 kHz bandwidth outside the frequency bands in which the spread spectrum intentional radiator is operating, the radio frequency power that is produced by the intentional radiator shall be at least 20 dB below that in the 100 kHz bandwidth within the band that contains the highest level of the desired power, based on either an RF conducted or a radiated measurement, provided the transmitter demonstrates compliance with the peak conducted power limits. In addition, radiated emissions which fall in the restricted bands, as defined in §15.205(a), must also comply with the radiated emission limits specified in 15.209(a) (see Section 15.205(c)).

Test Configuration

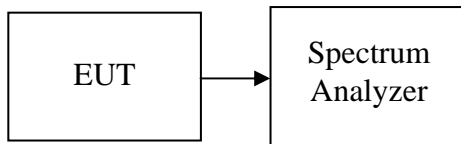

TEST PROCEDURE

Conducted RF measurements of the transmitter output were made to confirm that the EUT antenna port conducted emissions meet the specified limit and to identify any spurious signals that require further investigation or measurements on the radiated emissions site.

The transmitter output is connected to the spectrum analyzer. The resolution bandwidth is set to 100 kHz. The video bandwidth is set to 100 kHz.

Measurements are made over the 30MHz to 26GHz range for IEEE 802.11b/g, 30MHz to 40GHz range for IEEE 802.11a with the transmitter set to the lowest, middle, and highest channels.

TEST RESULTS

No non-compliance noted



Test Plot

IEEE 802.11b mode

CH Low



CH Mid

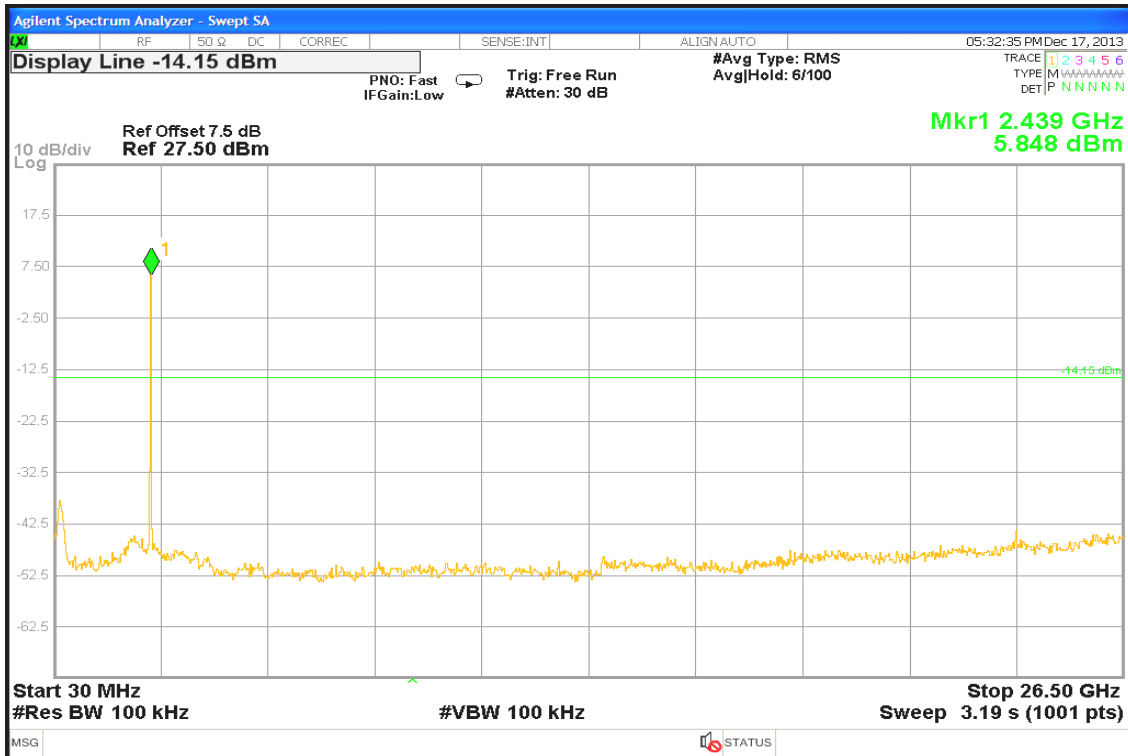



CH High



IEEE 802.11g mode

CH Low





CH Mid

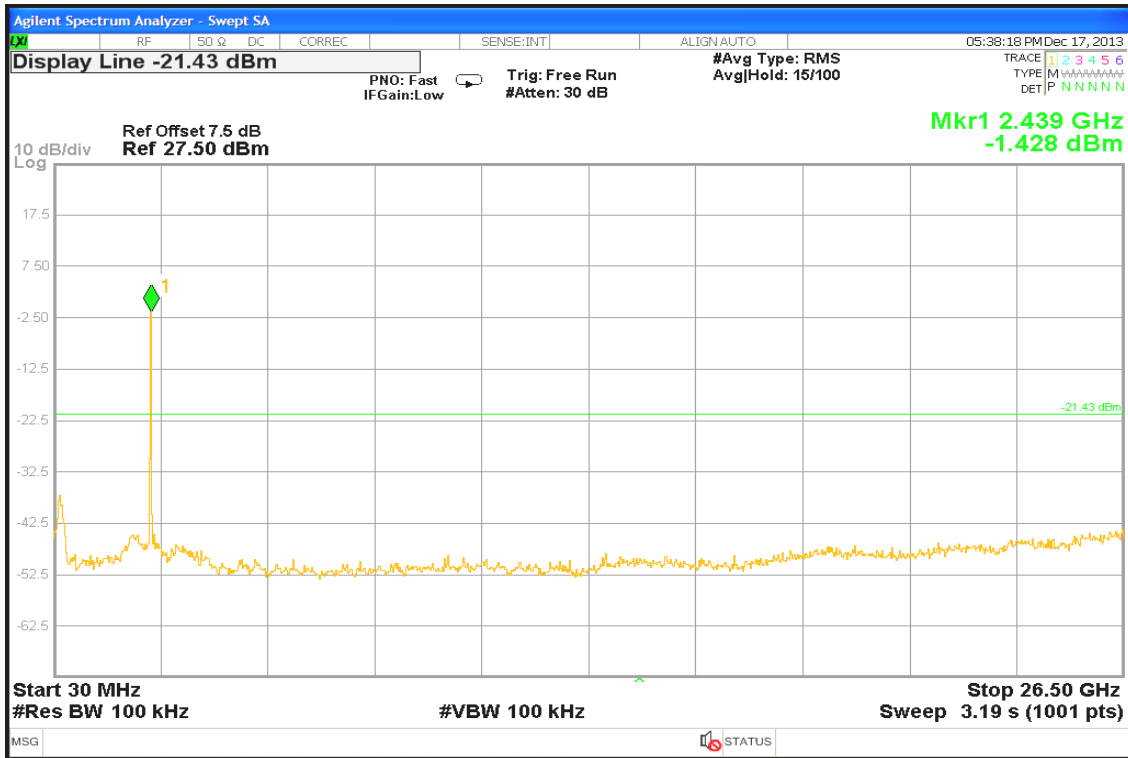

CH High





IEEE 802.11n HT20 mode

CH Low

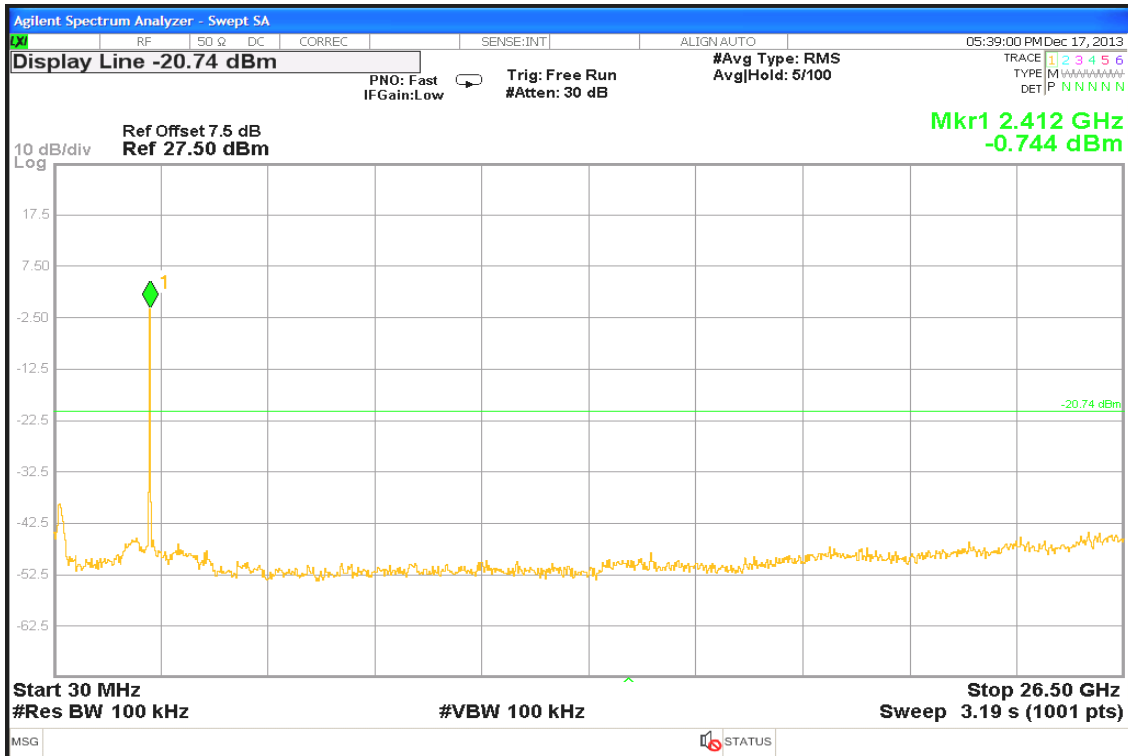

CH Mid





CH High



IEEE 802.11n HT40 mode

CH Low

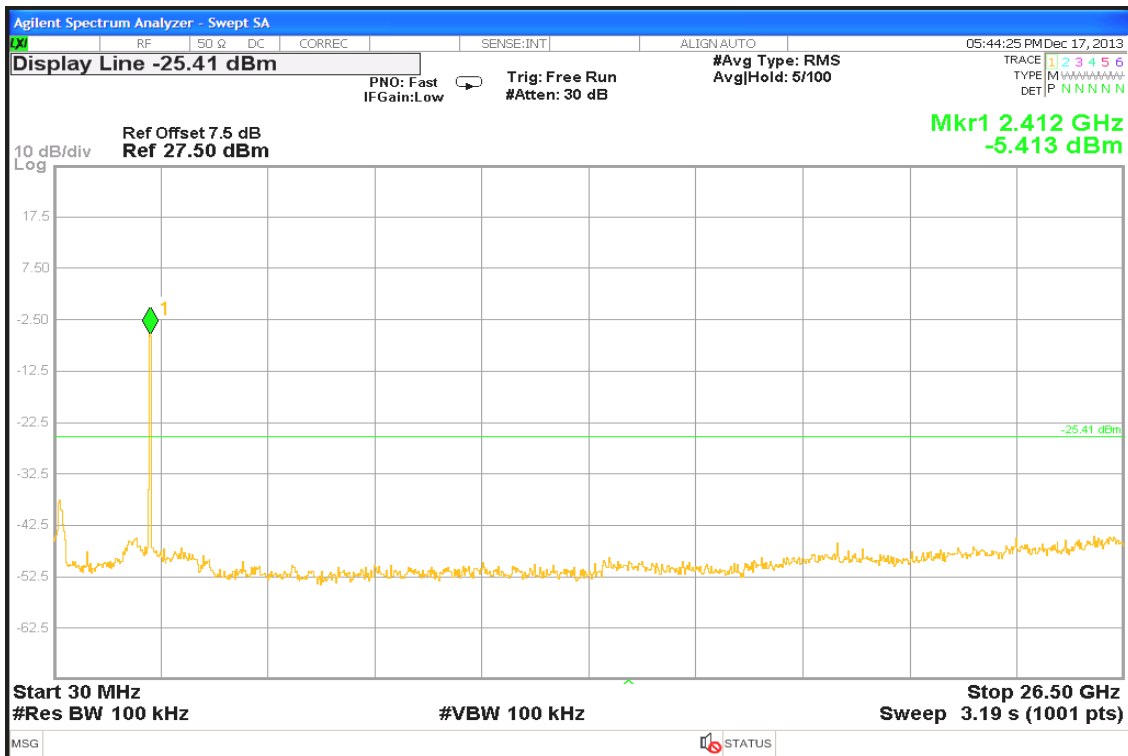



7.6.2 Radiated Emissions

LIMIT

1. According to §15.209(a), except as provided elsewhere in this Subpart, the emissions from an intentional radiator shall not exceed the field strength levels specified in the following table:

Frequency (MHz)	Field Strength (µV/m)	Measurement Distance (m)
0.009 - 0.490	2400/F(kHz)	300
0.490 - 1.705	24000/F(kHz)	30
1.705 – 30.0	30	30
30-88	100	3
88-216	150	3
216-960	200	3
Above 960	500	3

Remark: Except as provided in paragraph (g), fundamental emissions from intentional radiators operating under this Section shall not be located in the frequency bands 54-72 MHz, 76-88 MHz, 174-216 MHz or 470-806 MHz. However, operation within these frequency bands is permitted under other sections of this Part, e.g., Sections 15.231 and 15.241.

2. In the above emission table, the tighter limit applies at the band edges.

Frequency (MHz)	Field Strength (µV/m at 3-meter)	Field Strength (dBµV/m at 3-meter)
0.009 - 0.490	2400/F(kHz) +80	20LOG((2400/F(kHz))+80)
0.490 - 1.705	24000/F(kHz) +40	20LOG((24000/F(kHz))+40)
1.705 – 30.0	30	69.54
30-88	100	40
88-216	150	43.5
216-960	200	46
Above 960	500	54



Test Configuration

9kHz ~ 30MHz

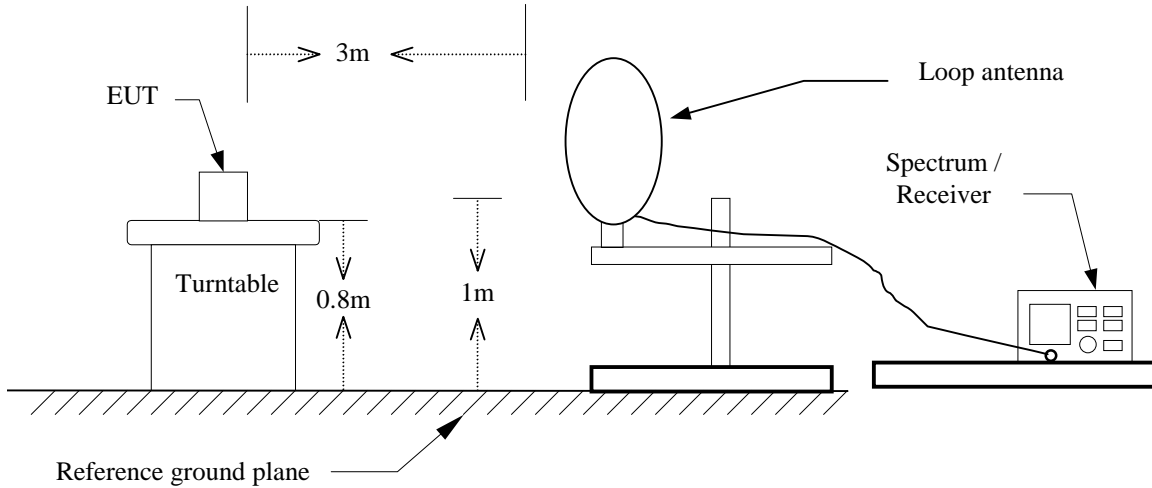

30MHz ~ 1GHz

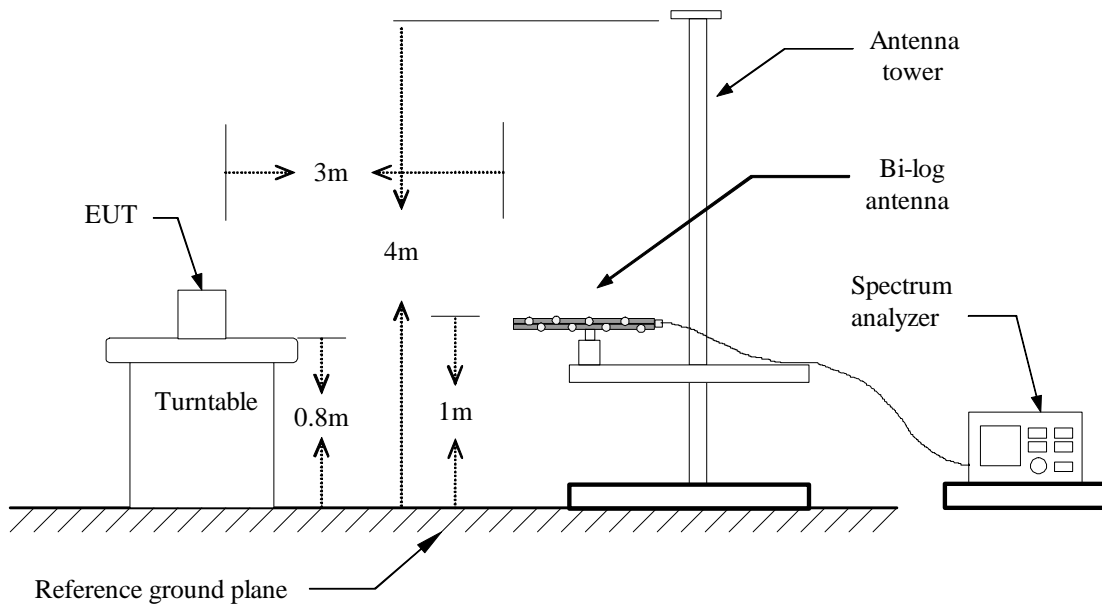



Above 1 GHz

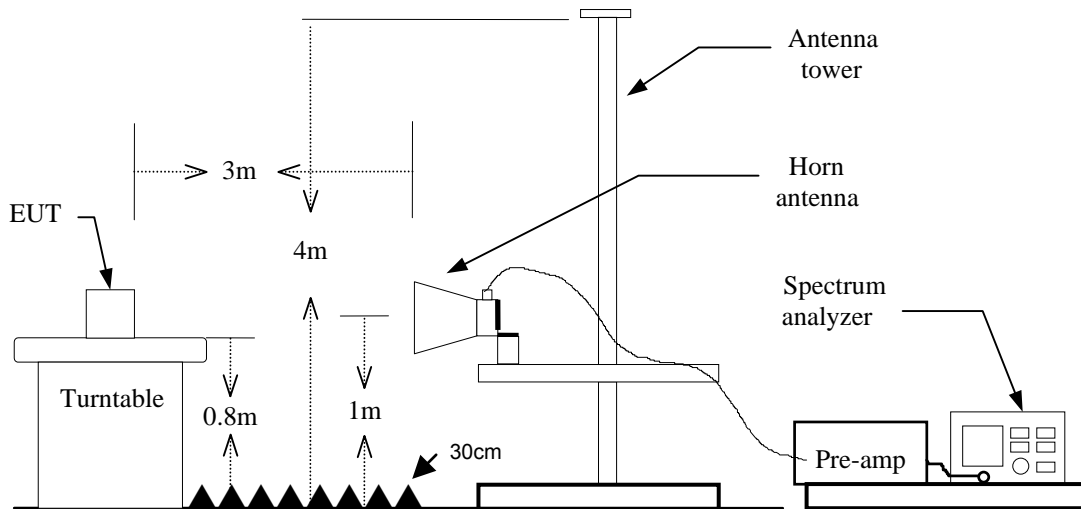

TEST PROCEDURE

1. The EUT is placed on a turntable, which is 0.8m above ground plane.
2. The turntable shall be rotated for 360 degrees to determine the position of maximum emission level.
3. EUT is set 3m away from the receiving antenna, which is varied from 1m to 4m to find out the highest emissions.
4. Maximum procedure was performed on the six highest emissions to ensure EUT compliance.
5. And also, each emission was to be maximized by changing the polarization of receiving antenna both horizontal and vertical.
6. Set the spectrum analyzer in the following setting as:

Below 30MHz

RBW=10kHz / VBW=30kHz / Sweep=AUTO

30 ~ 1000MHz:

RBW=100kHz / VBW=300kHz / Sweep=AUTO

Above 1GHz:

- a) PEAK: RBW=1MHz / VBW=3MHz / Sweep=AUTO
- b) AVERAGE: RBW=1MHz / VBW=300Hz / Sweep=AUTO

7. Repeat above procedures until the measurements for all frequencies are complete.



DATA SAMPLE

Below 1 GHz

Frequency (MHz)	Reading (dBuV)	Correction Factor (dB/m)	Result (dBuV/m)	Limit (dBuV/m)	Margin (dB)	Ant. Pol. (H/V)	Remark
x.xx	43.20	-20.71	22.49	40.00	-17.51	V	QP

Frequency (MHz) = Emission frequency in MHz
 Reading (dBuV) = Uncorrected Analyzer / Receiver reading
 Correction Factor (dB/m) = Antenna factor – Amplifier gain + Cable loss
 Result (dBuV/m) = Reading (dBuV) + Corr. Factor (dB/m)
 Limit (dBuV/m) = Limit stated in standard
 Margin (dB) = Result (dBuV/m) – Limit (dBuV/m)
 Q.P. = Quasi-Peak

Above 1 GHz

Freq. (MHz)	Reading (dBuV)	Correct Factor (dB/m)	Result (dBuV/m)	Limit (dBuV/m)	Margin (dB)	Ant. Pol. H/V	Remark
x.xx	45.25	6.91	52.16	74.00	-21.84	H	peak
x.xx	32.33	6.91	39.24	54.00	-14.76	H	AVG

Frequency (MHz) = Emission frequency in MHz
 Reading (dBuV) = Uncorrected Analyzer / Receiver reading
 Correction Factor (dB/m) = Antenna factor + Cable loss – Amplifier gain
 Result (dBuV/m) = Reading (dBuV) + Corr. Factor (dB/m)
 Limit (dBuV/m) = Limit stated in standard
 Margin (dB) = Result (dBuV/m) – Limit (dBuV/m)



Below 1 GHz

Operation Mode: LAN Mode **Test Date:** 2013/12/23
Temperature: 26°C **Tested by:** Louis Shen
Humidity: 56% RH **Polarity:** Ver. / Hor.

Frequency (MHz)	Reading (dBuV)	Correction Factor (dB/m)	Result (dBuV/m)	Limit (dBuV/m)	Margin (dB)	Ant. Pol. (H/V)	Remark
32.9099	25.60	-10.65	14.95	40.00	-25.05	V	QP
100.0001	48.30	-16.48	31.82	43.50	-11.68	V	QP
200.0042	53.90	-16.64	37.26	43.50	-6.24	V	QP
400.0071	44.10	-10.21	33.89	46.00	-12.11	V	QP
600.0089	50.10	-8.00	42.10	46.00	-3.90	V	QP
800.0124	44.70	-5.68	39.02	46.00	-6.98	V	QP
200.0001	46.90	-16.64	30.26	43.50	-13.24	H	QP
400.0100	45.50	-10.21	35.29	46.00	-10.71	H	QP
480.0100	38.80	-9.51	29.29	46.00	-16.71	H	QP
600.0085	44.10	-8.00	36.10	46.00	-9.90	H	QP
700.0100	34.40	-7.09	27.31	46.00	-18.69	H	QP
800.0140	33.50	-5.68	27.82	46.00	-18.18	H	QP

Remark:

1. No emission found between lowest internal used/generated frequency to 30MHz (9kHz~30MHz).
2. Radiated emissions measured in frequency range from 30 MHz to 1000MHz were made with an instrument using peak/quasi-peak detector mode.
3. Quasi-peak test would be performed if the peak result were greater than the quasi-peak limit or as required by the applicant.
4. Measurements above show only up to 6 maximum emissions noted, or would be lesser, with " N/A " remark, if no specific emissions from the EUT are recorded (ie: margin>20dB from the applicable limit) and considered that's already beyond the background noise floor.
5. Margin (dB) = Remark result (dBuV/m) – Quasi-peak limit (dBuV/m).



Operation Mode: Wifi Mode

Test Date: 2013/12/23

Temperature: 26°C

Tested by: Louis Shen

Humidity: 56% RH

Polarity: Ver. / Hor.

Frequency (MHz)	Reading (dBuV)	Correction Factor (dB/m)	Result (dBuV/m)	Limit (dBuV/m)	Margin (dB)	Ant. Pol. (H/V)	Remark
81.4700	41.80	-19.71	22.09	40.00	-17.91	V	QP
182.3000	42.80	-17.34	25.46	43.50	-18.04	V	QP
200.0067	52.30	-16.64	35.66	43.50	-7.84	V	QP
400.0100	45.10	-10.21	34.89	46.00	-11.11	V	QP
600.0000	48.20	-8.00	40.20	46.00	-5.80	V	QP
699.8500	35.50	-7.09	28.41	46.00	-17.59	V	QP
200.0002	50.80	-16.64	34.16	43.50	-9.34	H	QP
400.0077	47.50	-10.21	37.29	46.00	-8.71	H	QP
450.0091	37.30	-9.91	27.39	46.00	-18.61	H	QP
600.0102	44.40	-8.00	36.40	46.00	-9.60	H	QP
699.9900	32.20	-7.09	25.11	46.00	-20.89	H	QP
800.0135	35.70	-5.68	30.02	46.00	-15.98	H	QP

Remark:

1. No emission found between lowest internal used/generated frequency to 30MHz (9kHz~30MHz).
2. Radiated emissions measured in frequency range from 30 MHz to 1000MHz were made with an instrument using peak/quasi-peak detector mode.
3. Quasi-peak test would be performed if the peak result were greater than the quasi-peak limit or as required by the applicant.
4. Measurements above show only up to 6 maximum emissions noted, or would be lesser, with " N/A " remark, if no specific emissions from the EUT are recorded (ie: margin>20dB from the applicable limit) and considered that's already beyond the background noise floor.
5. Margin (dB) = Remark result (dBuV/m) – Quasi-peak limit (dBuV/m).



Above 1 GHz

Operation Mode: TX / IEEE 802.11b mode / CH Low **Test Date:** 2013/12/18

Temperature: 26°C

Tested by: Francis Lee

Humidity: 56%RH

Polarity: Ver. / Hor.

Freq. (MHz)	Reading (dBuV)	Correct Factor (dB/m)	Result (dBuV/m)	Limit (dBuV/m)	Margin (dB)	Ant. Pol H/V	Remark
1594.000	51.45	-4.82	46.63	74.00	-27.37	V	peak
2132.000	52.59	-2.85	49.74	74.00	-24.26	V	peak
2490.000	54.89	-1.00	53.89	74.00	-20.11	V	peak
2490.000	46.77	-1.00	45.77	54.00	-8.23	V	AVG
3700.000	41.31	2.47	43.78	74.00	-30.22	V	peak
4825.000	43.14	2.68	45.82	74.00	-28.18	V	peak
7605.000	38.90	11.85	50.75	74.00	-23.25	V	peak
1398.000	50.91	-6.95	43.96	74.00	-30.04	H	peak
2204.000	49.51	-3.67	45.84	74.00	-28.16	H	peak
2862.000	49.78	-2.01	47.77	74.00	-26.23	H	peak
3775.000	41.54	4.77	46.31	74.00	-27.69	H	peak
5595.000	39.43	9.18	48.61	74.00	-25.39	H	peak
7325.000	38.80	11.69	50.49	74.00	-23.51	H	peak

Remark:

1. Measuring frequencies from 1 GHz to the 10th harmonic of highest fundamental frequency.
2. Radiated emissions measured in frequency above 1000MHz were made with an instrument using peak/average detector mode.
3. Average test would be performed if the peak result were greater than the average limit.
4. Data of measurement within this frequency range shown " --- " in the table above means the reading of emissions are attenuated more than 20dB below the permissible limits or the field strength is too small to be measured.
5. Measurements above show only up to 6 maximum emissions noted, or would be lesser, with " N/A " remark, if no specific emissions from the EUT are recorded (ie: margin>20dB from the applicable limit) and considered that's already beyond the background noise floor.
6. Margin (dB) = Remark result (dBuV/m) – Average limit (dBuV/m).



Operation Mode: TX / IEEE 802.11b mode / CH Mid **Test Date:** 2013/12/18

Temperature: 26°C

Tested by: Francis Lee

Humidity: 56%RH

Polarity: Ver. / Hor.

Freq. (MHz)	Reading (dBuV)	Correct Factor (dB/m)	Result (dBuV/m)	Limit (dBuV/m)	Margin (dB)	Ant. Pol H/V	Remark
1486.000	50.89	-5.45	45.44	74.00	-28.56	V	peak
2132.000	51.58	-2.85	48.73	74.00	-25.27	V	peak
2514.000	54.72	-1.10	53.62	74.00	-20.38	V	peak
2514.000	47.48	-1.10	46.38	54.00	-7.62	V	AVG
3965.000	40.37	2.78	43.15	74.00	-30.85	V	peak
4875.000	43.35	3.81	47.16	74.00	-26.84	V	peak
7100.000	38.81	9.54	48.35	74.00	-25.65	V	peak
1422.000	51.17	-7.36	43.81	74.00	-30.19	H	peak
2110.000	49.89	-3.76	46.13	74.00	-27.87	H	peak
2724.000	49.62	-3.16	46.46	74.00	-27.54	H	peak
3795.000	40.17	5.03	45.20	74.00	-28.80	H	peak
4700.000	39.74	7.31	47.05	74.00	-26.95	H	peak
7230.000	38.27	10.89	49.16	74.00	-24.84	H	peak

Remark:

1. Measuring frequencies from 1 GHz to the 10th harmonic of highest fundamental frequency.
2. Radiated emissions measured in frequency above 1000MHz were made with an instrument using peak/average detector mode.
3. Average test would be performed if the peak result were greater than the average limit.
4. Data of measurement within this frequency range shown " --- " in the table above means the reading of emissions are attenuated more than 20dB below the permissible limits or the field strength is too small to be measured.
5. Measurements above show only up to 6 maximum emissions noted, or would be lesser, with " N/A " remark, if no specific emissions from the EUT are recorded (ie: margin>20dB from the applicable limit) and considered that's already beyond the background noise floor.
6. Margin (dB) = Remark result (dBuV/m) – Average limit (dBuV/m).



Operation Mode:TX / IEEE 802.11b mode / CH High **Test Date:** 2013/12/18

Temperature: 26°C

Tested by: Francis Lee

Humidity: 56%RH

Polarity: Ver. / Hor.

Freq. (MHz)	Reading (dBuV)	Correct Factor (dB/m)	Result (dBuV/m)	Limit (dBuV/m)	Margin (dB)	Ant. Pol H/V	Remark
1460.000	51.71	-5.81	45.90	74.00	-28.10	V	peak
2132.000	55.02	-2.85	52.17	74.00	-21.83	V	peak
2132.000	42.36	-2.85	39.51	54.00	-14.49	V	AVG
2678.000	50.79	-1.62	49.17	74.00	-24.83	V	peak
3540.000	41.00	2.51	43.51	74.00	-30.49	V	peak
4925.000	44.76	4.61	49.37	74.00	-24.63	V	peak
7430.000	38.45	11.37	49.82	74.00	-24.18	V	peak
1400.000	51.19	-6.90	44.29	74.00	-29.71	H	peak
2160.000	50.40	-3.65	46.75	74.00	-27.25	H	peak
2890.000	48.79	-1.80	46.99	74.00	-27.01	H	peak
4270.000	40.39	7.16	47.55	74.00	-26.45	H	peak
4925.000	41.54	7.26	48.80	74.00	-25.20	H	peak
7240.000	39.26	11.02	50.28	74.00	-23.72	H	peak

Remark:

1. Measuring frequencies from 1 GHz to the 10th harmonic of highest fundamental frequency.
2. Radiated emissions measured in frequency above 1000MHz were made with an instrument using peak/average detector mode.
3. Average test would be performed if the peak result were greater than the average limit.
4. Data of measurement within this frequency range shown " --- " in the table above means the reading of emissions are attenuated more than 20dB below the permissible limits or the field strength is too small to be measured.
5. Measurements above show only up to 6 maximum emissions noted, or would be lesser, with " N/A " remark, if no specific emissions from the EUT are recorded (ie: margin>20dB from the applicable limit) and considered that's already beyond the background noise floor.
6. Margin (dB) = Remark result (dBuV/m) – Average limit (dBuV/m).



Operation Mode:TX / IEEE 802.11g mode / CH Low **Test Date:** 2013/12/18

Temperature: 26°C

Tested by: Francis Lee

Humidity: 56%RH

Polarity: Ver. / Hor.

Freq. (MHz)	Reading (dBuV)	Correct Factor (dB/m)	Result (dBuV/m)	Limit (dBuV/m)	Margin (dB)	Ant. Pol H/V	Remark
1460.000	51.23	-5.81	45.42	74.00	-28.58	V	peak
2004.000	50.11	-1.39	48.72	74.00	-25.28	V	peak
2504.000	54.04	-0.98	53.06	74.00	-20.94	V	peak
2504.000	44.31	-0.98	43.33	54.00	-10.67	V	AVG
3620.000	40.32	2.84	43.16	74.00	-30.84	V	peak
5060.000	39.71	4.75	44.46	74.00	-29.54	V	peak
7045.000	39.96	8.97	48.93	74.00	-25.07	V	peak
1418.000	51.41	-7.28	44.13	74.00	-29.87	H	peak
2186.000	50.26	-3.59	46.67	74.00	-27.33	H	peak
2786.000	49.04	-2.60	46.44	74.00	-27.56	H	peak
3895.000	40.39	5.21	45.60	74.00	-28.40	H	peak
4910.000	40.77	7.19	47.96	74.00	-26.04	H	peak
7295.000	38.80	11.75	50.55	74.00	-23.45	H	peak

Remark:

1. Measuring frequencies from 1 GHz to the 10th harmonic of highest fundamental frequency.
2. Radiated emissions measured in frequency above 1000MHz were made with an instrument using peak/average detector mode.
3. Average test would be performed if the peak result were greater than the average limit.
4. Data of measurement within this frequency range shown " --- " in the table above means the reading of emissions are attenuated more than 20dB below the permissible limits or the field strength is too small to be measured.
5. Measurements above show only up to 6 maximum emissions noted, or would be lesser, with " N/A " remark, if no specific emissions from the EUT are recorded (ie: margin>20dB from the applicable limit) and considered that's already beyond the background noise floor.
6. Margin (dB) = Remark result (dBuV/m) – Average limit (dBuV/m).



Operation Mode:TX / IEEE 802.11g mode / CH Mid **Test Date:** 2013/12/18

Temperature: 26°C

Tested by: Francis Lee

Humidity: 56%RH

Polarity: Ver. / Hor.

Freq. (MHz)	Reading (dBuV)	Correct Factor (dB/m)	Result (dBuV/m)	Limit (dBuV/m)	Margin (dB)	Ant. Pol H/V	Remark
1984.000	50.39	-1.55	48.84	74.00	-25.16	V	peak
2354.000	52.37	-1.61	50.76	74.00	-23.24	V	peak
2516.000	57.41	-1.13	56.28	74.00	-17.72	V	peak
2516.000	50.94	-1.13	49.81	54.00	-4.19	V	AVG
3760.000	41.13	3.20	44.33	74.00	-29.67	V	peak
5160.000	39.76	5.07	44.83	74.00	-29.17	V	peak
7560.000	38.55	11.76	50.31	74.00	-23.69	V	peak
1396.000	50.92	-7.00	43.92	74.00	-30.08	H	peak
2166.000	50.22	-3.63	46.59	74.00	-27.41	H	peak
2586.000	50.60	-3.42	47.18	74.00	-26.82	H	peak
4310.000	39.78	7.59	47.37	74.00	-26.63	H	peak
5605.000	39.26	9.14	48.40	74.00	-25.60	H	peak
7230.000	38.52	10.89	49.41	74.00	-24.59	H	peak

Remark:

1. Measuring frequencies from 1 GHz to the 10th harmonic of highest fundamental frequency.
2. Radiated emissions measured in frequency above 1000MHz were made with an instrument using peak/average detector mode.
3. Average test would be performed if the peak result were greater than the average limit.
4. Data of measurement within this frequency range shown " --- " in the table above means the reading of emissions are attenuated more than 20dB below the permissible limits or the field strength is too small to be measured.
5. Measurements above show only up to 6 maximum emissions noted, or would be lesser, with " N/A " remark, if no specific emissions from the EUT are recorded (ie: margin>20dB from the applicable limit) and considered that's already beyond the background noise floor.
6. Margin (dB) = Remark result (dBuV/m) – Average limit (dBuV/m).



Operation Mode:TX / IEEE 802.11g mode / CH High Test Date: 2013/12/18

Temperature: 26°C

Tested by: Francis Lee

Humidity: 56%RH

Polarity: Ver. / Hor.

Freq. (MHz)	Reading (dBuV)	Correct Factor (dB/m)	Result (dBuV/m)	Limit (dBuV/m)	Margin (dB)	Ant. Pol H/V	Remark
1544.000	51.69	-5.05	46.64	74.00	-27.36	V	peak
2134.000	51.76	-2.81	48.95	74.00	-25.05	V	peak
2542.000	57.86	-1.45	56.41	74.00	-17.59	V	peak
2542.000	50.49	-1.45	49.04	54.00	-4.96	V	AVG
3635.000	40.78	2.77	43.55	74.00	-30.45	V	peak
4925.000	42.46	4.61	47.07	74.00	-26.93	V	peak
7245.000	39.16	10.25	49.41	74.00	-24.59	V	peak
1394.000	51.81	-7.05	44.76	74.00	-29.24	H	peak
2108.000	50.25	-3.76	46.49	74.00	-27.51	H	peak
2542.000	50.95	-3.62	47.33	74.00	-26.67	H	peak
4300.000	39.72	7.66	47.38	74.00	-26.62	H	peak
5360.000	39.65	7.88	47.53	74.00	-26.47	H	peak
7510.000	38.90	10.86	49.76	74.00	-24.24	H	peak

Remark:

1. Measuring frequencies from 1 GHz to the 10th harmonic of highest fundamental frequency.
2. Radiated emissions measured in frequency above 1000MHz were made with an instrument using peak/average detector mode.
3. Average test would be performed if the peak result were greater than the average limit.
4. Data of measurement within this frequency range shown " --- " in the table above means the reading of emissions are attenuated more than 20dB below the permissible limits or the field strength is too small to be measured.
5. Measurements above show only up to 6 maximum emissions noted, or would be lesser, with " N/A " remark, if no specific emissions from the EUT are recorded (ie: margin>20dB from the applicable limit) and considered that's already beyond the background noise floor.
6. Margin (dB) = Remark result (dBuV/m) – Average limit (dBuV/m).



Operation Mode: TX / IEEE 802.11n HT20 mode / CH Low

Test Date: 2013/12/18

Temperature: 26°C

Tested by: Francis Lee

Humidity: 56%RH

Polarity: Ver. / Hor.

Freq. (MHz)	Reading (dBuV)	Correct Factor (dB/m)	Result (dBuV/m)	Limit (dBuV/m)	Margin (dB)	Ant. Pol H/V	Remark
1576.000	50.95	-4.90	46.05	74.00	-27.95	V	peak
1958.000	50.38	-1.96	48.42	74.00	-25.58	V	peak
2574.000	54.52	-1.85	52.67	74.00	-21.33	V	peak
2574.000	45.16	-1.85	43.31	54.00	-10.69	V	AVG
3635.000	41.64	2.77	44.41	74.00	-29.59	V	peak
4880.000	40.69	3.92	44.61	74.00	-29.39	V	peak
7135.000	39.42	9.72	49.14	74.00	-24.86	V	peak
1410.000	51.33	-7.11	44.22	74.00	-29.78	H	peak
2132.000	50.22	-3.71	46.51	74.00	-27.49	H	peak
2572.000	50.35	-3.49	46.86	74.00	-27.14	H	peak
4325.000	40.34	7.47	47.81	74.00	-26.19	H	peak
5595.000	38.58	9.18	47.76	74.00	-26.24	H	peak
7365.000	38.28	11.49	49.77	74.00	-24.23	H	peak

Remark:

1. Measuring frequencies from 1 GHz to the 10th harmonic of highest fundamental frequency.
2. Radiated emissions measured in frequency above 1000MHz were made with an instrument using peak/average detector mode.
3. Average test would be performed if the peak result were greater than the average limit.
4. Data of measurement within this frequency range shown " --- " in the table above means the reading of emissions are attenuated more than 20dB below the permissible limits or the field strength is too small to be measured.
5. Measurements above show only up to 6 maximum emissions noted, or would be lesser, with " N/A " remark, if no specific emissions from the EUT are recorded (ie: margin>20dB from the applicable limit) and considered that's already beyond the background noise floor.
6. Margin (dB) = Remark result (dBuV/m) – Average limit (dBuV/m).



Operation Mode: TX / IEEE 802.11n HT20 mode / CH Mid

Test Date: 2013/12/18

Temperature: 26°C

Tested by: Francis Lee

Humidity: 56%RH

Polarity: Ver. / Hor.

Freq. (MHz)	Reading (dBuV)	Correct Factor (dB/m)	Result (dBuV/m)	Limit (dBuV/m)	Margin (dB)	Ant. Pol H/V	Remark
1550.000	51.71	-5.02	46.69	74.00	-27.31	V	peak
2132.000	51.47	-2.85	48.62	74.00	-25.38	V	peak
2516.000	56.85	-1.13	55.72	74.00	-18.28	V	peak
2516.000	50.69	-1.13	49.56	54.00	-4.44	V	AVG
3570.000	40.96	2.72	43.68	74.00	-30.32	V	peak
4870.000	41.39	3.70	45.09	74.00	-28.91	V	peak
7065.000	39.18	9.18	48.36	74.00	-25.64	V	peak
1402.000	50.57	-6.94	43.63	74.00	-30.37	H	peak
2106.000	49.71	-3.77	45.94	74.00	-28.06	H	peak
2792.000	48.96	-2.55	46.41	74.00	-27.59	H	peak
4420.000	40.67	6.86	47.53	74.00	-26.47	H	peak
5535.000	38.84	8.98	47.82	74.00	-26.18	H	peak
7230.000	39.21	10.89	50.10	74.00	-23.90	H	peak

Remark:

1. Measuring frequencies from 1 GHz to the 10th harmonic of highest fundamental frequency.
2. Radiated emissions measured in frequency above 1000MHz were made with an instrument using peak/average detector mode.
3. Average test would be performed if the peak result were greater than the average limit.
4. Data of measurement within this frequency range shown " --- " in the table above means the reading of emissions are attenuated more than 20dB below the permissible limits or the field strength is too small to be measured.
5. Measurements above show only up to 6 maximum emissions noted, or would be lesser, with " N/A " remark, if no specific emissions from the EUT are recorded (ie: margin>20dB from the applicable limit) and considered that's already beyond the background noise floor.
6. Margin (dB) = Remark result (dBuV/m) – Average limit (dBuV/m).



Operation Mode: TX / IEEE 802.11n HT20 mode / CH High

Test Date: 2013/12/18

Temperature: 26°C

Tested by: Francis Lee

Humidity: 56%RH

Polarity: Ver. / Hor.

Freq. (MHz)	Reading (dBuV)	Correct Factor (dB/m)	Result (dBuV/m)	Limit (dBuV/m)	Margin (dB)	Ant. Pol H/V	Remark
1432.000	51.72	-6.19	45.53	74.00	-28.47	V	peak
2132.000	51.47	-2.85	48.62	74.00	-25.38	V	peak
2542.000	57.30	-1.45	55.85	74.00	-18.15	V	peak
2542.000	50.35	-1.45	48.90	54.00	-5.10	V	AVG
3795.000	40.42	3.63	44.05	74.00	-29.95	V	peak
4925.000	41.26	4.61	45.87	74.00	-28.13	V	peak
7465.000	38.64	11.46	50.10	74.00	-23.90	V	peak
1406.000	50.67	-7.03	43.64	74.00	-30.36	H	peak
2126.000	50.33	-3.72	46.61	74.00	-27.39	H	peak
2580.000	50.08	-3.45	46.63	74.00	-27.37	H	peak
4335.000	39.82	7.40	47.22	74.00	-26.78	H	peak
5910.000	39.85	9.18	49.03	74.00	-24.97	H	peak
7605.000	39.50	10.52	50.02	74.00	-23.98	H	peak

Remark:

1. Measuring frequencies from 1 GHz to the 10th harmonic of highest fundamental frequency.
2. Radiated emissions measured in frequency above 1000MHz were made with an instrument using peak/average detector mode.
3. Average test would be performed if the peak result were greater than the average limit.
4. Data of measurement within this frequency range shown " --- " in the table above means the reading of emissions are attenuated more than 20dB below the permissible limits or the field strength is too small to be measured.
5. Measurements above show only up to 6 maximum emissions noted, or would be lesser, with " N/A " remark, if no specific emissions from the EUT are recorded (ie: margin>20dB from the applicable limit) and considered that's already beyond the background noise floor.
6. Margin (dB) = Remark result (dBuV/m) – Average limit (dBuV/m).



Operation Mode: TX / IEEE 802.11n HT40 mode / CH Low

Test Date: 2013/12/18

Temperature: 26°C

Tested by: Francis Lee

Humidity: 56%RH

Polarity: Ver. / Hor.

Freq. (MHz)	Reading (dBuV)	Correct Factor (dB/m)	Result (dBuV/m)	Limit (dBuV/m)	Margin (dB)	Ant. Pol H/V	Remark
1486.000	50.66	-5.45	45.21	74.00	-28.79	V	peak
2198.000	49.95	-1.37	48.58	74.00	-25.42	V	peak
2686.000	49.90	-1.57	48.33	74.00	-25.67	V	peak
3595.000	41.12	2.90	44.02	74.00	-29.98	V	peak
5000.000	39.64	5.32	44.96	74.00	-29.04	V	peak
6550.000	39.71	6.93	46.64	74.00	-27.36	V	peak
1418.000	51.52	-7.28	44.24	74.00	-29.76	H	peak
2198.000	49.87	-3.56	46.31	74.00	-27.69	H	peak
2608.000	49.55	-3.36	46.19	74.00	-27.81	H	peak
4310.000	40.29	7.59	47.88	74.00	-26.12	H	peak
5575.000	38.97	9.11	48.08	74.00	-25.92	H	peak
7540.000	39.30	10.77	50.07	74.00	-23.93	H	peak

Remark:

1. Measuring frequencies from 1 GHz to the 10th harmonic of highest fundamental frequency.
2. Radiated emissions measured in frequency above 1000MHz were made with an instrument using peak/average detector mode.
3. Average test would be performed if the peak result were greater than the average limit.
4. Data of measurement within this frequency range shown " --- " in the table above means the reading of emissions are attenuated more than 20dB below the permissible limits or the field strength is too small to be measured.
5. Measurements above show only up to 6 maximum emissions noted, or would be lesser, with " N/A " remark, if no specific emissions from the EUT are recorded (ie: margin>20dB from the applicable limit) and considered that's already beyond the background noise floor.
6. Margin (dB) = Remark result (dBuV/m) – Average limit (dBuV/m).



Operation Mode: TX / IEEE 802.11n HT40 mode / CH Mid

Test Date: 2013/12/18

Temperature: 26°C

Tested by: Francis Lee

Humidity: 56%RH

Polarity: Ver. / Hor.

Freq. (MHz)	Reading (dBuV)	Correct Factor (dB/m)	Result (dBuV/m)	Limit (dBuV/m)	Margin (dB)	Ant. Pol H/V	Remark
1528.000	51.44	-5.13	46.31	74.00	-27.69	V	peak
2192.000	49.95	-1.51	48.44	74.00	-25.56	V	peak
2516.000	56.06	-1.13	54.93	74.00	-19.07	V	peak
2516.000	49.67	-1.13	48.54	54.00	-5.46	V	AVG
4025.000	40.56	3.40	43.96	74.00	-30.04	V	peak
5540.000	40.54	6.10	46.64	74.00	-27.36	V	peak
7160.000	39.17	9.85	49.02	74.00	-24.98	V	peak
1442.000	51.80	-7.78	44.02	74.00	-29.98	H	peak
2152.000	50.37	-3.67	46.70	74.00	-27.30	H	peak
2824.000	48.70	-2.30	46.40	74.00	-27.60	H	peak
4355.000	39.96	7.25	47.21	74.00	-26.79	H	peak
6110.000	40.10	8.63	48.73	74.00	-25.27	H	peak
7640.000	39.34	9.99	49.33	74.00	-24.67	H	peak

Remark:

1. Measuring frequencies from 1 GHz to the 10th harmonic of highest fundamental frequency.
2. Radiated emissions measured in frequency above 1000MHz were made with an instrument using peak/average detector mode.
3. Average test would be performed if the peak result were greater than the average limit.
4. Data of measurement within this frequency range shown " --- " in the table above means the reading of emissions are attenuated more than 20dB below the permissible limits or the field strength is too small to be measured.
5. Measurements above show only up to 6 maximum emissions noted, or would be lesser, with " N/A " remark, if no specific emissions from the EUT are recorded (ie: margin>20dB from the applicable limit) and considered that's already beyond the background noise floor.
6. Margin (dB) = Remark result (dBuV/m) – Average limit (dBuV/m).



Operation Mode: TX / IEEE 802.11n HT40 mode / CH High

Test Date: 2013/12/18

Temperature: 26°C

Tested by: Francis Lee

Humidity: 56%RH

Polarity: Ver. / Hor.

Freq. (MHz)	Reading (dBuV)	Correct Factor (dB/m)	Result (dBuV/m)	Limit (dBuV/m)	Margin (dB)	Ant. Pol H/V	Remark
1566.000	52.41	-4.95	47.46	74.00	-26.54	V	peak
2268.000	50.21	-1.48	48.73	74.00	-25.27	V	peak
2580.000	54.66	-1.92	52.74	74.00	-21.26	V	peak
2580.000	43.52	-1.92	41.60	54.00	-12.40	V	AVG
3795.000	40.66	3.63	44.29	74.00	-29.71	V	peak
4905.000	40.51	4.42	44.93	74.00	-29.07	V	peak
7595.000	38.89	11.89	50.78	74.00	-23.22	V	peak
1404.000	50.68	-6.98	43.70	74.00	-30.30	H	peak
2192.000	50.25	-3.58	46.67	74.00	-27.33	H	peak
2530.000	51.80	-3.67	48.13	74.00	-25.87	H	peak
4365.000	40.03	7.18	47.21	74.00	-26.79	H	peak
5530.000	39.73	8.96	48.69	74.00	-25.31	H	peak
7285.000	37.57	11.62	49.19	74.00	-24.81	H	peak

Remark:

1. Measuring frequencies from 1 GHz to the 10th harmonic of highest fundamental frequency.
2. Radiated emissions measured in frequency above 1000MHz were made with an instrument using peak/average detector mode.
3. Average test would be performed if the peak result were greater than the average limit.
4. Data of measurement within this frequency range shown " --- " in the table above means the reading of emissions are attenuated more than 20dB below the permissible limits or the field strength is too small to be measured.
5. Measurements above show only up to 6 maximum emissions noted, or would be lesser, with " N/A " remark, if no specific emissions from the EUT are recorded (ie: margin>20dB from the applicable limit) and considered that's already beyond the background noise floor.
6. Margin (dB) = Remark result (dBuV/m) – Average limit (dBuV/m).



7.7 POWERLINE CONDUCTED EMISSIONS

LIMIT

According to §15.207(a), except as shown in paragraphs (b) and (c) of this section, for an intentional radiator that is designed to be connected to the public utility (AC) power line, the radio frequency voltage that is conducted back onto the AC power line on any frequency or frequencies within the band 150 kHz to 30 MHz shall not exceed the limits in the following table, as measured using a 50 μ H/50 ohms line impedance stabilization network (LISN). Compliance with the provisions of this paragraph shall be based on the measurement of the radio frequency voltage between each power line and ground at the power terminal. The lower limit applies at the boundary between the frequency ranges.

Frequency Range (MHz)	Limits (dB μ V)	
	Quasi-peak	Average
0.15 to 0.50	66 to 56*	56 to 46*
0.50 to 5	56	46
5 to 30	60	50

* Decreases with the logarithm of the frequency.

Test Configuration

See test photographs attached in Appendix 1 for the actual connections between EUT and support equipment.

TEST PROCEDURE

1. The EUT was placed on a table, which is 0.8m above ground plane.
2. Maximum procedure was performed on the six highest emissions to ensure EUT compliance.
3. Repeat above procedures until all frequency measured were complete.



TEST RESULTS

The initial step in collecting conducted data is a spectrum analyzer peak scan of the measurement range. Significant peaks are then marked as shown on the following data page, and these signals are then quasi-peaked.

Test Data

Operation Mode: LAN Mode **Test Date:** 2013/12/13
Temperature: 25°C **Tested by:** Cashman Wang
Humidity: 57% RH

Freq. (MHz)	QP Reading	AV Reading	Corr. factor	QP Result	AV Result	QP Limit	AV Limit	QP Margin	AV Margin	Note
3.1700	30.15	10.96	9.86	40.01	20.82	56.00	46.00	-15.99	-25.18	L1
16.1660	30.96	24.11	10.06	41.02	34.17	60.00	50.00	-18.98	-15.83	L1
17.6940	31.78	26.50	10.08	41.86	36.58	60.00	50.00	-18.14	-13.42	L1
18.2420	32.96	27.13	10.08	43.04	37.21	60.00	50.00	-16.96	-12.79	L1
20.2580	30.86	26.38	10.10	40.96	36.48	60.00	50.00	-19.04	-13.52	L1
23.1299	31.53	27.04	10.14	41.67	37.18	60.00	50.00	-18.33	-12.82	L1
16.2300	30.59	26.17	10.08	40.67	36.25	60.00	50.00	-19.33	-13.75	L2
17.6940	31.44	26.17	10.10	41.54	36.27	60.00	50.00	-18.46	-13.73	L2
18.2420	31.80	26.50	10.11	41.91	36.61	60.00	50.00	-18.09	-13.39	L2
19.7099	30.88	25.29	10.13	41.01	35.42	60.00	50.00	-18.99	-14.58	L2
20.2580	30.71	25.89	10.13	40.84	36.02	60.00	50.00	-19.16	-13.98	L2
23.1299	31.49	26.66	10.18	41.67	36.84	60.00	50.00	-18.33	-13.16	L2

Remark:

1. Measuring frequencies from 0.15 MHz to 30MHz.
2. The emissions measured in frequency range from 0.15 MHz to 30MHz were made with an instrument using Quasi-peak detector and average detector.
3. The IF bandwidth of SPA between 0.15MHz to 30MHz was 10kHz; the IF bandwidth of Test Receiver between 0.15MHz to 30MHz was 9kHz;
4. L1 = Line One (Live Line) / L2 = Line Two (Neutral Line)



Test Plots

Conducted emissions (Line 1)

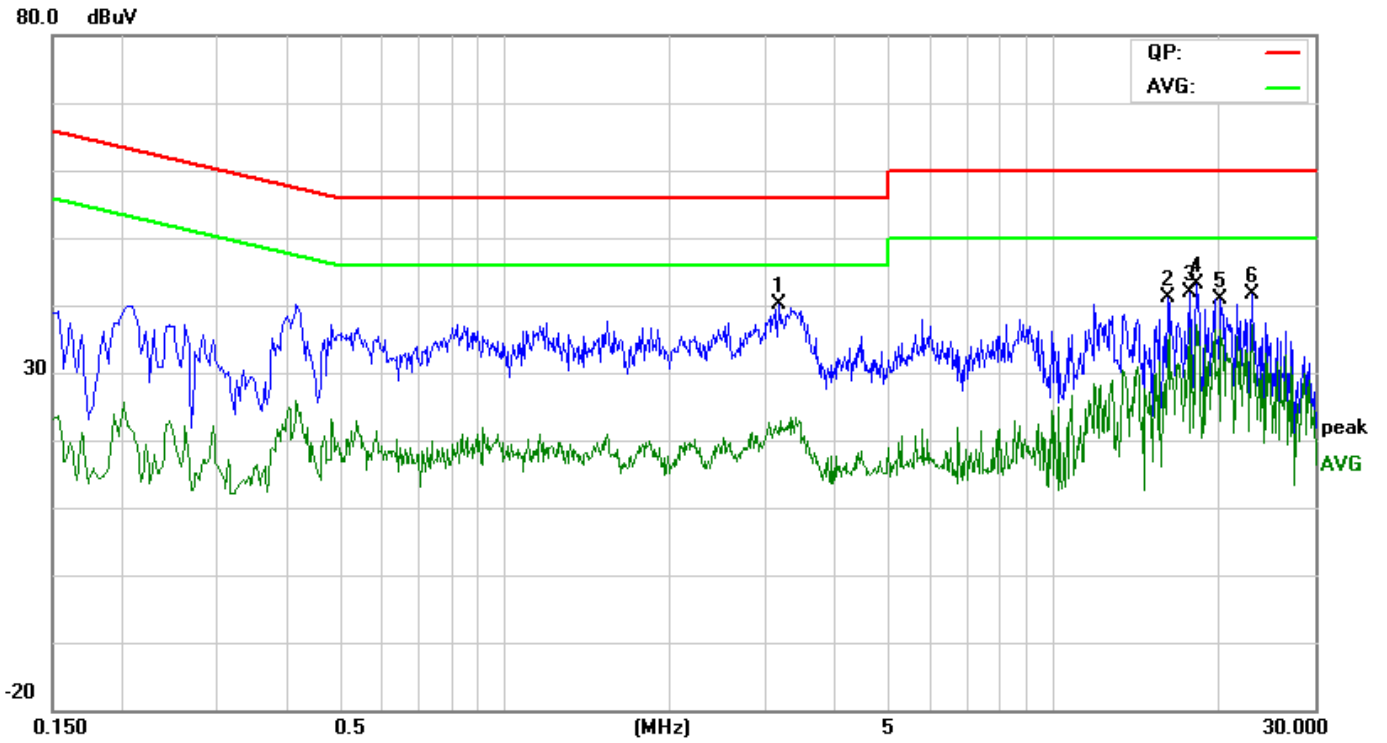

Conducted emissions (Line 2)

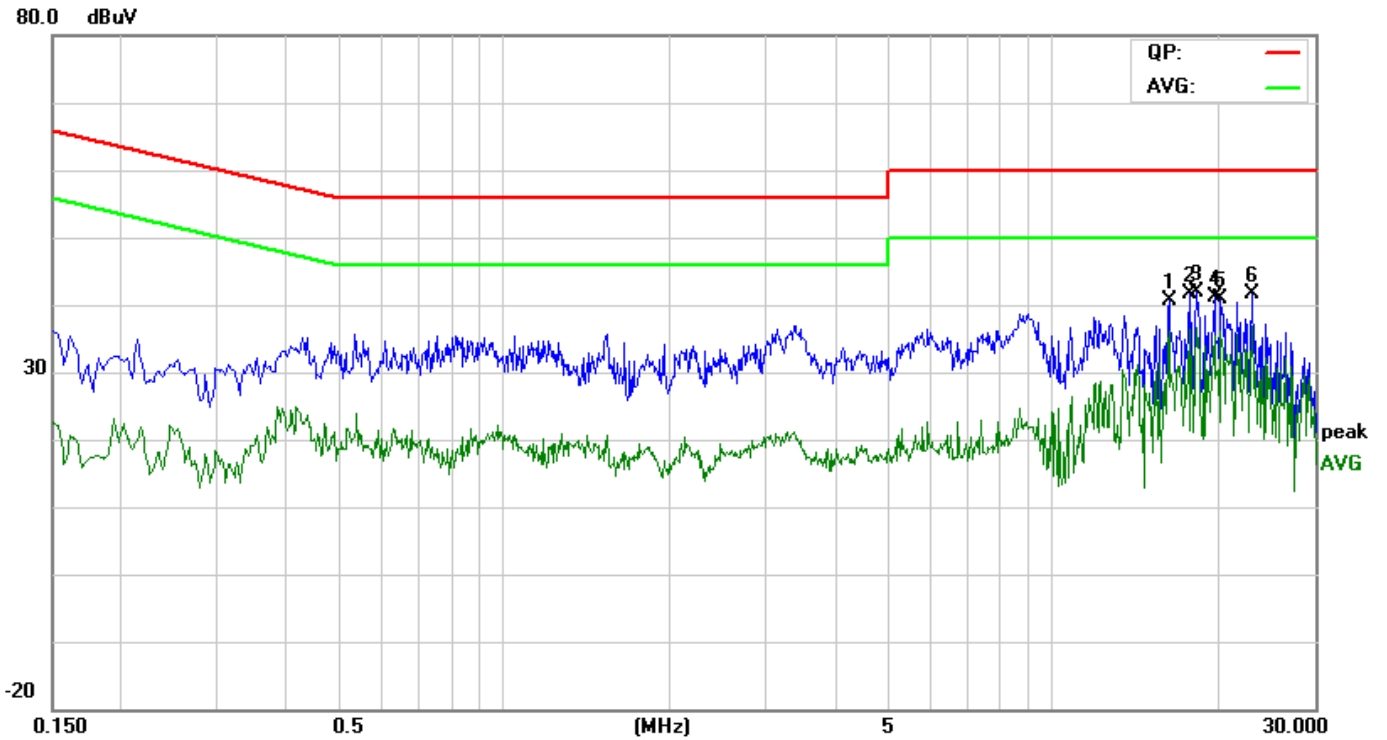



Operation Mode: Wifi Mode
Temperature: 25°C
Humidity: 57% RH

Test Date: 2013/12/13
Tested by: Cashman Wang

Freq. (MHz)	QP Reading	AV Reading	Corr. factor	QP Result	AV Result	QP Limit	AV Limit	QP Margin	AV Margin	Note
0.1819	29.56	7.59	9.68	39.24	17.27	64.39	54.40	-25.15	-37.13	L1
0.2260	27.54	11.27	9.69	37.23	20.96	62.59	52.60	-25.36	-31.64	L1
3.2940	25.41	4.64	9.86	35.27	14.50	56.00	46.00	-20.73	-31.50	L1
9.0420	23.62	4.96	9.94	33.56	14.90	60.00	50.00	-26.44	-35.10	L1
25.0020	24.44	16.54	10.15	34.59	26.69	60.00	50.00	-25.41	-23.31	L1
27.4380	23.39	5.96	10.16	33.55	16.12	60.00	50.00	-26.45	-33.88	L1
0.1700	26.91	9.38	9.69	36.60	19.07	64.96	54.96	-28.36	-35.89	L2
0.1819	27.17	9.01	9.69	36.86	18.70	64.39	54.40	-27.53	-35.70	L2
0.2100	31.85	26.58	9.70	41.55	36.28	63.20	53.21	-21.65	-16.93	L2
0.2420	29.56	25.24	9.70	39.26	34.94	62.02	52.03	-22.76	-17.09	L2
3.0620	24.45	4.84	9.86	34.31	14.70	56.00	46.00	-21.69	-31.30	L2
3.2659	24.77	5.45	9.86	34.63	15.31	56.00	46.00	-21.37	-30.69	L2

Remark:

5. Measuring frequencies from 0.15 MHz to 30MHz.
6. The emissions measured in frequency range from 0.15 MHz to 30MHz were made with an instrument using Quasi-peak detector and average detector.
7. The IF bandwidth of SPA between 0.15MHz to 30MHz was 10kHz; the IF bandwidth of Test Receiver between 0.15MHz to 30MHz was 9kHz;
8. L1 = Line One (Live Line) / L2 = Line Two (Neutral Line)



Test Plots

Conducted emissions (Line 1)

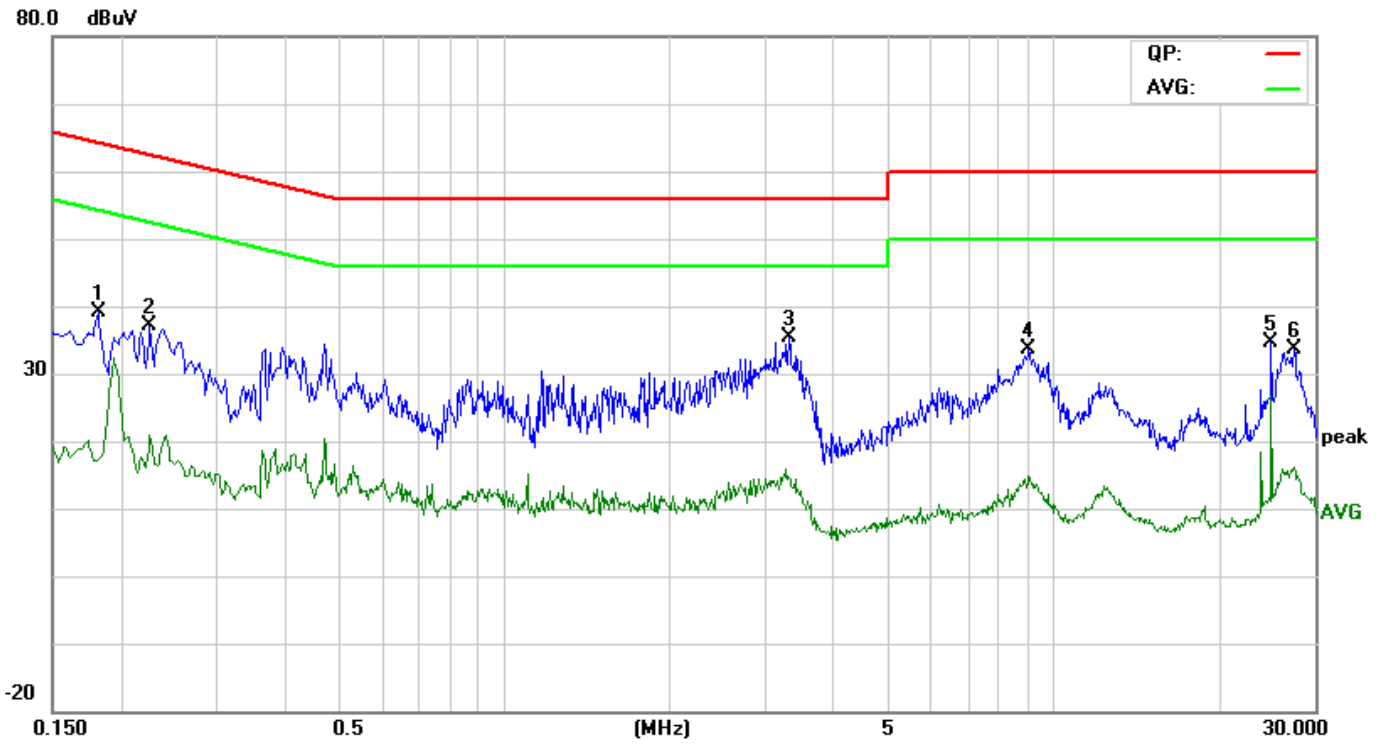

Conducted emissions (Line 2)

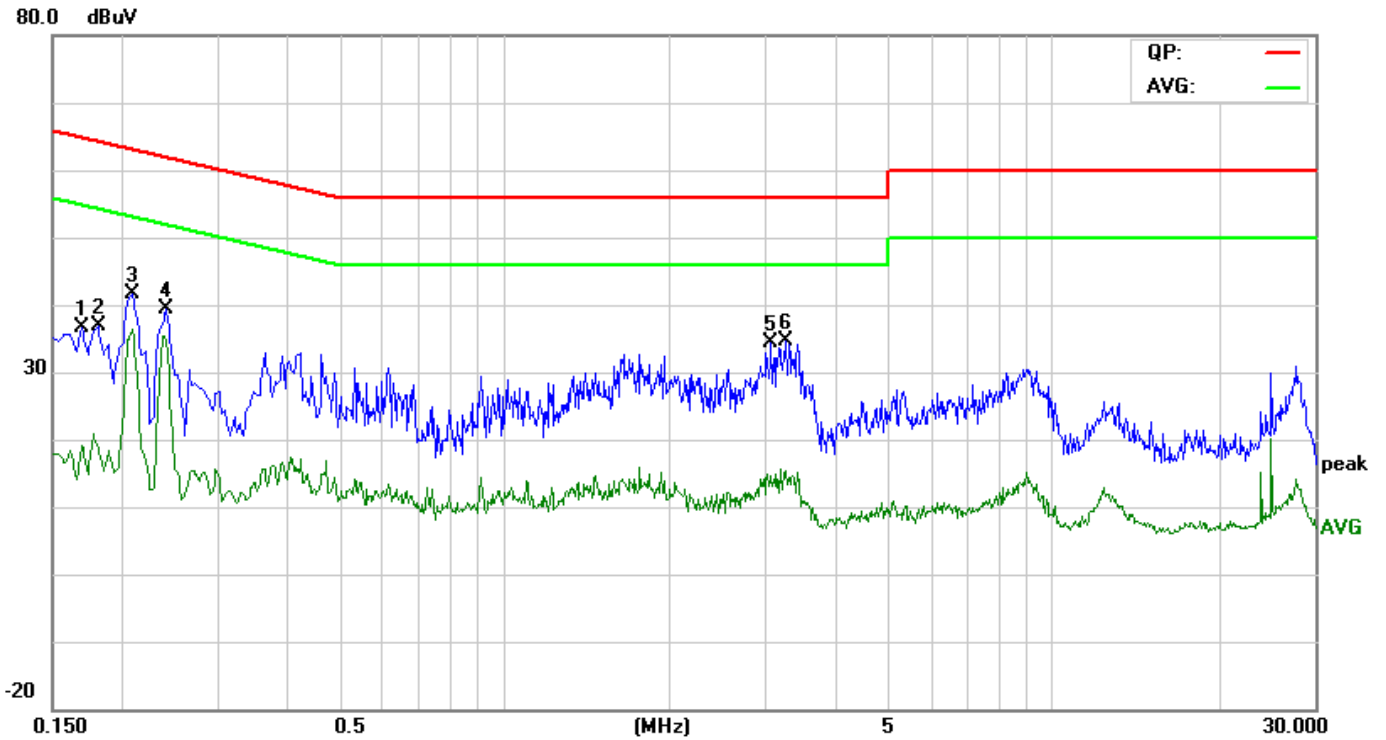



8 APPENDIX I PHOTOGRAPHS OF TEST SETUP

**Radiated Emissions Setup Photos
Below 1GHz
LAN Mode**

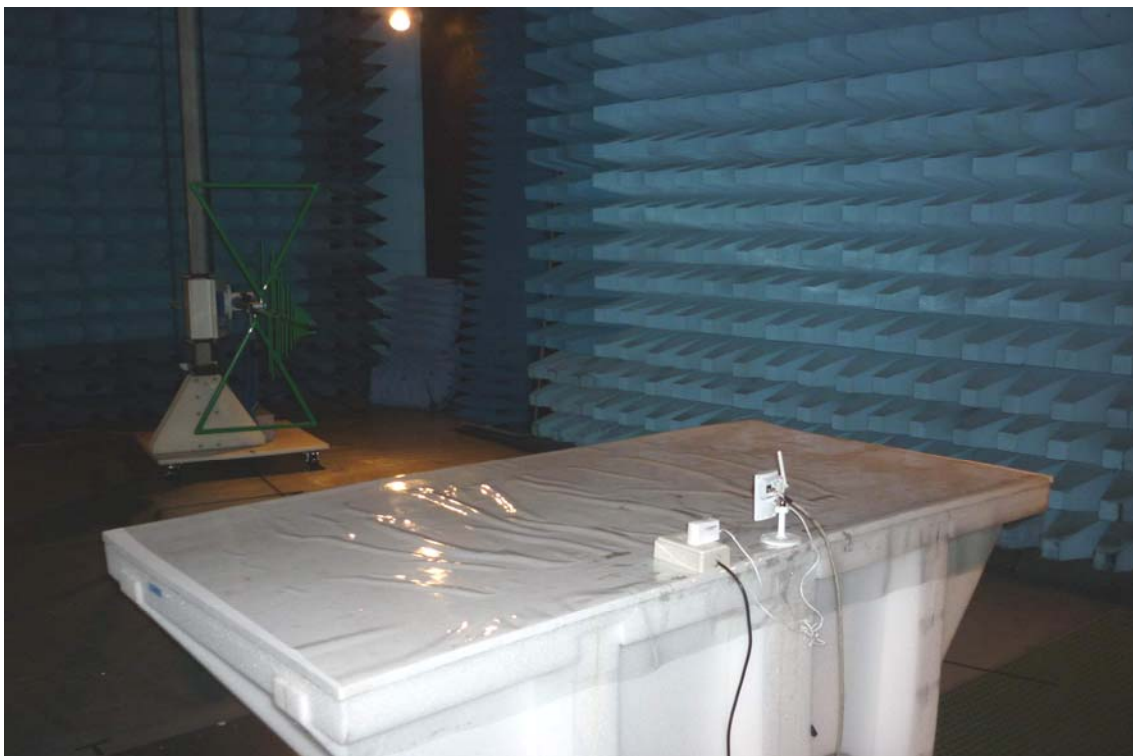



Wifi Mode

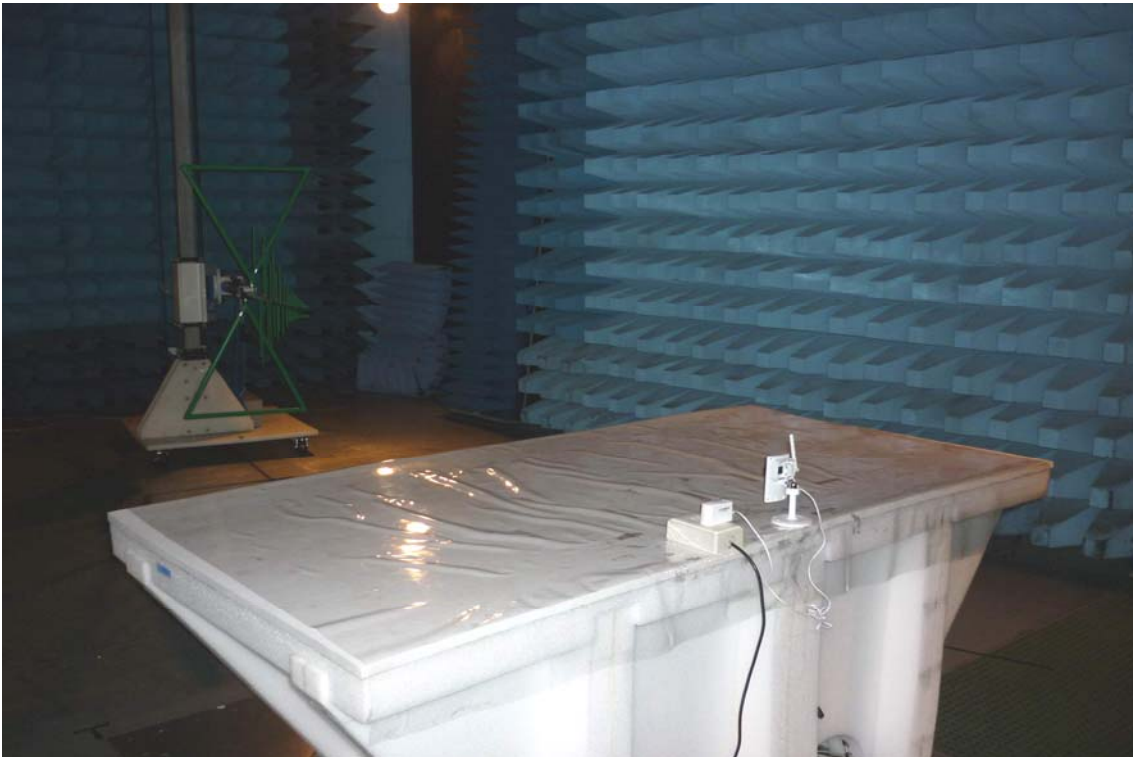
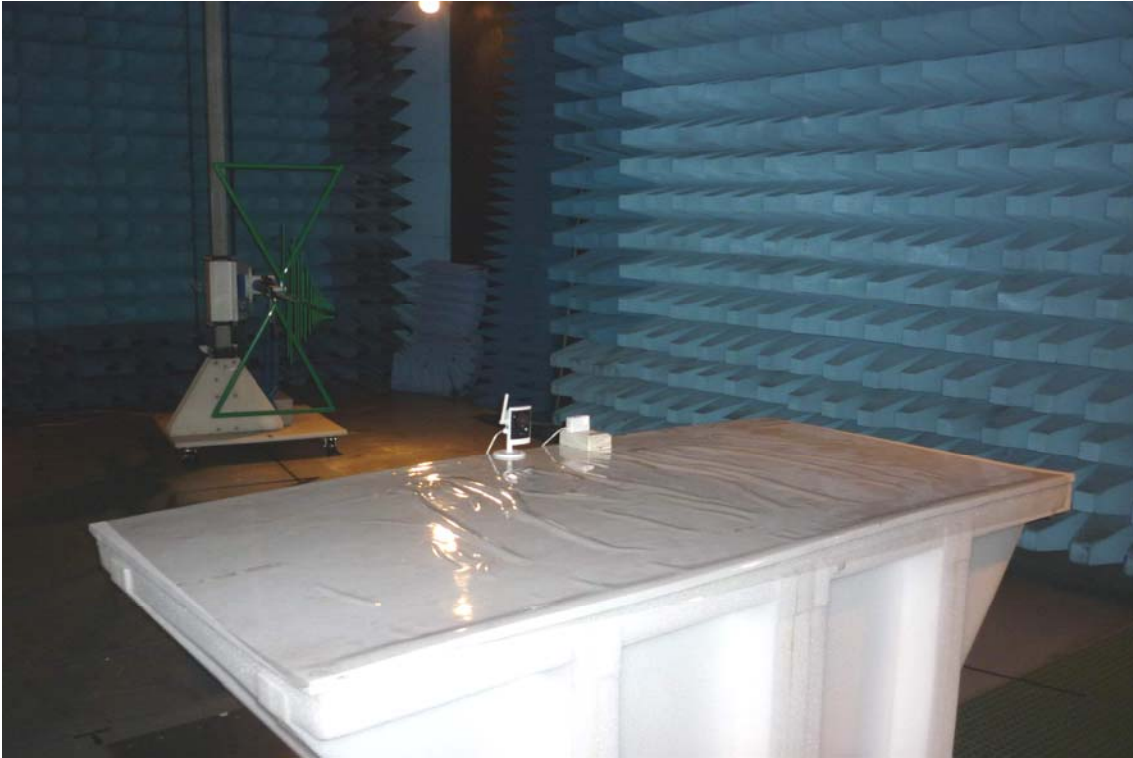



Above 1GHz





Conducted Emissions Setup Photo





Powerline Conducted Emissions Setup Photos LAN Mode





Wifi Mode





9 APPENDIX II: PHOTOGRAPHS OF EUT

Refer to T131206J02 Photographs.