

## FCC Test Report

**Report No.:** RF180515C27-2

**FCC ID:** KA2CS1820LMA1

**Test Model:** DCS-1820LM

**Received Date:** May 15, 2018

**Test Date:** May 30, 2018 ~ Jun. 05, 2018

**Issued Date:** Jun. 07, 2018

**Applicant:** D-Link Corporation

**Address:** 17595 Mt. Herrmann, Fountain Valley, California, United States, 92708

**Issued By:** Bureau Veritas Consumer Products Services (H.K.) Ltd., Taoyuan Branch

**Lab Address:** No. 47-2, 14th Ling, Chia Pau Vil., Lin Kou Dist., New Taipei City, Taiwan ( R.O.C )

**Test Location (1):** No.19, Hwa Ya 2nd Rd., Wen Hwa Vil., Kwei Shan Dist., Taoyuan City 33383, Taiwan, R.O.C.

**Test Location (2):** No.215, Sec. 3, Beixin Rd., Xindian Dist., New Taipei City 231, Taiwan, R.O.C

**FCC Registration /  
Designation Number:** 427177 / TW0011



This report is for your exclusive use. Any copying or replication of this report to or for any other person or entity, or use of our name or trademark, is permitted only with our prior written permission. This report sets forth our findings solely with respect to the test samples identified herein. The results set forth in this report are not indicative or representative of the quality or characteristics of the lot from which a test sample was taken or any similar or identical product unless specifically and expressly noted. Our report includes all of the tests requested by you and the results thereof based upon the information that you provided to us. You have 60 days from date of issuance of this report to notify us of any material error or omission caused by our negligence, provided, however, that such notice shall be in writing and shall specifically address the issue you wish to raise. A failure to raise such issue within the prescribed time shall constitute your unqualified acceptance of the completeness of this report, the tests conducted and the correctness of the report contents. Unless specific mention, the uncertainty of measurement has been explicitly taken into account to declare the compliance or non-compliance to the specification. The report must not be used by the client to claim product certification, approval, or endorsement by TAF or any government agencies.

## Table of Contents

<b>Release Control Record</b> .....	<b>4</b>
<b>1 Certificate of Conformity</b> .....	<b>5</b>
<b>2 Summary of Test Results</b> .....	<b>6</b>
2.1 Measurement Uncertainty .....	6
2.2 Modification Record .....	6
<b>3 General Information</b> .....	<b>7</b>
3.1 General Description of EUT .....	7
3.2 Description of Test Modes .....	8
3.2.1 Test Mode Applicability and Tested Channel Detail .....	9
3.3 Duty Cycle of Test Signal .....	11
3.4 Description of Support Units .....	12
3.4.1 Configuration of System under Test .....	12
3.5 General Description of Applied Standards .....	12
<b>4 Test Types and Results</b> .....	<b>13</b>
4.1 Radiated Emission and Bandedge Measurement .....	13
4.1.1 Limits of Radiated Emission and Bandedge Measurement .....	13
4.1.2 Test Instruments .....	14
4.1.3 Test Procedures .....	15
4.1.4 Deviation from Test Standard .....	16
4.1.5 Test Set Up .....	17
4.1.6 EUT Operating Conditions .....	18
4.1.7 Test Results .....	19
4.2 Conducted Emission Measurement .....	30
4.2.1 Limits of Conducted Emission Measurement .....	30
4.2.2 Test Instruments .....	30
4.2.3 Test Procedures .....	31
4.2.4 Deviation from Test Standard .....	31
4.2.5 Test Setup .....	31
4.2.6 EUT Operating Conditions .....	31
4.2.7 Test Results .....	32
4.3 6 dB Bandwidth Measurement .....	34
4.3.1 Limits of 6 dB Bandwidth Measurement .....	34
4.3.2 Test Setup .....	34
4.3.3 Test Instruments .....	34
4.3.4 Test Procedure .....	34
4.3.5 Deviation from Test Standard .....	34
4.3.6 EUT Operating Conditions .....	34
4.3.7 Test Result .....	35
4.4 Occupied Bandwidth Measurement .....	37
4.4.1 Test Setup .....	37
4.4.2 Test Instruments .....	37
4.4.3 Test Procedure .....	37
4.4.4 Deviation from Test Standard .....	37
4.4.5 EUT Operating Conditions .....	37
4.4.6 Test Results .....	38
4.5 Conducted Output Power Measurement .....	40
4.5.1 Limits of Conducted Output Power Measurement .....	40
4.5.2 Test Setup .....	40
4.5.3 Test Instruments .....	40
4.5.4 Test Procedures .....	40
4.5.5 Deviation from Test Standard .....	40
4.5.6 EUT Operating Conditions .....	40
4.5.7 Test Results .....	41

4.6	Power Spectral Density Measurement .....	43
4.6.1	Limits of Power Spectral Density Measurement.....	43
4.6.2	Test Setup.....	43
4.6.3	Test Instruments .....	43
4.6.4	Test Procedure .....	43
4.6.5	Deviation from Test Standard .....	43
4.6.6	EUT Operating Condition .....	43
4.6.7	Test Results .....	44
4.7	Conducted Out of Band Emission Measurement .....	46
4.7.1	Limits of Conducted Out of Band Emission Measurement.....	46
4.7.2	Test Setup.....	46
4.7.3	Test Instruments .....	46
4.7.4	Test Procedure .....	46
4.7.5	Deviation from Test Standard .....	46
4.7.6	EUT Operating Condition .....	46
4.7.7	Test Results .....	47
<b>5</b>	<b>Pictures of Test Arrangements.....</b>	<b>53</b>
	<b>Appendix – Information on the Testing Laboratories .....</b>	<b>54</b>

### Release Control Record

Issue No.	Description	Date Issued
RF180515C27-2	Original Release	Jun. 07, 2018

## 1 Certificate of Conformity

**Product:** LTE camera

**Brand:** D-Link Corporation

**Test Model:** DCS-1820LM

**Sample Status:** Identical Prototype

**Applicant:** D-Link Corporation

**Test Date:** May 30, 2018 ~ Jun. 05, 2018

**Standards:** 47 CFR FCC Part 15, Subpart C (Section 15.247)  
ANSI C63.10:2013

The above equipment has been tested by **Bureau Veritas Consumer Products Services (H.K.) Ltd., Taoyuan Branch**, and found compliance with the requirement of the above standards. The test record, data evaluation & Equipment Under Test (EUT) configurations represented herein are true and accurate accounts of the measurements of the sample's RF characteristics under the conditions specified in this report.

**Prepared by :**



**Date:**

Jun. 07, 2018

Ivonne Wu / Supervisor

**Approved by :**



**Date:**

Jun. 07, 2018

Dylan Chiou / Project Engineer

## 2 Summary of Test Results

47 CFR FCC Part 15, Subpart C (Section 15.247)			
FCC Clause	Test Item	Result	Remarks
15.207	AC Power Conducted Emission	Pass	Meet the requirement of limit. Minimum passing margin is -27.72 dB at 0.20083 MHz.
15.205 / 15.209 / 15.247(d)	Radiated Emissions and Band Edge Measurement	Pass	Meet the requirement of limit. Minimum passing margin is -1.4 dB at 4824 MHz.
15.247(d)	Antenna Port Emission	Pass	Meet the requirement of limit.
15.247(a)(2)	6 dB Bandwidth	Pass	Meet the requirement of limit.
---	Occupied Bandwidth Measurement	Pass	Reference only
15.247(b)	Conducted power	Pass	Meet the requirement of limit.
15.247(e)	Power Spectral Density	Pass	Meet the requirement of limit.
15.203	Antenna Requirement	Pass	No antenna connector is used.

### 2.1 Measurement Uncertainty

Where relevant, the following measurement uncertainty levels have been estimated for tests performed on the EUT:

The listed uncertainties are the worst case uncertainty for the entire range of measurement. Please note that the uncertainty values are provided for informational purposes only and are not used in determining the PASS/FAIL results.

Measurement	Frequency	Expanded Uncertainty (k=2) ( $\pm$ )
Conducted Emissions at mains ports	150 kHz ~ 30 MHz	2.44 dB
Radiated Emissions up to 1 GHz	30 MHz ~ 200 MHz	2.0153 dB
	200 MHz ~ 1000 MHz	2.0224 dB
Radiated Emissions above 1 GHz	1 GHz ~ 18 GHz	1.0121 dB
	18 GHz ~ 40 GHz	1.1508 dB

### 2.2 Modification Record

There were no modifications required for compliance.

### 3 General Information

#### 3.1 General Description of EUT

<b>Product</b>	LTE camera
<b>Brand</b>	D-Link Corporation
<b>Test Model</b>	DCS-1820LM
<b>Status of EUT</b>	Identical Prototype
<b>Power Supply Rating</b>	5.0 Vdc (adapter)
<b>Modulation Type</b>	CCK, DQPSK, DBPSK for DSSS 64QAM, 16QAM, QPSK, BPSK for OFDM
<b>Modulation Technology</b>	DSSS, OFDM
<b>Transfer Rate</b>	802.11b: 11.0 / 5.5 / 2.0 / 1.0 Mbps 802.11g: 54.0 / 48.0 / 36.0 / 24.0 / 18.0 / 12.0 / 9.0 / 6.0 Mbps 802.11n: up to 72.2
<b>Operating Frequency</b>	2412 ~ 2462 MHz
<b>Number of Channel</b>	11 for 802.11b, 802.11g, 802.11n (HT20)
<b>Output Power</b>	169.434 mW
<b>Antenna Type</b>	PIFA antenna with 4.4 dBi gain
<b>Antenna Connector</b>	N/A
<b>Accessory Device</b>	Refer to Note as below
<b>Data Cable Supplied</b>	Refer to Note as below

Note:

- The EUT provides one transmitter and receiver.

Modulation Mode	Tx Function
802.11b	1TX
802.11g	1TX
802.11n (HT20)	1TX

- The EUT contains following accessory devices.

Product	Brand	Model	Description
Adapter	D-Link	WB-10E05R	I/P: 100-240 Vac, 50-60 Hz, 0.4 A O/P: 5 Vdc, 2 A 2.95 m non-shielded cable w/o core

- The above EUT information is declared by manufacturer and for more detailed features description, please refers to the manufacturer's specifications or user's manual.

### 3.2 Description of Test Modes

11 channels are provided for 802.11b, 802.11g and 802.11n (HT20):

Channel	Frequency (MHz)	Channel	Frequency (MHz)
1	2412	7	2442
2	2417	8	2447
3	2422	9	2452
4	2427	10	2457
5	2432	11	2462
6	2437		



### 3.2.1 Test Mode Applicability and Tested Channel Detail

EUT Configure Mode	Applicable To				Description
	RE≥1G	RE<1G	PLC	APCM	
-	√	√	√	√	-

Where **RE≥1G**: Radiated Emission above 1 GHz      **RE<1G**: Radiated Emission below 1 GHz  
**PLC**: Power Line Conducted Emission      **APCM**: Antenna Port Conducted Measurement

**NOTE:** The EUT had been pre-tested on the positioned of each 3 axis. The worst case was found when positioned on **Z-plane**.  
**NOTE:** “-” means no effect.

#### **Radiated Emission Test (Above 1 GHz):**

- Pre-Scan has been conducted to determine the worst-case mode from all possible combinations between available modulations, data rates and antenna ports (if EUT with antenna diversity architecture).
- Following channel(s) was (were) selected for the final test as listed below.

EUT Configure Mode	Mode	Available Channel	Tested Channel	Modulation Technology	Modulation Type	Data Rate (Mbps)
-	802.11b	1 to 11	1, 6, 11	DSSS	DBPSK	1.0
-	802.11g	1 to 11	1, 6, 11	OFDM	BPSK	6.0
-	802.11n (HT20)	1 to 11	1, 6, 11	OFDM	BPSK	6.5

#### **Radiated Emission Test (Below 1 GHz):**

- Pre-Scan has been conducted to determine the worst-case mode from all possible combinations between available modulations, data rates and antenna ports (if EUT with antenna diversity architecture).
- Following channel(s) was (were) selected for the final test as listed below.

EUT Configure Mode	Mode	Available Channel	Tested Channel	Modulation Technology	Modulation Type	Data Rate (Mbps)
-	802.11b	1 to 11	1	DSSS	DBPSK	1.0

#### **Power Line Conducted Emission Test:**

- Pre-Scan has been conducted to determine the worst-case mode from all possible combinations between available modulations, data rates and antenna ports (if EUT with antenna diversity architecture).
- Following channel(s) was (were) selected for the final test as listed below.

EUT Configure Mode	Mode	Available Channel	Tested Channel	Modulation Technology	Modulation Type	Data Rate (Mbps)
-	802.11b	1 to 11	1	DSSS	DBPSK	1.0

**Bandedge Measurement:**

- Pre-Scan has been conducted to determine the worst-case mode from all possible combinations between available modulations, data rates and antenna ports (if EUT with antenna diversity architecture).
- Following channel(s) was (were) selected for the final test as listed below.

EUT Configure Mode	Mode	Available Channel	Tested Channel	Modulation Technology	Modulation Type	Data Rate (Mbps)
-	802.11b	1 to 11	1, 11	DSSS	DBPSK	1.0
-	802.11g	1 to 11	1, 11	OFDM	BPSK	6.0
-	802.11n (HT20)	1 to 11	1, 11	OFDM	BPSK	6.5

**Antenna Port Conducted Measurement:**

- This item includes all test value of each mode, but only includes spectrum plot of worst value of each mode.
- Pre-Scan has been conducted to determine the worst-case mode from all possible combinations between available modulations, data rates and antenna ports (if EUT with antenna diversity architecture).
- Following channel(s) was (were) selected for the final test as listed below.

EUT Configure Mode	Mode	Available Channel	Tested Channel	Modulation Technology	Modulation Type	Data Rate (Mbps)
-	802.11b	1 to 11	1, 6, 11	DSSS	DBPSK	1.0
-	802.11g	1 to 11	1, 6, 11	OFDM	BPSK	6.0
-	802.11n (HT20)	1 to 11	1, 6, 11	OFDM	BPSK	6.5

**Test Condition:**

Applicable To	Environmental Conditions	Input Power	Tested by
RE≥1G	25 deg. C, 65 % RH	120 Vac, 60 Hz	Karl Lee
RE<1G	25 deg. C, 65 % RH	120 Vac, 60 Hz	Karl Lee
PLC	25 deg. C, 65 % RH	120 Vac, 60 Hz	Getaz Yang
APCM	25 deg. C, 65 % RH	3.8 Vdc	Gavin Wu

### 3.3 Duty Cycle of Test Signal

Duty cycle of test signal is  $\geq 98\%$ , duty factor is not required.

Duty cycle of test signal is  $< 98\%$ , duty factor shall be considered.

**802.11b:** Duty cycle =  $8.22/8.24 = 0.998$

**802.11g:** Duty cycle =  $1.363/1.372 = 0.993$

**802.11n (HT20):** Duty cycle =  $1.275/1.304 = 0.978$ , Duty factor =  $10 * \log(1/0.978) = 0.10$

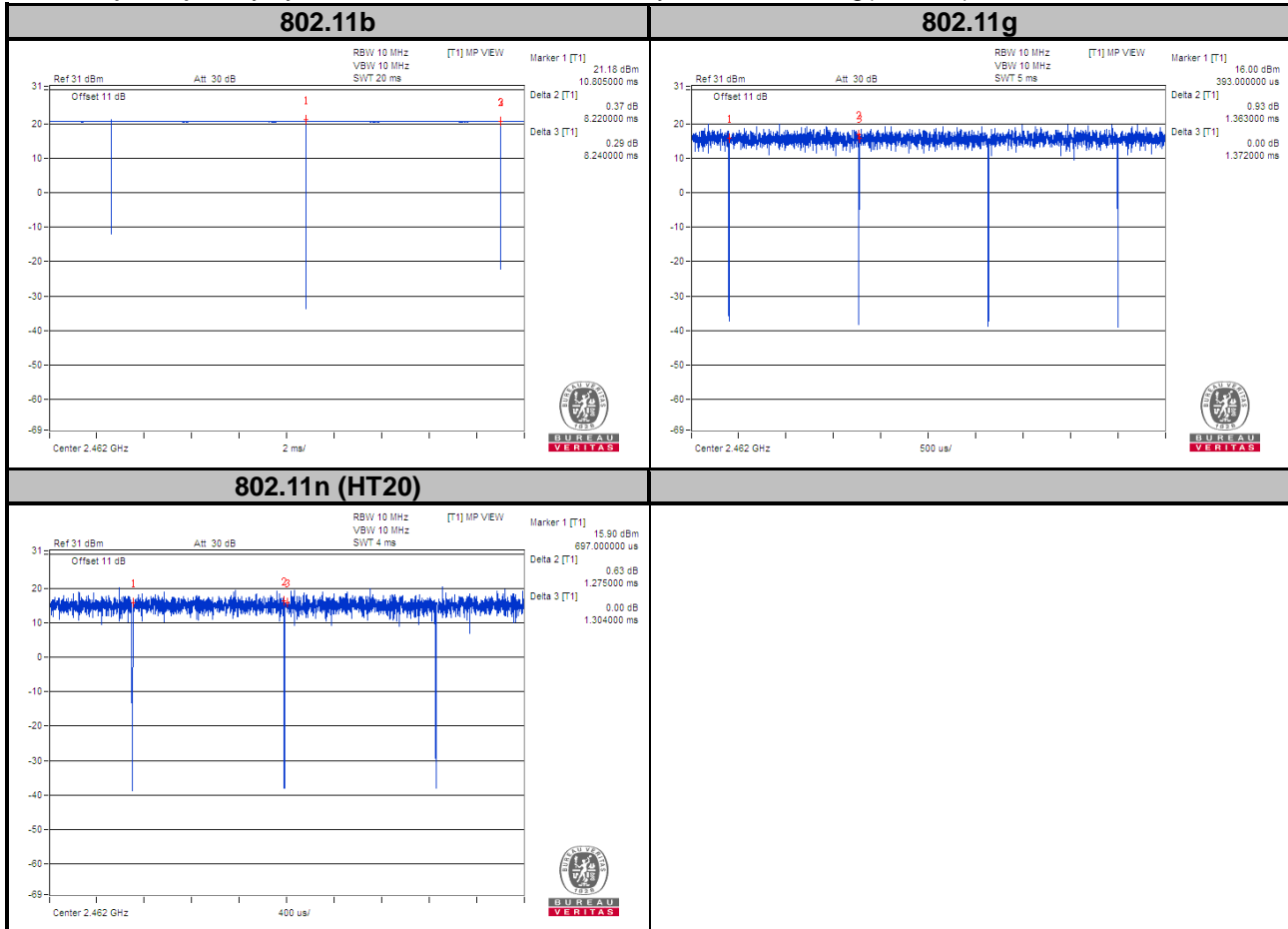

### 3.4 Description of Support Units

The EUT has been tested as an independent unit together with other necessary accessories or support units.

#### 3.4.1 Configuration of System under Test

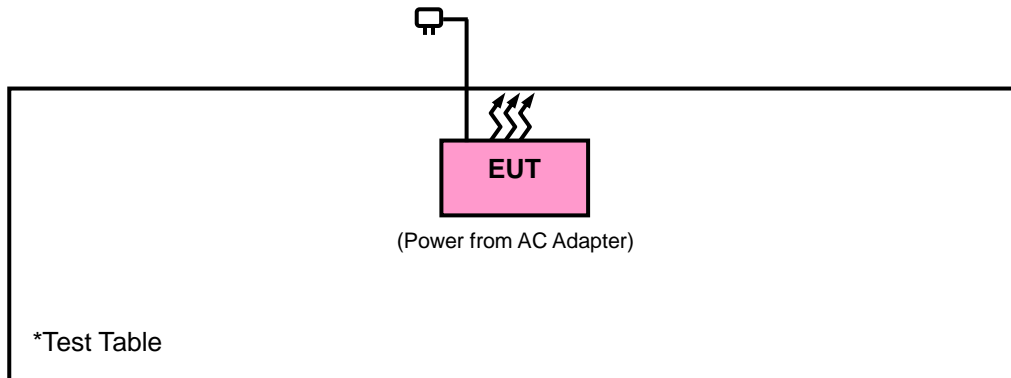

### 3.5 General Description of Applied Standards

The EUT is a RF Product. According to the specifications of the manufacturer, it must comply with the requirements of the following standards:

**FCC Part 15, Subpart C (15.247)**

**558074 D01 DTS Meas Guidance v04**

ANSI C63.10-2013

All test items have been performed and recorded as per the above standards.

## 4 Test Types and Results

### 4.1 Radiated Emission and Bandedge Measurement

#### 4.1.1 Limits of Radiated Emission and Bandedge Measurement

Radiated emissions which fall in the restricted bands must comply with the radiated emission limits specified as below table. Other emissions shall be at least 20 dB below the highest level of the desired power:

Frequencies (MHz)	Field Strength (microvolts/meter)	Measurement Distance (meters)
0.009 ~ 0.490	2400/F (kHz)	300
0.490 ~ 1.705	24000/F (kHz)	30
1.705 ~ 30.0	30	30
30 ~ 88	100	3
88 ~ 216	150	3
216 ~ 960	200	3
Above 960	500	3

**NOTE:**

1. The lower limit shall apply at the transition frequencies.
2. Emission level (dBuV/m) = 20 log Emission level (uV/m).
3. For frequencies above 1000 MHz, the field strength limits are based on average detector, however, the peak field strength of any emission shall not exceed the maximum permitted average limits, specified above by more than 20 dB under any condition of modulation.

## 4.1.2 Test Instruments

Description & Manufacturer	Model No.	Serial No.	Date of Calibration	Due Date of Calibration
Test Receiver Agilent Technologies	N9038A	MY52260177	Jul. 05, 2017	Jul. 04, 2018
Spectrum Analyzer ROHDE & SCHWARZ	FSU43	101261	Jan. 11, 2018	Jan. 10, 2019
Double Ridge Guide Horn Antenna EMCO	3115	5619	Nov. 30, 2017	Nov. 29, 2018
BILOG Antenna SCHWARZBECK	VULB 9168	9168-153	Dec. 06, 2017	Dec. 05, 2018
Fixed Attenuator Mini-Circuits	BW-N10W5+	NA	Jul. 07, 2017	Jul. 06, 2018
Bluetooth Tester	CBT	100980	Jun. 28, 2017	Jun. 27, 2019
Loop Antenna	EM-6879	269	Aug. 11, 2017	Aug. 10, 2018
Preamplifier Agilent	310N	187226	Jun. 23, 2017	Jun. 22, 2018
Preamplifier Agilent	83017A	MY39501357	Jun. 23, 2017	Jun. 22, 2018
Power Meter Anritsu	ML2495A	1012010	Aug. 15, 2017	Aug. 14, 2018
Power Sensor Anritsu	MA2411B	1315050	Aug. 15, 2017	Aug. 14, 2018
RF signal cable ETS-LINDGREN	5D-FB	Cable-CH1-01(RFC -SMS-100-SMS-12 0+RFC-SMS-100-S MS-400)	Jun. 26, 2017	Jun. 25, 2018
RF signal cable ETS-LINDGREN	8D-FB	Cable-CH1-02(RFC -SMS-100-SMS-24)	Jun. 26, 2017	Jun. 25, 2018
Boresight Antenna Fixture	FBA-01	FBA-SIP01	NA	NA
Software BV ADT	E3 8.130425b	NA	NA	NA
Antenna Tower MF	NA	NA	NA	NA
Turn Table MF	NA	NA	NA	NA
Antenna Tower & Turn Table Controller MF	MF-7802	NA	NA	NA

- Note: 1. The calibration interval of the above test instruments is 12 months and the calibrations are traceable to NML/ROC and NIST/USA.
2. The test was performed in HsinTien Chamber 1.
3. The horn antenna and preamplifier (model: 83017A) are used only for the measurement of emission frequency above 1 GHz if tested.
4. The IC Site Registration No. is IC7450I-1.

#### 4.1.3 Test Procedures

##### **For Radiated Emission below 30 MHz**

- a. The EUT was placed on the top of a rotating table 0.8 meters above the ground at a 3 meter chamber room. The table was rotated 360 degrees to determine the position of the highest radiation.
- b. The EUT was set 3 meters away from the interference-receiving antenna, which was mounted on the top of a variable-height antenna tower.
- c. Parallel, perpendicular, and ground-parallel orientations of the antenna are set to make the measurement.
- d. For each suspected emission, the EUT was arranged to its worst case and the rotatable table was turned from 0 degrees to 360 degrees to find the maximum reading.
- e. The test-receiver system was set to Quasi-Peak Detect Function and Specified Bandwidth with Maximum Hold Mode.

##### **Note:**

1. The resolution bandwidth and video bandwidth of test receiver/spectrum analyzer is 9 kHz at frequency below 30 MHz.

##### **For Radiated Emission above 30 MHz**

- a. The EUT was placed on the top of a rotating table 0.8 meters (for 30 MHz ~ 1 GHz) / 1.5 meters (for above 1 GHz) above the ground at 3 meter chamber room for test. The table was rotated 360 degrees to determine the position of the highest radiation.
- b. The EUT was set 3 meters away from the interference-receiving antenna, which was mounted on the top of a variable-height antenna tower.
- c. The height of antenna is varied from one meter to four meters above the ground to determine the maximum value of the field strength. Both horizontal and vertical polarizations of the antenna are set to make the measurement.
- d. For each suspected emission, the EUT was arranged to its worst case and then the antenna was tuned to heights from 1 meter to 4 meters and the rotatable table was turned from 0 degrees to 360 degrees to find the maximum reading.
- e. The test-receiver system was set to quasi-peak detect function and specified bandwidth with maximum hold mode when the test frequency is below 1 GHz.
- f. The test-receiver system was set to peak and average detected function and specified bandwidth with maximum hold mode when the test frequency is above 1 GHz. If the peak reading value also meets average limit, measurement with the average detector is unnecessary.

##### **Note:**

1. The resolution bandwidth and video bandwidth of test receiver/spectrum analyzer is 120 kHz for Quasi-peak detection (QP) at frequency below 1 GHz.
2. The resolution bandwidth of test receiver/spectrum analyzer is 1 MHz and the video bandwidth is 3 MHz for Peak detection (PK) at frequency above 1 GHz.
3. The resolution bandwidth of test receiver/spectrum analyzer is 1 MHz and the video bandwidth is  $\geq 1/T$  (Duty cycle < 98 %) or 10 Hz (Duty cycle  $\geq 98$  %) for Average detection (AV) at frequency above 1 GHz.  
(11b: RBW = 1 MHz, VBW = 10 Hz ; 11g: RBW = 1 MHz, VBW = 10 kHz ;  
11n (HT20): RBW = 1 MHz, VBW = 1 kHz)
4. All modes of operation were investigated and the worst-case emissions are reported.

#### 4.1.4 Deviation from Test Standard

No deviation.



#### 4.1.5 Test Set Up

##### <Radiated Emission below 30 MHz>

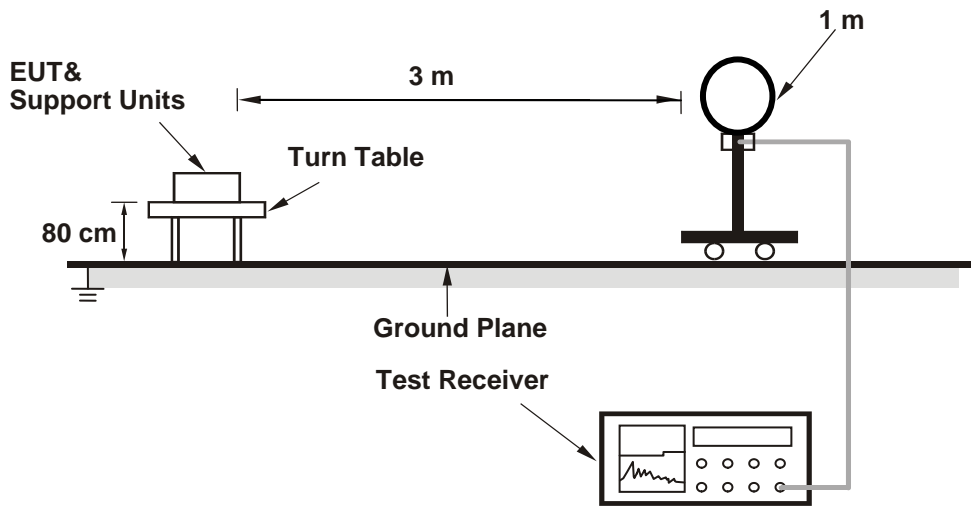

##### <Radiated Emission 30 MHz to 1 GHz>

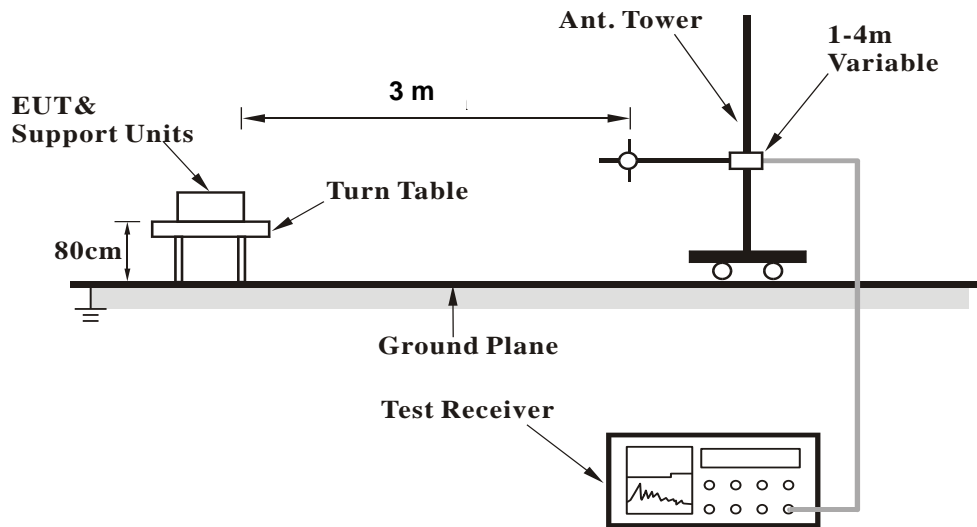

### <Radiated Emission above 1 GHz>

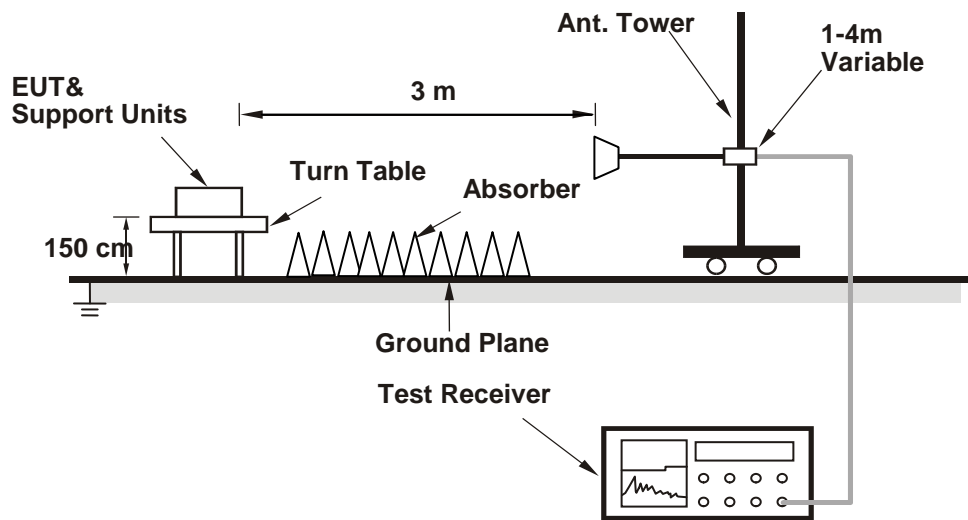

For the actual test configuration, please refer to the attached file (Test Setup Photo).

#### 4.1.6 EUT Operating Conditions

- Placed the EUT on a testing table.
- Use the software to control the EUT under transmission condition continuously at specific channel frequency.

4.1.7 Test Results

Above 1 GHz Data :  
802.11b

EUT Test Condition		Measurement Detail	
Channel	Channel 1	Frequency Range	1 GHz ~ 25 GHz
Input Power	120 Vac, 60 Hz	Detector Function	Peak (PK) Average (AV)
Environmental Conditions	25 deg. C, 65 % RH	Tested By	Karl Lee

Antennal Polarity & Test Distance: Horizontal at 3 m										
Frequency (MHz)	Emission Level (dBuV/m)	Read Level (dBuV)	Limit (dBuV/m)	Margin (dB)	Antenna Factor (dB/m)	Cable Loss (dB)	Preamp Factor (dB)	Antenna Height (cm)	Table Angle (Degree)	Remark
2389.92	41.5	39.77	54	-12.5	31.8	5.4	35.47	235	272	Average
2389.92	52.01	50.28	74	-21.99	31.8	5.4	35.47	235	272	Peak
2412	100.89	99.12			31.81	5.43	35.47	235	272	Average
2412	103.63	101.86			31.81	5.43	35.47	235	272	Peak
4824	47.68	39.55	54	-6.32	33.97	8.26	34.1	201	155	Average
4824	53.21	45.08	74	-20.79	33.97	8.26	34.1	201	155	Peak

Antennal Polarity & Test Distance: Vertical at 3 m										
Frequency (MHz)	Emission Level (dBuV/m)	Read Level (dBuV)	Limit (dBuV/m)	Margin (dB)	Antenna Factor (dB/m)	Cable Loss (dB)	Preamp Factor (dB)	Antenna Height (cm)	Table Angle (Degree)	Remark
2388.66	41.24	39.53	54	-12.76	31.8	5.4	35.49	133	213	Average
2388.66	52.47	50.76	74	-21.53	31.8	5.4	35.49	133	213	Peak
2412	100.39	98.62			31.81	5.43	35.47	133	213	Average
2412	103.11	101.34			31.81	5.43	35.47	133	213	Peak
4824	52.6	44.47	54	-1.4	33.97	8.26	34.1	149	84	Average
4824	55.78	47.65	74	-18.22	33.97	8.26	34.1	149	84	Peak

Remarks:

- Emission Level = Read Level + Antenna Factor + Cable Loss - Preamp Factor  
Margin value = Emission level – Limit value
- 2412 MHz: Fundamental frequency.

EUT Test Condition		Measurement Detail	
Channel	Channel 6	Frequency Range	1 GHz ~ 25 GHz
Input Power	120 Vac, 60 Hz	Detector Function	Peak (PK) Average (AV)
Environmental Conditions	25 deg. C, 65 % RH	Tested By	Karl Lee

Antennal Polarity & Test Distance: Horizontal at 3 m										
Frequency (MHz)	Emission Level (dBuV/m)	Read Level (dBuV)	Limit (dBuV/m)	Margin (dB)	Antenna Factor (dB/m)	Cable Loss (dB)	Preamp Factor (dB)	Antenna Height (cm)	Table Angle (Degree)	Remark
2387.85	40.77	39.06	54	-13.23	31.8	5.4	35.49	225	272	Average
2387.85	52.03	50.32	74	-21.97	31.8	5.4	35.49	225	272	Peak
2437	103.27	101.42			31.85	5.46	35.46	225	272	Average
2437	105.9	104.05			31.85	5.46	35.46	225	272	Peak
2483.72	41.14	39.18	54	-12.86	31.88	5.5	35.42	225	272	Average
2483.72	52.27	50.31	74	-21.73	31.88	5.5	35.42	225	272	Peak
4874	46.91	38.72	54	-7.09	33.98	8.27	34.06	221	160	Average
4874	53.69	45.5	74	-20.31	33.98	8.27	34.06	221	160	Peak

Antennal Polarity & Test Distance: Vertical at 3 m										
Frequency (MHz)	Emission Level (dBuV/m)	Read Level (dBuV)	Limit (dBuV/m)	Margin (dB)	Antenna Factor (dB/m)	Cable Loss (dB)	Preamp Factor (dB)	Antenna Height (cm)	Table Angle (Degree)	Remark
2389.2	41.01	39.3	54	-12.99	31.8	5.4	35.49	129	213	Average
2389.2	51.9	50.19	74	-22.1	31.8	5.4	35.49	129	213	Peak
2437	102.8	100.95			31.85	5.46	35.46	129	213	Average
2437	105.5	103.65			31.85	5.46	35.46	129	213	Peak
2483.6	41.3	39.34	54	-12.7	31.88	5.5	35.42	129	213	Average
2483.6	51.8	49.84	74	-22.2	31.88	5.5	35.42	129	213	Peak
4874	50.07	41.88	54	-3.93	33.98	8.27	34.06	161	81	Average
4874	54.97	46.78	74	-19.03	33.98	8.27	34.06	161	81	Peak

Remarks:

- Emission Level = Read Level + Antenna Factor + Cable Loss - Preamp Factor  
Margin value = Emission level – Limit value
- 2437 MHz: Fundamental frequency.

EUT Test Condition		Measurement Detail	
Channel	Channel 11	Frequency Range	1 GHz ~ 25 GHz
Input Power	120 Vac, 60 Hz	Detector Function	Peak (PK) Average (AV)
Environmental Conditions	25 deg. C, 65 % RH	Tested By	Karl Lee

Antennal Polarity & Test Distance: Horizontal at 3 m										
Frequency (MHz)	Emission Level (dBuV/m)	Read Level (dBuV)	Limit (dBuV/m)	Margin (dB)	Antenna Factor (dB/m)	Cable Loss (dB)	Preamp Factor (dB)	Antenna Height (cm)	Table Angle (Degree)	Remark
2462	103.06	101.13			31.87	5.5	35.44	256	274	Average
2462	105.72	103.79			31.87	5.5	35.44	256	274	Peak
2483.68	42.15	40.19	54	-11.85	31.88	5.5	35.42	256	274	Average
2483.68	53.31	51.35	74	-20.69	31.88	5.5	35.42	256	274	Peak
4924	47.13	38.88	54	-6.87	33.99	8.28	34.02	247	164	Average
4924	52.26	44.01	74	-21.74	33.99	8.28	34.02	247	164	Peak

Antennal Polarity & Test Distance: Vertical at 3 m										
Frequency (MHz)	Emission Level (dBuV/m)	Read Level (dBuV)	Limit (dBuV/m)	Margin (dB)	Antenna Factor (dB/m)	Cable Loss (dB)	Preamp Factor (dB)	Antenna Height (cm)	Table Angle (Degree)	Remark
2462	102.65	100.72			31.87	5.5	35.44	118	213	Average
2462	105.32	103.39			31.87	5.5	35.44	118	213	Peak
2483.72	41.74	39.78	54	-12.26	31.88	5.5	35.42	118	213	Average
2483.72	52.66	50.7	74	-21.34	31.88	5.5	35.42	118	213	Peak
4924	50.27	42.02	54	-3.73	33.99	8.28	34.02	169	79	Average
4924	54.63	46.38	74	-19.37	33.99	8.28	34.02	169	79	Peak

Remarks:

- Emission Level = Read Level + Antenna Factor + Cable Loss - Preamp Factor  
Margin value = Emission level – Limit value
- 2462 MHz: Fundamental frequency.

## 802.11g

EUT Test Condition		Measurement Detail	
Channel	Channel 1	Frequency Range	1 GHz ~ 25 GHz
Input Power	120 Vac, 60 Hz	Detector Function	Peak (PK) Average (AV)
Environmental Conditions	25 deg. C, 65 % RH	Tested By	Karl Lee

**Antennal Polarity & Test Distance: Horizontal at 3 m**

Frequency (MHz)	Emission Level (dBuV/m)	Read Level (dBuV)	Limit (dBuV/m)	Margin (dB)	Antenna Factor (dB/m)	Cable Loss (dB)	Preamp Factor (dB)	Antenna Height (cm)	Table Angle (Degree)	Remark
2389.92	46.19	44.46	54	-7.81	31.8	5.4	35.47	235	272	Average
2389.92	62.25	60.52	74	-11.75	31.8	5.4	35.47	235	272	Peak
2412	96.16	94.39			31.81	5.43	35.47	235	272	Average
2412	104.72	102.95			31.81	5.43	35.47	235	272	Peak
4824	37.42	29.29	54	-16.58	33.97	8.26	34.1	156	249	Average
4824	47.51	39.38	74	-26.49	33.97	8.26	34.1	156	249	Peak

**Antennal Polarity & Test Distance: Vertical at 3 m**

Frequency (MHz)	Emission Level (dBuV/m)	Read Level (dBuV)	Limit (dBuV/m)	Margin (dB)	Antenna Factor (dB/m)	Cable Loss (dB)	Preamp Factor (dB)	Antenna Height (cm)	Table Angle (Degree)	Remark
2389.92	45.28	43.55	54	-8.72	31.8	5.4	35.47	133	213	Average
2389.92	60.51	58.78	74	-13.49	31.8	5.4	35.47	133	213	Peak
2412	96.05	94.28			31.81	5.43	35.47	133	213	Average
2412	104.31	102.54			31.81	5.43	35.47	133	213	Peak
4824	37.82	29.69	54	-16.18	33.97	8.26	34.1	116	154	Average
4824	47.76	39.63	74	-26.24	33.97	8.26	34.1	116	154	Peak

## Remarks:

- Emission Level = Read Level + Antenna Factor + Cable Loss - Preamp Factor  
Margin value = Emission level – Limit value
- 2412 MHz: Fundamental frequency.

EUT Test Condition		Measurement Detail	
Channel	Channel 6	Frequency Range	1 GHz ~ 25 GHz
Input Power	120 Vac, 60 Hz	Detector Function	Peak (PK) Average (AV)
Environmental Conditions	25 deg. C, 65 % RH	Tested By	Karl Lee

Antennal Polarity & Test Distance: Horizontal at 3 m										
Frequency (MHz)	Emission Level (dBuV/m)	Read Level (dBuV)	Limit (dBuV/m)	Margin (dB)	Antenna Factor (dB/m)	Cable Loss (dB)	Preamp Factor (dB)	Antenna Height (cm)	Table Angle (Degree)	Remark
2389.11	40.84	39.13	54	-13.16	31.8	5.4	35.49	225	272	Average
2389.11	51.54	49.83	74	-22.46	31.8	5.4	35.49	225	272	Peak
2437	96.52	94.67			31.85	5.46	35.46	225	272	Average
2437	104.59	102.74			31.85	5.46	35.46	225	272	Peak
2483.96	41.16	39.2	54	-12.84	31.88	5.5	35.42	225	272	Average
2483.96	52.24	50.28	74	-21.76	31.88	5.5	35.42	225	272	Peak
4874	37.61	29.42	54	-16.39	33.98	8.27	34.06	105	112	Average
4874	47.56	39.37	74	-26.44	33.98	8.27	34.06	105	112	Peak

Antennal Polarity & Test Distance: Vertical at 3 m										
Frequency (MHz)	Emission Level (dBuV/m)	Read Level (dBuV)	Limit (dBuV/m)	Margin (dB)	Antenna Factor (dB/m)	Cable Loss (dB)	Preamp Factor (dB)	Antenna Height (cm)	Table Angle (Degree)	Remark
2384.79	40.81	39.12	54	-13.19	31.78	5.4	35.49	129	213	Average
2384.79	51.48	49.79	74	-22.52	31.78	5.4	35.49	129	213	Peak
2437	96.15	94.3			31.85	5.46	35.46	129	213	Average
2437	104.07	102.22			31.85	5.46	35.46	129	213	Peak
2485.68	41.02	39.03	54	-12.98	31.88	5.53	35.42	129	213	Average
2485.68	51.77	49.78	74	-22.23	31.88	5.53	35.42	129	213	Peak
4874	37.59	29.4	54	-16.41	33.98	8.27	34.06	112	342	Average
4874	47.74	39.55	74	-26.26	33.98	8.27	34.06	112	342	Peak

Remarks:

- Emission Level = Read Level + Antenna Factor + Cable Loss - Preamp Factor  
Margin value = Emission level – Limit value
- 2437 MHz: Fundamental frequency.

EUT Test Condition		Measurement Detail	
Channel	Channel 11	Frequency Range	1 GHz ~ 25 GHz
Input Power	120 Vac, 60 Hz	Detector Function	Peak (PK) Average (AV)
Environmental Conditions	25 deg. C, 65 % RH	Tested By	Karl Lee

Antennal Polarity & Test Distance: Horizontal at 3 m										
Frequency (MHz)	Emission Level (dBuV/m)	Read Level (dBuV)	Limit (dBuV/m)	Margin (dB)	Antenna Factor (dB/m)	Cable Loss (dB)	Preamp Factor (dB)	Antenna Height (cm)	Table Angle (Degree)	Remark
2462	95.7	93.77			31.87	5.5	35.44	256	274	Average
2462	104.32	102.39			31.87	5.5	35.44	256	274	Peak
2483.52	43.45	41.49	54	-10.55	31.88	5.5	35.42	256	274	Average
2483.52	59.47	57.51	74	-14.53	31.88	5.5	35.42	256	274	Peak
4924	37.64	29.39	54	-16.36	33.99	8.28	34.02	127	304	Average
4924	47.91	39.66	74	-26.09	33.99	8.28	34.02	127	304	Peak

Antennal Polarity & Test Distance: Vertical at 3 m										
Frequency (MHz)	Emission Level (dBuV/m)	Read Level (dBuV)	Limit (dBuV/m)	Margin (dB)	Antenna Factor (dB/m)	Cable Loss (dB)	Preamp Factor (dB)	Antenna Height (cm)	Table Angle (Degree)	Remark
2462	95.48	93.55			31.87	5.5	35.44	118	213	Average
2462	104.07	102.14			31.87	5.5	35.44	118	213	Peak
2483.52	43.01	41.05	54	-10.99	31.88	5.5	35.42	118	213	Average
2483.52	60.32	58.36	74	-13.68	31.88	5.5	35.42	118	213	Peak
4924	37.39	29.14	54	-16.61	33.99	8.28	34.02	154	108	Average
4924	47.43	39.18	74	-26.57	33.99	8.28	34.02	154	108	Peak

Remarks:

- Emission Level = Read Level + Antenna Factor + Cable Loss - Preamp Factor  
Margin value = Emission level – Limit value
- 2462 MHz: Fundamental frequency.



### 802.11n (HT20)

EUT Test Condition		Measurement Detail	
Channel	Channel 1	Frequency Range	1 GHz ~ 25 GHz
Input Power	120 Vac, 60 Hz	Detector Function	Peak (PK) Average (AV)
Environmental Conditions	25 deg. C, 65 % RH	Tested By	Karl Lee

#### Antennal Polarity & Test Distance: Horizontal at 3 m

Frequency (MHz)	Emission Level (dBuV/m)	Read Level (dBuV)	Limit (dBuV/m)	Margin (dB)	Antenna Factor (dB/m)	Cable Loss (dB)	Preamp Factor (dB)	Antenna Height (cm)	Table Angle (Degree)	Remark
2389.65	47.9	46.19	54	-6.1	31.8	5.4	35.49	235	272	Average
2389.65	63.19	61.48	74	-10.81	31.8	5.4	35.49	235	272	Peak
2412	96.01	94.24			31.81	5.43	35.47	235	272	Average
2412	104.53	102.76			31.81	5.43	35.47	235	272	Peak
4824	37.84	29.71	54	-16.16	33.97	8.26	34.1	164	203	Average
4824	48.48	40.35	74	-25.52	33.97	8.26	34.1	164	203	Peak

#### Antennal Polarity & Test Distance: Vertical at 3 m

Frequency (MHz)	Emission Level (dBuV/m)	Read Level (dBuV)	Limit (dBuV/m)	Margin (dB)	Antenna Factor (dB/m)	Cable Loss (dB)	Preamp Factor (dB)	Antenna Height (cm)	Table Angle (Degree)	Remark
2389.92	47.28	45.55	54	-6.72	31.8	5.4	35.47	133	213	Average
2389.92	62.73	61	74	-11.27	31.8	5.4	35.47	133	213	Peak
2412	95.19	93.42			31.81	5.43	35.47	133	213	Average
2412	104.15	102.38			31.81	5.43	35.47	133	213	Peak
4824	37.49	29.36	54	-16.51	33.97	8.26	34.1	132	110	Average
4824	47.7	39.57	74	-26.3	33.97	8.26	34.1	132	110	Peak

#### Remarks:

- Emission Level = Read Level + Antenna Factor + Cable Loss - Preamp Factor  
Margin value = Emission level – Limit value
- 2412 MHz: Fundamental frequency.

EUT Test Condition		Measurement Detail	
Channel	Channel 6	Frequency Range	1 GHz ~ 25 GHz
Input Power	120 Vac, 60 Hz	Detector Function	Peak (PK) Average (AV)
Environmental Conditions	25 deg. C, 65 % RH	Tested By	Karl Lee

Antennal Polarity & Test Distance: Horizontal at 3 m										
Frequency (MHz)	Emission Level (dBuV/m)	Read Level (dBuV)	Limit (dBuV/m)	Margin (dB)	Antenna Factor (dB/m)	Cable Loss (dB)	Preamp Factor (dB)	Antenna Height (cm)	Table Angle (Degree)	Remark
2385.6	41.01	39.3	54	-12.99	31.8	5.4	35.49	225	272	Average
2385.6	51.67	49.96	74	-22.33	31.8	5.4	35.49	225	272	Peak
2437	96.17	94.32			31.85	5.46	35.46	225	272	Average
2437	104.97	103.12			31.85	5.46	35.46	225	272	Peak
2485.04	41.17	39.18	54	-12.83	31.88	5.53	35.42	225	272	Average
2485.04	52.63	50.64	74	-21.37	31.88	5.53	35.42	225	272	Peak
4874	37.45	29.26	54	-16.55	33.98	8.27	34.06	139	261	Average
4874	47.89	39.7	74	-26.11	33.98	8.27	34.06	139	261	Peak
Antennal Polarity & Test Distance: Vertical at 3 m										
Frequency (MHz)	Emission Level (dBuV/m)	Read Level (dBuV)	Limit (dBuV/m)	Margin (dB)	Antenna Factor (dB/m)	Cable Loss (dB)	Preamp Factor (dB)	Antenna Height (cm)	Table Angle (Degree)	Remark
2385.69	40.98	39.27	54	-13.02	31.8	5.4	35.49	129	213	Average
2385.69	51.8	50.09	74	-22.2	31.8	5.4	35.49	129	213	Peak
2437	96.16	94.31			31.85	5.46	35.46	129	213	Average
2437	104.42	102.57			31.85	5.46	35.46	129	213	Peak
2484.52	41.08	39.09	54	-12.92	31.88	5.53	35.42	129	213	Average
2484.52	52.56	50.57	74	-21.44	31.88	5.53	35.42	129	213	Peak
4874	37.21	29.02	54	-16.79	33.98	8.27	34.06	166	227	Average
4874	47.09	38.9	74	-26.91	33.98	8.27	34.06	166	227	Peak

Remarks:

- Emission Level = Read Level + Antenna Factor + Cable Loss - Preamp Factor  
Margin value = Emission level – Limit value
- 2437 MHz: Fundamental frequency.

EUT Test Condition		Measurement Detail	
Channel	Channel 11	Frequency Range	1 GHz ~ 25 GHz
Input Power	120 Vac, 60 Hz	Detector Function	Peak (PK) Average (AV)
Environmental Conditions	25 deg. C, 65 % RH	Tested By	Karl Lee

Antennal Polarity & Test Distance: Horizontal at 3 m										
Frequency (MHz)	Emission Level (dBuV/m)	Read Level (dBuV)	Limit (dBuV/m)	Margin (dB)	Antenna Factor (dB/m)	Cable Loss (dB)	Preamp Factor (dB)	Antenna Height (cm)	Table Angle (Degree)	Remark
2462	96.48	94.55			31.87	5.5	35.44	256	274	Average
2462	104.47	102.54			31.87	5.5	35.44	256	274	Peak
2483.52	45.8	43.84	54	-8.2	31.88	5.5	35.42	256	274	Average
2483.52	60.83	58.87	74	-13.17	31.88	5.5	35.42	256	274	Peak
4924	38.11	29.86	54	-15.89	33.99	8.28	34.02	164	232	Average
4924	49.2	40.95	74	-24.8	33.99	8.28	34.02	164	232	Peak
Antennal Polarity & Test Distance: Vertical at 3 m										
Frequency (MHz)	Emission Level (dBuV/m)	Read Level (dBuV)	Limit (dBuV/m)	Margin (dB)	Antenna Factor (dB/m)	Cable Loss (dB)	Preamp Factor (dB)	Antenna Height (cm)	Table Angle (Degree)	Remark
2462	95.64	93.71			31.87	5.5	35.44	118	213	Average
2462	104.27	102.34			31.87	5.5	35.44	118	213	Peak
2483.56	45.02	43.06	54	-8.98	31.88	5.5	35.42	118	213	Average
2483.56	61.06	59.1	74	-12.94	31.88	5.5	35.42	118	213	Peak
4924	38.02	29.77	54	-15.98	33.99	8.28	34.02	112	150	Average
4924	48.24	39.99	74	-25.76	33.99	8.28	34.02	112	150	Peak

Remarks:

- Emission Level = Read Level + Antenna Factor + Cable Loss - Preamp Factor  
Margin value = Emission level – Limit value
- 2462 MHz: Fundamental frequency.

**9 kHz ~ 30 MHz Data:**

The amplitude of spurious emissions attenuated more than 20 dB below the permissible value is not required to be report.

**30 MHz ~ 1 GHz Worst-Case Data:**

**802.11b**

EUT Test Condition		Measurement Detail	
Channel	Channel 1	Frequency Range	30 MHz ~ 1 GHz
Input Power	120 Vac, 60 Hz	Detector Function	Peak (PK) Quasi-peak (QP)
Environmental Conditions	25 deg. C, 65 % RH	Tested By	Karl Lee

**Horizontal**

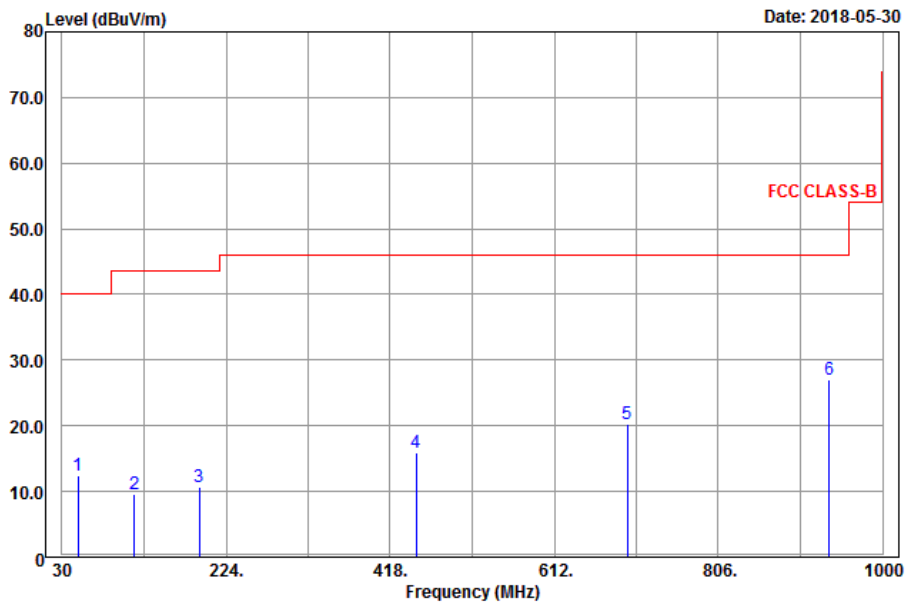

**Vertical**

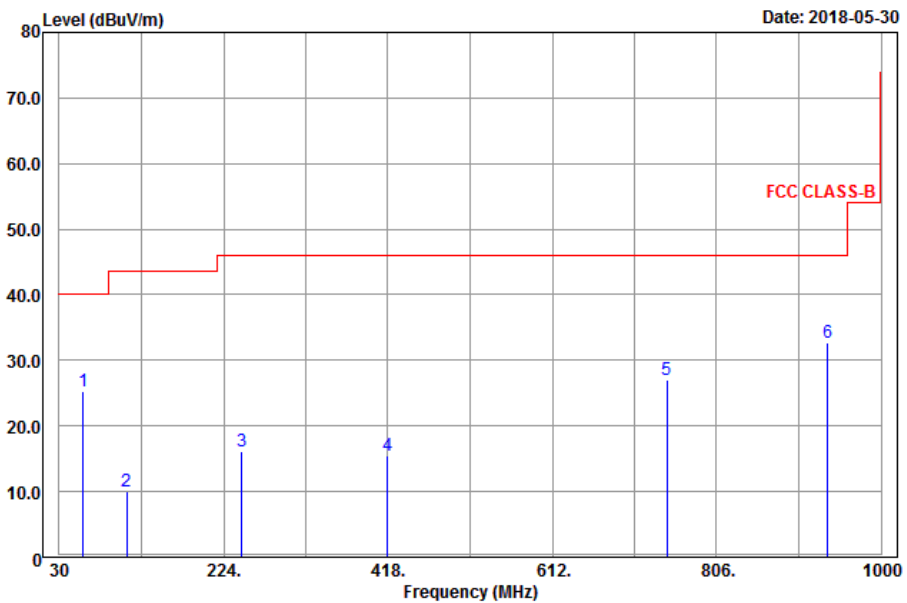

Antennal Polarity & Test Distance: Horizontal at 3 m										
Frequency (MHz)	Emission Level (dBuV/m)	Read Level (dBuV)	Limit (dBuV/m)	Margin (dB)	Antenna Factor (dB/m)	Cable Loss (dB)	Preamp Factor (dB)	Antenna Height (cm)	Table Angle (Degree)	Remark
48.63	12.36	29.12	40	-27.64	14.56	0.9	32.22	161	121	Peak
115.86	9.59	29.49	43.5	-33.91	11.07	1.28	32.25	123	190	Peak
192.27	10.62	30.52	43.5	-32.88	10.75	1.61	32.26	143	187	Peak
448.4	15.84	29.96	46	-30.16	15.54	2.49	32.15	147	154	Peak
698.3	20.29	30.06	46	-25.71	19.21	3.11	32.09	130	156	Peak
937	27.03	32.97	46	-18.97	21.65	3.62	31.21	111	108	Peak
Antennal Polarity & Test Distance: Vertical at 3 m										
Frequency (MHz)	Emission Level (dBuV/m)	Read Level (dBuV)	Limit (dBuV/m)	Margin (dB)	Antenna Factor (dB/m)	Cable Loss (dB)	Preamp Factor (dB)	Antenna Height (cm)	Table Angle (Degree)	Remark
58.35	25.21	42.86	40	-14.79	13.68	0.9	32.23	134	161	Peak
109.38	10.07	29.01	43.5	-33.43	12.03	1.28	32.25	189	240	Peak
245.19	16.21	34.27	46	-29.79	12.21	1.85	32.12	123	168	Peak
417.6	15.42	30	46	-30.58	15.21	2.41	32.2	125	180	Peak
747.3	27.14	36.28	46	-18.86	19.78	3.22	32.14	165	193	Peak
937	32.65	38.59	46	-13.35	21.65	3.62	31.21	142	146	Peak

Remarks:

- Emission Level = Read Level + Antenna Factor + Cable Loss - Preamp Factor  
Margin value = Emission level – Limit value

## 4.2 Conducted Emission Measurement

### 4.2.1 Limits of Conducted Emission Measurement

Frequency (MHz)	Conducted Limit (dBuV)	
	Quasi-Peak	Average
0.15 - 0.5	66 - 56	56 - 46
0.50 - 5.0	56	46
5.0 - 30.0	60	50

- Note: 1. The lower limit shall apply at the transition frequencies.  
 2. The limit decreases in line with the logarithm of the frequency in the range of 0.15 to 0.50 MHz.

### 4.2.2 Test Instruments

Description & Manufacturer	Model No.	Serial No.	Date of Calibration	Due Date of Calibration
Test Receiver ROHDE & SCHWARZ	ESCI	100613	Nov. 23, 2017	Nov. 22, 2018
RF signal cable (with 10dB PAD) Woken	5D-FB	Cable-cond1-01	Sep. 05, 2017	Sep. 04, 2018
LISN/AMN ROHDE & SCHWARZ (EUT)	ESH3-Z5	835239/001	Mar. 06, 2018	Mar. 05, 2019
LISN/AMN ROHDE & SCHWARZ (Peripheral)	ESH3-Z5	100311	Aug. 15, 2017	Aug. 14, 2018
Software ADT	BV ADT_Cond_ V7.3.7.3	NA	NA	NA

- Note: 1. The calibration interval of the above test instruments is 12 months and the calibrations are traceable to NML/ROC and NIST/USA.  
 2. The test was performed in HwaYa Shielded Room 1.  
 3. The VCCI Site Registration No. is C-2040.

#### 4.2.3 Test Procedures

- a. The EUT was placed 0.4 meters from the conducting wall of the shielded room with EUT being connected to the power mains through a line impedance stabilization network (LISN). Other support units were connected to the power mains through another LISN. The two LISNs provide 50 ohm/50 uH of coupling impedance for the measuring instrument.
- b. Both lines of the power mains connected to the EUT were checked for maximum conducted interference.
- c. The frequency range from 150 kHz to 30 MHz was searched. Emission levels under (Limit – 20 dB) was not recorded.

**Note:** The resolution bandwidth and video bandwidth of test receiver is 9 kHz for quasi-peak detection (QP) and average detection (AV) at frequency 0.15 MHz – 30 MHz.

#### 4.2.4 Deviation from Test Standard

No deviation.

#### 4.2.5 Test Setup

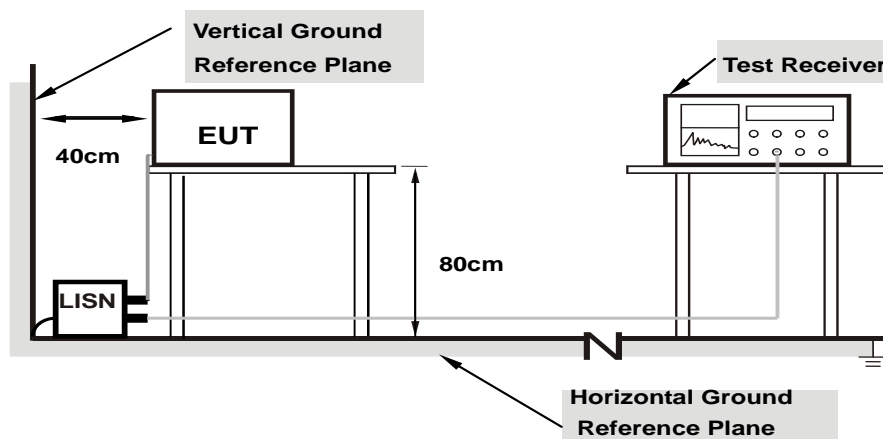

**Note:** 1.Support units were connected to second LISN.

For the actual test configuration, please refer to the attached file (Test Setup Photo).

#### 4.2.6 EUT Operating Conditions

- a. Placed the EUT on a testing table.
- b. Use the software to control the EUT under transmission condition continuously at specific channel frequency.

#### 4.2.7 Test Results

Frequency Range	150kHz ~ 30MHz	Detector Function & Resolution Bandwidth	Quasi-Peak (QP) / Average (AV), 9kHz
Input Power	120Vac, 60Hz	Environmental Conditions	25°C, 65%RH
Tested by	Getaz Yang	Test Date	2018/6/5

Phase Of Power : Line (L)										
No	Frequency (MHz)	Correction Factor (dB)	Reading Value (dBuV)		Emission Level (dBuV)		Limit (dBuV)		Margin (dB)	
			Q.P.	AV.	Q.P.	AV.	Q.P.	AV.	Q.P.	AV.
1	0.17346	10.10	24.99	13.21	35.09	23.31	64.79	54.79	-29.70	-31.48
2	0.20083	10.10	25.76	10.03	35.86	20.13	63.58	53.58	-27.72	-33.45
3	0.25593	10.11	21.90	11.25	32.01	21.36	61.56	51.56	-29.55	-30.20
4	0.50972	10.12	11.01	0.23	21.13	10.35	56.00	46.00	-34.87	-35.65
5	4.59958	10.32	11.07	0.76	21.39	11.08	56.00	46.00	-34.61	-34.92
6	17.59642	11.07	13.00	0.22	24.07	11.29	60.00	50.00	-35.93	-38.71

Remarks:

1. Q.P. and AV. are abbreviations of quasi-peak and average individually.
2. The emission levels of other frequencies were very low against the limit.
3. Margin value = Emission level – Limit value
4. Correction factor = Insertion loss + Cable loss
5. Emission Level = Correction Factor + Reading Value

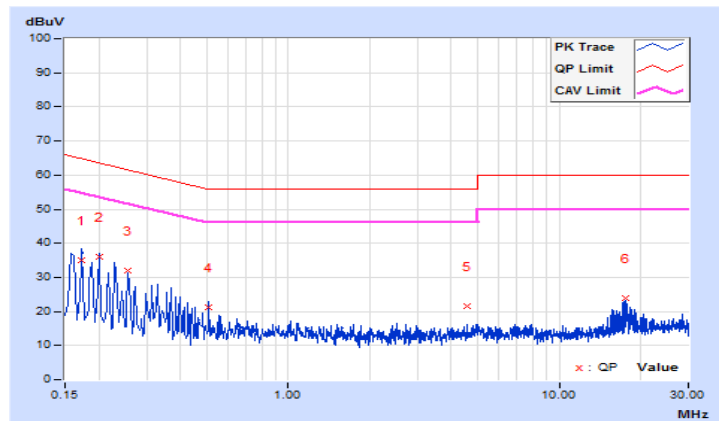



Frequency Range	150kHz ~ 30MHz	Detector Function & Resolution Bandwidth	Quasi-Peak (QP) / Average (AV), 9kHz
Input Power	120Vac, 60Hz	Environmental Conditions	25°C, 65%RH
Tested by	Getaz Yang	Test Date	2018/6/5

Phase Of Power : Neutral (N)										
No	Frequency (MHz)	Correction Factor (dB)	Reading Value (dBuV)		Emission Level (dBuV)		Limit (dBuV)		Margin (dB)	
			Q.P.	AV.	Q.P.	AV.	Q.P.	AV.	Q.P.	AV.
1	0.15000	10.10	26.61	11.35	36.71	21.45	66.00	56.00	-29.29	-34.55
2	0.17346	10.10	23.42	9.56	33.52	19.66	64.79	54.79	-31.27	-35.13
3	0.21647	10.10	19.30	7.36	29.40	17.46	62.95	52.95	-33.55	-35.49
4	0.32595	10.11	14.50	2.87	24.61	12.98	59.55	49.55	-34.94	-36.57
5	1.13141	10.14	11.14	0.34	21.28	10.48	56.00	46.00	-34.72	-35.52
6	17.29926	10.83	12.04	0.20	22.87	11.03	60.00	50.00	-37.13	-38.97

Remarks:

1. Q.P. and AV. are abbreviations of quasi-peak and average individually.
2. The emission levels of other frequencies were very low against the limit.
3. Margin value = Emission level – Limit value
4. Correction factor = Insertion loss + Cable loss
5. Emission Level = Correction Factor + Reading Value

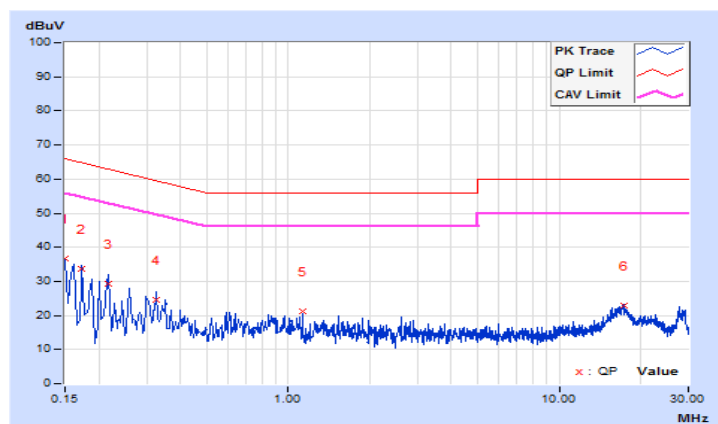

### 4.3 6 dB Bandwidth Measurement

#### 4.3.1 Limits of 6 dB Bandwidth Measurement

The minimum of 6 dB Bandwidth Measurement is 0.5 MHz.

#### 4.3.2 Test Setup

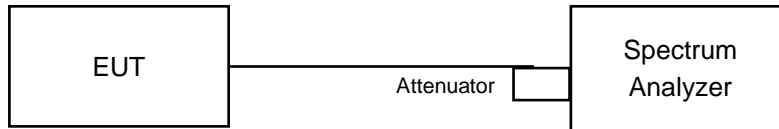

#### 4.3.3 Test Instruments

Refer to section 4.1.2 to get information of above instrument.

#### 4.3.4 Test Procedure

- Set resolution bandwidth (RBW) = 100 kHz
- Set the video bandwidth (VBW)  $\geq 3 \times$  RBW, Detector = Peak.
- Trace mode = max hold.
- Sweep = auto couple.
- Measure the maximum width of the emission that is constrained by the frequencies associated with the two amplitude points (upper and lower) that are attenuated by 6 dB relative to the maximum level measured in the fundamental emission

#### 4.3.5 Deviation from Test Standard

No deviation.

#### 4.3.6 EUT Operating Conditions

The software provided by client to enable the EUT under transmission condition continuously at lowest, middle and highest channel frequencies individually.

#### 4.3.7 Test Results

##### 802.11b

Channel	Frequency (MHz)	6 dB Bandwidth (MHz)	Minimum Limit (MHz)	Pass / Fail
1	2412	9.56	0.5	Pass
6	2437	9.07	0.5	Pass
11	2462	9.59	0.5	Pass

##### 802.11g

Channel	Frequency (MHz)	6 dB Bandwidth (MHz)	Minimum Limit (MHz)	Pass / Fail
1	2412	16.39	0.5	Pass
6	2437	16.49	0.5	Pass
11	2462	16.12	0.5	Pass

##### 802.11n (HT20)

Channel	Frequency (MHz)	6 dB Bandwidth (MHz)	Minimum Limit (MHz)	Pass / Fail
1	2412	17.60	0.5	Pass
6	2437	17.65	0.5	Pass
11	2462	16.72	0.5	Pass

### Spectrum Plot of Worst Value

#### 802.11b

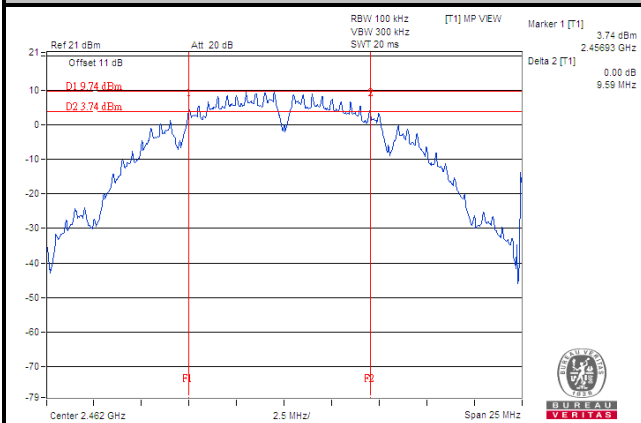

#### 802.11g

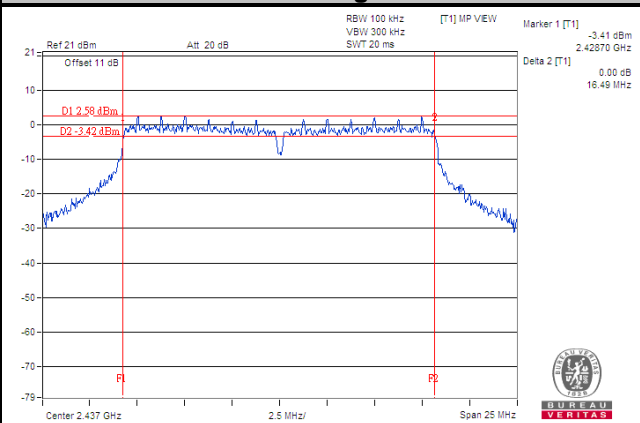

#### 802.11n (HT20)

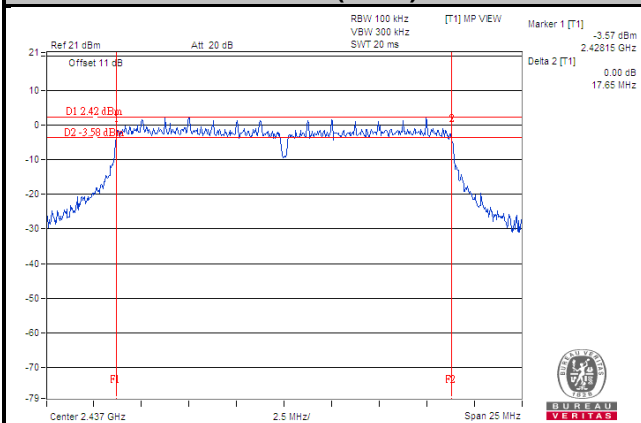

## 4.4 Occupied Bandwidth Measurement

### 4.4.1 Test Setup

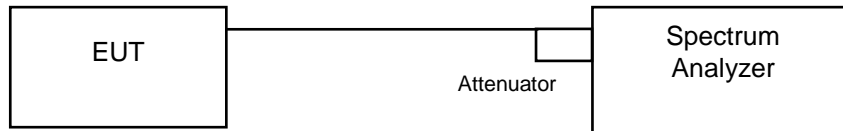

### 4.4.2 Test Instruments

Refer to section 4.1.2 to get information of above instrument.

### 4.4.3 Test Procedure

The transmitter output was connected to the spectrum analyzer through an attenuator. The bandwidth of the fundamental frequency was measured by spectrum analyzer with resolution bandwidth in the range of 1 % to 5 % of the anticipated emission bandwidth, and a video bandwidth at least 3x the resolution bandwidth and set the detector to PEAK. The width of a frequency band such that, below the lower and above the upper frequency limits, the mean powers emitted are each equal to a specified percentage 0.5 % of the total mean power of a given emission.

### 4.4.4 Deviation from Test Standard

No deviation.

### 4.4.5 EUT Operating Conditions

The software provided by client to enable the EUT under transmission condition continuously at lowest, middle and highest channel frequencies individually.

#### 4.4.6 Test Results

##### 802.11b

Channel	Frequency (MHz)	Occupied Bandwidth (MHz)	Pass / Fail
1	2412	14.04	Pass
6	2437	13.94	Pass
11	2462	14.52	Pass

##### 802.11g

Channel	Frequency (MHz)	Occupied Bandwidth (MHz)	Pass / Fail
1	2412	17.12	Pass
6	2437	17.41	Pass
11	2462	17.11	Pass

##### 802.11n (HT20)

Channel	Frequency (MHz)	Occupied Bandwidth (MHz)	Pass / Fail
1	2412	18.08	Pass
6	2437	18.46	Pass
11	2462	18.07	Pass

### Spectrum Plot of Worst Value

#### 802.11b

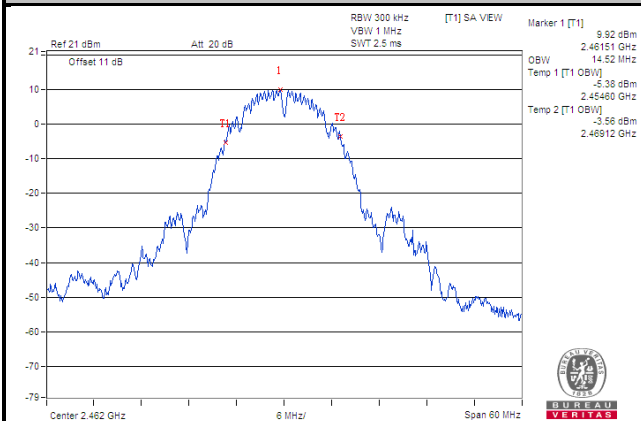

#### 802.11g

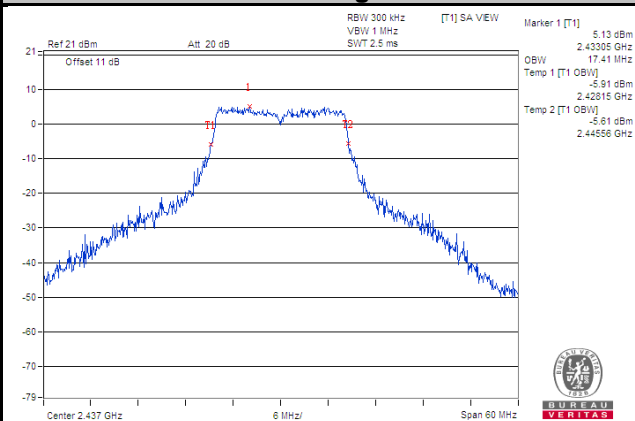

#### 802.11n (HT20)

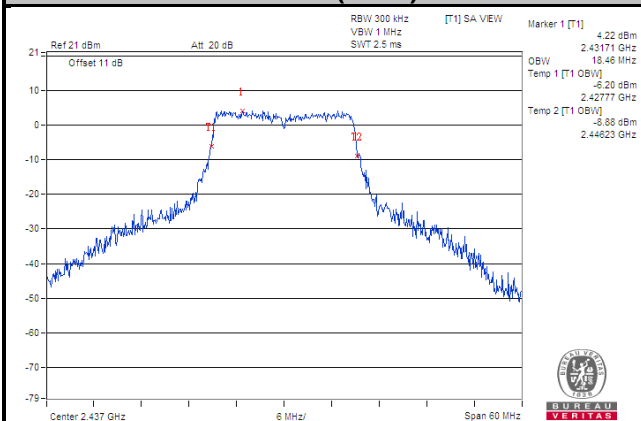

## 4.5 Conducted Output Power Measurement

### 4.5.1 Limits of Conducted Output Power Measurement

For systems using digital modulation in the 2400–2483.5 MHz bands: 1 Watt (30 dBm)

### 4.5.2 Test Setup

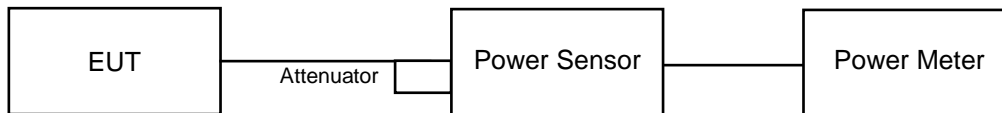

### 4.5.3 Test Instruments

Refer to section 4.1.2 to get information of above instrument.

### 4.5.4 Test Procedures

A peak power sensor was used on the output port of the EUT. A power meter was used to read the response of the peak power sensor. Record the power level.

Average power sensor was used to perform output power measurement, trigger and gating function of wide band power meter is enabled to measure max output power of TX on burst. Duty factor is not added to measured value.

### 4.5.5 Deviation from Test Standard

No deviation.

### 4.5.6 EUT Operating Conditions

The software provided by client to enable the EUT under transmission condition continuously at lowest, middle and highest channel frequencies individually.



#### 4.5.7 Test Results

<Peak>

##### 802.11b

Channel	Frequency (MHz)	Peak Power (mW)	Peak Power (dBm)	Limit (dBm)	Pass / Fail
1	2412	56.754	17.54	30	Pass
6	2437	100.925	20.04	30	Pass
11	2462	98.175	19.92	30	Pass

##### 802.11g

Channel	Frequency (MHz)	Peak Power (mW)	Peak Power (dBm)	Limit (dBm)	Pass / Fail
1	2412	147.571	21.69	30	Pass
6	2437	151.008	21.79	30	Pass
11	2462	159.956	22.04	30	Pass

##### 802.11n (HT20)

Channel	Frequency (MHz)	Peak Power (mW)	Peak Power (dBm)	Limit (dBm)	Pass / Fail
1	2412	129.122	21.11	30	Pass
6	2437	169.434	22.29	30	Pass
11	2462	150.314	21.77	30	Pass

<Average>

802.11b

Channel	Frequency (MHz)	Average Power (mW)	Average Power (dBm)
1	2412	32.734	15.15
6	2437	55.976	17.48
11	2462	55.208	17.42

802.11g

Channel	Frequency (MHz)	Average Power (mW)	Average Power (dBm)
1	2412	20.654	13.15
6	2437	22.080	13.44
11	2462	22.029	13.43

802.11n (HT20)

Channel	Frequency (MHz)	Average Power (mW)	Average Power (dBm)
1	2412	20.941	13.21
6	2437	22.284	13.48
11	2462	22.131	13.45

## 4.6 Power Spectral Density Measurement

### 4.6.1 Limits of Power Spectral Density Measurement

The Maximum of Power Spectral Density Measurement is 8 dBm.

### 4.6.2 Test Setup

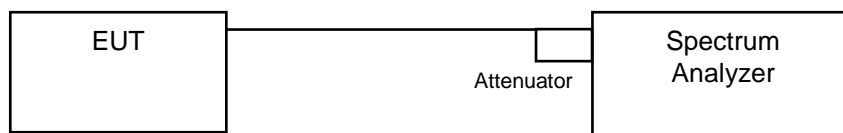

### 4.6.3 Test Instruments

Refer to section 4.1.2 to get information of above instrument.

### 4.6.4 Test Procedure

- a. Set analyzer center frequency to DTS channel center frequency.
- b. Set the span to 1.5 times the DTS bandwidth.
- c. Set the RBW to:  $3 \text{ kHz} \leq \text{RBW} \leq 100 \text{ kHz}$ .
- d. Set the VBW  $\geq 3 \times \text{RBW}$ .
- e. Detector = peak.
- f. Sweep time = auto couple.
- g. Trace mode = max hold.
- h. Allow trace to fully stabilize.
- i. Use the peak marker function to determine the maximum amplitude level within the RBW.

### 4.6.5 Deviation from Test Standard

No deviation.

### 4.6.6 EUT Operating Condition

The software provided by client to enable the EUT under transmission condition continuously at lowest, middle and highest channel frequencies individually.

#### 4.6.7 Test Results

##### 802.11b

Channel	Frequency (MHz)	PSD (dBm/3 kHz)	Limit (dBm/3 kHz)	Pass / Fail
1	2412	-4.44	8	Pass
6	2437	-4.13	8	Pass
11	2462	-4.14	8	Pass

##### 802.11g

Channel	Frequency (MHz)	PSD (dBm/3 kHz)	Limit (dBm/3 kHz)	Pass / Fail
1	2412	-11.60	8	Pass
6	2437	-11.25	8	Pass
11	2462	-11.31	8	Pass

##### 802.11n (HT20)

Channel	Frequency (MHz)	PSD (dBm/3 kHz)	Limit (dBm/3 kHz)	Pass / Fail
1	2412	-12.49	8	Pass
6	2437	-11.85	8	Pass
11	2462	-12.01	8	Pass

### Spectrum Plot of Worst Value

#### 802.11b

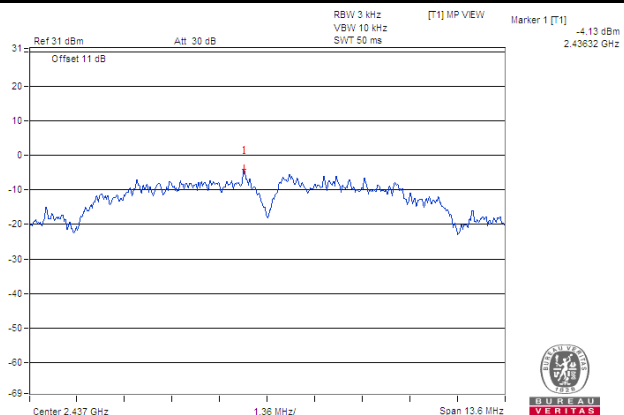

#### 802.11g

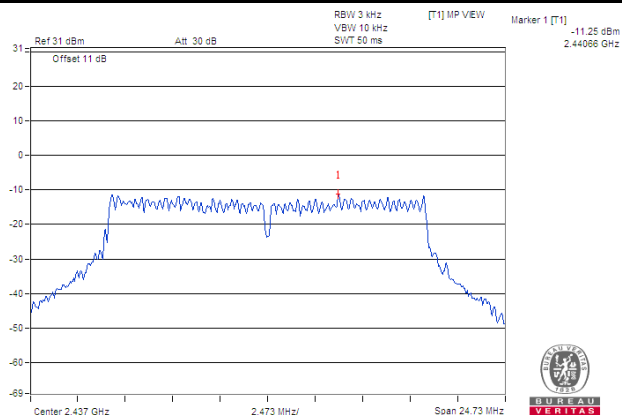

#### 802.11n (HT20)

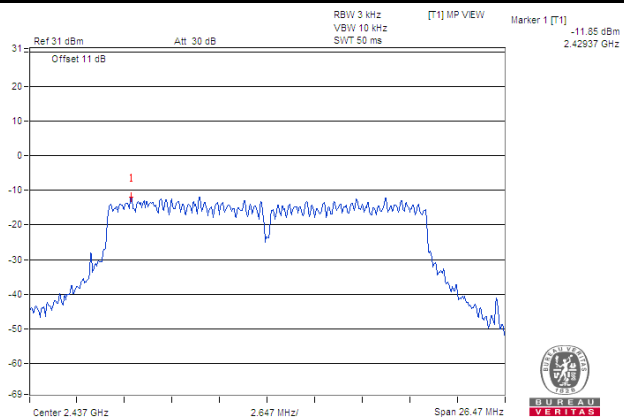

## 4.7 Conducted Out of Band Emission Measurement

### 4.7.1 Limits of Conducted Out of Band Emission Measurement

Below 20 dB of the highest emission level of operating band (in 100 kHz Resolution Bandwidth).

### 4.7.2 Test Setup

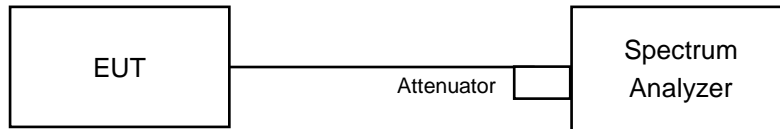

### 4.7.3 Test Instruments

Refer to section 4.1.2 to get information of above instrument.

### 4.7.4 Test Procedure

#### MEASUREMENT PROCEDURE REF

1. Set the RBW = 100 kHz.
2. Set the VBW  $\geq$  300 kHz.
3. Detector = peak.
4. Sweep time = auto couple.
5. Trace mode = max hold.
6. Allow trace to fully stabilize.
7. Use the peak marker function to determine the maximum power level in any 100 kHz band segment within the fundamental EBW.

#### MEASUREMENT PROCEDURE OOB

1. Set RBW = 100 kHz.
2. Set VBW  $\geq$  300 kHz.
3. Detector = peak.
4. Sweep = auto couple.
5. Trace Mode = max hold.
6. Allow trace to fully stabilize.
7. Use the peak marker function to determine the maximum amplitude level.

### 4.7.5 Deviation from Test Standard

No deviation.

### 4.7.6 EUT Operating Condition

The software provided by client to enable the EUT under transmission condition continuously at lowest, middle and highest channel frequencies individually.

### 4.7.7 Test Results

The spectrum plots are attached on the following images. D1 line indicates the highest level, and D2 line indicates the 20 dB offset below D1. It shows compliance with the requirement.

#### 802.11b

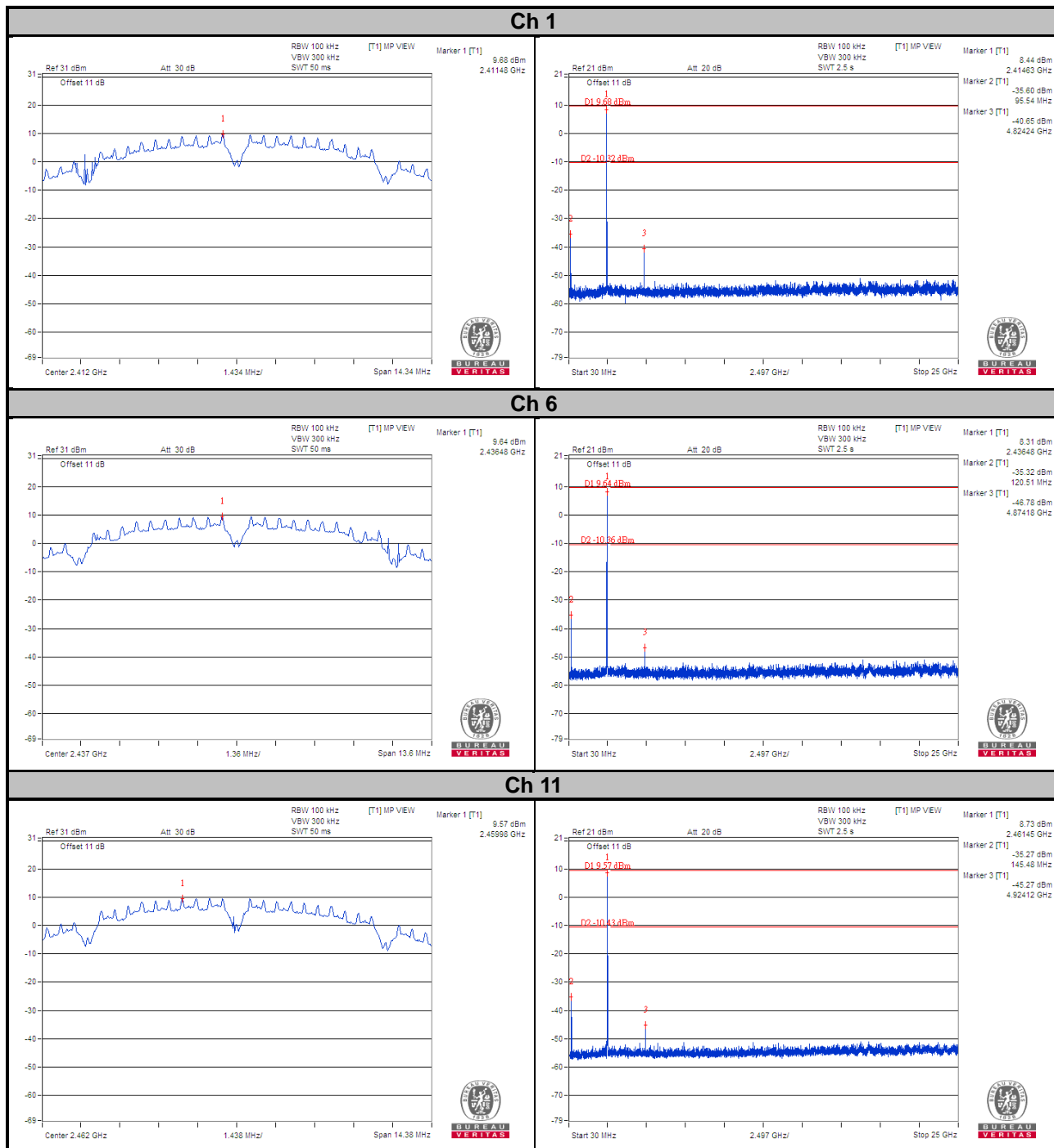

### Ch 1 Band Edge

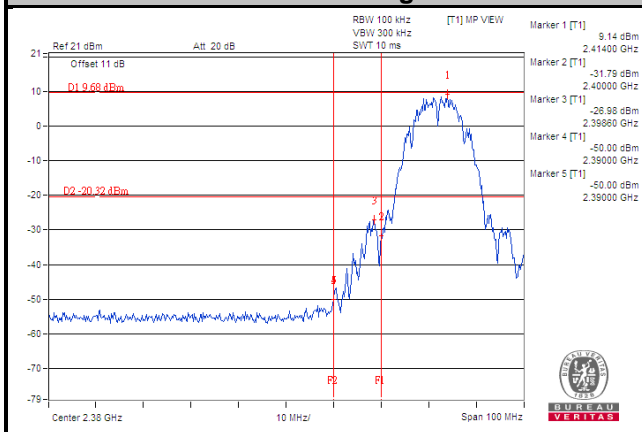

### Ch 11 Band Edge

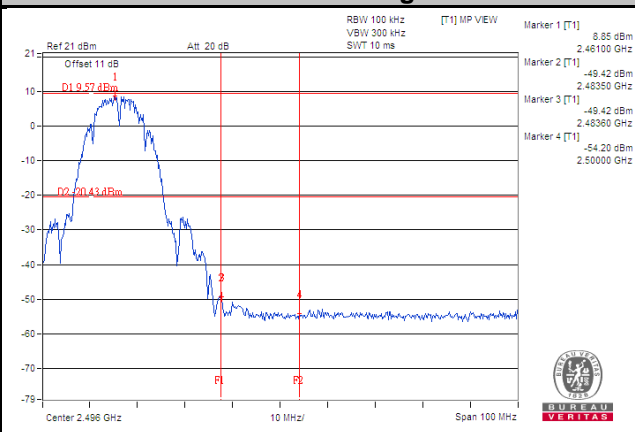



# 802.11g

## Ch 1

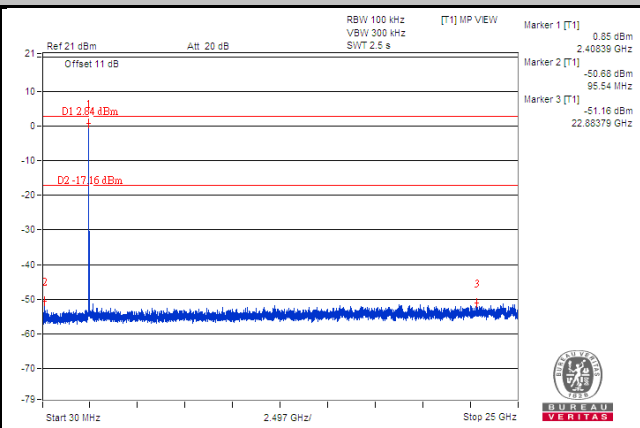
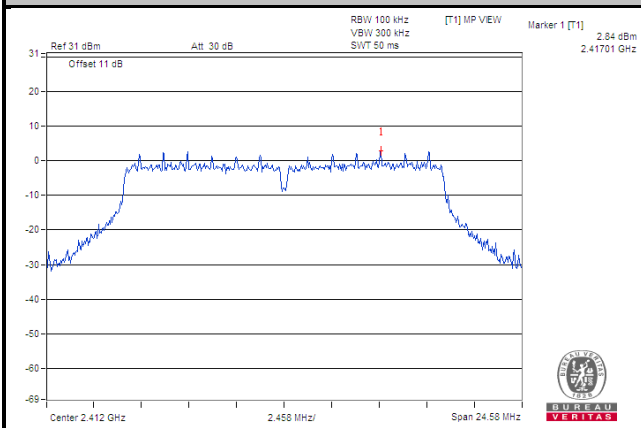

## Ch 6

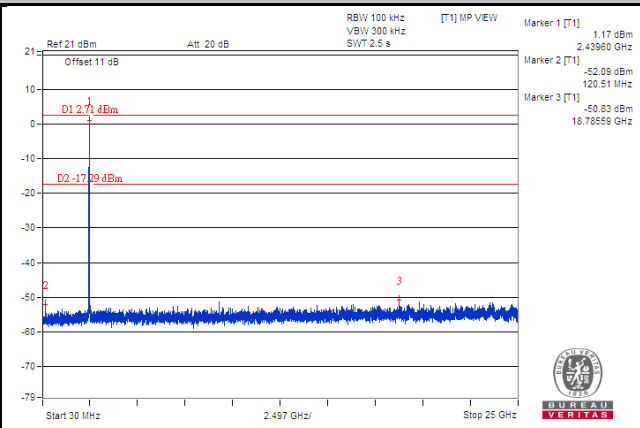
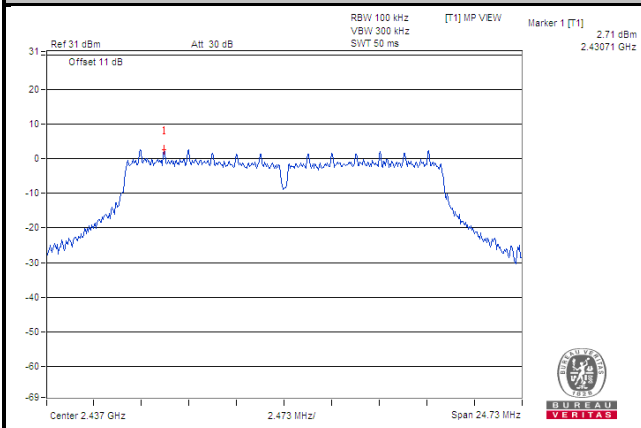

## Ch 11

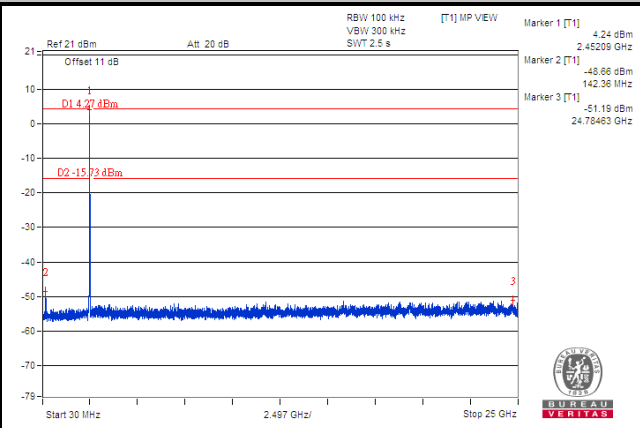
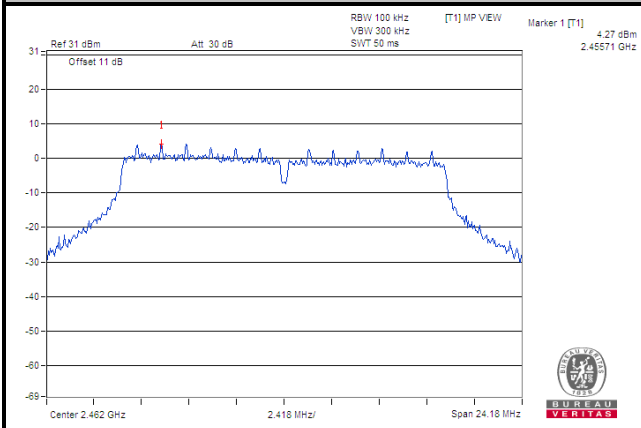

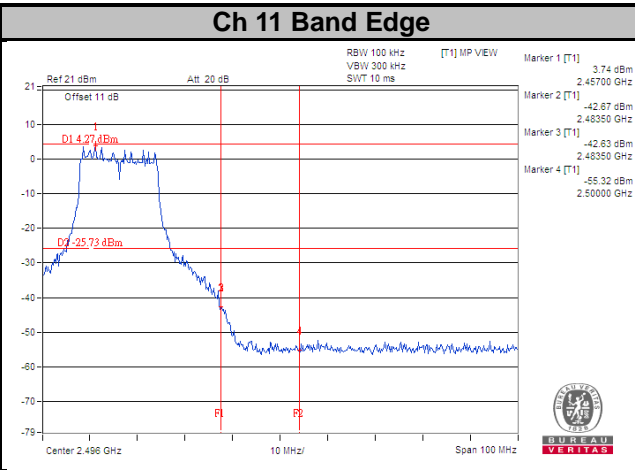
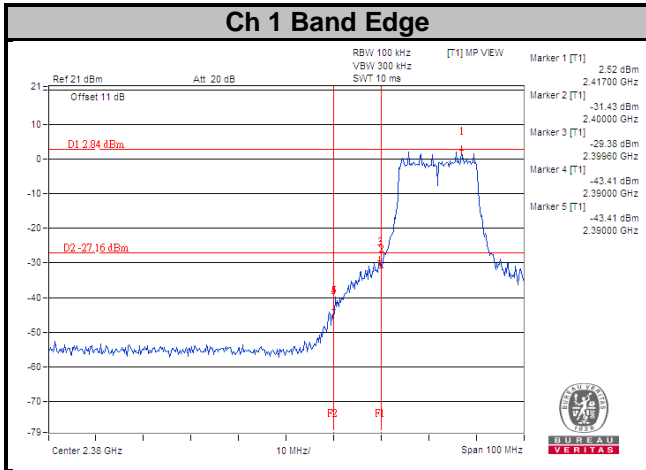

# 802.11n (HT20)

## Ch 1

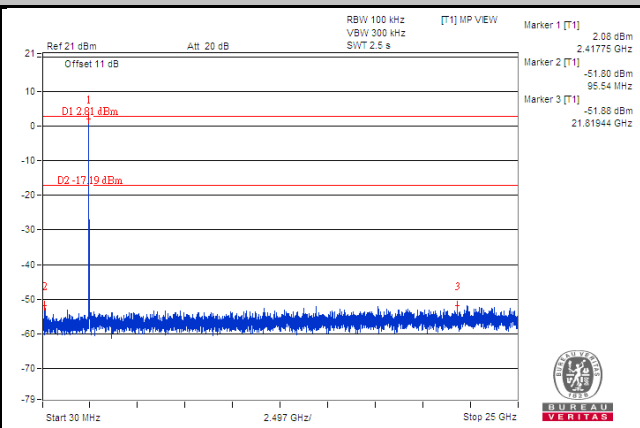
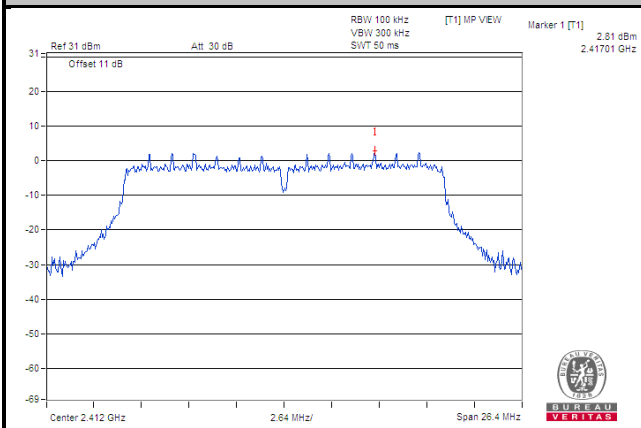

## Ch 6

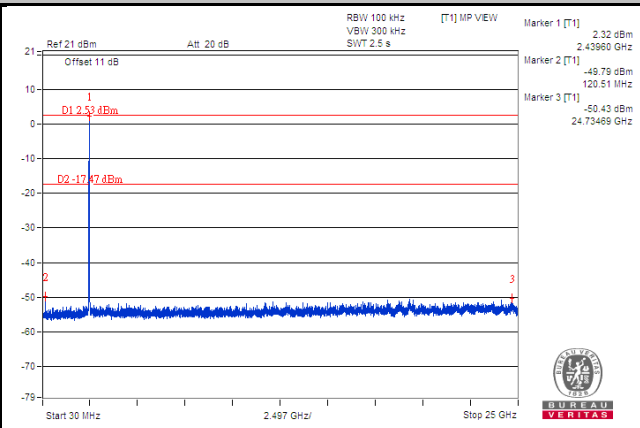
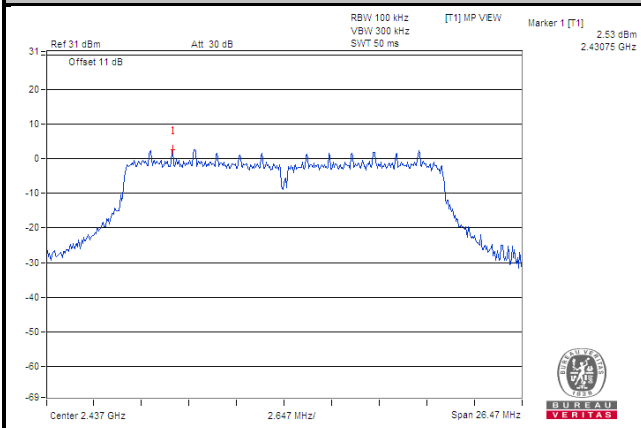

## Ch 11

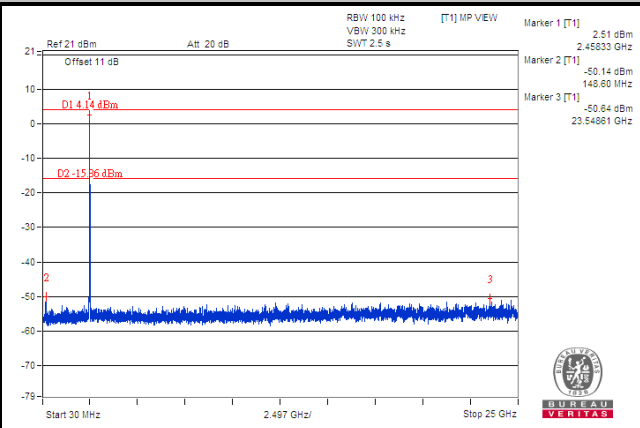
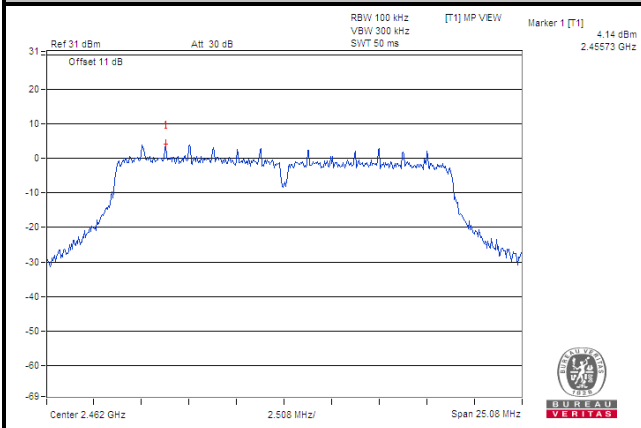

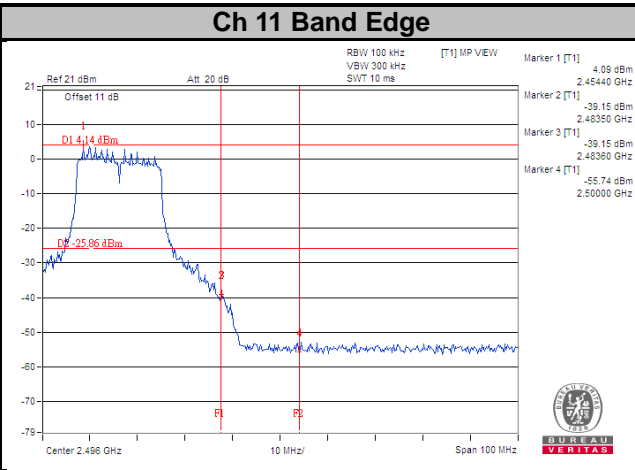
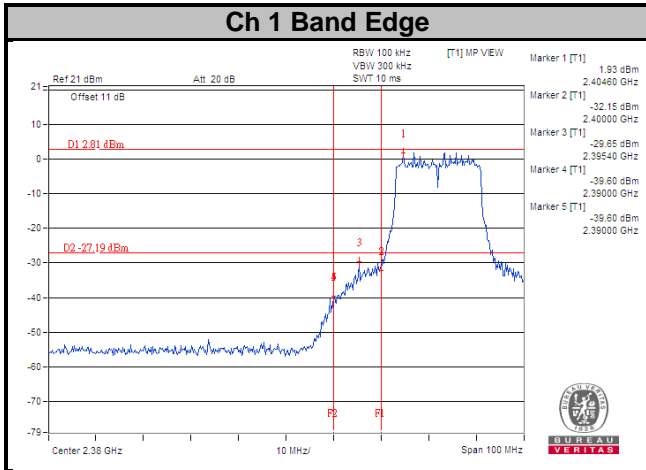

## 5 Pictures of Test Arrangements

Please refer to the attached file (Test Setup Photo).

## Appendix – Information on the Testing Laboratories

We, Bureau Veritas Consumer Products Services (H.K.) Ltd., Taoyuan Branch, were founded in 1988 to provide our best service in EMC, Radio, Telecom and Safety consultation. Our laboratories are FCC recognized accredited test firms and accredited according to ISO/IEC 17025.

If you have any comments, please feel free to contact us at the following:

**Linko EMC/RF Lab**

Tel: 886-2-26052180

Fax: 886-2-26051924

**Hsin Chu EMC/RF/Telecom Lab**

Tel: 886-3-6668565

Fax: 886-3-6668323

**Hwa Ya EMC/RF/Safety Lab**

Tel: 886-3-3183232

Fax: 886-3-3270892

**Email:** [service.adt@tw.bureauveritas.com](mailto:service.adt@tw.bureauveritas.com)

**Web Site:** [www.bureauveritas-adt.com](http://www.bureauveritas-adt.com)

The address and road map of all our labs can be found in our web site also.

--- END ---