

## FCC Test Report

**Report No.:** RFBEBW-WTW-P20120765-1

**FCC ID:** KA2BGX1000A1

**Test Model:** DBG-X1000

**Received Date:** Jan. 13, 2021

**Test Date:** Jan. 21 ~ Jan. 29, 2021

**Issued Date:** Sep. 02, 2021

**Applicant:** D-Link Corporation

**Address:** 14420 Myford Road Suite 100, Irvine, California 92606 United States

**Issued By:** Bureau Veritas Consumer Products Services (H.K.) Ltd., Taoyuan Branch  
Lin Kou Laboratories

**Lab Address:** No. 47-2, 14th Ling, Chia Pau Vil., Lin Kou Dist., New Taipei City, Taiwan

**Test Location:** No.19, Hwa Ya 2nd Rd., Wen Hwa Vil., Kwei Shan Dist., Taoyuan City  
33383, Taiwan

**FCC Registration /  
Designation Number:** 788550 / TW0003



This report is for your exclusive use. Any copying or replication of this report to or for any other person or entity, or use of our name or trademark, is permitted only with our prior written permission. This report sets forth our findings solely with respect to the test samples identified herein. The results set forth in this report are not indicative or representative of the quality or characteristics of the lot from which a test sample was taken or any similar or identical product unless specifically and expressly noted. Our report includes all of the tests requested by you and the results thereof based upon the information that you provided to us. You have 60 days from date of issuance of this report to notify us of any material error or omission caused by our negligence, provided, however, that such notice shall be in writing and shall specifically address the issue you wish to raise. A failure to raise such issue within the prescribed time shall constitute your unqualified acceptance of the completeness of this report, the tests conducted and the correctness of the report contents. Unless specific mention, the uncertainty of measurement has been explicitly taken into account to declare the compliance or non-compliance to the specification.

## Table of Contents

<b>Release Control Record</b> .....	<b>4</b>
<b>1 Certificate of Conformity</b> .....	<b>5</b>
<b>2 Summary of Test Results</b> .....	<b>6</b>
2.1 Measurement Uncertainty .....	7
2.2 Modification Record .....	7
<b>3 General Information</b> .....	<b>8</b>
3.1 General Description of EUT .....	8
3.2 Description of Test Modes .....	10
3.2.1 Test Mode Applicability and Tested Channel Detail .....	11
3.3 Duty Cycle of Test Signal .....	13
3.4 Description of Support Units .....	14
3.4.1 Configuration of System under Test .....	14
3.5 General Description of Applied Standards and References .....	15
<b>4 Test Types and Results</b> .....	<b>16</b>
4.1 Radiated Emission and Bandedge Measurement .....	16
4.1.1 Limits of Radiated Emission and Bandedge Measurement .....	16
4.1.2 Test Instruments .....	18
4.1.3 Test Procedures .....	19
4.1.4 Deviation from Test Standard .....	20
4.1.5 Test Setup .....	20
4.1.6 EUT Operating Conditions .....	21
4.1.7 Test Results .....	22
4.2 Conducted Emission Measurement .....	44
4.2.1 Limits of Conducted Emission Measurement .....	44
4.2.2 Test Instruments .....	44
4.2.3 Test Procedures .....	45
4.2.4 Deviation from Test Standard .....	45
4.2.5 Test Setup .....	45
4.2.6 EUT Operating Conditions .....	45
4.2.7 Test Results .....	46
4.3 Transmit Power Measurement .....	48
4.3.1 Limits of Transmit Power Measurement .....	48
4.3.2 Test Setup .....	48
4.3.3 Test Instruments .....	49
4.3.4 Test Procedure .....	49
4.3.5 Deviation from Test Standard .....	49
4.3.6 EUT Operating Conditions .....	49
4.3.7 Test Results .....	50
4.4 Occupied Bandwidth Measurement .....	58
4.4.1 Test Setup .....	58
4.4.2 Test Instruments .....	58
4.4.3 Test Procedure .....	58
4.4.4 Test Results .....	59
4.5 Peak Power Spectral Density Measurement .....	63
4.5.1 Limits of Peak Power Spectral Density Measurement .....	63
4.5.2 Test Setup .....	63
4.5.3 Test Instruments .....	63
4.5.4 Test Procedures .....	63
4.5.5 Deviation from Test Standard .....	64
4.5.6 EUT Operating Conditions .....	64
4.5.7 Test Results .....	65
4.6 Frequency Stability .....	71

4.6.1	Limit of Frequency Stability Measurement .....	71
4.6.2	Test Setup .....	71
4.6.3	Test Instruments .....	71
4.6.4	Test Procedure .....	71
4.6.5	Deviation from Test Standard .....	71
4.6.6	EUT Operating Condition .....	71
4.6.7	Test Results .....	72
4.7	6 dB Bandwidth Measurement.....	73
4.7.1	Limits of 6 dB Bandwidth Measurement.....	73
4.7.2	Test Setup.....	73
4.7.3	Test Instruments .....	73
4.7.4	Test Procedure .....	73
4.7.5	Deviation from Test Standard .....	73
4.7.6	EUT Operating Condition .....	73
4.7.7	Test Results .....	74
<b>5</b>	<b>Pictures of Test Arrangements.....</b>	<b>76</b>
	<b>Annex A- Radiated Out of Band Emission (OOBE) Measurement (For U-NII-3 band) .....</b>	<b>77</b>
	<b>Annex B- Band-edge measurement.....</b>	<b>81</b>
	<b>Appendix – Information of the Testing Laboratories .....</b>	<b>85</b>

### Release Control Record

Issue No.	Description	Date Issued
RFBEBW-WTW-P20120765-1	Original Release	Sep. 02, 2021

## 1 Certificate of Conformity

**Product:** Nuclias Cloud-Managed Wireless VPN Gateway

**Brand:** D-Link Corporation

**Test Model:** DBG-X1000

**Sample Status:** Mass product

**Applicant:** D-Link Corporation

**Test Date:** Jan. 21 ~ Jan. 29, 2021

**Standards:** 47 CFR FCC Part 15, Subpart E (Section 15.407)  
ANSI C63.10:2013

The above equipment has been tested by **Bureau Veritas Consumer Products Services (H.K.) Ltd., Taoyuan Branch**, and found compliance with the requirement of the above standards. The test record, data evaluation & Equipment Under Test (EUT) configurations represented herein are true and accurate accounts of the measurements of the sample's RF characteristics under the conditions specified in this report.

**Prepared by :** , **Date:** Sep. 02, 2021  
Gina Liu / Specialist

**Approved by :** , **Date:** Sep. 02, 2021  
Dylan Chiou / Senior Project Engineer

## 2 Summary of Test Results

47 CFR FCC Part 15, Subpart E (Section 15.407)			
FCC Clause	Test Item	Result	Remarks
15.407(b)(8)	AC Power Conducted Emissions	Pass	Meet the requirement of limit. Minimum passing margin is -26.55 dB at 0.198 MHz.
15.407(b) (1/2/3/4(i/ii)/8)	Radiated Emissions & Band Edge Measurement	Pass	Meet the requirement of limit. Minimum passing margin is -0.5 dB at 11650.00 MHz.
15.407(a)(1/2/3)	Max Average Transmit Power	Pass	Meet the requirement of limit.
---	Occupied Bandwidth Measurement	-	Reference only
15.407(a)(1/2/3)	Peak Power Spectral Density	Pass	Meet the requirement of limit.
15.407(e)	6 dB Bandwidth	Pass	Meet the requirement of limit. (U-NII-3 Band only)
15.407(g)	Frequency Stability	Pass	Meet the requirement of limit.
15.203	Antenna Requirement	Pass	Antenna connector is SMA Male Reverse connector not a standard connector.

Note:

1. For U-NII-3 band compliance with rule part 15.407(b)(4)(i), the OOB test plots were recorded in Annex A.
2. For U-NII-1 band compliance with rule 15.407(b) of the band-edge items, the test plots were recorded in Annex B. Test Procedures refer to report 4.1.3.
3. Determining compliance based on the results of the compliance measurement, not taking into account measurement instrumentation uncertainty.

## 2.1 Measurement Uncertainty

Where relevant, the following measurement uncertainty levels have been estimated for tests performed on the EUT as specified in CISPR 16-4-2:

Measurement	Frequency	Expanded Uncertainty (k=2) (±)
Conducted Emissions at mains ports	150 kHz ~ 30 MHz	2.79 dB
Radiated Emissions up to 1 GHz	9 kHz ~ 30 MHz	3.04 dB
	30 MHz ~ 200 MHz	2.93 dB
	200 MHz ~ 1000 MHz	2.95 dB
Radiated Emissions above 1 GHz	1 GHz ~ 18 GHz	2.26 dB
	18 GHz ~ 40 GHz	1.94 dB

## 2.2 Modification Record

There were no modifications required for compliance.

### 3 General Information

#### 3.1 General Description of EUT

<b>Product</b>	Nuclias Cloud-Managed Wireless VPN Gateway
<b>Brand</b>	D-Link Corporation
<b>Test Model</b>	DBG-X1000
<b>Status of EUT</b>	Mass product
<b>Power Supply Rating</b>	12 Vdc (Adapter)
<b>Modulation Type</b>	256QAM, 64QAM, 16QAM, QPSK, BPSK for OFDM 1024QAM, 256QAM, 64QAM, 16QAM, QPSK, BPSK for OFDMA
<b>Modulation Technology</b>	OFDM, OFDMA
<b>Transfer Rate</b>	802.11a: 54.0/ 48.0/ 36.0/ 24.0/ 18.0/ 12.0/ 9.0/ 6.0 Mbps 802.11n: up to 400.0 Mbps 802.11ac: up to 1733.3 Mbps 802.11ax: up to 2402.0 Mbps
<b>Operating Frequency</b>	5180 ~ 5240 MHz, 5745 ~ 5825 MHz
<b>Number of Channel</b>	5180 ~ 5250 MHz: 4 for 802.11a, 802.11n (HT20), 802.11ac (VHT20), 802.11ax (HE20) 2 for 802.11n (HT40), 802.11ac (VHT40), 802.11ax (HE40) 1 for 802.11ac (VHT80), 802.11ax (HE80) 5745 ~ 5825 MHz: 5 for 802.11a, 802.11n (HT20), 802.11ac (VHT20), 802.11ax (HE20) 2 for 802.11n (HT40), 802.11ac (VHT40), 802.11ax (HE40) 1 for 802.11ac (VHT80), 802.11ax (HE80)
<b>Output Power</b>	CDD Mode 536.14 mW for 5180 ~ 5240 MHz 529.813 mW for 5745 ~ 5825 MHz Beamforming Mode 264.088 mW for 5180 ~ 5240 MHz 264.925 mW for 5745 ~ 5825 MHz
<b>Antenna Type</b>	Dipole antenna with 4.5 dBi gain (5180 ~ 5240 MHz) Dipole antenna with 4.5 dBi gain (5745 ~ 5825 MHz)
<b>Antenna Connector</b>	SMA Male Reverse
<b>Accessory Device</b>	Refer to Note as below
<b>Data Cable Supplied</b>	Refer to Note as below



**Note:**

1. The EUT incorporates a MIMO function. Physically, the EUT provides two completed transmitters and two receivers.

Modulation Mode	Tx Function	CDD Mode	Beamforming Mode
802.11a	2TX	Support	Not Support
802.11n (HT20)	2TX	Support	Support
802.11n (HT40)	2TX	Support	Support
802.11ac (VHT20)	2TX	Support	Support
802.11ac (VHT40)	2TX	Support	Support
802.11ac (VHT80)	2TX	Support	Support
802.11ax (HE20)	2TX	Support	Support
802.11ax (HE40)	2TX	Support	Support
802.11ax (HE80)	2TX	Support	Support

\* The bandwidth and modulation are similar for 802.11n mode for HT20 / HT40, 802.11ac mode for VHT20 / VHT40 / VHT80 and 802.11ax mode for HE20 / HE40 / HE80, therefore investigated worst case to representative mode in test report. (Final test mode refer section 3.2.1)

2. The EUT contains following accessory devices.

Product	Brand	Model	Description
Adapter	APD	WA-24Q12R	I/P: 100-240 Vac, 50-60 Hz, 700 mA O/P: 12 Vdc, 2 A

3. The above Antenna information is declared by manufacturer and for more detailed features description, please refer to the manufacturer's specifications, the laboratory shall not be held responsible.
4. The above EUT information is declared by manufacturer and for more detailed features description, please refers to the manufacturer's specifications or user's manual.

### 3.2 Description of Test Modes

#### For 5180 ~ 5240 MHz

4 channels are provided for 802.11a, 802.11n (HT20), 802.11ac (VHT20), 802.11ax (HE20):

Channel	Frequency (MHz)	Channel	Frequency (MHz)
36	5180	44	5220
40	5200	48	5240

2 channels are provided for 802.11n (HT40), 802.11ac (VHT40), 802.11ax (HE40) :

Channel	Frequency (MHz)	Channel	Frequency (MHz)
38	5190	46	5230

1 channel is provided for 802.11ac (VHT80), 802.11ax (HE80):

Channel	Frequency (MHz)
42	5210

#### For 5745 ~ 5825 MHz:

5 channels are provided for 802.11a, 802.11n (HT20), 802.11ac (VHT20), 802.11ax (HE20):

Channel	Frequency (MHz)	Channel	Frequency (MHz)
149	5745	161	5805
153	5765	165	5825
157	5785		

2 channels are provided for 802.11n (HT40), 802.11ac (VHT40), 802.11ax (HE40) :

Channel	Frequency (MHz)	Channel	Frequency (MHz)
151	5755	159	5795

1 channel is provided for 802.11ac (VHT80), 802.11ax (HE80):

Channel	Frequency (MHz)
155	5775

### 3.2.1 Test Mode Applicability and Tested Channel Detail

EUT Configure Mode	Applicable To				Description
	RE $\geq$ 1G	RE $<$ 1G	PLC	APCM	
-	√	√	√	√	-

Where **RE $\geq$ 1G**: Radiated Emission above 1 GHz      **RE $<$ 1G**: Radiated Emission below 1 GHz  
**PLC**: Power Line Conducted Emission      **APCM**: Antenna Port Conducted Measurement

**Note:**

1. The EUT had been pre-tested on the positioned of each 3 axis. The worst case was found when positioned on **X-plane**.
2. "-" means no effect.

#### **Radiated Emission Test (Above 1 GHz):**

- Pre-Scan has been conducted to determine the worst-case mode from all possible combinations between available modulations, data rates and antenna ports (if EUT with antenna diversity architecture).
- Following channel(s) was (were) selected for the final test as listed below.

EUT Configure Mode	Frequency Band (MHz)	Mode	Available Channel	Tested Channel	Modulation Technology	Modulation Type	Data Rate (Mbps)
-	5180-5240	802.11a	36 to 48	36, 40, 48	OFDM	BPSK	6.0
-		802.11ax (HE20)	36 to 48	36, 40, 48	OFDMA	BPSK	MCS0
-		802.11ax (HE40)	38 to 46	38, 46	OFDMA	BPSK	MCS0
-		802.11ax (HE80)	42	42	OFDMA	BPSK	MCS0
-	5745-5825	802.11a	149 to 165	149, 157, 165	OFDM	BPSK	6.0
-		802.11ax (HE20)	149 to 165	149, 157, 165	OFDMA	BPSK	MCS0
-		802.11ax (HE40)	151 to 159	151, 159	OFDMA	BPSK	MCS0
-		802.11ax (HE80)	155	155	OFDMA	BPSK	MCS0

#### **Radiated Emission Test (Below 1 GHz):**

- Pre-Scan has been conducted to determine the worst-case mode from all possible combinations between available modulations, data rates and antenna ports (if EUT with antenna diversity architecture).
- Following channel(s) was (were) selected for the final test as listed below.

EUT Configure Mode	Frequency Band (MHz)	Mode	Available Channel	Tested Channel	Modulation Technology	Modulation Type	Data Rate (Mbps)
-	5180-5240	802.11a	36 to 48	40	OFDM	BPSK	6.0

#### **Power Line Conducted Emission Test:**

- Pre-Scan has been conducted to determine the worst-case mode from all possible combinations between available modulations, data rates and antenna ports (if EUT with antenna diversity architecture).
- Following channel(s) was (were) selected for the final test as listed below.

EUT Configure Mode	Frequency Band (MHz)	Mode	Available Channel	Tested Channel	Modulation Technology	Modulation Type	Data Rate (Mbps)
-	5180-5240	802.11a	36 to 48	40	OFDM	BPSK	6.0

**Antenna Port Conducted Measurement:**

- This item includes all test value of each mode, but only includes spectrum plot of worst value of each mode.
- Pre-Scan has been conducted to determine the worst-case mode from all possible combinations between available modulations, data rates and antenna ports (if EUT with antenna diversity architecture).
- Following channel(s) was (were) selected for the final test as listed below.

EUT Configure Mode	Frequency Band (MHz)	Mode	Available Channel	Tested Channel	Modulation Technology	Modulation Type	Data Rate (Mbps)
-	5180-5240	802.11a	36 to 48	36, 40, 48	OFDM	BPSK	6.0
-		802.11n (HT20)	36 to 48	36, 40, 48	OFDM	BPSK	6.5
-		802.11n (HT40)	38 to 46	38, 46	OFDM	BPSK	13.5
-		802.11ac (VHT20)	36 to 48	36, 40, 48	OFDM	BPSK	7.2
-		802.11ac (VHT40)	38 to 46	38, 46	OFDM	BPSK	15.0
-		802.11ac (VHT80)	42	42	OFDM	BPSK	29.3
-		802.11ax (HE20)	36 to 48	36, 40, 48	OFDMA	BPSK	MCS0
-		802.11ax (HE40)	38 to 46	38, 46	OFDMA	BPSK	MCS0
-		802.11ax (HE80)	42	42	OFDMA	BPSK	MCS0
-	5745-5825	802.11a	149 to 165	149, 157, 165	OFDM	BPSK	6.0
-		802.11n (HT20)	149 to 165	149, 157, 165	OFDM	BPSK	6.5
-		802.11n (HT40)	151 to 159	151, 159	OFDM	BPSK	13.5
-		802.11ac (VHT20)	149 to 165	149, 157, 165	OFDM	BPSK	7.2
-		802.11ac (VHT40)	151 to 159	151, 159	OFDM	BPSK	15.0
-		802.11ac (VHT80)	155	155	OFDM	BPSK	29.3
-		802.11ax (HE20)	149 to 165	149, 157, 165	OFDMA	BPSK	MCS0
-		802.11ax (HE40)	151 to 159	151, 159	OFDMA	BPSK	MCS0
-		802.11ax (HE80)	155	155	OFDMA	BPSK	MCS0

**Test Condition:**

Applicable To	Environmental Conditions	Input Power	Tested by
RE $\geq$ 1G	25 deg. C, 65 % RH	120 Vac, 60 Hz	Rex Wang
RE $<$ 1G	25 deg. C, 65 % RH	120 Vac, 60 Hz	Rex Wang
PLC	25 deg. C, 65 % RH	120 Vac, 60 Hz	Rex Wang
APCM	25 deg. C, 65 % RH	12 Vdc	Ivan Tseng

### 3.3 Duty Cycle of Test Signal

#### MODULATION TYPE: BPSK

Duty cycle of test signal is < 98 %, duty factor is required.

**802.11a:** Duty cycle =  $1.962/2.087 = 0.94$ , Duty factor =  $10 * \log(1/0.94) = 0.27$

**802.11ax (HE20):** Duty cycle =  $5.375/5.7 = 0.943$ , Duty factor =  $10 * \log(1/0.943) = 0.25$

**802.11ax (HE40):** Duty cycle =  $5.3/5.7 = 0.93$ , Duty factor =  $10 * \log(1/0.93) = 0.32$

**802.11ax (HE80):** Duty cycle =  $5.25/5.8 = 0.905$ , Duty factor =  $10 * \log(1/0.905) = 0.43$



### 3.4 Description of Support Units

The EUT has been tested as an independent unit together with other necessary accessories or support units. The following support units or accessories were used to form a representative test configuration during the tests.

ID	Product	Brand	Model No.	Serial No.	FCC ID	Remarks
A.	Load	N/A	N/A	N/A	N/A	--
B.	Notebook	DELL	E5410	1HC2XM1	N/A	--
C.	USB 2.0 FLASH	HP	v250W	09	N/A	--

ID	Cable Descriptions	Qty.	Length (m)	Shielding (Yes/No)	Cores (Qty.)	Remarks
1.	Adapter Cable	1	1.5	N	0	Accessory of the EUT
2.	LAN Cable	4	1.5	N	0	RJ45, Cat5e
3.	Console Cable	1	1.8	N	0	Provided by client
4.	LAN Cable	1	1.0	N	0	RJ45, Cat5e; Provided by client

Note:

1. All power cords of the above support units are non-shielded (1.8m).

#### 3.4.1 Configuration of System under Test

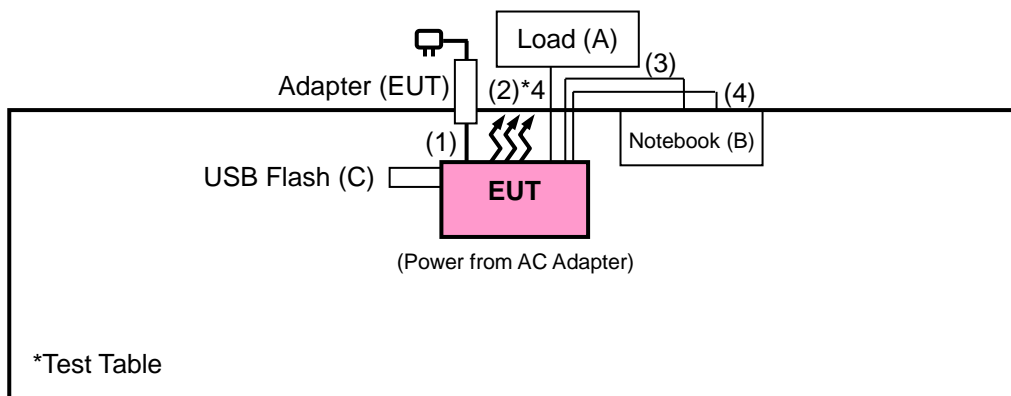

### **3.5 General Description of Applied Standards and References**

The EUT is a RF Product. According to the specifications of the manufacturer, it must comply with the requirements of the following standards and references:

#### **Test Standard:**

##### **FCC Part 15, Subpart E (15.407)**

ANSI C63.10-2013

All test items have been performed and recorded as per the above standards.

#### **References Test Guidance:**

##### **KDB 789033 D02 General UNII Test Procedures New Rules v02r01**

##### **KDB 662911 D01 Multiple Transmitter Output v02r01**

All test items have been performed as a reference to the above KDB test guidance.

## 4 Test Types and Results

### 4.1 Radiated Emission and Bandedge Measurement

#### 4.1.1 Limits of Radiated Emission and Bandedge Measurement

Radiated emissions which fall in the restricted bands must comply with the radiated emission limits specified as below table.

Frequencies (MHz)	Field Strength (microvolts/meter)	Measurement Distance (meters)
0.009 ~ 0.490	2400/F (kHz)	300
0.490 ~ 1.705	24000/F (kHz)	30
1.705 ~ 30.0	30	30
30 ~ 88	100	3
88 ~ 216	150	3
216 ~ 960	200	3
Above 960	500	3

**Note:**

1. The lower limit shall apply at the transition frequencies.
2. Emission level (dBuV/m) = 20 log Emission level (uV/m).
3. For frequencies above 1000 MHz, the field strength limits are based on average detector, however, the peak field strength of any emission shall not exceed the maximum permitted average limits, specified above by more than 20 dB under any condition of modulation.



## Limits of Unwanted Emission Out of the Restricted Bands

Applicable To		Limit	
789033 D02 General UNII Test Procedures New Rules v02r01		Field Strength at 3 m	
		PK: 74 (dBµV/m)	AV: 54 (dBµV/m)
Frequency Band	Applicable To	EIRP Limit	Equivalent Field Strength at 3 m
5150~5250 MHz	15.407(b)(1)	PK: -27 (dBm/MHz)	PK: 68.2 (dBµV/m)
5250~5350 MHz	15.407(b)(2)		
5470~5725 MHz	15.407(b)(3)		
5725~5850 MHz	<input checked="" type="checkbox"/> 15.407(b)(4)(i)	PK:-27 (dBm/MHz) <sup>*1</sup> PK:10 (dBm/MHz) <sup>*2</sup> PK:15.6 (dBm/MHz) <sup>*3</sup> PK:27 (dBm/MHz) <sup>*4</sup>	PK: 68.2 (dBµV/m) <sup>*1</sup> PK:105.2 (dBµV/m) <sup>*2</sup> PK: 110.8 (dBµV/m) <sup>*3</sup> PK:122.2 (dBµV/m) <sup>*4</sup>
	<input type="checkbox"/> 15.407(b)(4)(ii)	Emission limits in section 15.247(d)	

<sup>\*1</sup> beyond 75 MHz or more above of the band edge.

<sup>\*2</sup> below the band edge increasing linearly to 10 dBm/MHz at 25 MHz above.

<sup>\*3</sup> below the band edge increasing linearly to a level of 15.6 dBm/MHz at 5 MHz above.

<sup>\*4</sup> from 5 MHz above or below the band edge increasing linearly to a level of 27 dBm/MHz at the band edge.

**Note:**

The following formula is used to convert the equipment isotropic radiated power (eirp) to field strength:

$$E = \frac{1000000\sqrt{30P}}{3} \quad \mu\text{V/m, where P is the eirp (Watts).$$

#### 4.1.2 Test Instruments

Description & Manufacturer	Model No.	Serial No.	Date of Calibration	Due Date of Calibration
Test Receiver KEYSIGHT	N9038A	MY55420137	Apr. 16, 2020	Apr. 15, 2021
Spectrum Analyzer ROHDE & SCHWARZ	FSP40	100039	Jun. 12, 2020	Jun. 11, 2021
BILOG Antenna SCHWARZBECK	VULB9168	9168-160	Nov. 06, 2020	Nov. 05, 2021
HORN Antenna SCHWARZBECK	BBHA 9120 D	9120D-1169	Nov. 22, 2020	Nov. 21, 2021
HORN Antenna SCHWARZBECK	BBHA 9170	BBHA9170241	Nov. 22, 2020	Nov. 21, 2021
Preamplifier Agilent (Below 1GHz)	8447D	2944A10638	Jun. 08, 2020	Jun. 07, 2021
Preamplifier Agilent (Above 1GHz)	8449B	3008A02367	Feb. 18, 2020	Feb. 17, 2021
RF signal cable HUBER+SUHNER&EMCI	SUCOFLEX 104 & EMC104-SM-SM80 00	CABLE-CH9-02 (248780+171006)	Jan. 16, 2021	Jan. 15, 2022
RF signal cable HUBER+SUHNER	SUCOFLEX 104	CABLE-CH9-(2507 95/4)	Jan. 16, 2021	Jan. 15, 2022
RF signal cable Woken	8D-FB	Cable-CH9-01	Jun. 08, 2020	Jun. 07, 2021
Software BV ADT	ADT_Radiated_ V7.6.15.9.5	NA	NA	NA
Antenna Tower EMCO	2070/2080	512.835.4684	NA	NA
Turn Table EMCO	2087-2.03	NA	NA	NA
Antenna Tower & Turn BV ADT	AT100	AT93021705	NA	NA
Turn Table BV ADT	TT100	TT93021705	NA	NA
Turn Table Controller BV ADT	SC100	SC93021705	NA	NA
Boresight Antenna Fixture	FBA-01	FBA-SIP01	NA	NA
USB Wideband Power Sensor KEYSIGHT	U2021XA	MY55050005/MY55 190004/MY551900 07/MY55210005	Jul. 13, 2020	Jul. 12, 2021
Pre-amplifier (18GHz-40GHz) EMC	EMC184045B	980175	Sep. 04, 2020	Sep. 03, 2021

- Note: 1. The calibration interval of the above test instruments is 12 months and the calibrations are traceable to NML/ROC and NIST/USA.  
2. The test was performed in HwaYa Chamber 9.

#### 4.1.3 Test Procedures

##### **For Radiated Emission below 30 MHz**

- a. The EUT was placed on the top of a rotating table 0.8 meters above the ground at a 3 meter chamber room. The table was rotated 360 degrees to determine the position of the highest radiation.
- b. The EUT was set 3 meters away from the interference-receiving antenna, which was mounted on the top of a variable-height antenna tower.
- c. Parallel, perpendicular, and ground-parallel orientations of the antenna are set to make the measurement.
- d. For each suspected emission, the EUT was arranged to its worst case and the rotatable table was turned from 0 degrees to 360 degrees to find the maximum reading.
- e. The test-receiver system was set to Quasi-Peak Detect Function and Specified Bandwidth with Maximum Hold Mode.

##### **Note:**

1. The resolution bandwidth and video bandwidth of test receiver/spectrum analyzer is 9 kHz at frequency below 30 MHz.

##### **For Radiated Emission above 30 MHz**

- a. The EUT was placed on the top of a rotating table 0.8 meters (for 30 MHz ~ 1 GHz) / 1.5 meters (for above 1 GHz) above the ground at 3 meter chamber room for test. The table was rotated 360 degrees to determine the position of the highest radiation.
- b. The EUT was set 3 meters away from the interference-receiving antenna, which was mounted on the top of a variable-height antenna tower.
- c. The height of antenna is varied from one meter to four meters above the ground to determine the maximum value of the field strength. Both horizontal and vertical polarizations of the antenna are set to make the measurement.
- d. For each suspected emission, the EUT was arranged to its worst case and then the antenna was tuned to heights from 1 meter to 4 meters and the rotatable table was turned from 0 degrees to 360 degrees to find the maximum reading.
- e. The test-receiver system was set to quasi-peak detect function and specified bandwidth with maximum hold mode when the test frequency is below 1 GHz.
- f. The test-receiver system was set to peak and average detected function and specified bandwidth with maximum hold mode when the test frequency is above 1 GHz. If the peak reading value also meets average limit, measurement with the average detector is unnecessary.

##### **Note:**

1. The resolution bandwidth and video bandwidth of test receiver/spectrum analyzer is 120 kHz for Quasi-peak detection (QP) or Peak detection (PK) at frequency below 1 GHz.
2. The resolution bandwidth of test receiver/spectrum analyzer is 1 MHz and the video bandwidth is 3 MHz for Peak detection (PK) at frequency above 1 GHz.
3. The resolution bandwidth of test receiver/spectrum analyzer is 1 MHz and the video bandwidth is  $\geq 1/T$  (Duty cycle  $< 98\%$ ) or 10 Hz (Duty cycle  $\geq 98\%$ ) for Average detection (AV) at frequency above 1 GHz.  
(11a: RBW = 1 MHz, VBW = 1 kHz ; 11ax (HE20): RBW = 1 MHz, VBW = 1 kHz ;  
11ax (HE40): RBW = 1 MHz, VBW = 1 kHz ; 11ax (HE80): RBW = 1 MHz, VBW = 1 kHz)
4. All modes of operation were investigated and the worst-case emissions are reported.

4.1.4 Deviation from Test Standard

No deviation.

4.1.5 Test Setup

<Radiated Emission below 30 MHz>

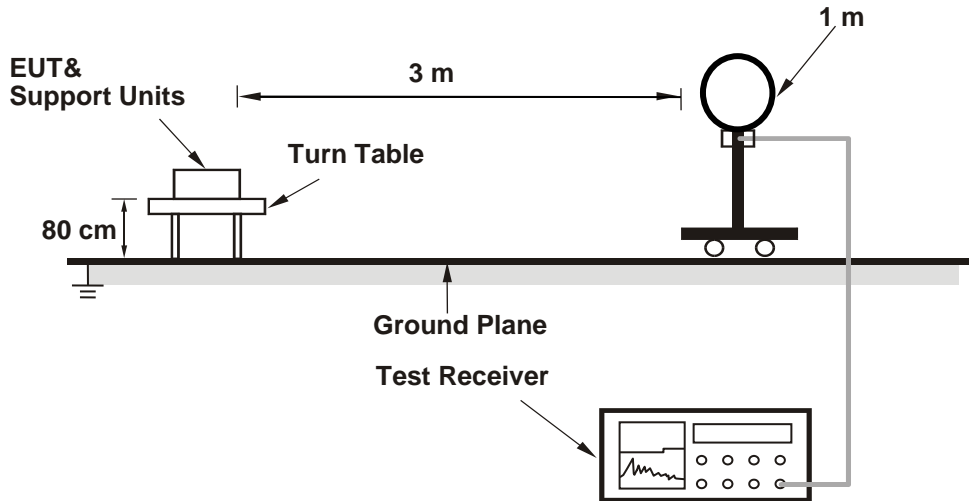

<Radiated Emission 30 MHz to 1 GHz>

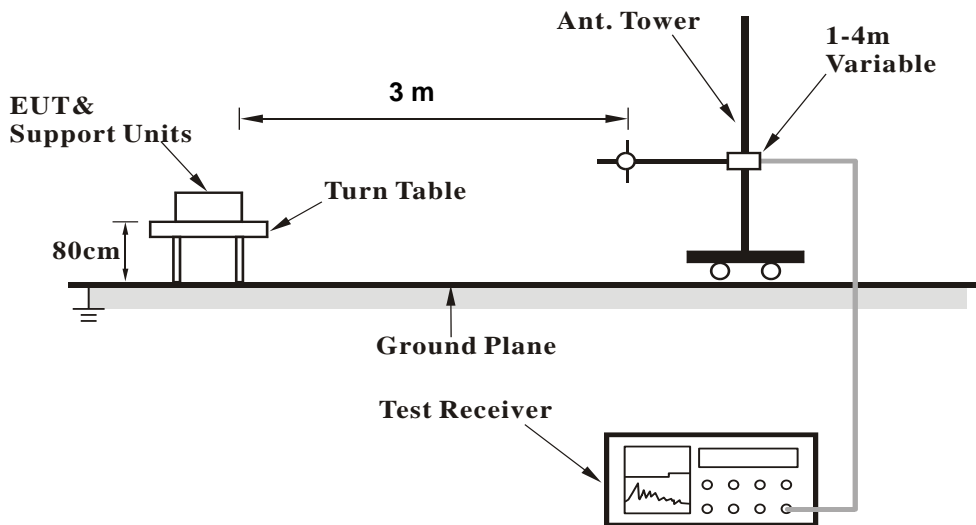

**<Radiated Emission above 1 GHz>**

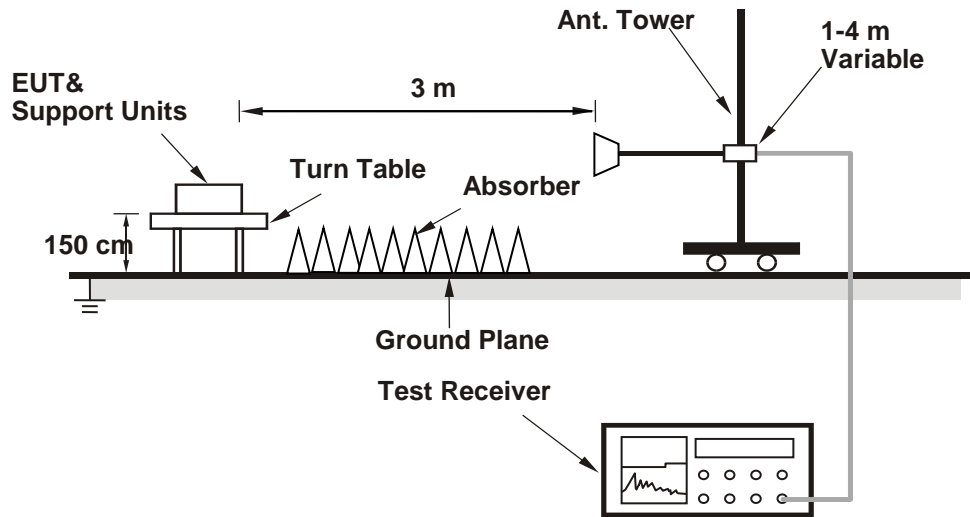

For the actual test configuration, please refer to the attached file (Test Setup Photo).

**4.1.6 EUT Operating Conditions**

- a. Placed the EUT on a testing table.
- b. Use the software to control the EUT under transmission condition continuously at specific channel frequency.

#### 4.1.7 Test Results

##### Above 1 GHz Data :

<b>RF Mode</b>	TX 802.11a	<b>Channel</b>	CH 36 : 5180 MHz
<b>Frequency Range</b>	1GHz ~ 40GHz	<b>Detector Function</b>	Peak (PK) Average (AV)

Antenna Polarity & Test Distance : Horizontal at 3 m								
No	Frequency (MHz)	Emission Level (dBUV/m)	Limit (dBUV/m)	Margin (dB)	Antenna Height (m)	Table Angle (Degree)	Raw Value (dBUV)	Correction Factor (dB/m)
1	5150.00	68.4 PK	74.0	-5.6	3.57 H	289	66.2	2.2
2	5150.00	53.4 AV	54.0	-0.6	3.57 H	289	51.2	2.2
3	*5180.00	118.3 PK			3.57 H	289	81.9	36.4
4	*5180.00	108.0 AV			3.57 H	289	71.6	36.4
5	#10360.00	58.9 PK	68.2	-9.3	1.29 H	194	43.7	15.2

Antenna Polarity & Test Distance : Vertical at 3 m								
No	Frequency (MHz)	Emission Level (dBUV/m)	Limit (dBUV/m)	Margin (dB)	Antenna Height (m)	Table Angle (Degree)	Raw Value (dBUV)	Correction Factor (dB/m)
1	5150.00	62.4 PK	74.0	-11.6	1.14 V	14	60.2	2.2
2	5150.00	47.1 AV	54.0	-6.9	1.14 V	14	44.9	2.2
3	*5180.00	113.3 PK			1.14 V	14	76.9	36.4
4	*5180.00	102.9 AV			1.14 V	14	66.5	36.4
5	#10360.00	58.0 PK	68.2	-10.2	1.18 V	179	42.8	15.2

#### Remarks:

1. Emission Level(dBUV/m) = Raw Value(dBUV) + Correction Factor(dB/m)
2. Correction Factor(dB/m) = Antenna Factor(dB/m) + Cable Factor(dB) – Pre-Amplifier Factor(dB)
3. Margin value = Emission Level – Limit value
4. The other emission levels were very low against the limit.
5. " \* ": Fundamental frequency.
6. " # ": The radiated frequency is out of the restricted band.

<b>RF Mode</b>	TX 802.11a	<b>Channel</b>	CH 40 : 5200 MHz
<b>Frequency Range</b>	1GHz ~ 40GHz	<b>Detector Function</b>	Peak (PK) Average (AV)

Antenna Polarity & Test Distance : Horizontal at 3 m								
No	Frequency (MHz)	Emission Level (dBuV/m)	Limit (dBuV/m)	Margin (dB)	Antenna Height (m)	Table Angle (Degree)	Raw Value (dBuV)	Correction Factor (dB/m)
1	*5200.00	119.8 PK			3.51 H	281	83.4	36.4
2	*5200.00	109.5 AV			3.51 H	281	73.1	36.4
3	#10400.00	59.1 PK	68.2	-9.1	1.31 H	197	43.9	15.2
Antenna Polarity & Test Distance : Vertical at 3 m								
No	Frequency (MHz)	Emission Level (dBuV/m)	Limit (dBuV/m)	Margin (dB)	Antenna Height (m)	Table Angle (Degree)	Raw Value (dBuV)	Correction Factor (dB/m)
1	*5200.00	114.8 PK			1.16 V	17	78.4	36.4
2	*5200.00	104.3 AV			1.16 V	17	67.9	36.4
3	#10400.00	58.6 PK	68.2	-9.6	1.24 V	183	43.4	15.2

**Remarks:**

1. Emission Level(dBuV/m) = Raw Value(dBuV) + Correction Factor(dB/m)
2. Correction Factor(dB/m) = Antenna Factor(dB/m) + Cable Factor(dB) – Pre-Amplifier Factor(dB)
3. Margin value = Emission Level – Limit value
4. The other emission levels were very low against the limit.
5. " \* ": Fundamental frequency.
6. " # ": The radiated frequency is out of the restricted band.

<b>RF Mode</b>	TX 802.11a	<b>Channel</b>	CH 48 : 5240 MHz
<b>Frequency Range</b>	1GHz ~ 40GHz	<b>Detector Function</b>	Peak (PK) Average (AV)

Antenna Polarity & Test Distance : Horizontal at 3 m								
No	Frequency (MHz)	Emission Level (dBuV/m)	Limit (dBuV/m)	Margin (dB)	Antenna Height (m)	Table Angle (Degree)	Raw Value (dBuV)	Correction Factor (dB/m)
1	*5240.00	118.9 PK			3.44 H	285	82.6	36.3
2	*5240.00	108.5 AV			3.44 H	285	72.2	36.3
3	5350.00	52.7 PK	74.0	-21.3	3.44 H	285	50.7	2.0
4	5350.00	39.7 AV	54.0	-14.3	3.44 H	285	37.7	2.0
5	#10480.00	58.6 PK	68.2	-9.6	1.27 H	192	43.5	15.1

Antenna Polarity & Test Distance : Vertical at 3 m								
No	Frequency (MHz)	Emission Level (dBuV/m)	Limit (dBuV/m)	Margin (dB)	Antenna Height (m)	Table Angle (Degree)	Raw Value (dBuV)	Correction Factor (dB/m)
1	*5240.00	114.0 PK			1.13 V	18	77.7	36.3
2	*5240.00	103.5 AV			1.13 V	18	67.2	36.3
3	5350.00	52.1 PK	74.0	-21.9	1.13 V	18	50.1	2.0
4	5350.00	39.2 AV	54.0	-14.8	1.13 V	18	37.2	2.0
5	#10480.00	58.4 PK	68.2	-9.8	1.21 V	176	43.3	15.1

**Remarks:**

1. Emission Level(dBuV/m) = Raw Value(dBuV) + Correction Factor(dB/m)
2. Correction Factor(dB/m) = Antenna Factor(dB/m) + Cable Factor(dB) – Pre-Amplifier Factor(dB)
3. Margin value = Emission Level – Limit value
4. The other emission levels were very low against the limit.
5. " \* ": Fundamental frequency.
6. " # ": The radiated frequency is out of the restricted band.



<b>RF Mode</b>	TX 802.11a	<b>Channel</b>	CH 149 : 5745 MHz
<b>Frequency Range</b>	1GHz ~ 40GHz	<b>Detector Function</b>	Peak (PK) Average (AV)

Antenna Polarity & Test Distance : Horizontal at 3 m								
No	Frequency (MHz)	Emission Level (dBuV/m)	Limit (dBuV/m)	Margin (dB)	Antenna Height (m)	Table Angle (Degree)	Raw Value (dBuV)	Correction Factor (dB/m)
1	*5745.00	115.4 PK			2.84 H	252	78.1	37.3
2	*5745.00	105.1 AV			2.84 H	252	67.8	37.3
3	11490.00	66.4 PK	74.0	-7.6	2.41 H	109	50.6	15.8
4	11490.00	53.0 AV	54.0	-1.0	2.41 H	109	37.2	15.8
Antenna Polarity & Test Distance : Vertical at 3 m								
No	Frequency (MHz)	Emission Level (dBuV/m)	Limit (dBuV/m)	Margin (dB)	Antenna Height (m)	Table Angle (Degree)	Raw Value (dBuV)	Correction Factor (dB/m)
1	*5745.00	110.5 PK			3.25 V	19	73.2	37.3
2	*5745.00	99.8 AV			3.25 V	19	62.5	37.3
3	11490.00	62.4 PK	74.0	-11.6	1.42 V	353	46.6	15.8
4	11490.00	48.3 AV	54.0	-5.7	1.42 V	353	32.5	15.8

**Remarks:**

1. Emission Level(dBuV/m) = Raw Value(dBuV) + Correction Factor(dB/m)
2. Correction Factor(dB/m) = Antenna Factor(dB/m) + Cable Factor(dB) – Pre-Amplifier Factor(dB)
3. Margin value = Emission Level – Limit value
4. The other emission levels were very low against the limit.
5. " \* ": Fundamental frequency.

<b>RF Mode</b>	TX 802.11a	<b>Channel</b>	CH 157 : 5785 MHz
<b>Frequency Range</b>	1GHz ~ 40GHz	<b>Detector Function</b>	Peak (PK) Average (AV)

Antenna Polarity & Test Distance : Horizontal at 3 m								
No	Frequency (MHz)	Emission Level (dBuV/m)	Limit (dBuV/m)	Margin (dB)	Antenna Height (m)	Table Angle (Degree)	Raw Value (dBuV)	Correction Factor (dB/m)
1	*5785.00	114.8 PK			2.97 H	251	77.3	37.5
2	*5785.00	104.1 AV			2.97 H	251	66.6	37.5
3	11570.00	65.9 PK	74.0	-8.1	2.19 H	128	50.5	15.4
4	11570.00	53.2 AV	54.0	-0.8	2.19 H	128	37.8	15.4
Antenna Polarity & Test Distance : Vertical at 3 m								
No	Frequency (MHz)	Emission Level (dBuV/m)	Limit (dBuV/m)	Margin (dB)	Antenna Height (m)	Table Angle (Degree)	Raw Value (dBuV)	Correction Factor (dB/m)
1	*5785.00	109.7 PK			3.23 V	16	72.2	37.5
2	*5785.00	98.9 AV			3.23 V	16	61.4	37.5
3	11570.00	62.1 PK	74.0	-11.9	1.51 V	352	46.7	15.4
4	11570.00	47.7 AV	54.0	-6.3	1.51 V	352	32.3	15.4

**Remarks:**

1. Emission Level(dBuV/m) = Raw Value(dBuV) + Correction Factor(dB/m)
2. Correction Factor(dB/m) = Antenna Factor(dB/m) + Cable Factor(dB) – Pre-Amplifier Factor(dB)
3. Margin value = Emission Level – Limit value
4. The other emission levels were very low against the limit.
5. " \* ": Fundamental frequency.

<b>RF Mode</b>	TX 802.11a	<b>Channel</b>	CH 165 : 5825 MHz
<b>Frequency Range</b>	1GHz ~ 40GHz	<b>Detector Function</b>	Peak (PK) Average (AV)

Antenna Polarity & Test Distance : Horizontal at 3 m								
No	Frequency (MHz)	Emission Level (dBuV/m)	Limit (dBuV/m)	Margin (dB)	Antenna Height (m)	Table Angle (Degree)	Raw Value (dBuV)	Correction Factor (dB/m)
1	*5825.00	111.1 PK			2.91 H	262	73.5	37.6
2	*5825.00	100.9 AV			2.91 H	262	63.3	37.6
3	11650.00	66.7 PK	74.0	-7.3	2.38 H	104	51.2	15.5
4	11650.00	53.3 AV	54.0	-0.7	2.38 H	104	37.8	15.5
Antenna Polarity & Test Distance : Vertical at 3 m								
No	Frequency (MHz)	Emission Level (dBuV/m)	Limit (dBuV/m)	Margin (dB)	Antenna Height (m)	Table Angle (Degree)	Raw Value (dBuV)	Correction Factor (dB/m)
1	*5825.00	106.2 PK			3.23 V	14	68.6	37.6
2	*5825.00	96.1 AV			3.23 V	14	58.5	37.6
3	11650.00	62.8 PK	74.0	-11.2	1.51 V	349	47.3	15.5
4	11650.00	48.3 AV	54.0	-5.7	1.51 V	349	32.8	15.5

**Remarks:**

1. Emission Level(dBuV/m) = Raw Value(dBuV) + Correction Factor(dB/m)
2. Correction Factor(dB/m) = Antenna Factor(dB/m) + Cable Factor(dB) – Pre-Amplifier Factor(dB)
3. Margin value = Emission Level – Limit value
4. The other emission levels were very low against the limit.
5. " \* ": Fundamental frequency.

<b>RF Mode</b>	TX 802.11ax (HE20)	<b>Channel</b>	CH 36 : 5180 MHz
<b>Frequency Range</b>	1GHz ~ 40GHz	<b>Detector Function</b>	Peak (PK) Average (AV)

Antenna Polarity & Test Distance : Horizontal at 3 m								
No	Frequency (MHz)	Emission Level (dBuV/m)	Limit (dBuV/m)	Margin (dB)	Antenna Height (m)	Table Angle (Degree)	Raw Value (dBuV)	Correction Factor (dB/m)
1	5150.00	68.5 PK	74.0	-5.5	3.55 H	285	66.3	2.2
2	5150.00	53.1 AV	54.0	-0.9	3.55 H	285	50.9	2.2
3	*5180.00	118.5 PK			3.55 H	285	82.1	36.4
4	*5180.00	106.5 AV			3.55 H	285	70.1	36.4
5	#10360.00	57.5 PK	68.2	-10.7	1.23 H	195	42.3	15.2

Antenna Polarity & Test Distance : Vertical at 3 m								
No	Frequency (MHz)	Emission Level (dBuV/m)	Limit (dBuV/m)	Margin (dB)	Antenna Height (m)	Table Angle (Degree)	Raw Value (dBuV)	Correction Factor (dB/m)
1	5150.00	63.5 PK	74.0	-10.5	1.17 V	16	61.3	2.2
2	5150.00	49.0 AV	54.0	-5.0	1.17 V	16	46.8	2.2
3	*5180.00	113.7 PK			1.17 V	16	77.3	36.4
4	*5180.00	101.6 AV			1.17 V	16	65.2	36.4
5	#10360.00	56.9 PK	68.2	-11.3	1.13 V	175	41.7	15.2

**Remarks:**

1. Emission Level(dBuV/m) = Raw Value(dBuV) + Correction Factor(dB/m)
2. Correction Factor(dB/m) = Antenna Factor(dB/m) + Cable Factor(dB) – Pre-Amplifier Factor(dB)
3. Margin value = Emission Level – Limit value
4. The other emission levels were very low against the limit.
5. " \* " : Fundamental frequency.
6. " # " : The radiated frequency is out of the restricted band.

<b>RF Mode</b>	TX 802.11ax (HE20)	<b>Channel</b>	CH 40 : 5200 MHz
<b>Frequency Range</b>	1GHz ~ 40GHz	<b>Detector Function</b>	Peak (PK) Average (AV)

Antenna Polarity & Test Distance : Horizontal at 3 m								
No	Frequency (MHz)	Emission Level (dBuV/m)	Limit (dBuV/m)	Margin (dB)	Antenna Height (m)	Table Angle (Degree)	Raw Value (dBuV)	Correction Factor (dB/m)
1	*5200.00	120.2 PK			3.59 H	282	83.8	36.4
2	*5200.00	108.0 AV			3.59 H	282	71.6	36.4
3	#10400.00	58.0 PK	68.2	-10.2	1.35 H	203	42.8	15.2
Antenna Polarity & Test Distance : Vertical at 3 m								
No	Frequency (MHz)	Emission Level (dBuV/m)	Limit (dBuV/m)	Margin (dB)	Antenna Height (m)	Table Angle (Degree)	Raw Value (dBuV)	Correction Factor (dB/m)
1	*5200.00	115.3 PK			1.18 V	13	78.9	36.4
2	*5200.00	103.1 AV			1.18 V	13	66.7	36.4
3	#10400.00	57.3 PK	68.2	-10.9	1.26 V	184	42.1	15.2

**Remarks:**

1. Emission Level(dBuV/m) = Raw Value(dBuV) + Correction Factor(dB/m)
2. Correction Factor(dB/m) = Antenna Factor(dB/m) + Cable Factor(dB) – Pre-Amplifier Factor(dB)
3. Margin value = Emission Level – Limit value
4. The other emission levels were very low against the limit.
5. " \* ": Fundamental frequency.
6. " # ": The radiated frequency is out of the restricted band.

<b>RF Mode</b>	TX 802.11ax (HE20)	<b>Channel</b>	CH 48 : 5240 MHz
<b>Frequency Range</b>	1GHz ~ 40GHz	<b>Detector Function</b>	Peak (PK) Average (AV)

Antenna Polarity & Test Distance : Horizontal at 3 m								
No	Frequency (MHz)	Emission Level (dBuV/m)	Limit (dBuV/m)	Margin (dB)	Antenna Height (m)	Table Angle (Degree)	Raw Value (dBuV)	Correction Factor (dB/m)
1	*5240.00	119.9 PK			3.46 H	284	83.6	36.3
2	*5240.00	107.9 AV			3.46 H	284	71.6	36.3
3	5350.00	52.2 PK	74.0	-21.8	3.46 H	284	50.2	2.0
4	5350.00	39.2 AV	54.0	-14.8	3.46 H	284	37.2	2.0
5	#10480.00	57.7 PK	68.2	-10.5	1.37 H	205	42.6	15.1

Antenna Polarity & Test Distance : Vertical at 3 m								
No	Frequency (MHz)	Emission Level (dBuV/m)	Limit (dBuV/m)	Margin (dB)	Antenna Height (m)	Table Angle (Degree)	Raw Value (dBuV)	Correction Factor (dB/m)
1	*5240.00	114.9 PK			1.18 V	19	78.6	36.3
2	*5240.00	102.8 AV			1.18 V	19	66.5	36.3
3	5350.00	51.2 PK	74.0	-22.8	1.18 V	19	49.2	2.0
4	5350.00	37.8 AV	54.0	-16.2	1.18 V	19	35.8	2.0
5	#10480.00	57.3 PK	68.2	-10.9	1.29 V	184	42.2	15.1

**Remarks:**

1. Emission Level(dBuV/m) = Raw Value(dBuV) + Correction Factor(dB/m)
2. Correction Factor(dB/m) = Antenna Factor(dB/m) + Cable Factor(dB) – Pre-Amplifier Factor(dB)
3. Margin value = Emission Level – Limit value
4. The other emission levels were very low against the limit.
5. " \* ": Fundamental frequency.
6. " # ": The radiated frequency is out of the restricted band.

<b>RF Mode</b>	TX 802.11ax (HE20)	<b>Channel</b>	CH 149 : 5745 MHz
<b>Frequency Range</b>	1GHz ~ 40GHz	<b>Detector Function</b>	Peak (PK) Average (AV)

Antenna Polarity & Test Distance : Horizontal at 3 m								
No	Frequency (MHz)	Emission Level (dBuV/m)	Limit (dBuV/m)	Margin (dB)	Antenna Height (m)	Table Angle (Degree)	Raw Value (dBuV)	Correction Factor (dB/m)
1	*5745.00	116.8 PK			2.82 H	252	79.5	37.3
2	*5745.00	104.1 AV			2.82 H	252	66.8	37.3
3	11490.00	66.6 PK	74.0	-7.4	2.32 H	112	50.8	15.8
4	11490.00	53.2 AV	54.0	-0.8	2.32 H	112	37.4	15.8
Antenna Polarity & Test Distance : Vertical at 3 m								
No	Frequency (MHz)	Emission Level (dBuV/m)	Limit (dBuV/m)	Margin (dB)	Antenna Height (m)	Table Angle (Degree)	Raw Value (dBuV)	Correction Factor (dB/m)
1	*5745.00	111.7 PK			3.21 V	17	74.4	37.3
2	*5745.00	99.1 AV			3.21 V	17	61.8	37.3
3	11490.00	63.0 PK	74.0	-11.0	1.48 V	347	47.2	15.8
4	11490.00	48.9 AV	54.0	-5.1	1.48 V	347	33.1	15.8

**Remarks:**

1. Emission Level(dBuV/m) = Raw Value(dBuV) + Correction Factor(dB/m)
2. Correction Factor(dB/m) = Antenna Factor(dB/m) + Cable Factor(dB) – Pre-Amplifier Factor(dB)
3. Margin value = Emission Level – Limit value
4. The other emission levels were very low against the limit.
5. " \* ": Fundamental frequency.

<b>RF Mode</b>	TX 802.11ax (HE20)	<b>Channel</b>	CH 157 : 5785 MHz
<b>Frequency Range</b>	1GHz ~ 40GHz	<b>Detector Function</b>	Peak (PK) Average (AV)

Antenna Polarity & Test Distance : Horizontal at 3 m								
No	Frequency (MHz)	Emission Level (dBuV/m)	Limit (dBuV/m)	Margin (dB)	Antenna Height (m)	Table Angle (Degree)	Raw Value (dBuV)	Correction Factor (dB/m)
1	*5785.00	118.0 PK			2.93 H	249	80.5	37.5
2	*5785.00	104.1 AV			2.93 H	249	66.6	37.5
3	11570.00	66.1 PK	74.0	-7.9	2.38 H	130	50.7	15.4
4	11570.00	53.0 AV	54.0	-1.0	2.38 H	130	37.6	15.4

Antenna Polarity & Test Distance : Vertical at 3 m								
No	Frequency (MHz)	Emission Level (dBuV/m)	Limit (dBuV/m)	Margin (dB)	Antenna Height (m)	Table Angle (Degree)	Raw Value (dBuV)	Correction Factor (dB/m)
1	*5785.00	111.3 PK			3.24 V	16	73.8	37.5
2	*5785.00	99.1 AV			3.24 V	16	61.6	37.5
3	11570.00	62.2 PK	74.0	-11.8	1.44 V	356	46.8	15.4
4	11570.00	48.1 AV	54.0	-5.9	1.44 V	356	32.7	15.4

**Remarks:**

1. Emission Level(dBuV/m) = Raw Value(dBuV) + Correction Factor(dB/m)
2. Correction Factor(dB/m) = Antenna Factor(dB/m) + Cable Factor(dB) – Pre-Amplifier Factor(dB)
3. Margin value = Emission Level – Limit value
4. The other emission levels were very low against the limit.
5. " \* ": Fundamental frequency.



<b>RF Mode</b>	TX 802.11ax (HE20)	<b>Channel</b>	CH 165 : 5825 MHz
<b>Frequency Range</b>	1GHz ~ 40GHz	<b>Detector Function</b>	Peak (PK) Average (AV)

Antenna Polarity & Test Distance : Horizontal at 3 m								
No	Frequency (MHz)	Emission Level (dBuV/m)	Limit (dBuV/m)	Margin (dB)	Antenna Height (m)	Table Angle (Degree)	Raw Value (dBuV)	Correction Factor (dB/m)
1	*5825.00	114.5 PK			2.88 H	260	76.9	37.6
2	*5825.00	101.3 AV			2.88 H	260	63.7	37.6
3	11650.00	69.3 PK	74.0	-4.7	2.37 H	105	53.8	15.5
4	<b>11650.00</b>	<b>53.5 AV</b>	<b>54.0</b>	<b>-0.5</b>	<b>2.37 H</b>	<b>105</b>	<b>38.0</b>	<b>15.5</b>

Antenna Polarity & Test Distance : Vertical at 3 m								
No	Frequency (MHz)	Emission Level (dBuV/m)	Limit (dBuV/m)	Margin (dB)	Antenna Height (m)	Table Angle (Degree)	Raw Value (dBuV)	Correction Factor (dB/m)
1	*5825.00	111.4 PK			2.64 V	11	73.8	37.6
2	*5825.00	98.6 AV			2.64 V	11	61.0	37.6
3	11650.00	62.1 PK	74.0	-11.9	1.38 V	17	46.6	15.5
4	11650.00	47.3 AV	54.0	-6.7	1.38 V	17	31.8	15.5

**Remarks:**

1. Emission Level(dBuV/m) = Raw Value(dBuV) + Correction Factor(dB/m)
2. Correction Factor(dB/m) = Antenna Factor(dB/m) + Cable Factor(dB) – Pre-Amplifier Factor(dB)
3. Margin value = Emission Level – Limit value
4. The other emission levels were very low against the limit.
5. " \* ": Fundamental frequency.

### 802.11ax (HE40)

<b>RF Mode</b>	TX 802.11ax (HE40)	<b>Channel</b>	CH 38 : 5190 MHz
<b>Frequency Range</b>	1GHz ~ 40GHz	<b>Detector Function</b>	Peak (PK) Average (AV)

#### Antenna Polarity & Test Distance : Horizontal at 3 m

No	Frequency (MHz)	Emission Level (dBuV/m)	Limit (dBuV/m)	Margin (dB)	Antenna Height (m)	Table Angle (Degree)	Raw Value (dBuV)	Correction Factor (dB/m)
1	5150.00	66.1 PK	74.0	-7.9	3.31 H	280	63.9	2.2
2	5150.00	53.0 AV	54.0	-1.0	3.31 H	280	50.8	2.2
3	*5190.00	114.3 PK			3.31 H	280	77.9	36.4
4	*5190.00	102.1 AV			3.31 H	280	65.7	36.4
5	#10380.00	57.0 PK	68.2	-11.2	1.32 H	199	41.8	15.2

#### Antenna Polarity & Test Distance : Vertical at 3 m

No	Frequency (MHz)	Emission Level (dBuV/m)	Limit (dBuV/m)	Margin (dB)	Antenna Height (m)	Table Angle (Degree)	Raw Value (dBuV)	Correction Factor (dB/m)
1	5150.00	62.3 PK	74.0	-11.7	1.21 V	11	60.1	2.2
2	5150.00	49.0 AV	54.0	-5.0	1.21 V	11	46.8	2.2
3	*5190.00	109.3 PK			1.21 V	11	72.9	36.4
4	*5190.00	97.3 AV			1.21 V	11	60.9	36.4
5	#10380.00	56.5 PK	68.2	-11.7	1.16 V	182	41.3	15.2

#### Remarks:

1. Emission Level(dBuV/m) = Raw Value(dBuV) + Correction Factor(dB/m)
2. Correction Factor(dB/m) = Antenna Factor(dB/m) + Cable Factor(dB) – Pre-Amplifier Factor(dB)
3. Margin value = Emission Level – Limit value
4. The other emission levels were very low against the limit.
5. " \* ": Fundamental frequency.
6. " # ": The radiated frequency is out of the restricted band.

<b>RF Mode</b>	TX 802.11ax (HE40)	<b>Channel</b>	CH 46 : 5230 MHz
<b>Frequency Range</b>	1GHz ~ 40GHz	<b>Detector Function</b>	Peak (PK) Average (AV)

Antenna Polarity & Test Distance : Horizontal at 3 m								
No	Frequency (MHz)	Emission Level (dBuV/m)	Limit (dBuV/m)	Margin (dB)	Antenna Height (m)	Table Angle (Degree)	Raw Value (dBuV)	Correction Factor (dB/m)
1	*5230.00	117.7 PK			3.49 H	285	81.4	36.3
2	*5230.00	105.2 AV			3.49 H	285	68.9	36.3
3	5350.00	54.6 PK	74.0	-19.4	3.49 H	285	52.6	2.0
4	5350.00	40.6 AV	54.0	-13.4	3.49 H	285	38.6	2.0
5	#10460.00	57.1 PK	68.2	-11.1	1.33 H	202	42.0	15.1

Antenna Polarity & Test Distance : Vertical at 3 m								
No	Frequency (MHz)	Emission Level (dBuV/m)	Limit (dBuV/m)	Margin (dB)	Antenna Height (m)	Table Angle (Degree)	Raw Value (dBuV)	Correction Factor (dB/m)
1	*5230.00	112.8 PK			1.25 V	12	76.5	36.3
2	*5230.00	100.2 AV			1.25 V	12	63.9	36.3
3	5350.00	54.0 PK	74.0	-20.0	1.25 V	12	52.0	2.0
4	5350.00	40.3 AV	54.0	-13.7	1.25 V	12	38.3	2.0
5	#10460.00	56.9 PK	68.2	-11.3	1.16 V	184	41.8	15.1

**Remarks:**

1. Emission Level(dBuV/m) = Raw Value(dBuV) + Correction Factor(dB/m)
2. Correction Factor(dB/m) = Antenna Factor(dB/m) + Cable Factor(dB) – Pre-Amplifier Factor(dB)
3. Margin value = Emission Level – Limit value
4. The other emission levels were very low against the limit.
5. " \* ": Fundamental frequency.
6. " # ": The radiated frequency is out of the restricted band.

<b>RF Mode</b>	TX 802.11ax (HE40)	<b>Channel</b>	CH 46 : 5230 MHz
<b>Frequency Range</b>	1GHz ~ 40GHz	<b>Detector Function</b>	Peak (PK) Average (AV)

Antenna Polarity & Test Distance : Horizontal at 3 m								
No	Frequency (MHz)	Emission Level (dBuV/m)	Limit (dBuV/m)	Margin (dB)	Antenna Height (m)	Table Angle (Degree)	Raw Value (dBuV)	Correction Factor (dB/m)
1	*5230.00	117.7 PK			3.49 H	285	81.4	36.3
2	*5230.00	105.2 AV			3.49 H	285	68.9	36.3
3	5350.00	54.6 PK	74.0	-19.4	3.49 H	285	52.6	2.0
4	5350.00	40.6 AV	54.0	-13.4	3.49 H	285	38.6	2.0
5	#10460.00	57.1 PK	68.2	-11.1	1.33 H	202	42.0	15.1

**Remarks:**

1. Emission Level(dBuV/m) = Raw Value(dBuV) + Correction Factor(dB/m)
2. Correction Factor(dB/m) = Antenna Factor(dB/m) + Cable Factor(dB) – Pre-Amplifier Factor(dB)
3. Margin value = Emission Level – Limit value
4. The other emission levels were very low against the limit.
5. " \* " : Fundamental frequency.
6. " # " : The radiated frequency is out of the restricted band.

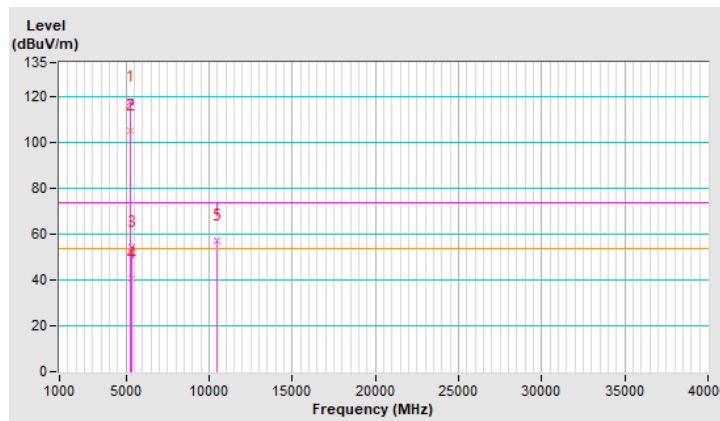

<b>RF Mode</b>	TX 802.11ax (HE40)	<b>Channel</b>	CH 46 : 5230 MHz
<b>Frequency Range</b>	1GHz ~ 40GHz	<b>Detector Function</b>	Peak (PK) Average (AV)

Antenna Polarity & Test Distance : Vertical at 3 m								
No	Frequency (MHz)	Emission Level (dBuV/m)	Limit (dBuV/m)	Margin (dB)	Antenna Height (m)	Table Angle (Degree)	Raw Value (dBuV)	Correction Factor (dB/m)
1	*5230.00	112.8 PK			1.25 V	12	76.5	36.3
2	*5230.00	100.2 AV			1.25 V	12	63.9	36.3
3	5350.00	54.0 PK	74.0	-20.0	1.25 V	12	52.0	2.0
4	5350.00	40.3 AV	54.0	-13.7	1.25 V	12	38.3	2.0
5	#10460.00	56.9 PK	68.2	-11.3	1.16 V	184	41.8	15.1

**Remarks:**

1. Emission Level(dBuV/m) = Raw Value(dBuV) + Correction Factor(dB/m)
2. Correction Factor(dB/m) = Antenna Factor(dB/m) + Cable Factor(dB) – Pre-Amplifier Factor(dB)
3. Margin value = Emission Level – Limit value
4. The other emission levels were very low against the limit.
5. " \* ": Fundamental frequency.
6. " # ": The radiated frequency is out of the restricted band.

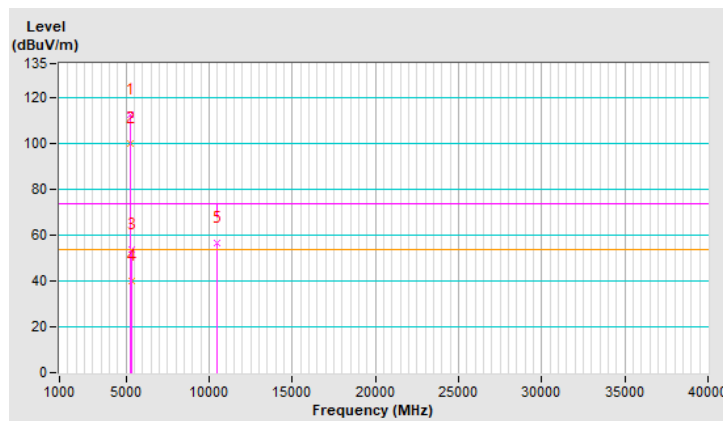

<b>RF Mode</b>	TX 802.11ax (HE40)	<b>Channel</b>	CH 151 : 5755 MHz
<b>Frequency Range</b>	1GHz ~ 40GHz	<b>Detector Function</b>	Peak (PK) Average (AV)

Antenna Polarity & Test Distance : Horizontal at 3 m								
No	Frequency (MHz)	Emission Level (dBuV/m)	Limit (dBuV/m)	Margin (dB)	Antenna Height (m)	Table Angle (Degree)	Raw Value (dBuV)	Correction Factor (dB/m)
1	*5755.00	117.8 PK			1.31 H	235	80.5	37.3
2	*5755.00	104.7 AV			1.31 H	235	67.4	37.3
3	11510.00	66.2 PK	74.0	-7.8	2.21 H	125	50.6	15.6
4	11510.00	52.5 AV	54.0	-1.5	2.21 H	125	36.9	15.6
Antenna Polarity & Test Distance : Vertical at 3 m								
No	Frequency (MHz)	Emission Level (dBuV/m)	Limit (dBuV/m)	Margin (dB)	Antenna Height (m)	Table Angle (Degree)	Raw Value (dBuV)	Correction Factor (dB/m)
1	*5755.00	112.5 PK			2.46 V	14	75.2	37.3
2	*5755.00	99.7 AV			2.46 V	14	62.4	37.3
3	11510.00	59.8 PK	74.0	-14.2	1.34 V	16	44.2	15.6
4	11510.00	46.9 AV	54.0	-7.1	1.34 V	16	31.3	15.6

**Remarks:**

1. Emission Level(dBuV/m) = Raw Value(dBuV) + Correction Factor(dB/m)
2. Correction Factor(dB/m) = Antenna Factor(dB/m) + Cable Factor(dB) – Pre-Amplifier Factor(dB)
3. Margin value = Emission Level – Limit value
4. The other emission levels were very low against the limit.
5. " \* ": Fundamental frequency.

<b>RF Mode</b>	TX 802.11ax (HE40)	<b>Channel</b>	CH 159 : 5795 MHz
<b>Frequency Range</b>	1GHz ~ 40GHz	<b>Detector Function</b>	Peak (PK) Average (AV)

Antenna Polarity & Test Distance : Horizontal at 3 m								
No	Frequency (MHz)	Emission Level (dBuV/m)	Limit (dBuV/m)	Margin (dB)	Antenna Height (m)	Table Angle (Degree)	Raw Value (dBuV)	Correction Factor (dB/m)
1	*5795.00	116.7 PK			1.34 H	232	79.1	37.6
2	*5795.00	102.8 AV			1.34 H	232	65.2	37.6
3	11590.00	66.2 PK	74.0	-7.8	2.26 H	130	50.8	15.4
4	11590.00	52.5 AV	54.0	-1.5	2.26 H	130	37.1	15.4
Antenna Polarity & Test Distance : Vertical at 3 m								
No	Frequency (MHz)	Emission Level (dBuV/m)	Limit (dBuV/m)	Margin (dB)	Antenna Height (m)	Table Angle (Degree)	Raw Value (dBuV)	Correction Factor (dB/m)
1	*5795.00	113.1 PK			2.68 V	10	75.5	37.6
2	*5795.00	100.1 AV			2.68 V	10	62.5	37.6
3	11590.00	60.0 PK	74.0	-14.0	1.32 V	16	44.6	15.4
4	11590.00	47.1 AV	54.0	-6.9	1.32 V	16	31.7	15.4

**Remarks:**

1. Emission Level(dBuV/m) = Raw Value(dBuV) + Correction Factor(dB/m)
2. Correction Factor(dB/m) = Antenna Factor(dB/m) + Cable Factor(dB) – Pre-Amplifier Factor(dB)
3. Margin value = Emission Level – Limit value
4. The other emission levels were very low against the limit.
5. " \* ": Fundamental frequency.

### 802.11ax (HE80)

<b>RF Mode</b>	TX 802.11ax (HE80)	<b>Channel</b>	CH 42 : 5210 MHz
<b>Frequency Range</b>	1GHz ~ 40GHz	<b>Detector Function</b>	Peak (PK) Average (AV)

#### Antenna Polarity & Test Distance : Horizontal at 3 m

No	Frequency (MHz)	Emission Level (dBuV/m)	Limit (dBuV/m)	Margin (dB)	Antenna Height (m)	Table Angle (Degree)	Raw Value (dBuV)	Correction Factor (dB/m)
1	5150.00	66.8 PK	74.0	-7.2	3.49 H	283	64.6	2.2
2	5150.00	53.0 AV	54.0	-1.0	3.49 H	283	50.8	2.2
3	*5210.00	112.2 PK			3.49 H	283	75.8	36.4
4	*5210.00	99.6 AV			3.49 H	283	63.2	36.4
5	5350.00	54.4 PK	74.0	-19.6	3.49 H	283	52.4	2.0
6	5350.00	41.1 AV	54.0	-12.9	3.49 H	283	39.1	2.0
7	#10420.00	56.8 PK	68.2	-11.4	1.32 H	198	41.6	15.2

#### Antenna Polarity & Test Distance : Vertical at 3 m

No	Frequency (MHz)	Emission Level (dBuV/m)	Limit (dBuV/m)	Margin (dB)	Antenna Height (m)	Table Angle (Degree)	Raw Value (dBuV)	Correction Factor (dB/m)
1	5150.00	62.6 PK	74.0	-11.4	1.15 V	16	60.4	2.2
2	5150.00	49.6 AV	54.0	-4.4	1.15 V	16	47.4	2.2
3	*5210.00	106.9 PK			1.15 V	16	70.5	36.4
4	*5210.00	94.7 AV			1.15 V	16	58.3	36.4
5	5350.00	52.2 PK	74.0	-21.8	1.15 V	16	50.2	2.0
6	5350.00	39.1 AV	54.0	-14.9	1.15 V	16	37.1	2.0
7	#10420.00	56.4 PK	68.2	-11.8	1.26 V	187	41.2	15.2

#### Remarks:

1. Emission Level(dBuV/m) = Raw Value(dBuV) + Correction Factor(dB/m)
2. Correction Factor(dB/m) = Antenna Factor(dB/m) + Cable Factor(dB) – Pre-Amplifier Factor(dB)
3. Margin value = Emission Level – Limit value
4. The other emission levels were very low against the limit.
5. " \* ": Fundamental frequency.
6. " # ": The radiated frequency is out of the restricted band.



<b>RF Mode</b>	TX 802.11ax (HE80)	<b>Channel</b>	CH 155 : 5775 MHz
<b>Frequency Range</b>	1GHz ~ 40GHz	<b>Detector Function</b>	Peak (PK) Average (AV)

Antenna Polarity & Test Distance : Horizontal at 3 m								
No	Frequency (MHz)	Emission Level (dBuV/m)	Limit (dBuV/m)	Margin (dB)	Antenna Height (m)	Table Angle (Degree)	Raw Value (dBuV)	Correction Factor (dB/m)
1	*5775.00	113.5 PK			1.30 H	234	76.0	37.5
2	*5775.00	100.5 AV			1.30 H	234	63.0	37.5
3	11550.00	61.6 PK	74.0	-12.4	2.60 H	128	46.0	15.6
4	11550.00	49.0 AV	54.0	-5.0	2.60 H	128	33.4	15.6
Antenna Polarity & Test Distance : Vertical at 3 m								
No	Frequency (MHz)	Emission Level (dBuV/m)	Limit (dBuV/m)	Margin (dB)	Antenna Height (m)	Table Angle (Degree)	Raw Value (dBuV)	Correction Factor (dB/m)
1	*5775.00	110.6 PK			2.67 V	12	73.1	37.5
2	*5775.00	97.0 AV			2.67 V	12	59.5	37.5
3	11550.00	56.4 PK	74.0	-17.6	1.42 V	17	40.8	15.6
4	11550.00	43.0 AV	54.0	-11.0	1.42 V	17	27.4	15.6

**Remarks:**

1. Emission Level(dBuV/m) = Raw Value(dBuV) + Correction Factor(dB/m)
2. Correction Factor(dB/m) = Antenna Factor(dB/m) + Cable Factor(dB) – Pre-Amplifier Factor(dB)
3. Margin value = Emission Level – Limit value
4. The other emission levels were very low against the limit.
5. " \* ": Fundamental frequency.

**30 MHz ~ 1 GHz Worst-Case Data:**  
**802.11a**

<b>RF Mode</b>	TX 802.11a	<b>Channel</b>	CH 40 : 5200 MHz
<b>Frequency Range</b>	30MHz ~ 1GHz	<b>Detector Function</b>	Quasi-Peak (QP)

Antenna Polarity & Test Distance : Horizontal at 3 m								
No	Frequency (MHz)	Emission Level (dBuV/m)	Limit (dBuV/m)	Margin (dB)	Antenna Height (m)	Table Angle (Degree)	Raw Value (dBuV)	Correction Factor (dB/m)
1	32.91	29.3 QP	40.0	-10.7	1.25 H	197	39.7	-10.4
2	56.19	32.5 QP	40.0	-7.5	1.00 H	10	41.5	-9.0
3	84.32	30.0 QP	40.0	-10.0	1.50 H	353	44.1	-14.1
4	337.49	34.0 QP	46.0	-12.0	1.25 H	143	39.9	-5.9
5	381.14	34.8 QP	46.0	-11.2	1.00 H	243	39.8	-5.0
6	543.13	35.7 QP	46.0	-10.3	1.50 H	47	37.6	-1.9

**Remarks:**

1. Emission Level(dBuV/m) = Raw Value(dBuV) + Correction Factor(dB/m)
2. Correction Factor(dB/m) = Antenna Factor(dB/m) + Cable Factor(dB) – Pre-Amplifier Factor(dB)
3. Margin value = Emission Level – Limit value
4. The other emission levels were very low against the limit of frequency range 30MHz~1000MHz.
5. The emission levels were very low against the limit of frequency range 9kHz~30MHz: the amplitude of spurious emissions attenuated more than 20 dB below the permissible value to be report.

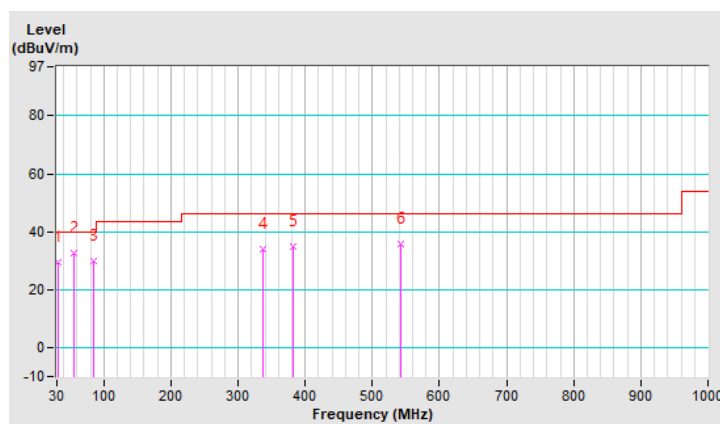

<b>RF Mode</b>	TX 802.11a	<b>Channel</b>	CH 40 : 5200 MHz
<b>Frequency Range</b>	30MHz ~ 1GHz	<b>Detector Function</b>	Quasi-Peak (QP)

Antenna Polarity & Test Distance : Vertical at 3 m								
No	Frequency (MHz)	Emission Level (dBUV/m)	Limit (dBUV/m)	Margin (dB)	Antenna Height (m)	Table Angle (Degree)	Raw Value (dBUV)	Correction Factor (dB/m)
1	53.28	32.5 QP	40.0	-7.5	1.50 V	5	41.5	-9.0
2	70.74	30.6 QP	40.0	-9.4	1.25 V	184	41.5	-10.9
3	105.66	26.2 QP	43.5	-17.3	1.00 V	250	38.3	-12.1
4	166.77	22.3 QP	43.5	-21.2	2.00 V	186	30.7	-8.4
5	433.52	29.2 QP	46.0	-16.8	1.25 V	223	33.1	-3.9
6	546.04	33.6 QP	46.0	-12.4	1.00 V	46	35.5	-1.9

**Remarks:**

1. Emission Level(dBUV/m) = Raw Value(dBuV) + Correction Factor(dB/m)
2. Correction Factor(dB/m) = Antenna Factor(dB/m) + Cable Factor(dB) – Pre-Amplifier Factor(dB)
3. Margin value = Emission Level – Limit value
4. The other emission levels were very low against the limit of frequency range 30MHz~1000MHz.
5. The emission levels were very low against the limit of frequency range 9kHz~30MHz: the amplitude of spurious emissions attenuated more than 20 dB below the permissible value to be report.

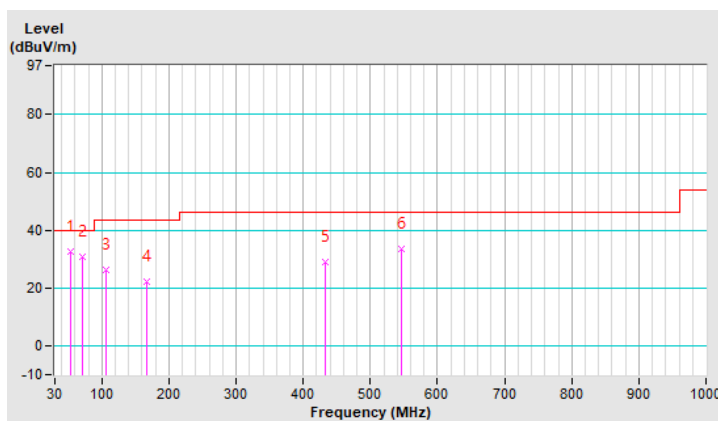

## 4.2 Conducted Emission Measurement

### 4.2.1 Limits of Conducted Emission Measurement

Frequency (MHz)	Conducted Limit (dBuV)	
	Quasi-Peak	Average
0.15 - 0.5	66 - 56	56 - 46
0.50 - 5.0	56	46
5.0 - 30.0	60	50

- Note: 1. The lower limit shall apply at the transition frequencies.  
 2. The limit decreases in line with the logarithm of the frequency in the range of 0.15 to 0.50 MHz.

### 4.2.2 Test Instruments

Description & Manufacturer	Model No.	Serial No.	Date of Calibration	Due Date of Calibration
Test Receiver ROHDE & SCHWARZ	ESR3	102783	Dec. 21, 2020	Dec. 20, 2021
RF signal cable (with 10dB PAD) Woken	5D-FB	Cable-cond2-01	Sep. 04, 2020	Sep. 03, 2021
LISN ROHDE & SCHWARZ (EUT)	ESH2-Z5	100100	Jan. 18, 2021	Jan. 17, 2022
LISN ROHDE & SCHWARZ (Peripheral)	ESH3-Z5	100312	Aug. 18, 2020	Aug. 17, 2021
Software ADT	BV ADT_Cond_ V7.3.7.4	NA	NA	NA

- Note: 1. The calibration interval of the above test instruments is 12 months and the calibrations are traceable to NML/ROC and NIST/USA.  
 2. The test was performed in HwaYa Shielded Room 2 (Conduction 2).  
 3. The VCCI Site Registration No. is C-12047.

#### 4.2.3 Test Procedures

- a. The EUT was placed 0.4 meters from the conducting wall of the shielded room with EUT being connected to the power mains through a line impedance stabilization network (LISN). Other support units were connected to the power mains through another LISN. The two LISNs provide 50 ohm/ 50uH of coupling impedance for the measuring instrument.
- b. Both lines of the power mains connected to the EUT were checked for maximum conducted interference.
- c. The frequency range from 150 kHz to 30 MHz was searched. Emission levels under (Limit -20 dB) was not recorded.

**Note:** All modes of operation were investigated and the worst-case emissions are reported.

#### 4.2.4 Deviation from Test Standard

No deviation.

#### 4.2.5 Test Setup

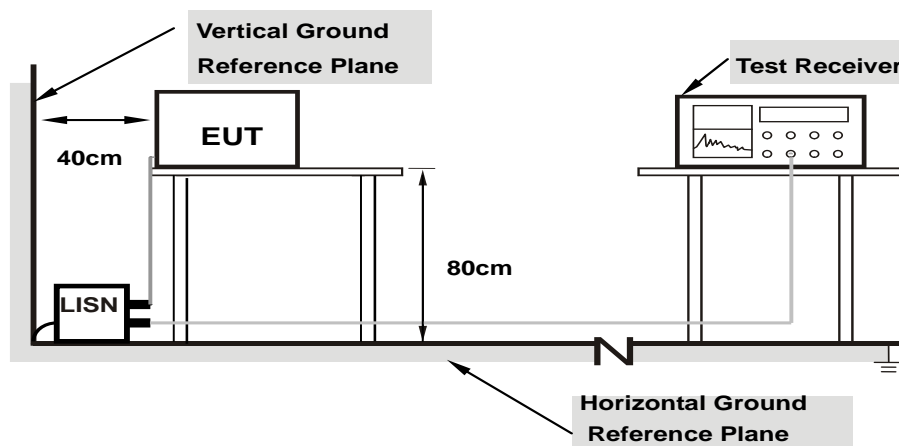

- Note:**
1. Support units were connected to second LISN.
  2. Both of LISNs (AMN) are 80 cm from EUT and at least 80 from other units and other metal planes

For the actual test configuration, please refer to the attached file (Test Setup Photo).

#### 4.2.6 EUT Operating Conditions

- a. Placed the EUT on a testing table.
- b. Use the software to control the EUT under transmission condition continuously at specific channel frequency.

#### 4.2.7 Test Results

<b>Frequency Range</b>	150kHz ~ 30MHz	<b>Detector Function &amp; Resolution Bandwidth</b>	Quasi-Peak (QP) / Average (AV), 9kHz
<b>Input Power</b>	120Vac, 60Hz	<b>Environmental Conditions</b>	23°C, 66%RH
<b>Tested by</b>	Rex Wang	<b>Test Date</b>	2021/1/25

Phase Of Power : Line (L)										
No	Frequency (MHz)	Correction Factor (dB)	Reading Value (dBuV)		Emission Level (dBuV)		Limit (dBuV)		Margin (dB)	
			Q.P.	AV.	Q.P.	AV.	Q.P.	AV.	Q.P.	AV.
1	0.15400	9.71	22.65	18.74	32.36	28.45	65.78	55.78	-33.42	-27.33
<b>2</b>	<b>0.19800</b>	<b>9.75</b>	<b>24.00</b>	<b>17.39</b>	<b>33.75</b>	<b>27.14</b>	<b>63.69</b>	<b>53.69</b>	<b>-29.94</b>	<b>-26.55</b>
3	3.60200	10.00	12.87	5.33	22.87	15.33	56.00	46.00	-33.13	-30.67
4	4.11400	10.01	16.11	8.91	26.12	18.92	56.00	46.00	-29.88	-27.08
5	14.10200	10.18	5.84	0.07	16.02	10.25	60.00	50.00	-43.98	-39.75
6	20.63800	10.24	8.70	1.12	18.94	11.36	60.00	50.00	-41.06	-38.64

#### Remarks:

1. Q.P. and AV. are abbreviations of quasi-peak and average individually.
2. The emission levels of other frequencies were very low against the limit.
3. Margin value = Emission level – Limit value
4. Correction factor = Insertion loss + Cable loss
5. Emission Level = Correction Factor + Reading Value

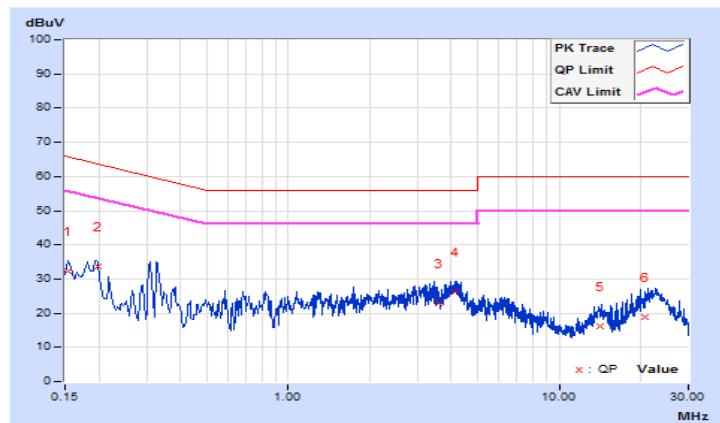

<b>Frequency Range</b>	150kHz ~ 30MHz	<b>Detector Function &amp; Resolution Bandwidth</b>	Quasi-Peak (QP) / Average (AV), 9kHz
<b>Input Power</b>	120Vac, 60Hz	<b>Environmental Conditions</b>	23°C, 66%RH
<b>Tested by</b>	Rex Wang	<b>Test Date</b>	2021/1/25

Phase Of Power : Neutral (N)										
No	Frequency (MHz)	Correction Factor (dB)	Reading Value (dBuV)		Emission Level (dBuV)		Limit (dBuV)		Margin (dB)	
			Q.P.	AV.	Q.P.	AV.	Q.P.	AV.	Q.P.	AV.
1	0.15687	9.71	25.43	17.65	35.14	27.36	65.63	55.63	-30.49	-28.27
2	0.19800	9.74	23.01	17.28	32.75	27.02	63.69	53.69	-30.94	-26.67
3	1.21400	9.87	13.18	6.38	23.05	16.25	56.00	46.00	-32.95	-29.75
4	3.68600	10.00	12.58	2.78	22.58	12.78	56.00	46.00	-33.42	-33.22
5	14.29000	10.21	5.32	0.54	15.53	10.75	60.00	50.00	-44.47	-39.25
6	19.63800	10.28	8.22	1.29	18.50	11.57	60.00	50.00	-41.50	-38.43

**Remarks:**

1. Q.P. and AV. are abbreviations of quasi-peak and average individually.
2. The emission levels of other frequencies were very low against the limit.
3. Margin value = Emission level – Limit value
4. Correction factor = Insertion loss + Cable loss
5. Emission Level = Correction Factor + Reading Value

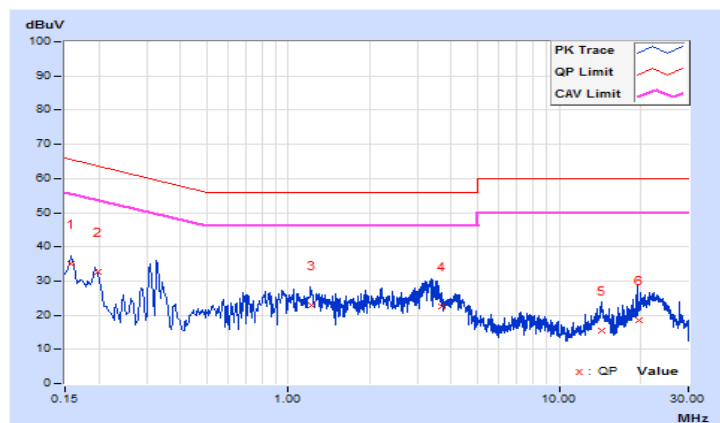

### 4.3 Transmit Power Measurement

#### 4.3.1 Limits of Transmit Power Measurement

Operation Band	EUT Category		Limit
U-NII-1		Outdoor Access Point	1 Watt (30 dBm) (Max. e.i.r.p $\leq$ 125 mW (21 dBm) at any elevation angle above 30 degrees as measured from the horizon)
		Fixed point-to-point Access Point	1 Watt (30 dBm)
	√	Indoor Access Point	1 Watt (30 dBm)
		Mobile and Portable client device	250 mW (24 dBm)
U-NII-2A			250 mW (24 dBm) or 11 dBm + 10 log B*
U-NII-2C			250 mW (24 dBm) or 11 dBm + 10 log B*
U-NII-3	√		1 Watt (30 dBm)

\*B is the 26 dB emission bandwidth in megahertz

Per KDB 662911 Method of conducted output power measurement on IEEE 802.11 devices,

Array Gain = 0 dB (i.e., no array gain) for  $N_{ANT} \leq 4$ ;

Array Gain = 0 dB (i.e., no array gain) for channel widths  $\geq 40$  MHz for any  $N_{ANT}$ ;

Array Gain =  $5 \log(N_{ANT}/N_{SS})$  dB or 3 dB, whichever is less for 20 MHz channel widths with  $N_{ANT} \geq 5$ .

For power measurements on all other devices: Array Gain =  $10 \log(N_{ANT}/N_{SS})$  dB.

#### 4.3.2 Test Setup

##### <Power Output Measurement>

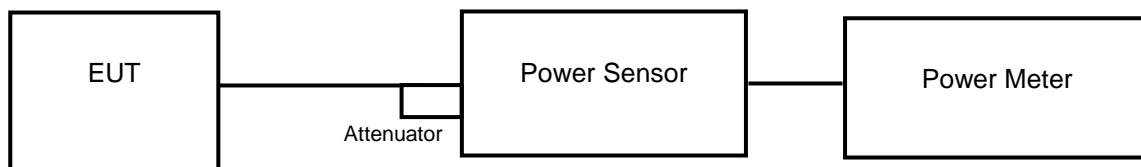

##### <26 dB Bandwidth>

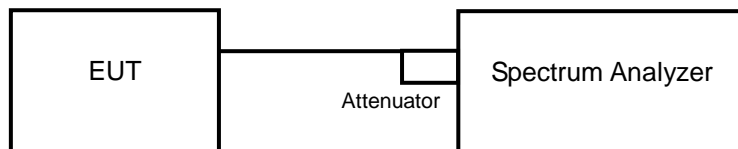



#### 4.3.3 Test Instruments

Refer to section 4.1.2 to get information of above instrument.

#### 4.3.4 Test Procedure

##### **Average Power Measurement**

Method PM is used to perform output power measurement, trigger and gating function of wide band power meter is enabled to measure max output power of TX on burst. Duty factor is not added to measured value.

##### **26 dB Bandwidth**

- a. Set RBW = approximately 1 % of the emission bandwidth.
- b. Set the VBW  $\geq 3 \times$  RBW.
- c. Detector = Peak.
- d. Trace mode = max hold.
- e. Measure the maximum width of the emission that is 26 dB down from the peak of the emission. Compare this with the RBW setting of the analyzer. Readjust RBW and repeat measurement as needed until the RBW/EBW ratio is approximately 1 %.

#### 4.3.5 Deviation from Test Standard

No deviation.

#### 4.3.6 EUT Operating Conditions

The software provided by client to enable the EUT under transmission condition continuously at lowest, middle and highest channel frequencies individually.

#### 4.3.7 Test Results

##### Power Output:

##### CDD Mode

##### 802.11a

Channel	Frequency (MHz)	Maximum Conducted Power (dBm)		Total Power (mW)	Total Power (dBm)	Power Limit (dBm)	Pass / Fail
		Chain 0	Chain 1				
36	5180	23.28	23.68	446.16	26.49	30	Pass
40	5200	24.02	24.53	536.14	27.29	30	Pass
48	5240	23.78	24.26	505.467	27.04	30	Pass
149	5745	20.05	20.84	222.497	23.47	30	Pass
157	5785	19.46	19.90	186.032	22.70	30	Pass
165	5825	17.58	17.72	116.436	20.66	30	Pass

##### 802.11n (HT20)

Channel	Frequency (MHz)	Maximum Conducted Power (dBm)		Total Power (mW)	Total Power (dBm)	Power Limit (dBm)	Pass / Fail
		Chain 0	Chain 1				
36	5180	22.61	23.56	409.376	26.12	30	Pass
40	5200	23.71	24.05	489.061	26.89	30	Pass
48	5240	23.57	23.96	476.395	26.78	30	Pass
149	5745	20.26	21.06	233.813	23.69	30	Pass
157	5785	20.06	20.76	220.515	23.43	30	Pass
165	5825	18.00	18.81	139.128	21.43	30	Pass

##### 802.11n (HT40)

Channel	Frequency (MHz)	Maximum Conducted Power (dBm)		Total Power (mW)	Total Power (dBm)	Power Limit (dBm)	Pass / Fail
		Chain 0	Chain 1				
38	5190	20.04	20.53	213.905	23.30	30	Pass
46	5230	23.91	24.40	521.46	27.17	30	Pass
151	5755	23.68	24.63	523.748	27.19	30	Pass
159	5795	23.38	24.07	473.041	26.75	30	Pass

**802.11ac (VHT20)**

Channel	Frequency (MHz)	Maximum Conducted Power (dBm)		Total Power (mW)	Total Power (dBm)	Power Limit (dBm)	Pass / Fail
		Chain 0	Chain 1				
36	5180	22.64	23.57	411.164	26.14	30	Pass
40	5200	23.73	24.08	491.906	26.92	30	Pass
48	5240	23.61	23.99	480.226	26.81	30	Pass
149	5745	20.28	21.09	235.188	23.71	30	Pass
157	5785	20.08	20.79	221.809	23.46	30	Pass
165	5825	18.01	18.83	139.625	21.45	30	Pass

**802.11ac (VHT40)**

Channel	Frequency (MHz)	Maximum Conducted Power (dBm)		Total Power (mW)	Total Power (dBm)	Power Limit (dBm)	Pass / Fail
		Chain 0	Chain 1				
38	5190	20.07	20.56	215.388	23.33	30	Pass
46	5230	23.93	24.43	524.504	27.20	30	Pass
151	5755	23.70	24.66	526.838	27.22	30	Pass
159	5795	23.40	24.11	476.408	26.78	30	Pass

**802.11ac (VHT80)**

Channel	Frequency (MHz)	Maximum Conducted Power (dBm)		Total Power (mW)	Total Power (dBm)	Power Limit (dBm)	Pass / Fail
		Chain 0	Chain 1				
42	5210	19.31	19.78	180.37	22.56	30	Pass
155	5775	23.24	23.98	460.897	26.64	30	Pass

**802.11ax (HE20)**

Channel	Frequency (MHz)	Maximum Conducted Power (dBm)		Total Power (mW)	Total Power (dBm)	Power Limit (dBm)	Pass / Fail
		Chain 0	Chain 1				
36	5180	22.67	23.59	413.487	26.16	30	Pass
40	5200	23.76	24.12	495.91	26.95	30	Pass
48	5240	23.64	24.03	484.136	26.85	30	Pass
149	5745	20.31	21.12	236.819	23.74	30	Pass
157	5785	20.11	20.82	223.347	23.49	30	Pass
165	5825	18.04	18.86	140.593	21.48	30	Pass

**802.11ax (HE40)**

Channel	Frequency (MHz)	Maximum Conducted Power (dBm)		Total Power (mW)	Total Power (dBm)	Power Limit (dBm)	Pass / Fail
		Chain 0	Chain 1				
38	5190	20.11	20.60	217.381	23.37	30	Pass
46	5230	23.96	24.46	528.14	27.23	30	Pass
151	5755	23.73	24.68	529.813	27.24	30	Pass
159	5795	23.42	24.14	479.204	26.81	30	Pass

**802.11ax (HE80)**

Channel	Frequency (MHz)	Maximum Conducted Power (dBm)		Total Power (mW)	Total Power (dBm)	Power Limit (dBm)	Pass / Fail
		Chain 0	Chain 1				
42	5210	19.34	19.82	181.841	22.60	30	Pass
155	5775	23.27	24.01	464.092	26.67	30	Pass

### Beamforming Mode

#### 802.11n (HT20)

Channel	Frequency (MHz)	Maximum Conducted Power (dBm)		Total Power (mW)	Total Power (dBm)	Power Limit (dBm)	Pass / Fail
		Chain 0	Chain 1				
36	5180	19.60	20.55	204.702	23.11	28.49	Pass
40	5200	20.70	21.04	244.547	23.88	28.49	Pass
48	5240	20.56	20.95	238.214	23.77	28.49	Pass
149	5745	17.25	18.05	116.915	20.68	28.49	Pass
157	5785	17.05	17.75	110.265	20.42	28.49	Pass
165	5825	14.99	15.80	69.569	18.42	28.49	Pass

NOTE: Directional gain = 7.51 dBi > 6dBi, so the output power limit shall be reduced to  $30 - (7.51 - 6) = 28.49$  dBm.

#### 802.11n (HT40)

Channel	Frequency (MHz)	Maximum Conducted Power (dBm)		Total Power (mW)	Total Power (dBm)	Power Limit (dBm)	Pass / Fail
		Chain 0	Chain 1				
38	5190	17.03	17.52	106.96	20.29	28.49	Pass
46	5230	20.90	21.39	260.748	24.16	28.49	Pass
151	5755	20.67	21.62	261.892	24.18	28.49	Pass
159	5795	20.37	21.06	236.537	23.74	28.49	Pass

NOTE: Directional gain = 7.51 dBi > 6dBi, so the output power limit shall be reduced to  $30 - (7.51 - 6) = 28.49$  dBm.

### 802.11ac (VHT20)

Channel	Frequency (MHz)	Maximum Conducted Power (dBm)		Total Power (mW)	Total Power (dBm)	Power Limit (dBm)	Pass / Fail
		Chain 0	Chain 1				
36	5180	19.63	20.56	205.596	23.13	28.49	Pass
40	5200	20.72	21.07	245.97	23.91	28.49	Pass
48	5240	20.60	20.98	240.129	23.80	28.49	Pass
149	5745	17.27	18.08	117.602	20.70	28.49	Pass
157	5785	17.07	17.78	110.912	20.45	28.49	Pass
165	5825	15.00	15.82	69.817	18.44	28.49	Pass

NOTE: Directional gain = 7.51 dBi > 6dBi, so the output power limit shall be reduced to  $30-(7.51-6) = 28.49$  dBm.

### 802.11ac (VHT40)

Channel	Frequency (MHz)	Maximum Conducted Power (dBm)		Total Power (mW)	Total Power (dBm)	Power Limit (dBm)	Pass / Fail
		Chain 0	Chain 1				
38	5190	17.06	17.55	107.701	20.32	28.49	Pass
46	5230	20.92	21.42	262.27	24.19	28.49	Pass
151	5755	20.69	21.65	263.437	24.21	28.49	Pass
159	5795	20.39	21.10	238.221	23.77	28.49	Pass

NOTE: Directional gain = 7.51 dBi > 6dBi, so the output power limit shall be reduced to  $30-(7.51-6) = 28.49$  dBm.

### 802.11ac (VHT80)

Channel	Frequency (MHz)	Maximum Conducted Power (dBm)		Total Power (mW)	Total Power (dBm)	Power Limit (dBm)	Pass / Fail
		Chain 0	Chain 1				
42	5210	16.30	16.77	90.191	19.55	28.49	Pass
155	5775	20.23	20.97	230.465	23.63	28.49	Pass

NOTE: Directional gain = 7.51 dBi > 6dBi, so the output power limit shall be reduced to  $30-(7.51-6) = 28.49$  dBm.

### 802.11ax (HE20)

Channel	Frequency (MHz)	Maximum Conducted Power (dBm)		Total Power (mW)	Total Power (dBm)	Power Limit (dBm)	Pass / Fail
		Chain 0	Chain 1				
36	5180	19.66	20.58	206.758	23.15	28.49	Pass
40	5200	20.75	21.11	247.972	23.94	28.49	Pass
48	5240	20.63	21.02	242.085	23.84	28.49	Pass
149	5745	17.30	18.11	118.417	20.73	28.49	Pass
157	5785	17.10	17.81	111.681	20.48	28.49	Pass
165	5825	15.03	15.85	70.301	18.47	28.49	Pass

NOTE: Directional gain = 7.51 dBi > 6dBi, so the output power limit shall be reduced to  $30-(7.51-6) = 28.49$  dBm.

### 802.11ax (HE40)

Channel	Frequency (MHz)	Maximum Conducted Power (dBm)		Total Power (mW)	Total Power (dBm)	Power Limit (dBm)	Pass / Fail
		Chain 0	Chain 1				
38	5190	17.10	17.59	108.698	20.36	28.49	Pass
46	5230	20.95	21.45	264.088	24.22	28.49	Pass
151	5755	20.72	21.67	264.925	24.23	28.49	Pass
159	5795	20.41	21.13	239.619	23.80	28.49	Pass

NOTE: Directional gain = 7.51 dBi > 6dBi, so the output power limit shall be reduced to  $30-(7.51-6) = 28.49$  dBm.

### 802.11ax (HE80)

Channel	Frequency (MHz)	Maximum Conducted Power (dBm)		Total Power (mW)	Total Power (dBm)	Power Limit (dBm)	Pass / Fail
		Chain 0	Chain 1				
42	5210	16.33	16.81	90.927	19.59	28.49	Pass
155	5775	20.26	21.00	232.062	23.66	28.49	Pass

NOTE: Directional gain = 7.51 dBi > 6dBi, so the output power limit shall be reduced to  $30-(7.51-6) = 28.49$  dBm.

**26 dB Bandwidth:**
**802.11a**

Channel	Frequency (MHz)	26 dBc Bandwidth (MHz)	
		Chain 0	Chain 1
36	5180	23.64	25.93
40	5200	27.16	29.11
48	5240	26.00	25.08

**802.11ax (HE20)**

Channel	Frequency (MHz)	26 dBc Bandwidth (MHz)	
		Chain 0	Chain 1
36	5180	22.81	23.81
40	5200	28.01	28.97
48	5240	26.31	25.27

**802.11ax (HE40)**

Channel	Frequency (MHz)	26 dBc Bandwidth (MHz)	
		Chain 0	Chain 1
38	5190	42.17	42.25
46	5230	46.61	43.89

**802.11ax (HE80)**

Channel	Frequency (MHz)	26 dBc Bandwidth (MHz)	
		Chain 0	Chain 1
42	5210	82.29	83.24



### Spectrum Plot of Worst Value

#### 802.11a

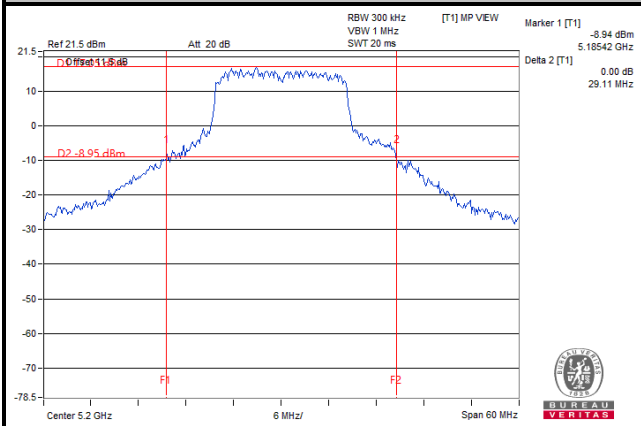

#### 802.11ax (HE20)

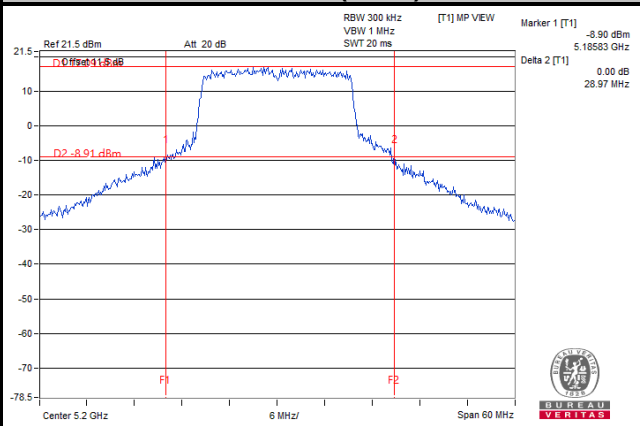

#### 802.11ax (HE40)

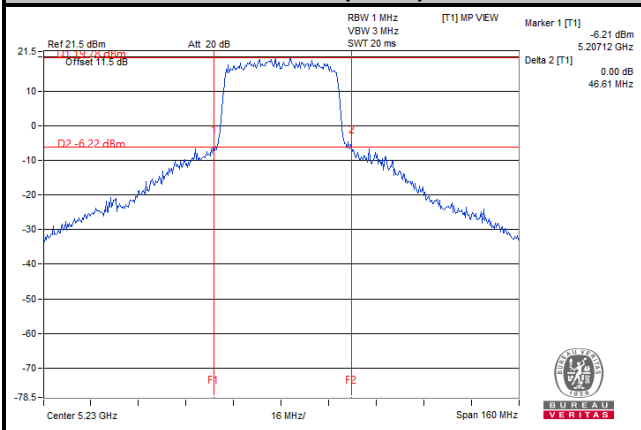

#### 802.11ax (HE80)

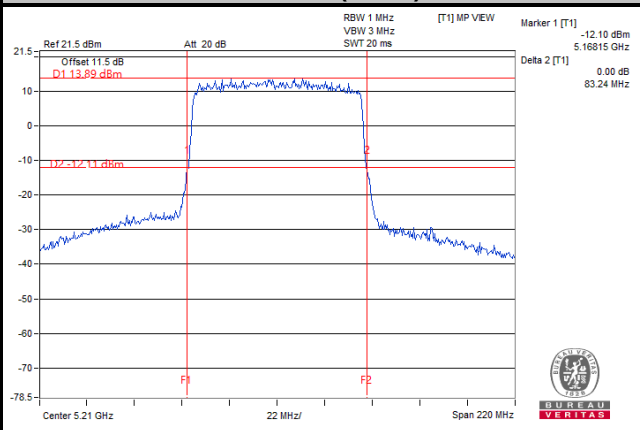

## 4.4 Occupied Bandwidth Measurement

### 4.4.1 Test Setup

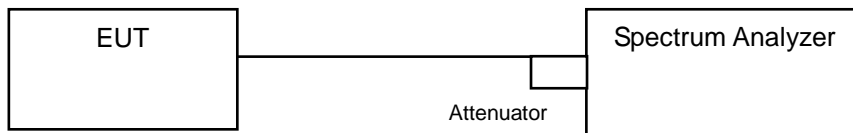

### 4.4.2 Test Instruments

Refer to section 4.1.2 to get information of above instrument.

### 4.4.3 Test Procedure

The transmitter output was connected to the spectrum analyzer through an attenuator. The bandwidth of the fundamental frequency was measured by spectrum analyzer with resolution bandwidth in the range of 1 % to 5 % of the anticipated emission bandwidth, and a video bandwidth at least 3x the resolution bandwidth and set the detector to SAMPLE. The width of a frequency band such that, below the lower and above the upper frequency limits, the mean powers emitted are each equal to a specified percentage 0.5 % of the total mean power of a given emission.

#### 4.4.4 Test Results

##### 802.11a

Channel	Channel Frequency (MHz)	Occupied Bandwidth (MHz)	
		Chain 0	Chain 1
36	5180	16.56	16.68
40	5200	16.80	16.92
48	5240	16.68	16.56
149	5745	16.56	16.56
157	5785	16.44	16.56
165	5825	16.44	16.56

##### 802.11ax (HE20)

Channel	Channel Frequency (MHz)	Occupied Bandwidth (MHz)	
		Chain 0	Chain 1
36	5180	18.96	19.08
40	5200	19.20	19.08
48	5240	18.96	19.08
149	5745	18.96	18.96
157	5785	18.96	18.96
165	5825	18.96	18.96

##### 802.11ax (HE40)

Channel	Channel Frequency (MHz)	Occupied Bandwidth (MHz)	
		Chain 0	Chain 1
38	5190	38.04	38.04
46	5230	38.16	38.16
151	5755	40.32	43.92
159	5795	39.00	38.88

##### 802.11ax (HE80)

Channel	Channel Frequency (MHz)	Occupied Bandwidth (MHz)	
		Chain 0	Chain 1
42	5210	77.28	77.52
155	5775	80.64	81.12

### Spectrum Plot of Worst Value

#### 802.11a

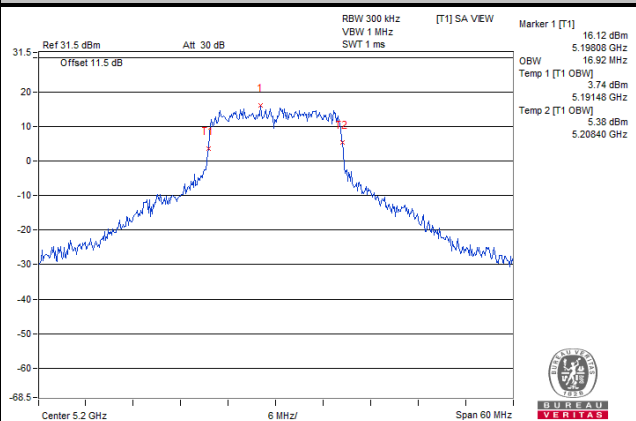

#### 802.11ax (HE20)

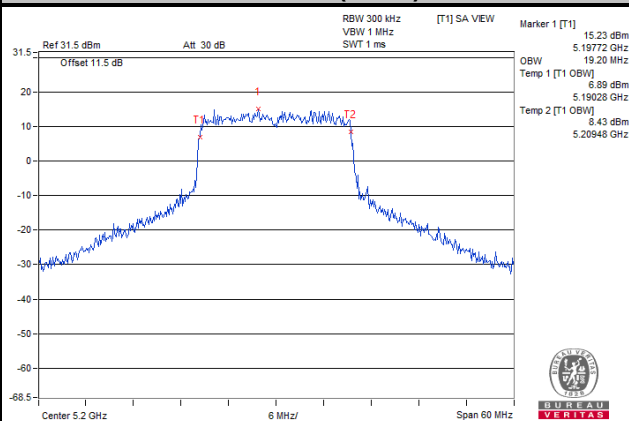

#### 802.11ax (HE40)

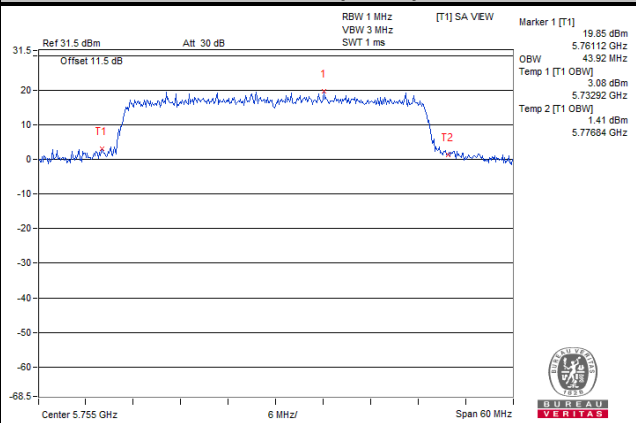

#### 802.11ax (HE80)

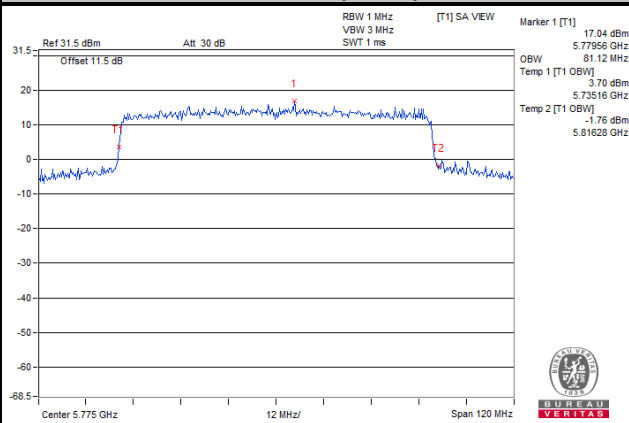

Chain 0

Spectrum Plot for Nearby DFS Band

802.11a

Ch 48 (5240 MHz)

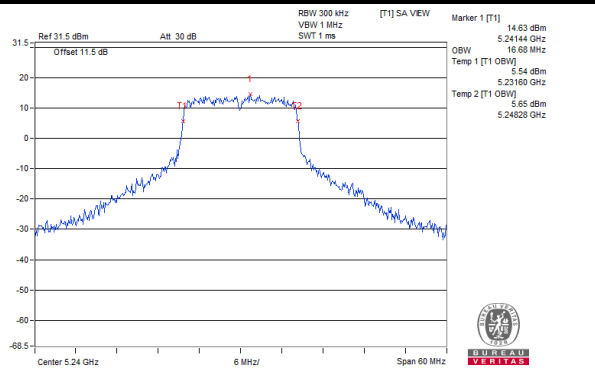

Ch 149 (5745 MHz)

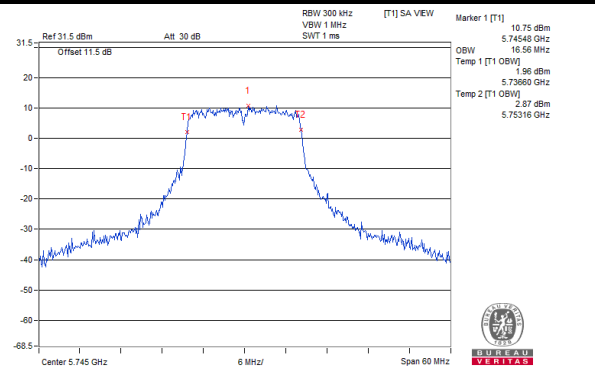

802.11ax (HE20)

Ch 48 (5240 MHz)

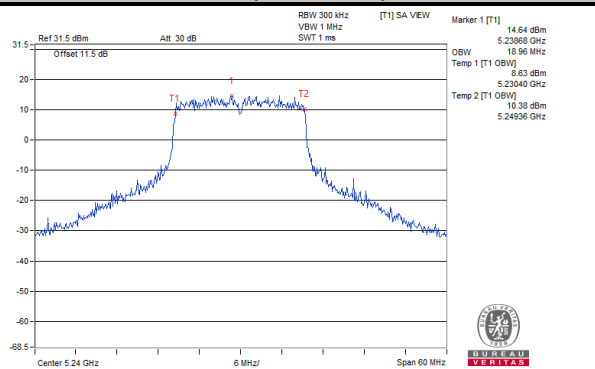

Ch 149 (5745 MHz)

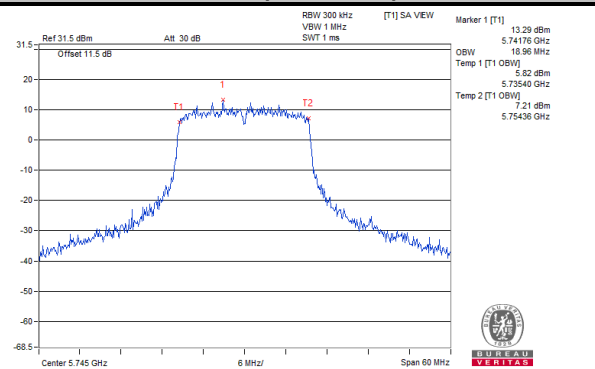

802.11ax (HE40)

Ch 46 (5230 MHz)

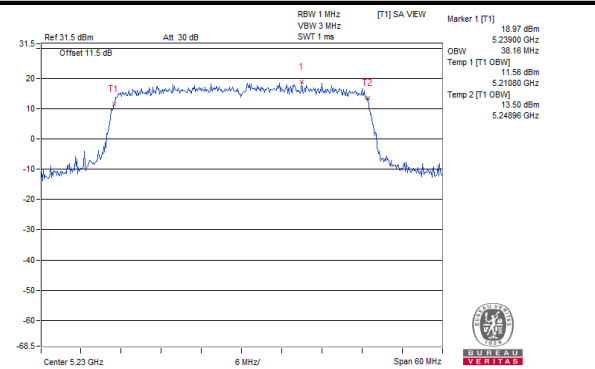

Ch 151 (5755 MHz)

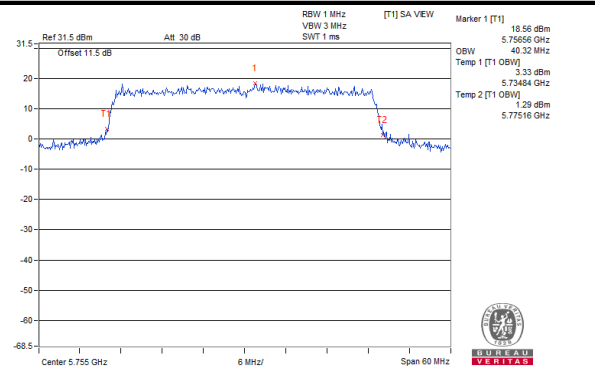

802.11ax (HE80)

Ch 42 (5210 MHz)

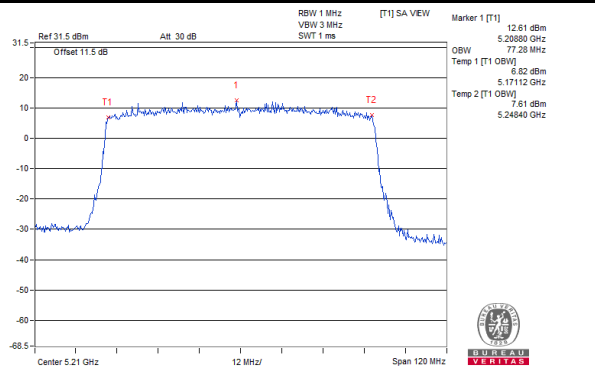

Ch 155 (5775 MHz)

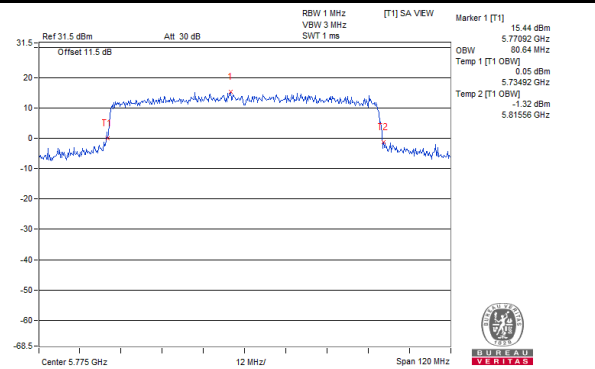

Chain 1

Spectrum Plot for Nearby DFS Band

802.11a

Ch 48 (5240 MHz)

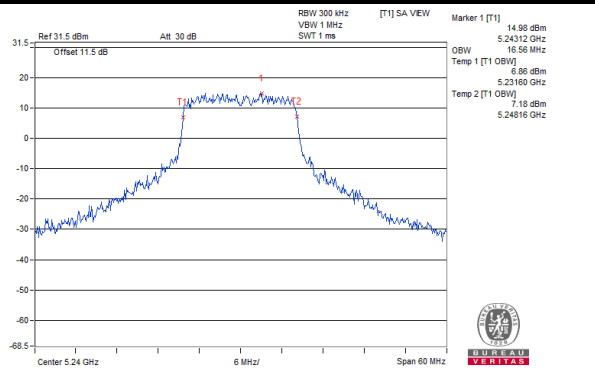

Ch 149 (5745 MHz)

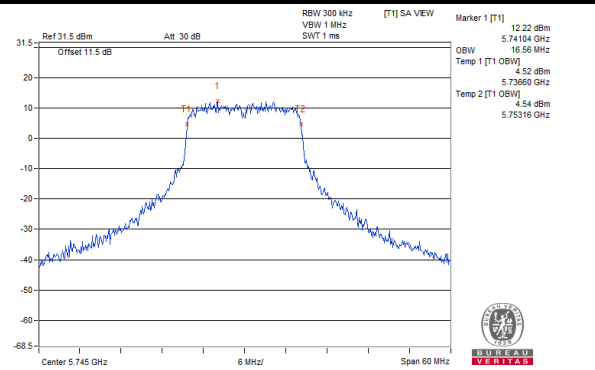

802.11ax (HE20)

Ch 48 (5240 MHz)

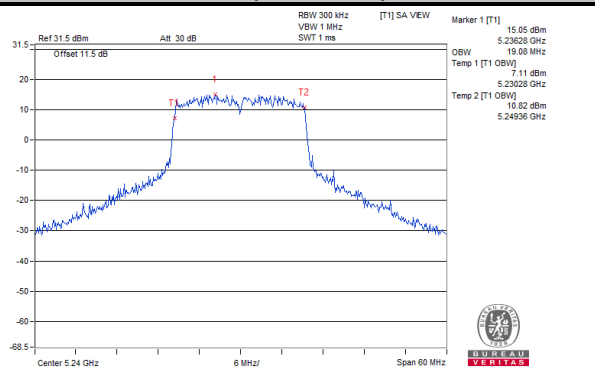

Ch 149 (5745 MHz)

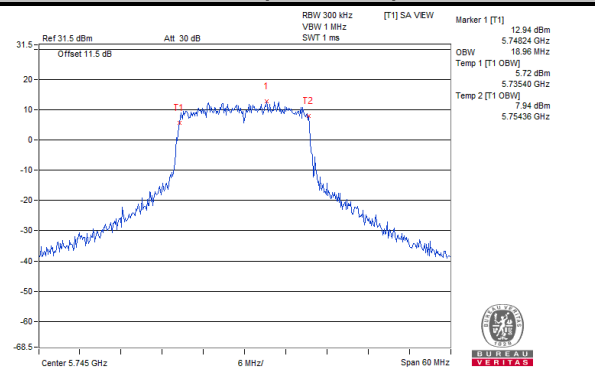

802.11ax (HE40)

Ch 46 (5230 MHz)

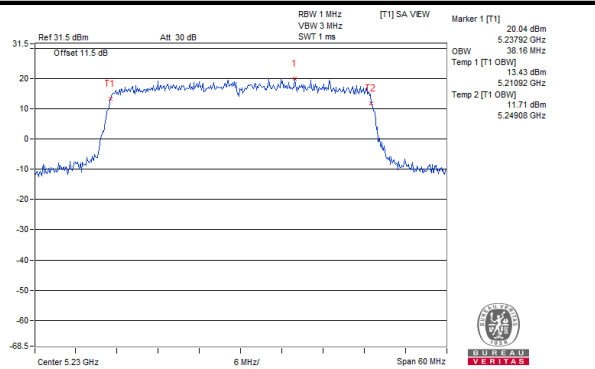

Ch 151 (5755 MHz)

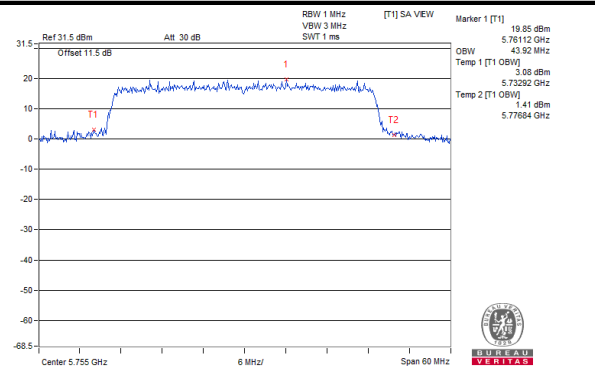

802.11ax (HE80)

Ch 42 (5210 MHz)

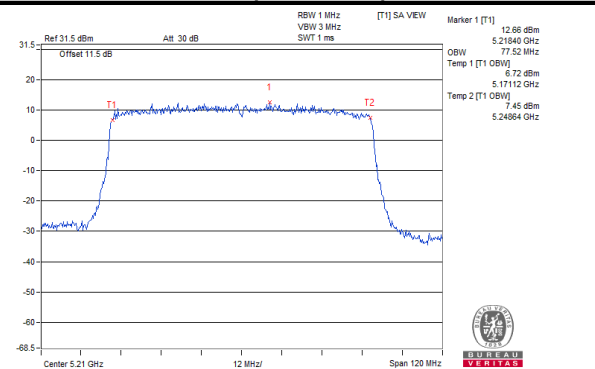

Ch 155 (5775 MHz)

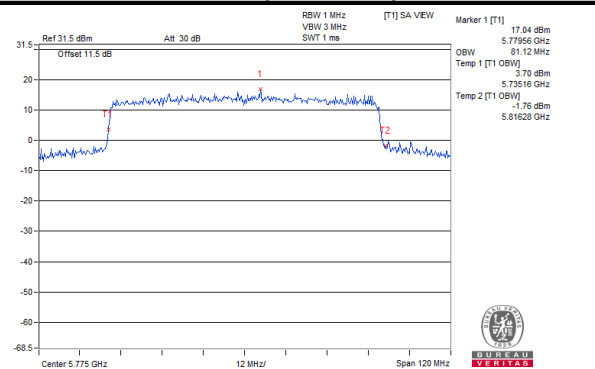

## 4.5 Peak Power Spectral Density Measurement

### 4.5.1 Limits of Peak Power Spectral Density Measurement

Operation Band	EUT Category		Limit
U-NII-1		Outdoor Access Point	17 dBm/MHz
		Fixed point-to-point Access Point	
	√	Indoor Access Point	
		Mobile and Portable client device	11 dBm/MHz
U-NII-2A			11 dBm/MHz
U-NII-2C			11 dBm/MHz
U-NII-3		√	30 dBm/500 kHz

### 4.5.2 Test Setup

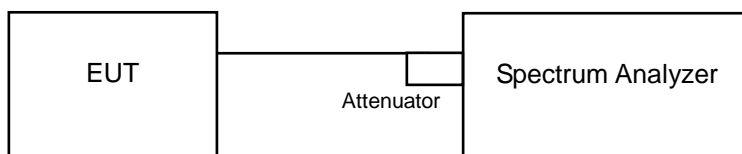

### 4.5.3 Test Instruments

Refer to section 4.1.2 to get information of above instrument.

### 4.5.4 Test Procedures

#### For U-NII-1 band:

Using method SA-2 Duty cycle <98%

1. Set span to encompass the entire emission bandwidth (EBW) of the signal.
2. Set RBW = 1 MHz, Set VBW ≥ 3 RBW, Detector = RMS
3. Sweep time = auto, trigger set to "free run".
4. Trace average at least 100 traces in power averaging mode.
5. Record the max value and add 10 log (1/duty cycle)

#### ※ For U-NII-3: with duty cycle & Duty cycle <98 %

1. Set span to encompass the entire emission bandwidth (EBW) of the signal.
2. Set RBW = 300 kHz, Set VBW ≥ 1 RBW, Detector = RMS
3. Use the peak marker function to determine the maximum power level in any 300 kHz band segment within the fundamental EBW.
4. Scale the observed power level to an equivalent value in 500 kHz by adjusting (increasing) the measured power by a bandwidth correction factor (BWCF) where  $BWCF = 10\log(500 \text{ kHz} / 300 \text{ kHz})$ .
5. Sweep time = auto, trigger set to "free run".
6. Trace average at least 100 traces in power averaging mode.
7. Record the max value and add 10 log (1/duty cycle)

#### 4.5.5 Deviation from Test Standard

No deviation.

#### 4.5.6 EUT Operating Conditions

The software provided by client to enable the EUT under transmission condition continuously at lowest, middle and highest channel frequencies individually.



#### 4.5.7 Test Results

##### For U-NII-1 Band

##### 802.11a

Channel	Frequency (MHz)	PSD (dBm/MHz)		Duty Factor (dB)	Total PSD with Duty Factor (dBm/MHz)	Max. Limit (dBm/MHz)	Pass / Fail
		Chain 0	Chain 1				
36	5180	9.78	10.54	0.27	13.46	15.49	Pass
40	5200	10.41	11.12	0.27	14.06	15.49	Pass
48	5240	10.28	10.74	0.27	13.79	15.49	Pass

##### Note:

- Method E) 2) a) of power density measurement of KDB 662911 is using for calculating total power density. Total power density is summing entire spectra across corresponding frequency bins on the various outputs by computer.
- For U-NII-1 Band:**  
 Directional gain =  $4.5 \text{ dBi} + 10\log(2) = 7.51 \text{ dBi} > 6 \text{ dBi}$  , so the power density limit shall be reduced to  $17 - (7.51 - 6) = 15.49 \text{ dBm}$ .
- Refer to section 3.3 for duty cycle spectrum plot.

##### 802.11ax (HE20)

Channel	Frequency (MHz)	PSD (dBm/MHz)		Duty Factor (dB)	Total PSD with Duty Factor (dBm/MHz)	Max. Limit (dBm/MHz)	Pass / Fail
		Chain 0	Chain 1				
36	5180	8.59	9.62	0.25	12.40	15.49	Pass
40	5200	9.30	10.32	0.25	13.11	15.49	Pass
48	5240	9.20	9.69	0.25	12.72	15.49	Pass

##### Note:

- Method E) 2) a) of power density measurement of KDB 662911 is using for calculating total power density. Total power density is summing entire spectra across corresponding frequency bins on the various outputs by computer.
- For U-NII-1 Band:**  
 Directional gain =  $4.5 \text{ dBi} + 10\log(2) = 7.51 \text{ dBi} > 6 \text{ dBi}$  , so the power density limit shall be reduced to  $17 - (7.51 - 6) = 15.49 \text{ dBm}$ .
- Refer to section 3.3 for duty cycle spectrum plot.

### 802.11ax (HE40)

Channel	Frequency (MHz)	PSD (dBm/MHz)		Duty Factor (dB)	Total PSD with Duty Factor (dBm/MHz)	Max. Limit (dBm/MHz)	Pass / Fail
		Chain 0	Chain 1				
38	5190	3.30	4.46	0.32	7.25	15.49	Pass
46	5230	6.20	7.27	0.32	10.09	15.49	Pass

**Note:**

- Method E) 2) a) of power density measurement of KDB 662911 is using for calculating total power density. Total power density is summing entire spectra across corresponding frequency bins on the various outputs by computer.
- For U-NII-1 Band:**  
 Directional gain = 4.5 dBi + 10log(2) = 7.51 dBi > 6 dBi , so the power density limit shall be reduced to 17-(7.51-6) = 15.49 dBm.
- Refer to section 3.3 for duty cycle spectrum plot.

### 802.11ax (HE80)

Channel	Frequency (MHz)	PSD (dBm/MHz)		Duty Factor (dB)	Total PSD with Duty Factor (dBm/MHz)	Max. Limit (dBm/MHz)	Pass / Fail
		Chain 0	Chain 1				
42	5210	-0.60	0.26	0.43	3.29	15.49	Pass

**Note:**

- Method E) 2) a) of power density measurement of KDB 662911 is using for calculating total power density. Total power density is summing entire spectra across corresponding frequency bins on the various outputs by computer.
- For U-NII-1 Band:**  
 Directional gain = 4.5 dBi + 10log(2) = 7.51 dBi > 6 dBi , so the power density limit shall be reduced to 17-(7.51-6) = 15.49 dBm.
- Refer to section 3.3 for duty cycle spectrum plot.

### Spectrum Plot of Worst Value

#### 802.11a

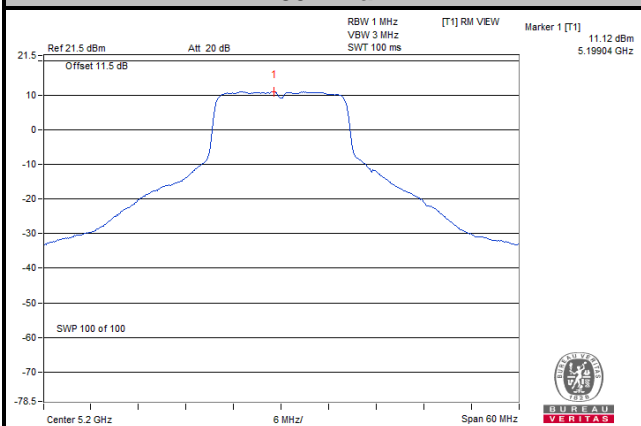

#### 802.11ax (HE20)

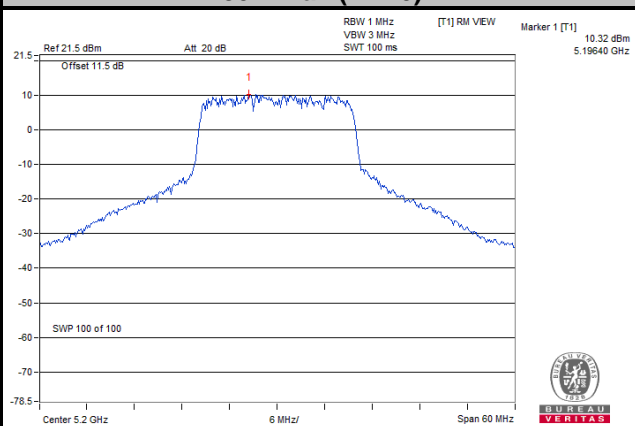

#### 802.11ax (HE40)

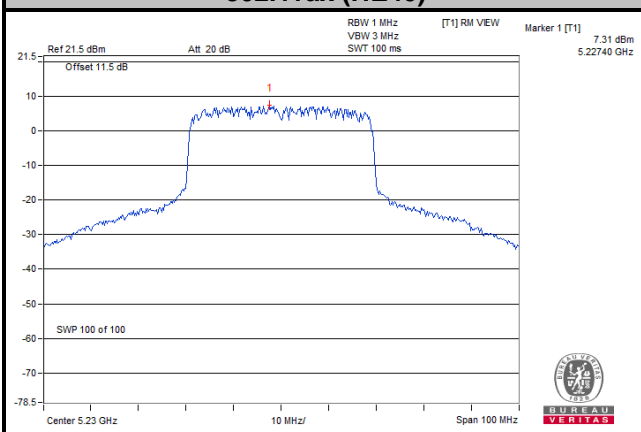

#### 802.11ax (HE80)

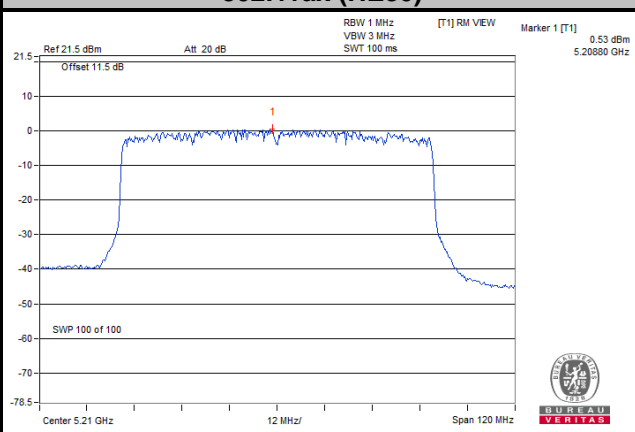

## For U-NII-3 Band

### 802.11a

TX Chain	Channel	Frequency (MHz)	PSD w/o Duty Factor		10 log (N=2) dB	Duty Factor (dB)	Total PSD with Duty Factor (dBm/500 kHz)	Limit (dBm/500 kHz)	Pass / Fail
			(dBm/300 kHz)	(dBm/500 kHz)					
0	149	5745	-1.42	0.8	3.01	0.27	4.08	28.49	Pass
	157	5785	-2.19	0.03	3.01	0.27	3.31	28.49	Pass
	165	5825	-4.32	-2.1	3.01	0.27	1.18	28.49	Pass
1	149	5745	-0.49	1.73	3.01	0.27	5.01	28.49	Pass
	157	5785	-1.49	0.73	3.01	0.27	4.01	28.49	Pass
	165	5825	-3.7	-1.48	3.01	0.27	1.8	28.49	Pass

#### Note:

- Method E) 2) c) of power density measurement of KDB 662911 is using for calculating total power density.
- Directional gain =  $4.5 \text{ dBi} + 10\log(2) = 7.51 \text{ dBi} > 6 \text{ dBi}$  , so the power density limit shall be reduced to  $30 - (7.51 - 6) = 28.49 \text{ dBm}$ .
- Refer to section 3.3 for duty cycle spectrum plot.

### 802.11ax (HE20)

TX Chain	Channel	Frequency (MHz)	PSD		10 log (N=2) dB	Duty Factor (dB)	Total PSD with Duty Factor (dBm/500 kHz)	Limit (dBm/500 kHz)	Pass / Fail
			(dBm/300 kHz)	(dBm/500 kHz)					
0	149	5745	-3.01	-0.79	3.01	0.25	2.47	28.49	Pass
	157	5785	-3.45	-1.23	3.01	0.25	2.03	28.49	Pass
	165	5825	-5.33	-3.11	3.01	0.25	0.15	28.49	Pass
1	149	5745	-1.92	0.3	3.01	0.25	3.56	28.49	Pass
	157	5785	-2.62	-0.4	3.01	0.25	2.86	28.49	Pass
	165	5825	-4.78	-2.56	3.01	0.25	0.7	28.49	Pass

#### Note:

- Method E) 2) c) of power density measurement of KDB 662911 is using for calculating total power density.
- Directional gain =  $4.5 \text{ dBi} + 10\log(2) = 7.51 \text{ dBi} > 6 \text{ dBi}$  , so the power density limit shall be reduced to  $30 - (7.51 - 6) = 28.49 \text{ dBm}$ .
- Refer to section 3.3 for duty cycle spectrum plot.

### 802.11ax (HE40)

TX Chain	Channel	Frequency (MHz)	PSD		10 log (N=2) dB	Duty Factor (dB)	Total PSD with Duty Factor (dBm/500 kHz)	Limit (dBm/500 kHz)	Pass / Fail
			(dBm/300 kHz)	(dBm/500 kHz)					
0	151	5755	-3.23	-1.01	3.01	0.32	2.32	28.49	Pass
	159	5795	-3.84	-1.62	3.01	0.32	1.71	28.49	Pass
1	151	5755	-2.22	0	3.01	0.32	3.33	28.49	Pass
	159	5795	-3.29	-1.07	3.01	0.32	2.26	28.49	Pass

**Note:**

1. Method E) 2) c) of power density measurement of KDB 662911 is using for calculating total power density.
2. Directional gain = 4.5 dBi + 10log(2) = 7.51 dBi > 6 dBi , so the power density limit shall be reduced to  $30-(7.51-6) = 28.49$  dBm.
3. Refer to section 3.3 for duty cycle spectrum plot.

### 802.11ax (HE80)

TX Chain	Channel	Frequency (MHz)	PSD		10 log (N=2) dB	Duty Factor (dB)	Total PSD with Duty Factor (dBm/500 kHz)	Limit (dBm/500 kHz)	Pass / Fail
			(dBm/300 kHz)	(dBm/500 kHz)					
0	155	5775	-6.22	-4	3.01	0.43	-0.56	28.49	Pass
1	155	5775	-5.42	-3.2	3.01	0.43	0.24	28.49	Pass

**Note:**

1. Method E) 2) c) of power density measurement of KDB 662911 is using for calculating total power density.
2. Directional gain = 4.5 dBi + 10log(2) = 7.51 dBi > 6 dBi , so the power density limit shall be reduced to  $30-(7.51-6) = 28.49$  dBm.
3. Refer to section 3.3 for duty cycle spectrum plot.

### Spectrum Plot of Worst Value

#### 802.11a

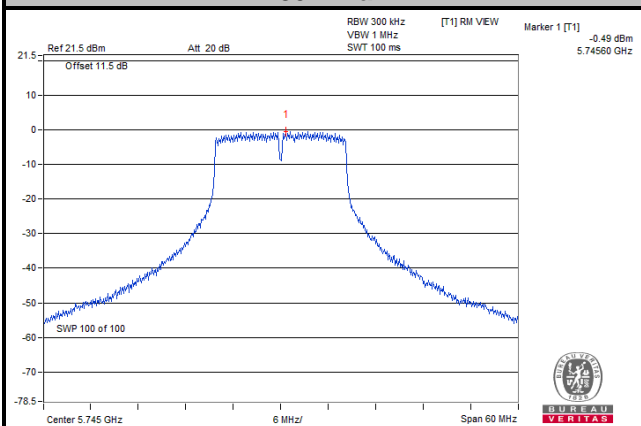

#### 802.11ax (HE20)

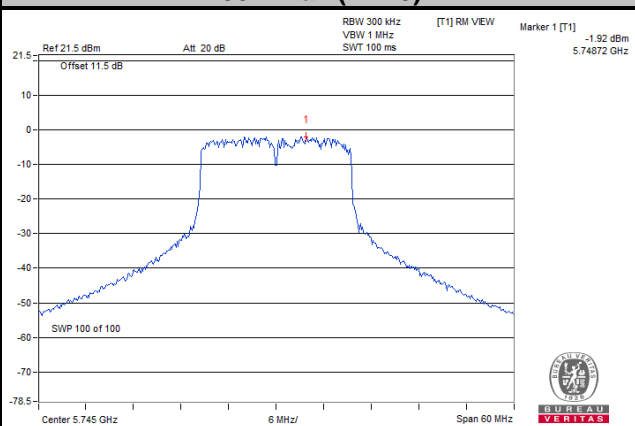

#### 802.11ax (HE40)

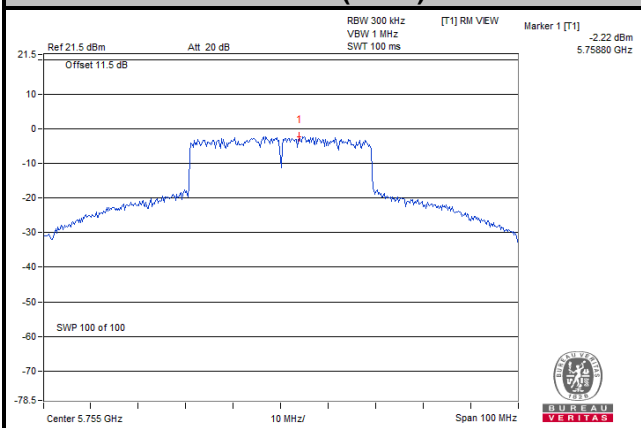

#### 802.11ax (HE80)

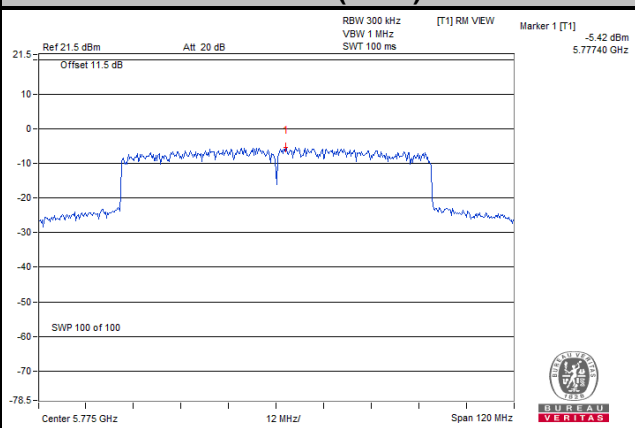

## 4.6 Frequency Stability

### 4.6.1 Limit of Frequency Stability Measurement

The frequency of the carrier signal shall be maintained within band of operation.

### 4.6.2 Test Setup

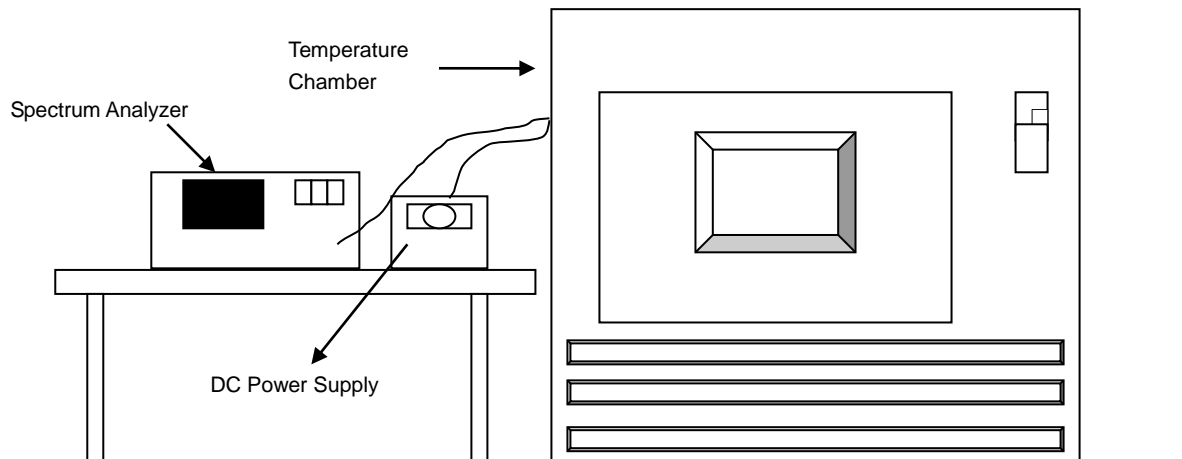

### 4.6.3 Test Instruments

Refer to section 4.1.2 to get information of above instrument.

### 4.6.4 Test Procedure

- The EUT was placed inside the environmental test chamber and powered by nominal DC voltage.
- Turn the EUT on and couple its output to a spectrum analyzer.
- Turn the EUT off and set the chamber to the highest temperature specified.
- Allow sufficient time (approximately 30 min) for the temperature of the chamber to stabilize, turn the EUT on and measure the operating frequency after 2, 5, and 10 Minutes.
- Repeat step (d) with the temperature chamber set to the next desired temperature until measurements down to the lowest specified temperature have been completed.
- The test chamber was allowed to stabilize at +20 degree C for a minimum of 30 Minutes. The supply voltage was then adjusted on the EUT from 85% to 115% and the frequency record.

### 4.6.5 Deviation from Test Standard

No deviation.

### 4.6.6 EUT Operating Condition

Set the EUT transmit at un-modulation mode to test frequency stability.

#### 4.6.7 Test Results

Frequency Stability Versus Temp.									
Operating Frequency: 5180 MHz									
Temp. (°C)	Power Supply (Vdc)	0 Minute		2 Minute		5 Minute		10 Minute	
		Measured Frequency (MHz)	Result	Measured Frequency (MHz)	Result	Measured Frequency (MHz)	Result	Measured Frequency (MHz)	Result
40	12	5179.9897	PASS	5179.9927	PASS	5179.9906	PASS	5179.9908	PASS
30	12	5180.0037	PASS	5180.004	PASS	5180.003	PASS	5180.006	PASS
20	12	5179.9981	PASS	5179.9983	PASS	5179.9938	PASS	5179.9945	PASS
10	12	5180.0024	PASS	5179.999	PASS	5180.002	PASS	5180.001	PASS
0	12	5179.9815	PASS	5179.9795	PASS	5179.9796	PASS	5179.98	PASS

Frequency Stability Versus Voltage									
Operating Frequency: 5180 MHz									
Temp. (°C)	Power Supply (Vdc)	0 Minute		2 Minute		5 Minute		10 Minute	
		Measured Frequency (MHz)	Result	Measured Frequency (MHz)	Result	Measured Frequency (MHz)	Result	Measured Frequency (MHz)	Result
20	13.8	5179.9982	PASS	5179.9993	PASS	5179.9941	PASS	5179.9946	PASS
	12	5179.9981	PASS	5179.9983	PASS	5179.9938	PASS	5179.9945	PASS
	10.2	5179.9971	PASS	5179.9984	PASS	5179.9932	PASS	5179.9953	PASS



## 4.7 6 dB Bandwidth Measurement

### 4.7.1 Limits of 6 dB Bandwidth Measurement

The minimum of 6 dB Bandwidth Measurement is 0.5 MHz.

### 4.7.2 Test Setup

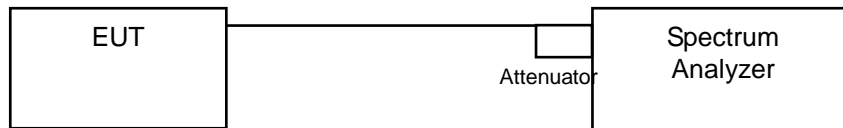

### 4.7.3 Test Instruments

Refer to section 4.1.2 to get information of above instrument.

### 4.7.4 Test Procedure

#### MEASUREMENT PROCEDURE REF

- Set resolution bandwidth (RBW) = 100 kHz
- Set the video bandwidth (VBW)  $\geq 3 \times$  RBW, Detector = Peak.
- Trace mode = max hold.
- Sweep = auto couple.
- Measure the maximum width of the emission that is constrained by the frequencies associated with the two amplitude points (upper and lower) that are attenuated by 6 dB relative to the maximum level measured in the fundamental emission

### 4.7.5 Deviation from Test Standard

No deviation.

### 4.7.6 EUT Operating Condition

The software provided by client to enable the EUT under transmission condition continuously at lowest, middle and highest channel frequencies individually.

#### 4.7.7 Test Results

##### 802.11a

Channel	Frequency (MHz)	6 dB Bandwidth (MHz)		Minimum Limit (MHz)	Pass / Fail
		Chain 0	Chain 1		
149	5745	15.72	15.36	0.5	Pass
157	5785	15.71	15.43	0.5	Pass
165	5825	15.82	15.34	0.5	Pass

##### 802.11ax (HE20)

Channel	Frequency (MHz)	6 dB Bandwidth (MHz)		Minimum Limit (MHz)	Pass / Fail
		Chain 0	Chain 1		
149	5745	18.38	18.10	0.5	Pass
157	5785	18.45	18.13	0.5	Pass
165	5825	18.43	18.37	0.5	Pass

##### 802.11ax (HE40)

Channel	Frequency (MHz)	6 dB Bandwidth (MHz)		Minimum Limit (MHz)	Pass / Fail
		Chain 0	Chain 1		
151	5755	38.06	38.07	0.5	Pass
159	5795	38.13	38.14	0.5	Pass

##### 802.11ax (HE80)

Channel	Frequency (MHz)	6 dB Bandwidth (MHz)		Minimum Limit (MHz)	Pass / Fail
		Chain 0	Chain 1		
155	5775	71.65	72.81	0.5	Pass

### Spectrum Plot of Worst Value

#### 802.11a

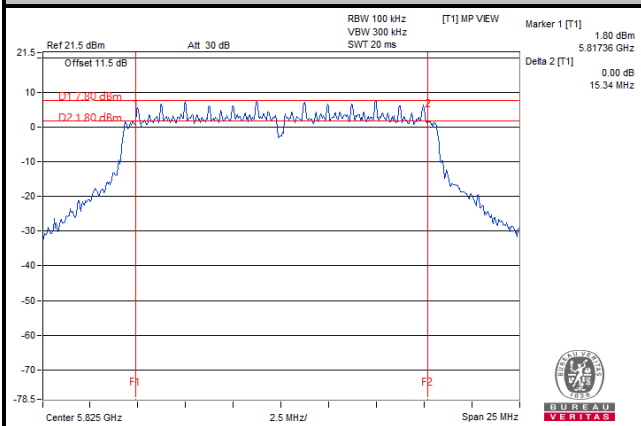

#### 802.11ax (HE20)

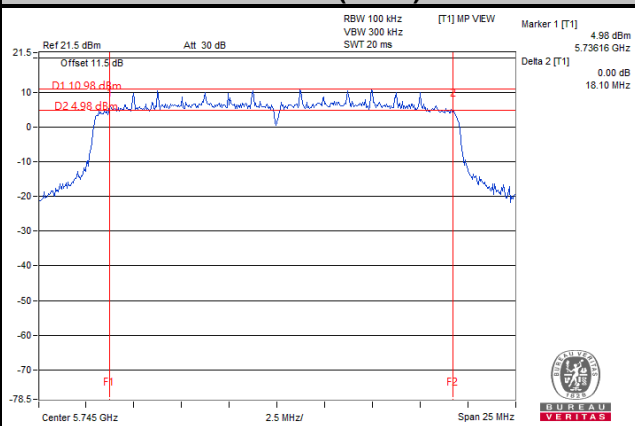

#### 802.11ax (HE40)

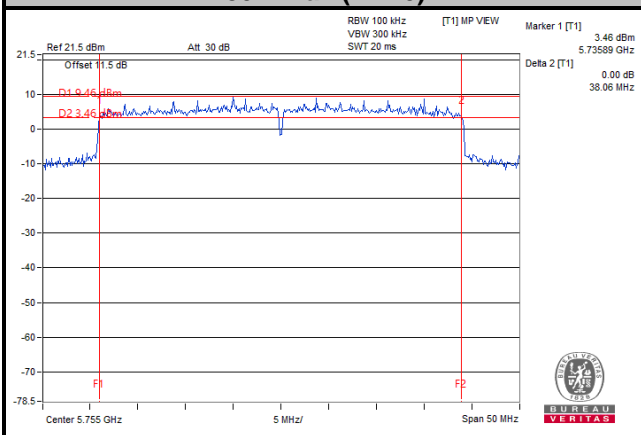

#### 802.11ax (HE80)

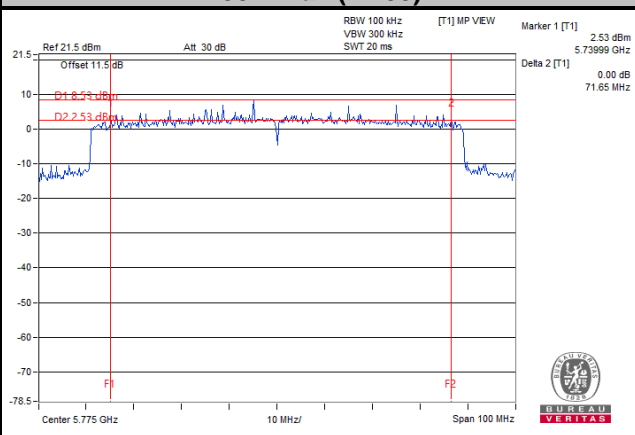

## 5 Pictures of Test Arrangements

Please refer to the attached file (Test Setup Photo).

## Annex A- Radiated Out of Band Emission (OOBE) Measurement (For U-NII-3 band)

802.11a

**CH 149 5745 MHz**

**Horizontal**

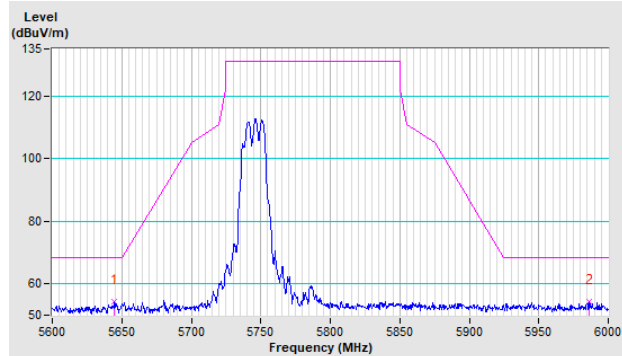

**Vertical**

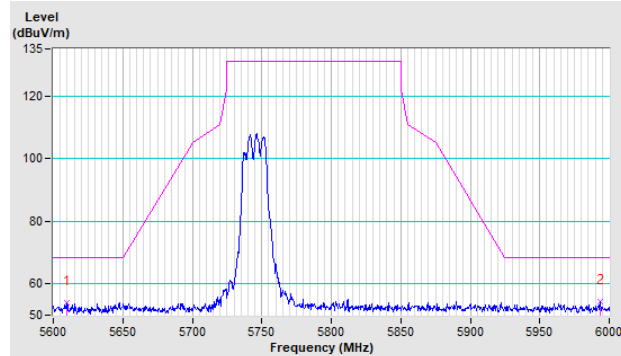

**CH 157 5785 MHz**

**Horizontal**

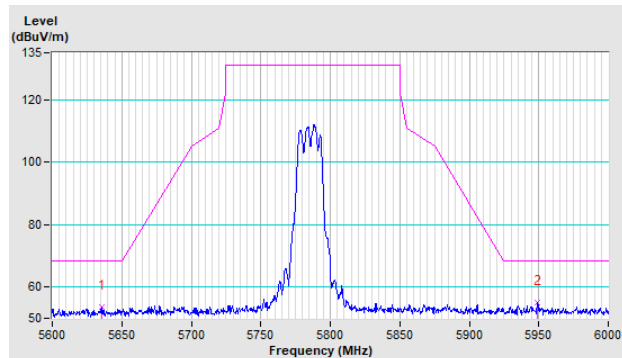

**Vertical**

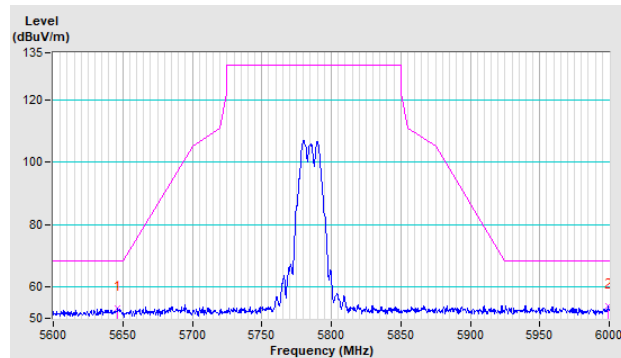

**CH 165 5825 MHz**

**Horizontal**

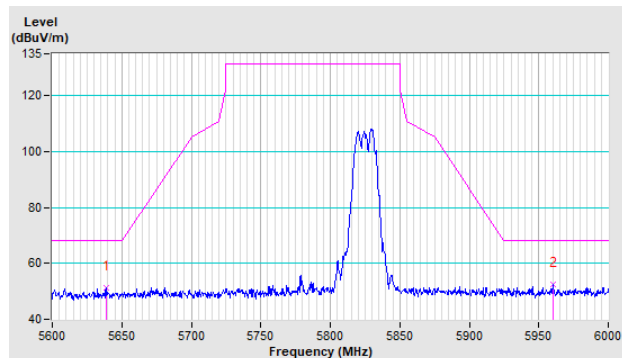

**Vertical**

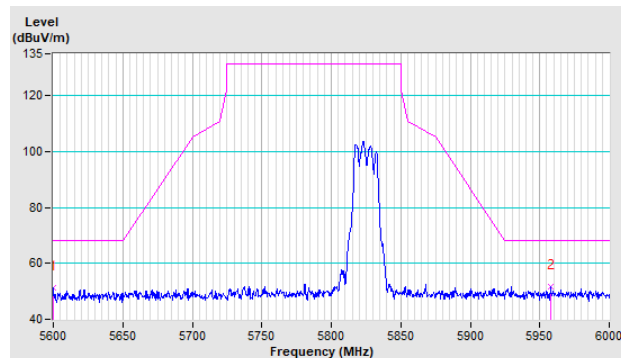

### 802.11ax (HE20)

#### CH 149 5745 MHz

**Horizontal**

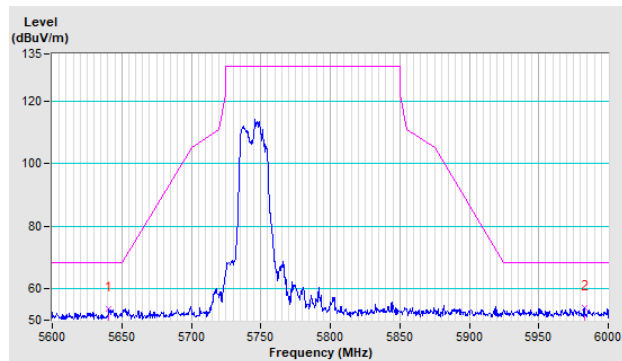

**Vertical**

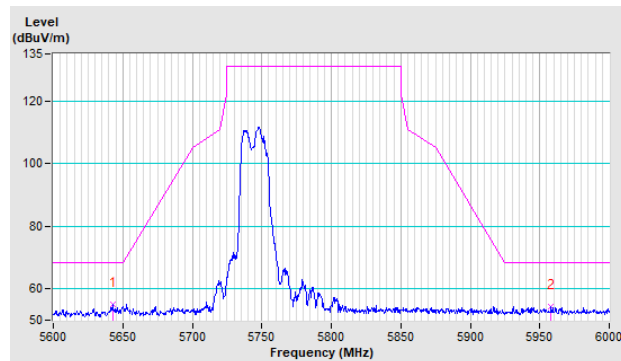

#### CH 157 5785 MHz

**Horizontal**

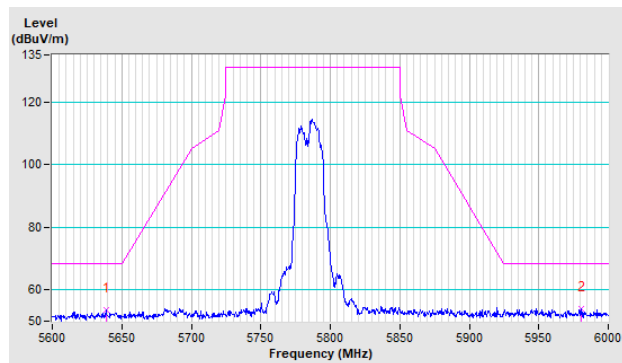

**Vertical**

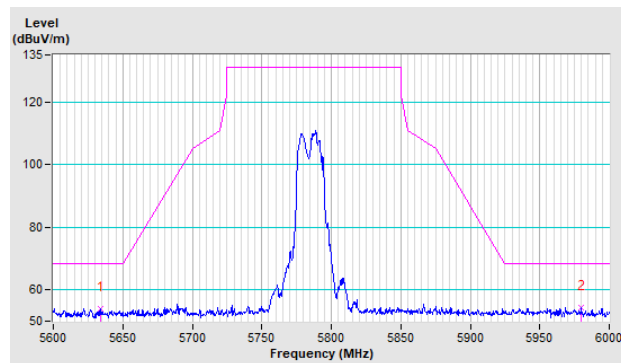

#### CH 165 5825 MHz

**Horizontal**

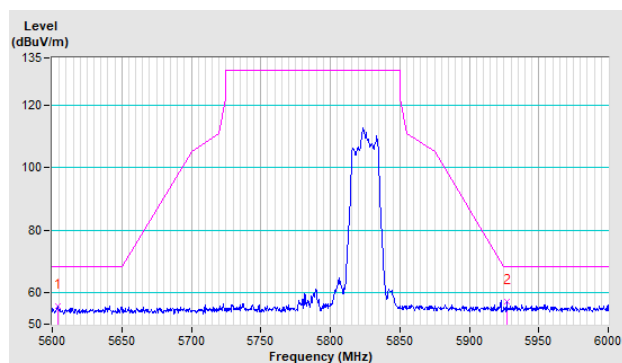

**Vertical**

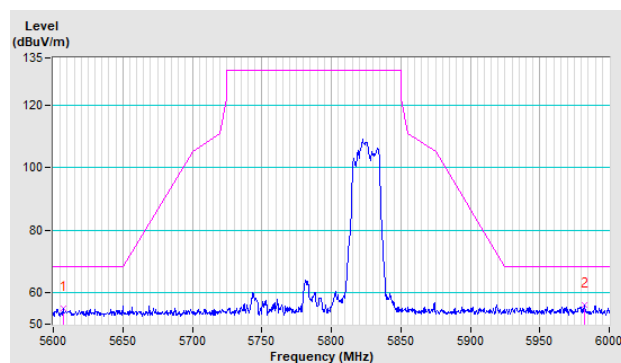

### 802.11ax (HE40)

#### CH 151 5755 MHz

##### Horizontal

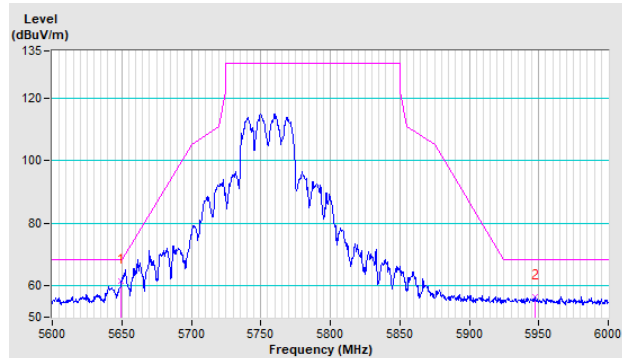

##### Vertical

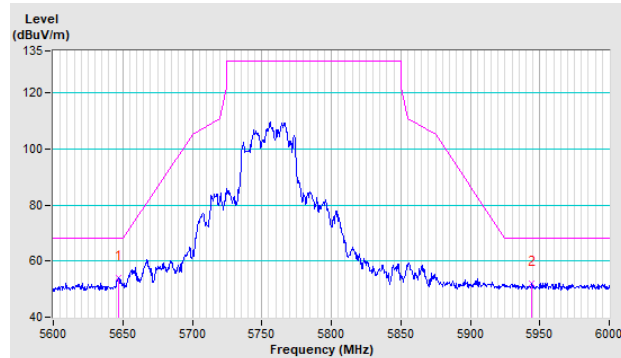

#### CH 159 5795 MHz

##### Horizontal

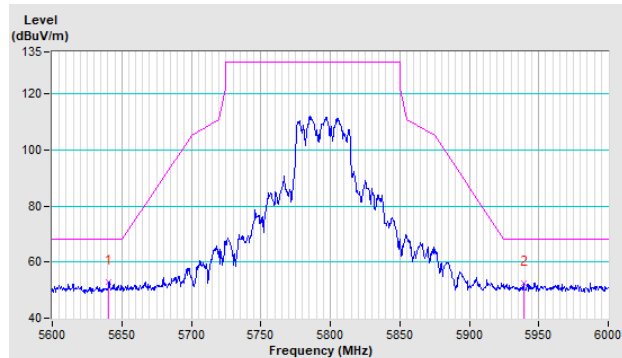

##### Vertical

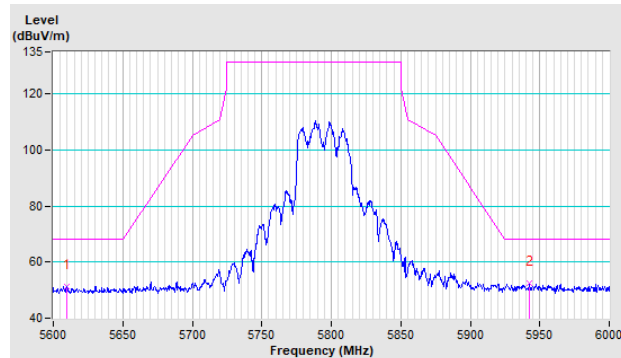

802.11ax (HE80)

CH 155 5775 MHz

Horizontal

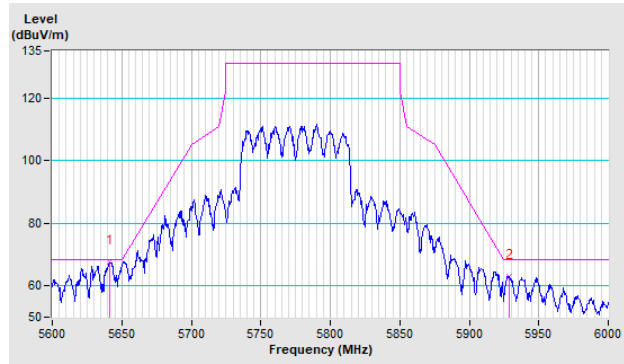

Vertical

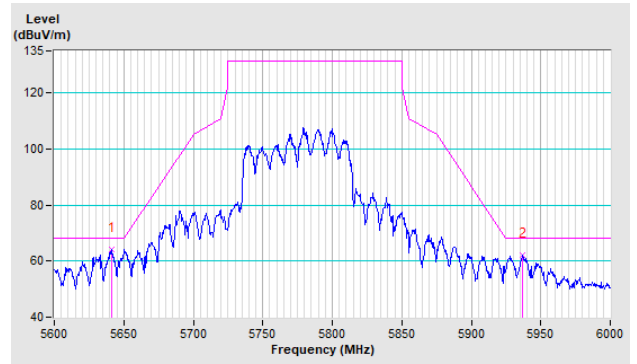



## Annex B- Band-edge measurement

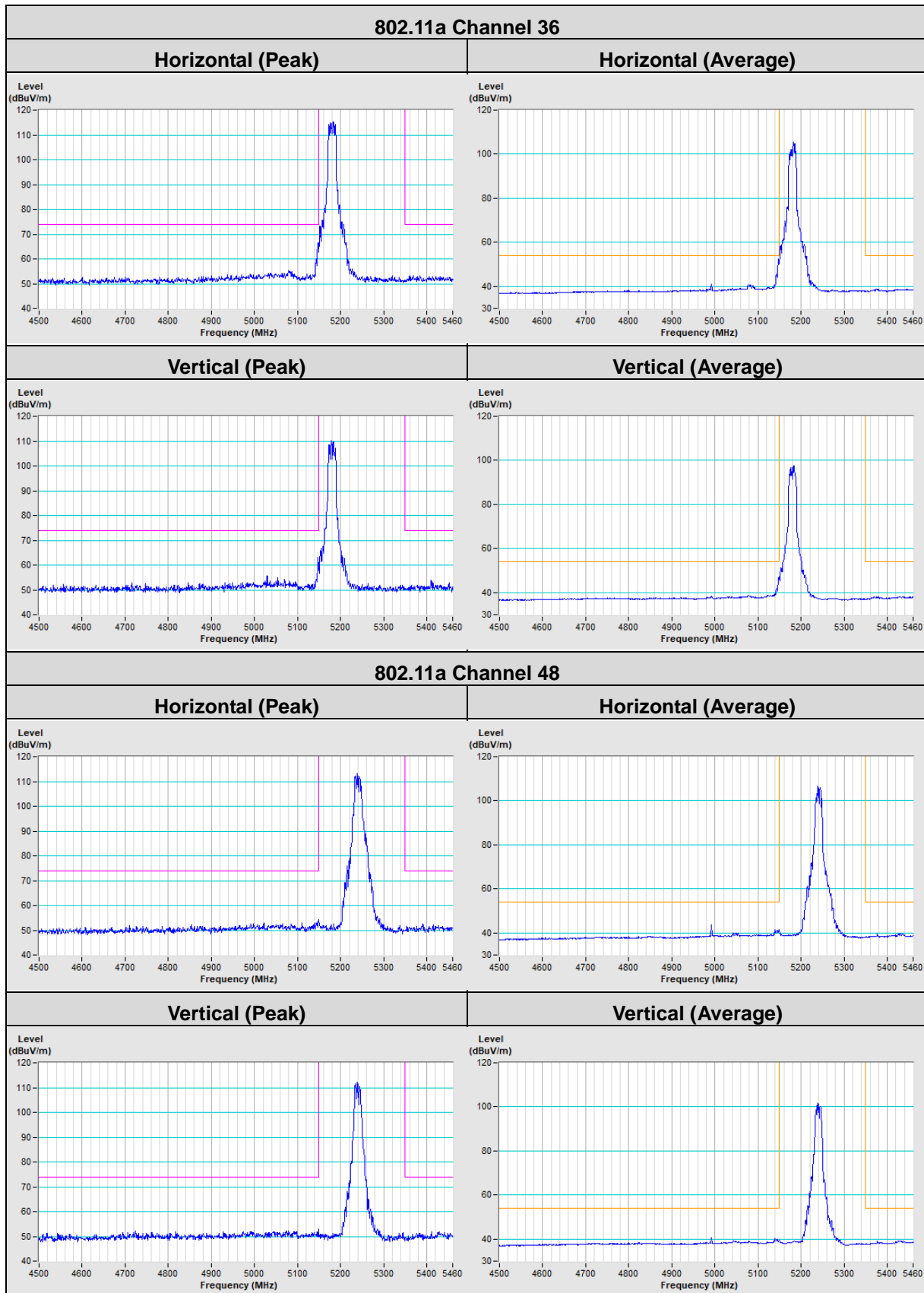

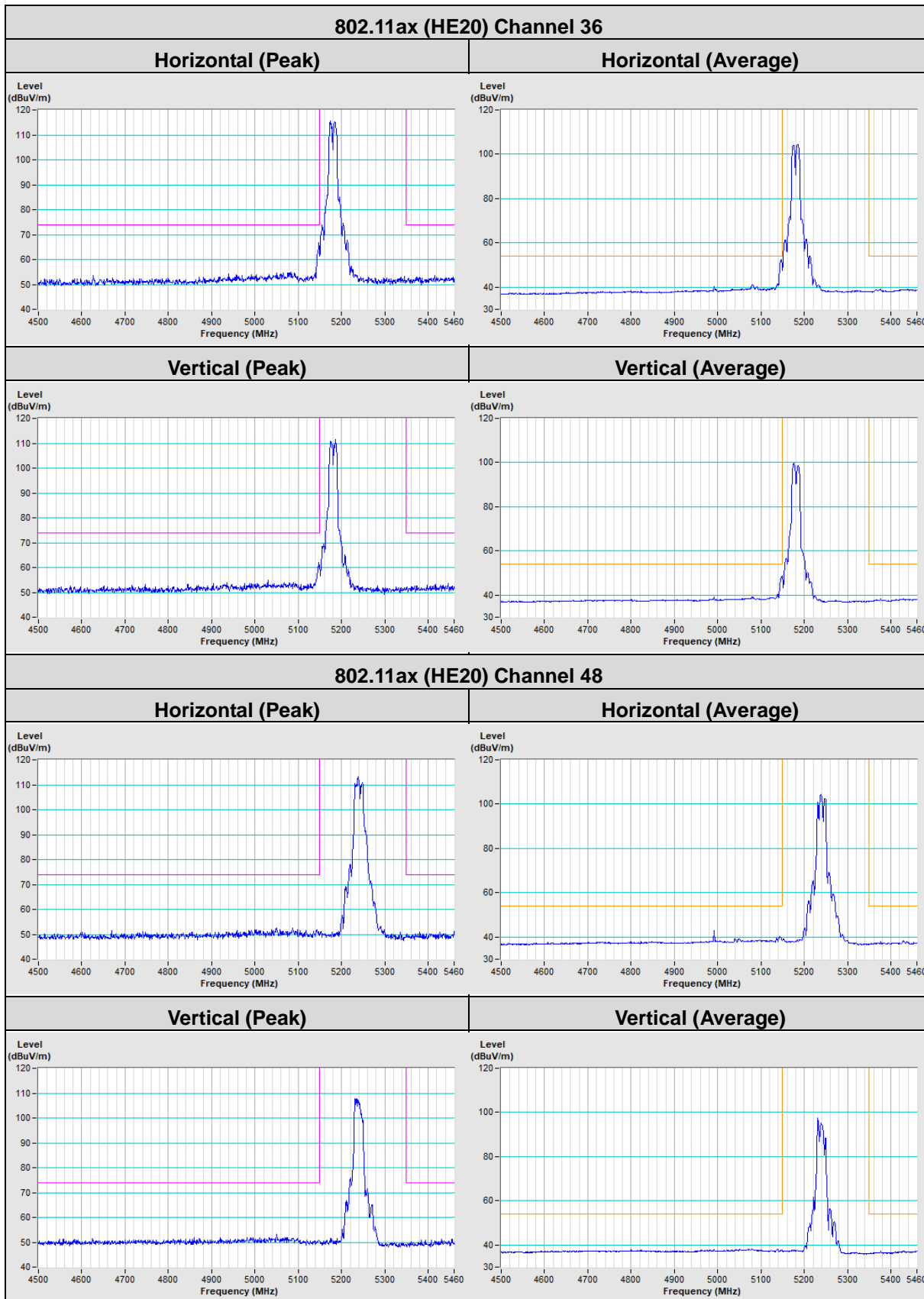

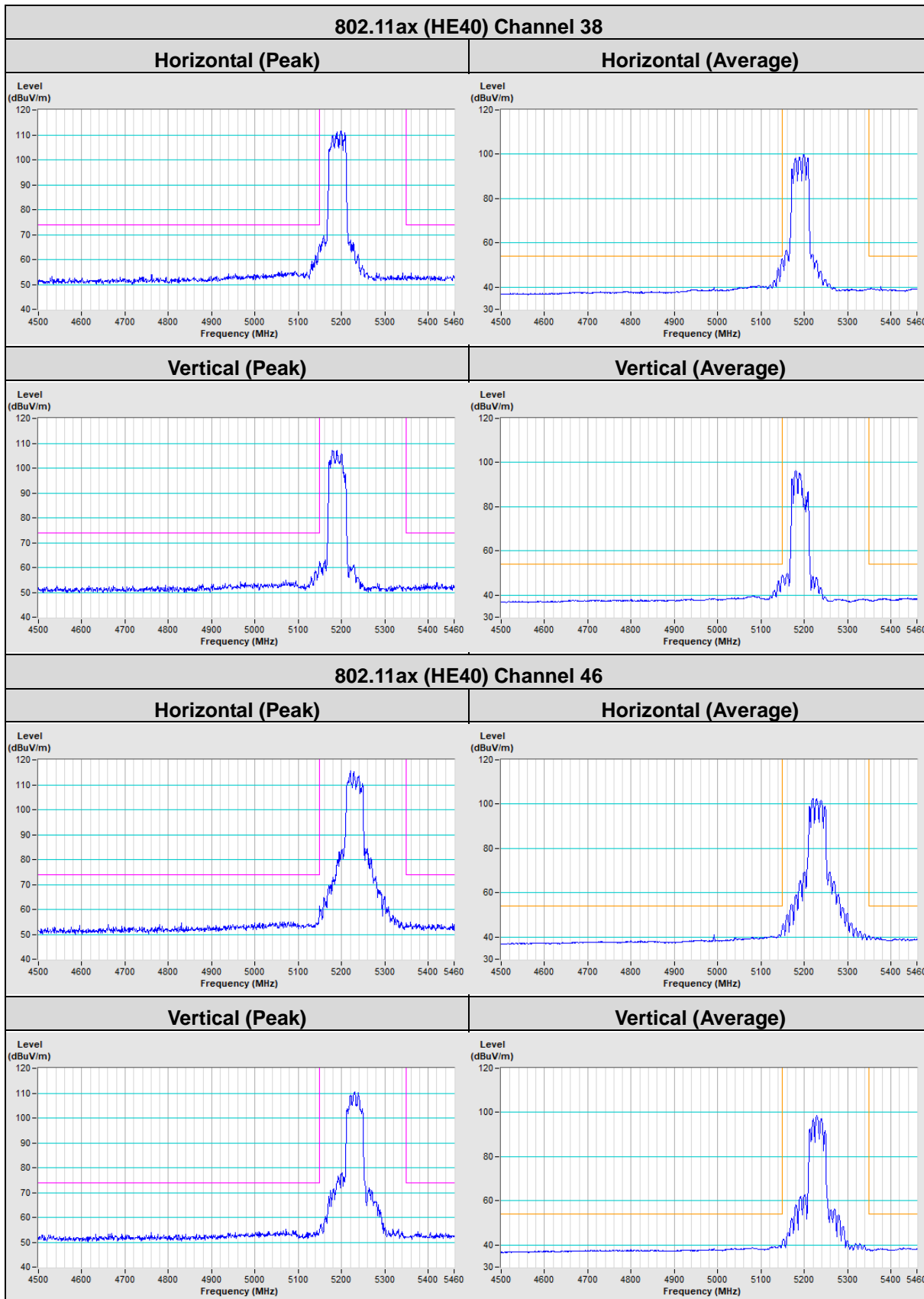

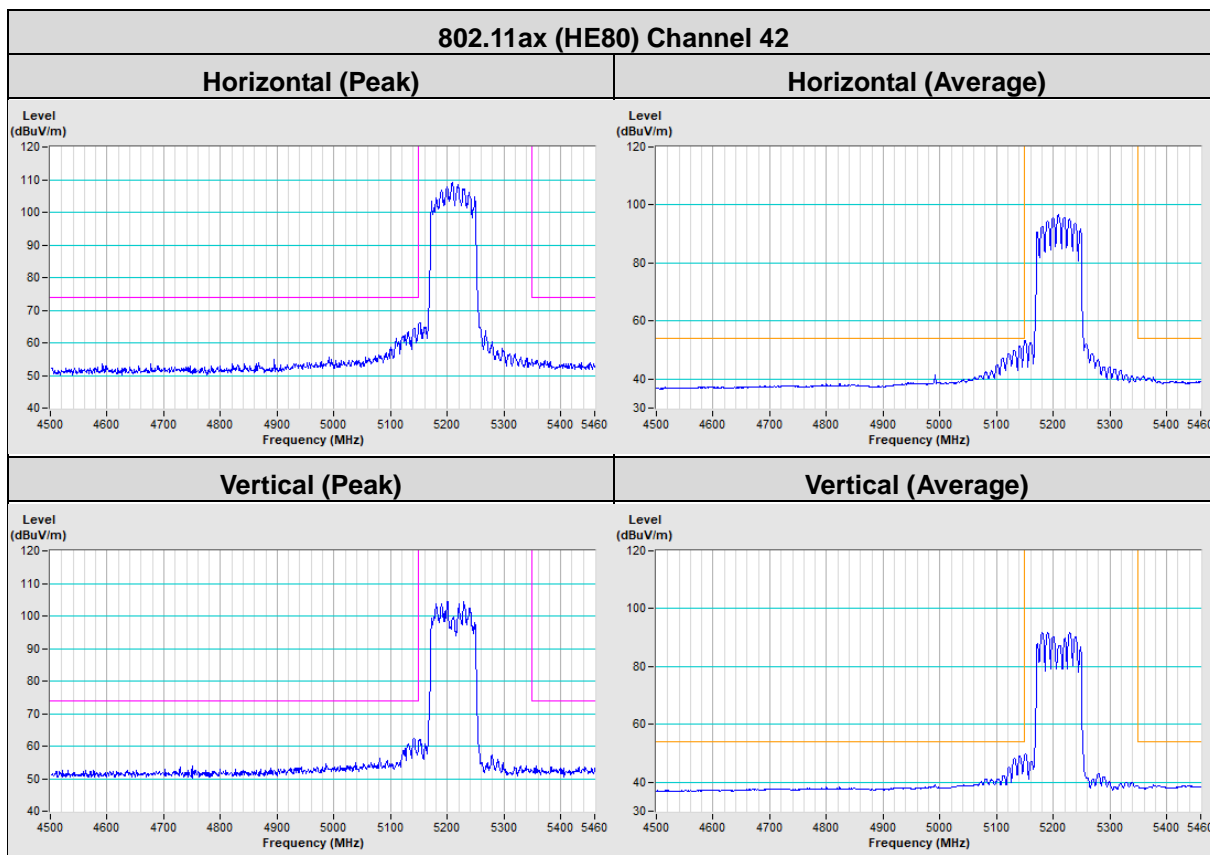

## Appendix – Information of the Testing Laboratories

We, Bureau Veritas Consumer Products Services (H.K.) Ltd., Taoyuan Branch, were founded in 1988 to provide our best service in EMC, Radio, Telecom and Safety consultation. Our laboratories are FCC recognized accredited test firms and accredited according to ISO/IEC 17025.

If you have any comments, please feel free to contact us at the following:

**Lin Kou EMC/RF Lab**

Tel: 886-2-26052180

Fax: 886-2-26051924

**Hsin Chu EMC/RF/Telecom Lab**

Tel: 886-3-6668565

Fax: 886-3-6668323

**Hwa Ya EMC/RF/Safety Lab**

Tel: 886-3-3183232

Fax: 886-3-3270892

**Email:** [service.adt@tw.bureauveritas.com](mailto:service.adt@tw.bureauveritas.com)

**Web Site:** [www.bureauveritas-adt.com](http://www.bureauveritas-adt.com)

The address and road map of all our labs can be found in our web site also.

--- END ---