

FCC Test Report

Report No.: RFBEBW-WTW-P20120765

FCC ID: KA2BGX1000A1

Test Model: DBG-X1000

Received Date: Jan. 13, 2021

Test Date: Jan. 21 ~ Jan. 29, 2021

Issued Date: Sep. 02, 2021

Applicant: D-Link Corporation

Address: 14420 Myford Road Suite 100, Irvine, California 92606 United States

Issued By: Bureau Veritas Consumer Products Services (H.K.) Ltd., Taoyuan Branch
Lin Kou Laboratories

Lab Address: No. 47-2, 14th Ling, Chia Pau Vil., Lin Kou Dist., New Taipei City, Taiwan

Test Location: No.19, Hwa Ya 2nd Rd., Wen Hwa Vil., Kwei Shan Dist., Taoyuan City
33383, Taiwan

**FCC Registration /
Designation Number:** 788550 / TW0003



This report is for your exclusive use. Any copying or replication of this report to or for any other person or entity, or use of our name or trademark, is permitted only with our prior written permission. This report sets forth our findings solely with respect to the test samples identified herein. The results set forth in this report are not indicative or representative of the quality or characteristics of the lot from which a test sample was taken or any similar or identical product unless specifically and expressly noted. Our report includes all of the tests requested by you and the results thereof based upon the information that you provided to us. You have 60 days from date of issuance of this report to notify us of any material error or omission caused by our negligence, provided, however, that such notice shall be in writing and shall specifically address the issue you wish to raise. A failure to raise such issue within the prescribed time shall constitute your unqualified acceptance of the completeness of this report, the tests conducted and the correctness of the report contents. Unless specific mention, the uncertainty of measurement has been explicitly taken into account to declare the compliance or non-compliance to the specification.

Table of Contents

Release Control Record	4
1 Certificate of Conformity	5
2 Summary of Test Results.....	6
2.1 Measurement Uncertainty.....	6
2.2 Modification Record	6
3 General Information	7
3.1 General Description of EUT	7
3.2 Description of Test Modes.....	8
3.2.1 Test Mode Applicability and Tested Channel Detail.....	9
3.3 Duty Cycle of Test Signal	11
3.4 Description of Support Units	12
3.4.1 Configuration of System under Test	12
3.5 General Description of Applied Standards and References	12
4 Test Types and Results	13
4.1 Radiated Emission and Bandedge Measurement	13
4.1.1 Limits of Radiated Emission and Bandedge Measurement	13
4.1.2 Test Instruments	14
4.1.3 Test Procedures.....	15
4.1.4 Deviation from Test Standard	16
4.1.5 Test Set Up	16
4.1.6 EUT Operating Conditions.....	17
4.1.7 Test Results	18
4.2 Conducted Emission Measurement.....	32
4.2.1 Limits of Conducted Emission Measurement	32
4.2.2 Test Instruments	32
4.2.3 Test Procedures.....	33
4.2.4 Deviation from Test Standard	33
4.2.5 Test Setup.....	33
4.2.6 EUT Operating Conditions.....	33
4.2.7 Test Results	34
4.3 6 dB Bandwidth Measurement.....	36
4.3.1 Limits of 6 dB Bandwidth Measurement.....	36
4.3.2 Test Setup.....	36
4.3.3 Test Instruments	36
4.3.4 Test Procedure	36
4.3.5 Deviation from Test Standard	36
4.3.6 EUT Operating Conditions.....	36
4.3.7 Test Results	37
4.4 Occupied Bandwidth Measurement.....	39
4.4.1 Test Setup.....	39
4.4.2 Test Instruments	39
4.4.3 Test Procedure	39
4.4.4 Deviation from Test Standard	39
4.4.5 EUT Operating Conditions.....	39
4.4.6 Test Results	40
4.5 Conducted Output Power Measurement	42
4.5.1 Limits of Conducted Output Power Measurement.....	42
4.5.2 Test Setup.....	42
4.5.3 Test Instruments	42
4.5.4 Test Procedures.....	42
4.5.5 Deviation from Test Standard	42
4.5.6 EUT Operating Conditions.....	42
4.5.7 Test Results	43

4.6	Power Spectral Density Measurement	47
4.6.1	Limits of Power Spectral Density Measurement.....	47
4.6.2	Test Setup.....	47
4.6.3	Test Instruments	47
4.6.4	Test Procedure	47
4.6.5	Deviation from Test Standard	48
4.6.6	EUT Operating Condition	48
4.6.7	Test Results	49
4.7	Conducted Out of Band Emission Measurement	52
4.7.1	Limits of Conducted Out of Band Emission Measurement.....	52
4.7.2	Test Setup.....	52
4.7.3	Test Instruments	52
4.7.4	Test Procedure	52
4.7.5	Deviation from Test Standard	52
4.7.6	EUT Operating Condition	52
4.7.7	Test Results	53
5	Pictures of Test Arrangements.....	61
	Annex A- Band Edge Measurement	62
	Appendix – Information of the Testing Laboratories	66

Release Control Record

Issue No.	Description	Date Issued
RFBEBW-WTW-P20120765	Original Release	Sep. 02, 2021

1 Certificate of Conformity

Product: Nuclias Cloud-Managed Wireless VPN Gateway

Brand: D-Link Corporation

Test Model: DBG-X1000

Sample Status: Mass product

Applicant: D-Link Corporation

Test Date: Jan. 21 ~ Jan. 29, 2021

Standards: 47 CFR FCC Part 15, Subpart C (Section 15.247)
ANSI C63.10:2013

The above equipment has been tested by **Bureau Veritas Consumer Products Services (H.K.) Ltd., Taoyuan Branch**, and found compliance with the requirement of the above standards. The test record, data evaluation & Equipment Under Test (EUT) configurations represented herein are true and accurate accounts of the measurements of the sample's RF characteristics under the conditions specified in this report.

Prepared by : Gina Liu, **Date:** Sep. 02, 2021
Gina Liu / Specialist

Approved by : Dylan Chiou, **Date:** Sep. 02, 2021
Dylan Chiou / Senior Project Engineer

2 Summary of Test Results

47 CFR FCC Part 15, Subpart C (Section 15.247)			
FCC Clause	Test Item	Result	Remarks
15.207	AC Power Conducted Emission	Pass	Meet the requirement of limit. Minimum passing margin is -0.3 dB at 2390.00 MHz.
15.205 / 15.209 / 15.247(d)	Radiated Emissions and Band Edge Measurement	Pass	Meet the requirement of limit. Minimum passing margin is -22.34 dB at 0.31531 MHz.
15.247(d)	Antenna Port Emission	Pass	Meet the requirement of limit.
15.247(a)(2)	6 dB Bandwidth	Pass	Meet the requirement of limit.
---	Occupied Bandwidth Measurement	Pass	Reference only
15.247(b)	Conducted power	Pass	Meet the requirement of limit.
15.247(e)	Power Spectral Density	Pass	Meet the requirement of limit.
15.203	Antenna Requirement	Pass	Antenna connector is SMA Male Reverse connector not a standard connector.

Note:

- For 2.4G band compliance with rule 15.247(d) of the band-edge items, the test plots were recorded in Annex A. Test Procedures refer to report 4.1.3.
- Determining compliance based on the results of the compliance measurement, not taking into account measurement instrumentation uncertainty.

2.1 Measurement Uncertainty

Where relevant, the following measurement uncertainty levels have been estimated for tests performed on the EUT as specified in CISPR 16-4-2:

Measurement	Frequency	Expanded Uncertainty (k=2) (±)
Conducted Emissions at mains ports	150 kHz ~ 30 MHz	2.79 dB
Radiated Emissions up to 1 GHz	9 kHz ~ 30 MHz	3.04 dB
	30 MHz ~ 200 MHz	2.93 dB
	200 MHz ~ 1000 MHz	2.95 dB
Radiated Emissions above 1 GHz	1 GHz ~ 18 GHz	2.26 dB
	18 GHz ~ 40 GHz	1.94 dB

2.2 Modification Record

There were no modifications required for compliance.

3 General Information

3.1 General Description of EUT

Product	Nuclias Cloud-Managed Wireless VPN Gateway
Brand	D-Link Corporation
Test Model	DBG-X1000
Status of EUT	Mass product
Power Supply Rating	12 Vdc (Adapter)
Modulation Type	CCK, DQPSK, DBPSK for DSSS 256QAM, 64QAM, 16QAM, QPSK, BPSK for OFDM 1024QAM, 256QAM, 64QAM, 16QAM, QPSK, BPSK for OFDMA
Modulation Technology	DSSS, OFDM, OFDMA
Transfer Rate	802.11b: 11.0 / 5.5 / 2.0 / 1.0 Mbps 802.11g: 54.0 / 48.0 / 36.0 / 24.0 / 18.0 / 12.0 / 9.0 / 6.0 Mbps 802.11n: up to 400.0 Mbps 802.11ax: up to 573.5 Mbps
Operating Frequency	2412 ~ 2462 MHz
Number of Channel	11 for 802.11b, 802.11g, 802.11n (HT20/VHT20), 802.11ax (HE20) 7 for 802.11n (HT40/VHT40), 802.11ax (HE40)
Output Power	CDD Mode: 389.243 mW Beamforming Mode: 185.751 mW
Antenna Type	Dipole antenna with 3.5 dBi gain
Antenna Connector	SMA Male Reverse
Accessory Device	Refer to Note as below
Data Cable Supplied	N/A

Note:

- The EUT incorporates a MIMO function. Physically, the EUT provides two completed transmitters and two receivers.

Modulation Mode	Tx Function	CDD Mode	Beamforming Mode
802.11b	2TX	Support	Not Support
802.11g	2TX	Support	Not Support
802.11n (HT20/VHT20)	2TX	Support	Support
802.11n (HT40/VHT40)	2TX	Support	Support
802.11ax (HE20)	2TX	Support	Support
802.11ax (HE40)	2TX	Support	Support

* The modulation and bandwidth are similar for 802.11n mode for HT20 / HT40 / VHT20 / VHT40 and 802.11ax mode for HE20 / HE40, therefore investigated worst case to representative mode in test report. (Final test mode refer section 3.2.1)

- The EUT contains following accessory devices.

Product	Brand	Model	Description
Adapter	APD	WA-24Q12R	I/P: 100-240 Vac, 50-60 Hz, 700 mA O/P: 12 Vdc, 2 A

- The above Antenna information is declared by manufacturer and for more detailed features description, please refer to the manufacturer's specifications, the laboratory shall not be held responsible.
- The above EUT information is declared by manufacturer and for more detailed features description, please refers to the manufacturer's specifications or user's manual.

3.2 Description of Test Modes

11 channels are provided for 802.11b, 802.11g and 802.11n (HT20/VHT20) and 802.11ax (HE20):

Channel	Frequency (MHz)	Channel	Frequency (MHz)
1	2412	7	2442
2	2417	8	2447
3	2422	9	2452
4	2427	10	2457
5	2432	11	2462
6	2437		

7 channels are provided for 802.11n (HT40/VHT40) and 802.11ax (HE40):

Channel	Frequency (MHz)	Channel	Frequency (MHz)
3	2422	7	2442
4	2427	8	2447
5	2432	9	2452
6	2437		

3.2.1 Test Mode Applicability and Tested Channel Detail

EUT Configure Mode	Applicable To				Description
	RE \geq 1G	RE<1G	PLC	APCM	
-	√	√	√	√	-

Where **RE \geq 1G**: Radiated Emission above 1 GHz **RE<1G**: Radiated Emission below 1 GHz
PLC: Power Line Conducted Emission **APCM**: Antenna Port Conducted Measurement

NOTE: The EUT had been pre-tested on the positioned of each 3 axis. The worst case was found when positioned on **X-plane**.
NOTE: “-” means no effect.

Radiated Emission Test (Above 1 GHz):

- Pre-Scan has been conducted to determine the worst-case mode from all possible combinations between available modulations, data rates and antenna ports (if EUT with antenna diversity architecture).
- Following channel(s) was (were) selected for the final test as listed below.

EUT Configure Mode	Mode	Available Channel	Tested Channel	Modulation Technology	Modulation Type	Data Rate (Mbps)
-	802.11b	1 to 11	1, 6, 11	DSSS	DBPSK	1.0
-	802.11g	1 to 11	1, 6, 11	OFDM	BPSK	6.0
-	802.11ax (HE20)	1 to 11	1, 6, 11	OFDMA	BPSK	MCS0
-	802.11ax (HE40)	3 to 9	3, 6, 9	OFDMA	BPSK	MCS0

Radiated Emission Test (Below 1 GHz):

- Pre-Scan has been conducted to determine the worst-case mode from all possible combinations between available modulations, data rates and antenna ports (if EUT with antenna diversity architecture).
- Following channel(s) was (were) selected for the final test as listed below.

EUT Configure Mode	Mode	Available Channel	Tested Channel	Modulation Technology	Modulation Type	Data Rate (Mbps)
-	802.11g	1 to 11	6	OFDM	BPSK	6.0

Power Line Conducted Emission Test:

- Pre-Scan has been conducted to determine the worst-case mode from all possible combinations between available modulations, data rates and antenna ports (if EUT with antenna diversity architecture).
- Following channel(s) was (were) selected for the final test as listed below.

EUT Configure Mode	Mode	Available Channel	Tested Channel	Modulation Technology	Modulation Type	Data Rate (Mbps)
-	802.11g	1 to 11	6	OFDM	BPSK	6.0

Bandedge Measurement:

- Pre-Scan has been conducted to determine the worst-case mode from all possible combinations between available modulations, data rates and antenna ports (if EUT with antenna diversity architecture).
- Following channel(s) was (were) selected for the final test as listed below.

EUT Configure Mode	Mode	Available Channel	Tested Channel	Modulation Technology	Modulation Type	Data Rate (Mbps)
-	802.11b	1 to 11	1, 11	DSSS	DBPSK	1.0
-	802.11g	1 to 11	1, 11	OFDM	BPSK	6.0
-	802.11ax (HE20)	1 to 11	1, 11	OFDMA	BPSK	MCS0
-	802.11ax (HE40)	3 to 9	3, 9	OFDMA	BPSK	MCS0

Antenna Port Conducted Measurement:

- This item includes all test value of each mode, but only includes spectrum plot of worst value of each mode.
- Pre-Scan has been conducted to determine the worst-case mode from all possible combinations between available modulations, data rates and antenna ports (if EUT with antenna diversity architecture).
- Following channel(s) was (were) selected for the final test as listed below.

EUT Configure Mode	Mode	Available Channel	Tested Channel	Modulation Technology	Modulation Type	Data Rate (Mbps)
-	802.11b	1 to 11	1, 6, 11	DSSS	DBPSK	1.0
-	802.11g	1 to 11	1, 6, 11	OFDM	BPSK	6.0
-	802.11n (HT20)	1 to 11	1, 6, 11	OFDM	BPSK	6.5
-	802.11n (HT40)	3 to 9	3, 6, 9	OFDM	BPSK	13.5
-	802.11ac (VHT20)	1 to 11	1, 6, 11	OFDM	BPSK	7.2
-	802.11ac (VHT40)	3 to 9	3, 6, 9	OFDM	BPSK	15.0
-	802.11ax (HE20)	1 to 11	1, 6, 11	OFDMA	BPSK	MCS0
-	802.11ax (HE40)	3 to 9	3, 6, 9	OFDMA	BPSK	MCS0

Test Condition:

Applicable To	Environmental Conditions	Input Power	Tested by
RE \geq 1G	25 deg. C, 65 % RH	120 Vac, 60 Hz	Rex Wang
RE<1G	25 deg. C, 65 % RH	120 Vac, 60 Hz	Rex Wang
PLC	25 deg. C, 65 % RH	120 Vac, 60 Hz	Rex Wang
APCM	25 deg. C, 65 % RH	12 Vdc	Ivan Tseng

3.3 Duty Cycle of Test Signal

Duty cycle of test signal is < 98 %, duty factor shall be considered.

802.11b: Duty cycle = $0.684/0.937 = 0.730$, Duty factor = $10 * \log(1/0.730) = 1.37$

802.11g: Duty cycle = $1.97/2.105 = 0.936$, Duty factor = $10 * \log(1/0.936) = 0.29$

802.11ax (HE20): Duty cycle = $5.388/5.738 = 0.939$, Duty factor = $10 * \log(1/0.939) = 0.27$

802.11ax (HE40): Duty cycle = $5.35/5.988 = 0.893$, Duty factor = $10 * \log(1/0.893) = 0.49$

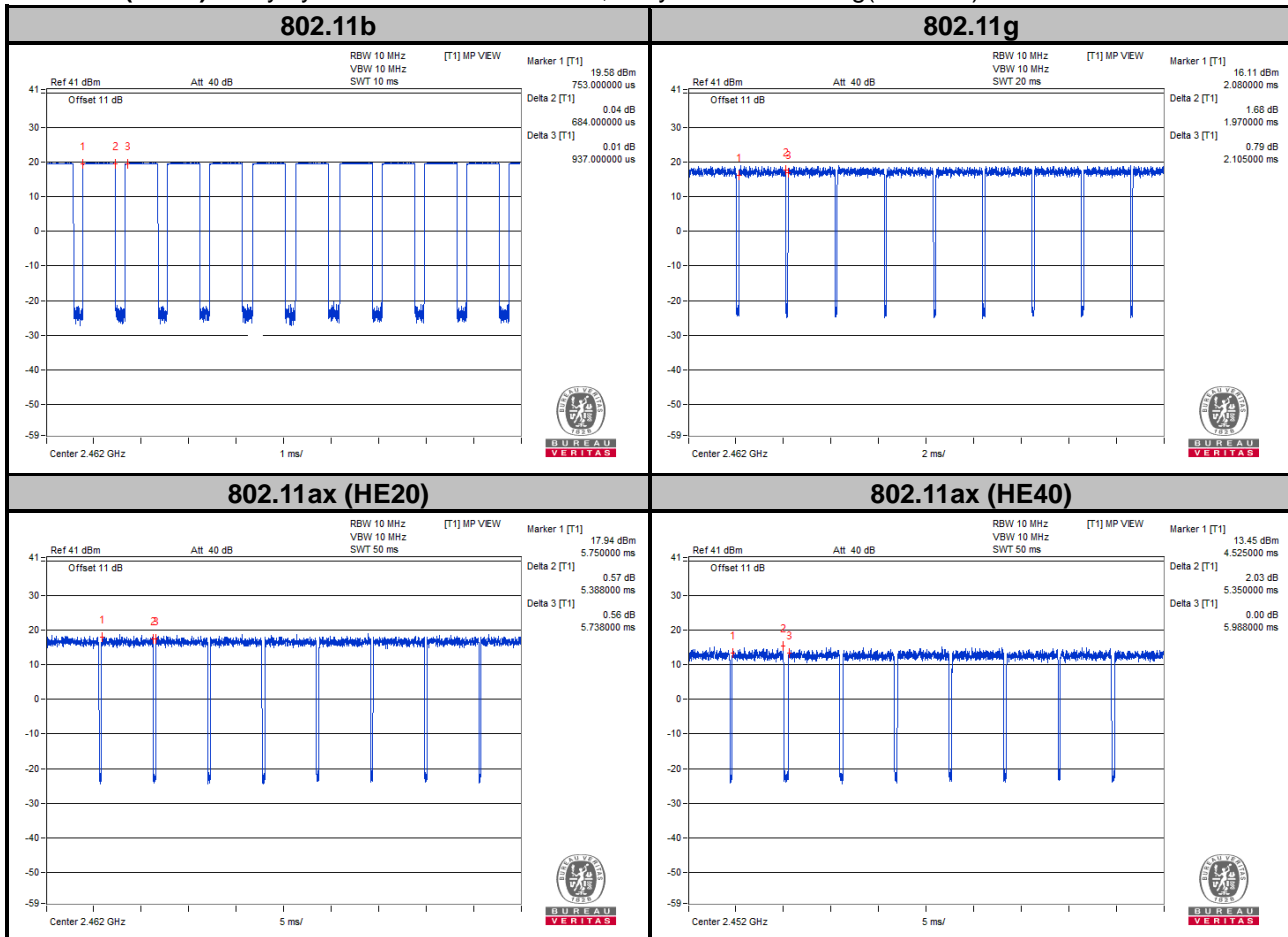

3.4 Description of Support Units

The EUT has been tested as an independent unit together with other necessary accessories or support units. The following support units or accessories were used to form a representative test configuration during the tests.

ID	Product	Brand	Model No.	Serial No.	FCC ID	Remarks
A.	Load	N/A	N/A	N/A	N/A	--
B.	Notebook	DELL	E5410	1HC2XM1	N/A	--
C.	USB 2.0 FLASH	HP	v250W	09	N/A	--

ID	Cable Descriptions	Qty.	Length (m)	Shielding (Yes/No)	Cores (Qty.)	Remarks
1.	Adapter Cable	1	1.5	N	0	Accessory of the EUT
2.	LAN Cable	4	1.5	N	0	RJ45, Cat5e
3.	Console Cable	1	1.8	N	0	Provided by client
4.	LAN Cable	1	1.0	N	0	RJ45, Cat5e; Provided by client

Note:

1. All power cords of the above support units are non-shielded (1.8m).

3.4.1 Configuration of System under Test

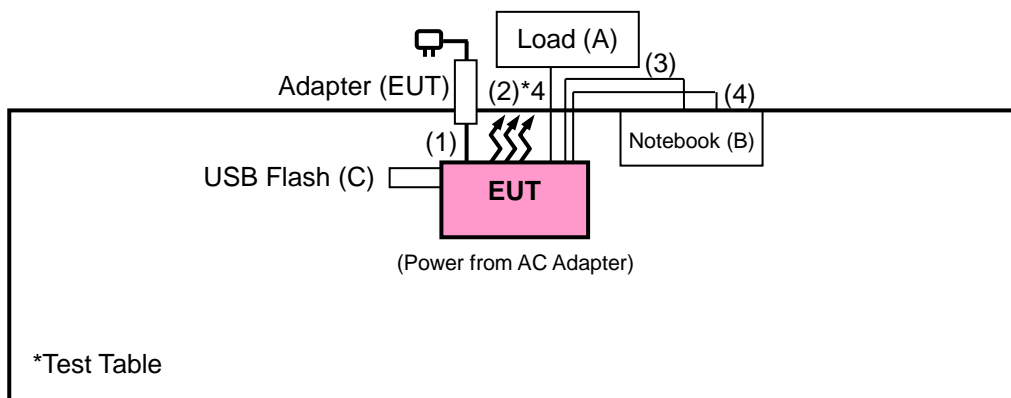

3.5 General Description of Applied Standards and References

The EUT is a RF Product. According to the specifications of the manufacturer, it must comply with the requirements of the following standards and references:

Test Standard:

FCC Part 15, Subpart C (15.247)

ANSI C63.10-2013

All test items have been performed and recorded as per the above standards.

References Test Guidance:

KDB 558074 D01 Meas Guidance v05r02

KDB 662911 D01 Multiple Transmitter Output v02r01

All test items have been performed as a reference to the above KDB test guidance.

4 Test Types and Results

4.1 Radiated Emission and Bandedge Measurement

4.1.1 Limits of Radiated Emission and Bandedge Measurement

Radiated emissions which fall in the restricted bands must comply with the radiated emission limits specified as below table. Other emissions shall be at least 20 dB below the highest level of the desired power:

Frequencies (MHz)	Field Strength (microvolts/meter)	Measurement Distance (meters)
0.009 ~ 0.490	2400/F (kHz)	300
0.490 ~ 1.705	24000/F (kHz)	30
1.705 ~ 30.0	30	30
30 ~ 88	100	3
88 ~ 216	150	3
216 ~ 960	200	3
Above 960	500	3

NOTE:

1. The lower limit shall apply at the transition frequencies.
2. Emission level (dBuV/m) = 20 log Emission level (uV/m).
3. For frequencies above 1000 MHz, the field strength limits are based on average detector, however, the peak field strength of any emission shall not exceed the maximum permitted average limits, specified above by more than 20 dB under any condition of modulation.

4.1.2 Test Instruments

Description & Manufacturer	Model No.	Serial No.	Date of Calibration	Due Date of Calibration
Test Receiver KEYSIGHT	N9038A	MY55420137	Apr. 16, 2020	Apr. 15, 2021
Spectrum Analyzer ROHDE & SCHWARZ	FSP40	100039	Jun. 12, 2020	Jun. 11, 2021
BILOG Antenna SCHWARZBECK	VULB9168	9168-160	Nov. 06, 2020	Nov. 05, 2021
HORN Antenna SCHWARZBECK	BBHA 9120 D	9120D-1169	Nov. 22, 2020	Nov. 21, 2021
HORN Antenna SCHWARZBECK	BBHA 9170	BBHA9170241	Nov. 22, 2020	Nov. 21, 2021
Preamplifier Agilent (Below 1GHz)	8447D	2944A10638	Jun. 08, 2020	Jun. 07, 2021
Preamplifier Agilent (Above 1GHz)	8449B	3008A02367	Feb. 18, 2020	Feb. 17, 2021
RF signal cable HUBER+SUHNER&EMCI	SUCOFLEX 104 & EMC104-SM-SM80 00	CABLE-CH9-02 (248780+171006)	Jan. 16, 2021	Jan. 15, 2022
RF signal cable HUBER+SUHNER	SUCOFLEX 104	CABLE-CH9-(2507 95/4)	Jan. 16, 2021	Jan. 15, 2022
RF signal cable Woken	8D-FB	Cable-CH9-01	Jun. 08, 2020	Jun. 07, 2021
Software BV ADT	ADT_Radiated_ V7.6.15.9.5	NA	NA	NA
Antenna Tower EMCO	2070/2080	512.835.4684	NA	NA
Turn Table EMCO	2087-2.03	NA	NA	NA
Antenna Tower & Turn BV ADT	AT100	AT93021705	NA	NA
Turn Table BV ADT	TT100	TT93021705	NA	NA
Turn Table Controller BV ADT	SC100	SC93021705	NA	NA
Boresight Antenna Fixture	FBA-01	FBA-SIP01	NA	NA
USB Wideband Power Sensor KEYSIGHT	U2021XA	MY55050005/MY55 190004/MY551900 07/MY55210005	Jul. 13, 2020	Jul. 12, 2021

- Note: 1. The calibration interval of the above test instruments is 12 months and the calibrations are traceable to NML/ROC and NIST/USA.
2. The test was performed in HwaYa Chamber 9.

4.1.3 Test Procedures

For Radiated Emission below 30 MHz

- a. The EUT was placed on the top of a rotating table 0.8 meters above the ground at a 3 meter chamber room. The table was rotated 360 degrees to determine the position of the highest radiation.
- b. The EUT was set 3 meters away from the interference-receiving antenna, which was mounted on the top of a variable-height antenna tower.
- c. Parallel, perpendicular, and ground-parallel orientations of the antenna are set to make the measurement.
- d. For each suspected emission, the EUT was arranged to its worst case and the rotatable table was turned from 0 degrees to 360 degrees to find the maximum reading.
- e. The test-receiver system was set to Quasi-Peak Detect Function and Specified Bandwidth with Maximum Hold Mode.

Note:

1. The resolution bandwidth and video bandwidth of test receiver/spectrum analyzer is 9 kHz at frequency below 30 MHz.

For Radiated Emission above 30 MHz

- a. The EUT was placed on the top of a rotating table 0.8 meters (for 30 MHz ~ 1 GHz) / 1.5 meters (for above 1 GHz) above the ground at 3 meter chamber room for test. The table was rotated 360 degrees to determine the position of the highest radiation.
- b. The EUT was set 3 meters away from the interference-receiving antenna, which was mounted on the top of a variable-height antenna tower.
- c. The height of antenna is varied from one meter to four meters above the ground to determine the maximum value of the field strength. Both horizontal and vertical polarizations of the antenna are set to make the measurement.
- d. For each suspected emission, the EUT was arranged to its worst case and then the antenna was tuned to heights from 1 meter to 4 meters and the rotatable table was turned from 0 degrees to 360 degrees to find the maximum reading.
- e. The test-receiver system was set to quasi-peak detect function and specified bandwidth with maximum hold mode when the test frequency is below 1 GHz.
- f. The test-receiver system was set to peak and average detected function and specified bandwidth with maximum hold mode when the test frequency is above 1 GHz. If the peak reading value also meets average limit, measurement with the average detector is unnecessary.

Note:

1. The resolution bandwidth and video bandwidth of test receiver/spectrum analyzer is 120 kHz for Quasi-peak detection (QP) or Peak detection (PK) at frequency below 1 GHz.
2. The resolution bandwidth of test receiver/spectrum analyzer is 1 MHz and the video bandwidth is 3 MHz for Peak detection (PK) at frequency above 1 GHz.
3. The resolution bandwidth of test receiver/spectrum analyzer is 1 MHz and the video bandwidth is $\geq 1/T$ (Duty cycle < 98 %) or 10 Hz (Duty cycle ≥ 98 %) for Average detection (AV) at frequency above 1 GHz.
(11b: RBW = 1 MHz, VBW = 3 kHz ; 11g: RBW = 1 MHz, VBW = 1 kHz ;
11ax (HE20): RBW = 1 MHz, VBW = 1 kHz ; 11ax (HE40): RBW = 1 MHz, VBW = 1 kHz)
4. All modes of operation were investigated and the worst-case emissions are reported.

4.1.4 Deviation from Test Standard

No deviation.

4.1.5 Test Set Up

<Radiated Emission below 30 MHz>

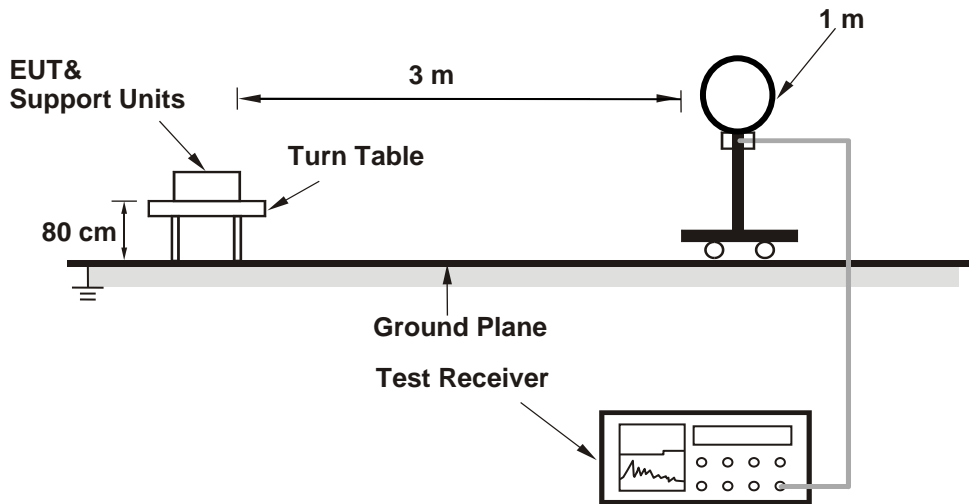

<Radiated Emission 30 MHz to 1 GHz>

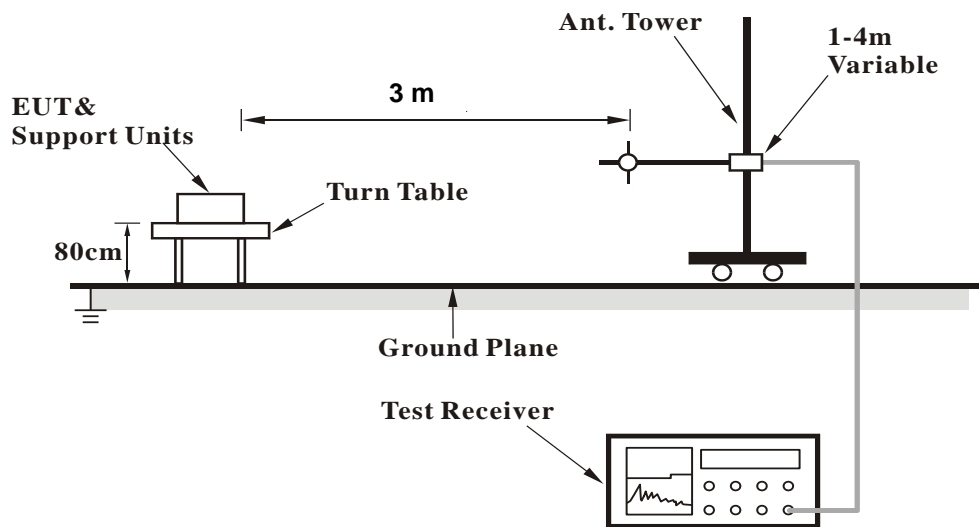

<Radiated Emission above 1 GHz>

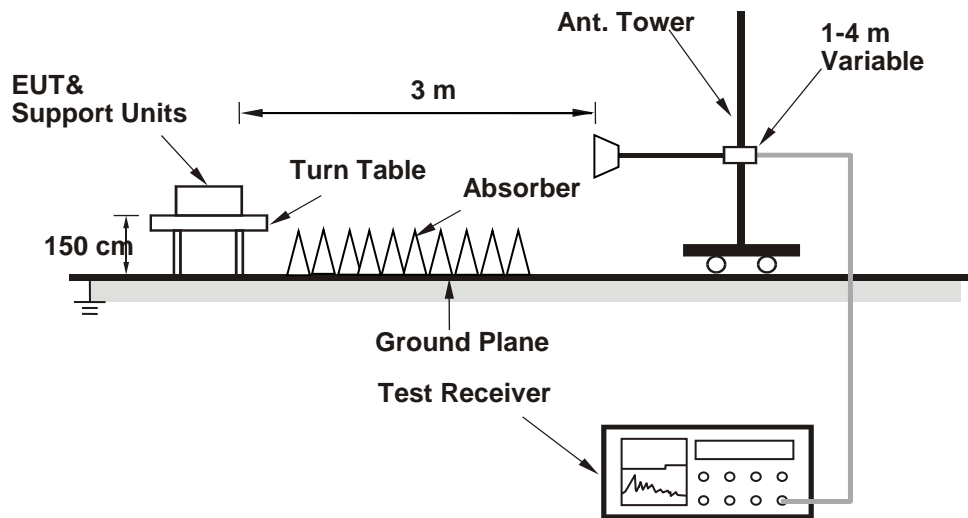

For the actual test configuration, please refer to the attached file (Test Setup Photo).

4.1.6 EUT Operating Conditions

- a. Placed the EUT on a testing table.
- b. Use the software to control the EUT under transmission condition continuously at specific channel frequency.

4.1.7 Test Results

Above 1 GHz Data :

RF Mode	TX 802.11b	Channel	CH 1 : 2412 MHz
Frequency Range	1GHz ~ 25GHz	Detector Function	Peak (PK) Average (AV)

Antenna Polarity & Test Distance : Horizontal at 3 m								
No	Frequency (MHz)	Emission Level (dBuV/m)	Limit (dBuV/m)	Margin (dB)	Antenna Height (m)	Table Angle (Degree)	Raw Value (dBuV)	Correction Factor (dB/m)
1	2390.00	57.8 PK	74.0	-16.2	1.27 H	252	26.6	31.2
2	2390.00	45.1 AV	54.0	-8.9	1.27 H	252	13.9	31.2
3	*2412.00	109.9 PK			1.27 H	252	78.7	31.2
4	*2412.00	107.8 AV			1.27 H	252	76.6	31.2
5	4824.00	54.8 PK	74.0	-19.2	3.65 H	278	52.8	2.0
6	4824.00	53.2 AV	54.0	-0.8	3.65 H	278	51.2	2.0
Antenna Polarity & Test Distance : Vertical at 3 m								
No	Frequency (MHz)	Emission Level (dBuV/m)	Limit (dBuV/m)	Margin (dB)	Antenna Height (m)	Table Angle (Degree)	Raw Value (dBuV)	Correction Factor (dB/m)
1	2390.00	55.7 PK	74.0	-18.3	3.63 V	350	24.5	31.2
2	2390.00	42.6 AV	54.0	-11.4	3.63 V	350	11.4	31.2
3	*2412.00	101.4 PK			3.63 V	350	70.2	31.2
4	*2412.00	99.4 AV			3.63 V	350	68.2	31.2
5	4824.00	52.1 PK	74.0	-21.9	1.08 V	18	50.1	2.0
6	4824.00	49.6 AV	54.0	-4.4	1.08 V	18	47.6	2.0

Remarks:

1. Emission Level(dBuV/m) = Raw Value(dBuV) + Correction Factor(dB/m)
2. Correction Factor(dB/m) = Antenna Factor(dB/m) + Cable Factor(dB) – Pre-Amplifier Factor(dB)
3. Margin value = Emission Level – Limit value
4. The other emission levels were very low against the limit.
5. " * ": Fundamental frequency.

RF Mode	TX 802.11b	Channel	CH 6 : 2437 MHz
Frequency Range	1GHz ~ 25GHz	Detector Function	Peak (PK) Average (AV)

Antenna Polarity & Test Distance : Horizontal at 3 m

No	Frequency (MHz)	Emission Level (dBuV/m)	Limit (dBuV/m)	Margin (dB)	Antenna Height (m)	Table Angle (Degree)	Raw Value (dBuV)	Correction Factor (dB/m)
1	*2437.00	109.1 PK			1.08 H	267	78.0	31.1
2	*2437.00	106.8 AV			1.08 H	267	75.7	31.1
3	4874.00	54.1 PK	74.0	-19.9	3.57 H	276	52.0	2.1
4	4874.00	52.2 AV	54.0	-1.8	3.57 H	276	50.1	2.1

Antenna Polarity & Test Distance : Vertical at 3 m

No	Frequency (MHz)	Emission Level (dBuV/m)	Limit (dBuV/m)	Margin (dB)	Antenna Height (m)	Table Angle (Degree)	Raw Value (dBuV)	Correction Factor (dB/m)
1	*2437.00	101.5 PK			3.46 V	320	70.4	31.1
2	*2437.00	99.7 AV			3.46 V	320	68.6	31.1
3	4874.00	50.1 PK	74.0	-23.9	1.05 V	18	48.0	2.1
4	4874.00	47.6 AV	54.0	-6.4	1.05 V	18	45.5	2.1

Remarks:

1. Emission Level(dBuV/m) = Raw Value(dBuV) + Correction Factor(dB/m)
2. Correction Factor(dB/m) = Antenna Factor(dB/m) + Cable Factor(dB) – Pre-Amplifier Factor(dB)
3. Margin value = Emission Level – Limit value
4. The other emission levels were very low against the limit.
5. " * ": Fundamental frequency.

RF Mode	TX 802.11b	Channel	CH 11 : 2462 MHz
Frequency Range	1GHz ~ 25GHz	Detector Function	Peak (PK) Average (AV)

Antenna Polarity & Test Distance : Horizontal at 3 m								
No	Frequency (MHz)	Emission Level (dBuV/m)	Limit (dBuV/m)	Margin (dB)	Antenna Height (m)	Table Angle (Degree)	Raw Value (dBuV)	Correction Factor (dB/m)
1	*2462.00	112.4 PK			1.34 H	278	81.3	31.1
2	*2462.00	110.0 AV			1.34 H	278	78.9	31.1
3	2483.50	57.3 PK	74.0	-16.7	1.34 H	278	26.2	31.1
4	2483.50	47.5 AV	54.0	-6.5	1.34 H	278	16.4	31.1
5	4924.00	54.0 PK	74.0	-20.0	3.70 H	277	51.8	2.2
6	4924.00	52.8 AV	54.0	-1.2	3.70 H	277	50.6	2.2
Antenna Polarity & Test Distance : Vertical at 3 m								
No	Frequency (MHz)	Emission Level (dBuV/m)	Limit (dBuV/m)	Margin (dB)	Antenna Height (m)	Table Angle (Degree)	Raw Value (dBuV)	Correction Factor (dB/m)
1	*2462.00	104.3 PK			3.90 V	330	73.2	31.1
2	*2462.00	102.0 AV			3.90 V	330	70.9	31.1
3	2483.50	55.8 PK	74.0	-18.2	3.90 V	330	24.7	31.1
4	2483.50	45.9 AV	54.0	-8.1	3.90 V	330	14.8	31.1
5	4924.00	53.0 PK	74.0	-21.0	1.00 V	1	50.8	2.2
6	4924.00	49.8 AV	54.0	-4.2	1.00 V	1	47.6	2.2

Remarks:

1. Emission Level(dBuV/m) = Raw Value(dBuV) + Correction Factor(dB/m)
2. Correction Factor(dB/m) = Antenna Factor(dB/m) + Cable Factor(dB) – Pre-Amplifier Factor(dB)
3. Margin value = Emission Level – Limit value
4. The other emission levels were very low against the limit.
5. " * ": Fundamental frequency.

RF Mode	TX 802.11g	Channel	CH 1 : 2412 MHz
Frequency Range	1GHz ~ 25GHz	Detector Function	Peak (PK) Average (AV)

Antenna Polarity & Test Distance : Horizontal at 3 m

No	Frequency (MHz)	Emission Level (dBuV/m)	Limit (dBuV/m)	Margin (dB)	Antenna Height (m)	Table Angle (Degree)	Raw Value (dBuV)	Correction Factor (dB/m)
1	2390.00	68.8 PK	74.0	-5.2	1.35 H	257	37.6	31.2
2	2390.00	53.7 AV	54.0	-0.3	1.35 H	257	22.5	31.2
3	*2412.00	111.4 PK			1.35 H	257	80.2	31.2
4	*2412.00	101.1 AV			1.35 H	257	69.9	31.2
5	4824.00	51.1 PK	74.0	-22.9	3.43 H	285	49.1	2.0
6	4824.00	41.1 AV	54.0	-12.9	3.43 H	285	39.1	2.0

Antenna Polarity & Test Distance : Vertical at 3 m

No	Frequency (MHz)	Emission Level (dBuV/m)	Limit (dBuV/m)	Margin (dB)	Antenna Height (m)	Table Angle (Degree)	Raw Value (dBuV)	Correction Factor (dB/m)
1	2390.00	58.9 PK	74.0	-15.1	3.99 V	323	27.7	31.2
2	2390.00	45.0 AV	54.0	-9.0	3.99 V	323	13.8	31.2
3	*2412.00	103.5 PK			3.99 V	323	72.3	31.2
4	*2412.00	93.2 AV			3.99 V	323	62.0	31.2
5	4824.00	48.2 PK	74.0	-25.8	3.92 V	284	46.2	2.0
6	4824.00	38.4 AV	54.0	-15.6	3.92 V	284	36.4	2.0

Remarks:

1. Emission Level(dBuV/m) = Raw Value(dBuV) + Correction Factor(dB/m)
2. Correction Factor(dB/m) = Antenna Factor(dB/m) + Cable Factor(dB) – Pre-Amplifier Factor(dB)
3. Margin value = Emission Level – Limit value
4. The other emission levels were very low against the limit.
5. " * ": Fundamental frequency.

RF Mode	TX 802.11g	Channel	CH 6 : 2437 MHz
Frequency Range	1GHz ~ 25GHz	Detector Function	Peak (PK) Average (AV)

Antenna Polarity & Test Distance : Horizontal at 3 m								
No	Frequency (MHz)	Emission Level (dBuV/m)	Limit (dBuV/m)	Margin (dB)	Antenna Height (m)	Table Angle (Degree)	Raw Value (dBuV)	Correction Factor (dB/m)
1	*2437.00	118.9 PK			1.40 H	254	87.8	31.1
2	*2437.00	108.4 AV			1.40 H	254	77.3	31.1
3	4874.00	61.4 PK	74.0	-12.6	3.39 H	291	59.3	2.1
4	4874.00	48.1 AV	54.0	-5.9	3.39 H	291	46.0	2.1
Antenna Polarity & Test Distance : Vertical at 3 m								
No	Frequency (MHz)	Emission Level (dBuV/m)	Limit (dBuV/m)	Margin (dB)	Antenna Height (m)	Table Angle (Degree)	Raw Value (dBuV)	Correction Factor (dB/m)
1	*2437.00	112.5 PK			4.00 V	346	81.4	31.1
2	*2437.00	102.0 AV			4.00 V	346	70.9	31.1
3	4874.00	58.4 PK	74.0	-15.6	3.89 V	190	56.3	2.1
4	4874.00	45.0 AV	54.0	-9.0	3.89 V	190	42.9	2.1

Remarks:

1. Emission Level(dBuV/m) = Raw Value(dBuV) + Correction Factor(dB/m)
2. Correction Factor(dB/m) = Antenna Factor(dB/m) + Cable Factor(dB) – Pre-Amplifier Factor(dB)
3. Margin value = Emission Level – Limit value
4. The other emission levels were very low against the limit.
5. " * ": Fundamental frequency.

RF Mode	TX 802.11g	Channel	CH 11 : 2462 MHz
Frequency Range	1GHz ~ 25GHz	Detector Function	Peak (PK) Average (AV)

Antenna Polarity & Test Distance : Horizontal at 3 m

No	Frequency (MHz)	Emission Level (dBuV/m)	Limit (dBuV/m)	Margin (dB)	Antenna Height (m)	Table Angle (Degree)	Raw Value (dBuV)	Correction Factor (dB/m)
1	*2462.00	111.9 PK			1.28 H	254	80.8	31.1
2	*2462.00	101.2 AV			1.28 H	254	70.1	31.1
3	2483.50	64.5 PK	74.0	-9.5	1.28 H	254	33.4	31.1
4	2483.50	53.1 AV	54.0	-0.9	1.28 H	254	22.0	31.1
5	4924.00	48.2 PK	74.0	-25.8	3.61 H	290	46.0	2.2
6	4924.00	37.4 AV	54.0	-16.6	3.61 H	290	35.2	2.2

Antenna Polarity & Test Distance : Vertical at 3 m

No	Frequency (MHz)	Emission Level (dBuV/m)	Limit (dBuV/m)	Margin (dB)	Antenna Height (m)	Table Angle (Degree)	Raw Value (dBuV)	Correction Factor (dB/m)
1	*2462.00	107.3 PK			3.99 V	342	76.2	31.1
2	*2462.00	96.8 AV			3.99 V	342	65.7	31.1
3	2483.50	60.6 PK	74.0	-13.4	3.99 V	342	29.5	31.1
4	2483.50	48.6 AV	54.0	-5.4	3.99 V	342	17.5	31.1
5	4924.00	44.9 PK	74.0	-29.1	3.88 V	186	42.7	2.2
6	4924.00	33.8 AV	54.0	-20.2	3.88 V	186	31.6	2.2

Remarks:

1. Emission Level(dBuV/m) = Raw Value(dBuV) + Correction Factor(dB/m)
2. Correction Factor(dB/m) = Antenna Factor(dB/m) + Cable Factor(dB) – Pre-Amplifier Factor(dB)
3. Margin value = Emission Level – Limit value
4. The other emission levels were very low against the limit.
5. " * ": Fundamental frequency.

RF Mode	TX 802.11ax (HE20)	Channel	CH 1 : 2412 MHz
Frequency Range	1GHz ~ 25GHz	Detector Function	Peak (PK) Average (AV)

Antenna Polarity & Test Distance : Horizontal at 3 m

No	Frequency (MHz)	Emission Level (dBuV/m)	Limit (dBuV/m)	Margin (dB)	Antenna Height (m)	Table Angle (Degree)	Raw Value (dBuV)	Correction Factor (dB/m)
1	2390.00	69.1 PK	74.0	-4.9	1.00 H	261	37.9	31.2
2	2390.00	53.6 AV	54.0	-0.4	1.00 H	261	22.4	31.2
3	*2412.00	113.6 PK			1.00 H	261	82.4	31.2
4	*2412.00	100.1 AV			1.00 H	261	68.9	31.2
5	4824.00	50.7 PK	74.0	-23.3	3.48 H	286	48.7	2.0
6	4824.00	39.1 AV	54.0	-14.9	3.48 H	286	37.1	2.0

Antenna Polarity & Test Distance : Vertical at 3 m

No	Frequency (MHz)	Emission Level (dBuV/m)	Limit (dBuV/m)	Margin (dB)	Antenna Height (m)	Table Angle (Degree)	Raw Value (dBuV)	Correction Factor (dB/m)
1	2390.00	64.2 PK	74.0	-9.8	3.68 V	339	33.0	31.2
2	2390.00	49.4 AV	54.0	-4.6	3.68 V	339	18.2	31.2
3	*2412.00	109.0 PK			3.68 V	339	77.8	31.2
4	*2412.00	95.7 AV			3.68 V	339	64.5	31.2
5	4824.00	47.6 PK	74.0	-26.4	3.96 V	178	45.6	2.0
6	4824.00	37.4 AV	54.0	-16.6	3.96 V	178	35.4	2.0

Remarks:

1. Emission Level(dBuV/m) = Raw Value(dBuV) + Correction Factor(dB/m)
2. Correction Factor(dB/m) = Antenna Factor(dB/m) + Cable Factor(dB) – Pre-Amplifier Factor(dB)
3. Margin value = Emission Level – Limit value
4. The other emission levels were very low against the limit.
5. " * ": Fundamental frequency.

RF Mode	TX 802.11ax (HE20)	Channel	CH 6 : 2437 MHz
Frequency Range	1GHz ~ 25GHz	Detector Function	Peak (PK) Average (AV)

Antenna Polarity & Test Distance : Horizontal at 3 m

No	Frequency (MHz)	Emission Level (dBuV/m)	Limit (dBuV/m)	Margin (dB)	Antenna Height (m)	Table Angle (Degree)	Raw Value (dBuV)	Correction Factor (dB/m)
1	*2437.00	119.6 PK			1.15 H	257	88.5	31.1
2	*2437.00	106.8 AV			1.15 H	257	75.7	31.1
3	4874.00	60.8 PK	74.0	-13.2	3.42 H	288	58.7	2.1
4	4874.00	47.2 AV	54.0	-6.8	3.42 H	288	45.1	2.1

Antenna Polarity & Test Distance : Vertical at 3 m

No	Frequency (MHz)	Emission Level (dBuV/m)	Limit (dBuV/m)	Margin (dB)	Antenna Height (m)	Table Angle (Degree)	Raw Value (dBuV)	Correction Factor (dB/m)
1	*2437.00	114.8 PK			3.57 V	346	83.7	31.1
2	*2437.00	101.7 AV			3.57 V	346	70.6	31.1
3	4874.00	57.8 PK	74.0	-16.2	3.92 V	188	55.7	2.1
4	4874.00	45.5 AV	54.0	-8.5	3.92 V	188	43.4	2.1

Remarks:

1. Emission Level(dBuV/m) = Raw Value(dBuV) + Correction Factor(dB/m)
2. Correction Factor(dB/m) = Antenna Factor(dB/m) + Cable Factor(dB) – Pre-Amplifier Factor(dB)
3. Margin value = Emission Level – Limit value
4. The other emission levels were very low against the limit.
5. " * ": Fundamental frequency.

RF Mode	TX 802.11ax (HE20)	Channel	CH 11 : 2462 MHz
Frequency Range	1GHz ~ 25GHz	Detector Function	Peak (PK) Average (AV)

Antenna Polarity & Test Distance : Horizontal at 3 m

No	Frequency (MHz)	Emission Level (dBuV/m)	Limit (dBuV/m)	Margin (dB)	Antenna Height (m)	Table Angle (Degree)	Raw Value (dBuV)	Correction Factor (dB/m)
1	*2462.00	112.2 PK			1.10 H	260	81.1	31.1
2	*2462.00	98.8 AV			1.10 H	260	67.7	31.1
3	2483.50	65.5 PK	74.0	-8.5	1.10 H	260	34.4	31.1
4	2483.50	53.3 AV	54.0	-0.7	1.10 H	260	22.2	31.1
5	4824.00	46.9 PK	74.0	-27.1	3.59 H	286	44.9	2.0
6	4824.00	37.1 AV	54.0	-16.9	3.59 H	286	35.1	2.0

Antenna Polarity & Test Distance : Vertical at 3 m

No	Frequency (MHz)	Emission Level (dBuV/m)	Limit (dBuV/m)	Margin (dB)	Antenna Height (m)	Table Angle (Degree)	Raw Value (dBuV)	Correction Factor (dB/m)
1	*2462.00	108.1 PK			4.00 V	344	77.0	31.1
2	*2462.00	94.8 AV			4.00 V	344	63.7	31.1
3	2483.50	60.3 PK	74.0	-13.7	4.00 V	344	29.2	31.1
4	2483.50	48.6 AV	54.0	-5.4	4.00 V	344	17.5	31.1
5	4924.00	44.4 PK	74.0	-29.6	3.67 V	216	42.2	2.2
6	4924.00	33.6 AV	54.0	-20.4	3.67 V	216	31.4	2.2

Remarks:

1. Emission Level(dBuV/m) = Raw Value(dBuV) + Correction Factor(dB/m)
2. Correction Factor(dB/m) = Antenna Factor(dB/m) + Cable Factor(dB) – Pre-Amplifier Factor(dB)
3. Margin value = Emission Level – Limit value
4. The other emission levels were very low against the limit.
5. " * ": Fundamental frequency.

RF Mode	TX 802.11ax (HE40)	Channel	CH 3 : 2422 MHz
Frequency Range	1GHz ~ 25GHz	Detector Function	Peak (PK) Average (AV)

Antenna Polarity & Test Distance : Horizontal at 3 m

No	Frequency (MHz)	Emission Level (dBuV/m)	Limit (dBuV/m)	Margin (dB)	Antenna Height (m)	Table Angle (Degree)	Raw Value (dBuV)	Correction Factor (dB/m)
1	2390.00	66.8 PK	74.0	-7.2	1.14 H	260	35.6	31.2
2	2390.00	53.1 AV	54.0	-0.9	1.14 H	260	21.9	31.2
3	*2422.00	107.0 PK			1.14 H	260	75.8	31.2
4	*2422.00	93.8 AV			1.14 H	260	62.6	31.2
5	4844.00	46.6 PK	74.0	-27.4	3.26 H	278	44.5	2.1
6	4844.00	39.1 AV	54.0	-14.9	3.26 H	278	37.0	2.1

Antenna Polarity & Test Distance : Vertical at 3 m

No	Frequency (MHz)	Emission Level (dBuV/m)	Limit (dBuV/m)	Margin (dB)	Antenna Height (m)	Table Angle (Degree)	Raw Value (dBuV)	Correction Factor (dB/m)
1	2390.00	59.1 PK	74.0	-14.9	3.98 V	331	27.9	31.2
2	2390.00	44.8 AV	54.0	-9.2	3.98 V	331	13.6	31.2
3	*2422.00	101.2 PK			3.98 V	331	70.0	31.2
4	*2422.00	86.9 AV			3.98 V	331	55.7	31.2
5	4844.00	46.6 PK	74.0	-27.4	3.26 V	278	44.5	2.1
6	4844.00	39.1 AV	54.0	-14.9	3.26 V	278	37.0	2.1

Remarks:

1. Emission Level(dBuV/m) = Raw Value(dBuV) + Correction Factor(dB/m)
2. Correction Factor(dB/m) = Antenna Factor(dB/m) + Cable Factor(dB) – Pre-Amplifier Factor(dB)
3. Margin value = Emission Level – Limit value
4. The other emission levels were very low against the limit.
5. " * ": Fundamental frequency.

RF Mode	TX 802.11ax (HE40)	Channel	CH 6 : 2437 MHz
Frequency Range	1GHz ~ 25GHz	Detector Function	Peak (PK) Average (AV)

Antenna Polarity & Test Distance : Horizontal at 3 m								
No	Frequency (MHz)	Emission Level (dBuV/m)	Limit (dBuV/m)	Margin (dB)	Antenna Height (m)	Table Angle (Degree)	Raw Value (dBuV)	Correction Factor (dB/m)
1	*2437.00	109.9 PK			1.14 H	258	78.8	31.1
2	*2437.00	97.1 AV			1.14 H	258	66.0	31.1
3	4874.00	47.2 PK	74.0	-26.8	3.28 H	289	45.1	2.1
4	4874.00	37.6 AV	54.0	-16.4	3.28 H	289	35.5	2.1
Antenna Polarity & Test Distance : Vertical at 3 m								
No	Frequency (MHz)	Emission Level (dBuV/m)	Limit (dBuV/m)	Margin (dB)	Antenna Height (m)	Table Angle (Degree)	Raw Value (dBuV)	Correction Factor (dB/m)
1	*2437.00	104.3 PK			4.00 V	342	73.2	31.1
2	*2437.00	92.1 AV			4.00 V	342	61.0	31.1
3	4874.00	44.4 PK	74.0	-29.6	3.92 V	184	42.3	2.1
4	4874.00	34.7 AV	54.0	-19.3	3.92 V	184	32.6	2.1

Remarks:

1. Emission Level(dBuV/m) = Raw Value(dBuV) + Correction Factor(dB/m)
2. Correction Factor(dB/m) = Antenna Factor(dB/m) + Cable Factor(dB) – Pre-Amplifier Factor(dB)
3. Margin value = Emission Level – Limit value
4. The other emission levels were very low against the limit.
5. " * ": Fundamental frequency.

RF Mode	TX 802.11ax (HE40)	Channel	CH 9 : 2452 MHz
Frequency Range	1GHz ~ 25GHz	Detector Function	Peak (PK) Average (AV)

Antenna Polarity & Test Distance : Horizontal at 3 m

No	Frequency (MHz)	Emission Level (dBuV/m)	Limit (dBuV/m)	Margin (dB)	Antenna Height (m)	Table Angle (Degree)	Raw Value (dBuV)	Correction Factor (dB/m)
1	*2452.00	107.8 PK			1.05 H	255	76.7	31.1
2	*2452.00	94.0 AV			1.05 H	255	62.9	31.1
3	2483.50	66.8 PK	74.0	-7.2	1.05 H	255	35.7	31.1
4	2483.50	53.2 AV	54.0	-0.8	1.05 H	255	22.1	31.1
5	4904.00	46.0 PK	74.0	-28.0	3.41 H	286	44.0	2.0
6	4904.00	37.8 AV	54.0	-16.2	3.41 H	286	35.8	2.0

Antenna Polarity & Test Distance : Vertical at 3 m

No	Frequency (MHz)	Emission Level (dBuV/m)	Limit (dBuV/m)	Margin (dB)	Antenna Height (m)	Table Angle (Degree)	Raw Value (dBuV)	Correction Factor (dB/m)
1	*2452.00	103.6 PK			4.00 V	345	72.5	31.1
2	*2452.00	90.4 AV			4.00 V	345	59.3	31.1
3	2483.50	60.2 PK	74.0	-13.8	4.00 V	345	29.1	31.1
4	2483.50	49.1 AV	54.0	-4.9	4.00 V	345	18.0	31.1
5	4904.00	44.3 PK	74.0	-29.7	3.96 V	188	42.3	2.0
6	4904.00	34.8 AV	54.0	-19.2	3.96 V	188	32.8	2.0

Remarks:

1. Emission Level(dBuV/m) = Raw Value(dBuV) + Correction Factor(dB/m)
2. Correction Factor(dB/m) = Antenna Factor(dB/m) + Cable Factor(dB) – Pre-Amplifier Factor(dB)
3. Margin value = Emission Level – Limit value
4. The other emission levels were very low against the limit.
5. " * ": Fundamental frequency.

30 MHz ~ 1 GHz Worst-Case Data:

RF Mode	TX 802.11g	Channel	CH 6 : 2437 MHz
Frequency Range	30MHz ~ 1GHz	Detector Function	Quasi-Peak (QP)

Antenna Polarity & Test Distance : Horizontal at 3 m								
No	Frequency (MHz)	Emission Level (dBuV/m)	Limit (dBuV/m)	Margin (dB)	Antenna Height (m)	Table Angle (Degree)	Raw Value (dBuV)	Correction Factor (dB/m)
1	32.91	27.8 QP	40.0	-12.2	1.25 H	93	38.2	-10.4
2	54.25	33.0 QP	40.0	-7.0	1.00 H	319	42.2	-9.2
3	112.45	28.7 QP	43.5	-14.8	2.00 H	280	40.1	-11.4
4	331.67	34.2 QP	46.0	-11.8	1.25 H	149	40.2	-6.0
5	377.26	33.3 QP	46.0	-12.7	1.50 H	251	38.3	-5.0
6	548.95	33.0 QP	46.0	-13.0	1.00 H	68	34.9	-1.9

Remarks:

1. Emission Level(dBuV/m) = Raw Value(dBuV) + Correction Factor(dB/m)
2. Correction Factor(dB/m) = Antenna Factor(dB/m) + Cable Factor(dB) – Pre-Amplifier Factor(dB)
3. Margin value = Emission Level – Limit value
4. The other emission levels were very low against the limit of frequency range 30MHz~1000MHz.
5. The emission levels were very low against the limit of frequency range 9kHz~30MHz: the amplitude of spurious emissions attenuated more than 20 dB below the permissible value to be report.

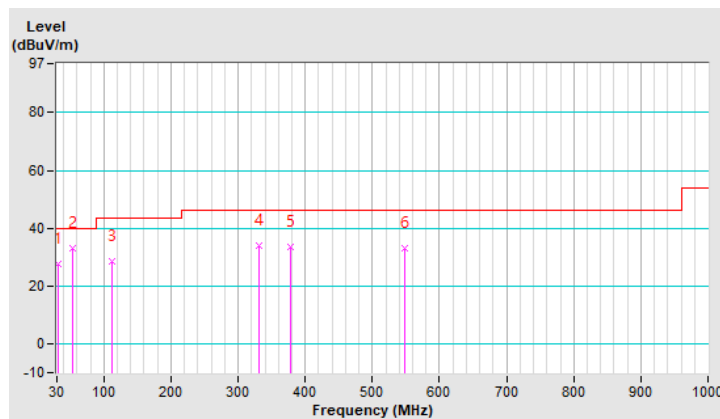

RF Mode	TX 802.11g	Channel	CH 6 : 2437 MHz
Frequency Range	30MHz ~ 1GHz	Detector Function	Quasi-Peak (QP)

Antenna Polarity & Test Distance : Vertical at 3 m								
No	Frequency (MHz)	Emission Level (dBuV/m)	Limit (dBuV/m)	Margin (dB)	Antenna Height (m)	Table Angle (Degree)	Raw Value (dBuV)	Correction Factor (dB/m)
1	30.97	31.7 QP	40.0	-8.3	1.25 V	182	42.3	-10.6
2	55.22	36.4 QP	40.0	-3.6	1.00 V	343	45.4	-9.0
3	112.45	29.2 QP	43.5	-14.3	1.50 V	42	40.6	-11.4
4	334.58	33.4 QP	46.0	-12.6	2.00 V	184	39.4	-6.0
5	420.91	32.7 QP	46.0	-13.3	1.50 V	155	36.9	-4.2
6	517.91	33.1 QP	46.0	-12.9	1.00 V	54	35.4	-2.3

Remarks:

1. Emission Level(dBuV/m) = Raw Value(dBuV) + Correction Factor(dB/m)
2. Correction Factor(dB/m) = Antenna Factor(dB/m) + Cable Factor(dB) – Pre-Amplifier Factor(dB)
3. Margin value = Emission Level – Limit value
4. The other emission levels were very low against the limit of frequency range 30MHz~1000MHz.
5. The emission levels were very low against the limit of frequency range 9kHz~30MHz: the amplitude of spurious emissions attenuated more than 20 dB below the permissible value to be report.

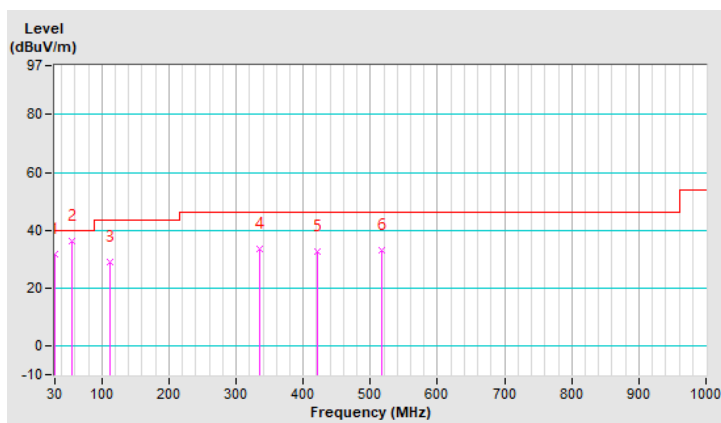

4.2 Conducted Emission Measurement

4.2.1 Limits of Conducted Emission Measurement

Frequency (MHz)	Conducted Limit (dBuV)	
	Quasi-Peak	Average
0.15 - 0.5	66 - 56	56 - 46
0.50 - 5.0	56	46
5.0 - 30.0	60	50

- Note: 1. The lower limit shall apply at the transition frequencies.
 2. The limit decreases in line with the logarithm of the frequency in the range of 0.15 to 0.50 MHz.

4.2.2 Test Instruments

Description & Manufacturer	Model No.	Serial No.	Date of Calibration	Due Date of Calibration
Test Receiver ROHDE & SCHWARZ	ESR3	102783	Dec. 21, 2020	Dec. 20, 2021
RF signal cable (with 10dB PAD) Woken	5D-FB	Cable-cond2-01	Sep. 04, 2020	Sep. 03, 2021
LISN ROHDE & SCHWARZ (EUT)	ESH2-Z5	100100	Jan. 18, 2021	Jan. 17, 2022
LISN ROHDE & SCHWARZ (Peripheral)	ESH3-Z5	100312	Aug. 18, 2020	Aug. 17, 2021
Software ADT	BV ADT_Cond_ V7.3.7.4	NA	NA	NA

- Note: 1. The calibration interval of the above test instruments is 12 months and the calibrations are traceable to NML/ROC and NIST/USA.
 2. The test was performed in HwaYa Shielded Room 2 (Conduction 2).
 3. The VCCI Site Registration No. is C-12047.

4.2.3 Test Procedures

- a. The EUT was placed 0.4 meters from the conducting wall of the shielded room with EUT being connected to the power mains through a line impedance stabilization network (LISN). Other support units were connected to the power mains through another LISN. The two LISNs provide 50 ohm/50 uH of coupling impedance for the measuring instrument.
- b. Both lines of the power mains connected to the EUT were checked for maximum conducted interference.
- c. The frequency range from 150 kHz to 30 MHz was searched. Emission levels under (Limit – 20 dB) was not recorded.

Note: The resolution bandwidth and video bandwidth of test receiver is 9 kHz for quasi-peak detection (QP) and average detection (AV) at frequency 0.15 MHz – 30 MHz.

4.2.4 Deviation from Test Standard

No deviation.

4.2.5 Test Setup

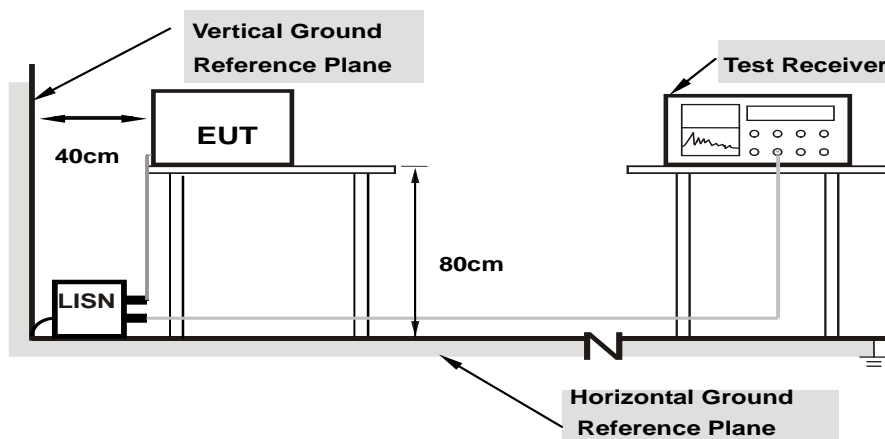

Note: 1.Support units were connected to second LISN.

For the actual test configuration, please refer to the attached file (Test Setup Photo).

4.2.6 EUT Operating Conditions

- a. Placed the EUT on a testing table.
- b. Use the software to control the EUT under transmission condition continuously at specific channel frequency.

4.2.7 Test Results

Frequency Range	150kHz ~ 30MHz	Detector Function & Resolution Bandwidth	Quasi-Peak (QP) / Average (AV), 9kHz
Input Power	120Vac, 60Hz	Environmental Conditions	23°C, 66%RH
Tested by	Rex Wang	Test Date	2021/1/25

Phase Of Power : Line (L)										
No	Frequency (MHz)	Correction Factor (dB)	Reading Value (dBuV)		Emission Level (dBuV)		Limit (dBuV)		Margin (dB)	
			Q.P.	AV.	Q.P.	AV.	Q.P.	AV.	Q.P.	AV.
1	0.16200	9.72	25.39	15.57	35.11	25.29	65.36	55.36	-30.25	-30.07
2	0.19469	9.75	23.32	16.54	33.07	26.29	63.83	53.83	-30.76	-27.54
3	3.65800	10.00	12.00	5.44	22.00	15.44	56.00	46.00	-34.00	-30.56
4	4.11000	10.01	15.99	8.88	26.00	18.89	56.00	46.00	-30.00	-27.11
5	17.05000	10.20	3.77	2.12	13.97	12.32	60.00	50.00	-46.03	-37.68
6	22.54600	10.26	10.93	3.43	21.19	13.69	60.00	50.00	-38.81	-36.31

Remarks:

1. Q.P. and AV. are abbreviations of quasi-peak and average individually.
2. The emission levels of other frequencies were very low against the limit.
3. Margin value = Emission level – Limit value
4. Correction factor = Insertion loss + Cable loss
5. Emission Level = Correction Factor + Reading Value

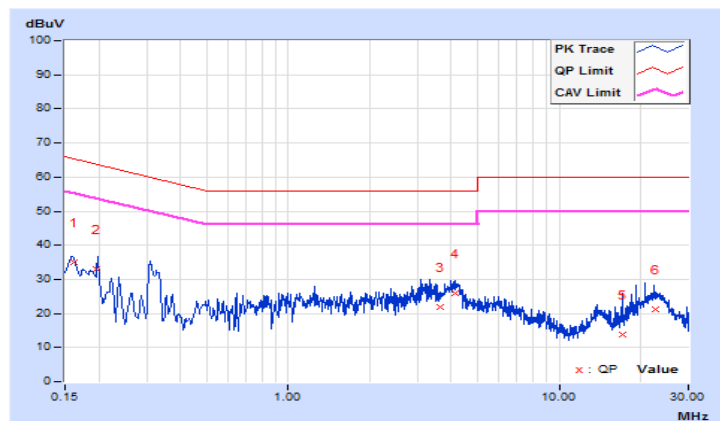

Frequency Range	150kHz ~ 30MHz	Detector Function & Resolution Bandwidth	Quasi-Peak (QP) / Average (AV), 9kHz
Input Power	120Vac, 60Hz	Environmental Conditions	23°C, 66%RH
Tested by	Rex Wang	Test Date	2021/1/25

Phase Of Power : Neutral (N)										
No	Frequency (MHz)	Correction Factor (dB)	Reading Value (dBuV)		Emission Level (dBuV)		Limit (dBuV)		Margin (dB)	
			Q.P.	AV.	Q.P.	AV.	Q.P.	AV.	Q.P.	AV.
1	0.15400	9.70	27.46	18.45	37.16	28.15	65.78	55.78	-28.62	-27.63
2	0.17615	9.72	25.53	17.58	35.25	27.30	64.67	54.67	-29.42	-27.37
3	0.31531	9.75	22.58	17.74	32.33	27.49	59.83	49.83	-27.50	-22.34
4	0.94594	9.84	15.14	6.14	24.98	15.98	56.00	46.00	-31.02	-30.02
5	3.19000	9.99	15.72	5.41	25.71	15.40	56.00	46.00	-30.29	-30.60
6	22.29000	10.32	10.38	2.90	20.70	13.22	60.00	50.00	-39.30	-36.78

Remarks:

1. Q.P. and AV. are abbreviations of quasi-peak and average individually.
2. The emission levels of other frequencies were very low against the limit.
3. Margin value = Emission level – Limit value
4. Correction factor = Insertion loss + Cable loss
5. Emission Level = Correction Factor + Reading Value

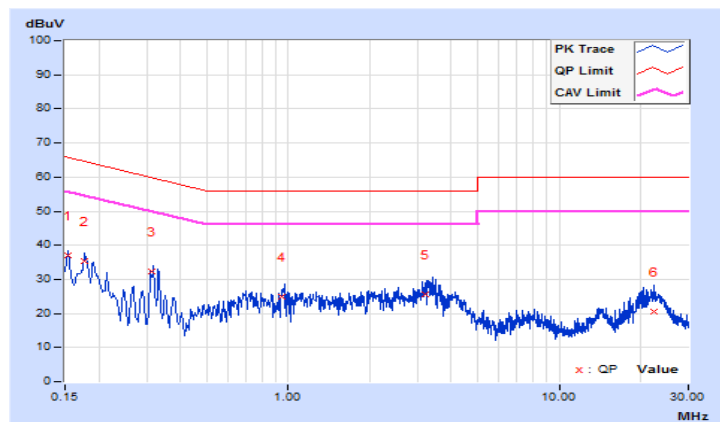

4.3 6 dB Bandwidth Measurement

4.3.1 Limits of 6 dB Bandwidth Measurement

The minimum of 6 dB Bandwidth Measurement is 0.5 MHz.

4.3.2 Test Setup

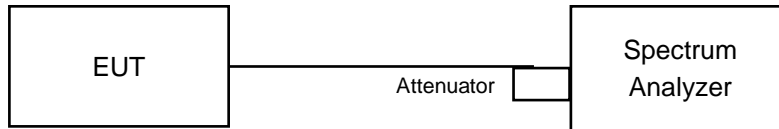

4.3.3 Test Instruments

Refer to section 4.1.2 to get information of above instrument.

4.3.4 Test Procedure

- Set resolution bandwidth (RBW) = 100 kHz
- Set the video bandwidth (VBW) $\geq 3 \times$ RBW, Detector = Peak.
- Trace mode = max hold.
- Sweep = auto couple.
- Measure the maximum width of the emission that is constrained by the frequencies associated with the two amplitude points (upper and lower) that are attenuated by 6 dB relative to the maximum level measured in the fundamental emission

4.3.5 Deviation from Test Standard

No deviation.

4.3.6 EUT Operating Conditions

The software provided by client to enable the EUT under transmission condition continuously at lowest, middle and highest channel frequencies individually.

4.3.7 Test Results

802.11b

Channel	Frequency (MHz)	6 dB Bandwidth (MHz)		Minimum Limit (MHz)	Pass / Fail
		Chain 0	Chain 1		
1	2412	8.11	8.11	0.5	Pass
6	2437	8.11	8.04	0.5	Pass
11	2462	8.06	8.07	0.5	Pass

802.11g

Channel	Frequency (MHz)	6 dB Bandwidth (MHz)		Minimum Limit (MHz)	Pass / Fail
		Chain 0	Chain 1		
1	2412	15.83	16.11	0.5	Pass
6	2437	16.34	16.34	0.5	Pass
11	2462	15.83	16.33	0.5	Pass

802.11ax (HE20)

Channel	Frequency (MHz)	6 dB Bandwidth (MHz)		Minimum Limit (MHz)	Pass / Fail
		Chain 0	Chain 1		
1	2412	18.67	18.66	0.5	Pass
6	2437	18.86	18.46	0.5	Pass
11	2462	18.54	18.71	0.5	Pass

802.11ax (HE40)

Channel	Frequency (MHz)	6 dB Bandwidth (MHz)		Minimum Limit (MHz)	Pass / Fail
		Chain 0	Chain 1		
3	2422	37.79	37.76	0.5	Pass
6	2437	38.00	38.09	0.5	Pass
9	2452	37.84	37.45	0.5	Pass

Spectrum Plot of Worst Value

802.11b

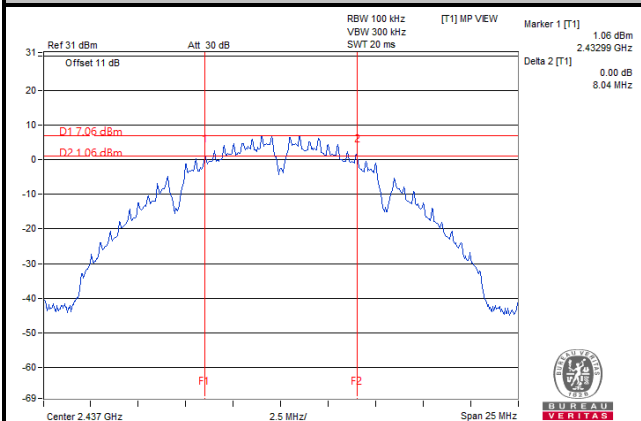

802.11g

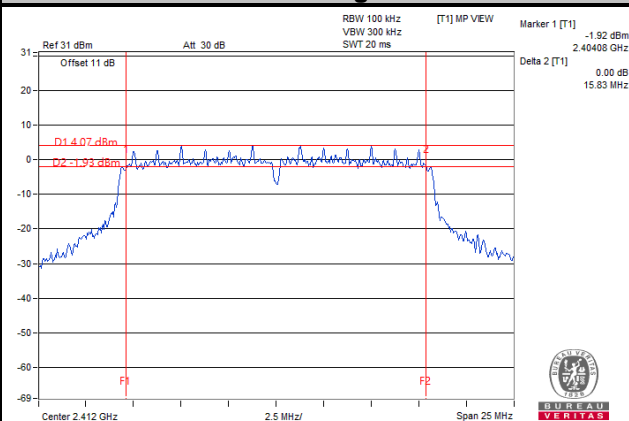

802.11ax (HE20)

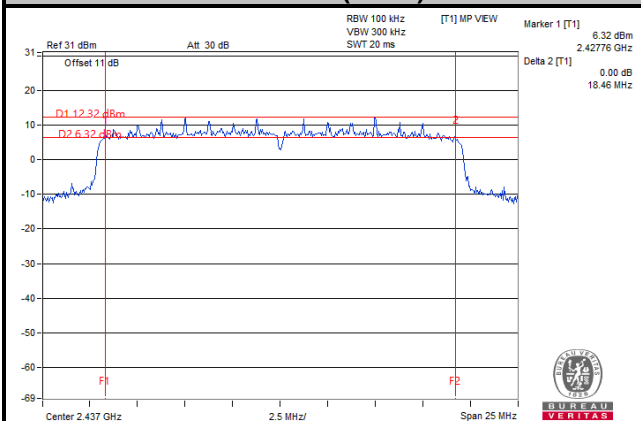

802.11ax (HE40)

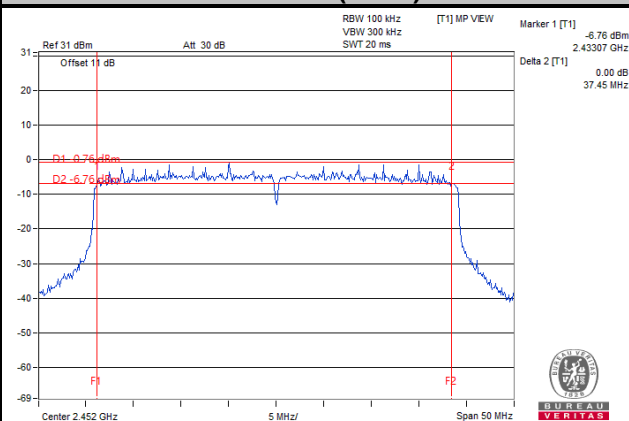

4.4 Occupied Bandwidth Measurement

4.4.1 Test Setup

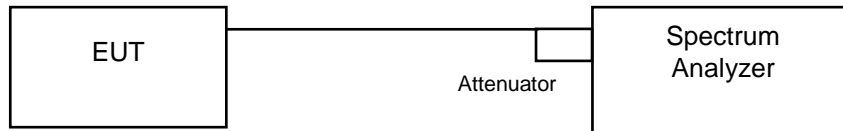

4.4.2 Test Instruments

Refer to section 4.1.2 to get information of above instrument.

4.4.3 Test Procedure

The transmitter output was connected to the spectrum analyzer through an attenuator. The bandwidth of the fundamental frequency was measured by spectrum analyzer with resolution bandwidth in the range of 1 % to 5 % of the anticipated emission bandwidth, and a video bandwidth at least 3x the resolution bandwidth and set the detector to sampling. The width of a frequency band such that, below the lower and above the upper frequency limits, the mean powers emitted are each equal to a specified percentage 0.5 % of the total mean power of a given emission.

4.4.4 Deviation from Test Standard

No deviation.

4.4.5 EUT Operating Conditions

The software provided by client to enable the EUT under transmission condition continuously at lowest, middle and highest channel frequencies individually.

4.4.6 Test Results

802.11b

Channel	Frequency (MHz)	Occupied Bandwidth (MHz)		Pass / Fail
		Chain 0	Chain 1	
1	2412	13.14	13.14	Pass
6	2437	13.08	13.08	Pass
11	2462	13.56	13.32	Pass

802.11g

Channel	Frequency (MHz)	Occupied Bandwidth (MHz)		Pass / Fail
		Chain 0	Chain 1	
1	2412	16.44	16.44	Pass
6	2437	24.12	24.60	Pass
11	2462	16.44	16.44	Pass

802.11ax (HE20)

Channel	Frequency (MHz)	Occupied Bandwidth (MHz)		Pass / Fail
		Chain 0	Chain 1	
1	2412	19.08	18.96	Pass
6	2437	22.20	21.66	Pass
11	2462	19.08	18.96	Pass

802.11ax (HE40)

Channel	Frequency (MHz)	Occupied Bandwidth (MHz)		Pass / Fail
		Chain 0	Chain 1	
3	2422	37.92	37.92	Pass
6	2437	38.64	38.52	Pass
9	2452	38.04	38.04	Pass

Spectrum Plot of Worst Value

802.11b

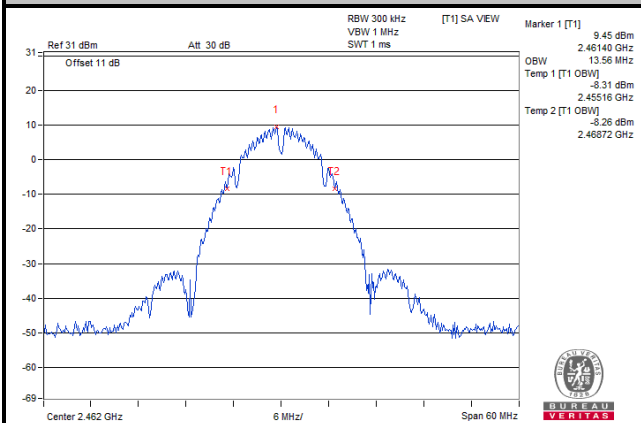

802.11g

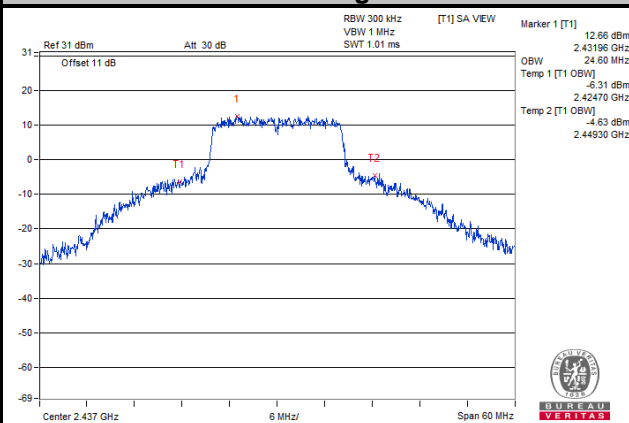

802.11ax (HE20)

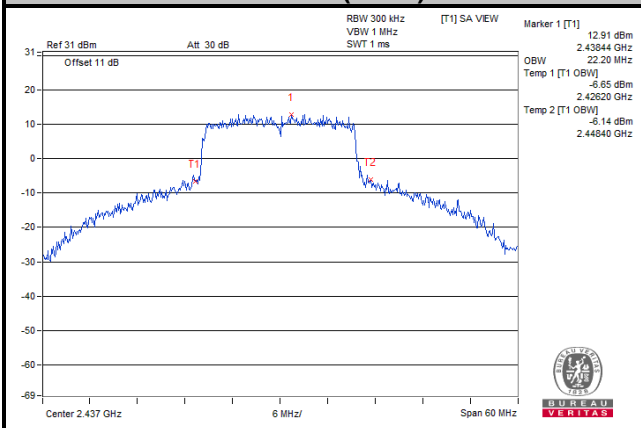

802.11ax (HE40)

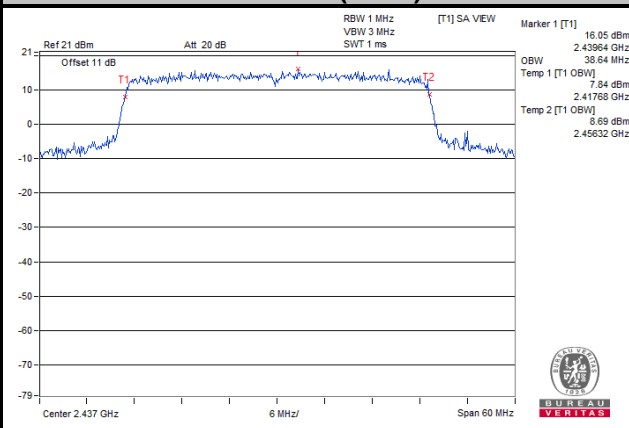

4.5 Conducted Output Power Measurement

4.5.1 Limits of Conducted Output Power Measurement

For systems using digital modulation in the 2400–2483.5 MHz bands: 1 Watt (30 dBm)

Per KDB 662911 D01 Multiple Transmitter Output Method of conducted output power measurement on IEEE 802.11 devices,

Array Gain = 0 dB (i.e., no array gain) for NANT \leq 4;

Array Gain = 0 dB (i.e., no array gain) for channel widths \geq 40 MHz for any NANT;

Array Gain = $5 \log(\text{NANT}/\text{NSS})$ dB or 3 dB, whichever is less for 20 MHz channel widths with NANT \geq 5.

For power measurements on all other devices: Array Gain = $10 \log(\text{NANT}/\text{NSS})$ dB.

4.5.2 Test Setup

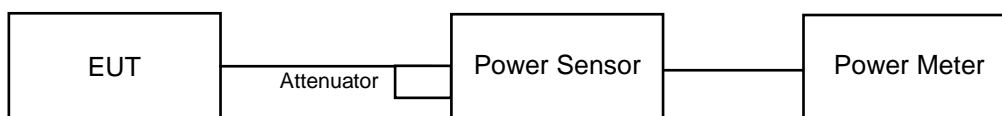

4.5.3 Test Instruments

Refer to section 4.1.2 to get information of above instrument.

4.5.4 Test Procedures

Average power sensor was used to perform output power measurement, trigger and gating function of wide band power meter is enabled to measure max output power of TX on burst. Duty factor is not added to measured value.

4.5.5 Deviation from Test Standard

No deviation.

4.5.6 EUT Operating Conditions

The software provided by client to enable the EUT under transmission condition continuously at lowest, middle and highest channel frequencies individually.

4.5.7 Test Results

CDD Mode

802.11b

Channel	Frequency (MHz)	Average Power (dBm)		Total Power (mW)	Total Power (dBm)	Limit (dBm)	Pass / Fail
		Chain 0	Chain 1				
1	2412	14.96	15.82	69.527	18.42	30	Pass
6	2437	14.89	15.74	68.329	18.35	30	Pass
11	2462	17.91	18.76	136.964	21.37	30	Pass

802.11g

Channel	Frequency (MHz)	Average Power (dBm)		Total Power (mW)	Total Power (dBm)	Limit (dBm)	Pass / Fail
		Chain 0	Chain 1				
1	2412	14.93	15.88	69.843	18.44	30	Pass
6	2437	22.64	23.13	389.243	25.90	30	Pass
11	2462	14.84	15.78	68.323	18.35	30	Pass

802.11n (HT20)

Channel	Frequency (MHz)	Average Power (dBm)		Total Power (mW)	Total Power (dBm)	Limit (dBm)	Pass / Fail
		Chain 0	Chain 1				
1	2412	15.28	16.36	76.98	18.86	30	Pass
6	2437	22.34	22.87	365.038	25.62	30	Pass
11	2462	13.58	14.45	50.665	17.05	30	Pass

802.11n (HT40)

Channel	Frequency (MHz)	Average Power (dBm)		Total Power (mW)	Total Power (dBm)	Limit (dBm)	Pass / Fail
		Chain 0	Chain 1				
3	2422	11.36	12.21	30.311	14.82	30	Pass
6	2437	21.55	22.48	319.9	25.05	30	Pass
9	2452	12.22	13.01	36.671	15.64	30	Pass

802.11n (VHT20)

Channel	Frequency (MHz)	Average Power (dBm)		Total Power (mW)	Total Power (dBm)	Limit (dBm)	Pass / Fail
		Chain 0	Chain 1				
1	2412	15.31	16.40	77.614	18.90	30	Pass
6	2437	22.37	22.91	368.018	25.66	30	Pass
11	2462	13.62	14.48	51.069	17.08	30	Pass

802.11n (VHT40)

Channel	Frequency (MHz)	Average Power (dBm)		Total Power (mW)	Total Power (dBm)	Limit (dBm)	Pass / Fail
		Chain 0	Chain 1				
3	2422	11.39	12.24	30.522	14.85	30	Pass
6	2437	21.57	22.52	322.198	25.08	30	Pass
9	2452	12.24	13.04	36.887	15.67	30	Pass

802.11ax (HE20)

Channel	Frequency (MHz)	Average Power (dBm)		Total Power (mW)	Total Power (dBm)	Limit (dBm)	Pass / Fail
		Chain 0	Chain 1				
1	2412	15.34	16.43	78.152	18.93	30	Pass
6	2437	22.40	22.96	371.477	25.70	30	Pass
11	2462	13.66	14.51	51.476	17.12	30	Pass

802.11ax (HE40)

Channel	Frequency (MHz)	Average Power (dBm)		Total Power (mW)	Total Power (dBm)	Limit (dBm)	Pass / Fail
		Chain 0	Chain 1				
3	2422	11.42	12.26	30.694	14.87	30	Pass
6	2437	21.60	22.54	324.017	25.11	30	Pass
9	2452	12.27	13.07	37.142	15.70	30	Pass

Beamforming Mode

802.11n (HT20)

Channel	Frequency (MHz)	Average Power (dBm)		Total Power (mW)	Total Power (dBm)	Limit (dBm)	Pass / Fail
		Chain 0	Chain 1				
1	2412	12.27	13.35	38.493	15.85	29.49	Pass
6	2437	19.33	19.86	182.532	22.61	29.49	Pass
11	2462	10.57	11.44	25.334	14.04	29.49	Pass

NOTE: Directional gain = 6.51 dBi > 6dBi, so the output power limit shall be reduced to $30-(6.51-6) = 29.49$ dBm.

802.11n (HT40)

Channel	Frequency (MHz)	Average Power (dBm)		Total Power (mW)	Total Power (dBm)	Limit (dBm)	Pass / Fail
		Chain 0	Chain 1				
3	2422	8.35	9.20	15.157	11.81	29.49	Pass
6	2437	18.54	19.47	159.961	22.04	29.49	Pass
9	2452	9.21	10.00	18.337	12.63	29.49	Pass

NOTE: Directional gain = 6.51 dBi > 6dBi, so the output power limit shall be reduced to $30-(6.51-6) = 29.49$ dBm.

802.11n (VHT20)

Channel	Frequency (MHz)	Average Power (dBm)		Total Power (mW)	Total Power (dBm)	Limit (dBm)	Pass / Fail
		Chain 0	Chain 1				
1	2412	12.30	13.39	38.81	15.89	29.49	Pass
6	2437	19.36	19.90	184.022	22.65	29.49	Pass
11	2462	10.61	11.47	25.536	14.07	29.49	Pass

NOTE: Directional gain = 6.51 dBi > 6dBi, so the output power limit shall be reduced to $30-(6.51-6) = 29.49$ dBm.

802.11n (VHT40)

Channel	Frequency (MHz)	Average Power (dBm)		Total Power (mW)	Total Power (dBm)	Limit (dBm)	Pass / Fail
		Chain 0	Chain 1				
3	2422	8.38	9.23	15.262	11.84	29.49	Pass
6	2437	18.56	19.51	161.11	22.07	29.49	Pass
9	2452	9.23	10.03	18.445	12.66	29.49	Pass

NOTE: Directional gain = 6.51 dBi > 6dBi, so the output power limit shall be reduced to $30-(6.51-6) = 29.49$ dBm.

802.11ax (HE20)

Channel	Frequency (MHz)	Average Power (dBm)		Total Power (mW)	Total Power (dBm)	Limit (dBm)	Pass / Fail
		Chain 0	Chain 1				
1	2412	12.33	13.42	39.079	15.92	29.49	Pass
6	2437	19.39	19.95	185.751	22.69	29.49	Pass
11	2462	10.65	11.50	25.74	14.11	29.49	Pass

NOTE: Directional gain = 6.51 dBi > 6dBi, so the output power limit shall be reduced to $30-(6.51-6) = 29.49$ dBm.

802.11ax (HE40)

Channel	Frequency (MHz)	Average Power (dBm)		Total Power (mW)	Total Power (dBm)	Limit (dBm)	Pass / Fail
		Chain 0	Chain 1				
3	2422	8.41	9.25	15.348	11.86	29.49	Pass
6	2437	18.59	19.53	162.02	22.10	29.49	Pass
9	2452	9.26	10.06	18.572	12.69	29.49	Pass

NOTE: Directional gain = 6.51 dBi > 6dBi, so the output power limit shall be reduced to $30-(6.51-6) = 29.49$ dBm.

4.6 Power Spectral Density Measurement

4.6.1 Limits of Power Spectral Density Measurement

The Maximum of Power Spectral Density Measurement is 8 dBm in any 3 kHz band during any time interval of continuous transmission.

4.6.2 Test Setup

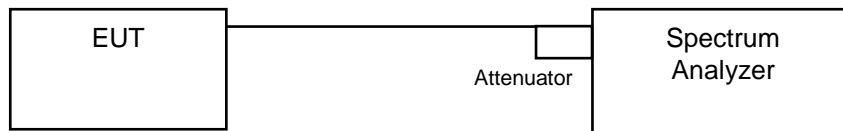

4.6.3 Test Instruments

Refer to section 4.1.2 to get information of above instrument.

4.6.4 Test Procedure

For Average Power (Duty cycle $\geq 98\%$)

- a. Set instrument center frequency to DTS channel center frequency.
- b. Set span to at least 1.5 times the OBW.
- c. Set RBW to: $3 \text{ kHz} \leq \text{RBW} \leq 100 \text{ kHz}$.
- d. Set VBW $\geq 3 \times \text{RBW}$.
- e. Detector = power averaging (RMS) or sample detector (when RMS not available).
- f. Ensure that the number of measurement points in the sweep $\geq 2 \times \text{span}/\text{RBW}$.
- g. Sweep time = auto couple.
- h. Employ trace averaging (RMS) mode over a minimum of 100 traces.
- i. Use the peak marker function to determine the maximum amplitude level.

For Average Power (Duty cycle $< 98\%$)

- a. Measure the duty cycle (x).
- b. Set instrument center frequency to DTS channel center frequency.
- c. Set span to at least 1.5 times the OBW.
- d. Set RBW to: $3 \text{ kHz} \leq \text{RBW} \leq 100 \text{ kHz}$.
- e. Set VBW $\geq 3 \times \text{RBW}$.
- f. Detector = power averaging (RMS) or sample detector (when RMS not available).
- g. Ensure that the number of measurement points in the sweep $\geq 2 \times \text{span}/\text{RBW}$.
- h. Sweep time = auto couple.
- i. Do not use sweep triggering. Allow sweep to "free run".
- j. Employ trace averaging (RMS) mode over a minimum of 100 traces.
- k. Use the peak marker function to determine the maximum amplitude level.
- l. Add $10 \log (1/x)$, where x is the duty cycle measured in step (a), to the measured PSD to compute the average PSD during the actual transmission time.

4.6.5 Deviation from Test Standard

No deviation.

4.6.6 EUT Operating Condition

The software provided by client to enable the EUT under transmission condition continuously at lowest, middle and highest channel frequencies individually.

4.6.7 Test Results

802.11b

TX Chain	Channel	Freq. (MHz)	PSD (dBm/3 kHz)	10 log (N=2) dB	Duty Factor (dB)	Total PSD (dBm/3 kHz)	Limit (dBm/3 kHz)	Pass / Fail
0	1	2412	-23.72	3.01	1.37	-19.34	7.49	Pass
	6	2437	-22.61	3.01	1.37	-18.23	7.49	Pass
	11	2462	-21.13	3.01	1.37	-16.75	7.49	Pass
1	1	2412	-23.24	3.01	1.37	-18.86	7.49	Pass
	6	2437	-22.71	3.01	1.37	-18.33	7.49	Pass
	11	2462	-19.55	3.01	1.37	-15.17	7.49	Pass

NOTE:

1. Directional gain = $3.5 \text{ dBi} + 10\log(2) = 6.51 \text{ dBi} > 6 \text{ dBi}$, so the power density limit shall be reduced to $8-(6.51-6) = 7.49 \text{ dBm}$.
2. Method 2) C) of power density measurement of KDB 662911 is using for calculating total power density.

802.11g

TX Chain	Channel	Freq. (MHz)	PSD (dBm/3 kHz)	10 log (N=2) dB	Duty Factor (dB)	Total PSD (dBm/3 kHz)	Limit (dBm/3 kHz)	Pass / Fail
0	1	2412	-22.51	3.01	0.29	-19.21	7.49	Pass
	6	2437	-15.03	3.01	0.29	-11.73	7.49	Pass
	11	2462	-22.07	3.01	0.29	-18.77	7.49	Pass
1	1	2412	-21.17	3.01	0.29	-17.87	7.49	Pass
	6	2437	-14.61	3.01	0.29	-11.31	7.49	Pass
	11	2462	-21.25	3.01	0.29	-17.95	7.49	Pass

NOTE:

1. Directional gain = $3.5 \text{ dBi} + 10\log(2) = 6.51 \text{ dBi} > 6 \text{ dBi}$, so the power density limit shall be reduced to $8-(6.51-6) = 7.49 \text{ dBm}$.
2. Method 2) C) of power density measurement of KDB 662911 is using for calculating total power density.

802.11ax (HE20)

TX Chain	Channel	Freq. (MHz)	PSD (dBm/3 kHz)	10 log (N=2) dB	Duty Factor (dB)	Total PSD (dBm/3 kHz)	Limit (dBm/3 kHz)	Pass / Fail
0	1	2412	-23.61	3.01	0.27	-20.33	7.49	Pass
	6	2437	-16.9	3.01	0.27	-13.62	7.49	Pass
	11	2462	-25.86	3.01	0.27	-22.58	7.49	Pass
1	1	2412	-23.34	3.01	0.27	-20.06	7.49	Pass
	6	2437	-16.56	3.01	0.27	-13.28	7.49	Pass
	11	2462	-24.88	3.01	0.27	-21.6	7.49	Pass

NOTE:

- Directional gain = $3.5 \text{ dBi} + 10\log(2) = 6.51 \text{ dBi} > 6 \text{ dBi}$, so the power density limit shall be reduced to $8 - (6.51 - 6) = 7.49 \text{ dBm}$.
- Method E) 2) c) of power density measurement of KDB 662911 is using for calculating total power density.

802.11ax (HE40)

TX Chain	Channel	Freq. (MHz)	PSD (dBm/3 kHz)	10 log (N=2) dB	Duty Factor (dB)	Total PSD (dBm/3 kHz)	Limit (dBm/3 kHz)	Pass / Fail
0	3	2422	-30.18	3.01	0.49	-26.68	7.49	Pass
	6	2437	-20.72	3.01	0.49	-17.22	7.49	Pass
	9	2452	-30.09	3.01	0.49	-26.59	7.49	Pass
1	3	2422	-29.45	3.01	0.49	-25.95	7.49	Pass
	6	2437	-19.85	3.01	0.49	-16.35	7.49	Pass
	9	2452	-28.82	3.01	0.49	-25.32	7.49	Pass

NOTE:

- Directional gain = $3.5 \text{ dBi} + 10\log(2) = 6.51 \text{ dBi} > 6 \text{ dBi}$, so the power density limit shall be reduced to $8 - (6.51 - 6) = 7.49 \text{ dBm}$.
- Method E) 2) c) of power density measurement of KDB 662911 is using for calculating total power density.

Spectrum Plot of Worst Value

802.11b

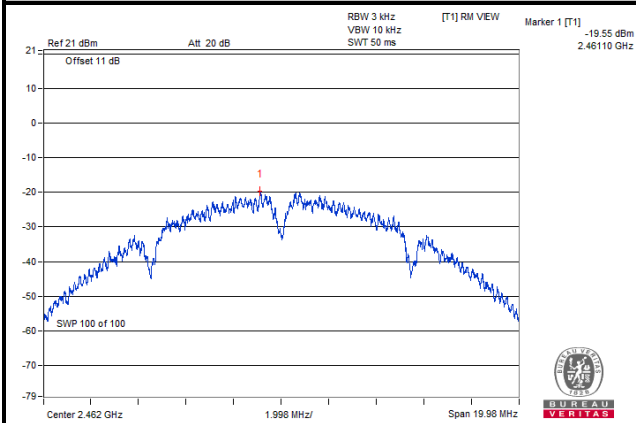

802.11g

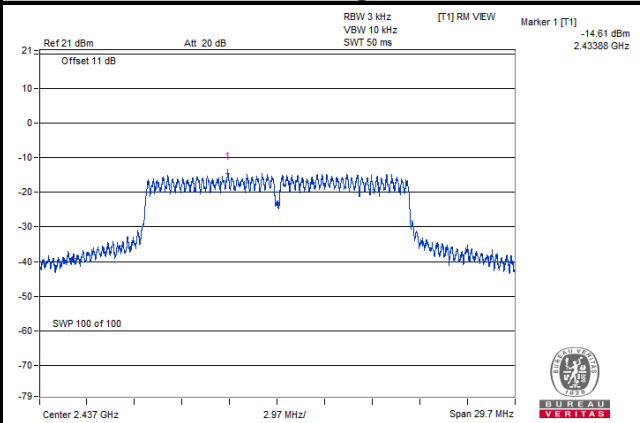

802.11ax (HE20)

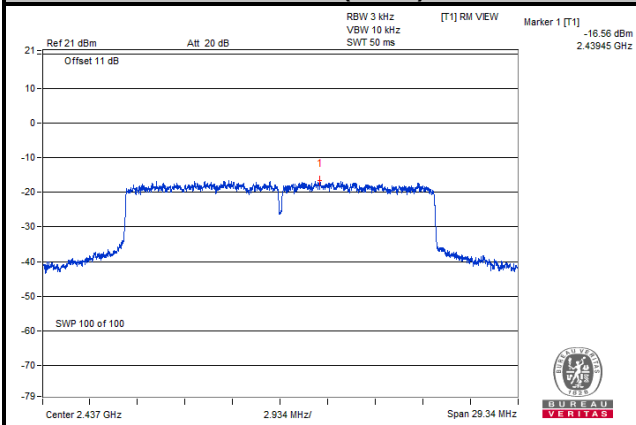

802.11ax (HE40)

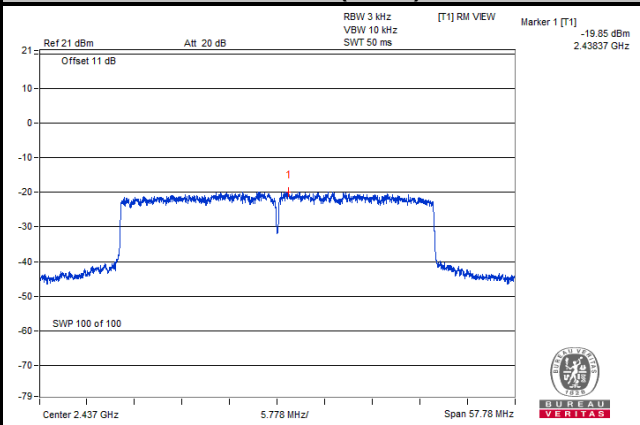

4.7 Conducted Out of Band Emission Measurement

4.7.1 Limits of Conducted Out of Band Emission Measurement

Below -30 dB of the highest emission level of operating band (in 100 kHz Resolution Bandwidth).

4.7.2 Test Setup

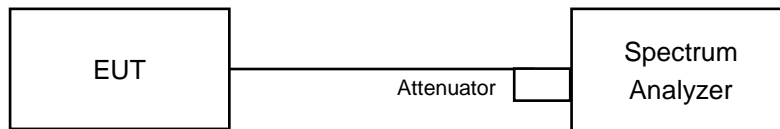

4.7.3 Test Instruments

Refer to section 4.1.2 to get information of above instrument.

4.7.4 Test Procedure

MEASUREMENT PROCEDURE REF

1. Set the RBW = 100 kHz.
2. Set the VBW \geq 300 kHz.
3. Detector = peak.
4. Sweep time = auto couple.
5. Trace mode = max hold.
6. Allow trace to fully stabilize.
7. Use the peak marker function to determine the maximum power level in any 100 kHz band segment within the fundamental EBW.

MEASUREMENT PROCEDURE OOB

1. Set RBW = 100 kHz.
2. Set VBW \geq 300 kHz.
3. Detector = peak.
4. Sweep = auto couple.
5. Trace Mode = max hold.
6. Allow trace to fully stabilize.
7. Use the peak marker function to determine the maximum amplitude level.

4.7.5 Deviation from Test Standard

No deviation.

4.7.6 EUT Operating Condition

The software provided by client to enable the EUT under transmission condition continuously at lowest, middle and highest channel frequencies individually.

4.7.7 Test Results

The spectrum plots are attached on the following images. D1 line indicates the highest level, and D2 line indicates the 30 dB offset below D1. It shows compliance with the requirement.

802.11b CHAIN 0

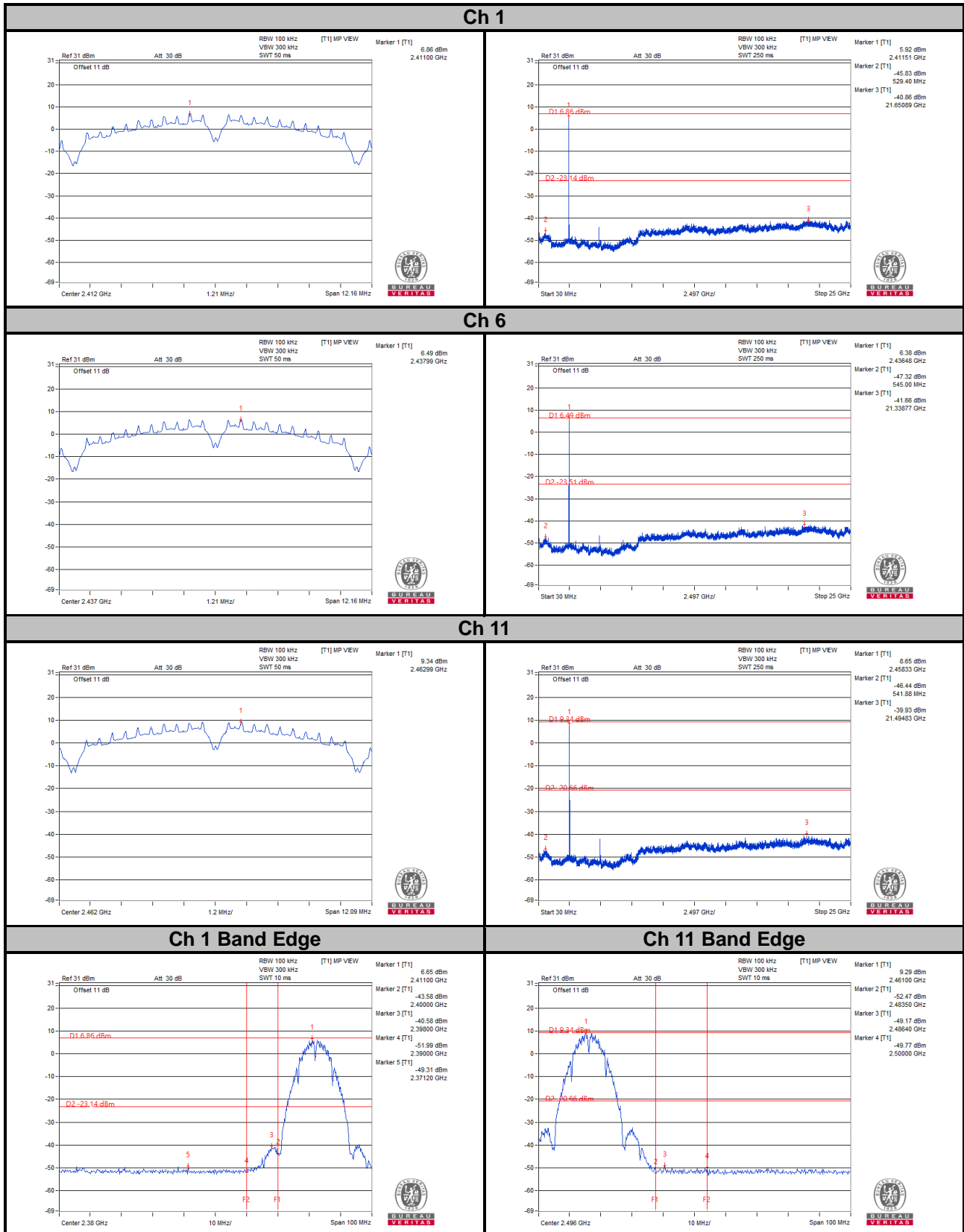

CHAIN 1

Ch 1

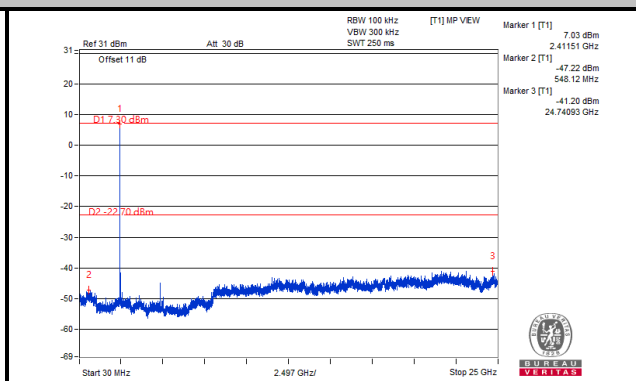
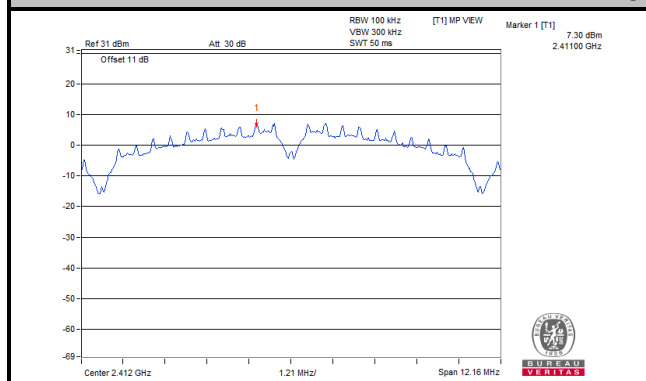

Ch 6

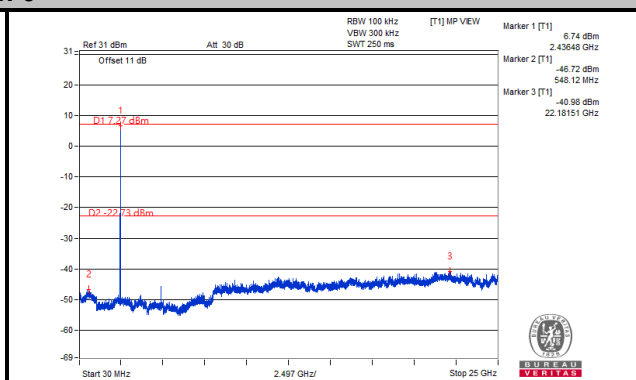
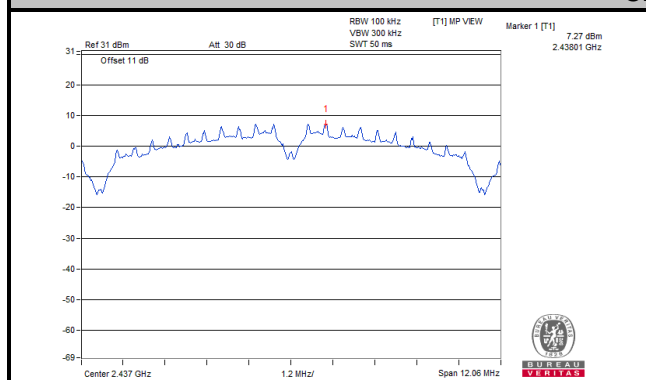

Ch 11

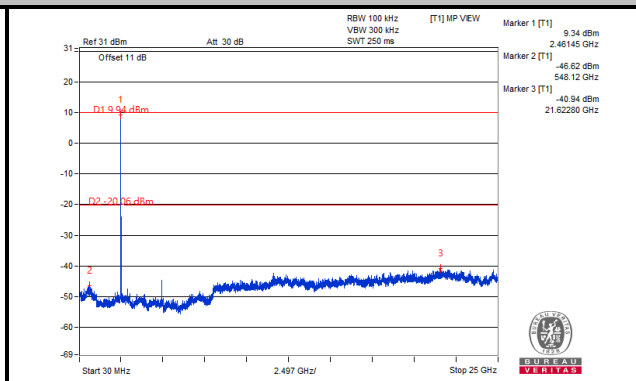
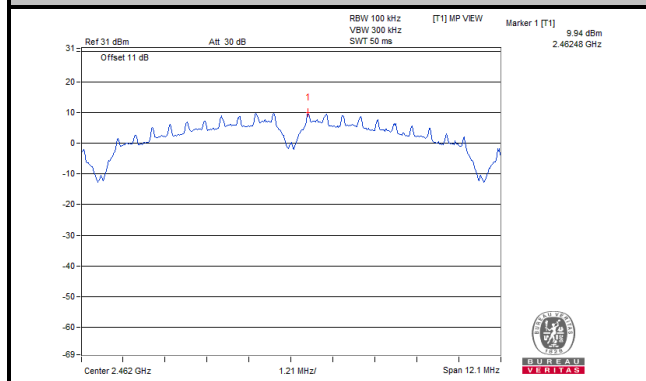

Ch 1 Band Edge

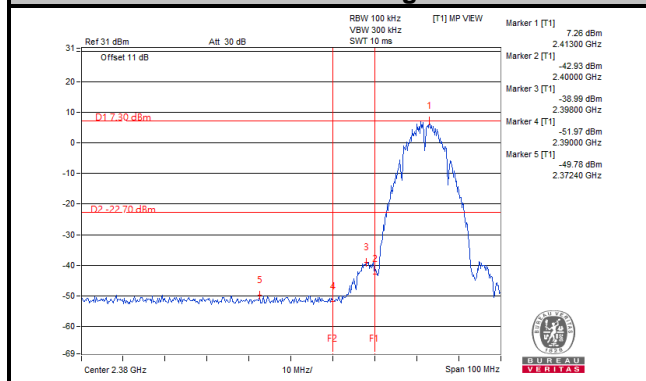

Ch 11 Band Edge

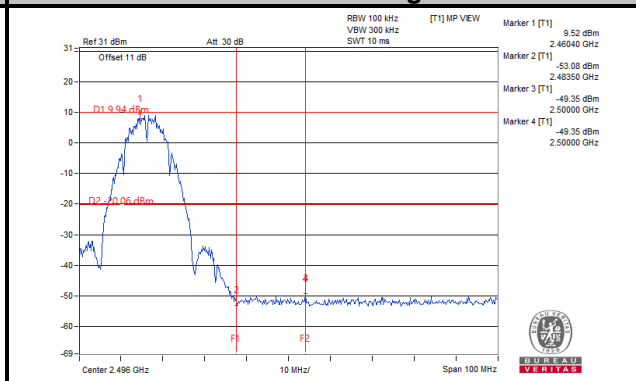

802.11g
CHAIN 0

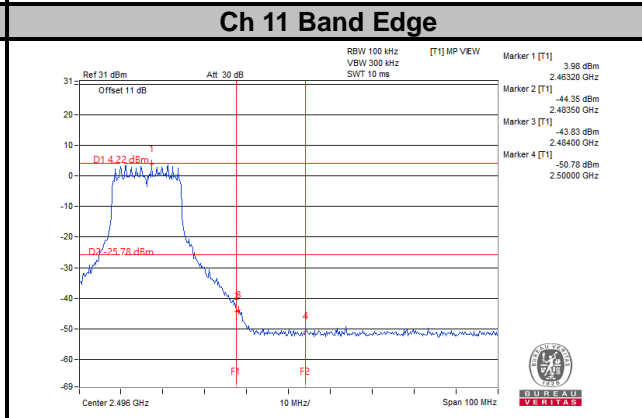
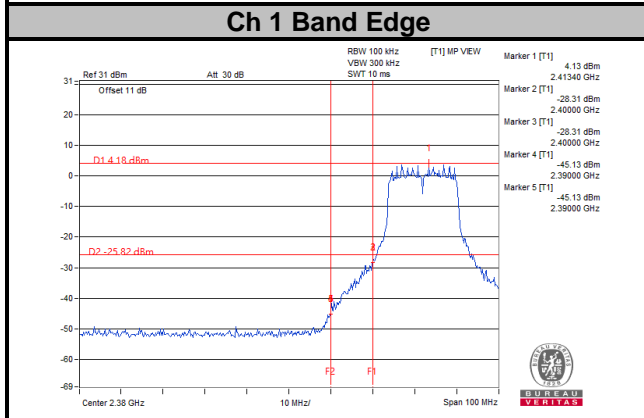
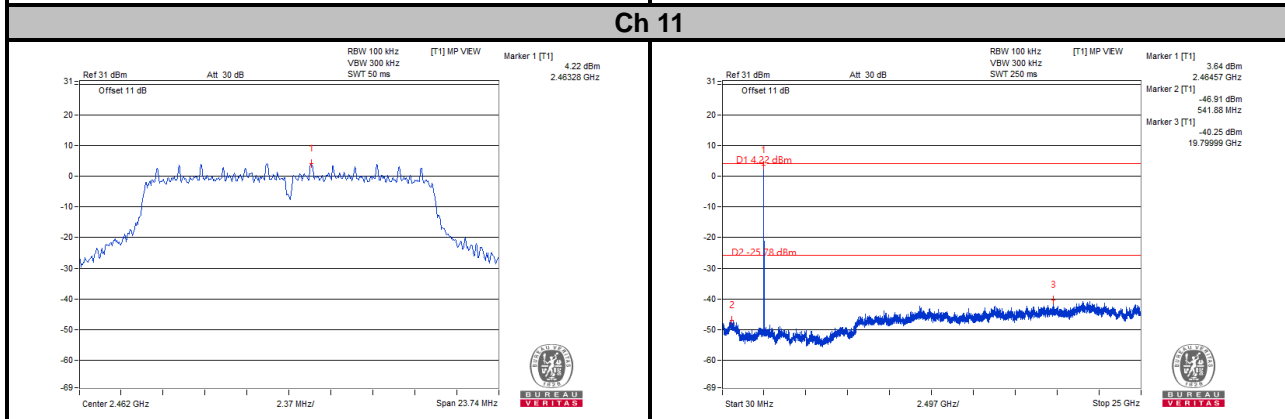
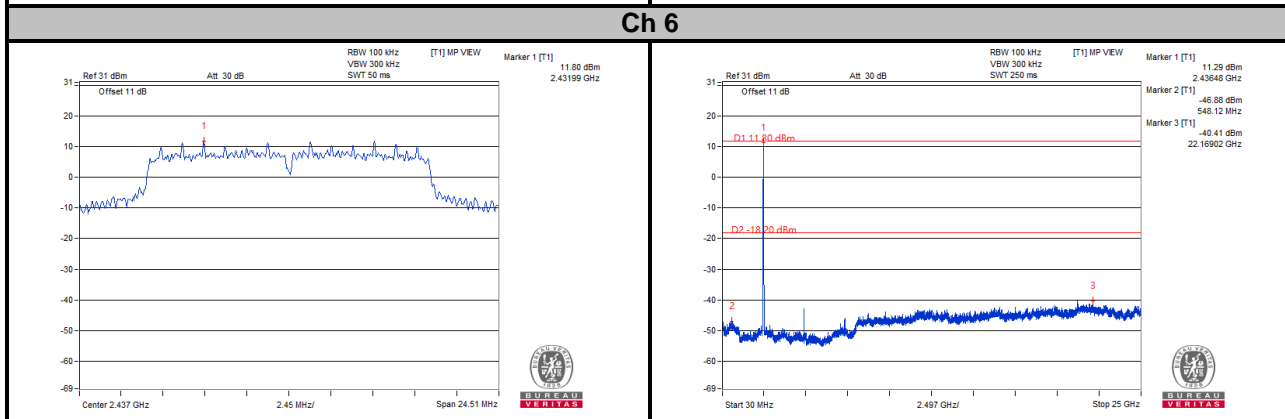
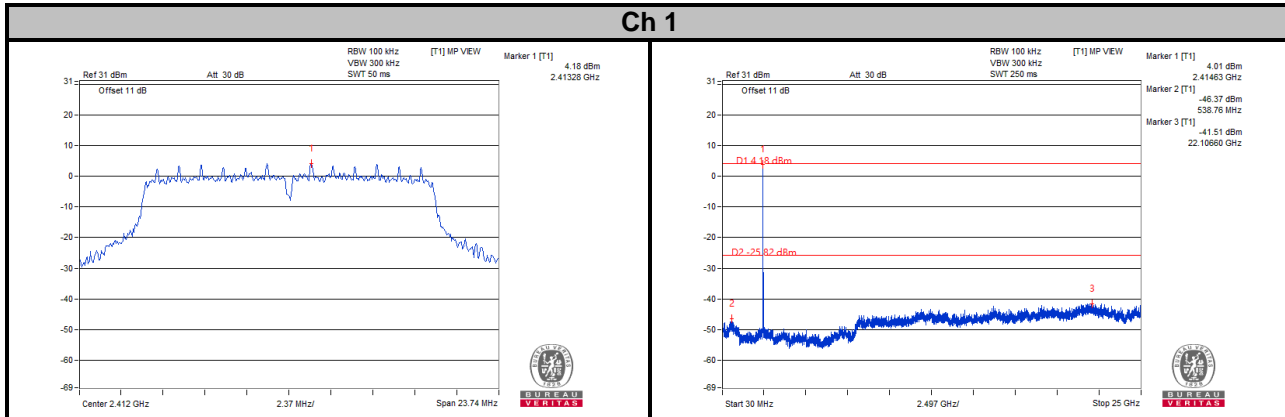

CHAIN 1

Ch 1

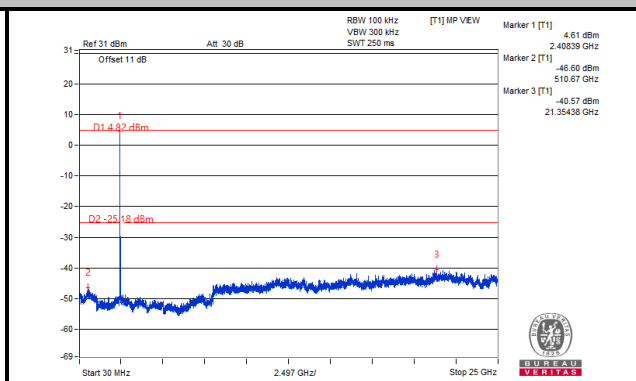
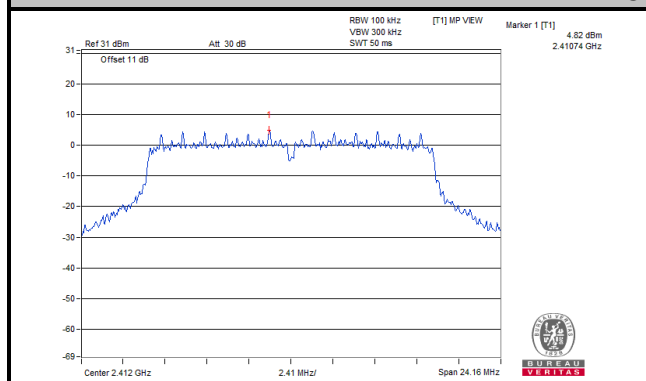

Ch 6

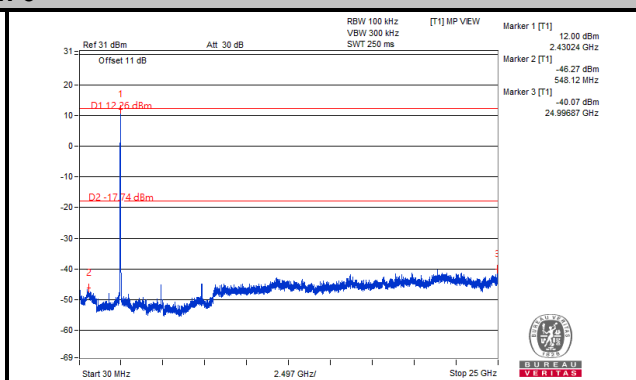
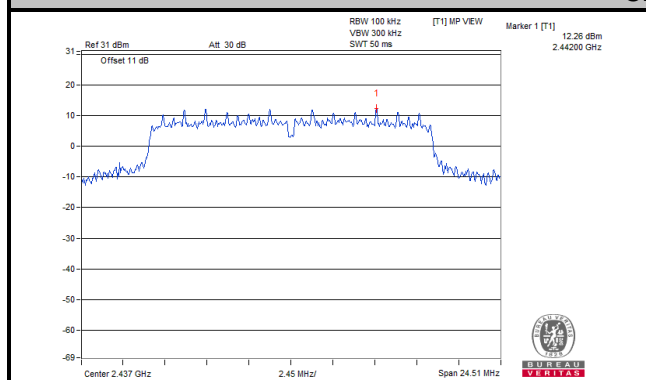

Ch 11

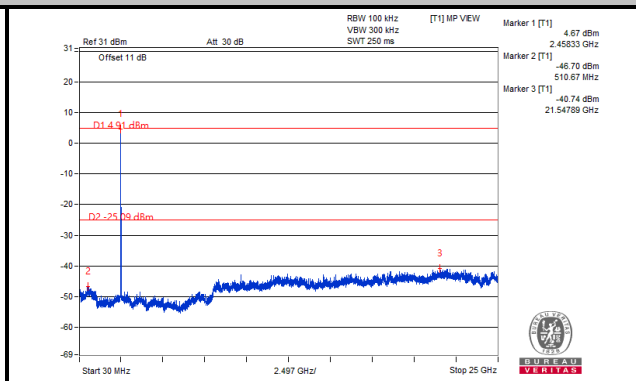
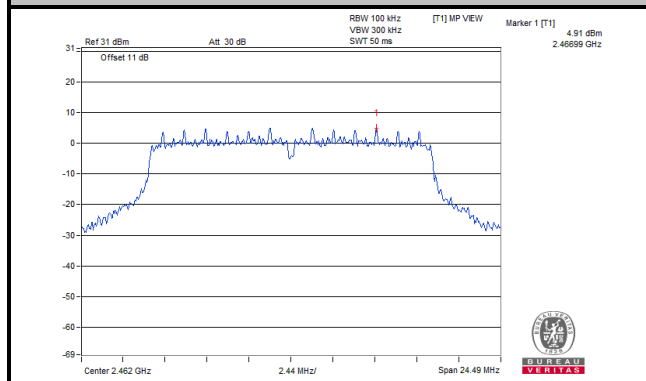

Ch 1 Band Edge

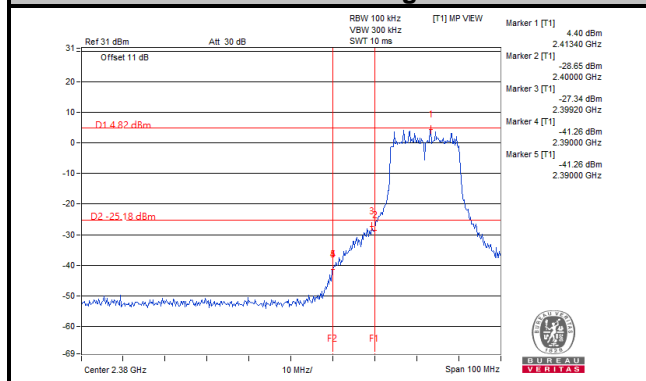

Ch 11 Band Edge

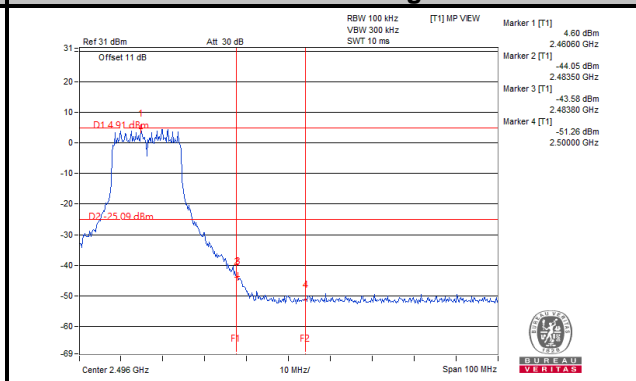

802.11ax (HE20)

Ch 1

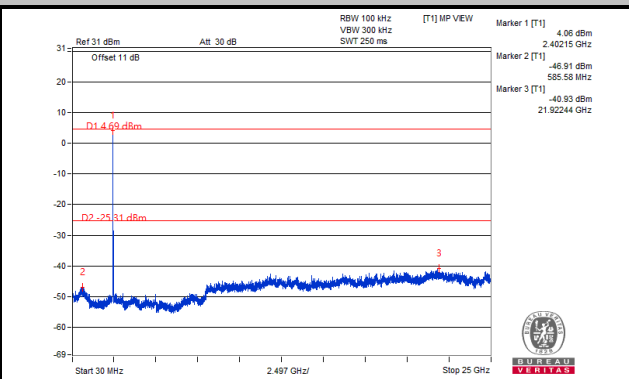
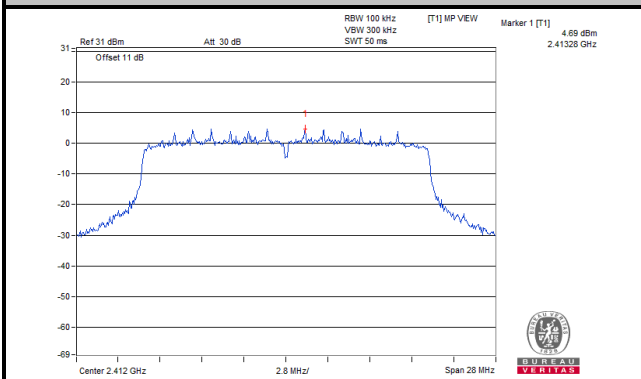

Ch 6

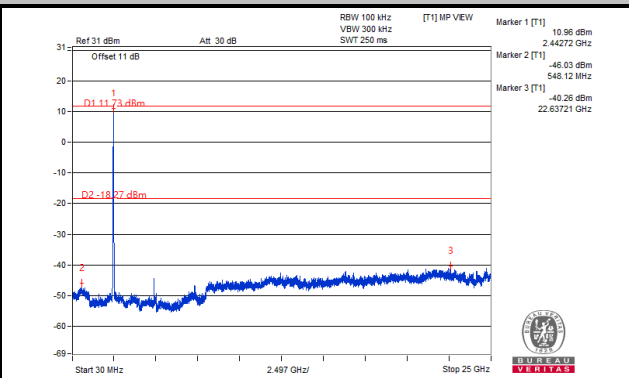
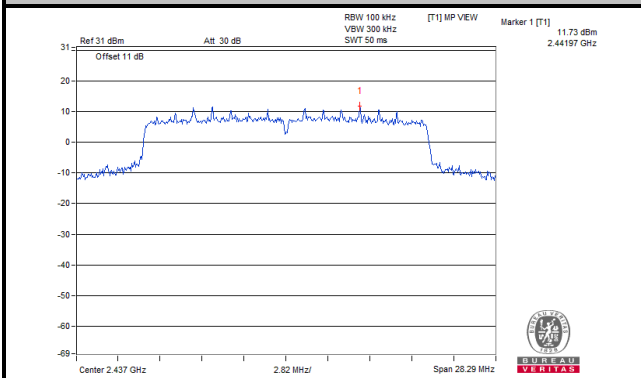

Ch 11

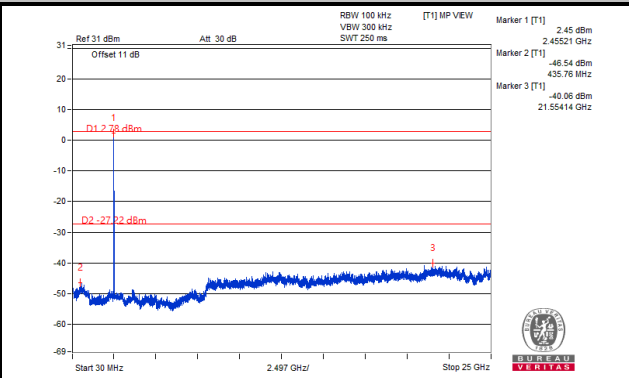
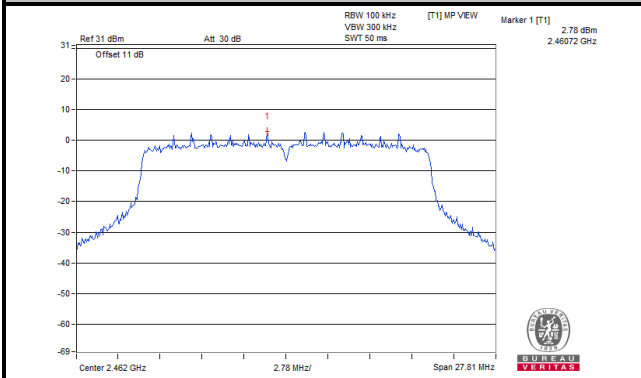

Ch 1 Band Edge

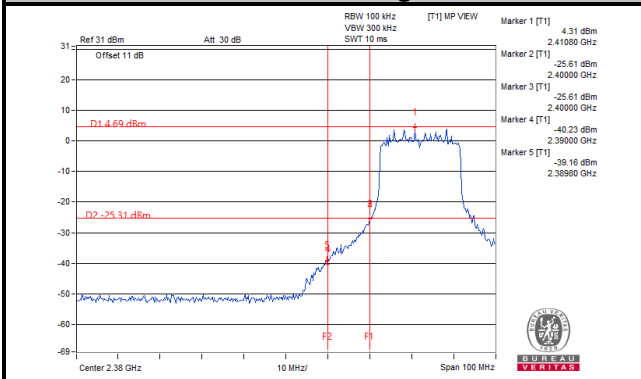

Ch 11 Band Edge

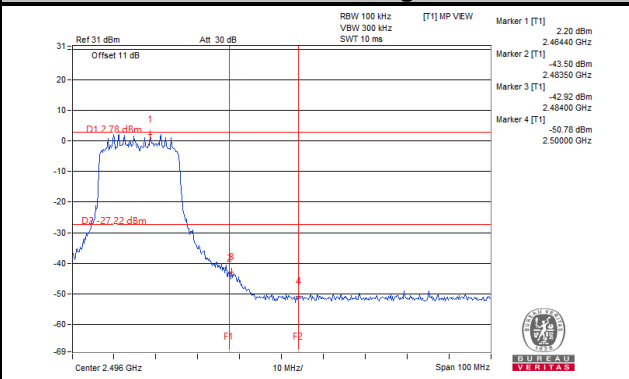

CHAIN 1

Ch 1

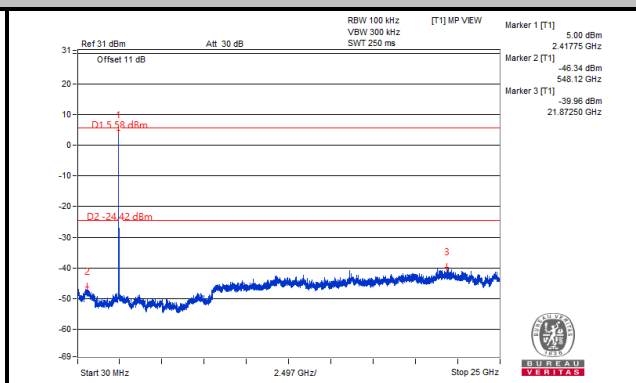
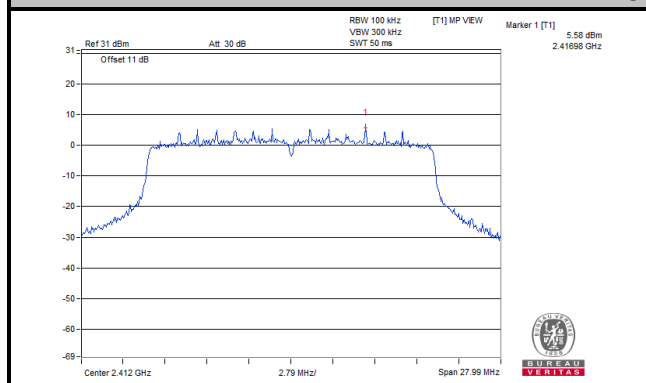

Ch 6

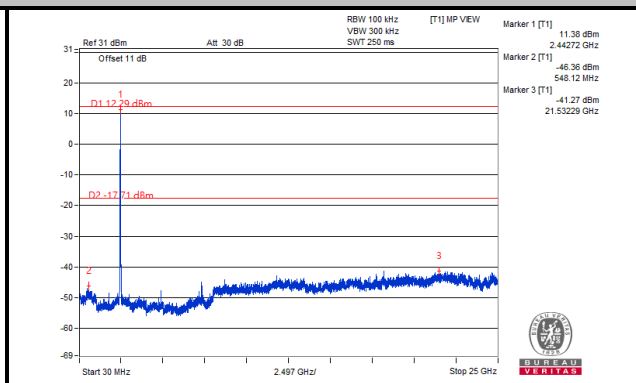
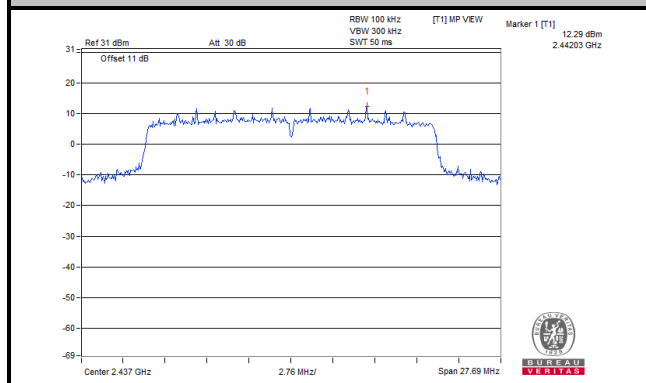

Ch 11

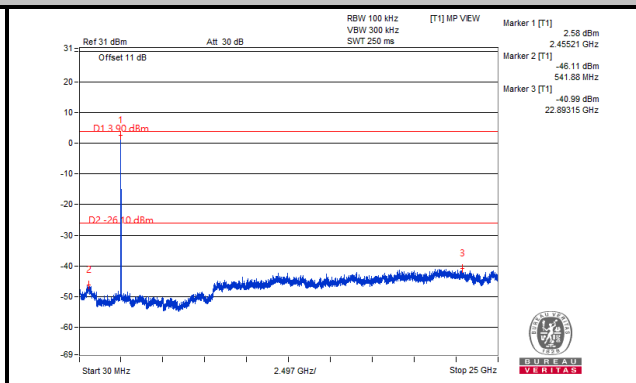
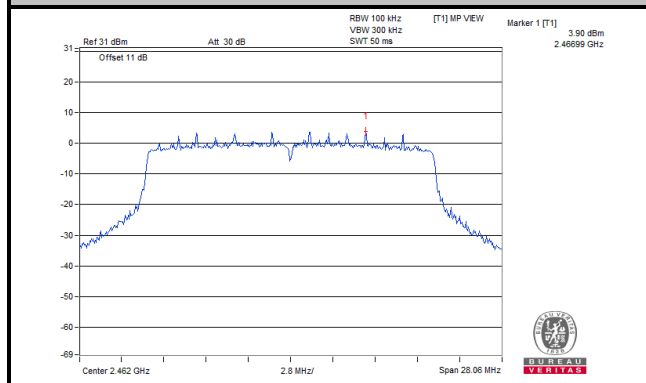

Ch 1 Band Edge

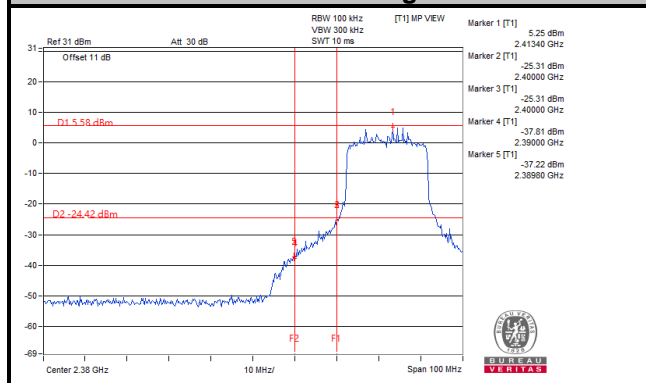

Ch 11 Band Edge

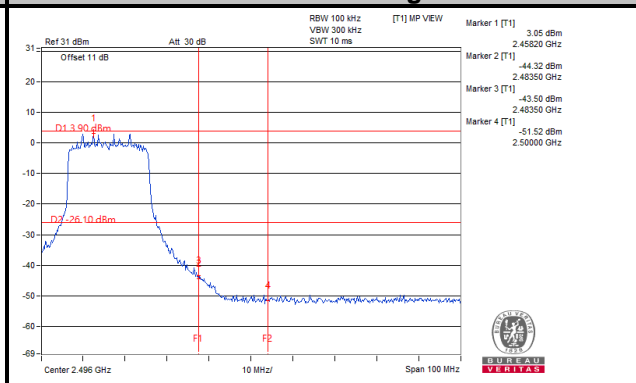

802.11ax (HE40)
CHAIN 0

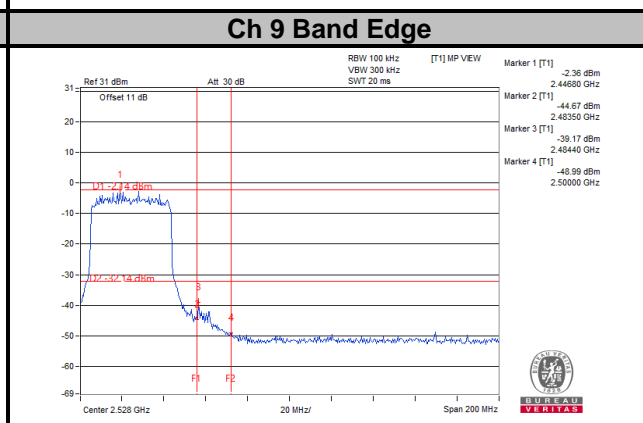
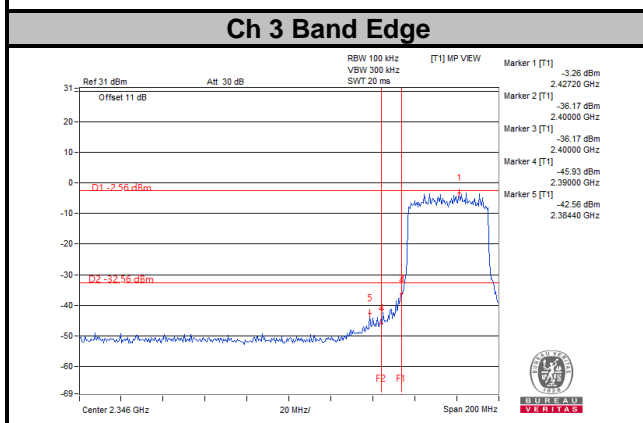
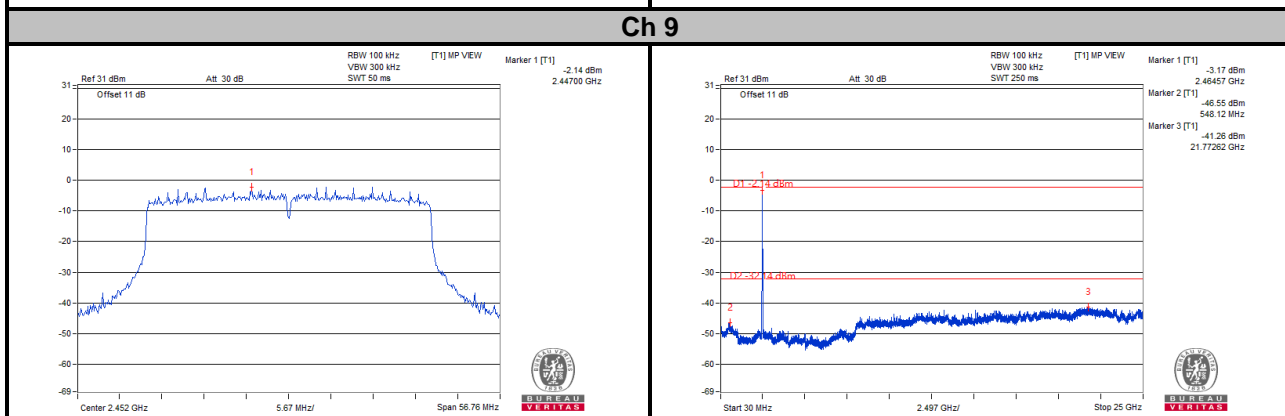
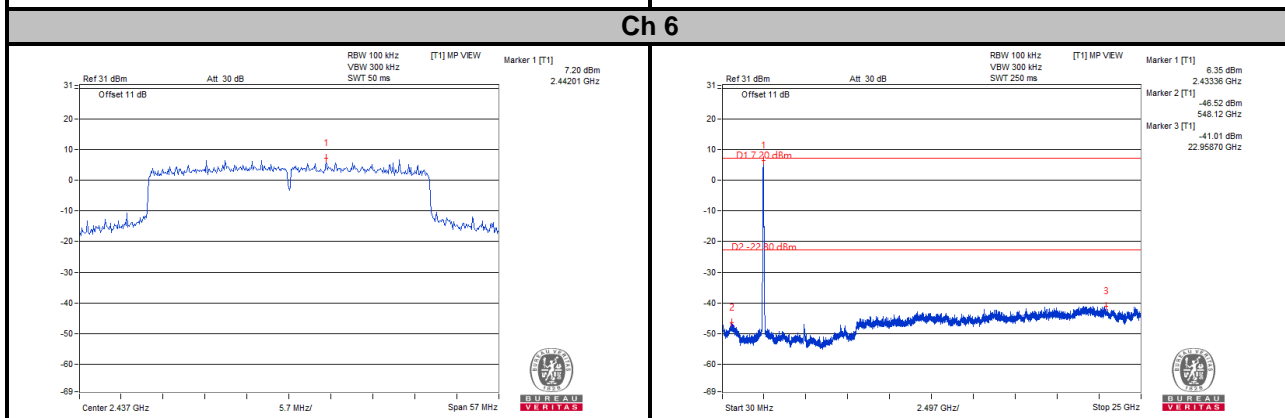
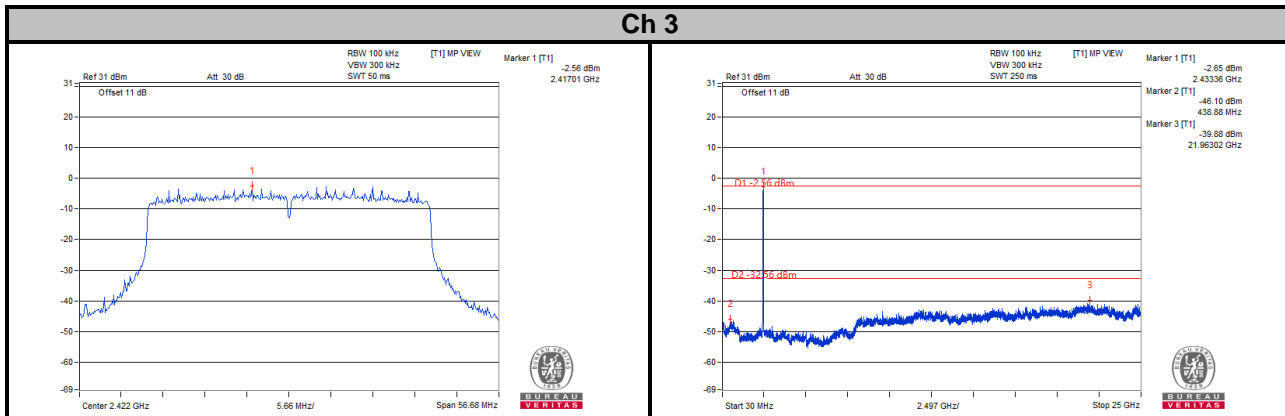

CHAIN 1

Ch 3

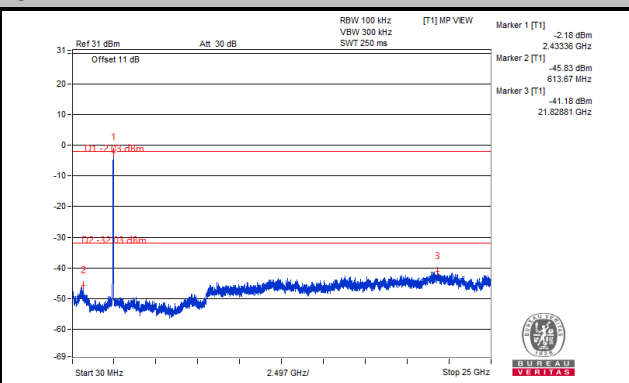
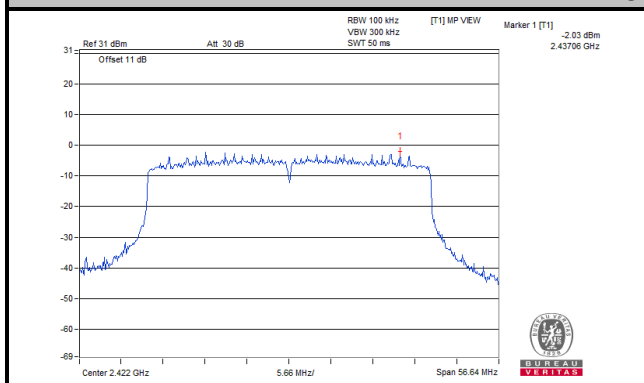

Ch 6

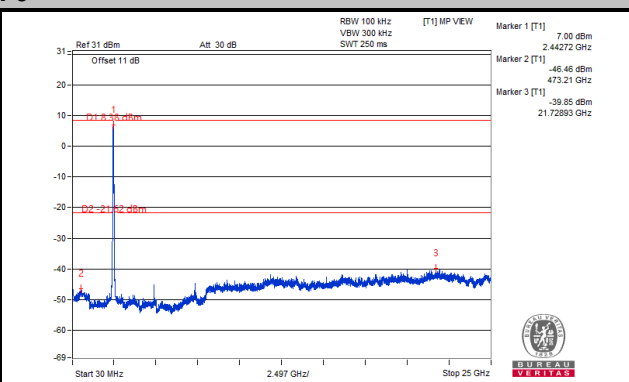
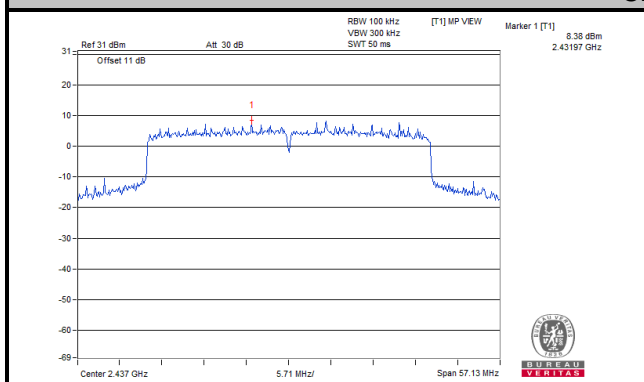

Ch 9

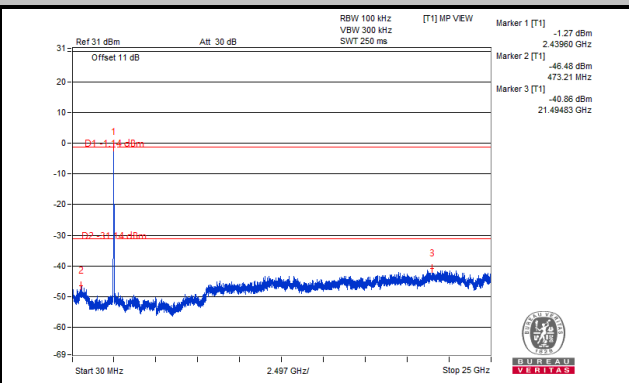
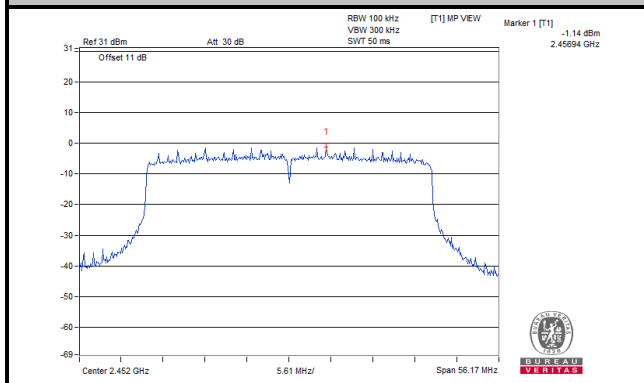

Ch 3 Band Edge

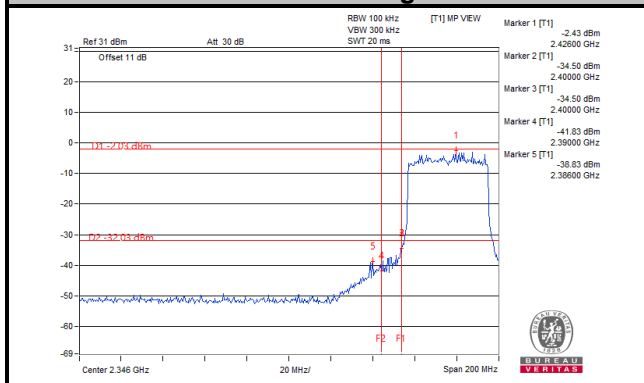

Ch 9 Band Edge

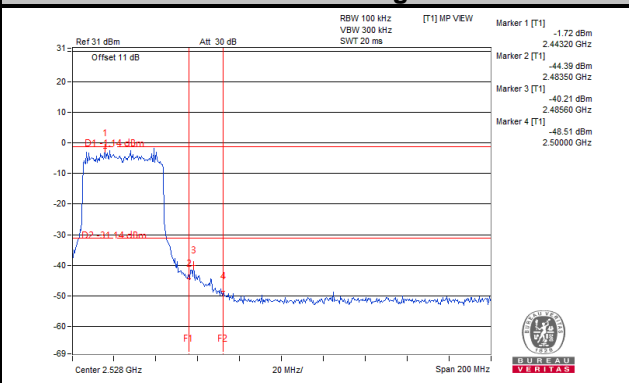

5 Pictures of Test Arrangements

Please refer to the attached file (Test Setup Photo).

Annex A- Band Edge Measurement

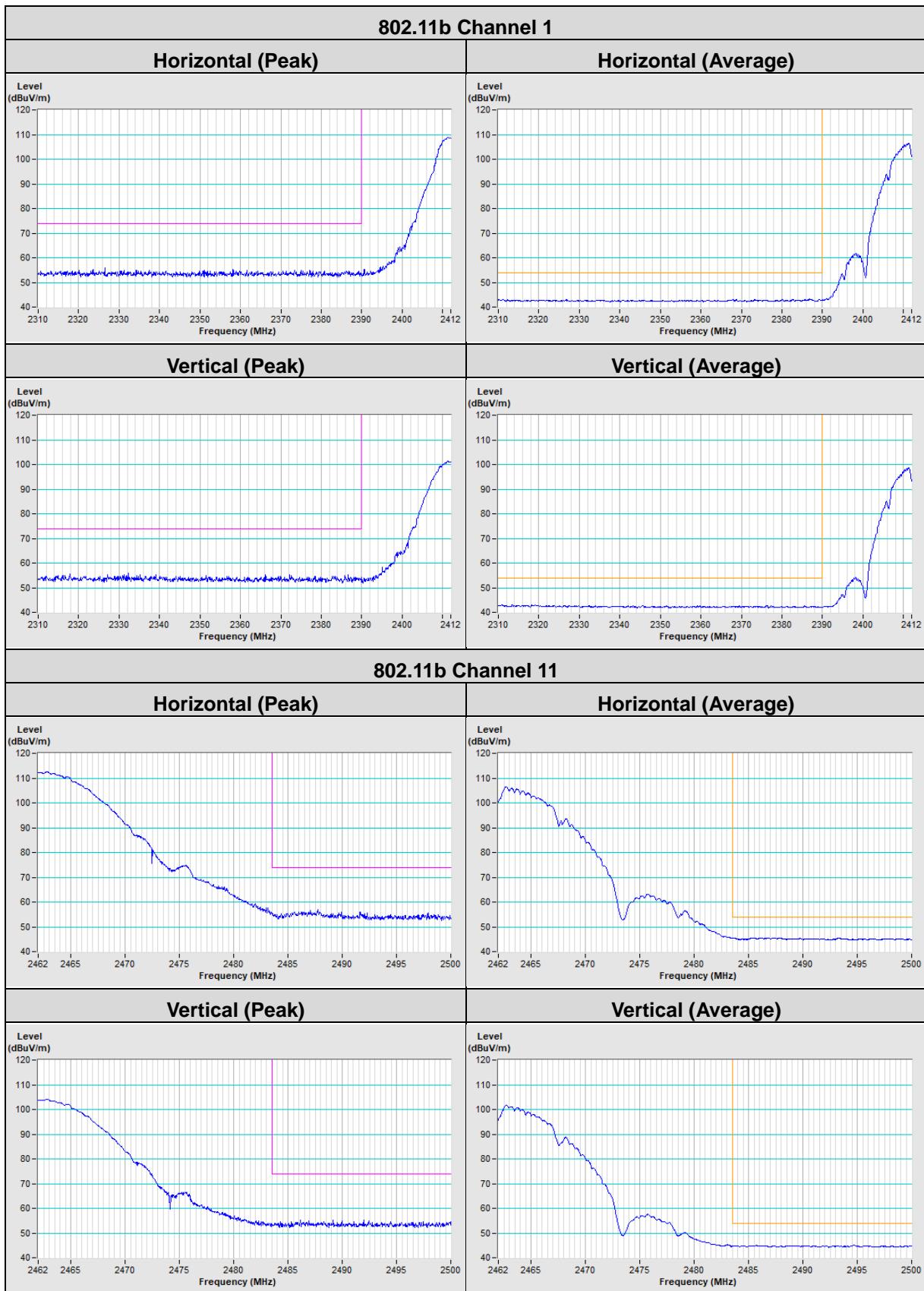

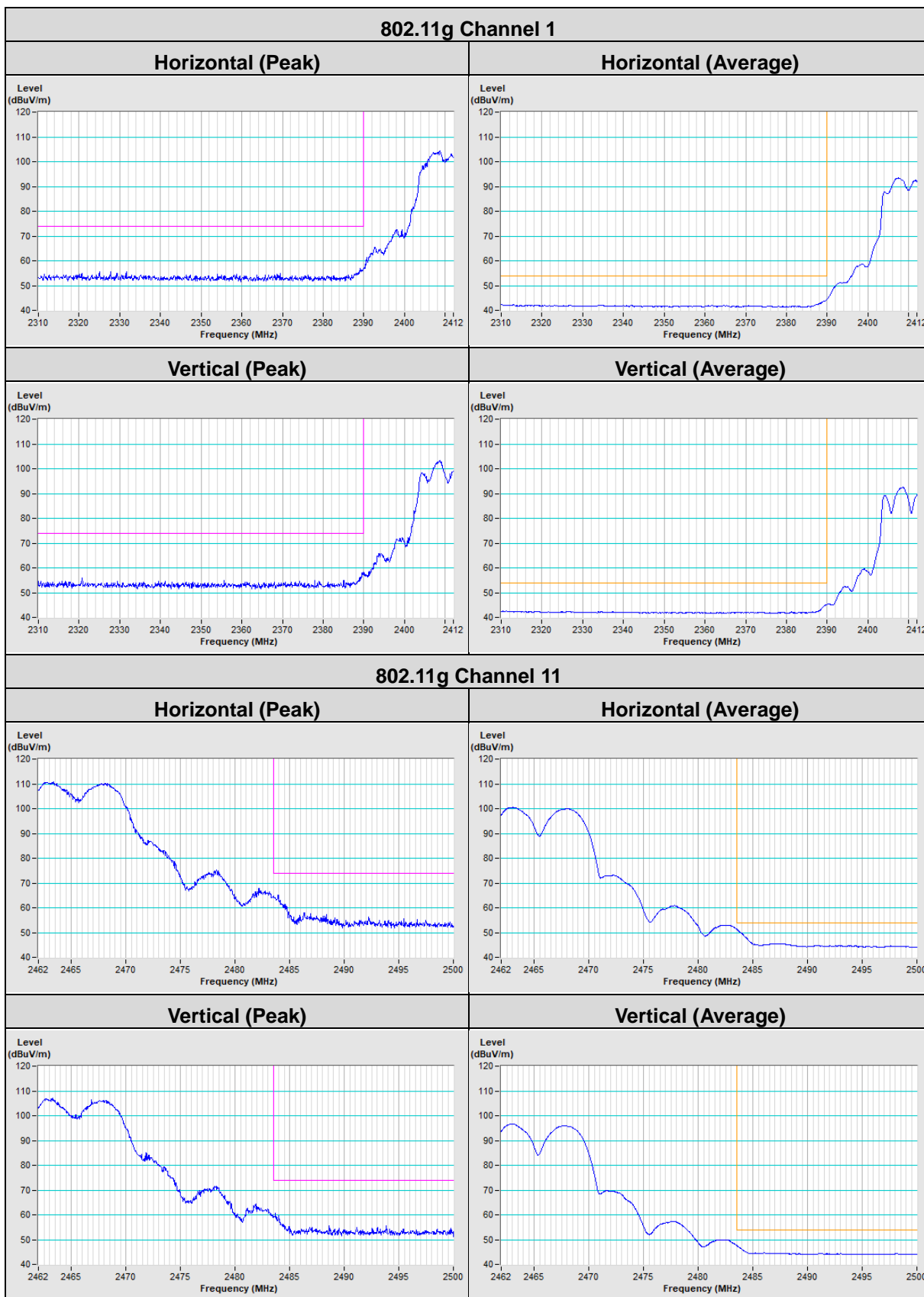

802.11ax (HE20) Channel 1

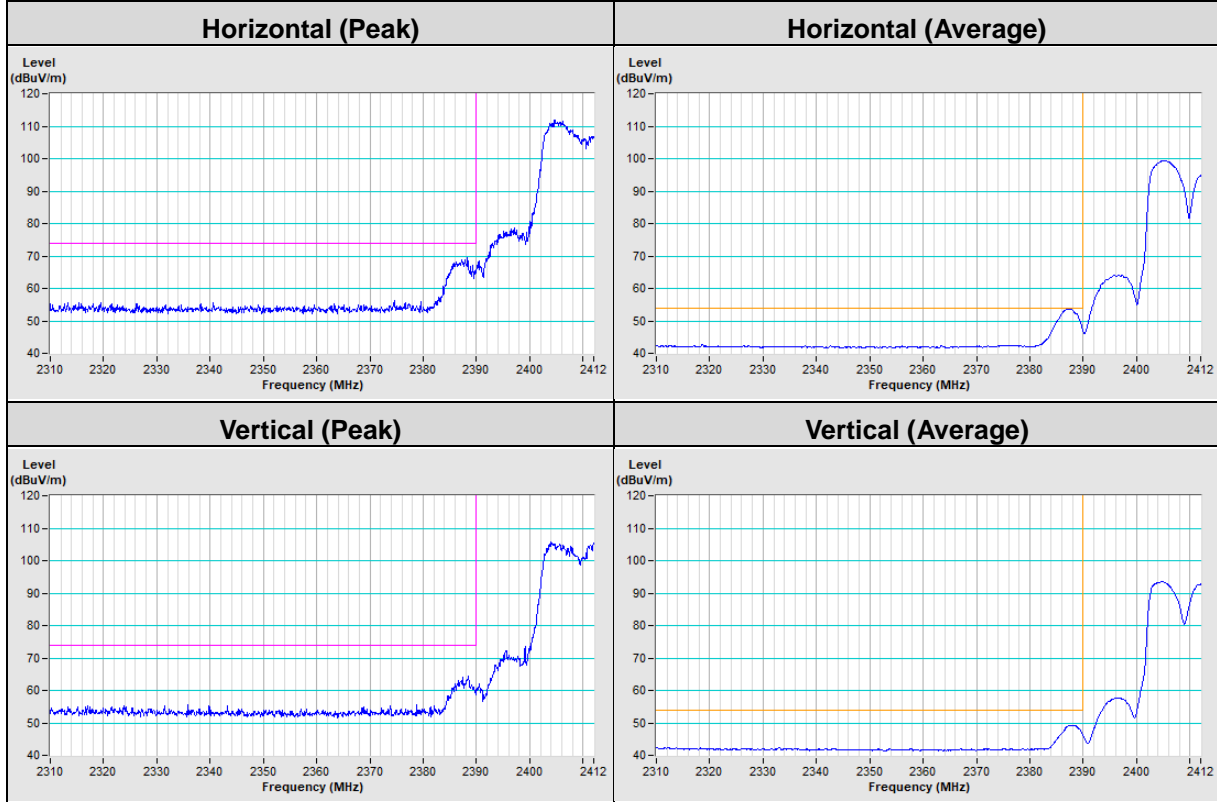

802.11ax (HE20) Channel 11

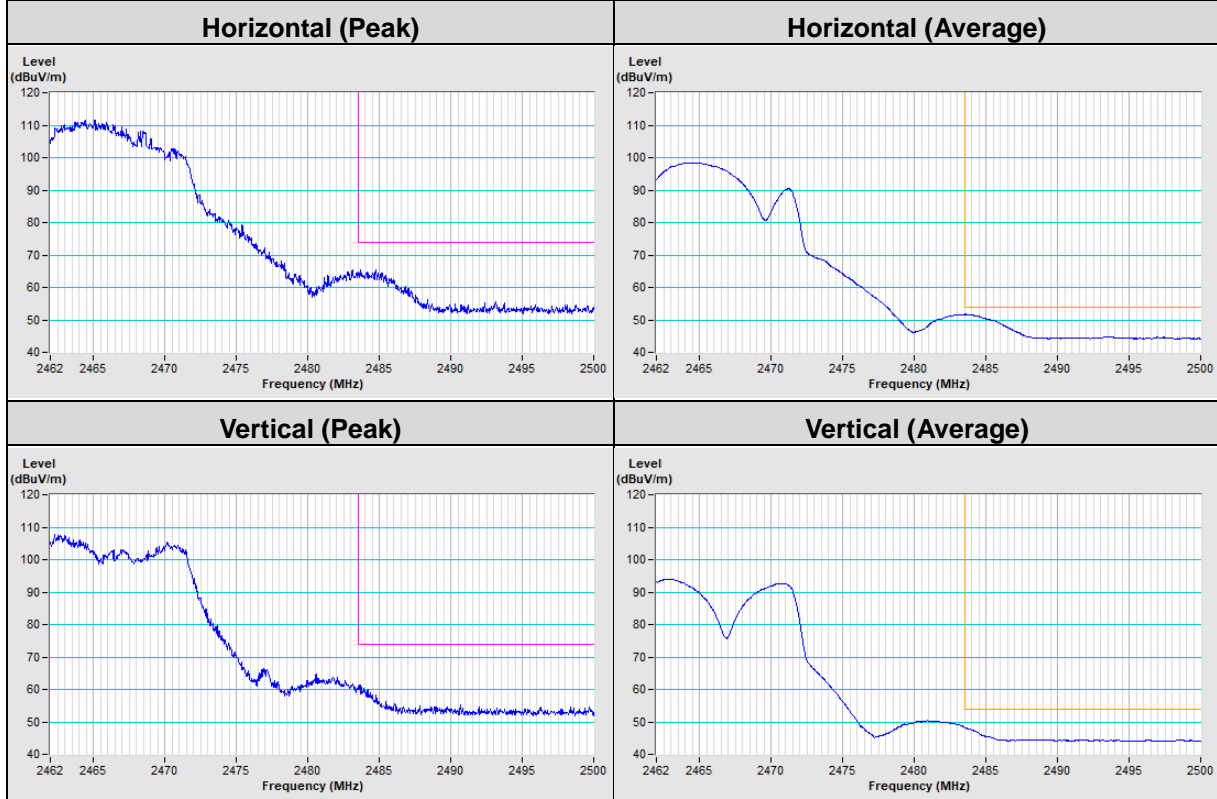

802.11ax (HE40) Channel 3

Horizontal (Peak)

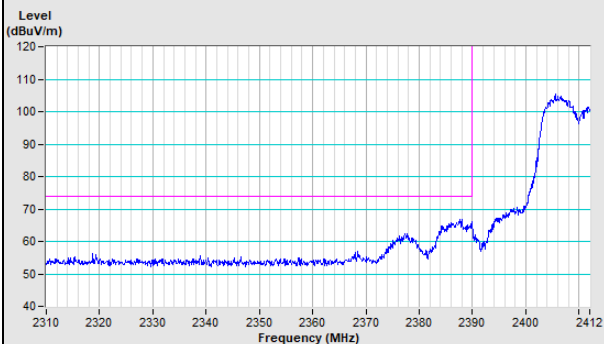

Horizontal (Average)

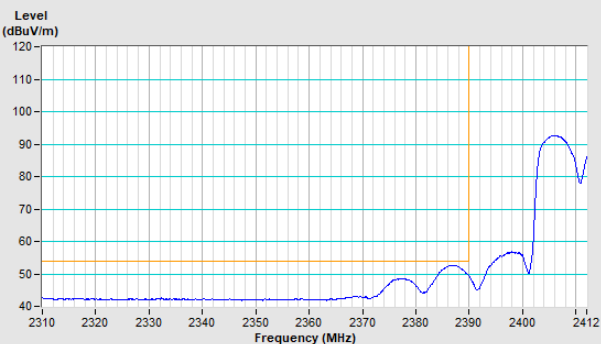

Vertical (Peak)

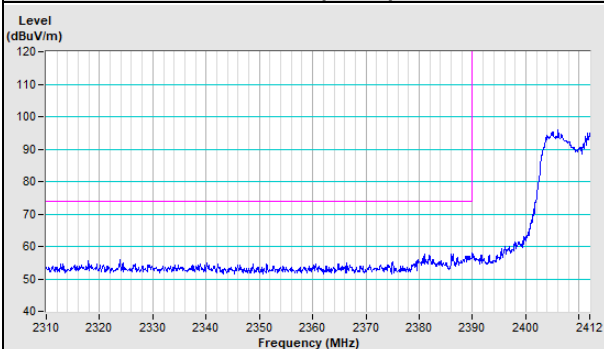

Vertical (Average)

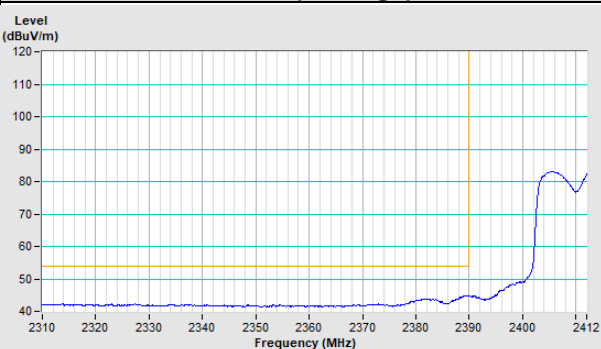

802.11ax (HE40) Channel 9

Horizontal (Peak)

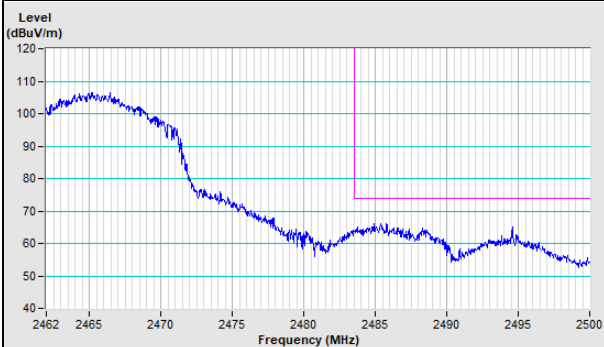

Horizontal (Average)

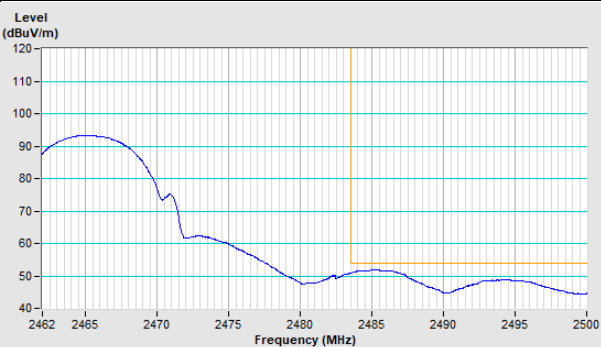

Vertical (Peak)

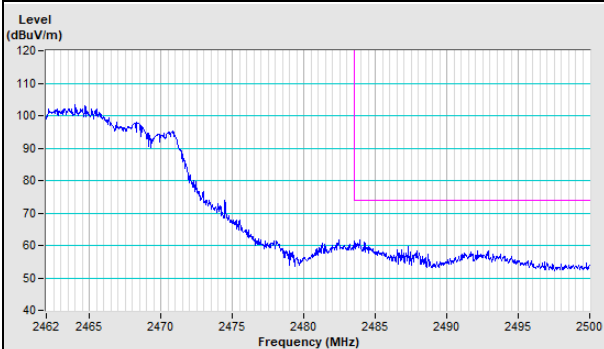

Vertical (Average)

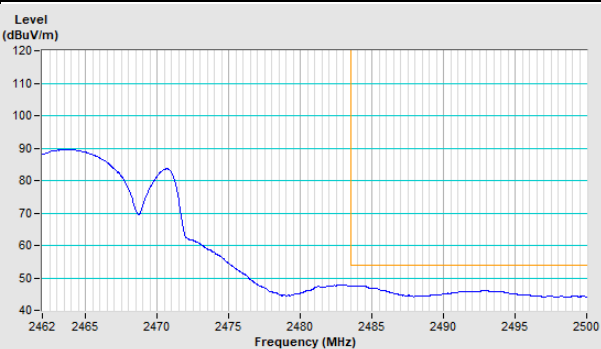

Appendix – Information of the Testing Laboratories

We, Bureau Veritas Consumer Products Services (H.K.) Ltd., Taoyuan Branch, were founded in 1988 to provide our best service in EMC, Radio, Telecom and Safety consultation. Our laboratories are FCC recognized accredited test firms and accredited according to ISO/IEC 17025.

If you have any comments, please feel free to contact us at the following:

Lin Kou EMC/RF Lab

Tel: 886-2-26052180

Fax: 886-2-26051924

Hsin Chu EMC/RF/Telecom Lab

Tel: 886-3-6668565

Fax: 886-3-6668323

Hwa Ya EMC/RF/Safety Lab

Tel: 886-3-3183232

Fax: 886-3-3270892

Email: service.adt@tw.bureauveritas.com

Web Site: www.bureauveritas-adt.com

The address and road map of all our labs can be found in our web site also.

--- END ---