

FCC Test Report

Report No.: RF200116C09-1

FCC ID: KA2WL8720APA1

Test Model: DWL-8720AP

Received Date: Jan. 16, 2020

Test Date: Jan. 22, 2020 ~ Apr. 05, 2020

Issued Date: Jun. 02, 2020

Applicant: D-Link Corporation

Address: 17595 Mt. Herrmann, Fountain Valley, California, United States, 92708

Issued By: Bureau Veritas Consumer Products Services (H.K.) Ltd., Taoyuan Branch
Lin Kou Laboratories

Lab Address: No. 47-2, 14th Ling, Chia Pau Vil., Lin Kou Dist., New Taipei City, Taiwan

Test Location: No.19, Hwa Ya 2nd Rd., Wen Hwa Vil., Kwei Shan Dist., Taoyuan City
33383, Taiwan

**FCC Registration /
Designation Number:** 788550 / TW0003



This report is for your exclusive use. Any copying or replication of this report to or for any other person or entity, or use of our name or trademark, is permitted only with our prior written permission. This report sets forth our findings solely with respect to the test samples identified herein. The results set forth in this report are not indicative or representative of the quality or characteristics of the lot from which a test sample was taken or any similar or identical product unless specifically and expressly noted. Our report includes all of the tests requested by you and the results thereof based upon the information that you provided to us. You have 60 days from date of issuance of this report to notify us of any material error or omission caused by our negligence, provided, however, that such notice shall be in writing and shall specifically address the issue you wish to raise. A failure to raise such issue within the prescribed time shall constitute your unqualified acceptance of the completeness of this report, the tests conducted and the correctness of the report contents. Unless specific mention, the uncertainty of measurement has been explicitly taken into account to declare the compliance or non-compliance to the specification. The report must not be used by the client to claim product certification, approval, or endorsement by TAF or any government agencies.

Table of Contents

Release Control Record	4
1 Certificate of Conformity	5
2 Summary of Test Results.....	6
2.1 Measurement Uncertainty.....	6
2.2 Modification Record	6
3 General Information	7
3.1 General Description of EUT	7
3.2 Description of Test Modes.....	9
3.2.1 Test Mode Applicability and Tested Channel Detail.....	10
3.3 Duty Cycle of Test Signal	12
3.4 Description of Support Units	13
3.4.1 Configuration of System under Test	13
3.5 General Description of Applied Standards and References	13
4 Test Types and Results	14
4.1 Radiated Emission and Bandedge Measurement	14
4.1.1 Limits of Radiated Emission and Bandedge Measurement	14
4.1.2 Test Instruments	16
4.1.3 Test Procedures.....	17
4.1.4 Deviation from Test Standard	17
4.1.5 Test Setup.....	18
4.1.6 EUT Operating Conditions.....	19
4.1.7 Test Results	20
4.2 Conducted Emission Measurement.....	42
4.2.1 Limits of Conducted Emission Measurement	42
4.2.2 Test Instruments	42
4.2.3 Test Procedures.....	43
4.2.4 Deviation from Test Standard	43
4.2.5 Test Setup.....	43
4.2.6 EUT Operating Conditions.....	43
4.2.7 Test Results	44
4.3 Transmit Power Measurement.....	46
4.3.1 Limits of Transmit Power Measurement	46
4.3.2 Test Setup.....	46
4.3.3 Test Instruments	47
4.3.4 Test Procedure	47
4.3.5 Deviation from Test Standard	47
4.3.6 EUT Operating Conditions.....	47
4.3.7 Test Result	48
4.4 Occupied Bandwidth Measurement.....	56
4.4.1 Test Setup.....	56
4.4.2 Test Instruments	56
4.4.3 Test Procedure	56
4.4.4 Test Result	57
4.5 Peak Power Spectral Density Measurement	61
4.5.1 Limits of Peak Power Spectral Density Measurement	61
4.5.2 Test Setup.....	61
4.5.3 Test Instruments	61
4.5.4 Test Procedures.....	61
4.5.5 Deviation from Test Standard	62
4.5.6 EUT Operating Conditions.....	62
4.5.7 Test Results	63
4.6 Frequency Stability	68
4.6.1 Limits of Frequency Stability Measurement	68

4.6.2 Test Setup	68
4.6.3 Test Instruments	68
4.6.4 Test Procedure	68
4.6.5 Deviation from Test Standard	69
4.6.6 EUT Operating Condition	69
4.6.7 Test Results	69
4.7 6dB Bandwidth Measurement.....	70
4.7.1 Limits of 6dB Bandwidth Measurement.....	70
4.7.2 Test Setup.....	70
4.7.3 Test Instruments	70
4.7.4 Test Procedure	70
4.7.5 Deviation from Test Standard	70
4.7.6 EUT Operating Condition	70
4.7.7 Test Results	71
5 Pictures of Test Arrangements.....	73
Annex A- Radiated Out of Band Emission (OOBE) Measurement (For U-NII-3 band)	74
Annex B- Band Edge Measurement.....	77
Appendix – Information of the Testing Laboratories	83

Release Control Record

Issue No.	Description	Date Issued
RF200116C09-1	Original Release	Jun. 02, 2020

1 Certificate of Conformity

Product: Unified AC Dual-band Outdoor PoE Access Point

Brand: D-Link

Test Model: DWL-8720AP

Sample Status: Engineering Sample

Applicant: D-Link Corporation

Test Date: Jan. 22, 2020 ~ Apr. 05, 2020

Standards: 47 CFR FCC Part 15, Subpart E (Section 15.407)
ANSI C63.10:2013

The above equipment has been tested by **Bureau Veritas Consumer Products Services (H.K.) Ltd., Taoyuan Branch**, and found compliance with the requirement of the above standards. The test record, data evaluation & Equipment Under Test (EUT) configurations represented herein are true and accurate accounts of the measurements of the sample's RF characteristics under the conditions specified in this report.

Prepared by :  , Date: Jun. 02, 2020
Lena Wang / Specialist

Approved by :  , Date: Jun. 02, 2020
Dylan Chiou / Senior Project Engineer

2 Summary of Test Results

47 CFR FCC Part 15, Subpart E (Section 15.407)			
FCC Clause	Test Item	Result	Remarks
15.407(b)(6)	AC Power Conducted Emissions	Pass	Meet the requirement of limit. Minimum passing margin is -10.41 dB at 0.17476 MHz.
15.407(b) (1/2/3/4(i/ii)/6)	Radiated Emissions & Band Edge Measurement	Pass	Meet the requirement of limit. Minimum passing margin is -1.0 dB at 5150.00 MHz.
15.407(a)(1/2/3)	Max Average Transmit Power	Pass	Meet the requirement of limit.
---	Occupied Bandwidth Measurement	-	Reference only
15.407(a)(1/2/3)	Peak Power Spectral Density	Pass	Meet the requirement of limit.
15.407(e)	6 dB Bandwidth	Pass	Meet the requirement of limit. (U-NII-3 Band only)
15.407(g)	Frequency Stability	Pass	Meet the requirement of limit.
15.203	Antenna Requirement	Pass	Antenna connector is R-N type(F) not a standard connector.

Note:

- For U-NII-3 band compliance with rule part 15.407(b)(4)(i), the OOB test plots were recorded in Annex A.
- For U-NII-1, U-NII-2A, U-NII-2C band compliance with rule 15.407(b) of the band-edge items, the test plots were recorded in Annex B. Test Procedures refer to report 4.1.3.
- Determining compliance based on the results of the compliance measurement, not taking into account measurement instrumentation uncertainty.

2.1 Measurement Uncertainty

Where relevant, the following measurement uncertainty levels have been estimated for tests performed on the EUT as specified in CISPR 16-4-2:

Measurement	Frequency	Expanded Uncertainty (k=2) (\pm)
Conducted Emissions at mains ports	150 kHz ~ 30 MHz	2.79 dB
Radiated Emissions up to 1 GHz	9 kHz ~ 30 MHz	3.04 dB
	30 MHz ~ 200 MHz	2.93 dB
	200 MHz ~ 1000 MHz	2.95 dB
Radiated Emissions above 1 GHz	1 GHz ~ 18 GHz	2.26 dB
	18 GHz ~ 40 GHz	1.94 dB

2.2 Modification Record

There were no modifications required for compliance.

3 General Information

3.1 General Description of EUT

Product	Unified AC Dual-band Outdoor PoE Access Point
Brand	D-Link
Test Model	DWL-8720AP
Status of EUT	Engineering Sample
Power Supply Rating	54 Vdc (POE)
Modulation Type	256QAM, 64QAM, 16QAM, QPSK, BPSK
Modulation Technology	OFDM
Transfer Rate	802.11a: 54.0/ 48.0/ 36.0/ 24.0/ 18.0/ 12.0/ 9.0/ 6.0 Mbps 802.11n: up to 400.0 Mbps 802.11ac: up to 866.7 Mbps
Operating Frequency	5180 ~ 5240 MHz, 5745 ~ 5825 MHz
Number of Channel	5180 ~ 5240 MHz: 4 for 802.11a, 802.11n (HT20), 802.11ac (VHT20) 2 for 802.11n (HT40), 802.11ac (VHT40) 1 for 802.11ac (VHT80) 5745 ~ 5825 MHz: 5 for 802.11a, 802.11n (HT20), 802.11ac (VHT20) 2 for 802.11n (HT40), 802.11ac (VHT40) 1 for 802.11ac (VHT80)
Output Power	CDD Mode: 479.848 mW for 5180 ~ 5240 MHz 417.081 mW for 5745 ~ 5825 MHz Beamforming Mode: 239.941 mW for 5180 ~ 5240 MHz 208.555 mW for 5745 ~ 5825 MHz
Antenna Type	Refer to Note as below
Antenna Connector	Refer to Note as below
Accessory Device	Refer to Note as below
Data Cable Supplied	Refer to Note as below

Note:

1. The EUT incorporates a MIMO function. Physically, the EUT provides two completed transmitters and two receivers.

Modulation Mode	Beamformng Mode	Tx Function
802.11a	Not Support	2TX
802.11n (HT20)	Support	2TX
802.11n (HT40)	Support	2TX
802.11ac (VHT20)	Support	2TX
802.11ac (VHT40)	Support	2TX
802.11ac (VHT80)	Support	2TX

* The modulation and bandwidth are similar for 802.11n mode for HT20 / HT40 and 802.11ac mode for VHT20 / VHT40, therefore investigated worst case to representative mode in test report. (Final test mode refer section 3.2.1)

* For 802.11n and 802.11ac, CDD mode is the worst case for final radiated emission and power line conducted emission tests after pretesting CDD mode and beamforming mode.

2. The following antennas were provided to the EUT.

No.	Type	Connector	Gain (dBi)							
			2400 MHz	2450 MHz	2500 MHz	4900 MHz	5150 MHz	5350 MHz	5725 MHz	5825 MHz
1	Dipole	R-N type(F)	3.5	3.4	3.1	5.1	6.0	5.8	5.5	5.3
2	Dipole	R-N type(F)	3.5	3.4	3.1	5.1	6.0	5.8	5.5	5.3

3. The EUT contains following accessory devices.

Product	Brand	Model	Description
Console Cable	N/A	N/A	1 m non-shielded without core
GND Cable	N/A	N/A	1m non-shielded ground cable without core

4. The test support unit which provided by client is listed as below.

Product	Brand	Model	Description
POE	LEADER ELECTRONICS INC.	NU90-J540167-I1	I/P: 100-240 Vac, 50/60 Hz, 1.2 A O/P: 54 Vdc, 1.67 A Power Cord: 1.5m non-shielded power cord without core

5. The EUT will install at outdoor area, the highest antenna gain from the horizon above 30 degrees as below, for more detail information please refer to antenna specification and user manual.

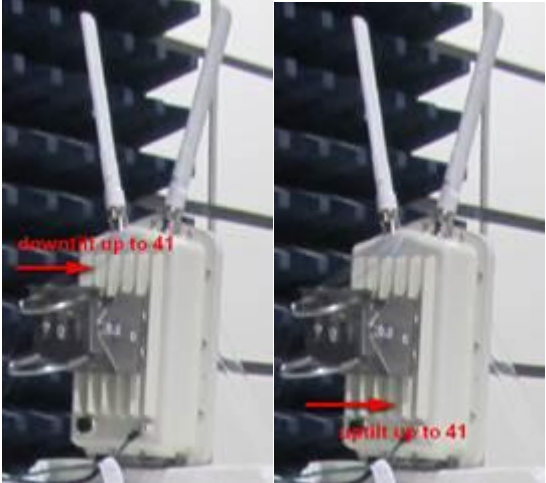
C107-511211-A	6dBi	
Due to device will restricted installation position as above photo, to the maximum antenna gain are chosen		

6. There're 2 configurations for the EUT listed as below.

Mode A: Flat Type iron frame

Mode B: C Type iron frame

7. Spurious emission of the simultaneous operation (2.4GHz and 5GHz) has been evaluated and no non-compliance was found.

8. The above EUT information is declared by manufacturer and for more detailed features description, please refers to the manufacturer's specifications or user's manual.

3.2 Description of Test Modes

For 5180 ~ 5240 MHz

4 channels are provided for 802.11a, 802.11n (HT20), 802.11ac (VHT20):

Channel	Frequency (MHz)	Channel	Frequency (MHz)
36	5180	44	5220
40	5200	48	5240

2 channels are provided for 802.11n (HT40), 802.11ac (VHT40):

Channel	Frequency (MHz)	Channel	Frequency (MHz)
38	5190	46	5230

1 channel is provided for 802.11ac (VHT80):

Channel	Frequency (MHz)
42	5210

For 5745 ~ 5825 MHz:

5 channels are provided for 802.11a, 802.11n (HT20), 802.11ac (VHT20):

Channel	Frequency (MHz)	Channel	Frequency (MHz)
149	5745	161	5805
153	5765	165	5825
157	5785		

2 channels are provided for 802.11n (HT40), 802.11ac (VHT40):

Channel	Frequency (MHz)	Channel	Frequency (MHz)
151	5755	159	5795

1 channel is provided for 802.11ac (VHT80):

Channel	Frequency (MHz)
155	5775

3.2.1 Test Mode Applicability and Tested Channel Detail

EUT Configure Mode	Applicable To				Description
	RE \geq 1G	RE $<$ 1G	PLC	APCM	
A	√	√	√	√	For Flat Type iron frame
B	-	√	-	-	For C Type iron frame

Where **RE \geq 1G**: Radiated Emission above 1 GHz **RE $<$ 1G**: Radiated Emission below 1 GHz
PLC: Power Line Conducted Emission **APCM**: Antenna Port Conducted Measurement

Note:

1. The EUT had been pre-tested on the positioned of each 3 axis. The worst case was found when positioned on **Z-plane**.
2. "-" means no effect.

Radiated Emission Test (Above 1 GHz):

- Pre-Scan has been conducted to determine the worst-case mode from all possible combinations between available modulations, data rates and antenna ports (if EUT with antenna diversity architecture).
- Following channel(s) was (were) selected for the final test as listed below.

EUT Configure Mode	Frequency Band (MHz)	Mode	Available Channel	Tested Channel	Modulation Technology	Modulation Type	Data Rate (Mbps)
A	5180-5240	802.11a	36 to 48	36, 40, 48	OFDM	BPSK	6.0
		802.11n (HT20)	36 to 48	36, 40, 48	OFDM	BPSK	6.5
		802.11n (HT40)	38 to 46	38, 46	OFDM	BPSK	13.5
		802.11ac (VHT80)	42	42	OFDM	BPSK	29.3
	5745-5825	802.11a	149 to 165	149, 157, 165	OFDM	BPSK	6.0
		802.11n (HT20)	149 to 165	149, 157, 165	OFDM	BPSK	6.5
		802.11n (HT40)	151 to 159	151, 159	OFDM	BPSK	13.5
		802.11ac (VHT80)	155	155	OFDM	BPSK	29.3

Radiated Emission Test (Below 1 GHz):

- Pre-Scan has been conducted to determine the worst-case mode from all possible combinations between available modulations, data rates and antenna ports (if EUT with antenna diversity architecture).
- Following channel(s) was (were) selected for the final test as listed below.

EUT Configure Mode	Frequency Band (MHz)	Mode	Available Channel	Tested Channel	Modulation Technology	Modulation Type	Data Rate (Mbps)
A、B	5180-5240	802.11n (HT40)	38 to 46	38	OFDM	BPSK	13.5

Power Line Conducted Emission Test:

- Pre-Scan has been conducted to determine the worst-case mode from all possible combinations between available modulations, data rates and antenna ports (if EUT with antenna diversity architecture).
- Following channel(s) was (were) selected for the final test as listed below.

EUT Configure Mode	Frequency Band (MHz)	Mode	Available Channel	Tested Channel	Modulation Technology	Modulation Type	Data Rate (Mbps)
A	5180-5240	802.11n (HT40)	38 to 46	38	OFDM	BPSK	13.5

Antenna Port Conducted Measurement:

- This item includes all test value of each mode, but only includes spectrum plot of worst value of each mode.
- Pre-Scan has been conducted to determine the worst-case mode from all possible combinations between available modulations, data rates and antenna ports (if EUT with antenna diversity architecture).
- Following channel(s) was (were) selected for the final test as listed below.

EUT Configure Mode	Frequency Band (MHz)	Mode	Available Channel	Tested Channel	Modulation Technology	Modulation Type	Data Rate (Mbps)
A	5180-5240	802.11a	36 to 48	36, 40, 48	OFDM	BPSK	6.0
		802.11n (HT20)	36 to 48	36, 40, 48	OFDM	BPSK	6.5
		802.11n (HT40)	38 to 46	38, 46	OFDM	BPSK	13.5
		802.11ac (VHT80)	42	42	OFDM	BPSK	29.3
	5745-5825	802.11a	149 to 165	149, 157, 165	OFDM	BPSK	6.0
		802.11n (HT20)	149 to 165	149, 157, 165	OFDM	BPSK	6.5
		802.11n (HT40)	151 to 159	151, 159	OFDM	BPSK	13.5
		802.11ac (VHT80)	155	155	OFDM	BPSK	29.3

Test Condition:

Applicable To	Environmental Conditions	Input Power	Tested by
RE \geq 1G	25 deg. C, 65 % RH	120 Vac, 60 Hz	Han Wu
RE $<$ 1G	25 deg. C, 65 % RH	120 Vac, 60 Hz	Han Wu
PLC	25 deg. C, 65 % RH	120 Vac, 60 Hz	Jones Chang
APCM	25 deg. C, 65 % RH	48 Vdc	Chris Lin

3.3 Duty Cycle of Test Signal

Duty cycle of test signal is $\geq 98\%$, duty factor is not required.

MODULATION TYPE: BPSK

802.11a: Duty cycle = $2.058/2.165 = 0.951$, Duty factor = $10 * \log(1/0.951) = 0.22$

802.11n (HT20): Duty cycle = $4.954/5.044 = 0.982$.

802.11n (HT40): Duty cycle = $2.362/2.5 = 0.945$, Duty factor = $10 * \log(1/0.945) = 0.25$

802.11ac (VHT80): Duty cycle = $1.118/1.233 = 0.907$, Duty factor = $10 * \log(1/0.907) = 0.43$

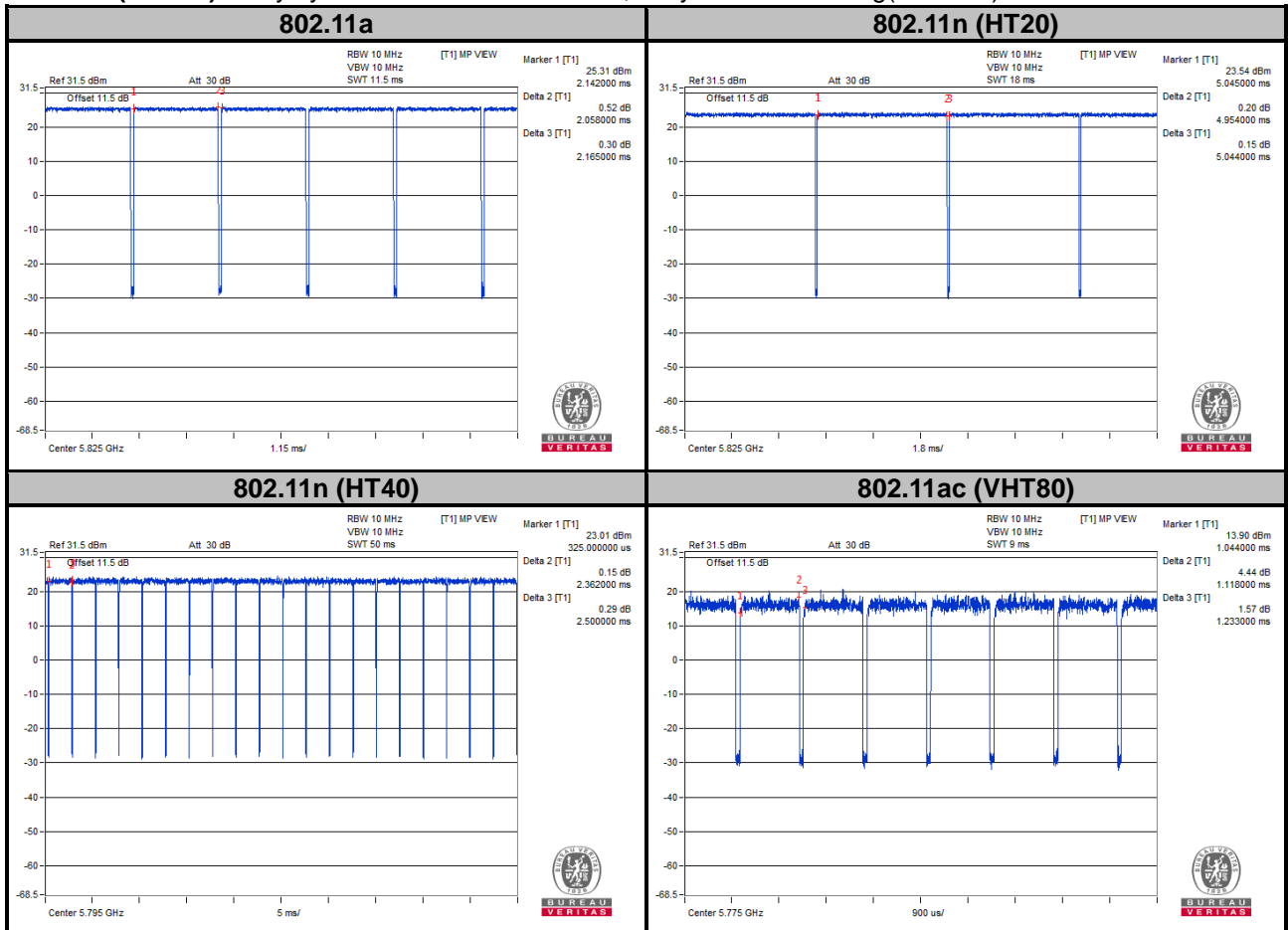

3.4 Description of Support Units

The EUT has been tested as an independent unit together with other necessary accessories or support units. The following support units or accessories were used to form a representative test configuration during the tests.

No.	Product	Brand	Model No.	Serial No.	FCC ID	Remarks
A	Notebook	DELL	E5420	33MJMQ1	FCC DoC Approved	Provided by Lab
B	POE	LEADER ELECTRONICS INC.	NU90-J540167-I1	N/A	N/A	Provided by Client

Note:

1. All power cords of the above support units are non-shielded (1.8m).
2. Item A acted as communication partner to transfer data.

ID	Cable Descriptions	Qty.	Length (m)	Shielding (Yes/No)	Cores (Qty.)	Remarks
1.	LAN Cable	1	10	N	0	RJ45, Cat5e
2.	LAN Cable	1	1.5	N	0	RJ45, Cat5e, Provided by client.
3.	GND Cable	1	1	N	0	Provided by client.

3.4.1 Configuration of System under Test

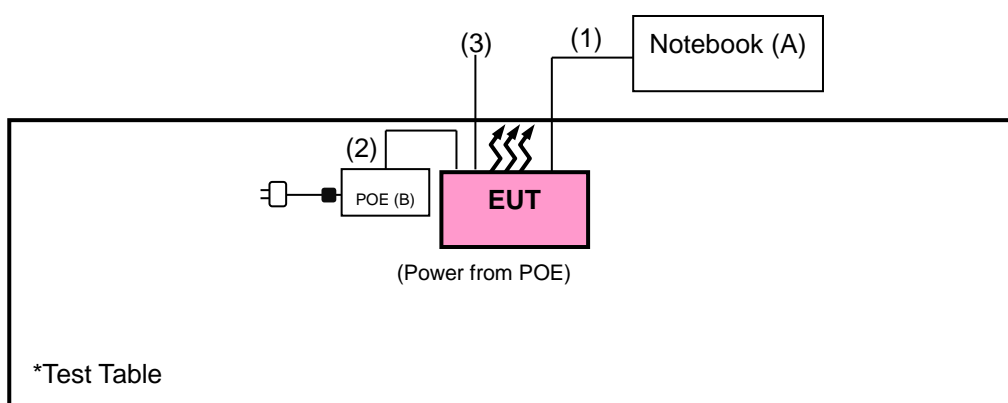

3.5 General Description of Applied Standards and References

The EUT is a RF Product. According to the specifications of the manufacturer, it must comply with the requirements of the following standards and references:

Test Standard:

FCC Part 15, Subpart E (15.407)

ANSI C63.10-2013

All test items have been performed and recorded as per the above standards.

References Test Guidance:

KDB 789033 D02 General UNII Test Procedures New Rules v02r01

KDB 662911 D01 Multiple Transmitter Output v02r01

All test items have been performed as a reference to the above KDB test guidance.

4 Test Types and Results

4.1 Radiated Emission and Bandedge Measurement

4.1.1 Limits of Radiated Emission and Bandedge Measurement

Radiated emissions which fall in the restricted bands must comply with the radiated emission limits specified as below table.

Frequencies (MHz)	Field Strength (microvolts/meter)	Measurement Distance (meters)
0.009 ~ 0.490	2400/F (kHz)	300
0.490 ~ 1.705	24000/F (kHz)	30
1.705 ~ 30.0	30	30
30 ~ 88	100	3
88 ~ 216	150	3
216 ~ 960	200	3
Above 960	500	3

Note:

1. The lower limit shall apply at the transition frequencies.
2. Emission level (dBuV/m) = 20 log Emission level (uV/m).
3. For frequencies above 1000 MHz, the field strength limits are based on average detector, however, the peak field strength of any emission shall not exceed the maximum permitted average limits, specified above by more than 20 dB under any condition of modulation.

Limits of Unwanted Emission Out of the Restricted Bands

Applicable To		Limit	
789033 D02 General UNII Test Procedures New Rules v02r01		Field Strength at 3 m	
		PK: 74 (dBµV/m)	AV: 54 (dBµV/m)
Frequency Band	Applicable To	EIRP Limit	Equivalent Field Strength at 3 m
5150~5250 MHz	15.407(b)(1)	PK: -27 (dBm/MHz)	PK: 68.2 (dBµV/m)
5250~5350 MHz	15.407(b)(2)		
5470~5725 MHz	15.407(b)(3)		
5725~5850 MHz	<input checked="" type="checkbox"/> 15.407(b)(4)(i)	PK:-27 (dBm/MHz) *1 PK:10 (dBm/MHz) *2 PK:15.6 (dBm/MHz) *3 PK:27 (dBm/MHz) *4	PK: 68.2 (dBµV/m) *1 PK:105.2 (dBµV/m) *2 PK: 110.8 (dBµV/m) *3 PK:122.2 (dBµV/m) *4
	<input type="checkbox"/> 15.407(b)(4)(ii)	Emission limits in section 15.247(d)	
<p>*1 beyond 75 MHz or more above of the band edge.</p> <p>*2 below the band edge increasing linearly to 10 dBm/MHz at 25 MHz above.</p> <p>*3 below the band edge increasing linearly to a level of 15.6 dBm/MHz at 5 MHz above.</p> <p>*4 from 5 MHz above or below the band edge increasing linearly to a level of 27 dBm/MHz at the band edge.</p>			

Note:

The following formula is used to convert the equipment isotropic radiated power (eirp) to field strength:

$$E = \frac{1000000\sqrt{30P}}{3} \quad \mu\text{V/m, where P is the eirp (Watts).$$

4.1.2 Test Instruments

Description & Manufacturer	Model No.	Serial No.	Date of Calibration	Due Date of Calibration
Test Receiver KEYSIGHT	N9038A	MY55420137	Apr. 15, 2019	Apr. 14, 2020
Spectrum Analyzer ROHDE & SCHWARZ	FSP40	100269	Jun. 04, 2019	Jun. 03, 2020
BILOG Antenna SCHWARZBECK	VULB9168	9168-160	Nov. 07, 2019	Nov. 06, 2020
HORN Antenna SCHWARZBECK	BBHA 9120 D	9120D-1169	Nov. 24, 2019	Nov. 23, 2020
HORN Antenna SCHWARZBECK	BBHA 9170	BBHA9170241	Nov. 24, 2019	Nov. 23, 2020
Preamplifier Agilent (Below 1GHz)	8447D	2944A10638	Jul. 11, 2019	Jul. 10, 2020
Preamplifier Agilent (Above 1GHz)	8449B	3008A02367	Feb. 19, 2019	Feb. 18, 2020
			Feb. 18, 2020	Feb. 17, 2021
RF signal cable HUBER+SUHNER&EMCI	SUCOFLEX 104 & EMC104-SM- SM8000	CABLE-CH9-02 (248780+171006)	Jan. 18, 2020	Jan. 17, 2021
RF signal cable HUBER+SUHNER	SUCOFLEX 104	CABLE-CH9- (250795/4)	Jul. 11, 2019	Jul. 10, 2020
RF signal cable Woken	8D-FB	Cable-CH9-01	Jul. 30, 2019	Jul. 29, 2020
Software BV ADT	ADT_Radiated_ V7.6.15.9.5	NA	NA	NA
Antenna Tower EMCO	2070/2080	512.835.4684	NA	NA
Turn Table EMCO	2087-2.03	NA	NA	NA
Antenna Tower & Turn BV ADT	AT100	AT93021705	NA	NA
Turn Table BV ADT	TT100	TT93021705	NA	NA
Turn Table Controller BV ADT	SC100	SC93021705	NA	NA
Boresight Antenna Fixture	FBA-01	FBA-SIP01	NA	NA
USB Wideband Power Sensor KEYSIGHT	U2021XA	MY55050005/MY55 190004/MY551900 07/MY55210005	Jul. 15, 2019	Jul. 14, 2020

- Note: 1. The calibration interval of the above test instruments is 12 months and the calibrations are traceable to NML/ROC and NIST/USA.
2. The test was performed in HwaYa Chamber 9.

4.1.3 Test Procedures

For Radiated Emission below 30 MHz

- a. The EUT was placed on the top of a rotating table 0.8 meters above the ground at a 3 meter chamber room. The table was rotated 360 degrees to determine the position of the highest radiation.
- b. The EUT was set 3 meters away from the interference-receiving antenna, which was mounted on the top of a variable-height antenna tower.
- c. Parallel, perpendicular, and ground-parallel orientations of the antenna are set to make the measurement.
- d. For each suspected emission, the EUT was arranged to its worst case and the rotatable table was turned from 0 degrees to 360 degrees to find the maximum reading.
- e. The test-receiver system was set to Quasi-Peak Detect Function and Specified Bandwidth with Maximum Hold Mode.

Note:

1. The resolution bandwidth and video bandwidth of test receiver/spectrum analyzer is 9 kHz at frequency below 30 MHz.

For Radiated Emission above 30 MHz

- a. The EUT was placed on the top of a rotating table 0.8 meters (for 30 MHz ~ 1 GHz) / 1.5 meters (for above 1 GHz) above the ground at 3 meter chamber room for test. The table was rotated 360 degrees to determine the position of the highest radiation.
- b. The EUT was set 3 meters away from the interference-receiving antenna, which was mounted on the top of a variable-height antenna tower.
- c. The height of antenna is varied from one meter to four meters above the ground to determine the maximum value of the field strength. Both horizontal and vertical polarizations of the antenna are set to make the measurement.
- d. For each suspected emission, the EUT was arranged to its worst case and then the antenna was tuned to heights from 1 meter to 4 meters and the rotatable table was turned from 0 degrees to 360 degrees to find the maximum reading.
- e. The test-receiver system was set to quasi-peak detect function and specified bandwidth with maximum hold mode when the test frequency is below 1 GHz.
- f. The test-receiver system was set to peak and average detected function and specified bandwidth with maximum hold mode when the test frequency is above 1 GHz. If the peak reading value also meets average limit, measurement with the average detector is unnecessary.

Note:

1. The resolution bandwidth and video bandwidth of test receiver/spectrum analyzer is 120 kHz for Quasi-peak detection (QP) or Peak detection (PK) at frequency below 1 GHz.
2. The resolution bandwidth of test receiver/spectrum analyzer is 1 MHz and the video bandwidth is 3 MHz for Peak detection (PK) at frequency above 1 GHz.
3. The resolution bandwidth of test receiver/spectrum analyzer is 1 MHz and the video bandwidth is $\geq 1/T$ (Duty cycle < 98 %) or 10 Hz (Duty cycle ≥ 98 %) for Average detection (AV) at frequency above 1 GHz.
(11a: RBW = 1 MHz, VBW = 1 kHz ; 11n (HT20): RBW = 1 MHz, VBW = 1 kHz ;
11n (HT40): RBW = 1 MHz, VBW = 1 kHz ; 11ac (VHT80): RBW = 1 MHz, VBW = 1 kHz)
4. All modes of operation were investigated and the worst-case emissions are reported.

4.1.4 Deviation from Test Standard

No deviation.

4.1.5 Test Setup

<Radiated Emission below 30 MHz>

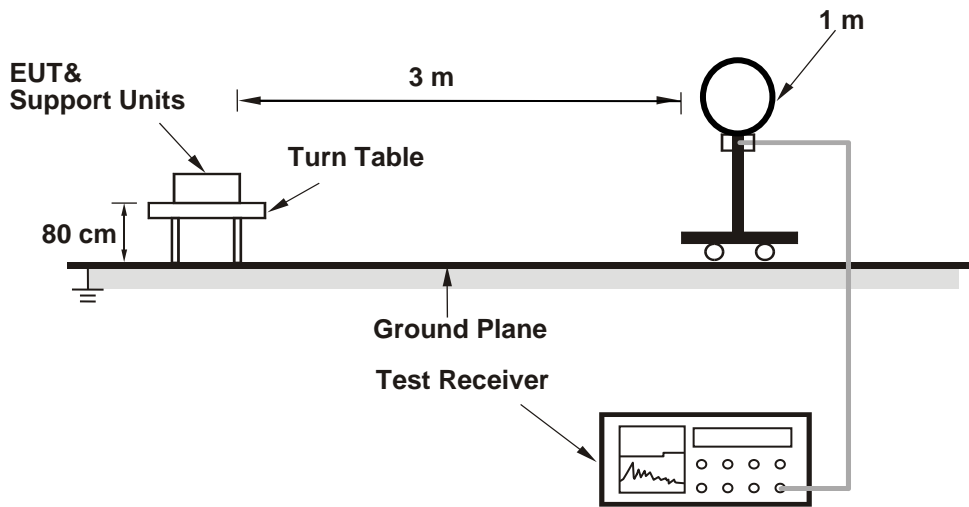

<Radiated Emission 30 MHz to 1 GHz>

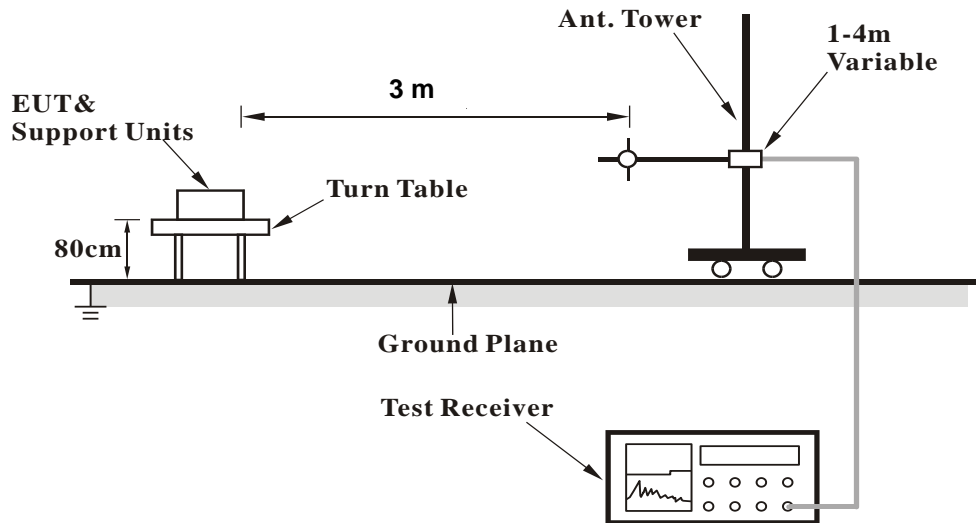

<Radiated Emission above 1 GHz>

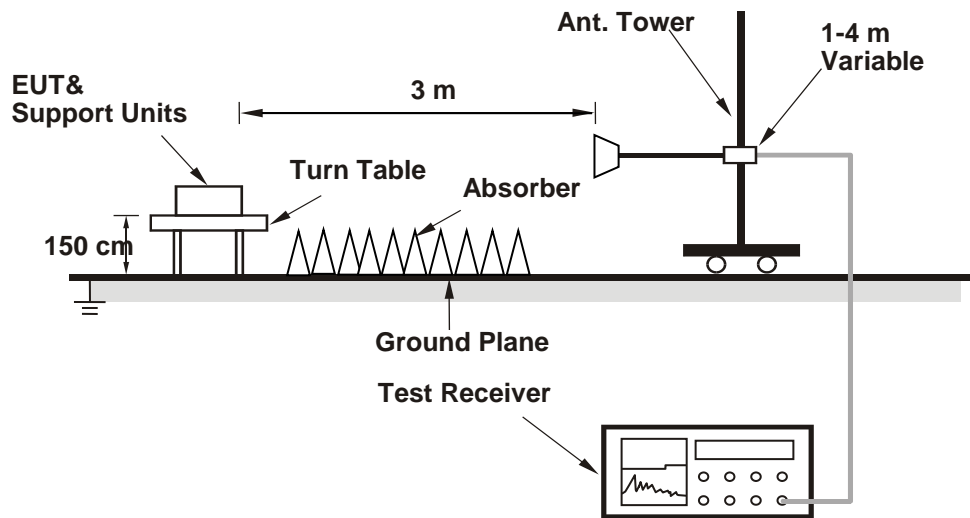

For the actual test configuration, please refer to the attached file (Test Setup Photo).

4.1.6 EUT Operating Conditions

- a. Placed the EUT on a testing table.
- b. Use the software to control the EUT under transmission condition continuously at specific channel frequency.

4.1.7 Test Results

Above 1 GHz Data :

802.11a

CHANNEL	TX Channel 36	DETECTOR FUNCTION	Peak (PK)
FREQUENCY RANGE	1GHz ~ 40GHz		Average (AV)

ANTENNA POLARITY & TEST DISTANCE: HORIZONTAL AT 3 M								
NO.	FREQ. (MHz)	EMISSION LEVEL (dBuV/m)	LIMIT (dBuV/m)	MARGIN (dB)	ANTENNA HEIGHT (m)	TABLE ANGLE (Degree)	RAW VALUE (dBuV)	CORRECTION FACTOR (dB/m)
1	5150.00	61.1 PK	74.0	-12.9	1.95 H	357	59.2	1.9
2	5150.00	44.5 AV	54.0	-9.5	1.95 H	357	42.6	1.9
3	*5180.00	107.0 PK			2.11 H	5	70.7	36.3
4	*5180.00	96.5 AV			2.11 H	5	60.2	36.3
5	#10360.00	55.9 PK	68.2	-12.3	1.91 H	133	41.0	14.9
ANTENNA POLARITY & TEST DISTANCE: VERTICAL AT 3 M								
NO.	FREQ. (MHz)	EMISSION LEVEL (dBuV/m)	LIMIT (dBuV/m)	MARGIN (dB)	ANTENNA HEIGHT (m)	TABLE ANGLE (Degree)	RAW VALUE (dBuV)	CORRECTION FACTOR (dB/m)
1	5150.00	71.5 PK	74.0	-2.5	2.05 V	12	69.6	1.9
2	5150.00	52.5 AV	54.0	-1.5	2.05 V	12	50.6	1.9
3	*5180.00	117.6 PK			1.97 V	28	81.3	36.3
4	*5180.00	106.8 AV			1.97 V	28	70.5	36.3
5	#10360.00	55.7 PK	68.2	-12.5	1.68 V	6	40.8	14.9

REMARKS:

1. Emission Level(dBuV/m) = Raw Value(dBuV) + Correction Factor(dB/m)
2. Correction Factor(dB/m) = Antenna Factor(dB/m) + Cable Factor(dB) – Pre-Amplifier Factor(dB)
3. Margin value = Emission Level – Limit value
4. The other emission levels were very low against the limit.
5. " * ": Fundamental frequency.
6. " # ": The radiated frequency is out of the restricted band.

CHANNEL	TX Channel 40	DETECTOR FUNCTION	Peak (PK)
FREQUENCY RANGE	1GHz ~ 40GHz		Average (AV)

ANTENNA POLARITY & TEST DISTANCE: HORIZONTAL AT 3 M

NO.	FREQ. (MHz)	EMISSION LEVEL (dBuV/m)	LIMIT (dBuV/m)	MARGIN (dB)	ANTENNA HEIGHT (m)	TABLE ANGLE (Degree)	RAW VALUE (dBuV)	CORRECTION FACTOR (dB/m)
1	5150.00	59.7 PK	74.0	-14.3	2.21 H	6	57.8	1.9
2	5150.00	43.4 AV	54.0	-10.6	2.21 H	6	41.5	1.9
3	*5200.00	110.5 PK			2.04 H	2	74.3	36.2
4	*5200.00	99.6 AV			2.04 H	2	63.4	36.2
5	#10400.00	55.1 PK	68.2	-13.1	1.93 H	126	40.1	15.0

ANTENNA POLARITY & TEST DISTANCE: VERTICAL AT 3 M

NO.	FREQ. (MHz)	EMISSION LEVEL (dBuV/m)	LIMIT (dBuV/m)	MARGIN (dB)	ANTENNA HEIGHT (m)	TABLE ANGLE (Degree)	RAW VALUE (dBuV)	CORRECTION FACTOR (dB/m)
1	5150.00	69.4 PK	74.0	-4.6	2.09 V	9	67.5	1.9
2	5150.00	52.3 AV	54.0	-1.7	2.09 V	9	50.4	1.9
3	*5200.00	120.8 PK			1.96 V	25	84.6	36.2
4	*5200.00	109.9 AV			1.96 V	25	73.7	36.2
5	#10400.00	55.3 PK	68.2	-12.9	1.74 V	7	40.3	15.0

REMARKS:

1. Emission Level(dBuV/m) = Raw Value(dBuV) + Correction Factor(dB/m)
2. Correction Factor(dB/m) = Antenna Factor(dB/m) + Cable Factor(dB) – Pre-Amplifier Factor(dB)
3. Margin value = Emission Level – Limit value
4. The other emission levels were very low against the limit.
5. " * ": Fundamental frequency.
6. " # ": The radiated frequency is out of the restricted band.

CHANNEL	TX Channel 48	DETECTOR FUNCTION	Peak (PK)
FREQUENCY RANGE	1GHz ~ 40GHz		Average (AV)

ANTENNA POLARITY & TEST DISTANCE: HORIZONTAL AT 3 M

NO.	FREQ. (MHz)	EMISSION LEVEL (dBuV/m)	LIMIT (dBuV/m)	MARGIN (dB)	ANTENNA HEIGHT (m)	TABLE ANGLE (Degree)	RAW VALUE (dBuV)	CORRECTION FACTOR (dB/m)
1	*5240.00	110.5 PK			2.17 H	5	74.4	36.1
2	*5240.00	99.7 AV			2.17 H	5	63.6	36.1
3	5350.00	53.4 PK	74.0	-20.6	2.02 H	1	51.5	1.9
4	5350.00	39.5 AV	54.0	-14.5	2.02 H	1	37.6	1.9
5	#10480.00	55.6 PK	68.2	-12.6	1.98 H	134	40.7	14.9

ANTENNA POLARITY & TEST DISTANCE: VERTICAL AT 3 M

NO.	FREQ. (MHz)	EMISSION LEVEL (dBuV/m)	LIMIT (dBuV/m)	MARGIN (dB)	ANTENNA HEIGHT (m)	TABLE ANGLE (Degree)	RAW VALUE (dBuV)	CORRECTION FACTOR (dB/m)
1	*5240.00	121.0 PK			2.00 V	27	84.9	36.1
2	*5240.00	110.1 AV			2.00 V	27	74.0	36.1
3	5350.00	53.1 PK	74.0	-20.9	1.90 V	34	51.2	1.9
4	5350.00	39.2 AV	54.0	-14.8	1.90 V	34	37.3	1.9
5	#10480.00	55.4 PK	68.2	-12.8	1.69 V	9	40.5	14.9

REMARKS:

1. Emission Level(dBuV/m) = Raw Value(dBuV) + Correction Factor(dB/m)
2. Correction Factor(dB/m) = Antenna Factor(dB/m) + Cable Factor(dB) – Pre-Amplifier Factor(dB)
3. Margin value = Emission Level – Limit value
4. The other emission levels were very low against the limit.
5. " * ": Fundamental frequency.
6. " # ": The radiated frequency is out of the restricted band.

CHANNEL	TX Channel 149	DETECTOR FUNCTION	Peak (PK)
FREQUENCY RANGE	1GHz ~ 40GHz		Average (AV)

ANTENNA POLARITY & TEST DISTANCE: HORIZONTAL AT 3 M

NO.	FREQ. (MHz)	EMISSION LEVEL (dBuV/m)	LIMIT (dBuV/m)	MARGIN (dB)	ANTENNA HEIGHT (m)	TABLE ANGLE (Degree)	RAW VALUE (dBuV)	CORRECTION FACTOR (dB/m)
1	#5636.80	53.2 PK	68.2	-15.0	2.04 H	3	50.7	2.5
2	*5745.00	109.6 PK			2.04 H	3	72.3	37.3
3	*5745.00	99.3 AV			2.04 H	3	62.0	37.3
4	#5960.00	53.9 PK	68.2	-14.3	2.04 H	3	50.8	3.1
5	11490.00	55.7 PK	74.0	-18.3	1.87 H	140	40.0	15.7
6	11490.00	43.1 AV	54.0	-10.9	1.87 H	140	27.4	15.7

ANTENNA POLARITY & TEST DISTANCE: VERTICAL AT 3 M

NO.	FREQ. (MHz)	EMISSION LEVEL (dBuV/m)	LIMIT (dBuV/m)	MARGIN (dB)	ANTENNA HEIGHT (m)	TABLE ANGLE (Degree)	RAW VALUE (dBuV)	CORRECTION FACTOR (dB/m)
1	#5644.00	56.3 PK	68.2	-11.9	2.20 V	37	53.7	2.6
2	*5745.00	120.1 PK			2.20 V	37	82.8	37.3
3	*5745.00	109.7 AV			2.20 V	37	72.4	37.3
4	#5984.80	54.4 PK	68.2	-13.8	2.20 V	37	51.3	3.1
5	11490.00	55.8 PK	74.0	-18.2	1.67 V	4	40.1	15.7
6	11490.00	43.3 AV	54.0	-10.7	1.67 V	4	27.6	15.7

REMARKS:

1. Emission Level(dBuV/m) = Raw Value(dBuV) + Correction Factor(dB/m)
2. Correction Factor(dB/m) = Antenna Factor(dB/m) + Cable Factor(dB) – Pre-Amplifier Factor(dB)
3. Margin value = Emission Level – Limit value
4. The other emission levels were very low against the limit.
5. " * ": Fundamental frequency.
6. " # ": The radiated frequency is out of the restricted band.

CHANNEL	TX Channel 157	DETECTOR FUNCTION	Peak (PK)
FREQUENCY RANGE	1GHz ~ 40GHz		Average (AV)

ANTENNA POLARITY & TEST DISTANCE: HORIZONTAL AT 3 M

NO.	FREQ. (MHz)	EMISSION LEVEL (dBuV/m)	LIMIT (dBuV/m)	MARGIN (dB)	ANTENNA HEIGHT (m)	TABLE ANGLE (Degree)	RAW VALUE (dBuV)	CORRECTION FACTOR (dB/m)
1	#5638.40	52.6 PK	68.2	-15.6	2.13 H	4	50.1	2.5
2	*5785.00	109.5 PK			2.13 H	4	72.0	37.5
3	*5785.00	99.0 AV			2.13 H	4	61.5	37.5
4	#5949.60	53.7 PK	68.2	-14.5	2.13 H	4	50.6	3.1
5	11570.00	56.2 PK	74.0	-17.8	1.94 H	143	40.8	15.4
6	11570.00	42.8 AV	54.0	-11.2	1.94 H	143	27.4	15.4

ANTENNA POLARITY & TEST DISTANCE: VERTICAL AT 3 M

NO.	FREQ. (MHz)	EMISSION LEVEL (dBuV/m)	LIMIT (dBuV/m)	MARGIN (dB)	ANTENNA HEIGHT (m)	TABLE ANGLE (Degree)	RAW VALUE (dBuV)	CORRECTION FACTOR (dB/m)
1	#5639.20	53.8 PK	68.2	-14.4	2.38 V	39	51.3	2.5
2	*5785.00	120.0 PK			2.38 V	39	82.5	37.5
3	*5785.00	109.4 AV			2.38 V	39	71.9	37.5
4	#5924.00	53.5 PK	68.9	-15.4	2.38 V	39	50.4	3.1
5	11570.00	56.4 PK	74.0	-17.6	1.68 V	16	41.0	15.4
6	11570.00	43.0 AV	54.0	-11.0	1.68 V	16	27.6	15.4

REMARKS:

1. Emission Level(dBuV/m) = Raw Value(dBuV) + Correction Factor(dB/m)
2. Correction Factor(dB/m) = Antenna Factor(dB/m) + Cable Factor(dB) – Pre-Amplifier Factor(dB)
3. Margin value = Emission Level – Limit value
4. The other emission levels were very low against the limit.
5. " * ": Fundamental frequency.
6. " # ": The radiated frequency is out of the restricted band.

CHANNEL	TX Channel 165	DETECTOR FUNCTION	Peak (PK)
FREQUENCY RANGE	1GHz ~ 40GHz		Average (AV)

ANTENNA POLARITY & TEST DISTANCE: HORIZONTAL AT 3 M

NO.	FREQ. (MHz)	EMISSION LEVEL (dBuV/m)	LIMIT (dBuV/m)	MARGIN (dB)	ANTENNA HEIGHT (m)	TABLE ANGLE (Degree)	RAW VALUE (dBuV)	CORRECTION FACTOR (dB/m)
1	#5628.80	53.6 PK	68.2	-14.6	2.04 H	3	51.1	2.5
2	*5825.00	109.4 PK			2.04 H	3	72.0	37.4
3	*5825.00	98.9 AV			2.04 H	3	61.5	37.4
4	#5946.40	53.8 PK	68.2	-14.4	2.04 H	3	50.7	3.1
5	11650.00	55.9 PK	74.0	-18.1	1.87 H	136	40.6	15.3
6	11650.00	42.7 AV	54.0	-11.3	1.87 H	136	27.4	15.3

ANTENNA POLARITY & TEST DISTANCE: VERTICAL AT 3 M

NO.	FREQ. (MHz)	EMISSION LEVEL (dBuV/m)	LIMIT (dBuV/m)	MARGIN (dB)	ANTENNA HEIGHT (m)	TABLE ANGLE (Degree)	RAW VALUE (dBuV)	CORRECTION FACTOR (dB/m)
1	#5620.80	53.4 PK	68.2	-14.8	2.34 V	35	50.9	2.5
2	*5825.00	119.7 PK			2.34 V	35	82.3	37.4
3	*5825.00	109.2 AV			2.34 V	35	71.8	37.4
4	#5932.00	56.5 PK	68.2	-11.7	2.34 V	35	53.4	3.1
5	11650.00	55.6 PK	74.0	-18.4	1.69 V	1	40.3	15.3
6	11650.00	43.0 AV	54.0	-11.0	1.69 V	1	27.7	15.3

REMARKS:

1. Emission Level(dBuV/m) = Raw Value(dBuV) + Correction Factor(dB/m)
2. Correction Factor(dB/m) = Antenna Factor(dB/m) + Cable Factor(dB) – Pre-Amplifier Factor(dB)
3. Margin value = Emission Level – Limit value
4. The other emission levels were very low against the limit.
5. " * ": Fundamental frequency.
6. " # ": The radiated frequency is out of the restricted band.

802.11n (HT20)

CHANNEL	TX Channel 36	DETECTOR FUNCTION	Peak (PK)
FREQUENCY RANGE	1GHz ~ 40GHz		Average (AV)

ANTENNA POLARITY & TEST DISTANCE: HORIZONTAL AT 3 M								
NO.	FREQ. (MHz)	EMISSION LEVEL (dBuV/m)	LIMIT (dBuV/m)	MARGIN (dB)	ANTENNA HEIGHT (m)	TABLE ANGLE (Degree)	RAW VALUE (dBuV)	CORRECTION FACTOR (dB/m)
1	5150.00	61.6 PK	74.0	-12.4	2.12 H	2	59.7	1.9
2	5150.00	44.5 AV	54.0	-9.5	2.12 H	2	42.6	1.9
3	*5180.00	106.2 PK			2.09 H	6	69.9	36.3
4	*5180.00	95.4 AV			2.09 H	6	59.1	36.3
5	#10360.00	55.7 PK	68.2	-12.5	1.98 H	135	40.8	14.9

ANTENNA POLARITY & TEST DISTANCE: VERTICAL AT 3 M								
NO.	FREQ. (MHz)	EMISSION LEVEL (dBuV/m)	LIMIT (dBuV/m)	MARGIN (dB)	ANTENNA HEIGHT (m)	TABLE ANGLE (Degree)	RAW VALUE (dBuV)	CORRECTION FACTOR (dB/m)
1	5150.00	68.9 PK	74.0	-5.1	1.94 V	25	67.0	1.9
2	5150.00	52.6 AV	54.0	-1.4	1.94 V	25	50.7	1.9
3	*5180.00	116.7 PK			1.94 V	7	80.4	36.3
4	*5180.00	105.8 AV			1.94 V	7	69.5	36.3
5	#10360.00	55.0 PK	68.2	-13.2	1.76 V	12	40.1	14.9

REMARKS:

1. Emission Level(dBuV/m) = Raw Value(dBuV) + Correction Factor(dB/m)
2. Correction Factor(dB/m) = Antenna Factor(dB/m) + Cable Factor(dB) – Pre-Amplifier Factor(dB)
3. Margin value = Emission Level – Limit value
4. The other emission levels were very low against the limit.
5. " * ": Fundamental frequency.
6. " # ": The radiated frequency is out of the restricted band.

CHANNEL	TX Channel 40	DETECTOR FUNCTION	Peak (PK)
FREQUENCY RANGE	1GHz ~ 40GHz		Average (AV)

ANTENNA POLARITY & TEST DISTANCE: HORIZONTAL AT 3 M

NO.	FREQ. (MHz)	EMISSION LEVEL (dBuV/m)	LIMIT (dBuV/m)	MARGIN (dB)	ANTENNA HEIGHT (m)	TABLE ANGLE (Degree)	RAW VALUE (dBuV)	CORRECTION FACTOR (dB/m)
1	5150.00	59.3 PK	74.0	-14.7	2.05 H	2	57.4	1.9
2	5150.00	42.7 AV	54.0	-11.3	2.05 H	2	40.8	1.9
3	*5200.00	110.2 PK			2.03 H	6	74.0	36.2
4	*5200.00	99.1 AV			2.03 H	6	62.9	36.2
5	#10400.00	55.4 PK	68.2	-12.8	1.92 H	129	40.4	15.0

ANTENNA POLARITY & TEST DISTANCE: VERTICAL AT 3 M

NO.	FREQ. (MHz)	EMISSION LEVEL (dBuV/m)	LIMIT (dBuV/m)	MARGIN (dB)	ANTENNA HEIGHT (m)	TABLE ANGLE (Degree)	RAW VALUE (dBuV)	CORRECTION FACTOR (dB/m)
1	5150.00	68.5 PK	74.0	-5.5	1.96 V	25	66.6	1.9
2	5150.00	50.4 AV	54.0	-3.6	1.96 V	25	48.5	1.9
3	*5200.00	120.7 PK			2.01 V	5	84.5	36.2
4	*5200.00	109.5 AV			2.01 V	5	73.3	36.2
5	#10400.00	55.5 PK	68.2	-12.7	1.72 V	16	40.5	15.0

REMARKS:

1. Emission Level(dBuV/m) = Raw Value(dBuV) + Correction Factor(dB/m)
2. Correction Factor(dB/m) = Antenna Factor(dB/m) + Cable Factor(dB) – Pre-Amplifier Factor(dB)
3. Margin value = Emission Level – Limit value
4. The other emission levels were very low against the limit.
5. " * ": Fundamental frequency.
6. " # ": The radiated frequency is out of the restricted band.

CHANNEL	TX Channel 48	DETECTOR FUNCTION	Peak (PK)
FREQUENCY RANGE	1GHz ~ 40GHz		Average (AV)

ANTENNA POLARITY & TEST DISTANCE: HORIZONTAL AT 3 M

NO.	FREQ. (MHz)	EMISSION LEVEL (dBuV/m)	LIMIT (dBuV/m)	MARGIN (dB)	ANTENNA HEIGHT (m)	TABLE ANGLE (Degree)	RAW VALUE (dBuV)	CORRECTION FACTOR (dB/m)
1	*5240.00	110.1 PK			2.01 H	6	74.0	36.1
2	*5240.00	99.4 AV			2.01 H	6	63.3	36.1
3	5350.00	53.4 PK	74.0	-20.6	2.05 H	6	51.5	1.9
4	5350.00	39.4 AV	54.0	-14.6	2.05 H	6	37.5	1.9
5	#10480.00	55.9 PK	68.2	-12.3	2.00 H	136	41.0	14.9

ANTENNA POLARITY & TEST DISTANCE: VERTICAL AT 3 M

NO.	FREQ. (MHz)	EMISSION LEVEL (dBuV/m)	LIMIT (dBuV/m)	MARGIN (dB)	ANTENNA HEIGHT (m)	TABLE ANGLE (Degree)	RAW VALUE (dBuV)	CORRECTION FACTOR (dB/m)
1	*5240.00	120.6 PK			1.99 V	28	84.5	36.1
2	*5240.00	109.8 AV			1.99 V	28	73.7	36.1
3	5350.00	53.6 PK	74.0	-20.4	1.98 V	28	51.7	1.9
4	5350.00	39.6 AV	54.0	-14.4	1.98 V	28	37.7	1.9
5	#10480.00	55.8 PK	68.2	-12.4	1.74 V	7	40.9	14.9

REMARKS:

1. Emission Level(dBuV/m) = Raw Value(dBuV) + Correction Factor(dB/m)
2. Correction Factor(dB/m) = Antenna Factor(dB/m) + Cable Factor(dB) – Pre-Amplifier Factor(dB)
3. Margin value = Emission Level – Limit value
4. The other emission levels were very low against the limit.
5. " * ": Fundamental frequency.
6. " # ": The radiated frequency is out of the restricted band.

CHANNEL	TX Channel 149	DETECTOR FUNCTION	Peak (PK)
FREQUENCY RANGE	1GHz ~ 40GHz		Average (AV)

ANTENNA POLARITY & TEST DISTANCE: HORIZONTAL AT 3 M

NO.	FREQ. (MHz)	EMISSION LEVEL (dBuV/m)	LIMIT (dBuV/m)	MARGIN (dB)	ANTENNA HEIGHT (m)	TABLE ANGLE (Degree)	RAW VALUE (dBuV)	CORRECTION FACTOR (dB/m)
1	#5612.80	52.8 PK	68.2	-15.4	2.09 H	6	50.4	2.4
2	*5745.00	109.9 PK			2.09 H	6	72.6	37.3
3	*5745.00	99.4 AV			2.09 H	6	62.1	37.3
4	#5979.20	53.9 PK	68.2	-14.3	2.09 H	6	50.8	3.1
5	11490.00	56.1 PK	74.0	-17.9	1.90 H	126	40.4	15.7
6	11490.00	43.2 AV	54.0	-10.8	1.90 H	126	27.5	15.7

ANTENNA POLARITY & TEST DISTANCE: VERTICAL AT 3 M

NO.	FREQ. (MHz)	EMISSION LEVEL (dBuV/m)	LIMIT (dBuV/m)	MARGIN (dB)	ANTENNA HEIGHT (m)	TABLE ANGLE (Degree)	RAW VALUE (dBuV)	CORRECTION FACTOR (dB/m)
1	#5644.80	56.2 PK	68.2	-12.0	2.26 V	39	53.6	2.6
2	*5745.00	120.2 PK			2.26 V	39	82.9	37.3
3	*5745.00	109.7 AV			2.26 V	39	72.4	37.3
4	#5949.60	54.0 PK	68.2	-14.2	2.26 V	39	50.9	3.1
5	11490.00	56.2 PK	74.0	-17.8	1.68 V	7	40.5	15.7
6	11490.00	43.5 AV	54.0	-10.5	1.68 V	7	27.8	15.7

REMARKS:

1. Emission Level(dBuV/m) = Raw Value(dBuV) + Correction Factor(dB/m)
2. Correction Factor(dB/m) = Antenna Factor(dB/m) + Cable Factor(dB) – Pre-Amplifier Factor(dB)
3. Margin value = Emission Level – Limit value
4. The other emission levels were very low against the limit.
5. " * ": Fundamental frequency.
6. " # ": The radiated frequency is out of the restricted band.

CHANNEL	TX Channel 157	DETECTOR FUNCTION	Peak (PK)
FREQUENCY RANGE	1GHz ~ 40GHz		Average (AV)

ANTENNA POLARITY & TEST DISTANCE: HORIZONTAL AT 3 M

NO.	FREQ. (MHz)	EMISSION LEVEL (dBuV/m)	LIMIT (dBuV/m)	MARGIN (dB)	ANTENNA HEIGHT (m)	TABLE ANGLE (Degree)	RAW VALUE (dBuV)	CORRECTION FACTOR (dB/m)
1	#5620.00	53.3 PK	68.2	-14.9	2.20 H	4	50.8	2.5
2	*5785.00	110.4 PK			2.20 H	4	72.9	37.5
3	*5785.00	99.4 AV			2.20 H	4	61.9	37.5
4	#5939.20	53.4 PK	68.2	-14.8	2.20 H	4	50.3	3.1
5	11570.00	55.9 PK	74.0	-18.1	1.98 H	127	40.5	15.4
6	11570.00	42.8 AV	54.0	-11.2	1.98 H	127	27.4	15.4

ANTENNA POLARITY & TEST DISTANCE: VERTICAL AT 3 M

NO.	FREQ. (MHz)	EMISSION LEVEL (dBuV/m)	LIMIT (dBuV/m)	MARGIN (dB)	ANTENNA HEIGHT (m)	TABLE ANGLE (Degree)	RAW VALUE (dBuV)	CORRECTION FACTOR (dB/m)
1	#5629.60	53.7 PK	68.2	-14.5	2.38 V	36	51.2	2.5
2	*5785.00	120.5 PK			2.38 V	36	83.0	37.5
3	*5785.00	109.6 AV			2.38 V	36	72.1	37.5
4	#5987.20	53.6 PK	68.2	-14.6	2.38 V	36	50.5	3.1
5	11570.00	55.6 PK	74.0	-18.4	1.76 V	14	40.2	15.4
6	11570.00	43.0 AV	54.0	-11.0	1.76 V	14	27.6	15.4

REMARKS:

1. Emission Level(dBuV/m) = Raw Value(dBuV) + Correction Factor(dB/m)
2. Correction Factor(dB/m) = Antenna Factor(dB/m) + Cable Factor(dB) – Pre-Amplifier Factor(dB)
3. Margin value = Emission Level – Limit value
4. The other emission levels were very low against the limit.
5. " * ": Fundamental frequency.
6. " # ": The radiated frequency is out of the restricted band.

CHANNEL	TX Channel 165	DETECTOR FUNCTION	Peak (PK)
FREQUENCY RANGE	1GHz ~ 40GHz		Average (AV)

ANTENNA POLARITY & TEST DISTANCE: HORIZONTAL AT 3 M

NO.	FREQ. (MHz)	EMISSION LEVEL (dBuV/m)	LIMIT (dBuV/m)	MARGIN (dB)	ANTENNA HEIGHT (m)	TABLE ANGLE (Degree)	RAW VALUE (dBuV)	CORRECTION FACTOR (dB/m)
1	#5613.60	53.5 PK	68.2	-14.7	2.20 H	5	51.0	2.5
2	*5825.00	109.3 PK			2.20 H	5	71.9	37.4
3	*5825.00	99.0 AV			2.20 H	5	61.6	37.4
4	#5976.00	53.7 PK	68.2	-14.5	2.20 H	5	50.6	3.1
5	11650.00	56.0 PK	74.0	-18.0	1.85 H	129	40.7	15.3
6	11650.00	43.1 AV	54.0	-10.9	1.85 H	129	27.8	15.3

ANTENNA POLARITY & TEST DISTANCE: VERTICAL AT 3 M

NO.	FREQ. (MHz)	EMISSION LEVEL (dBuV/m)	LIMIT (dBuV/m)	MARGIN (dB)	ANTENNA HEIGHT (m)	TABLE ANGLE (Degree)	RAW VALUE (dBuV)	CORRECTION FACTOR (dB/m)
1	#5637.60	53.6 PK	68.2	-14.6	2.36 V	34	51.1	2.5
2	*5825.00	119.4 PK			2.36 V	34	82.0	37.4
3	*5825.00	109.2 AV			2.36 V	34	71.8	37.4
4	#5940.80	58.6 PK	68.2	-9.6	2.36 V	34	55.5	3.1
5	11650.00	55.5 PK	74.0	-18.5	1.71 V	11	40.2	15.3
6	11650.00	43.0 AV	54.0	-11.0	1.71 V	11	27.7	15.3

REMARKS:

1. Emission Level(dBuV/m) = Raw Value(dBuV) + Correction Factor(dB/m)
2. Correction Factor(dB/m) = Antenna Factor(dB/m) + Cable Factor(dB) – Pre-Amplifier Factor(dB)
3. Margin value = Emission Level – Limit value
4. The other emission levels were very low against the limit.
5. " * ": Fundamental frequency.
6. " # ": The radiated frequency is out of the restricted band.

802.11n (HT40)

CHANNEL	TX Channel 38	DETECTOR FUNCTION	Peak (PK)
FREQUENCY RANGE	1GHz ~ 40GHz		Average (AV)

ANTENNA POLARITY & TEST DISTANCE: HORIZONTAL AT 3 M								
NO.	FREQ. (MHz)	EMISSION LEVEL (dBuV/m)	LIMIT (dBuV/m)	MARGIN (dB)	ANTENNA HEIGHT (m)	TABLE ANGLE (Degree)	RAW VALUE (dBuV)	CORRECTION FACTOR (dB/m)
1	5150.00	61.2 PK	74.0	-12.8	2.12 H	4	59.3	1.9
2	5150.00	44.8 AV	54.0	-9.2	2.12 H	4	42.9	1.9
3	*5190.00	101.3 PK			2.06 H	4	65.1	36.2
4	*5190.00	91.8 AV			2.06 H	4	55.6	36.2
5	#10380.00	55.8 PK	68.2	-12.4	1.86 H	133	40.8	15.0

ANTENNA POLARITY & TEST DISTANCE: VERTICAL AT 3 M								
NO.	FREQ. (MHz)	EMISSION LEVEL (dBuV/m)	LIMIT (dBuV/m)	MARGIN (dB)	ANTENNA HEIGHT (m)	TABLE ANGLE (Degree)	RAW VALUE (dBuV)	CORRECTION FACTOR (dB/m)
1	5150.00	69.4 PK	74.0	-4.6	1.97 V	9	67.5	1.9
2	5150.00	53.0 AV	54.0	-1.0	1.97 V	9	51.1	1.9
3	*5190.00	111.6 PK			1.95 V	29	75.4	36.2
4	*5190.00	102.1 AV			1.95 V	29	65.9	36.2
5	#10380.00	55.0 PK	68.2	-13.2	1.73 V	12	40.0	15.0

REMARKS:

- Emission Level(dBuV/m) = Raw Value(dBuV) + Correction Factor(dB/m)
- Correction Factor(dB/m) = Antenna Factor(dB/m) + Cable Factor(dB) – Pre-Amplifier Factor(dB)
- Margin value = Emission Level – Limit value
- The other emission levels were very low against the limit.
- " * ": Fundamental frequency.
- " # ": The radiated frequency is out of the restricted band.

CHANNEL	TX Channel 46	DETECTOR FUNCTION	Peak (PK)
FREQUENCY RANGE	1GHz ~ 40GHz		Average (AV)

ANTENNA POLARITY & TEST DISTANCE: HORIZONTAL AT 3 M

NO.	FREQ. (MHz)	EMISSION LEVEL (dBuV/m)	LIMIT (dBuV/m)	MARGIN (dB)	ANTENNA HEIGHT (m)	TABLE ANGLE (Degree)	RAW VALUE (dBuV)	CORRECTION FACTOR (dB/m)
1	5150.00	61.2 PK	74.0	-12.8	2.10 H	2	59.3	1.9
2	5150.00	44.2 AV	54.0	-9.8	2.10 H	2	42.3	1.9
3	*5230.00	105.5 PK			2.05 H	2	69.3	36.2
4	*5230.00	95.7 AV			2.05 H	2	59.5	36.2
5	5350.00	53.3 PK	74.0	-20.7	2.21 H	5	51.4	1.9
6	5350.00	39.5 AV	54.0	-14.5	2.21 H	5	37.6	1.9
7	#10460.00	55.5 PK	68.2	-12.7	1.93 H	129	40.6	14.9

ANTENNA POLARITY & TEST DISTANCE: VERTICAL AT 3 M

NO.	FREQ. (MHz)	EMISSION LEVEL (dBuV/m)	LIMIT (dBuV/m)	MARGIN (dB)	ANTENNA HEIGHT (m)	TABLE ANGLE (Degree)	RAW VALUE (dBuV)	CORRECTION FACTOR (dB/m)
1	5150.00	68.3 PK	74.0	-5.7	2.00 V	7	66.4	1.9
2	5150.00	52.5 AV	54.0	-1.5	2.00 V	7	50.6	1.9
3	*5230.00	115.8 PK			2.01 V	28	79.6	36.2
4	*5230.00	106.0 AV			2.01 V	28	69.8	36.2
5	5350.00	53.3 PK	74.0	-20.7	2.03 V	16	51.4	1.9
6	5350.00	39.5 AV	54.0	-14.5	2.03 V	16	37.6	1.9
7	#10460.00	55.9 PK	68.2	-12.3	1.70 V	10	41.0	14.9

REMARKS:

1. Emission Level(dBuV/m) = Raw Value(dBuV) + Correction Factor(dB/m)
2. Correction Factor(dB/m) = Antenna Factor(dB/m) + Cable Factor(dB) – Pre-Amplifier Factor(dB)
3. Margin value = Emission Level – Limit value
4. The other emission levels were very low against the limit.
5. " * ": Fundamental frequency.
6. " # ": The radiated frequency is out of the restricted band.

CHANNEL	TX Channel 151	DETECTOR FUNCTION	Peak (PK)
FREQUENCY RANGE	1GHz ~ 40GHz		Average (AV)

ANTENNA POLARITY & TEST DISTANCE: HORIZONTAL AT 3 M

NO.	FREQ. (MHz)	EMISSION LEVEL (dBuV/m)	LIMIT (dBuV/m)	MARGIN (dB)	ANTENNA HEIGHT (m)	TABLE ANGLE (Degree)	RAW VALUE (dBuV)	CORRECTION FACTOR (dB/m)
1	#5644.80	58.0 PK	68.2	-10.2	2.17 H	5	55.4	2.6
2	*5755.00	106.8 PK			2.17 H	5	69.5	37.3
3	*5755.00	96.8 AV			2.17 H	5	59.5	37.3
4	#5933.60	53.3 PK	68.2	-14.9	2.17 H	5	50.2	3.1
5	11510.00	55.9 PK	74.0	-18.1	1.88 H	136	40.3	15.6
6	11510.00	43.1 AV	54.0	-10.9	1.88 H	136	27.5	15.6

ANTENNA POLARITY & TEST DISTANCE: VERTICAL AT 3 M

NO.	FREQ. (MHz)	EMISSION LEVEL (dBuV/m)	LIMIT (dBuV/m)	MARGIN (dB)	ANTENNA HEIGHT (m)	TABLE ANGLE (Degree)	RAW VALUE (dBuV)	CORRECTION FACTOR (dB/m)
1	#5648.80	66.8 PK	68.2	-1.4	2.33 V	52	64.2	2.6
2	*5755.00	116.9 PK			2.33 V	52	79.6	37.3
3	*5755.00	107.0 AV			2.33 V	52	69.7	37.3
4	#5937.60	55.4 PK	68.2	-12.8	2.33 V	52	52.3	3.1
5	11510.00	56.5 PK	74.0	-17.5	1.64 V	14	40.9	15.6
6	11510.00	43.3 AV	54.0	-10.7	1.64 V	14	27.7	15.6

REMARKS:

1. Emission Level(dBuV/m) = Raw Value(dBuV) + Correction Factor(dB/m)
2. Correction Factor(dB/m) = Antenna Factor(dB/m) + Cable Factor(dB) – Pre-Amplifier Factor(dB)
3. Margin value = Emission Level – Limit value
4. The other emission levels were very low against the limit.
5. " * ": Fundamental frequency.
6. " # ": The radiated frequency is out of the restricted band.

CHANNEL	TX Channel 159	DETECTOR FUNCTION	Peak (PK)
FREQUENCY RANGE	1GHz ~ 40GHz		Average (AV)

ANTENNA POLARITY & TEST DISTANCE: HORIZONTAL AT 3 M

NO.	FREQ. (MHz)	EMISSION LEVEL (dBuV/m)	LIMIT (dBuV/m)	MARGIN (dB)	ANTENNA HEIGHT (m)	TABLE ANGLE (Degree)	RAW VALUE (dBuV)	CORRECTION FACTOR (dB/m)
1	#5640.80	53.9 PK	68.2	-14.3	2.11 H	4	51.3	2.6
2	*5795.00	106.8 PK			2.11 H	4	69.3	37.5
3	*5795.00	96.6 AV			2.11 H	4	59.1	37.5
4	#5932.00	55.0 PK	68.2	-13.2	2.11 H	4	51.9	3.1
5	11590.00	55.4 PK	74.0	-18.6	1.93 H	134	40.2	15.2
6	11590.00	43.0 AV	54.0	-11.0	1.93 H	134	27.8	15.2

ANTENNA POLARITY & TEST DISTANCE: VERTICAL AT 3 M

NO.	FREQ. (MHz)	EMISSION LEVEL (dBuV/m)	LIMIT (dBuV/m)	MARGIN (dB)	ANTENNA HEIGHT (m)	TABLE ANGLE (Degree)	RAW VALUE (dBuV)	CORRECTION FACTOR (dB/m)
1	#5643.20	57.6 PK	68.2	-10.6	2.31 V	50	55.0	2.6
2	*5795.00	117.3 PK			2.31 V	50	79.8	37.5
3	*5795.00	107.0 AV			2.31 V	50	69.5	37.5
4	#5930.40	63.1 PK	68.2	-5.1	2.31 V	50	60.0	3.1
5	11590.00	56.0 PK	74.0	-18.0	1.60 V	13	40.8	15.2
6	11590.00	43.0 AV	54.0	-11.0	1.60 V	13	27.8	15.2

REMARKS:

1. Emission Level(dBuV/m) = Raw Value(dBuV) + Correction Factor(dB/m)
2. Correction Factor(dB/m) = Antenna Factor(dB/m) + Cable Factor(dB) – Pre-Amplifier Factor(dB)
3. Margin value = Emission Level – Limit value
4. The other emission levels were very low against the limit.
5. " * ": Fundamental frequency.
6. " # ": The radiated frequency is out of the restricted band.

802.11ac (VHT80)

CHANNEL	TX Channel 42	DETECTOR FUNCTION	Peak (PK)
FREQUENCY RANGE	1GHz ~ 40GHz		Average (AV)

ANTENNA POLARITY & TEST DISTANCE: HORIZONTAL AT 3 M								
NO.	FREQ. (MHz)	EMISSION LEVEL (dBuV/m)	LIMIT (dBuV/m)	MARGIN (dB)	ANTENNA HEIGHT (m)	TABLE ANGLE (Degree)	RAW VALUE (dBuV)	CORRECTION FACTOR (dB/m)
1	5150.00	61.5 PK	74.0	-12.5	2.13 H	1	59.6	1.9
2	5150.00	44.4 AV	54.0	-9.6	2.13 H	1	42.5	1.9
3	*5210.00	96.1 PK			2.04 H	4	59.9	36.2
4	*5210.00	86.2 AV			2.04 H	4	50.0	36.2
5	5350.00	52.9 PK	74.0	-21.1	2.01 H	6	51.0	1.9
6	5350.00	39.7 AV	54.0	-14.3	2.01 H	6	37.8	1.9
7	#10420.00	55.9 PK	68.2	-12.3	1.92 H	131	40.9	15.0

ANTENNA POLARITY & TEST DISTANCE: VERTICAL AT 3 M								
NO.	FREQ. (MHz)	EMISSION LEVEL (dBuV/m)	LIMIT (dBuV/m)	MARGIN (dB)	ANTENNA HEIGHT (m)	TABLE ANGLE (Degree)	RAW VALUE (dBuV)	CORRECTION FACTOR (dB/m)
1	5150.00	66.0 PK	74.0	-8.0	2.04 V	6	64.1	1.9
2	5150.00	52.5 AV	54.0	-1.5	2.04 V	6	50.6	1.9
3	*5210.00	106.6 PK			2.06 V	26	70.4	36.2
4	*5210.00	96.6 AV			2.06 V	26	60.4	36.2
5	5350.00	54.4 PK	74.0	-19.6	2.04 V	6	52.5	1.9
6	5350.00	41.4 AV	54.0	-12.6	2.04 V	6	39.5	1.9
7	#10420.00	55.4 PK	68.2	-12.8	1.66 V	12	40.4	15.0

REMARKS:

1. Emission Level(dBuV/m) = Raw Value(dBuV) + Correction Factor(dB/m)
2. Correction Factor(dB/m) = Antenna Factor(dB/m) + Cable Factor(dB) – Pre-Amplifier Factor(dB)
3. Margin value = Emission Level – Limit value
4. The other emission levels were very low against the limit.
5. " * ": Fundamental frequency.
6. " # ": The radiated frequency is out of the restricted band.

CHANNEL	TX Channel 155	DETECTOR FUNCTION	Peak (PK)
FREQUENCY RANGE	1GHz ~ 40GHz		Average (AV)

ANTENNA POLARITY & TEST DISTANCE: HORIZONTAL AT 3 M

NO.	FREQ. (MHz)	EMISSION LEVEL (dBuV/m)	LIMIT (dBuV/m)	MARGIN (dB)	ANTENNA HEIGHT (m)	TABLE ANGLE (Degree)	RAW VALUE (dBuV)	CORRECTION FACTOR (dB/m)
1	#5641.60	55.0 PK	68.2	-13.2	2.16 H	2	52.4	2.6
2	*5775.00	99.4 PK			2.16 H	2	61.9	37.5
3	*5775.00	89.3 AV			2.16 H	2	51.8	37.5
4	#5938.40	55.0 PK	68.2	-13.2	2.16 H	2	51.9	3.1
5	11550.00	55.9 PK	74.0	-18.1	1.95 H	131	40.4	15.5
6	11550.00	43.1 AV	54.0	-10.9	1.95 H	131	27.6	15.5

ANTENNA POLARITY & TEST DISTANCE: VERTICAL AT 3 M

NO.	FREQ. (MHz)	EMISSION LEVEL (dBuV/m)	LIMIT (dBuV/m)	MARGIN (dB)	ANTENNA HEIGHT (m)	TABLE ANGLE (Degree)	RAW VALUE (dBuV)	CORRECTION FACTOR (dB/m)
1	#5643.20	66.7 PK	68.2	-1.5	2.23 V	48	64.1	2.6
2	*5775.00	109.7 PK			2.23 V	48	72.2	37.5
3	*5775.00	99.6 AV			2.23 V	48	62.1	37.5
4	#5925.00	63.8 PK	68.2	-4.4	2.23 V	48	60.7	3.1
5	11550.00	55.9 PK	74.0	-18.1	1.75 V	5	40.4	15.5
6	11550.00	43.2 AV	54.0	-10.8	1.75 V	5	27.7	15.5

REMARKS:

1. Emission Level(dBuV/m) = Raw Value(dBuV) + Correction Factor(dB/m)
2. Correction Factor(dB/m) = Antenna Factor(dB/m) + Cable Factor(dB) – Pre-Amplifier Factor(dB)
3. Margin value = Emission Level – Limit value
4. The other emission levels were very low against the limit.
5. " * ": Fundamental frequency.
6. " # ": The radiated frequency is out of the restricted band.

9 kHz ~ 30 MHz Data:

The amplitude of spurious emissions attenuated more than 20 dB below the permissible value is not required to be report.

30 MHz ~ 1 GHz Worst-Case Data:

802.11n (HT40)

Mode A

CHANNEL	TX Channel 38	DETECTOR FUNCTION	Quasi-Peak (QP)
FREQUENCY RANGE	30MHz ~ 1GHz		

ANTENNA POLARITY & TEST DISTANCE: HORIZONTAL AT 3 M								
NO.	FREQ. (MHz)	EMISSION LEVEL (dBuV/m)	LIMIT (dBuV/m)	MARGIN (dB)	ANTENNA HEIGHT (m)	TABLE ANGLE (Degree)	RAW VALUE (dBuV)	CORRECTION FACTOR (dB/m)
1	49.40	35.2 QP	40.0	-4.8	1.00 H	140	44.9	-9.7
2	62.01	37.9 QP	40.0	-2.1	1.00 H	6	48.4	-10.5
3	88.20	26.7 QP	43.5	-16.8	1.00 H	56	41.6	-14.9
4	140.58	27.7 QP	43.5	-15.8	1.00 H	110	37.6	-9.9
5	165.80	28.4 QP	43.5	-15.1	1.00 H	35	37.6	-9.2
6	223.03	21.1 QP	46.0	-24.9	1.00 H	275	33.1	-12.0

REMARKS:

1. Emission Level(dBuV/m) = Raw Value(dBuV) + Correction Factor(dB/m)
2. Correction Factor(dB/m) = Antenna Factor(dB/m) + Cable Factor(dB) – Pre-Amplifier Factor(dB)
3. Margin value = Emission Level – Limit value
4. The other emission levels were very low against the limit of frequency range 30MHz~1000MHz.
5. The emission levels were very low against the limit of frequency range 9kHz~30MHz: the amplitude of spurious emissions attenuated more than 20 dB below the permissible value to be report.

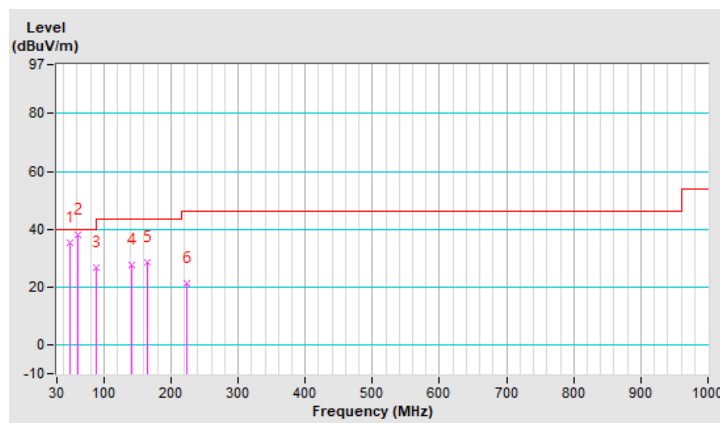

CHANNEL	TX Channel 38	DETECTOR FUNCTION	Quasi-Peak (QP)
FREQUENCY RANGE	30MHz ~ 1GHz		

ANTENNA POLARITY & TEST DISTANCE: VERTICAL AT 3 M								
NO.	FREQ. (MHz)	EMISSION LEVEL (dBuV/m)	LIMIT (dBuV/m)	MARGIN (dB)	ANTENNA HEIGHT (m)	TABLE ANGLE (Degree)	RAW VALUE (dBuV)	CORRECTION FACTOR (dB/m)
1	44.55	32.0 QP	40.0	-8.0	1.00 V	95	42.0	-10.0
2	62.01	36.1 QP	40.0	-3.9	1.00 V	226	46.6	-10.5
3	90.14	20.0 QP	43.5	-23.5	1.00 V	58	35.0	-15.0
4	113.42	19.9 QP	43.5	-23.6	1.00 V	165	32.2	-12.3
5	165.80	28.6 QP	43.5	-14.9	1.00 V	193	37.8	-9.2
6	481.05	26.1 QP	46.0	-19.9	1.00 V	35	30.2	-4.1

REMARKS:

1. Emission Level(dBuV/m) = Raw Value(dBuV) + Correction Factor(dB/m)
2. Correction Factor(dB/m) = Antenna Factor(dB/m) + Cable Factor(dB) – Pre-Amplifier Factor(dB)
3. Margin value = Emission Level – Limit value
4. The other emission levels were very low against the limit of frequency range 30MHz~1000MHz.
5. The emission levels were very low against the limit of frequency range 9kHz~30MHz: the amplitude of spurious emissions attenuated more than 20 dB below the permissible value to be report.

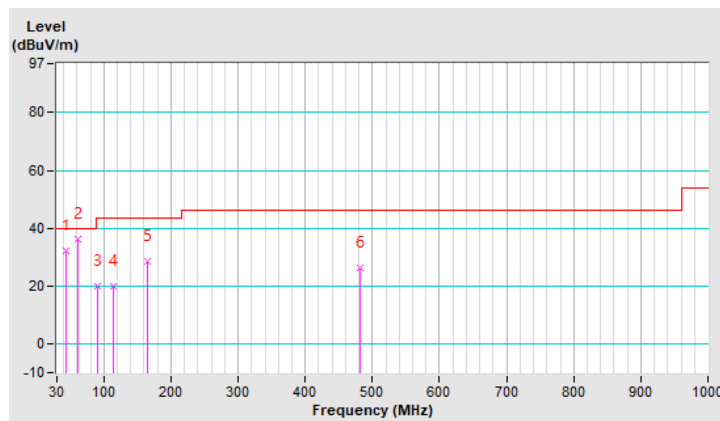

Mode B

CHANNEL	TX Channel 38	DETECTOR FUNCTION	Quasi-Peak (QP)
FREQUENCY RANGE	30MHz ~ 1GHz		

ANTENNA POLARITY & TEST DISTANCE: HORIZONTAL AT 3 M								
NO.	FREQ. (MHz)	EMISSION LEVEL (dBuV/m)	LIMIT (dBuV/m)	MARGIN (dB)	ANTENNA HEIGHT (m)	TABLE ANGLE (Degree)	RAW VALUE (dBuV)	CORRECTION FACTOR (dB/m)
1	62.01	37.9 QP	40.0	-2.1	1.00 H	6	48.4	-10.5
2	166.77	28.7 QP	43.5	-14.8	1.00 H	16	38.0	-9.3
3	543.13	28.2 QP	46.0	-17.8	1.00 H	351	31.2	-3.0
4	745.86	39.9 QP	46.0	-6.1	1.00 H	299	39.3	0.6
5	909.79	38.0 QP	46.0	-8.0	1.00 H	152	34.2	3.8
6	994.18	34.2 QP	54.0	-19.8	1.00 H	327	29.4	4.8

REMARKS:

1. Emission Level(dBuV/m) = Raw Value(dBuV) + Correction Factor(dB/m)
2. Correction Factor(dB/m) = Antenna Factor(dB/m) + Cable Factor(dB) – Pre-Amplifier Factor(dB)
3. Margin value = Emission Level – Limit value
4. The other emission levels were very low against the limit of frequency range 30MHz~1000MHz.
5. The emission levels were very low against the limit of frequency range 9kHz~30MHz: the amplitude of spurious emissions attenuated more than 20 dB below the permissible value to be report.

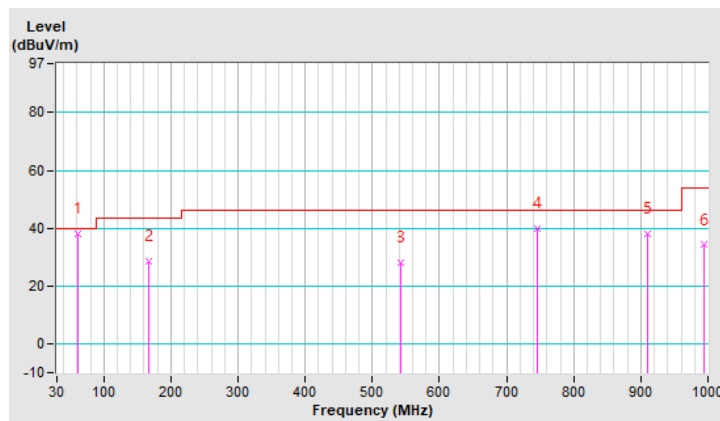

CHANNEL	TX Channel 38	DETECTOR FUNCTION	Quasi-Peak (QP)
FREQUENCY RANGE	30MHz ~ 1GHz		

ANTENNA POLARITY & TEST DISTANCE: VERTICAL AT 3 M

NO.	FREQ. (MHz)	EMISSION LEVEL (dBuV/m)	LIMIT (dBuV/m)	MARGIN (dB)	ANTENNA HEIGHT (m)	TABLE ANGLE (Degree)	RAW VALUE (dBuV)	CORRECTION FACTOR (dB/m)
1	30.00	33.4 QP	40.0	-6.6	1.00 V	92	44.7	-11.3
2	63.01	36.0 QP	40.0	-4.0	1.00 V	226	46.6	-10.6
3	166.80	28.5 QP	43.5	-15.0	2.00 V	193	37.8	-9.3
4	650.80	28.9 QP	46.0	-17.1	1.00 V	352	30.0	-1.1
5	800.18	35.2 QP	46.0	-10.8	1.50 V	316	33.7	1.5
6	909.79	38.0 QP	46.0	-8.0	1.00 V	269	34.2	3.8

REMARKS:

1. Emission Level(dBuV/m) = Raw Value(dBuV) + Correction Factor(dB/m)
2. Correction Factor(dB/m) = Antenna Factor(dB/m) + Cable Factor(dB) – Pre-Amplifier Factor(dB)
3. Margin value = Emission Level – Limit value
4. The other emission levels were very low against the limit of frequency range 30MHz~1000MHz.
5. The emission levels were very low against the limit of frequency range 9kHz~30MHz: the amplitude of spurious emissions attenuated more than 20 dB below the permissible value to be report.

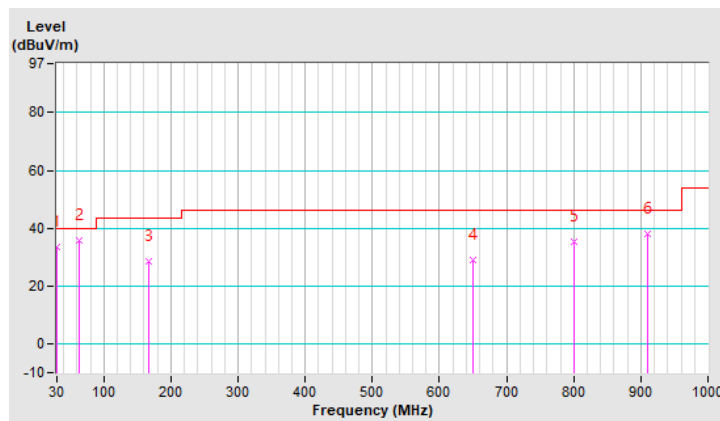

4.2 Conducted Emission Measurement

4.2.1 Limits of Conducted Emission Measurement

Frequency (MHz)	Conducted Limit (dBuV)	
	Quasi-Peak	Average
0.15 - 0.5	66 - 56	56 - 46
0.50 - 5.0	56	46
5.0 - 30.0	60	50

- Note: 1. The lower limit shall apply at the transition frequencies.
 2. The limit decreases in line with the logarithm of the frequency in the range of 0.15 to 0.50 MHz.

4.2.2 Test Instruments

Description & Manufacturer	Model No.	Serial No.	Date of Calibration	Due Date of Calibration
Test Receiver ROHDE & SCHWARZ	ESR3	102412	Feb. 19, 2019	Feb. 18, 2020
RF signal cable (with 10dB PAD) Woken	5D-FB	Cable-cond2-01	Sep. 05, 2019	Sep. 04, 2020
LISN ROHDE & SCHWARZ (EUT)	ESH2-Z5	100100	Jan. 20, 2020	Jan. 19, 2021
LISN ROHDE & SCHWARZ (Peripheral)	ESH3-Z5	100312	Aug. 13, 2019	Aug. 12, 2020
Software ADT	BV ADT_Cond_ V7.3.7.4	NA	NA	NA

- Note: 1. The calibration interval of the above test instruments is 12 months and the calibrations are traceable to NML/ROC and NIST/USA.
 2. The test was performed in HwaYa Shielded Room 2.
 3. The VCCI Site Registration No. is C-12047.

4.2.3 Test Procedures

- a. The EUT was placed 0.4 meters from the conducting wall of the shielded room with EUT being connected to the power mains through a line impedance stabilization network (LISN). Other support units were connected to the power mains through another LISN. The two LISNs provide 50 ohm/ 50uH of coupling impedance for the measuring instrument.
- b. Both lines of the power mains connected to the EUT were checked for maximum conducted interference.
- c. The frequency range from 150 kHz to 30 MHz was searched. Emission levels under (Limit -20 dB) was not recorded.

Note: All modes of operation were investigated and the worst-case emissions are reported.

4.2.4 Deviation from Test Standard

No deviation.

4.2.5 Test Setup

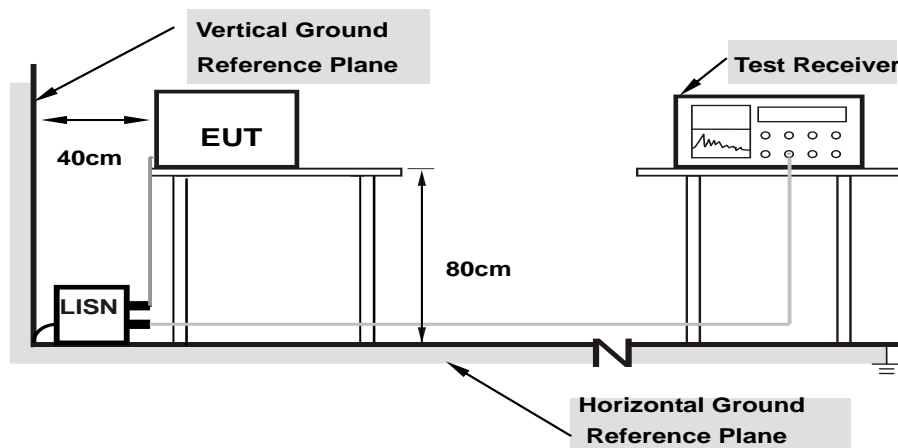

- Note:**
1. Support units were connected to second LISN.
 2. Both of LISNs (AMN) are 80 cm from EUT and at least 80 from other units and other metal planes

For the actual test configuration, please refer to the attached file (Test Setup Photo).

4.2.6 EUT Operating Conditions

- a. Placed the EUT on a testing table.
- b. Use the software to control the EUT under transmission condition continuously at specific channel frequency.

4.2.7 Test Results

Frequency Range	150kHz ~ 30MHz	Detector Function & Resolution Bandwidth	Quasi-Peak (QP) / Average (AV), 9kHz
Input Power	120Vac, 60Hz	Environmental Conditions	25°C, 75%RH
Tested by	Jones Chang	Test Date	2020/2/10

Phase Of Power : Line (L)										
No	Frequency (MHz)	Correction Factor (dB)	Reading Value (dBuV)		Emission Level (dBuV)		Limit (dBuV)		Margin (dB)	
			Q.P.	AV.	Q.P.	AV.	Q.P.	AV.	Q.P.	AV.
1	0.18085	9.66	44.32	30.86	53.98	40.52	64.45	54.45	-10.47	-13.93
2	0.24200	9.67	36.29	20.69	45.96	30.36	62.03	52.03	-16.07	-21.67
3	0.40600	9.69	29.50	17.82	39.19	27.51	57.73	47.73	-18.54	-20.22
4	0.63800	9.71	22.79	11.43	32.50	21.14	56.00	46.00	-23.50	-24.86
5	3.41400	9.82	21.72	8.50	31.54	18.32	56.00	46.00	-24.46	-27.68
6	28.93400	10.01	15.76	10.07	25.77	20.08	60.00	50.00	-34.23	-29.92

Remarks:

1. Q.P. and AV. are abbreviations of quasi-peak and average individually.
2. The emission levels of other frequencies were very low against the limit.
3. Margin value = Emission level – Limit value
4. Correction factor = Insertion loss + Cable loss
5. Emission Level = Correction Factor + Reading Value

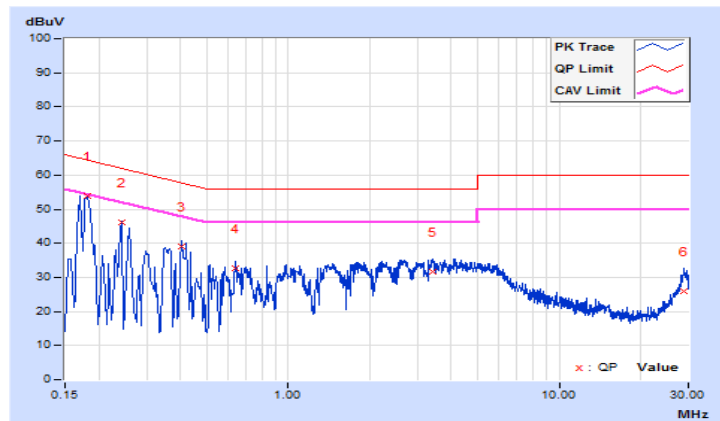

Frequency Range	150kHz ~ 30MHz	Detector Function & Resolution Bandwidth	Quasi-Peak (QP) / Average (AV), 9kHz
Input Power	120Vac, 60Hz	Environmental Conditions	25°C, 75%RH
Tested by	Jones Chang	Test Date	2020/2/10

Phase Of Power : Neutral (N)										
No	Frequency (MHz)	Correction Factor (dB)	Reading Value (dBuV)		Emission Level (dBuV)		Limit (dBuV)		Margin (dB)	
			Q.P.	AV.	Q.P.	AV.	Q.P.	AV.	Q.P.	AV.
1	0.17476	9.64	44.68	33.09	54.32	42.73	64.73	54.73	-10.41	-12.00
2	0.24200	9.64	36.57	21.19	46.21	30.83	62.03	52.03	-15.82	-21.20
3	0.35800	9.66	29.44	19.89	39.10	29.55	58.77	48.77	-19.67	-19.22
4	0.40600	9.66	29.07	17.59	38.73	27.25	57.73	47.73	-19.00	-20.48
5	1.37800	9.72	23.72	10.99	33.44	20.71	56.00	46.00	-22.56	-25.29
6	3.39000	9.79	22.62	8.34	32.41	18.13	56.00	46.00	-23.59	-27.87

Remarks:

1. Q.P. and AV. are abbreviations of quasi-peak and average individually.
2. The emission levels of other frequencies were very low against the limit.
3. Margin value = Emission level – Limit value
4. Correction factor = Insertion loss + Cable loss
5. Emission Level = Correction Factor + Reading Value

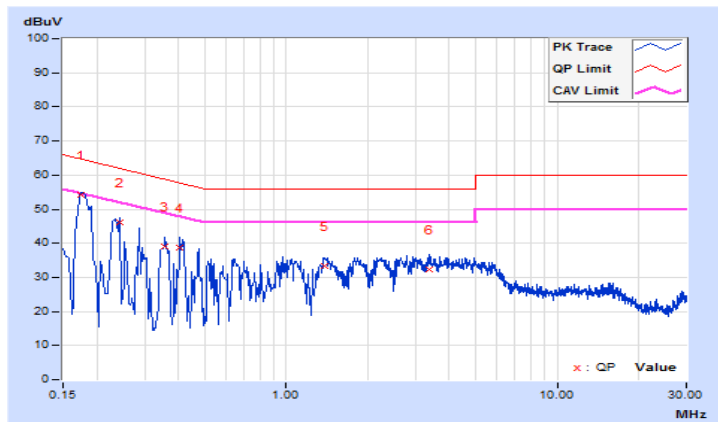

4.3 Transmit Power Measurement

4.3.1 Limits of Transmit Power Measurement

Operation Band	EUT Category		Limit
U-NII-1	√	Outdoor Access Point	1 Watt (30 dBm) (Max. e.i.r.p ≤ 125mW(21 dBm) at any elevation angle above 30 degrees as measured from the horizon)
		Fixed point-to-point Access Point	1 Watt (30 dBm)
	√	Indoor Access Point	1 Watt (30 dBm)
		Mobile and Portable client device	250mW (24 dBm)
U-NII-2A			250mW (24 dBm) or 11 dBm+10 log B*
U-NII-2C			250mW (24 dBm) or 11 dBm+10 log B*
U-NII-3		√	1 Watt (30 dBm)

*B is the 26 dB emission bandwidth in megahertz

Per KDB 662911 Method of conducted output power measurement on IEEE 802.11 devices,

Array Gain = 0 dB (i.e., no array gain) for $N_{ANT} \leq 4$;

Array Gain = 0 dB (i.e., no array gain) for channel widths ≥ 40 MHz for any N_{ANT} ;

Array Gain = $5 \log(N_{ANT}/N_{SS})$ dB or 3 dB, whichever is less for 20-MHz channel widths with $N_{ANT} \geq 5$.

For power measurements on all other devices: Array Gain = $10 \log(N_{ANT}/N_{SS})$ dB.

4.3.2 Test Setup

<Power Output Measurement>

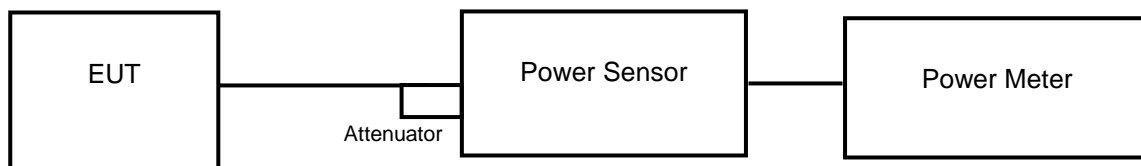

<26 dB Bandwidth>

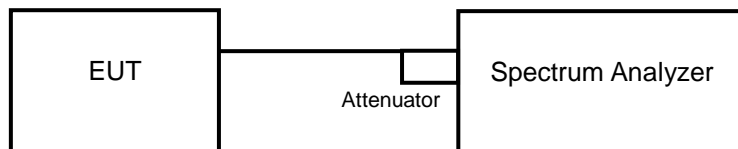

4.3.3 Test Instruments

Refer to section 4.1.2 to get information of above instrument.

4.3.4 Test Procedure

Method PM is used to perform output power measurement, trigger and gating function of wide band power meter is enabled to measure max output power of TX on burst. Duty factor is not added to measured value.

26 dB Bandwidth

- a. Set RBW = approximately 1 % of the emission bandwidth.
- b. Set the VBW > RBW.
- c. Detector = Peak.
- d. Trace mode = max hold.
- e. Measure the maximum width of the emission that is 26 dB down from the peak of the emission. Compare this with the RBW setting of the analyzer. Readjust RBW and repeat measurement as needed until the RBW/EBW ratio is approximately 1 %.

4.3.5 Deviation from Test Standard

No deviation.

4.3.6 EUT Operating Conditions

The software provided by client to enable the EUT under transmission condition continuously at lowest, middle and highest channel frequencies individually.

4.3.7 Test Result

For U-NII-1 band (Outdoor Access Point):

CCD Mode

802.11a

Chan.	Freq. (MHz)	Conducted Power (dBm)		Total Power (mW)	Total Power (dBm)	Power Limit (dBm)	Ant. Gain (dBi)	EIRP (dBm)	EIRP limit (dBm)	Pass / Fail
		Chain 0	Chain 1							
36	5180	11.69	11.89	30.21	14.80	30.00	6	20.80	21.00	Pass
40	5200	11.76	11.94	30.628	14.86	30.00	6	20.86	21.00	Pass
48	5240	11.78	11.96	30.77	14.88	30.00	6	20.88	21.00	Pass

Note:

1. Antenna gain = 6dBi = 6dBi, so the limit no need to be reduced.
2. EIRP = conducted power + (6dBi) + array gain = (0 dB (i.e., no array gain) for $N_{ANT} \leq 4$).

802.11n (HT20)

Chan.	Freq. (MHz)	Conducted Power (dBm)		Total Power (mW)	Total Power (dBm)	Power Limit (dBm)	Ant. Gain (dBi)	EIRP (dBm)	EIRP limit (dBm)	Pass / Fail
		Chain 0	Chain 1							
36	5180	11.74	11.95	30.595	14.86	30.00	6	20.86	21.00	Pass
40	5200	11.83	11.96	30.944	14.91	30.00	6	20.91	21.00	Pass
48	5240	11.77	11.85	30.342	14.82	30.00	6	20.82	21.00	Pass

Note:

1. Antenna gain = 6dBi = 6dBi, so the limit no need to be reduced.
2. EIRP = conducted power + (6dBi) + array gain = (0 dB (i.e., no array gain) for $N_{ANT} \leq 4$).

802.11n (HT40)

Chan.	Freq. (MHz)	Conducted Power (dBm)		Total Power (mW)	Total Power (dBm)	Power Limit (dBm)	Ant. Gain (dBi)	EIRP (dBm)	EIRP limit (dBm)	Pass / Fail
		Chain 0	Chain 1							
38	5190	11.46	11.54	28.252	14.51	30.00	6	20.51	21.00	Pass
46	5230	11.45	11.57	28.319	14.52	30.00	6	20.52	21.00	Pass

Note:

1. Antenna gain = 6dBi = 6dBi, so the limit no need to be reduced.
2. EIRP = conducted power + (6dBi) + array gain = (0 dB (i.e., no array gain) for $N_{ANT} \leq 4$).

802.11ac (VHT80)

Chan.	Freq. (MHz)	Conducted Power (dBm)		Total Power (mW)	Total Power (dBm)	Power Limit (dBm)	Ant. Gain (dBi)	EIRP (dBm)	EIRP limit (dBm)	Pass / Fail
		Chain 0	Chain 1							
42	5210	11.53	11.64	28.811	14.60	30.00	6	20.60	21.00	Pass

Note:

1. Antenna gain = 6dBi = 6dBi, so the limit no need to be reduced.
2. EIRP = conducted power + (6dBi) + array gain = (0dB (i.e., no array gain) for $N_{ANT} \leq 4$).

Beamforming Mode

802.11n (HT20)

Chan.	Freq. (MHz)	Conducted Power (dBm)		Total Power (mW)	Total Power (dBm)	Power Limit (dBm)	Ant. Gain (dBi)	EIRP (dBm)	EIRP limit (dBm)	Pass / Fail
		Chain 0	Chain 1							
36	5180	8.73	8.94	16.775	11.85	26.99	9.01	20.86	21.00	Pass
40	5200	8.82	8.95	16.966	11.90	26.99	9.01	20.91	21.00	Pass
48	5240	8.76	8.84	16.636	11.81	26.99	9.01	20.82	21.00	Pass

Note:

1. Antenna gain = 9.01dBi > 6dBi, so the power limit shall be reduced to $30 - (9.01 - 6) = 26.99$ dBm.
2. EIRP = conducted power + (6dBi) + array gain = (3.01 dB (i.e., no array gain) for $N_{ANT} \leq 4$).

802.11n (HT40)

Chan.	Freq. (MHz)	Conducted Power (dBm)		Total Power (mW)	Total Power (dBm)	Power Limit (dBm)	Ant. Gain (dBi)	EIRP (dBm)	EIRP limit (dBm)	Pass / Fail
		Chain 0	Chain 1							
38	5190	8.45	8.53	15.49	11.50	26.99	9.01	20.51	21.00	Pass
46	5230	8.44	8.56	15.526	11.51	26.99	9.01	20.52	21.00	Pass

Note:

1. Antenna gain = 9.01dBi > 6dBi, so the power limit shall be reduced to $30 - (9.01 - 6) = 26.99$ dBm.
2. EIRP = conducted power + (6dBi) + array gain = (3.01 dB (i.e., no array gain) for $N_{ANT} \leq 4$).

802.11ac (VHT80)

Chan.	Freq. (MHz)	Conducted Power (dBm)		Total Power (mW)	Total Power (dBm)	Power Limit (dBm)	Ant. Gain (dBi)	EIRP (dBm)	EIRP limit (dBm)	Pass / Fail
		Chain 0	Chain 1							
42	5210	8.52	8.63	15.797	11.59	26.99	9.01	20.60	21.00	Pass

Note:

1. Antenna gain = 9.01dBi > 6dBi, so the power limit shall be reduced to $30 - (9.01 - 6) = 26.99$ dBm.
2. EIRP = conducted power + (6dBi) + array gain = (3.01 dB (i.e., no array gain) for $N_{ANT} \leq 4$).

For U-NII-1 band (Indoor Access Point):

CCD Mode

802.11a

Chan.	Freq. (MHz)	Maximum Conducted Power (dBm)		Total Power (mW)	Total Power (dBm)	Power Limit (dBm)	Pass / Fail
		Chain 0	Chain 1				
36	5180	20.34	20.44	218.806	23.40	30.00	Pass
40	5200	23.69	23.78	472.665	26.75	30.00	Pass
48	5240	23.66	23.85	474.935	26.77	30.00	Pass

Note: Antenna gain = 6dBi = 6dBi, so the limit no need to be reduced.

802.11n (HT20)

Chan.	Freq. (MHz)	Maximum Conducted Power (dBm)		Total Power (mW)	Total Power (dBm)	Power Limit (dBm)	Pass / Fail
		Chain 0	Chain 1				
36	5180	20.39	20.46	220.569	23.44	30.00	Pass
40	5200	23.72	23.86	478.725	26.80	30.00	Pass
48	5240	23.72	23.88	479.848	26.81	30.00	Pass

Note: Antenna gain = 6dBi = 6dBi, so the limit no need to be reduced.

802.11n (HT40)

Chan.	Freq. (MHz)	Maximum Conducted Power (dBm)		Total Power (mW)	Total Power (dBm)	Power Limit (dBm)	Pass / Fail
		Chain 0	Chain 1				
38	5190	18.66	18.43	143.114	21.56	30.00	Pass
46	5230	22.65	22.48	361.088	25.58	30.00	Pass

Note: Antenna gain = 6dBi = 6dBi, so the limit no need to be reduced.

802.11ac (VHT80)

Chan.	Freq. (MHz)	Maximum Conducted Power (dBm)		Total Power (mW)	Total Power (dBm)	Power Limit (dBm)	Pass / Fail
		Chain 0	Chain 1				
42	5210	16.58	16.41	89.251	19.51	30.00	Pass

Note: Antenna gain = 6dBi = 6dBi, so the limit no need to be reduced.

Beamforming Mode

802.11n (HT20)

Chan.	Freq. (MHz)	Maximum Conducted Power (dBm)		Total Power (mW)	Total Power (dBm)	Power Limit (dBm)	Pass / Fail
		Chain 0	Chain 1				
36	5180	17.38	17.45	110.292	20.43	26.99	Pass
40	5200	20.71	20.85	239.379	23.79	26.99	Pass
48	5240	20.71	20.87	239.941	23.80	26.99	Pass

Note: Beamforming gain = 9.01dBi > 6dBi , so the power limit shall be reduced to $30-(9.01-6) = 26.99$ dBm.

802.11n (HT40)

Chan.	Freq. (MHz)	Maximum Conducted Power (dBm)		Total Power (mW)	Total Power (dBm)	Power Limit (dBm)	Pass / Fail
		Chain 0	Chain 1				
38	5190	15.65	15.42	71.562	18.55	26.99	Pass
46	5230	19.64	19.47	180.557	22.57	26.99	Pass

Note: Beamforming gain = 9.01dBi > 6dBi , so the power limit shall be reduced to $30-(9.01-6) = 26.99$ dBm.

802.11ac (VHT80)

Chan.	Freq. (MHz)	Maximum Conducted Power (dBm)		Total Power (mW)	Total Power (dBm)	Power Limit (dBm)	Pass / Fail
		Chain 0	Chain 1				
42	5210	13.57	13.40	44.629	16.50	26.99	Pass

Note: Beamforming gain = 9.01dBi > 6dBi , so the power limit shall be reduced to $30-(9.01-6) = 26.99$ dBm.

For U-NII-3 band:

CCD Mode

802.11a

Chan.	Freq. (MHz)	Maximum Conducted Power (dBm)		Total Power (mW)	Total Power (dBm)	Power Limit (dBm)	Pass / Fail
		Chain 0	Chain 1				
149	5745	22.73	23.27	399.824	26.02	30.00	Pass
157	5785	22.70	23.21	395.62	25.97	30.00	Pass
165	5825	22.69	23.18	393.75	25.95	30.00	Pass

Note: Antenna gain = 6dBi = 6dBi, so the limit no need to be reduced.

802.11n (HT20)

Chan.	Freq. (MHz)	Maximum Conducted Power (dBm)		Total Power (mW)	Total Power (dBm)	Power Limit (dBm)	Pass / Fail
		Chain 0	Chain 1				
149	5745	22.94	23.43	417.081	26.20	30.00	Pass
157	5785	22.84	23.47	414.64	26.18	30.00	Pass
165	5825	22.85	23.44	413.553	26.17	30.00	Pass

Note: Antenna gain = 6dBi = 6dBi, so the limit no need to be reduced.

802.11n (HT40)

Chan.	Freq. (MHz)	Maximum Conducted Power (dBm)		Total Power (mW)	Total Power (dBm)	Power Limit (dBm)	Pass / Fail
		Chain 0	Chain 1				
151	5755	22.37	23.00	372.11	25.71	30.00	Pass
159	5795	22.86	23.48	416.04	26.19	30.00	Pass

Note: Antenna gain = 6dBi = 6dBi, so the limit no need to be reduced.

802.11ac (VHT80)

Chan.	Freq. (MHz)	Maximum Conducted Power (dBm)		Total Power (mW)	Total Power (dBm)	Power Limit (dBm)	Pass / Fail
		Chain 0	Chain 1				
155	5775	18.41	18.97	148.229	21.71	30.00	Pass

Note: Antenna gain = 6dBi = 6dBi, so the limit no need to be reduced.

Beamforming Mode

802.11n (HT20)

Chan.	Freq. (MHz)	Maximum Conducted Power (dBm)		Total Power (mW)	Total Power (dBm)	Power Limit (dBm)	Pass / Fail
		Chain 0	Chain 1				
149	5745	19.93	20.42	208.555	23.19	26.99	Pass
157	5785	19.83	20.46	207.334	23.17	26.99	Pass
165	5825	19.84	20.43	206.791	23.16	26.99	Pass

Note: Beamforming gain = 9.01 dBi > 6dBi , so the power limit shall be reduced to $30-(9.01-6) = 26.99$ dBm.

802.11n (HT40)

Chan.	Freq. (MHz)	Maximum Conducted Power (dBm)		Total Power (mW)	Total Power (dBm)	Power Limit (dBm)	Pass / Fail
		Chain 0	Chain 1				
151	5755	19.36	19.99	186.068	22.70	26.99	Pass
159	5795	19.85	20.47	208.035	23.18	26.99	Pass

Note: Beamforming gain = 9.01 dBi > 6dBi , so the power limit shall be reduced to $30-(9.01-6) = 26.99$ dBm.

802.11ac (VHT80)

Chan.	Freq. (MHz)	Maximum Conducted Power (dBm)		Total Power (mW)	Total Power (dBm)	Power Limit (dBm)	Pass / Fail
		Chain 0	Chain 1				
155	5775	15.40	15.96	74.119	18.70	26.99	Pass

Note: Beamforming gain = 9.01 dBi > 6dBi , so the power limit shall be reduced to $30-(9.01-6) = 26.99$ dBm.

26 dB Bandwidth:
802.11a

Channel	Frequency (MHz)	26 dBc Bandwidth (MHz)	
		Chain 0	Chain 1
36	5180	19.29	19.79
40	5200	34.09	39.89
48	5240	34.35	33.65

802.11n (HT20)

Channel	Frequency (MHz)	26 dBc Bandwidth (MHz)	
		Chain 0	Chain 1
36	5180	20.81	20.44
40	5200	40.65	40.49
48	5240	34.13	34.29

802.11n (HT40)

Channel	Frequency (MHz)	26 dBc Bandwidth (MHz)	
		Chain 0	Chain 1
38	5190	40.58	40.46
46	5230	81.46	79.19

802.11ac (VHT80)

Channel	Frequency (MHz)	26 dBc Bandwidth (MHz)	
		Chain 0	Chain 1
42	5210	84.15	82.93

Spectrum Plot of Worst Value

802.11a

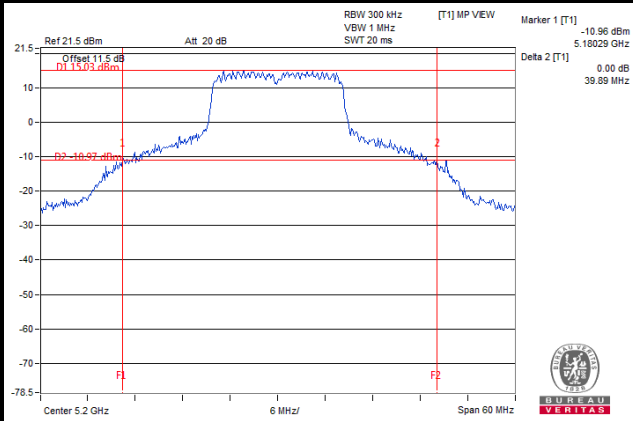

802.11n (HT20)

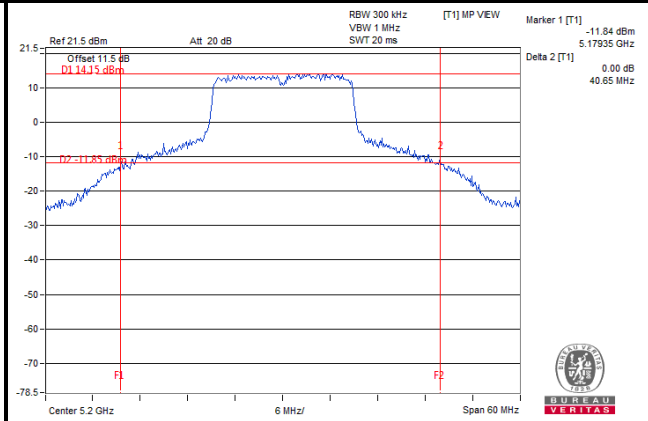

802.11n (HT40)

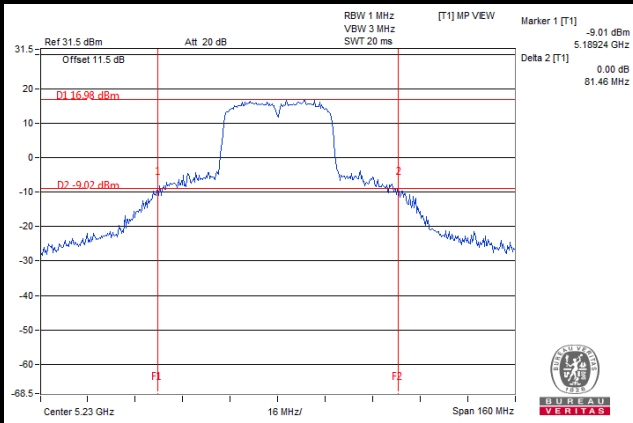

802.11ac (VHT80)

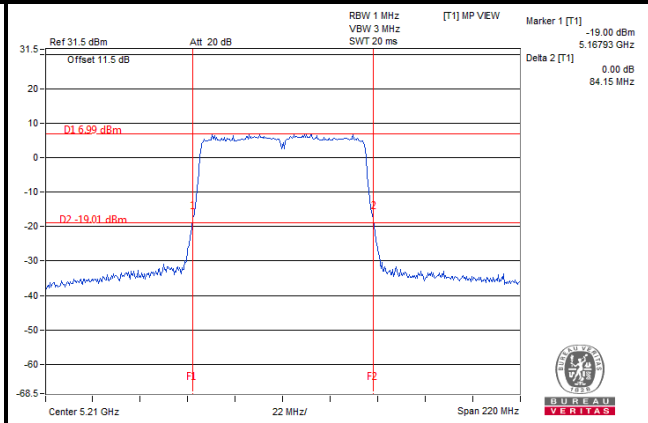

4.4 Occupied Bandwidth Measurement

4.4.1 Test Setup

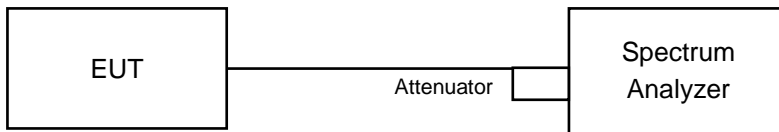

4.4.2 Test Instruments

Refer to section 4.1.2 to get information of above instrument.

4.4.3 Test Procedure

The transmitter output was connected to the spectrum analyzer through an attenuator. The bandwidth of the fundamental frequency was measured by spectrum analyzer with resolution bandwidth in the range of 1% to 5% of the anticipated emission bandwidth, and a video bandwidth at least 3x the resolution bandwidth and set the detector to sampling. The width of a frequency band such that, below the lower and above the upper frequency limits, the mean powers emitted are each equal to a specified percentage 0.5 %of the total mean power of a given emission.

4.4.4 Test Result

802.11a

Chan.	Freq. (MHz)	Occupied Bandwidth (MHz)	
		Chain 0	Chain 1
36	5180	16.44	16.44
40	5200	17.04	20.28
48	5240	17.40	17.04
149	5745	28.68	33.24
157	5785	29.28	32.52
165	5825	30.96	33.12

802.11n (HT20)

Chan.	Freq. (MHz)	Occupied Bandwidth (MHz)	
		Chain 0	Chain 1
36	5180	17.64	17.64
40	5200	19.68	20.40
48	5240	18.00	18.08
149	5745	31.92	35.16
157	5785	33.96	34.08
165	5825	33.60	35.04

802.11n (HT40)

Chan.	Freq. (MHz)	Occupied Bandwidth (MHz)	
		Chain 0	Chain 1
38	5190	36.12	36.12
46	5230	36.72	36.72
151	5755	49.92	46.20
159	5795	42.96	46.44

802.11ac (VHT80)

Chan.	Freq. (MHz)	Occupied Bandwidth (MHz)	
		Chain 0	Chain 1
42	5210	75.84	75.84
155	5775	75.84	76.08

Spectrum Plot of Worst Value

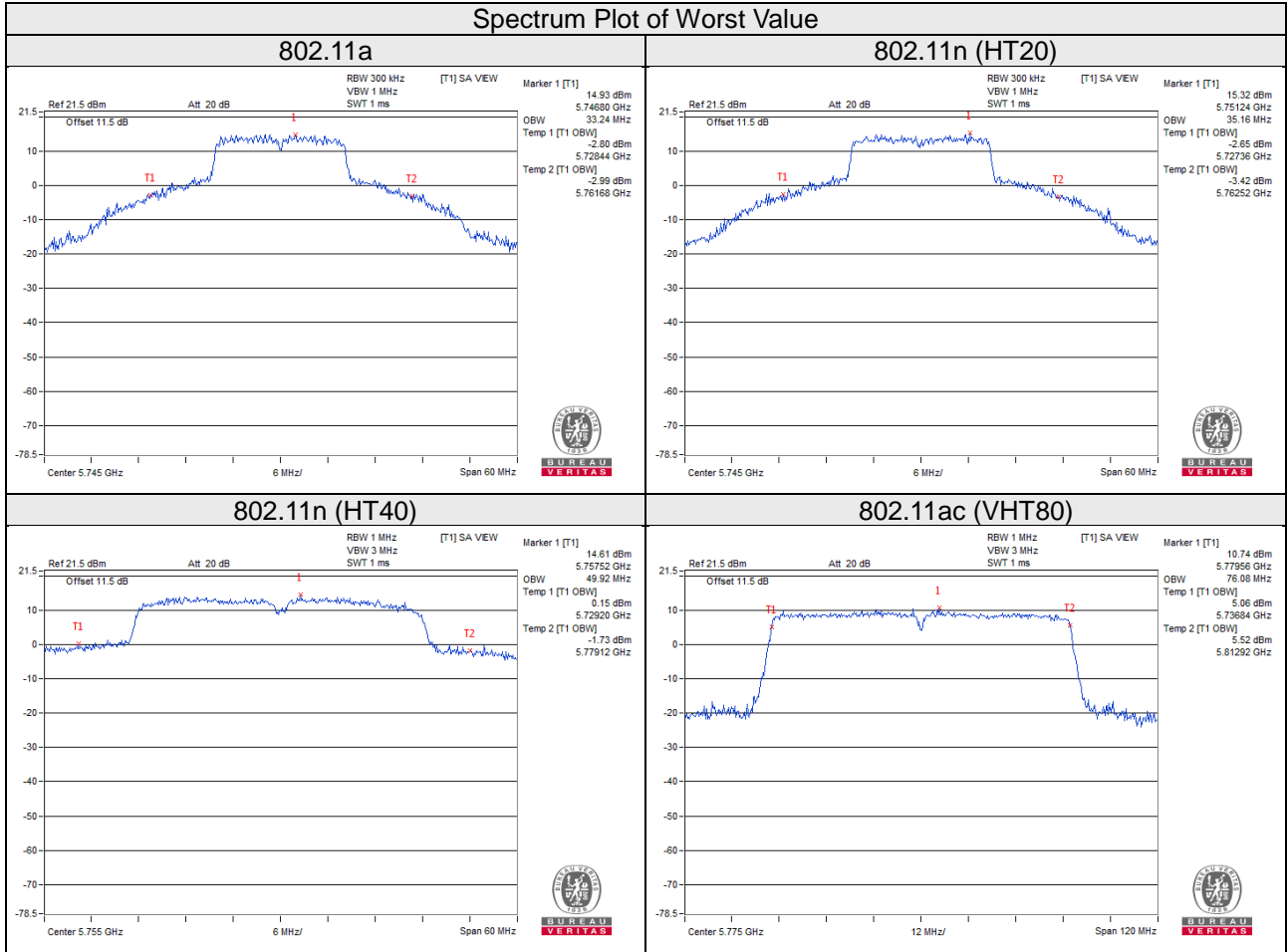

Chain 0

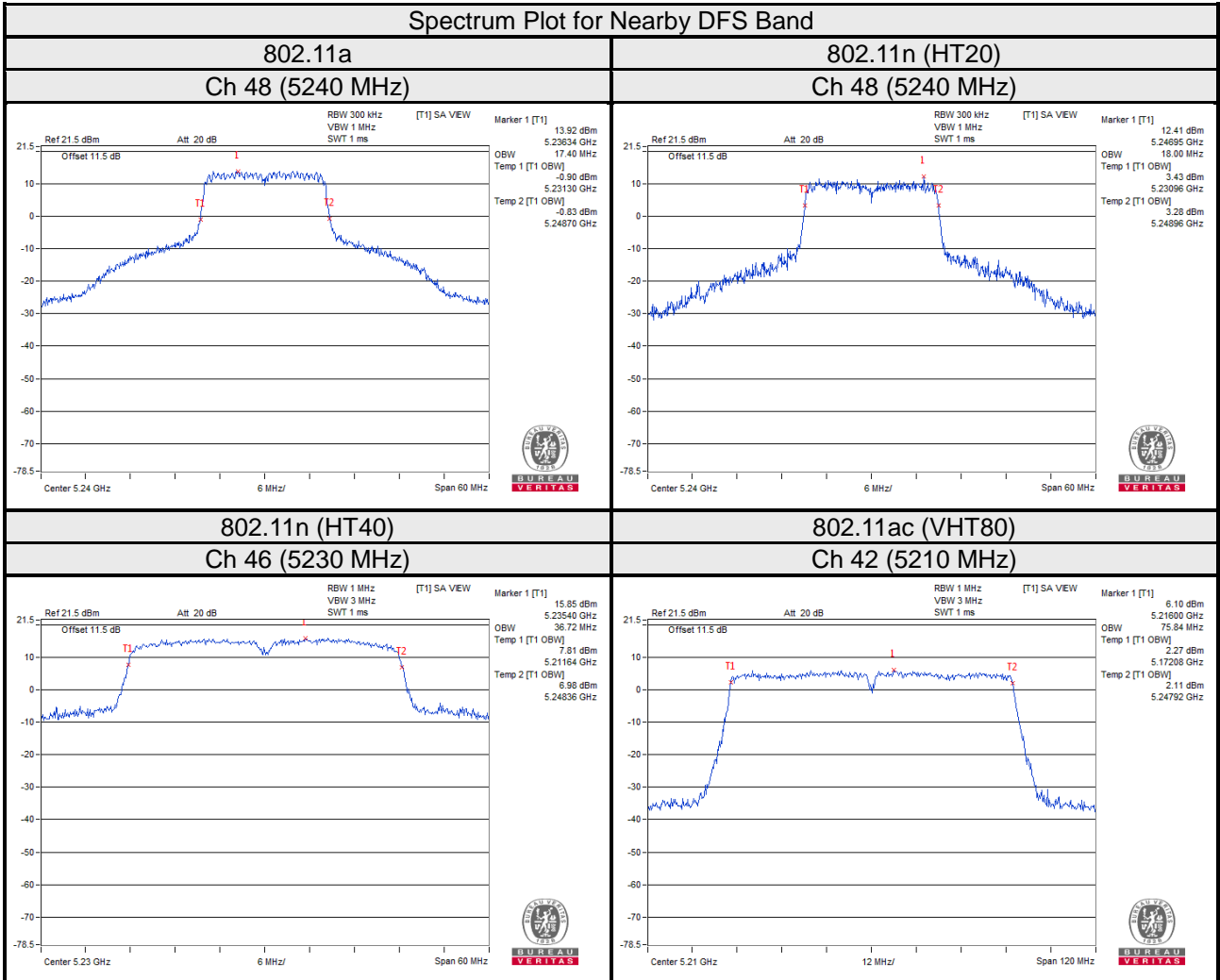

Chain 1

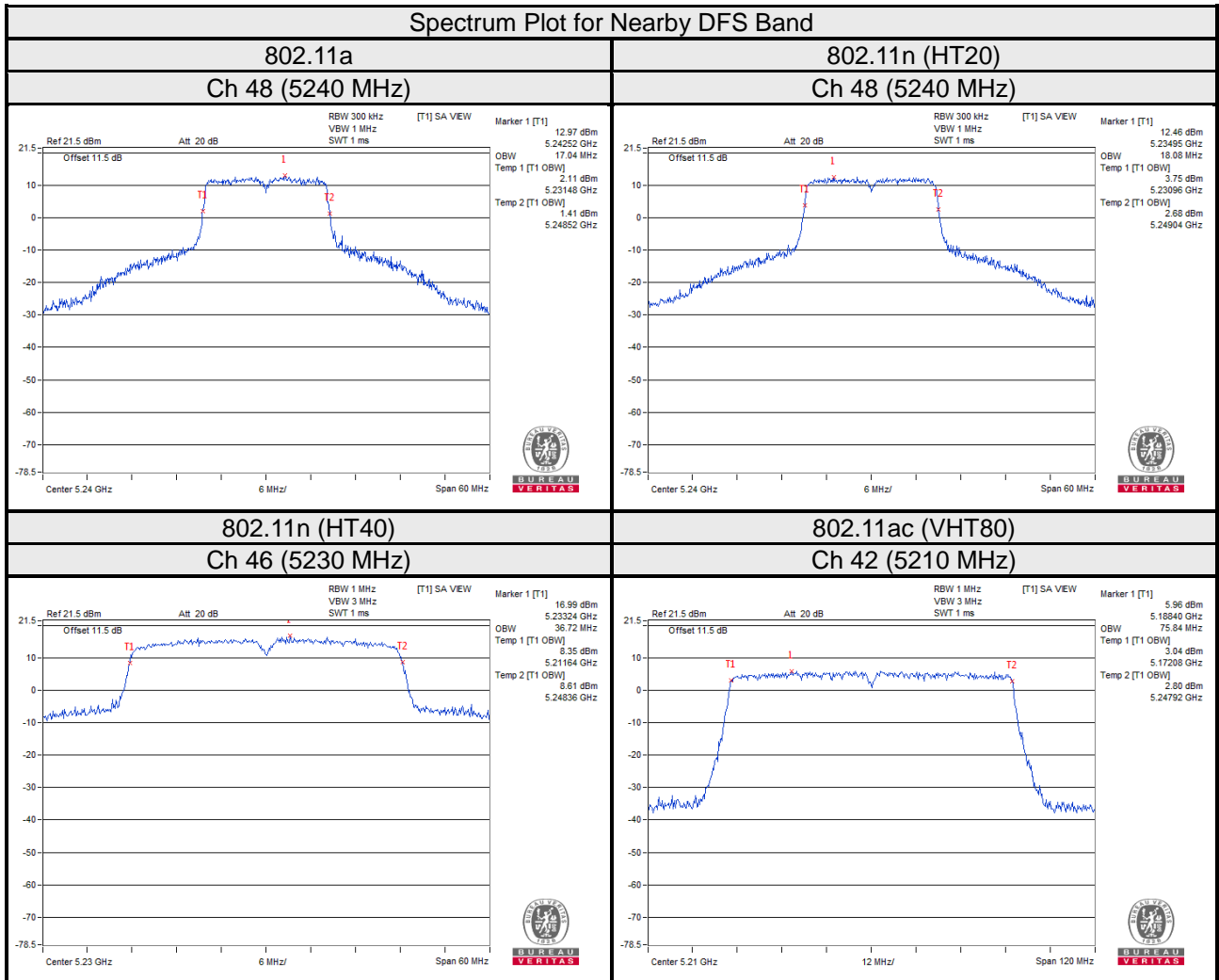

4.5 Peak Power Spectral Density Measurement

4.5.1 Limits of Peak Power Spectral Density Measurement

Operation Band	EUT Category		Limit
U-NII-1	√	Outdoor Access Point	17dBm/ MHz
		Fixed point-to-point Access Point	
	√	Indoor Access Point	
		Mobile and Portable client device	11dBm/ MHz
U-NII-2A			11dBm/ MHz
U-NII-2C			11dBm/ MHz
U-NII-3		√	30dBm/ 500kHz

4.5.2 Test Setup

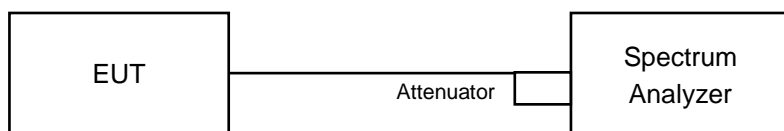

4.5.3 Test Instruments

Refer to section 4.1.2 to get information of above instrument.

4.5.4 Test Procedures

For U-NII-1 band:

Duty cycle of test signal is > 98%

Using method SA-1

- Set span to encompass the entire emission bandwidth (EBW) of the signal.
- Set RBW = 1 MHz, Set VBW ≥ 3 MHz, Detector = RMS
- Sweep time = auto, trigger set to “free run”.
- Trace average at least 100 traces in power averaging mode.
- Record the max value

Duty cycle of test signal is < 98%

Using method SA-2

- Set span to encompass the entire emission bandwidth (EBW) of the signal.
- Set RBW = 1MHz, Set VBW ≥ 3 MHz, Detector = RMS
- Set Channel power measure = 1MHz
- Sweep time = auto, trigger set to “free run”.
- Trace average at least 100 traces in power averaging mode.
- Record the max value and add 10 log (1/duty cycle)

For U-NII-3 band:

Duty cycle of test signal is > 98%

- a. Set span to encompass the entire emission bandwidth (EBW) of the signal.
- b. Set RBW = 300 kHz, Set VBW \geq 1 MHz, Detector = RMS
- c. Use the peak marker function to determine the maximum power level in any 300 kHz band segment within the fundamental EBW.
- d. Scale the observed power level to an equivalent value in 500 kHz by adjusting (reducing) the measured power by a bandwidth correction factor (BWCF) where $BWCF = 10\log(500 \text{ kHz}/300\text{kHz})$
- e. Sweep time = auto, trigger set to "free run".
- f. Trace average at least 100 traces in power averaging mode.
- g. Record the max value

Duty cycle of test signal is < 98%

- a. Set span to encompass the entire emission bandwidth (EBW) of the signal.
- b. Set RBW = 300 kHz, Set VBW \geq 1 MHz, Detector = RMS
- c. Use the peak marker function to determine the maximum power level in any 300 kHz band segment within the fundamental EBW.
- d. Scale the observed power level to an equivalent value in 500 kHz by adjusting (reducing) the measured power by a bandwidth correction factor (BWCF) where $BWCF = 10\log(500 \text{ kHz} / 300 \text{ kHz})$
- e. Sweep time = auto, trigger set to "free run".
- f. Trace average at least 100 traces in power averaging mode.
- g. Record the max value and add $10 \log (1/\text{duty cycle})$

4.5.5 Deviation from Test Standard

No deviation.

4.5.6 EUT Operating Conditions

Same as 4.3.6.

4.5.7 Test Results

For U-NII-1 band:

802.11a

Chan.	Freq. (MHz)	PSD w/o Duty Factor (dBm/MHz)		Duty Factor (dB)	Total PSD with Duty Factor (dBm/MHz)	Max. Limit (dBm/MHz)	Pass / Fail
		Chain 0	Chain 1				
36	5180	6.88	6.40	0.22	9.66	13.99	Pass
40	5200	10.41	9.63	0.22	13.05	13.99	Pass
48	5240	8.46	8.57	0.22	11.53	13.99	Pass

Note:

- Method E) 2) a) of power density measurement of KDB 662911 is using for calculating total power density. Total power density is summing entire spectra across corresponding frequency bins on the various outputs by computer.
- Directional gain = $6\text{dBi} + 10\log(2) = 9.01\text{ dBi} > 6\text{ dBi}$, so the power density limit shall be reduced to $17 - (9.01-6) = 13.99\text{ dBm}$.
- Refer to section 3.3 for duty cycle spectrum plot.

802.11n (HT20)

Chan.	Freq. (MHz)	PSD (dBm/MHz)		Total PSD (dBm/MHz)	Max. Limit (dBm/MHz)	Pass / Fail
		Chain 0	Chain 1			
36	5180	5.70	6.22	8.98	13.99	Pass
40	5200	9.38	9.55	12.48	13.99	Pass
48	5240	8.68	8.85	11.78	13.99	Pass

Note:

- Method E) 2) a) of power density measurement of KDB 662911 is using for calculating total power density. Total power density is summing entire spectra across corresponding frequency bins on the various outputs by computer.
- Directional gain = $6\text{dBi} + 10\log(2) = 9.01\text{ dBi} > 6\text{ dBi}$, so the power density limit shall be reduced to $17 - (9.01-6) = 13.99\text{ dBm}$.
- Refer to section 3.3 for duty cycle spectrum plot.

802.11n (HT40)

Chan.	Freq. (MHz)	PSD w/o Duty Factor (dBm/MHz)		Duty Factor (dB)	Total PSD with Duty Factor (dBm/MHz)	Max. Limit (dBm/MHz)	Pass / Fail
		Chain 0	Chain 1				
38	5190	1.60	1.40	0.25	4.51	13.99	Pass
46	5230	5.69	5.74	0.25	8.73	13.99	Pass

Note:

- Method E) 2) a) of power density measurement of KDB 662911 is using for calculating total power density. Total power density is summing entire spectra across corresponding frequency bins on the various outputs by computer.
- Directional gain = $6\text{dBi} + 10\log(2) = 9.01\text{ dBi} > 6\text{ dBi}$, so the power density limit shall be reduced to $17 - (9.01-6) = 13.99\text{ dBm}$.
- Refer to section 3.3 for duty cycle spectrum plot.

802.11ac (VHT80)

Chan.	Freq. (MHz)	PSD w/o Duty Factor (dBm/MHz)		Duty Factor (dB)	Total PSD with Duty Factor (dBm/MHz)	Max. Limit (dBm/MHz)	Pass / Fail
		Chain 0	Chain 1				
42	5210	-3.80	-4.02	0.43	-0.90	13.99	Pass

Note:

- Method E) 2) a) of power density measurement of KDB 662911 is using for calculating total power density. Total power density is summing entire spectra across corresponding frequency bins on the various outputs by computer.
- Directional gain = $6\text{dBi} + 10\log(2) = 9.01\text{ dBi} > 6\text{ dBi}$, so the power density limit shall be reduced to $17 - (9.01 - 6) = 13.99\text{ dBm}$.
- Refer to section 3.3 for duty cycle spectrum plot.

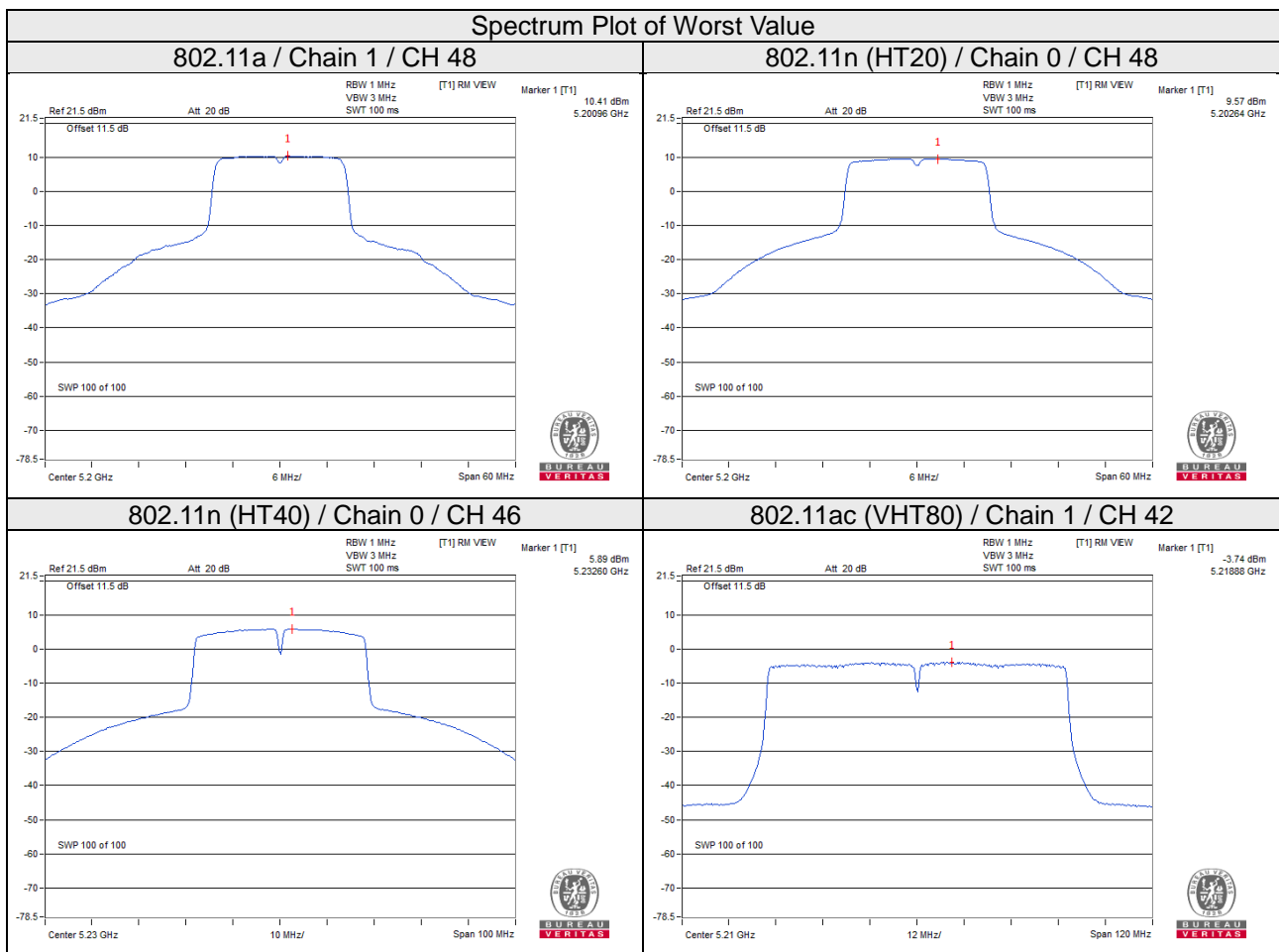

For U-NII-3 band:

802.11a

TX chain	Chan.	Freq. (MHz)	PSD w/o Duty Factor		10 log (N=2) dB	Duty Factor (dB)	Total PSD with Duty Factor (dBm/500kHz)	Limit (dBm/500 kHz)	Pass / Fail
			(dBm/300kHz)	(dBm/500kHz)					
0	149	5745	2.7	4.92	3.01	0.22	8.15	26.99	Pass
	157	5785	2.63	4.85	3.01	0.22	8.08	26.99	Pass
	165	5825	2.58	4.8	3.01	0.22	8.03	26.99	Pass
1	149	5745	1.92	4.14	3.01	0.22	7.37	26.99	Pass
	157	5785	1.3	3.52	3.01	0.22	6.75	26.99	Pass
	165	5825	0.99	3.21	3.01	0.22	6.44	26.99	Pass

Note:

- Method E) 2) c) of power density measurement of KDB 662911 is using for calculating total power density, Measure and add $10 \log(N_{ANT})$ dB.
- Directional gain = $6\text{dBi} + 10\log(2) = 9.01 \text{ dBi} > 6 \text{ dBi}$ so the power density limit shall be reduced to $30 - (9.01 - 6) = 26.99\text{dBi}$.
- Refer to section 3.3 for duty cycle spectrum plot.

802.11n (HT20)

TX chain	Chan.	Freq. (MHz)	PSD (dBm/300 kHz)	PSD (dBm/500 kHz)	10 log (N=2) dB	Total PSD (dBm/500 kHz)	Limit (dBm/500 kHz)	Pass / Fail
0	149	5745	1.31	3.53	3.01	6.54	26.99	Pass
	157	5785	1.08	3.3	3.01	6.31	26.99	Pass
	165	5825	0.59	2.81	3.01	5.82	26.99	Pass
1	149	5745	1.47	3.69	3.01	6.7	26.99	Pass
	157	5785	1.25	3.47	3.01	6.48	26.99	Pass
	165	5825	0.72	2.94	3.01	5.95	26.99	Pass

Note:

- Method E) 2) c) of power density measurement of KDB 662911 is using for calculating total power density, Measure and add $10 \log(N_{ANT})$ dB.
- Directional gain = $6\text{dBi} + 10\log(2) = 9.01 \text{ dBi} > 6 \text{ dBi}$ so the power density limit shall be reduced to $30 - (9.01 - 6) = 26.99\text{dBi}$.

802.11n (HT40)

TX chain	Chan.	Freq. (MHz)	PSD W/O Duty Factor		10 log (N=2) dB	Duty Factor (dB)	Total PSD With Duty Factor (dBm/500kHz)	Limit (dBm/500kHz)	Pass / Fail
			(dBm/300kHz)	(dBm/500kHz)					
0	151	5755	-5.38	-3.16	3.01	0.25	0.1	26.99	Pass
	159	5795	-7.57	-5.35	3.01	0.25	-2.09	26.99	Pass
1	151	5755	-1.77	0.45	3.01	0.25	3.71	26.99	Pass
	159	5795	-2.21	0.01	3.01	0.25	3.27	26.99	Pass

Note:

1. Method E) 2) c) of power density measurement of KDB 662911 is using for calculating total power density, Measure and add $10 \log(N_{ANT})$ dB.
2. Directional gain = $6\text{dBi} + 10\log(2) = 9.01 \text{ dBi} > 6 \text{ dBi}$ so the power density limit shall be reduced to $30 - (9.01 - 6) = 26.99\text{dBi}$.
3. Refer to section 3.3 for duty cycle spectrum plot.

802.11ac (VHT80)

TX chain	Chan.	Freq. (MHz)	PSD W/O Duty Factor		10 log (N=2) dB	Duty Factor (dB)	Total PSD With Duty Factor (dBm/500kHz)	Limit (dBm/500kHz)	Pass / Fail
			(dBm/300kHz)	(dBm/500kHz)					
0	155	5775	-8.99	-6.77	3.01	0.43	-3.33	26.99	Pass
1	155	5775	-9.18	-6.96	3.01	0.43	-3.52	26.99	Pass

Note:

1. Method E) 2) c) of power density measurement of KDB 662911 is using for calculating total power density, Measure and add $10 \log(N_{ANT})$ dB.
2. Directional gain = $6\text{dBi} + 10\log(2) = 9.01 \text{ dBi} > 6 \text{ dBi}$ so the power density limit shall be reduced to $30 - (9.01 - 6) = 26.99\text{dBi}$.
3. Refer to section 3.3 for duty cycle spectrum plot.

Spectrum Plot of Worst Value

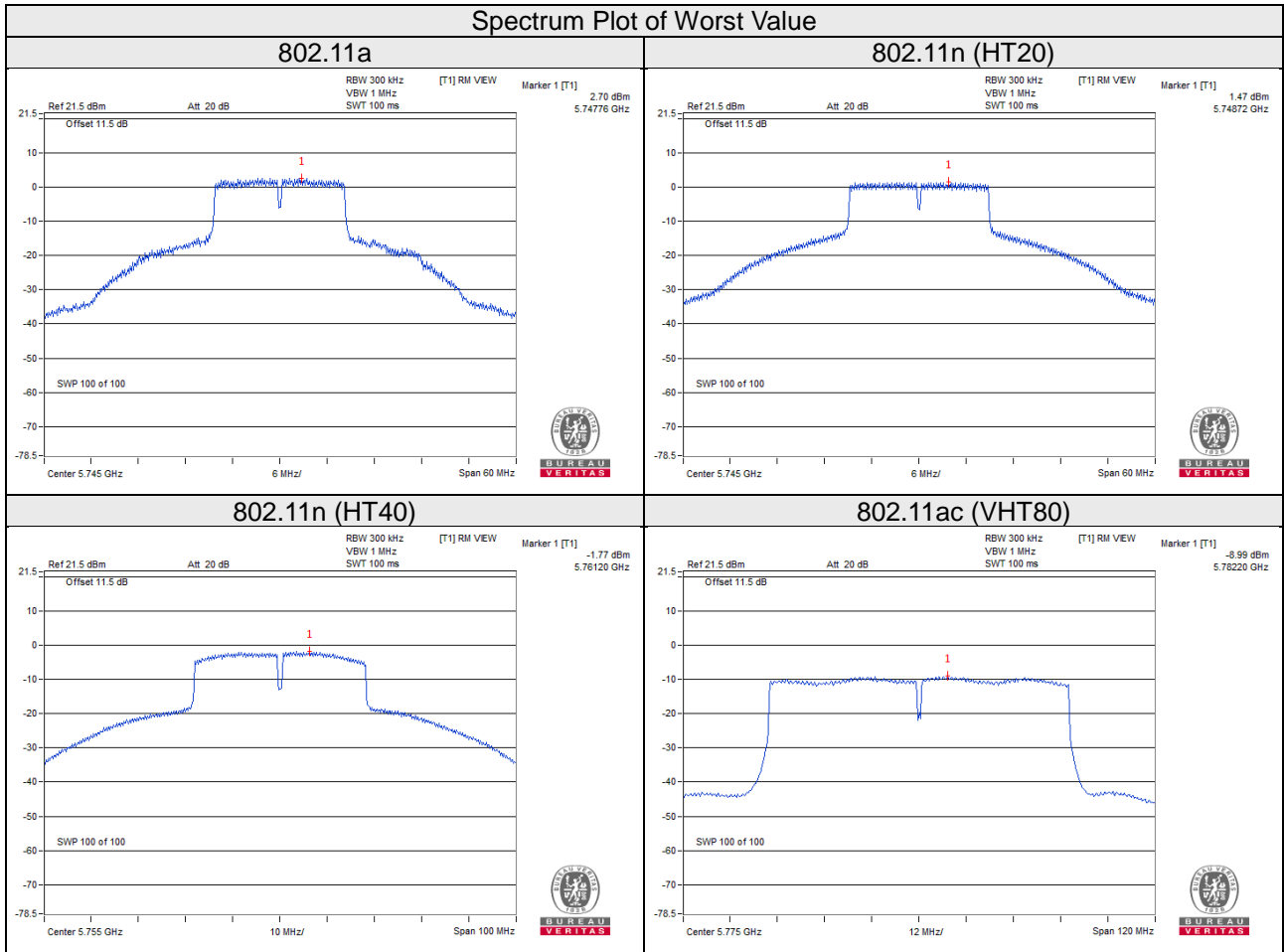

4.6 Frequency Stability

4.6.1 Limits of Frequency Stability Measurement

The frequency of the carrier signal shall be maintained within band of operation

4.6.2 Test Setup

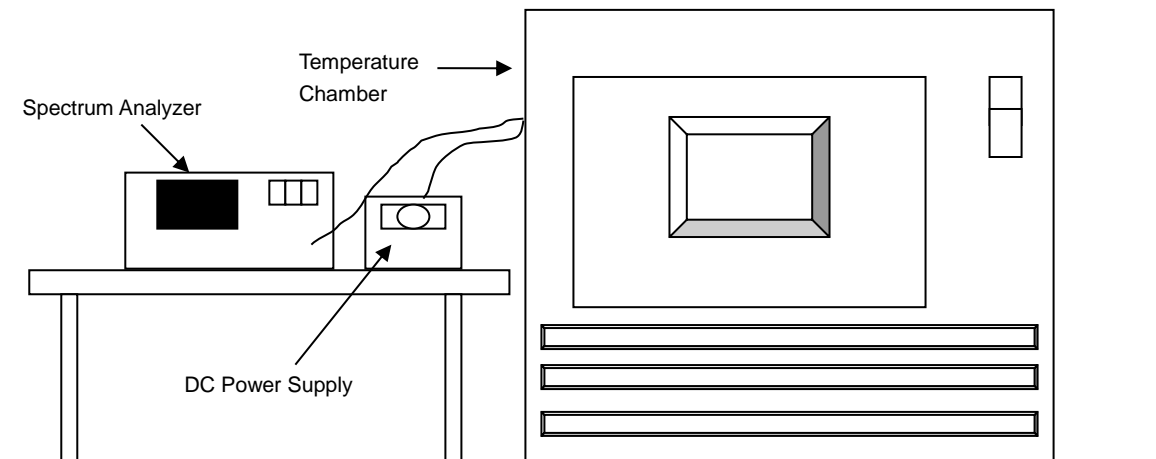

4.6.3 Test Instruments

Description & Manufacturer	Model No.	Serial No.	Cal. Date	Cal. Due
Spectrum Analyzer ROHDE & SCHWARZ	FSP40	100040	Sep. 23, 2019	Sep. 22, 2020
WIT Standard Temperature And Humidity Chamber	TH-4S-C	W981030	Jun. 03, 2019	Jun. 02, 2020
Digital Multimeter Fluke	87-III	70360742	Jun. 28, 2019	Jun. 27, 2020
AC Power Supply Exttech	CFW-105	E000603	NA	NA

Note: 1. The calibration interval of the above test instruments is 12 months and the calibrations are traceable to NML/ROC and NIST/USA.

4.6.4 Test Procedure

- The EUT was placed inside the environmental test chamber and powered by nominal DC voltage.
- Turn the EUT on and couple its output to a spectrum analyzer.
- Turn the EUT off and set the chamber to the highest temperature specified.
- Allow sufficient time (approximately 30 min) for the temperature of the chamber to stabilize, turn the EUT on and measure the operating frequency after 2, 5, and 10 minutes.
- Repeat step (d) with the temperature chamber set to the next desired temperature until measurements down to the lowest specified temperature have been completed.
- The test chamber was allowed to stabilize at +20 degree C for a minimum of 30 minutes. The supply voltage was then adjusted on the EUT from 85% to 115% and the frequency record.

4.6.5 Deviation from Test Standard

No deviation.

4.6.6 EUT Operating Condition

Set the EUT transmit at un-modulation mode to test frequency stability.

4.6.7 Test Results

Frequency Stability Versus Temp.									
Operating Frequency: 5180MHz									
Temp. (°C)	Power Supply (Vdc)	0 Minute		2 Minute		5 Minute		10 Minute	
		Measured Frequency (MHz)	Result	Measured Frequency (MHz)	Result	Measured Frequency (MHz)	Result	Measured Frequency (MHz)	Result
40	48	5179.9876	PASS	5179.9881	PASS	5179.9911	PASS	5179.987	PASS
30	48	5180.0014	PASS	5180.0059	PASS	5180.0035	PASS	5180.0035	PASS
20	48	5180.0162	PASS	5180.0149	PASS	5180.0181	PASS	5180.0172	PASS
10	48	5179.9965	PASS	5179.9973	PASS	5179.9989	PASS	5180	PASS
0	48	5180.0034	PASS	5180.0036	PASS	5180.0003	PASS	5180.0013	PASS
40	48	5179.9876	PASS	5179.9881	PASS	5179.9911	PASS	5179.987	PASS

Frequency Stability Versus Voltage									
Operating Frequency: 5180MHz									
Temp. (°C)	Power Supply (Vdc)	0 Minute		2 Minute		5 Minute		10 Minute	
		Measured Frequency (MHz)	Result	Measured Frequency (MHz)	Result	Measured Frequency (MHz)	Result	Measured Frequency (MHz)	Result
20	55.2	5180.0172	PASS	5180.0149	PASS	5180.0177	PASS	5180.0169	PASS
	48	5180.0162	PASS	5180.0149	PASS	5180.0181	PASS	5180.0172	PASS
	40.8	5180.0168	PASS	5180.0155	PASS	5180.0185	PASS	5180.0181	PASS

4.7 6dB Bandwidth Measurement

4.7.1 Limits of 6dB Bandwidth Measurement

The minimum of 6dB Bandwidth Measurement is 0.5MHz.

4.7.2 Test Setup

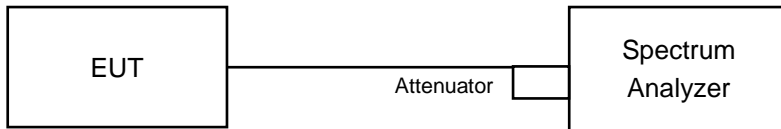

4.7.3 Test Instruments

Refer to section 4.1.2 to get information of above instrument.

4.7.4 Test Procedure

- Set resolution bandwidth (RBW) = 100kHz
- Set the video bandwidth (VBW) $\geq 3 \times$ RBW, Detector = Peak.
- Trace mode = max hold.
- Sweep = auto couple.
- Measure the maximum width of the emission that is constrained by the frequencies associated with the two amplitude points (upper and lower) that are attenuated by 6 dB relative to the maximum level measured in the fundamental emission

4.7.5 Deviation from Test Standard

No deviation.

4.7.6 EUT Operating Condition

The software provided by client to enable the EUT under transmission condition continuously at lowest, middle and highest channel frequencies individually.

4.7.7 Test Results

802.11a

Channel	Frequency (MHz)	6dB Bandwidth (MHz)		Minimum Limit (MHz)	Pass / Fail
		Chain 0	Chain 1		
149	5745	16.42	16.43	0.5	Pass
157	5785	16.38	16.41	0.5	Pass
165	5825	16.38	16.42	0.5	Pass

802.11n (HT20)

Channel	Frequency (MHz)	6dB Bandwidth (MHz)		Minimum Limit (MHz)	Pass / Fail
		Chain 0	Chain 1		
149	5745	17.67	17.65	0.5	Pass
157	5785	17.69	17.64	0.5	Pass
165	5825	17.68	17.64	0.5	Pass

802.11n (HT40)

Channel	Frequency (MHz)	6dB Bandwidth (MHz)		Minimum Limit (MHz)	Pass / Fail
		Chain 0	Chain 1		
151	5755	35.77	35.21	0.5	Pass
159	5795	35.83	35.18	0.5	Pass

802.11ac (VHT80)

Channel	Frequency (MHz)	6dB Bandwidth (MHz)		Minimum Limit (MHz)	Pass / Fail
		Chain 0	Chain 1		
155	5775	76.33	76.31	0.5	Pass

Spectrum Plot of Worst Value

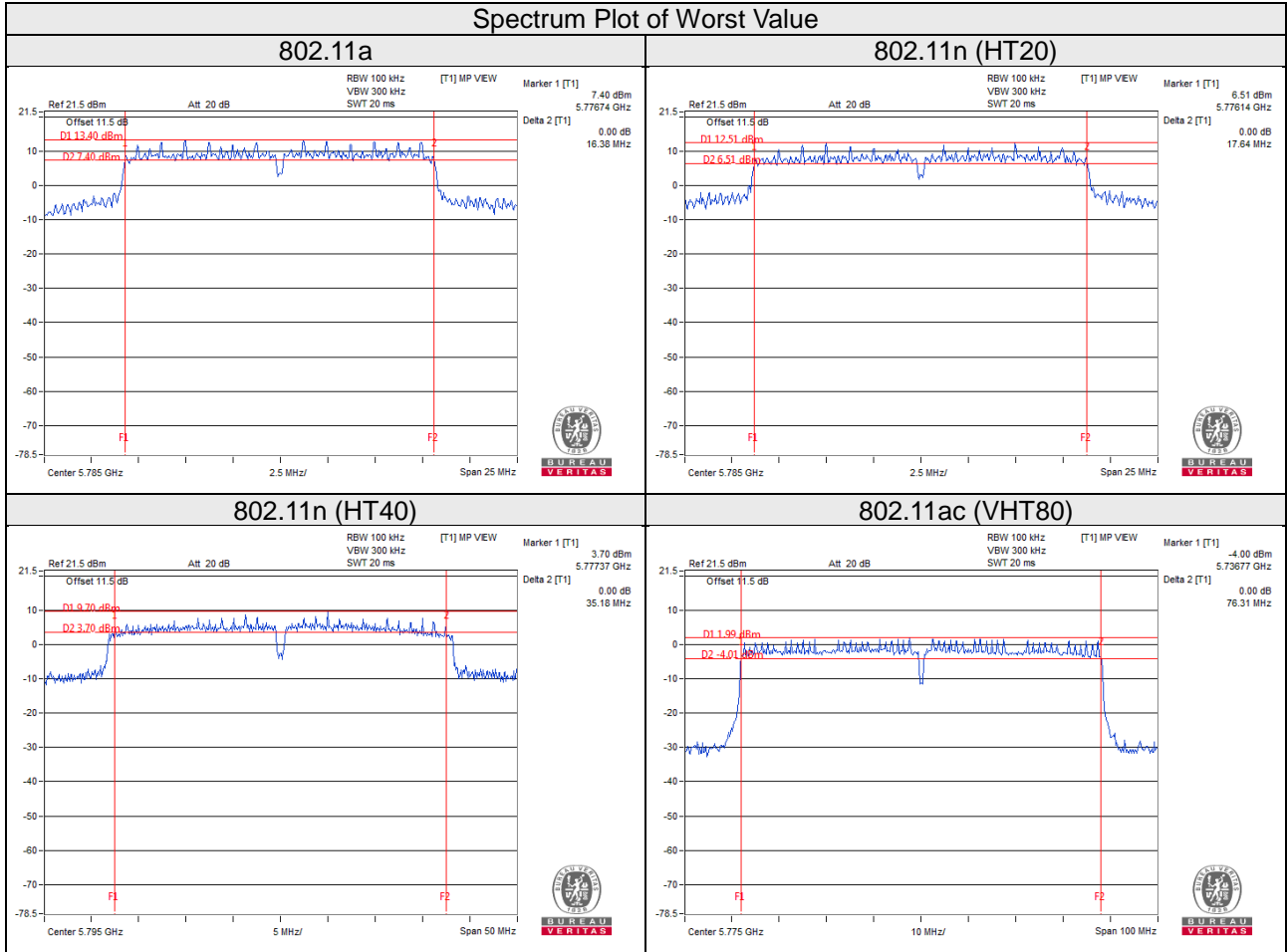

5 Pictures of Test Arrangements

Please refer to the attached file (Test Setup Photo).

Annex A- Radiated Out of Band Emission (OOBE) Measurement (For U-NII-3 band)

802.11a

CH 149 5745 MHz

Horizontal

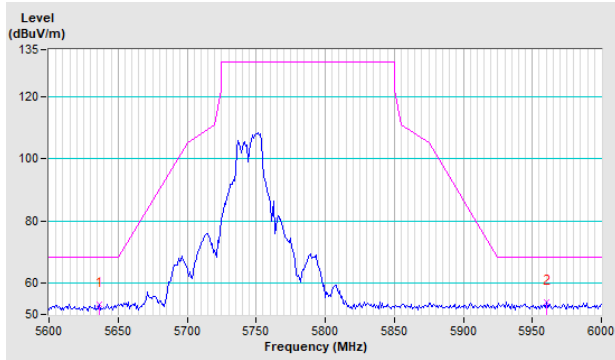

Vertical

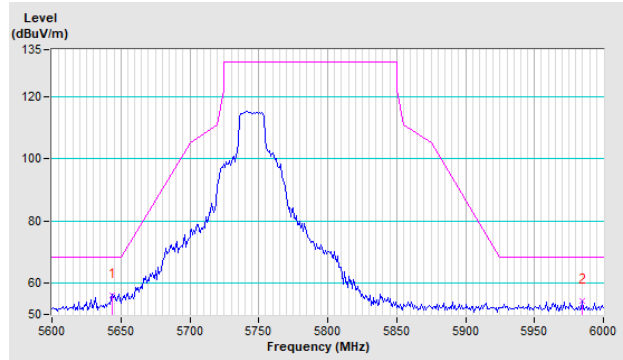

CH 157 5785 MHz

Horizontal

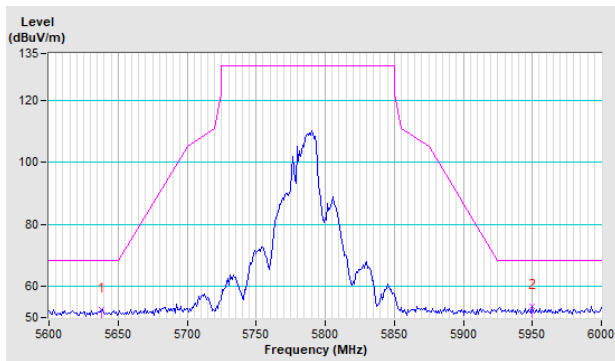

Vertical

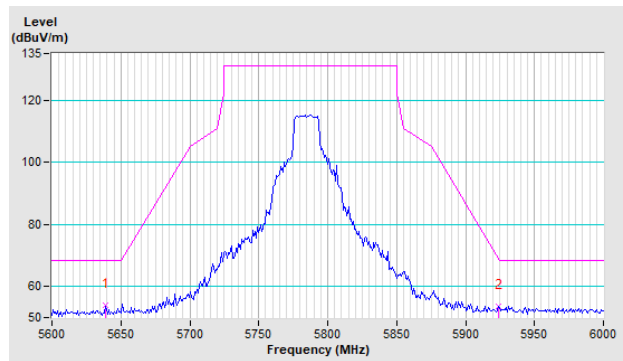

CH 165 5825 MHz

Horizontal

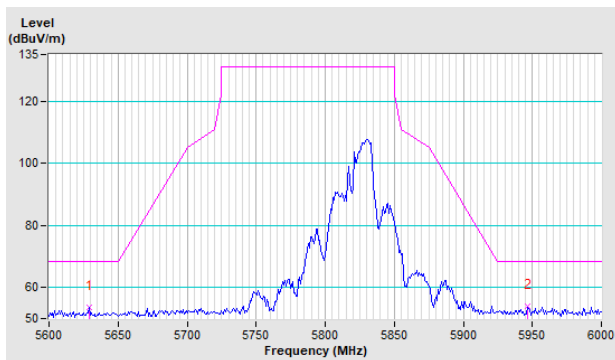

Vertical

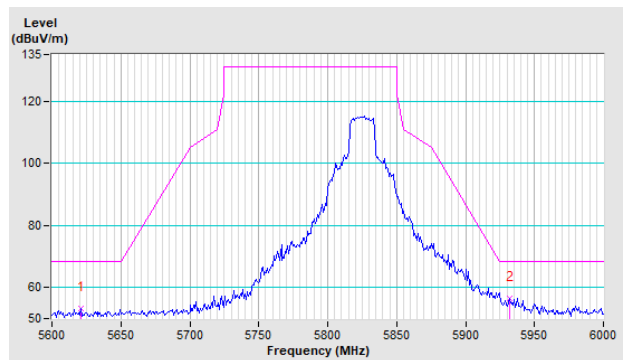

802.11n (HT20)

CH 149 5745 MHz

Horizontal

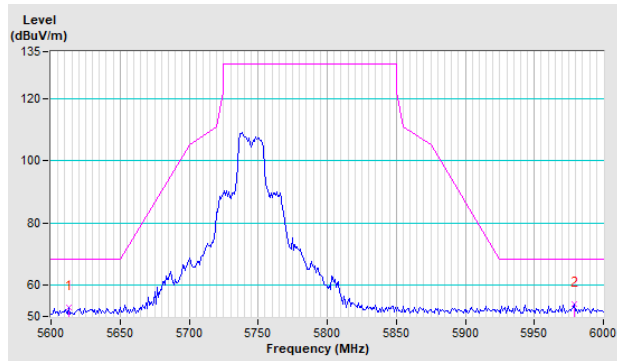

Vertical

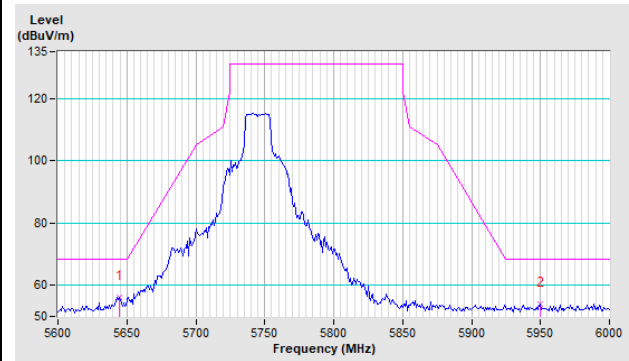

CH 157 5785 MHz

Horizontal

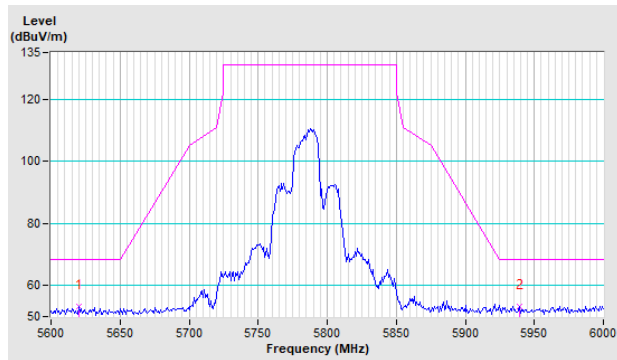

Vertical

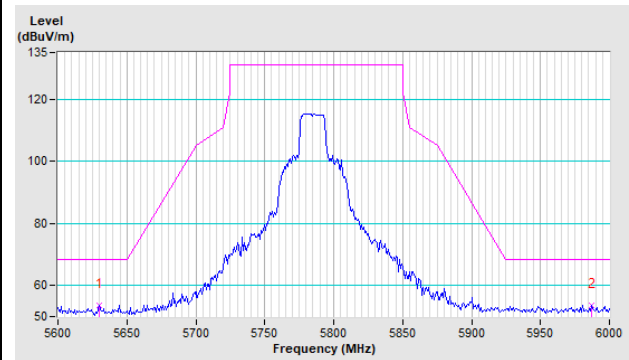

CH 165 5825 MHz

Horizontal

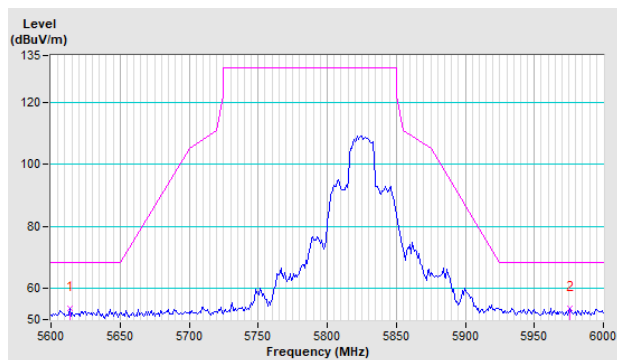

Vertical

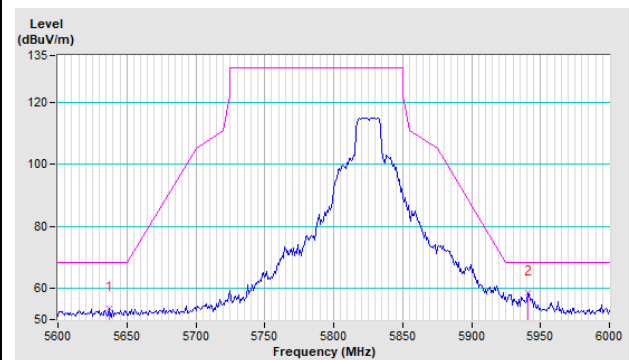

802.11n (HT40)

CH 151 5755 MHz

Horizontal

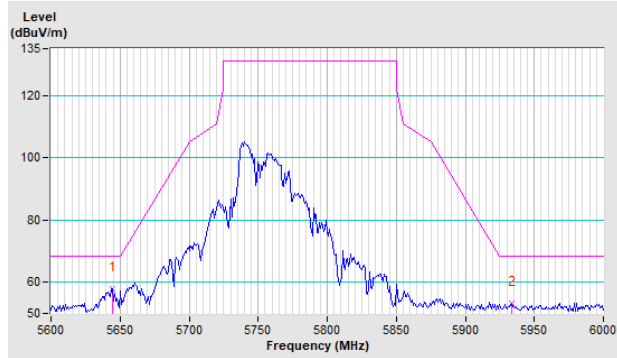

Vertical

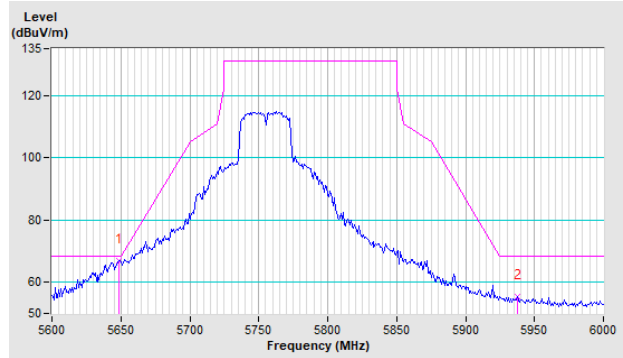

CH 159 5795 MHz

Horizontal

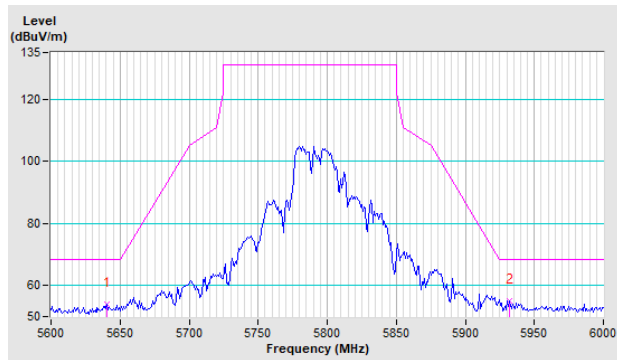

Vertical

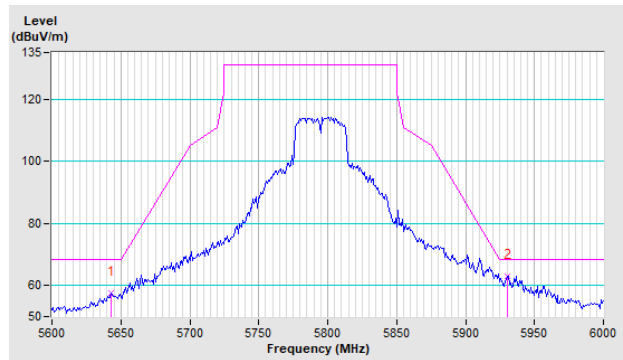

802.11ac (VHT80)

CH 155 5775 MHz

Horizontal

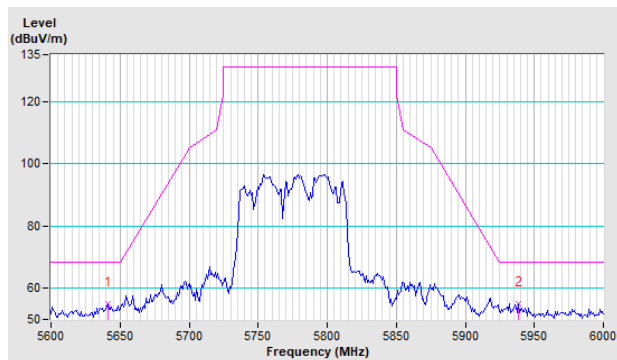

Vertical

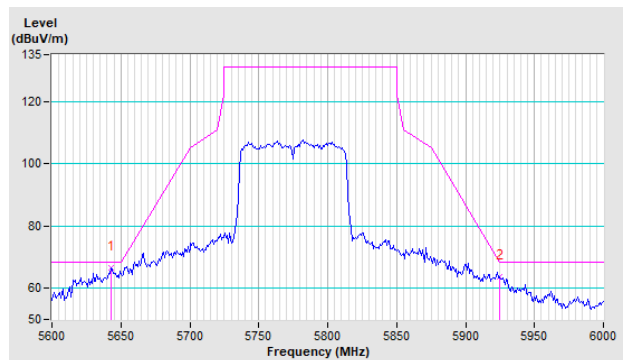

Annex B- Band Edge Measurement

802.11a

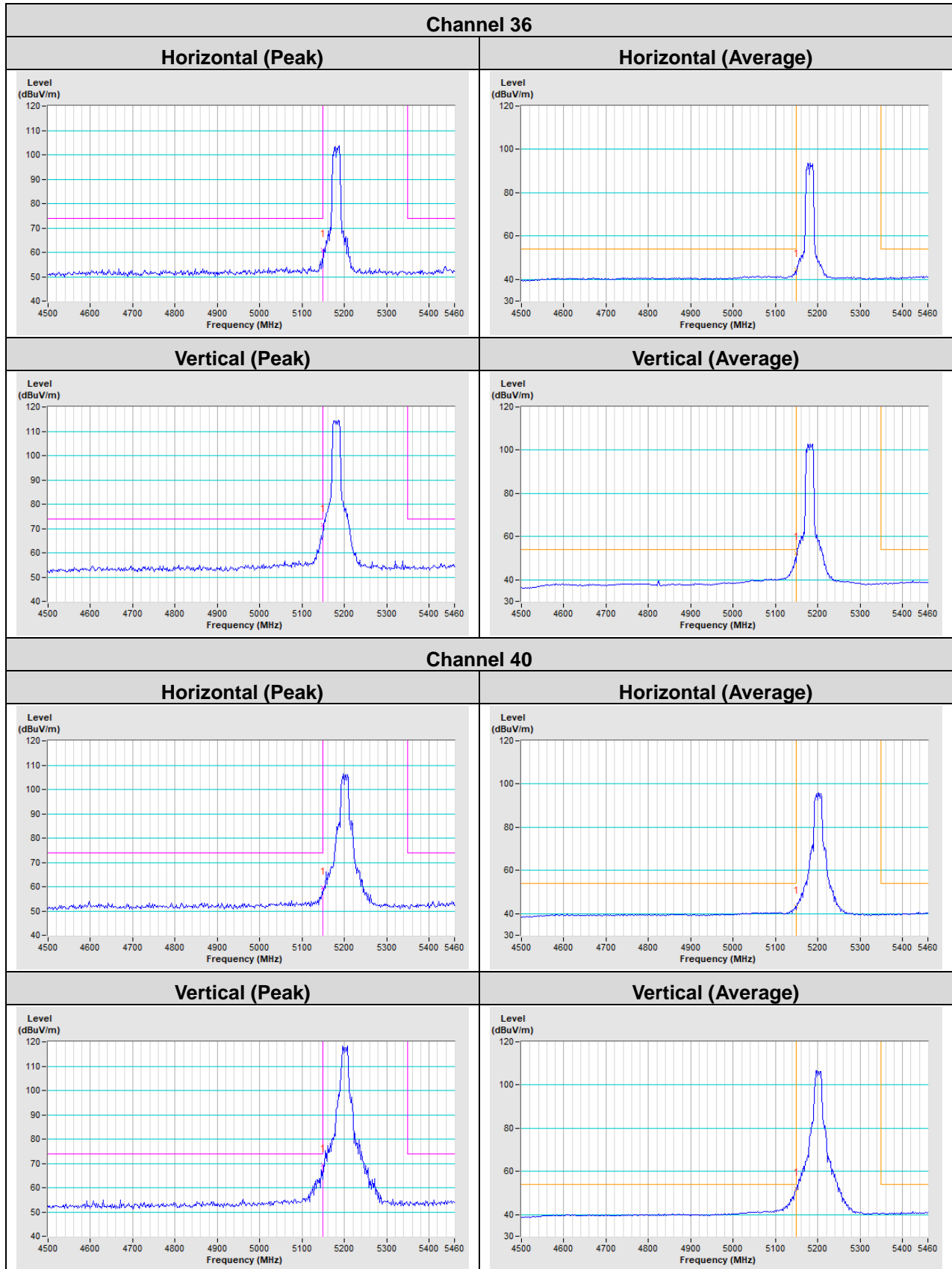

Channel 48

Horizontal (Peak)

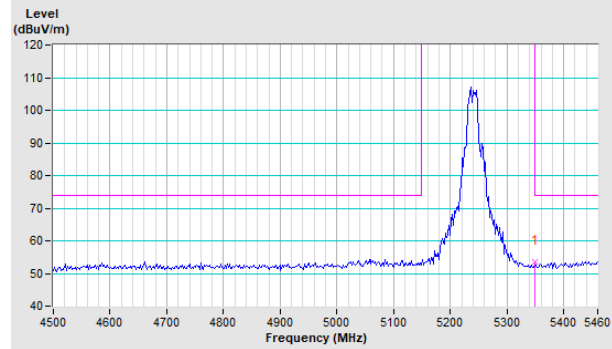

Horizontal (Average)

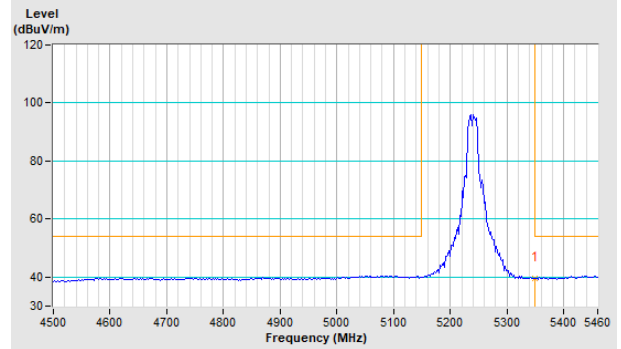

Vertical (Peak)

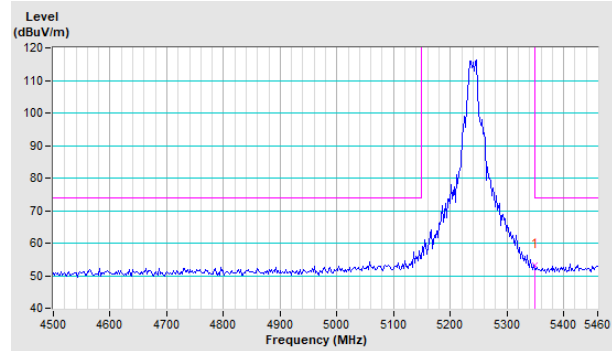

Vertical (Average)

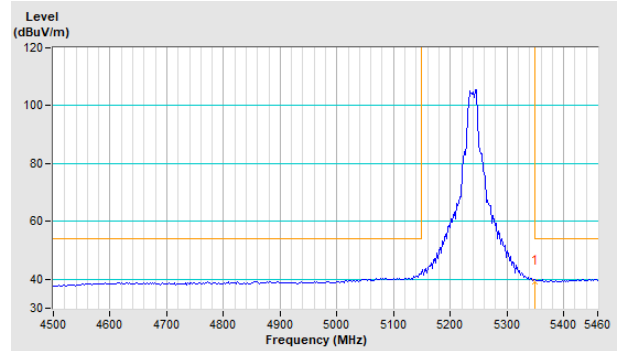

802.11n (HT20)

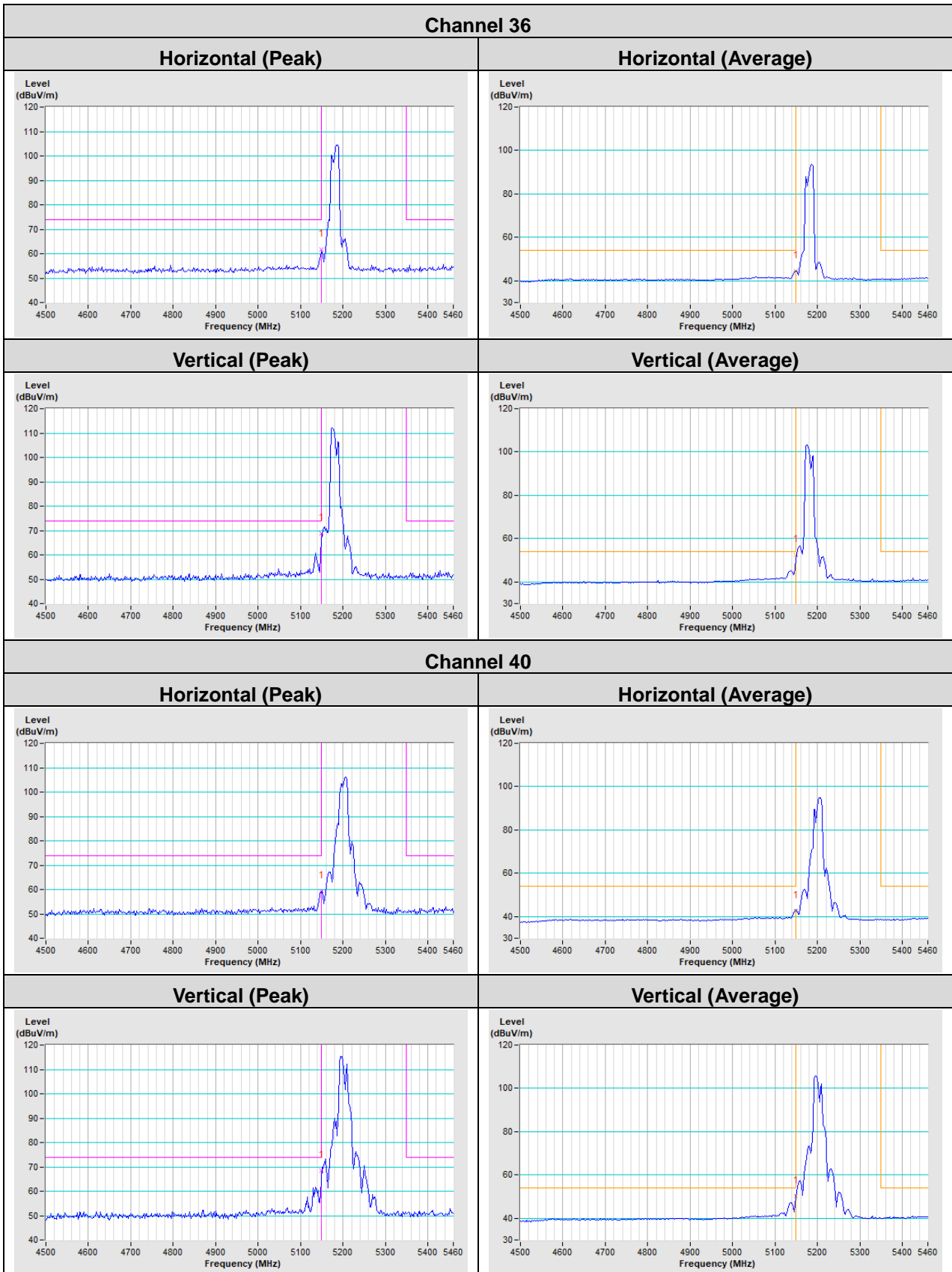

Channel 48

Horizontal (Peak)

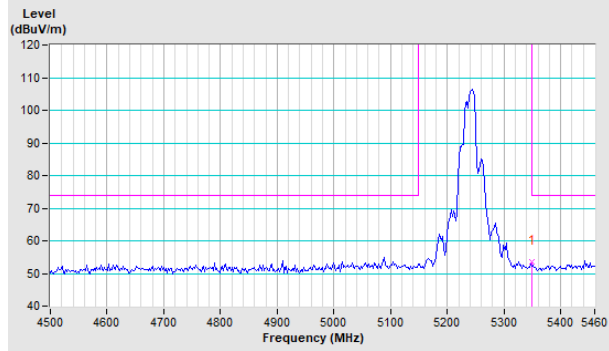

Horizontal (Average)

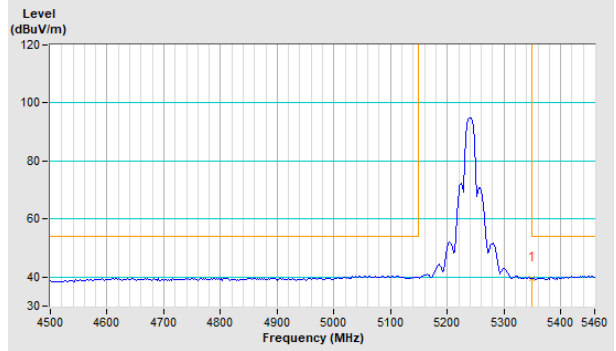

Vertical (Peak)

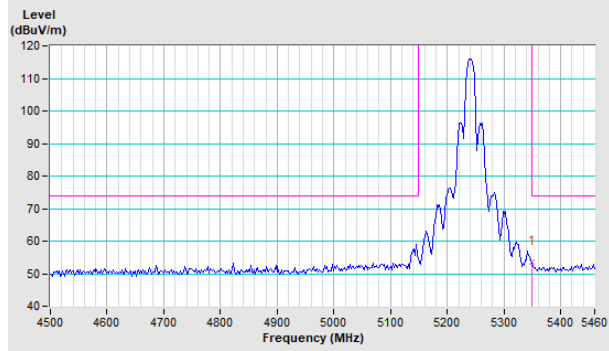

Vertical (Average)

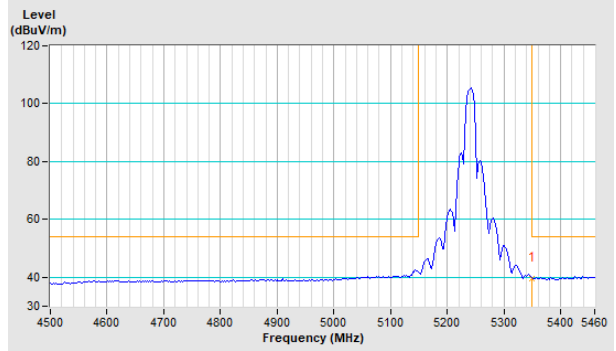

802.11n (HT40)

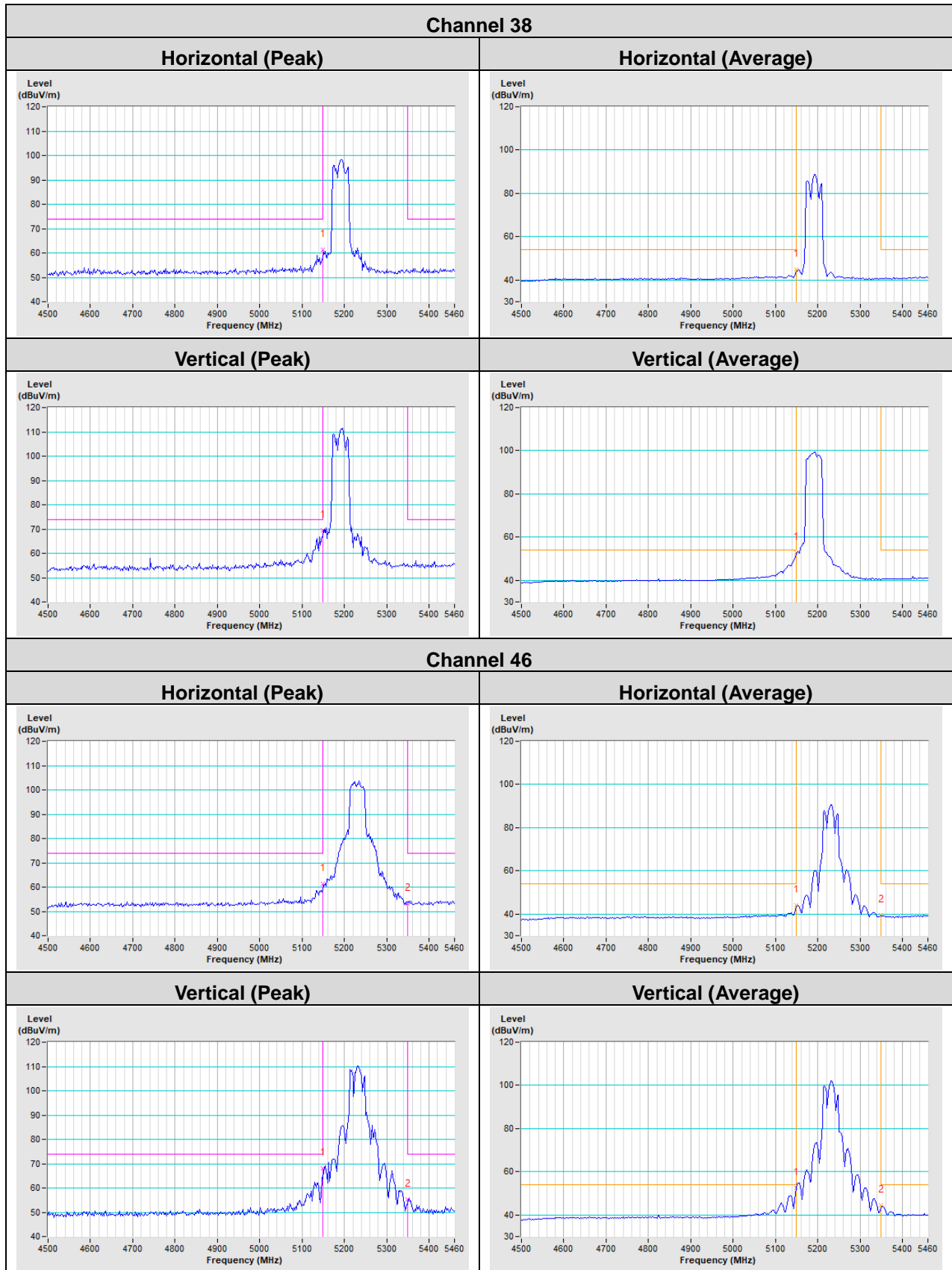

802.11ac (VHT80)

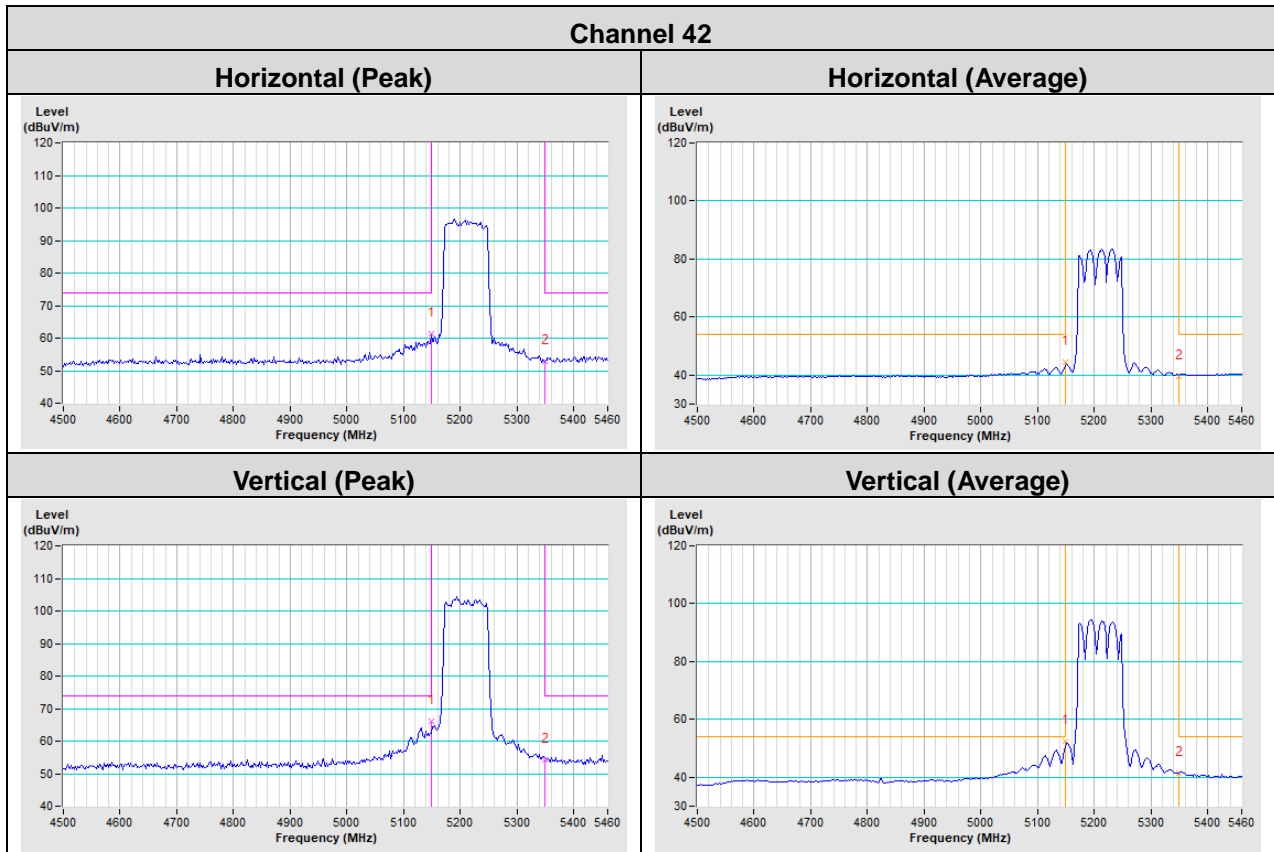

Appendix – Information of the Testing Laboratories

We, Bureau Veritas Consumer Products Services (H.K.) Ltd., Taoyuan Branch, were founded in 1988 to provide our best service in EMC, Radio, Telecom and Safety consultation. Our laboratories are FCC recognized accredited test firms and accredited according to ISO/IEC 17025.

If you have any comments, please feel free to contact us at the following:

Lin Kou EMC/RF Lab

Tel: 886-2-26052180

Fax: 886-2-26051924

Hsin Chu EMC/RF/Telecom Lab

Tel: 886-3-6668565

Fax: 886-3-6668323

Hwa Ya EMC/RF/Safety Lab

Tel: 886-3-3183232

Fax: 886-3-3270892

Email: service.adt@tw.bureauveritas.com

Web Site: www.bureauveritas-adt.com

The address and road map of all our labs can be found in our web site also.

--- END ---