

FCC Test Report

Report No.: RF200116C09

FCC ID: KA2WL8720APA1

Test Model: DWL-8720AP

Received Date: Jan. 16, 2020

Test Date: Jan. 21, 2020 ~ Mar. 08, 2020

Issued Date: Jun. 02, 2020

Applicant: D-Link Corporation

Address: 17595 Mt. Herrmann, Fountain Valley, California, United States, 92708

Issued By: Bureau Veritas Consumer Products Services (H.K.) Ltd., Taoyuan Branch
Lin Kou Laboratories

Lab Address: No. 47-2, 14th Ling, Chia Pau Vil., Lin Kou Dist., New Taipei City, Taiwan

Test Location: No.19, Hwa Ya 2nd Rd., Wen Hwa Vil., Kwei Shan Dist., Taoyuan City
33383, Taiwan

**FCC Registration /
Designation Number:** 788550 / TW0003



This report is for your exclusive use. Any copying or replication of this report to or for any other person or entity, or use of our name or trademark, is permitted only with our prior written permission. This report sets forth our findings solely with respect to the test samples identified herein. The results set forth in this report are not indicative or representative of the quality or characteristics of the lot from which a test sample was taken or any similar or identical product unless specifically and expressly noted. Our report includes all of the tests requested by you and the results thereof based upon the information that you provided to us. You have 60 days from date of issuance of this report to notify us of any material error or omission caused by our negligence, provided, however, that such notice shall be in writing and shall specifically address the issue you wish to raise. A failure to raise such issue within the prescribed time shall constitute your unqualified acceptance of the completeness of this report, the tests conducted and the correctness of the report contents. Unless specific mention, the uncertainty of measurement has been explicitly taken into account to declare the compliance or non-compliance to the specification. The report must not be used by the client to claim product certification, approval, or endorsement by TAF or any government agencies.

Table of Contents

Release Control Record	4
1 Certificate of Conformity	5
2 Summary of Test Results	6
2.1 Measurement Uncertainty	6
2.2 Modification Record	6
3 General Information	7
3.1 General Description of EUT	7
3.2 Description of Test Modes	9
3.2.1 Test Mode Applicability and Tested Channel Detail	10
3.3 Duty Cycle of Test Signal	12
3.4 Description of Support Units	13
3.4.1 Configuration of System under Test	13
3.5 General Description of Applied Standards and References	13
4 Test Types and Results	14
4.1 Radiated Emission and Bandedge Measurement	14
4.1.1 Limits of Radiated Emission and Bandedge Measurement	14
4.1.2 Test Instruments	15
4.1.3 Test Procedures	16
4.1.4 Deviation from Test Standard	17
4.1.5 Test Set Up	17
4.1.6 EUT Operating Conditions	18
4.1.7 Test Results	19
4.2 Conducted Emission Measurement	35
4.2.1 Limits of Conducted Emission Measurement	35
4.2.2 Test Instruments	35
4.2.3 Test Procedures	36
4.2.4 Deviation from Test Standard	36
4.2.5 Test Setup	36
4.2.6 EUT Operating Conditions	36
4.2.7 Test Results	37
4.3 6 dB Bandwidth Measurement	39
4.3.1 Limits of 6 dB Bandwidth Measurement	39
4.3.2 Test Setup	39
4.3.3 Test Instruments	39
4.3.4 Test Procedure	39
4.3.5 Deviation from Test Standard	39
4.3.6 EUT Operating Conditions	39
4.3.7 Test Results	40
4.4 Occupied Bandwidth Measurement	42
4.4.1 Test Setup	42
4.4.2 Test Instruments	42
4.4.3 Test Procedure	42
4.4.4 Deviation from Test Standard	42
4.4.5 EUT Operating Conditions	42
4.4.6 Test Results	43
4.5 Conducted Output Power Measurement	45
4.5.1 Limits of Conducted Output Power Measurement	45
4.5.2 Test Setup	45
4.5.3 Test Instruments	45
4.5.4 Test Procedures	45
4.5.5 Deviation from Test Standard	45
4.5.6 EUT Operating Conditions	45
4.5.7 Test Results	46

4.6	Power Spectral Density Measurement	48
4.6.1	Limits of Power Spectral Density Measurement.....	48
4.6.2	Test Setup.....	48
4.6.3	Test Instruments	48
4.6.4	Test Procedure	48
4.6.5	Deviation from Test Standard	49
4.6.6	EUT Operating Condition	49
4.6.7	Test Results	50
4.7	Conducted Out of Band Emission Measurement	53
4.7.1	Limits of Conducted Out of Band Emission Measurement.....	53
4.7.2	Test Setup.....	53
4.7.3	Test Instruments	53
4.7.4	Test Procedure	53
4.7.5	Deviation from Test Standard	53
4.7.6	EUT Operating Condition	53
4.7.7	Test Results	54
5	Pictures of Test Arrangements.....	70
	Annex A- Band Edge Measurement	71
	Appendix – Information of the Testing Laboratories	79

Release Control Record

Issue No.	Description	Date Issued
RF200116C09	Original Release	Jun. 02, 2020

1 Certificate of Conformity

Product: Unified AC Dual-band Outdoor PoE Access Point

Brand: D-Link

Test Model: DWL-8720AP

Sample Status: Engineering Sample

Applicant: D-Link Corporation

Test Date: Jan. 21, 2020 ~ Mar. 08, 2020

Standards: 47 CFR FCC Part 15, Subpart C (Section 15.247)
ANSI C63.10:2013

The above equipment has been tested by **Bureau Veritas Consumer Products Services (H.K.) Ltd., Taoyuan Branch**, and found compliance with the requirement of the above standards. The test record, data evaluation & Equipment Under Test (EUT) configurations represented herein are true and accurate accounts of the measurements of the sample's RF characteristics under the conditions specified in this report.

Prepared by : , **Date:** Jun. 02, 2020
Lena Wang / Specialist

Approved by : , **Date:** Jun. 02, 2020
Dylan Chiou / Senior Project Engineer

2 Summary of Test Results

47 CFR FCC Part 15, Subpart C (Section 15.247)			
FCC Clause	Test Item	Result	Remarks
15.207	AC Power Conducted Emission	Pass	Meet the requirement of limit. Minimum passing margin is -10.58 dB at 0.17800 MHz.
15.205 / 15.209 / 15.247(d)	Radiated Emissions and Band Edge Measurement	Pass	Meet the requirement of limit. Minimum passing margin is -0.8 dB at 2390.00 MHz.
15.247(d)	Antenna Port Emission	Pass	Meet the requirement of limit.
15.247(a)(2)	6 dB Bandwidth	Pass	Meet the requirement of limit.
---	Occupied Bandwidth Measurement	Pass	Reference only
15.247(b)	Conducted power	Pass	Meet the requirement of limit.
15.247(e)	Power Spectral Density	Pass	Meet the requirement of limit.
15.203	Antenna Requirement	Pass	Antenna connector is R-N type(F) not a standard connector.

Note:

- For 2.4G band compliance with rule 15.247(d) of the band-edge items, the test plots were recorded in Annex A. Test Procedures refer to report 4.1.3.
- Determining compliance based on the results of the compliance measurement, not taking into account measurement instrumentation uncertainty.

2.1 Measurement Uncertainty

Where relevant, the following measurement uncertainty levels have been estimated for tests performed on the EUT as specified in CISPR 16-4-2:

Measurement	Frequency	Expanded Uncertainty (k=2) (\pm)
Conducted Emissions at mains ports	150 kHz ~ 30 MHz	2.79 dB
Radiated Emissions up to 1 GHz	9 kHz ~ 30 MHz	3.04 dB
	30 MHz ~ 200 MHz	2.93 dB
	200 MHz ~ 1000 MHz	2.95 dB
Radiated Emissions above 1 GHz	1 GHz ~ 18 GHz	2.26 dB
	18 GHz ~ 40 GHz	1.94 dB

2.2 Modification Record

There were no modifications required for compliance.

3 General Information

3.1 General Description of EUT

Product	Unified AC Dual-band Outdoor PoE Access Point
Brand	D-Link
Test Model	DWL-8720AP
Status of EUT	Engineering Sample
Power Supply Rating	54Vdc (PoE)
Modulation Type	CCK, DQPSK, DBPSK for DSSS 256QAM, 64QAM, 16QAM, QPSK, BPSK for OFDM
Modulation Technology	DSSS, OFDM
Transfer Rate	802.11b: 11.0 / 5.5 / 2.0 / 1.0 Mbps 802.11g: 54.0 / 48.0 / 36.0 / 24.0 / 18.0 / 12.0 / 9.0 / 6.0 Mbps 802.11n: up to 400 Mbps
Operating Frequency	2412 ~ 2462 MHz
Number of Channel	11 for 802.11b, 802.11g, 802.11n (HT20), 802.11n (VHT20) 7 for 802.11n (HT40), 802.11n (VHT40)
Output Power	CDD Mode: 652.739 mW Beamforming Mode: 220.800 mW
Antenna Type	Refer to Note as below
Antenna Connector	Refer to Note as below
Accessory Device	Refer to Note as below
Data Cable Supplied	Refer to Note as below

Note:

1. The EUT incorporates a MIMO function. Physically, the EUT provides two completed transmitters and two receivers.

Modulation Mode	Beamforming Mode	Tx Function
802.11b	Not Support	2TX
802.11g	Not Support	2TX
802.11n (HT20)	Support	2TX
802.11n (HT40)	Support	2TX
802.11n (VHT20)	Support	2TX
802.11n (VHT40)	Support	2TX

* The bandwidth and modulation are similar for HT20/HT40 on 802.11n mode and VHT20/VHT40 on 802.11n mode. Therefore the investigated worst case is the representative mode in test report. (Final test mode refer section 3.2.1)

* For 802.11n, CDD mode is the worst case for final radiated emission and power line conducted emission tests after pretesting CDD mode and beamforming mode.

2. The following antennas were provided to the EUT.

No.	Type	Connector	Gain (dBi)							
			2400 MHz	2450 MHz	2500 MHz	4900 MHz	5150 MHz	5350 MHz	5725 MHz	5825 MHz
1	Dipole	R-N type(F)	3.5	3.4	3.1	5.1	6.0	5.8	5.5	5.3
2	Dipole	R-N type(F)	3.5	3.4	3.1	5.1	6.0	5.8	5.5	5.3

3. The EUT contains following accessory devices.

Product	Brand	Model	Description
Console Cable	N/A	N/A	1 m non-shielded without core
GND Cable	N/A	N/A	1m non-shielded ground cable without core

4. The test support unit which provided by client is listed as below.

Product	Brand	Model	Description
POE	LEADER ELECTRONICS INC.	NU90-J540167-I1	I/P: 100-240 Vac, 50/60 Hz, 1.2 A O/P: 54 Vdc, 1.67 A Power Cord: 1.5m non-shielded power cord without core

5. **There're 2 configurations for the EUT listed as below.**

Mode A: Flat Type iron frame

Mode B: C Type iron frame

6. Spurious emission of the simultaneous operation (2.4GHz and 5GHz) has been evaluated and no non-compliance was found.
7. The above EUT information is declared by manufacturer and for more detailed features description, please refers to the manufacturer's specifications or user's manual.

3.2 Description of Test Modes

11 channels are provided for 802.11b, 802.11g and 802.11n (HT20):

Channel	Frequency (MHz)	Channel	Frequency (MHz)
1	2412	7	2442
2	2417	8	2447
3	2422	9	2452
4	2427	10	2457
5	2432	11	2462
6	2437		

7 channels are provided for 802.11n (HT40):

Channel	Frequency (MHz)	Channel	Frequency (MHz)
3	2422	7	2442
4	2427	8	2447
5	2432	9	2452
6	2437		

3.2.1 Test Mode Applicability and Tested Channel Detail

EUT Configure Mode	Applicable To				Description
	RE \geq 1G	RE<1G	PLC	APCM	
A	√	√	√	√	For Flat Type iron frame
B	-	√	-	-	For C Type iron frame

Where **RE \geq 1G**: Radiated Emission above 1 GHz **RE<1G**: Radiated Emission below 1 GHz
PLC: Power Line Conducted Emission **APCM**: Antenna Port Conducted Measurement

NOTE: The EUT had been pre-tested on the positioned of each 3 axis. The worst case was found when positioned on **Z-plane**.
NOTE: "-" means no effect.

Radiated Emission Test (Above 1 GHz):

- Pre-Scan has been conducted to determine the worst-case mode from all possible combinations between available modulations, data rates and antenna ports (if EUT with antenna diversity architecture).
- Following channel(s) was (were) selected for the final test as listed below.

EUT Configure Mode	Mode	Available Channel	Tested Channel	Modulation Technology	Modulation Type	Data Rate (Mbps)
A	802.11b	1 to 11	1, 6, 11	DSSS	DBPSK	1.0
	802.11g	1 to 11	1, 6, 11	OFDM	BPSK	6.0
	802.11n (HT20)	1 to 11	1, 6, 11	OFDM	BPSK	6.5
	802.11n (HT40)	3 to 9	3, 6, 9	OFDM	BPSK	13.5

Radiated Emission Test (Below 1 GHz):

- Pre-Scan has been conducted to determine the worst-case mode from all possible combinations between available modulations, data rates and antenna ports (if EUT with antenna diversity architecture).
- Following channel(s) was (were) selected for the final test as listed below.

EUT Configure Mode	Mode	Available Channel	Tested Channel	Modulation Technology	Modulation Type	Data Rate (Mbps)
A · B	802.11b	1 to 11	6	DSSS	DBPSK	1.0

Power Line Conducted Emission Test:

- Pre-Scan has been conducted to determine the worst-case mode from all possible combinations between available modulations, data rates and antenna ports (if EUT with antenna diversity architecture).
- Following channel(s) was (were) selected for the final test as listed below.

EUT Configure Mode	Mode	Available Channel	Tested Channel	Modulation Technology	Modulation Type	Data Rate (Mbps)
A	802.11b	1 to 11	6	DSSS	DBPSK	1.0

Bandedge Measurement:

- Pre-Scan has been conducted to determine the worst-case mode from all possible combinations between available modulations, data rates and antenna ports (if EUT with antenna diversity architecture).
- Following channel(s) was (were) selected for the final test as listed below.

EUT Configure Mode	Mode	Available Channel	Tested Channel	Modulation Technology	Modulation Type	Data Rate (Mbps)
A	802.11b	1 to 11	1, 6, 11	DSSS	DBPSK	1.0
	802.11g	1 to 11	1, 6, 11	OFDM	BPSK	6.0
	802.11n (HT20)	1 to 11	1, 6, 11	OFDM	BPSK	6.5
	802.11n (HT40)	3 to 9	3, 6, 9	OFDM	BPSK	13.5

Antenna Port Conducted Measurement:

- This item includes all test value of each mode, but only includes spectrum plot of worst value of each mode.
- Pre-Scan has been conducted to determine the worst-case mode from all possible combinations between available modulations, data rates and antenna ports (if EUT with antenna diversity architecture).
- Following channel(s) was (were) selected for the final test as listed below.

EUT Configure Mode	Mode	Available Channel	Tested Channel	Modulation Technology	Modulation Type	Data Rate (Mbps)
A	802.11b	1 to 11	1, 6, 11	DSSS	DBPSK	1.0
	802.11g	1 to 11	1, 6, 11	OFDM	BPSK	6.0
	802.11n (HT20)	1 to 11	1, 6, 11	OFDM	BPSK	6.5
	802.11n (HT40)	3 to 9	3, 6, 9	OFDM	BPSK	13.5

Test Condition:

Applicable To	Environmental Conditions	Input Power	Tested by
RE≥1G	25 deg. C, 65 % RH	120 Vac, 60 Hz	Greg Lin, Han Wu
RE<1G	25 deg. C, 65 % RH	120 Vac, 60 Hz	Han Wu
PLC	25 deg. C, 65 % RH	120 Vac, 60 Hz	Jones Chang
APCM	25 deg. C, 65 % RH	48 Vdc	Chris Lin

3.3 Duty Cycle of Test Signal

Duty cycle of test signal is $\geq 98\%$, duty factor is not required.

Duty cycle of test signal is $< 98\%$, duty factor shall be considered.

802.11b: Duty cycle = $12.414/12.543 = 0.99$.

802.11g: Duty cycle = $2.06/2.16 = 0.954$, Duty factor = $10 * \log(1/0.954) = 0.21$

802.11n (HT20): Duty cycle = $4.995/5.098 = 0.98$.

802.11n (HT40): Duty cycle = $2.418/2.51 = 0.963$, Duty factor = $10 * \log(1/0.963) = 0.16$

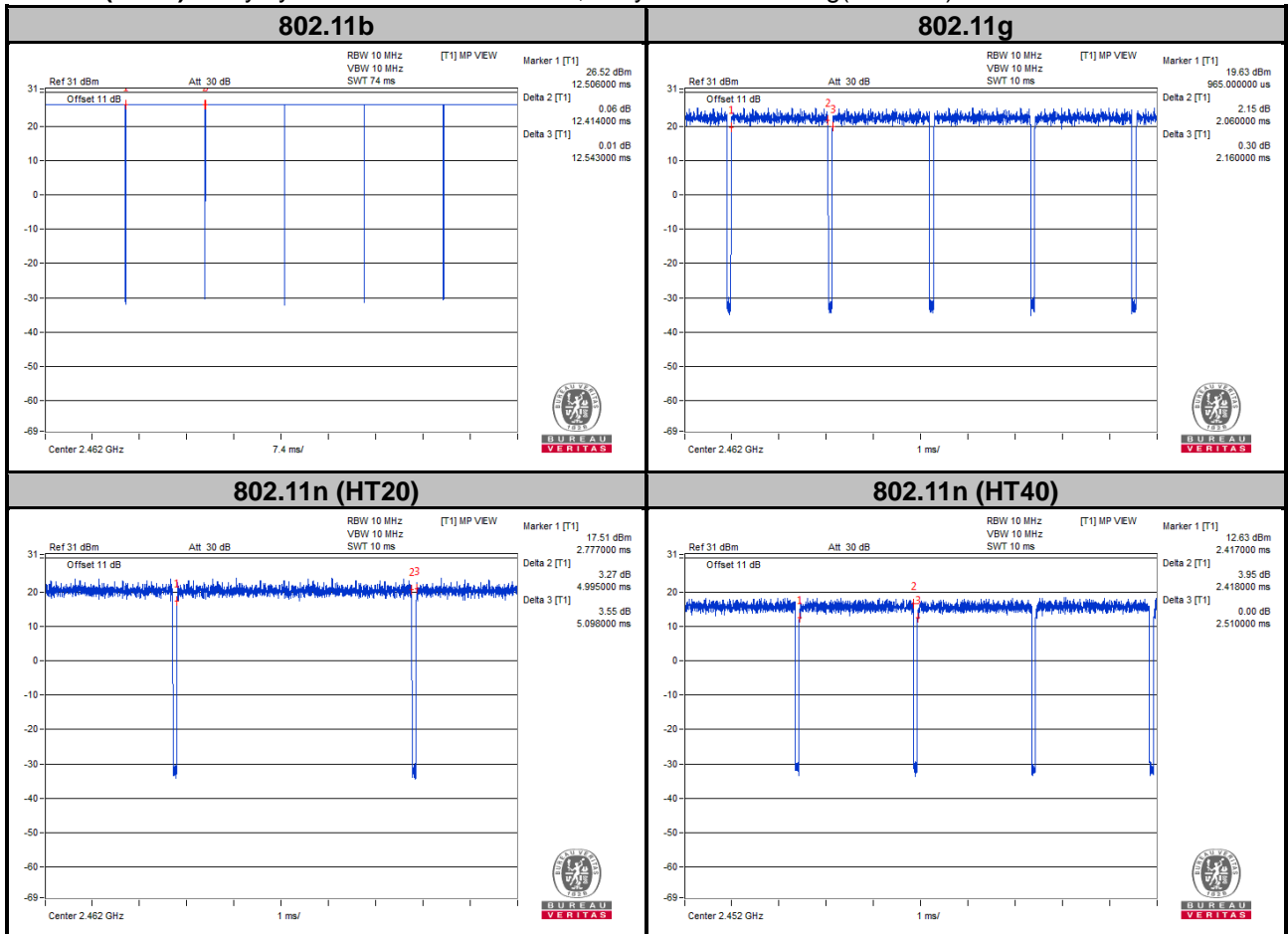

3.4 Description of Support Units

The EUT has been tested as an independent unit together with other necessary accessories or support units. The following support units or accessories were used to form a representative test configuration during the tests.

No.	Product	Brand	Model No.	Serial No.	FCC ID	Remarks
A	Notebook	DELL	E5420	33MJMQ1	FCC DoC Approved	Provided by Lab
B	POE	LEADER ELECTRONICS INC.	NU90-J540167-I1	N/A	N/A	Provided by Client

ID	Cable Descriptions	Qty.	Length (m)	Shielding (Yes/No)	Cores (Qty.)	Remarks
1.	LAN Cable	1	10	N	0	RJ45, Cat5e
2.	LAN Cable	1	1.5	N	0	RJ45, Cat5e, Provided by client.
3.	GND Cable	1	1	N	0	Provided by client.

Note:

1. All power cords of the above support units are non-shielded (1.8m).
2. Items A acted as communication partners to transfer data.
3. Items B was provided by client.

3.4.1 Configuration of System under Test

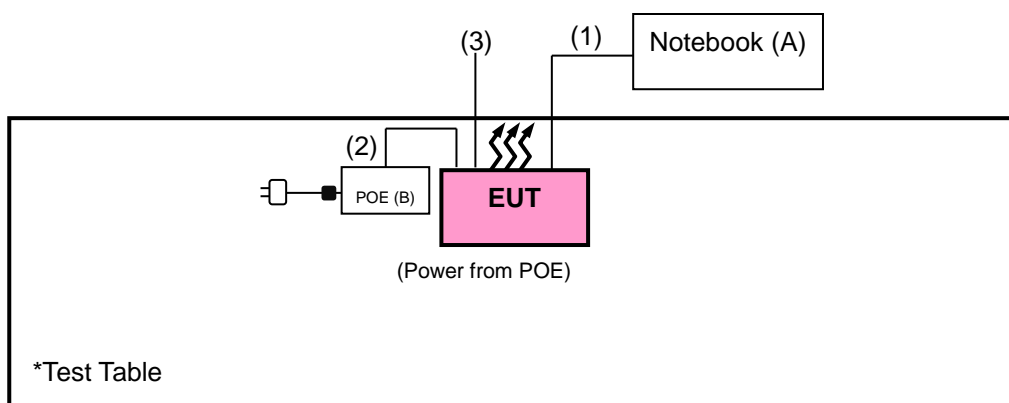

3.5 General Description of Applied Standards and References

The EUT is a RF Product. According to the specifications of the manufacturer, it must comply with the requirements of the following standards and references:

Test Standard:

FCC Part 15, Subpart C (15.247)

ANSI C63.10-2013

All test items have been performed and recorded as per the above standards.

References Test Guidance:

KDB 558074 D01 Meas Guidance v05r02

KDB 662911 D01 Multiple Transmitter Output v02r01

All test items have been performed as a reference to the above KDB test guidance.

4 Test Types and Results

4.1 Radiated Emission and Bandedge Measurement

4.1.1 Limits of Radiated Emission and Bandedge Measurement

Radiated emissions which fall in the restricted bands must comply with the radiated emission limits specified as below table. Other emissions shall be at least 20 dB below the highest level of the desired power:

Frequencies (MHz)	Field Strength (microvolts/meter)	Measurement Distance (meters)
0.009 ~ 0.490	2400/F (kHz)	300
0.490 ~ 1.705	24000/F (kHz)	30
1.705 ~ 30.0	30	30
30 ~ 88	100	3
88 ~ 216	150	3
216 ~ 960	200	3
Above 960	500	3

NOTE:

1. The lower limit shall apply at the transition frequencies.
2. Emission level (dBuV/m) = 20 log Emission level (uV/m).
3. For frequencies above 1000 MHz, the field strength limits are based on average detector, however, the peak field strength of any emission shall not exceed the maximum permitted average limits, specified above by more than 20 dB under any condition of modulation.

4.1.2 Test Instruments

Description & Manufacturer	Model No.	Serial No.	Date of Calibration	Due Date of Calibration
Test Receiver KEYSIGHT	N9038A	MY55420137	Apr. 15, 2019	Apr. 14, 2020
Spectrum Analyzer ROHDE & SCHWARZ	FSP40	100269	Jun. 04, 2019	Jun. 03, 2020
BILOG Antenna SCHWARZBECK	VULB9168	9168-160	Nov. 07, 2019	Nov. 06, 2020
HORN Antenna SCHWARZBECK	BBHA 9120 D	9120D-1169	Nov. 24, 2019	Nov. 23, 2020
HORN Antenna SCHWARZBECK	BBHA 9170	BBHA9170241	Nov. 24, 2019	Nov. 23, 2020
Preamplifier Agilent (Below 1GHz)	8447D	2944A10638	Jul. 11, 2019	Jul. 10, 2020
Preamplifier Agilent (Above 1GHz)	8449B	3008A02367	Feb. 19, 2019	Feb. 18, 2020
			Feb. 18, 2020	Feb. 17, 2021
RF signal cable HUBER+SUHNER&EMCI	SUCOFLEX 104 & EMC104-SM- SM8000	CABLE-CH9-02 (248780+171006)	Jan. 18, 2020	Jan. 17, 2021
RF signal cable HUBER+SUHNER	SUCOFLEX 104	CABLE-CH9- (250795/4)	Jul. 11, 2019	Jul. 10, 2020
RF signal cable Woken	8D-FB	Cable-CH9-01	Jul. 30, 2019	Jul. 29, 2020
Software BV ADT	ADT_Radiated_ V7.6.15.9.5	NA	NA	NA
Antenna Tower EMCO	2070/2080	512.835.4684	NA	NA
Turn Table EMCO	2087-2.03	NA	NA	NA
Antenna Tower & Turn BV ADT	AT100	AT93021705	NA	NA
Turn Table BV ADT	TT100	TT93021705	NA	NA
Turn Table Controller BV ADT	SC100	SC93021705	NA	NA
Boresight Antenna Fixture	FBA-01	FBA-SIP01	NA	NA
USB Wideband Power Sensor KEYSIGHT	U2021XA	MY55050005/MY55 190004/MY551900 07/MY55210005	Jul. 15, 2019	Jul. 14, 2020

Note: 1. The calibration interval of the above test instruments is 12 months and the calibrations are traceable to NML/ROC and NIST/USA.

2. The test was performed in HwaYa Chamber 9.

4.1.3 Test Procedures

For Radiated Emission below 30 MHz

- a. The EUT was placed on the top of a rotating table 0.8 meters above the ground at a 3 meter chamber room. The table was rotated 360 degrees to determine the position of the highest radiation.
- b. The EUT was set 3 meters away from the interference-receiving antenna, which was mounted on the top of a variable-height antenna tower.
- c. Parallel, perpendicular, and ground-parallel orientations of the antenna are set to make the measurement.
- d. For each suspected emission, the EUT was arranged to its worst case and the rotatable table was turned from 0 degrees to 360 degrees to find the maximum reading.
- e. The test-receiver system was set to Quasi-Peak Detect Function and Specified Bandwidth with Maximum Hold Mode.

Note:

1. The resolution bandwidth and video bandwidth of test receiver/spectrum analyzer is 9 kHz at frequency below 30 MHz.

For Radiated Emission above 30 MHz

- a. The EUT was placed on the top of a rotating table 0.8 meters (for 30 MHz ~ 1 GHz) / 1.5 meters (for above 1 GHz) above the ground at 3 meter chamber room for test. The table was rotated 360 degrees to determine the position of the highest radiation.
- b. The EUT was set 3 meters away from the interference-receiving antenna, which was mounted on the top of a variable-height antenna tower.
- c. The height of antenna is varied from one meter to four meters above the ground to determine the maximum value of the field strength. Both horizontal and vertical polarizations of the antenna are set to make the measurement.
- d. For each suspected emission, the EUT was arranged to its worst case and then the antenna was tuned to heights from 1 meter to 4 meters and the rotatable table was turned from 0 degrees to 360 degrees to find the maximum reading.
- e. The test-receiver system was set to quasi-peak detect function and specified bandwidth with maximum hold mode when the test frequency is below 1 GHz.
- f. The test-receiver system was set to peak and average detected function and specified bandwidth with maximum hold mode when the test frequency is above 1 GHz. If the peak reading value also meets average limit, measurement with the average detector is unnecessary.

Note:

1. The resolution bandwidth and video bandwidth of test receiver/spectrum analyzer is 120 kHz for Quasi-peak detection (QP) or Peak detection (PK) at frequency below 1 GHz.
2. The resolution bandwidth of test receiver/spectrum analyzer is 1 MHz and the video bandwidth is 3 MHz for Peak detection (PK) at frequency above 1 GHz.
3. The resolution bandwidth of test receiver/spectrum analyzer is 1 MHz and the video bandwidth is $\geq 1/T$ (Duty cycle $< 98\%$) or 10 Hz (Duty cycle $\geq 98\%$) for Average detection (AV) at frequency above 1 GHz.
(11b: RBW = 1 MHz, VBW = 10 Hz ; 11g: RBW = 1 MHz, VBW = 1 kHz ;
11n (HT20): RBW = 1 MHz, VBW = 1 kHz ; 11n (HT40): RBW = 1 MHz, VBW = 1 kHz)
4. All modes of operation were investigated and the worst-case emissions are reported.

4.1.4 Deviation from Test Standard

No deviation.

4.1.5 Test Set Up

<Radiated Emission below 30 MHz>

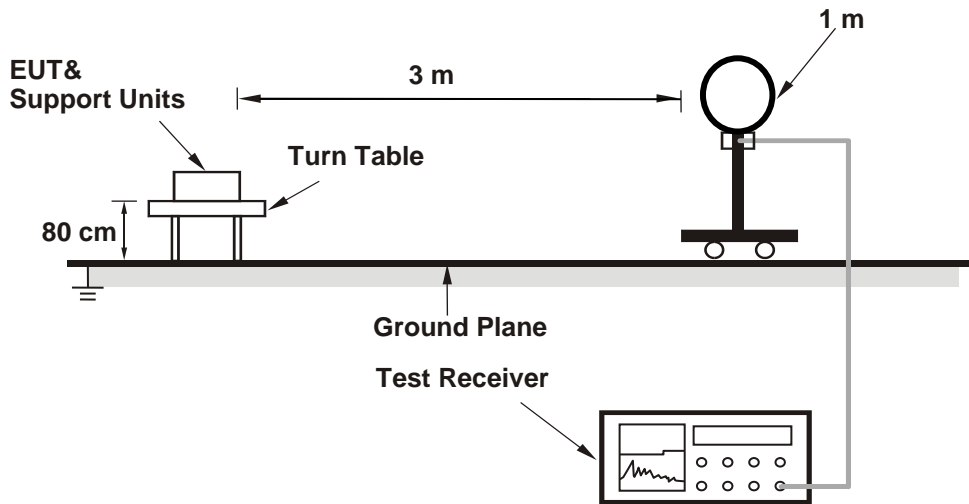

<Radiated Emission 30 MHz to 1 GHz>

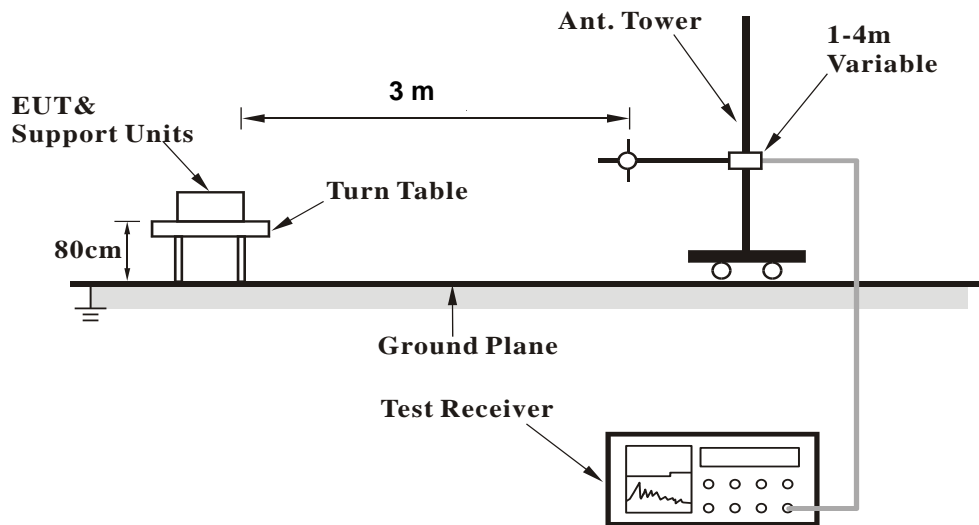

<Radiated Emission above 1 GHz>

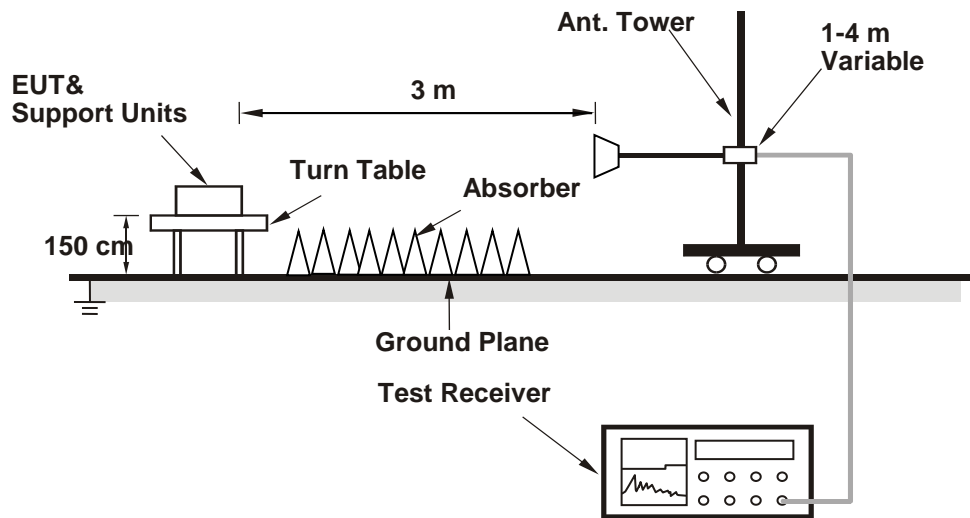

For the actual test configuration, please refer to the attached file (Test Setup Photo).

4.1.6 EUT Operating Conditions

- a. Placed the EUT on a testing table.
- b. Use the software to control the EUT under transmission condition continuously at specific channel frequency.

4.1.7 Test Results

Above 1 GHz Data :

802.11b

CHANNEL	TX Channel 1	DETECTOR FUNCTION	Peak (PK)
FREQUENCY RANGE	1GHz ~ 25GHz		Average (AV)

ANTENNA POLARITY & TEST DISTANCE: HORIZONTAL AT 3 M								
NO.	FREQ. (MHz)	EMISSION LEVEL (dBuV/m)	LIMIT (dBuV/m)	MARGIN (dB)	ANTENNA HEIGHT (m)	TABLE ANGLE (Degree)	RAW VALUE (dBuV)	CORRECTION FACTOR (dB/m)
1	2390.00	56.0 PK	74.0	-18.0	2.13 H	11	24.8	31.2
2	2390.00	45.6 AV	54.0	-8.4	2.13 H	11	14.4	31.2
3	*2412.00	104.9 PK			1.97 H	209	73.8	31.1
4	*2412.00	100.9 AV			1.97 H	209	69.8	31.1
5	4824.00	45.5 PK	74.0	-28.5	2.02 H	343	43.5	2.0
6	4824.00	35.6 AV	54.0	-18.4	2.02 H	343	33.6	2.0
ANTENNA POLARITY & TEST DISTANCE: VERTICAL AT 3 M								
NO.	FREQ. (MHz)	EMISSION LEVEL (dBuV/m)	LIMIT (dBuV/m)	MARGIN (dB)	ANTENNA HEIGHT (m)	TABLE ANGLE (Degree)	RAW VALUE (dBuV)	CORRECTION FACTOR (dB/m)
1	2390.00	60.5 PK	74.0	-13.5	1.96 V	351	29.3	31.2
2	2390.00	52.8 AV	54.0	-1.2	1.96 V	351	21.6	31.2
3	*2412.00	116.3 PK			1.52 V	246	85.2	31.1
4	*2412.00	112.4 AV			1.52 V	246	81.3	31.1
5	4824.00	45.7 PK	74.0	-28.3	1.40 V	354	43.7	2.0
6	4824.00	37.8 AV	54.0	-16.2	1.40 V	354	35.8	2.0

REMARKS:

1. Emission Level(dBuV/m) = Raw Value(dBuV) + Correction Factor(dB/m)
2. Correction Factor(dB/m) = Antenna Factor(dB/m) + Cable Factor(dB) – Pre-Amplifier Factor(dB)
3. Margin value = Emission Level – Limit value
4. The other emission levels were very low against the limit.
5. " * ": Fundamental frequency.

CHANNEL	TX Channel 6	DETECTOR FUNCTION	Peak (PK)
FREQUENCY RANGE	1GHz ~ 25GHz		Average (AV)

ANTENNA POLARITY & TEST DISTANCE: HORIZONTAL AT 3 M

NO.	FREQ. (MHz)	EMISSION LEVEL (dBuV/m)	LIMIT (dBuV/m)	MARGIN (dB)	ANTENNA HEIGHT (m)	TABLE ANGLE (Degree)	RAW VALUE (dBuV)	CORRECTION FACTOR (dB/m)
1	2390.00	56.5 PK	74.0	-17.5	2.26 H	14	25.3	31.2
2	2390.00	46.4 AV	54.0	-7.6	2.26 H	14	15.2	31.2
3	*2437.00	110.3 PK			2.04 H	211	79.2	31.1
4	*2437.00	106.4 AV			2.04 H	211	75.3	31.1
5	4874.00	46.1 PK	74.0	-27.9	2.16 H	349	44.2	1.9
6	4874.00	41.5 AV	54.0	-12.5	2.16 H	349	39.6	1.9

ANTENNA POLARITY & TEST DISTANCE: VERTICAL AT 3 M

NO.	FREQ. (MHz)	EMISSION LEVEL (dBuV/m)	LIMIT (dBuV/m)	MARGIN (dB)	ANTENNA HEIGHT (m)	TABLE ANGLE (Degree)	RAW VALUE (dBuV)	CORRECTION FACTOR (dB/m)
1	2390.00	61.0 PK	74.0	-13.0	1.88 V	340	29.8	31.2
2	2390.00	53.2 AV	54.0	-0.8	1.88 V	340	22.0	31.2
3	*2437.00	121.7 PK			1.89 V	357	90.6	31.1
4	*2437.00	117.7 AV			1.89 V	357	86.6	31.1
5	4874.00	48.0 PK	74.0	-26.0	2.37 V	27	46.1	1.9
6	4874.00	43.6 AV	54.0	-10.4	2.37 V	27	41.7	1.9

REMARKS:

1. Emission Level(dBuV/m) = Raw Value(dBuV) + Correction Factor(dB/m)
2. Correction Factor(dB/m) = Antenna Factor(dB/m) + Cable Factor(dB) – Pre-Amplifier Factor(dB)
3. Margin value = Emission Level – Limit value
4. The other emission levels were very low against the limit.
5. " * ": Fundamental frequency.

CHANNEL	TX Channel 11	DETECTOR FUNCTION	Peak (PK)
FREQUENCY RANGE	1GHz ~ 25GHz		Average (AV)

ANTENNA POLARITY & TEST DISTANCE: HORIZONTAL AT 3 M

NO.	FREQ. (MHz)	EMISSION LEVEL (dBuV/m)	LIMIT (dBuV/m)	MARGIN (dB)	ANTENNA HEIGHT (m)	TABLE ANGLE (Degree)	RAW VALUE (dBuV)	CORRECTION FACTOR (dB/m)
1	*2462.00	110.2 PK			2.03 H	215	79.1	31.1
2	*2462.00	106.3 AV			2.03 H	215	75.2	31.1
3	2483.50	56.1 PK	74.0	-17.9	2.26 H	187	24.9	31.2
4	2483.50	46.4 AV	54.0	-7.6	2.26 H	187	15.2	31.2
5	4924.00	44.8 PK	74.0	-29.2	1.97 H	336	43.4	1.4
6	4924.00	36.6 AV	54.0	-17.4	1.97 H	336	35.2	1.4

ANTENNA POLARITY & TEST DISTANCE: VERTICAL AT 3 M

NO.	FREQ. (MHz)	EMISSION LEVEL (dBuV/m)	LIMIT (dBuV/m)	MARGIN (dB)	ANTENNA HEIGHT (m)	TABLE ANGLE (Degree)	RAW VALUE (dBuV)	CORRECTION FACTOR (dB/m)
1	*2462.00	121.4 PK			1.78 V	341	90.3	31.1
2	*2462.00	117.4 AV			1.78 V	341	86.3	31.1
3	2483.50	63.1 PK	74.0	-10.9	2.02 V	340	31.9	31.2
4	2483.50	53.1 AV	54.0	-0.9	2.02 V	340	21.9	31.2
5	4924.00	46.0 PK	74.0	-28.0	1.53 V	349	44.6	1.4
6	4924.00	39.0 AV	54.0	-15.0	1.53 V	349	37.6	1.4

REMARKS:

1. Emission Level(dBuV/m) = Raw Value(dBuV) + Correction Factor(dB/m)
2. Correction Factor(dB/m) = Antenna Factor(dB/m) + Cable Factor(dB) – Pre-Amplifier Factor(dB)
3. Margin value = Emission Level – Limit value
4. The other emission levels were very low against the limit.
5. " * ": Fundamental frequency.

802.11g

CHANNEL	TX Channel 1	DETECTOR FUNCTION	Peak (PK)
FREQUENCY RANGE	1GHz ~ 25GHz		Average (AV)

ANTENNA POLARITY & TEST DISTANCE: HORIZONTAL AT 3 M								
NO.	FREQ. (MHz)	EMISSION LEVEL (dBuV/m)	LIMIT (dBuV/m)	MARGIN (dB)	ANTENNA HEIGHT (m)	TABLE ANGLE (Degree)	RAW VALUE (dBuV)	CORRECTION FACTOR (dB/m)
1	2390.00	62.8 PK	74.0	-11.2	2.07 H	208	31.6	31.2
2	2390.00	48.7 AV	54.0	-5.3	2.07 H	208	17.5	31.2
3	*2412.00	102.9 PK			1.90 H	210	71.8	31.1
4	*2412.00	92.0 AV			1.90 H	210	60.9	31.1
5	4824.00	42.8 PK	74.0	-31.2	2.01 H	351	40.8	2.0
6	4824.00	31.9 AV	54.0	-22.1	2.01 H	351	29.9	2.0

ANTENNA POLARITY & TEST DISTANCE: VERTICAL AT 3 M								
NO.	FREQ. (MHz)	EMISSION LEVEL (dBuV/m)	LIMIT (dBuV/m)	MARGIN (dB)	ANTENNA HEIGHT (m)	TABLE ANGLE (Degree)	RAW VALUE (dBuV)	CORRECTION FACTOR (dB/m)
1	2390.00	69.2 PK	74.0	-4.8	1.78 V	6	38.0	31.2
2	2390.00	52.6 AV	54.0	-1.4	1.78 V	6	21.4	31.2
3	*2412.00	114.4 PK			2.14 V	343	83.3	31.1
4	*2412.00	103.5 AV			2.14 V	343	72.4	31.1
5	4824.00	44.1 PK	74.0	-29.9	2.97 V	21	42.1	2.0
6	4824.00	33.4 AV	54.0	-20.6	2.97 V	21	31.4	2.0

REMARKS:

1. Emission Level(dBuV/m) = Raw Value(dBuV) + Correction Factor(dB/m)
2. Correction Factor(dB/m) = Antenna Factor(dB/m) + Cable Factor(dB) – Pre-Amplifier Factor(dB)
3. Margin value = Emission Level – Limit value
4. The other emission levels were very low against the limit.
5. " * ": Fundamental frequency.

CHANNEL	TX Channel 6	DETECTOR FUNCTION	Peak (PK)
FREQUENCY RANGE	1GHz ~ 25GHz		Average (AV)

ANTENNA POLARITY & TEST DISTANCE: HORIZONTAL AT 3 M

NO.	FREQ. (MHz)	EMISSION LEVEL (dBuV/m)	LIMIT (dBuV/m)	MARGIN (dB)	ANTENNA HEIGHT (m)	TABLE ANGLE (Degree)	RAW VALUE (dBuV)	CORRECTION FACTOR (dB/m)
1	2390.00	61.4 PK	74.0	-12.6	1.98 H	208	30.2	31.2
2	2390.00	46.0 AV	54.0	-8.0	1.98 H	208	14.8	31.2
3	*2437.00	111.1 PK			2.05 H	216	80.0	31.1
4	*2437.00	100.8 AV			2.05 H	216	69.7	31.1
5	4874.00	43.0 PK	74.0	-31.0	2.11 H	350	41.1	1.9
6	4874.00	31.8 AV	54.0	-22.2	2.11 H	350	29.9	1.9

ANTENNA POLARITY & TEST DISTANCE: VERTICAL AT 3 M

NO.	FREQ. (MHz)	EMISSION LEVEL (dBuV/m)	LIMIT (dBuV/m)	MARGIN (dB)	ANTENNA HEIGHT (m)	TABLE ANGLE (Degree)	RAW VALUE (dBuV)	CORRECTION FACTOR (dB/m)
1	2390.00	68.8 PK	74.0	-5.2	1.81 V	6	37.6	31.2
2	2390.00	52.6 AV	54.0	-1.4	1.81 V	6	21.4	31.2
3	*2437.00	122.4 PK			2.09 V	347	91.3	31.1
4	*2437.00	112.2 AV			2.09 V	347	81.1	31.1
5	4874.00	43.8 PK	74.0	-30.2	3.06 V	27	41.9	1.9
6	4874.00	33.7 AV	54.0	-20.3	3.06 V	27	31.8	1.9

REMARKS:

1. Emission Level(dBuV/m) = Raw Value(dBuV) + Correction Factor(dB/m)
2. Correction Factor(dB/m) = Antenna Factor(dB/m) + Cable Factor(dB) – Pre-Amplifier Factor(dB)
3. Margin value = Emission Level – Limit value
4. The other emission levels were very low against the limit.
5. " * ": Fundamental frequency.

CHANNEL	TX Channel 11	DETECTOR FUNCTION	Peak (PK)
FREQUENCY RANGE	1GHz ~ 25GHz		Average (AV)

ANTENNA POLARITY & TEST DISTANCE: HORIZONTAL AT 3 M

NO.	FREQ. (MHz)	EMISSION LEVEL (dBuV/m)	LIMIT (dBuV/m)	MARGIN (dB)	ANTENNA HEIGHT (m)	TABLE ANGLE (Degree)	RAW VALUE (dBuV)	CORRECTION FACTOR (dB/m)
1	*2462.00	104.9 PK			1.94 H	208	73.8	31.1
2	*2462.00	94.7 AV			1.94 H	208	63.6	31.1
3	2483.50	54.7 PK	74.0	-19.3	1.98 H	211	23.5	31.2
4	2483.50	45.5 AV	54.0	-8.5	1.98 H	211	14.3	31.2
5	4924.00	42.7 PK	74.0	-31.3	2.01 H	343	40.8	1.9
6	4924.00	31.8 AV	54.0	-22.2	2.01 H	343	29.9	1.9

ANTENNA POLARITY & TEST DISTANCE: VERTICAL AT 3 M

NO.	FREQ. (MHz)	EMISSION LEVEL (dBuV/m)	LIMIT (dBuV/m)	MARGIN (dB)	ANTENNA HEIGHT (m)	TABLE ANGLE (Degree)	RAW VALUE (dBuV)	CORRECTION FACTOR (dB/m)
1	*2462.00	116.4 PK			1.98 V	350	85.3	31.1
2	*2462.00	106.2 AV			1.98 V	350	75.1	31.1
3	2483.50	66.5 PK	74.0	-7.5	2.10 V	356	35.3	31.2
4	2483.50	53.0 AV	54.0	-1.0	2.10 V	356	21.8	31.2
5	4924.00	43.7 PK	74.0	-30.3	2.97 V	25	41.8	1.9
6	4924.00	33.7 AV	54.0	-20.3	2.97 V	25	31.8	1.9

REMARKS:

1. Emission Level(dBuV/m) = Raw Value(dBuV) + Correction Factor(dB/m)
2. Correction Factor(dB/m) = Antenna Factor(dB/m) + Cable Factor(dB) – Pre-Amplifier Factor(dB)
3. Margin value = Emission Level – Limit value
4. The other emission levels were very low against the limit.
5. " * ": Fundamental frequency.

802.11n (HT20)

CHANNEL	TX Channel 1	DETECTOR FUNCTION	Peak (PK)
FREQUENCY RANGE	1GHz ~ 25GHz		Average (AV)

ANTENNA POLARITY & TEST DISTANCE: HORIZONTAL AT 3 M								
NO.	FREQ. (MHz)	EMISSION LEVEL (dBuV/m)	LIMIT (dBuV/m)	MARGIN (dB)	ANTENNA HEIGHT (m)	TABLE ANGLE (Degree)	RAW VALUE (dBuV)	CORRECTION FACTOR (dB/m)
1	2390.00	55.0 PK	74.0	-19.0	1.92 H	208	23.8	31.2
2	2390.00	45.8 AV	54.0	-8.2	1.92 H	208	14.6	31.2
3	*2412.00	101.2 PK			1.90 H	216	70.1	31.1
4	*2412.00	90.2 AV			1.90 H	216	59.1	31.1
5	4824.00	42.5 PK	74.0	-31.5	2.01 H	351	40.5	2.0
6	4824.00	30.9 AV	54.0	-23.1	2.01 H	351	28.9	2.0

ANTENNA POLARITY & TEST DISTANCE: VERTICAL AT 3 M								
NO.	FREQ. (MHz)	EMISSION LEVEL (dBuV/m)	LIMIT (dBuV/m)	MARGIN (dB)	ANTENNA HEIGHT (m)	TABLE ANGLE (Degree)	RAW VALUE (dBuV)	CORRECTION FACTOR (dB/m)
1	2390.00	67.8 PK	74.0	-6.2	2.06 V	330	36.6	31.2
2	2390.00	52.8 AV	54.0	-1.2	2.06 V	330	21.6	31.2
3	*2412.00	112.9 PK			2.04 V	343	81.8	31.1
4	*2412.00	101.8 AV			2.04 V	343	70.7	31.1
5	4824.00	43.3 PK	74.0	-30.7	3.06 V	28	41.3	2.0
6	4824.00	32.0 AV	54.0	-22.0	3.06 V	28	30.0	2.0

REMARKS:

1. Emission Level(dBuV/m) = Raw Value(dBuV) + Correction Factor(dB/m)
2. Correction Factor(dB/m) = Antenna Factor(dB/m) + Cable Factor(dB) – Pre-Amplifier Factor(dB)
3. Margin value = Emission Level – Limit value
4. The other emission levels were very low against the limit.
5. " * ": Fundamental frequency.

CHANNEL	TX Channel 6	DETECTOR FUNCTION	Peak (PK)
FREQUENCY RANGE	1GHz ~ 25GHz		Average (AV)

ANTENNA POLARITY & TEST DISTANCE: HORIZONTAL AT 3 M

NO.	FREQ. (MHz)	EMISSION LEVEL (dBuV/m)	LIMIT (dBuV/m)	MARGIN (dB)	ANTENNA HEIGHT (m)	TABLE ANGLE (Degree)	RAW VALUE (dBuV)	CORRECTION FACTOR (dB/m)
1	2390.00	55.7 PK	74.0	-18.3	1.89 H	212	24.5	31.2
2	2390.00	45.9 AV	54.0	-8.1	1.89 H	212	14.7	31.2
3	*2437.00	111.1 PK			2.03 H	213	80.0	31.1
4	*2437.00	100.7 AV			2.03 H	213	69.6	31.1
5	4874.00	42.5 PK	74.0	-31.5	3.03 H	338	40.6	1.9
6	4874.00	30.9 AV	54.0	-23.1	3.03 H	338	29.0	1.9

ANTENNA POLARITY & TEST DISTANCE: VERTICAL AT 3 M

NO.	FREQ. (MHz)	EMISSION LEVEL (dBuV/m)	LIMIT (dBuV/m)	MARGIN (dB)	ANTENNA HEIGHT (m)	TABLE ANGLE (Degree)	RAW VALUE (dBuV)	CORRECTION FACTOR (dB/m)
1	2390.00	71.2 PK	74.0	-2.8	1.86 V	13	40.0	31.2
2	2390.00	52.5 AV	54.0	-1.5	1.86 V	13	21.3	31.2
3	*2437.00	122.8 PK			2.07 V	345	91.7	31.1
4	*2437.00	112.3 AV			2.07 V	345	81.2	31.1
5	4874.00	43.4 PK	74.0	-30.6	3.05 V	25	41.5	1.9
6	4874.00	32.1 AV	54.0	-21.9	3.05 V	25	30.2	1.9

REMARKS:

1. Emission Level(dBuV/m) = Raw Value(dBuV) + Correction Factor(dB/m)
2. Correction Factor(dB/m) = Antenna Factor(dB/m) + Cable Factor(dB) – Pre-Amplifier Factor(dB)
3. Margin value = Emission Level – Limit value
4. The other emission levels were very low against the limit.
5. " * ": Fundamental frequency.

CHANNEL	TX Channel 11	DETECTOR FUNCTION	Peak (PK)
FREQUENCY RANGE	1GHz ~ 25GHz		Average (AV)

ANTENNA POLARITY & TEST DISTANCE: HORIZONTAL AT 3 M

NO.	FREQ. (MHz)	EMISSION LEVEL (dBuV/m)	LIMIT (dBuV/m)	MARGIN (dB)	ANTENNA HEIGHT (m)	TABLE ANGLE (Degree)	RAW VALUE (dBuV)	CORRECTION FACTOR (dB/m)
1	*2462.00	104.5 PK			1.94 H	212	73.4	31.1
2	*2462.00	93.5 AV			1.94 H	212	62.4	31.1
3	2483.50	54.7 PK	74.0	-19.3	2.00 H	209	23.5	31.2
4	2483.50	45.6 AV	54.0	-8.4	2.00 H	209	14.4	31.2
5	4924.00	43.3 PK	74.0	-30.7	1.98 H	342	41.4	1.9
6	4924.00	31.0 AV	54.0	-23.0	1.98 H	342	29.1	1.9

ANTENNA POLARITY & TEST DISTANCE: VERTICAL AT 3 M

NO.	FREQ. (MHz)	EMISSION LEVEL (dBuV/m)	LIMIT (dBuV/m)	MARGIN (dB)	ANTENNA HEIGHT (m)	TABLE ANGLE (Degree)	RAW VALUE (dBuV)	CORRECTION FACTOR (dB/m)
1	*2462.00	115.8 PK			2.06 V	345	84.7	31.1
2	*2462.00	104.9 AV			2.06 V	345	73.8	31.1
3	2483.50	66.9 PK	74.0	-7.1	2.00 V	345	35.7	31.2
4	2483.50	53.0 AV	54.0	-1.0	2.00 V	345	21.8	31.2
5	4924.00	43.2 PK	74.0	-30.8	2.94 V	23	41.3	1.9
6	4924.00	32.1 AV	54.0	-21.9	2.94 V	23	30.2	1.9

REMARKS:

1. Emission Level(dBuV/m) = Raw Value(dBuV) + Correction Factor(dB/m)
2. Correction Factor(dB/m) = Antenna Factor(dB/m) + Cable Factor(dB) – Pre-Amplifier Factor(dB)
3. Margin value = Emission Level – Limit value
4. The other emission levels were very low against the limit.
5. " * ": Fundamental frequency.

802.11n (HT40)

CHANNEL	TX Channel 3	DETECTOR FUNCTION	Peak (PK)
FREQUENCY RANGE	1GHz ~ 25GHz		Average (AV)

ANTENNA POLARITY & TEST DISTANCE: HORIZONTAL AT 3 M								
NO.	FREQ. (MHz)	EMISSION LEVEL (dBuV/m)	LIMIT (dBuV/m)	MARGIN (dB)	ANTENNA HEIGHT (m)	TABLE ANGLE (Degree)	RAW VALUE (dBuV)	CORRECTION FACTOR (dB/m)
1	2390.00	55.4 PK	74.0	-18.6	1.90 H	211	24.2	31.2
2	2390.00	45.9 AV	54.0	-8.1	1.90 H	211	14.7	31.2
3	*2422.00	93.6 PK			2.04 H	208	62.5	31.1
4	*2422.00	84.6 AV			2.04 H	208	53.5	31.1
5	4844.00	42.9 PK	74.0	-31.1	2.04 H	338	41.0	1.9
6	4844.00	28.9 AV	54.0	-25.1	2.04 H	338	27.0	1.9

ANTENNA POLARITY & TEST DISTANCE: VERTICAL AT 3 M								
NO.	FREQ. (MHz)	EMISSION LEVEL (dBuV/m)	LIMIT (dBuV/m)	MARGIN (dB)	ANTENNA HEIGHT (m)	TABLE ANGLE (Degree)	RAW VALUE (dBuV)	CORRECTION FACTOR (dB/m)
1	2390.00	66.0 PK	74.0	-8.0	1.82 V	1	34.8	31.2
2	2390.00	52.8 AV	54.0	-1.2	1.82 V	1	21.6	31.2
3	*2422.00	105.1 PK			2.26 V	344	74.0	31.1
4	*2422.00	96.1 AV			2.26 V	344	65.0	31.1
5	4844.00	43.4 PK	74.0	-30.6	2.93 V	16	41.5	1.9
6	4844.00	28.8 AV	54.0	-25.2	2.93 V	16	26.9	1.9

REMARKS:

1. Emission Level(dBuV/m) = Raw Value(dBuV) + Correction Factor(dB/m)
2. Correction Factor(dB/m) = Antenna Factor(dB/m) + Cable Factor(dB) – Pre-Amplifier Factor(dB)
3. Margin value = Emission Level – Limit value
4. The other emission levels were very low against the limit.
5. " * ": Fundamental frequency.

CHANNEL	TX Channel 6	DETECTOR FUNCTION	Peak (PK)
FREQUENCY RANGE	1GHz ~ 25GHz		Average (AV)

ANTENNA POLARITY & TEST DISTANCE: HORIZONTAL AT 3 M

NO.	FREQ. (MHz)	EMISSION LEVEL (dBuV/m)	LIMIT (dBuV/m)	MARGIN (dB)	ANTENNA HEIGHT (m)	TABLE ANGLE (Degree)	RAW VALUE (dBuV)	CORRECTION FACTOR (dB/m)
1	*2437.00	100.7 PK			2.05 H	212	69.6	31.1
2	*2437.00	91.9 AV			2.05 H	212	60.8	31.1
3	2483.50	55.7 PK	74.0	-18.3	1.97 H	212	24.5	31.2
4	2483.50	45.5 AV	54.0	-8.5	1.97 H	212	14.3	31.2
5	4874.00	42.8 PK	74.0	-31.2	2.02 H	343	40.9	1.9
6	4874.00	29.2 AV	54.0	-24.8	2.02 H	343	27.3	1.9

ANTENNA POLARITY & TEST DISTANCE: VERTICAL AT 3 M

NO.	FREQ. (MHz)	EMISSION LEVEL (dBuV/m)	LIMIT (dBuV/m)	MARGIN (dB)	ANTENNA HEIGHT (m)	TABLE ANGLE (Degree)	RAW VALUE (dBuV)	CORRECTION FACTOR (dB/m)
1	*2437.00	112.4 PK			1.71 V	346	81.3	31.1
2	*2437.00	103.5 AV			1.71 V	346	72.4	31.1
3	2483.50	67.9 PK	74.0	-6.1	2.05 V	354	36.7	31.2
4	2483.50	52.9 AV	54.0	-1.1	2.05 V	354	21.7	31.2
5	4874.00	43.4 PK	74.0	-30.6	3.02 V	21	41.5	1.9
6	4874.00	28.8 AV	54.0	-25.2	3.02 V	21	26.9	1.9

REMARKS:

1. Emission Level(dBuV/m) = Raw Value(dBuV) + Correction Factor(dB/m)
2. Correction Factor(dB/m) = Antenna Factor(dB/m) + Cable Factor(dB) – Pre-Amplifier Factor(dB)
3. Margin value = Emission Level – Limit value
4. The other emission levels were very low against the limit.
5. " * ": Fundamental frequency.

CHANNEL	TX Channel 9	DETECTOR FUNCTION	Peak (PK)
FREQUENCY RANGE	1GHz ~ 25GHz		Average (AV)

ANTENNA POLARITY & TEST DISTANCE: HORIZONTAL AT 3 M

NO.	FREQ. (MHz)	EMISSION LEVEL (dBuV/m)	LIMIT (dBuV/m)	MARGIN (dB)	ANTENNA HEIGHT (m)	TABLE ANGLE (Degree)	RAW VALUE (dBuV)	CORRECTION FACTOR (dB/m)
1	*2452.00	98.5 PK			1.97 H	209	67.4	31.1
2	*2452.00	89.4 AV			1.97 H	209	58.3	31.1
3	2483.50	56.0 PK	74.0	-18.0	2.07 H	212	24.8	31.2
4	2483.50	45.8 AV	54.0	-8.2	2.07 H	212	14.6	31.2
5	4904.00	42.8 PK	74.0	-31.2	2.11 H	342	41.0	1.8
6	4904.00	28.9 AV	54.0	-25.1	2.11 H	342	27.1	1.8

ANTENNA POLARITY & TEST DISTANCE: VERTICAL AT 3 M

NO.	FREQ. (MHz)	EMISSION LEVEL (dBuV/m)	LIMIT (dBuV/m)	MARGIN (dB)	ANTENNA HEIGHT (m)	TABLE ANGLE (Degree)	RAW VALUE (dBuV)	CORRECTION FACTOR (dB/m)
1	*2452.00	109.8 PK			1.87 V	343	78.7	31.1
2	*2452.00	100.8 AV			1.87 V	343	69.7	31.1
3	2483.50	66.4 PK	74.0	-7.6	2.00 V	15	35.2	31.2
4	2483.50	53.0 AV	54.0	-1.0	2.00 V	15	21.8	31.2
5	4904.00	43.2 PK	74.0	-30.8	2.93 V	30	41.4	1.8
6	4904.00	29.0 AV	54.0	-25.0	2.93 V	30	27.2	1.8

REMARKS:

1. Emission Level(dBuV/m) = Raw Value(dBuV) + Correction Factor(dB/m)
2. Correction Factor(dB/m) = Antenna Factor(dB/m) + Cable Factor(dB) – Pre-Amplifier Factor(dB)
3. Margin value = Emission Level – Limit value
4. The other emission levels were very low against the limit.
5. " * ": Fundamental frequency.

9 kHz ~ 30 MHz Data:

The amplitude of spurious emissions attenuated more than 20 dB below the permissible value is not required to be report.

30 MHz ~ 1 GHz Worst-Case Data:

802.11b

Mode A

CHANNEL	TX Channel 6	DETECTOR FUNCTION	Quasi-Peak (QP)
FREQUENCY RANGE	30MHz ~ 1GHz		

ANTENNA POLARITY & TEST DISTANCE: HORIZONTAL AT 3 M								
NO.	FREQ. (MHz)	EMISSION LEVEL (dBuV/m)	LIMIT (dBuV/m)	MARGIN (dB)	ANTENNA HEIGHT (m)	TABLE ANGLE (Degree)	RAW VALUE (dBuV)	CORRECTION FACTOR (dB/m)
1	44.55	34.7 QP	40.0	-5.3	1.00 H	310	44.7	-10.0
2	62.01	38.0 QP	40.0	-2.0	1.00 H	17	48.5	-10.5
3	63.95	35.5 QP	40.0	-4.5	1.00 H	17	46.0	-10.5
4	89.17	23.7 QP	43.5	-19.8	1.00 H	112	38.6	-14.9
5	165.80	28.9 QP	43.5	-14.6	1.00 H	207	38.1	-9.2
6	223.03	21.2 QP	46.0	-24.8	1.00 H	285	33.2	-12.0

REMARKS:

1. Emission Level(dBuV/m) = Raw Value(dBuV) + Correction Factor(dB/m)
2. Correction Factor(dB/m) = Antenna Factor(dB/m) + Cable Factor(dB) – Pre-Amplifier Factor(dB)
3. Margin value = Emission Level – Limit value
4. The other emission levels were very low against the limit of frequency range 30MHz~1000MHz.
5. The emission levels were very low against the limit of frequency range 9kHz~30MHz: the amplitude of spurious emissions attenuated more than 20 dB below the permissible value to be report.

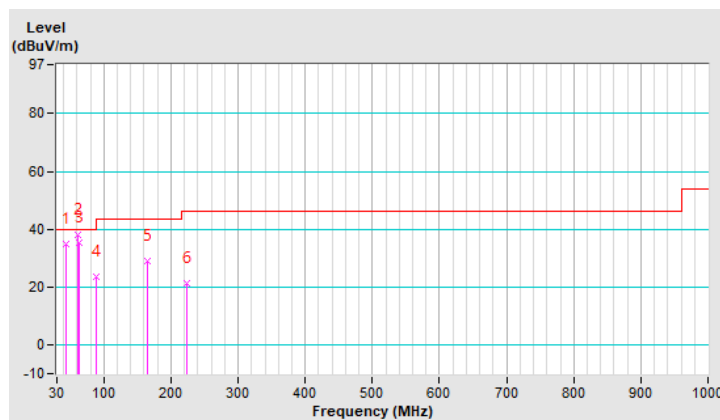

CHANNEL	TX Channel 6	DETECTOR FUNCTION	Quasi-Peak (QP)
FREQUENCY RANGE	30MHz ~ 1GHz		

ANTENNA POLARITY & TEST DISTANCE: VERTICAL AT 3 M

NO.	FREQ. (MHz)	EMISSION LEVEL (dBuV/m)	LIMIT (dBuV/m)	MARGIN (dB)	ANTENNA HEIGHT (m)	TABLE ANGLE (Degree)	RAW VALUE (dBuV)	CORRECTION FACTOR (dB/m)
1	62.01	37.8 QP	40.0	-2.2	1.00 V	48	48.3	-10.5
2	107.60	24.8 QP	43.5	-18.7	1.00 V	68	37.4	-12.6
3	165.80	28.4 QP	43.5	-15.1	1.00 V	177	37.6	-9.2
4	233.70	19.5 QP	46.0	-26.5	1.00 V	145	30.6	-11.1
5	323.91	25.0 QP	46.0	-21.0	1.00 V	335	32.5	-7.5
6	435.46	33.9 QP	46.0	-12.1	1.00 V	6	38.6	-4.7

REMARKS:

1. Emission Level(dBuV/m) = Raw Value(dBuV) + Correction Factor(dB/m)
2. Correction Factor(dB/m) = Antenna Factor(dB/m) + Cable Factor(dB) – Pre-Amplifier Factor(dB)
3. Margin value = Emission Level – Limit value
4. The other emission levels were very low against the limit of frequency range 30MHz~1000MHz.
5. The emission levels were very low against the limit of frequency range 9kHz~30MHz: the amplitude of spurious emissions attenuated more than 20 dB below the permissible value to be report.

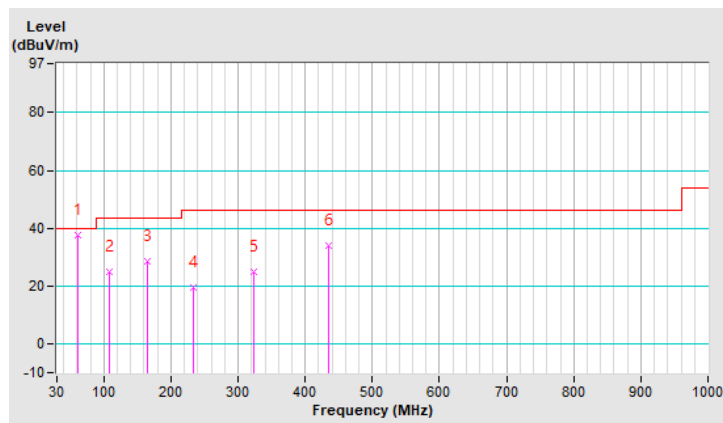

Mode B

CHANNEL	TX Channel 6	DETECTOR FUNCTION	Quasi-Peak (QP)
FREQUENCY RANGE	30MHz ~ 1GHz		

ANTENNA POLARITY & TEST DISTANCE: HORIZONTAL AT 3 M								
NO.	FREQ. (MHz)	EMISSION LEVEL (dBuV/m)	LIMIT (dBuV/m)	MARGIN (dB)	ANTENNA HEIGHT (m)	TABLE ANGLE (Degree)	RAW VALUE (dBuV)	CORRECTION FACTOR (dB/m)
1	43.55	33.6 QP	40.0	-6.4	1.00 H	310	43.7	-10.1
2	166.80	28.8 QP	43.5	-14.7	2.00 H	207	38.1	-9.3
3	710.88	39.3 QP	46.0	-6.7	1.00 H	249	39.7	-0.4
4	800.18	35.1 QP	46.0	-10.9	1.00 H	189	33.6	1.5
5	911.79	38.6 QP	46.0	-7.4	1.50 H	293	34.8	3.8
6	999.06	35.0 QP	54.0	-19.0	1.00 H	106	30.0	5.0

REMARKS:

1. Emission Level(dBuV/m) = Raw Value(dBuV) + Correction Factor(dB/m)
2. Correction Factor(dB/m) = Antenna Factor(dB/m) + Cable Factor(dB) – Pre-Amplifier Factor(dB)
3. Margin value = Emission Level – Limit value
4. The other emission levels were very low against the limit of frequency range 30MHz~1000MHz.
5. The emission levels were very low against the limit of frequency range 9kHz~30MHz: the amplitude of spurious emissions attenuated more than 20 dB below the permissible value to be report.

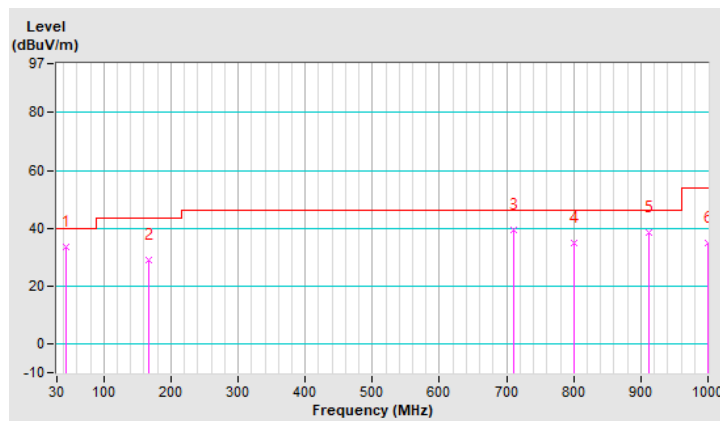

CHANNEL	TX Channel 6	DETECTOR FUNCTION	Quasi-Peak (QP)
FREQUENCY RANGE	30MHz ~ 1GHz		

ANTENNA POLARITY & TEST DISTANCE: VERTICAL AT 3 M

NO.	FREQ. (MHz)	EMISSION LEVEL (dBuV/m)	LIMIT (dBuV/m)	MARGIN (dB)	ANTENNA HEIGHT (m)	TABLE ANGLE (Degree)	RAW VALUE (dBuV)	CORRECTION FACTOR (dB/m)
1	58.13	35.8 QP	40.0	-4.2	1.00 V	17	45.9	-10.1
2	165.80	28.4 QP	43.5	-15.1	1.00 V	177	37.6	-9.2
3	435.46	33.9 QP	46.0	-12.1	1.00 V	6	38.6	-4.7
4	730.34	39.0 QP	46.0	-7.0	2.00 V	279	39.0	0.0
5	908.82	33.6 QP	46.0	-12.4	1.00 V	325	29.8	3.8
6	1000.00	36.9 QP	54.0	-17.1	1.50 V	195	31.9	5.0

REMARKS:

1. Emission Level(dBuV/m) = Raw Value(dBuV) + Correction Factor(dB/m)
2. Correction Factor(dB/m) = Antenna Factor(dB/m) + Cable Factor(dB) – Pre-Amplifier Factor(dB)
3. Margin value = Emission Level – Limit value
4. The other emission levels were very low against the limit of frequency range 30MHz~1000MHz.
5. The emission levels were very low against the limit of frequency range 9kHz~30MHz: the amplitude of spurious emissions attenuated more than 20 dB below the permissible value to be report.

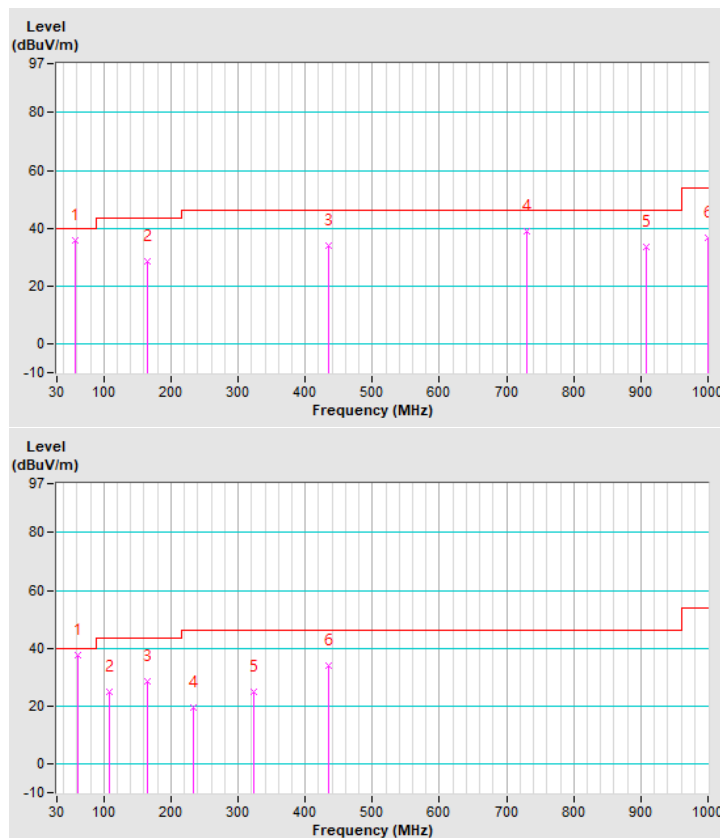

4.2 Conducted Emission Measurement

4.2.1 Limits of Conducted Emission Measurement

Frequency (MHz)	Conducted Limit (dBuV)	
	Quasi-Peak	Average
0.15 - 0.5	66 - 56	56 - 46
0.50 - 5.0	56	46
5.0 - 30.0	60	50

- Note: 1. The lower limit shall apply at the transition frequencies.
 2. The limit decreases in line with the logarithm of the frequency in the range of 0.15 to 0.50 MHz.

4.2.2 Test Instruments

Description & Manufacturer	Model No.	Serial No.	Date of Calibration	Due Date of Calibration
Test Receiver ROHDE & SCHWARZ	ESCI	100613	Dec. 11, 2019	Dec. 10, 2020
RF signal cable (with 10dB PAD) Woken	5D-FB	Cable-cond1-01	Sep. 05, 2019	Sep. 04, 2020
LISN ROHDE & SCHWARZ (EUT)	ENV216	101826	Mar. 06, 2019	Mar. 05, 2020
LISN ROHDE & SCHWARZ (Peripheral)	ESH3-Z5	100311	Aug. 22, 2019	Aug. 21, 2020
Software ADT	BV ADT_Cond_ V7.3.7.4	NA	NA	NA

- Note: 1. The calibration interval of the above test instruments is 12 months and the calibrations are traceable to NML/ROC and NIST/USA.
 2. The test was performed in HwaYa Shielded Room 1.
 3. The VCCI Site Registration No. is C-12040.

4.2.3 Test Procedures

- a. The EUT was placed 0.4 meters from the conducting wall of the shielded room with EUT being connected to the power mains through a line impedance stabilization network (LISN). Other support units were connected to the power mains through another LISN. The two LISNs provide 50 ohm/50 uH of coupling impedance for the measuring instrument.
- b. Both lines of the power mains connected to the EUT were checked for maximum conducted interference.
- c. The frequency range from 150 kHz to 30 MHz was searched. Emission levels under (Limit – 20 dB) was not recorded.

Note: The resolution bandwidth and video bandwidth of test receiver is 9 kHz for quasi-peak detection (QP) and average detection (AV) at frequency 0.15 MHz – 30 MHz.

4.2.4 Deviation from Test Standard

No deviation.

4.2.5 Test Setup

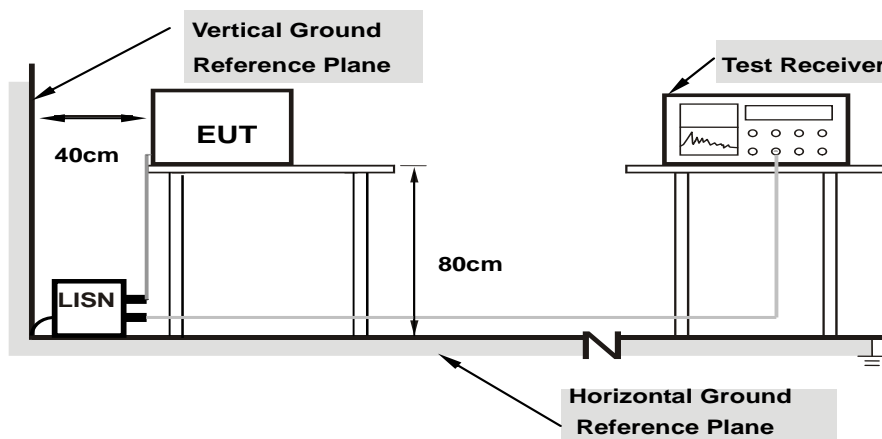

Note: 1.Support units were connected to second LISN.

For the actual test configuration, please refer to the attached file (Test Setup Photo).

4.2.6 EUT Operating Conditions

- a. Placed the EUT on a testing table.
- b. Use the software to control the EUT under transmission condition continuously at specific channel frequency.

4.2.7 Test Results

Frequency Range	150kHz ~ 30MHz	Detector Function & Resolution Bandwidth	Quasi-Peak (QP) / Average (AV), 9kHz
Input Power	120Vac, 60Hz	Environmental Conditions	25°C, 75%RH
Tested by	Jones Chang	Test Date	2020/2/10

Phase Of Power : Line (L)										
No	Frequency (MHz)	Correction Factor (dB)	Reading Value (dBuV)		Emission Level (dBuV)		Limit (dBuV)		Margin (dB)	
			Q.P.	AV.	Q.P.	AV.	Q.P.	AV.	Q.P.	AV.
1	0.17800	9.66	44.34	32.34	54.00	42.00	64.58	54.58	-10.58	-12.58
2	0.19780	9.66	23.23	1.00	32.89	10.66	63.70	53.70	-30.81	-43.04
3	0.41000	9.69	29.03	17.22	38.72	26.91	57.65	47.65	-18.93	-20.74
4	0.64600	9.71	22.50	11.25	32.21	20.96	56.00	46.00	-23.79	-25.04
5	2.57400	9.80	22.14	9.24	31.94	19.04	56.00	46.00	-24.06	-26.96
6	29.72200	10.01	16.43	10.25	26.44	20.26	60.00	50.00	-33.56	-29.74

Remarks:

1. Q.P. and AV. are abbreviations of quasi-peak and average individually.
2. The emission levels of other frequencies were very low against the limit.
3. Margin value = Emission level – Limit value
4. Correction factor = Insertion loss + Cable loss
5. Emission Level = Correction Factor + Reading Value

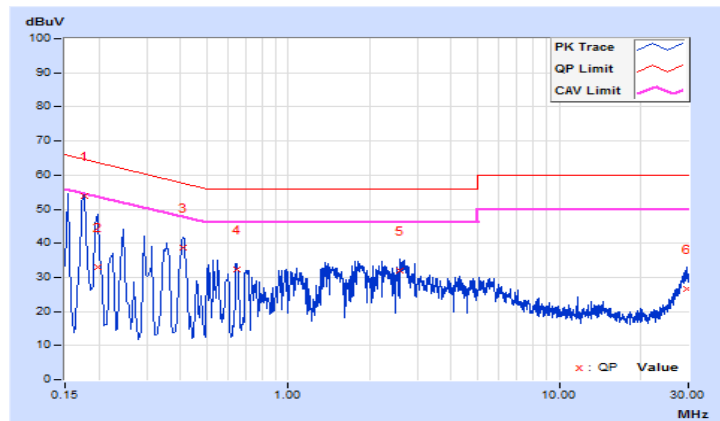

Frequency Range	150kHz ~ 30MHz	Detector Function & Resolution Bandwidth	Quasi-Peak (QP) / Average (AV), 9kHz
Input Power	120Vac, 60Hz	Environmental Conditions	25°C, 75%RH
Tested by	Jones Chang	Test Date	2020/2/10

Phase Of Power : Neutral (N)										
No	Frequency (MHz)	Correction Factor (dB)	Reading Value (dBuV)		Emission Level (dBuV)		Limit (dBuV)		Margin (dB)	
			Q.P.	AV.	Q.P.	AV.	Q.P.	AV.	Q.P.	AV.
1	0.17800	9.64	44.29	32.69	53.93	42.33	64.58	54.58	-10.65	-12.25
2	0.24200	9.64	36.63	21.78	46.27	31.42	62.03	52.03	-15.76	-20.61
3	0.35782	9.66	29.26	19.38	38.92	29.04	58.78	48.78	-19.86	-19.74
4	0.64200	9.68	23.42	12.06	33.10	21.74	56.00	46.00	-22.90	-24.26
5	0.97000	9.70	23.98	12.31	33.68	22.01	56.00	46.00	-22.32	-23.99
6	3.50200	9.80	22.34	10.32	32.14	20.12	56.00	46.00	-23.86	-25.88

Remarks:

1. Q.P. and AV. are abbreviations of quasi-peak and average individually.
2. The emission levels of other frequencies were very low against the limit.
3. Margin value = Emission level – Limit value
4. Correction factor = Insertion loss + Cable loss
5. Emission Level = Correction Factor + Reading Value

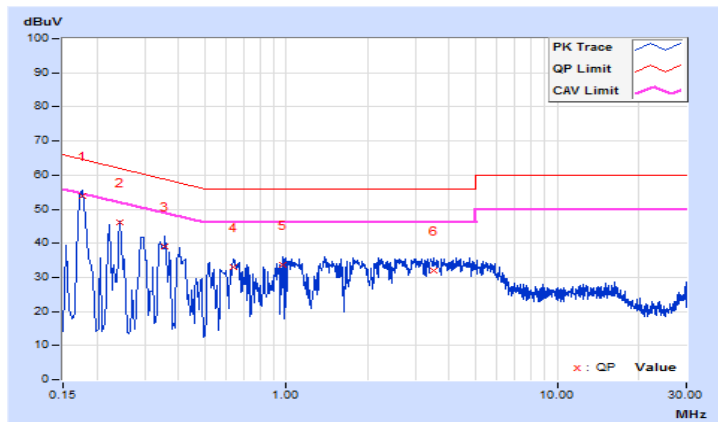

4.3 6 dB Bandwidth Measurement

4.3.1 Limits of 6 dB Bandwidth Measurement

The minimum of 6 dB Bandwidth Measurement is 0.5 MHz.

4.3.2 Test Setup

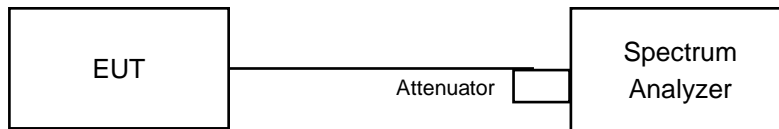

4.3.3 Test Instruments

Refer to section 4.1.2 to get information of above instrument.

4.3.4 Test Procedure

- Set resolution bandwidth (RBW) = 100 kHz
- Set the video bandwidth (VBW) $\geq 3 \times$ RBW, Detector = Peak.
- Trace mode = max hold.
- Sweep = auto couple.
- Measure the maximum width of the emission that is constrained by the frequencies associated with the two amplitude points (upper and lower) that are attenuated by 6 dB relative to the maximum level measured in the fundamental emission

4.3.5 Deviation from Test Standard

No deviation.

4.3.6 EUT Operating Conditions

The software provided by client to enable the EUT under transmission condition continuously at lowest, middle and highest channel frequencies individually.

4.3.7 Test Results

802.11b

Channel	Frequency (MHz)	6 dB Bandwidth (MHz)		Minimum Limit (MHz)	Pass / Fail
		Chain 0	Chain 1		
1	2412	8.11	7.60	0.5	Pass
6	2437	8.14	8.14	0.5	Pass
11	2462	8.13	8.12	0.5	Pass

802.11g

Channel	Frequency (MHz)	6 dB Bandwidth (MHz)		Minimum Limit (MHz)	Pass / Fail
		Chain 0	Chain 1		
1	2412	16.40	16.42	0.5	Pass
6	2437	16.34	16.37	0.5	Pass
11	2462	16.40	16.41	0.5	Pass

802.11n (HT20)

Channel	Frequency (MHz)	6 dB Bandwidth (MHz)		Minimum Limit (MHz)	Pass / Fail
		Chain 0	Chain 1		
1	2412	17.61	17.64	0.5	Pass
6	2437	17.59	17.58	0.5	Pass
11	2462	17.60	17.62	0.5	Pass

802.11n (HT40)

		Chain 0	Chain 1		
3	2422	35.25	35.30	0.5	Pass
6	2437	35.32	35.34	0.5	Pass
9	2452	35.31	35.18	0.5	Pass

Spectrum Plot of Worst Value

802.11b

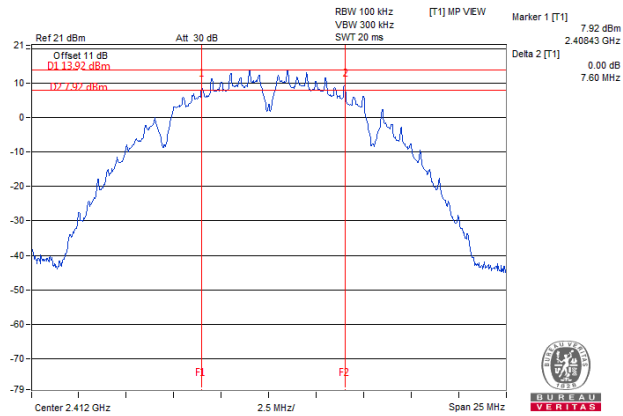

802.11g

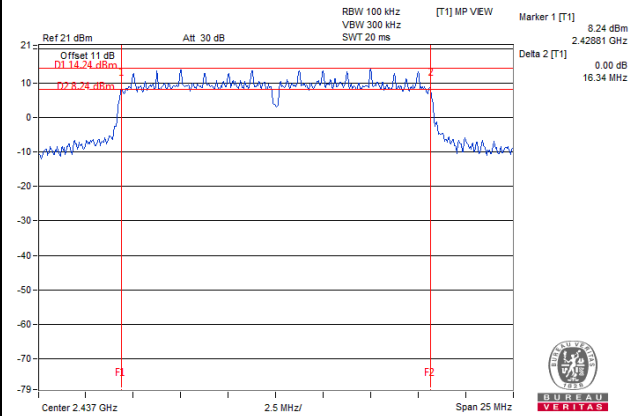

802.11n (HT20)

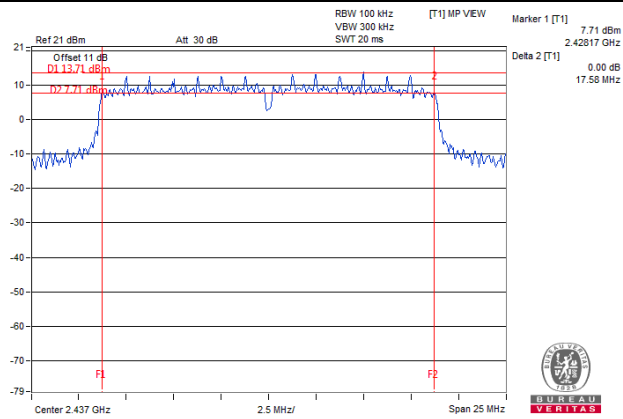

802.11n (HT40)

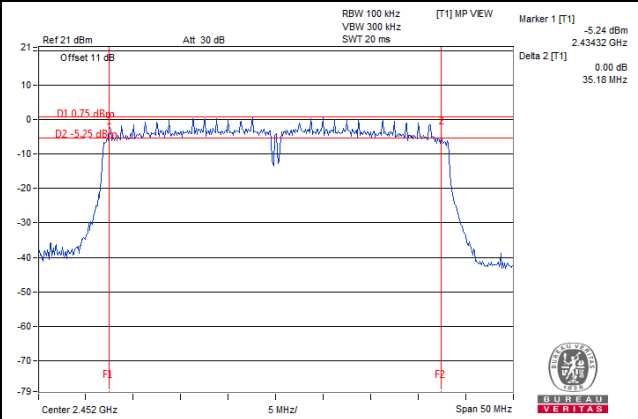

4.4 Occupied Bandwidth Measurement

4.4.1 Test Setup

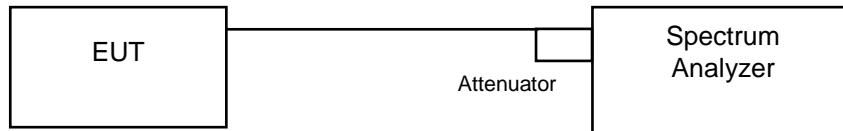

4.4.2 Test Instruments

Refer to section 4.1.2 to get information of above instrument.

4.4.3 Test Procedure

The transmitter output was connected to the spectrum analyzer through an attenuator. The bandwidth of the fundamental frequency was measured by spectrum analyzer with resolution bandwidth in the range of 1 % to 5 % of the anticipated emission bandwidth, and a video bandwidth at least 3x the resolution bandwidth and set the detector to sampling. The width of a frequency band such that, below the lower and above the upper frequency limits, the mean powers emitted are each equal to a specified percentage 0.5 % of the total mean power of a given emission.

4.4.4 Deviation from Test Standard

No deviation.

4.4.5 EUT Operating Conditions

The software provided by client to enable the EUT under transmission condition continuously at lowest, middle and highest channel frequencies individually.

4.4.6 Test Results

802.11b

Channel	Frequency (MHz)	Occupied Bandwidth (MHz)		Pass / Fail
		Chain 0	Chain 1	
1	2412	13.04	12.86	Pass
6	2437	14.28	14.04	Pass
11	2462	13.32	13.08	Pass

802.11g

Channel	Frequency (MHz)	Occupied Bandwidth (MHz)		Pass / Fail
		Chain 0	Chain 1	
1	2412	16.44	16.44	Pass
6	2437	21.24	19.32	Pass
11	2462	16.44	16.44	Pass

802.11n (HT20)

Channel	Frequency (MHz)	Occupied Bandwidth (MHz)		Pass / Fail
		Chain 0	Chain 1	
1	2412	17.64	17.64	Pass
6	2437	19.68	18.24	Pass
11	2462	17.64	17.64	Pass

802.11n (HT40)

Channel	Frequency (MHz)	Occupied Bandwidth (MHz)		Pass / Fail
		Chain 0	Chain 1	
3	2422	36.00	36.00	Pass
6	2437	36.00	36.00	Pass
9	2452	36.00	36.00	Pass

Spectrum Plot of Worst Value

802.11b

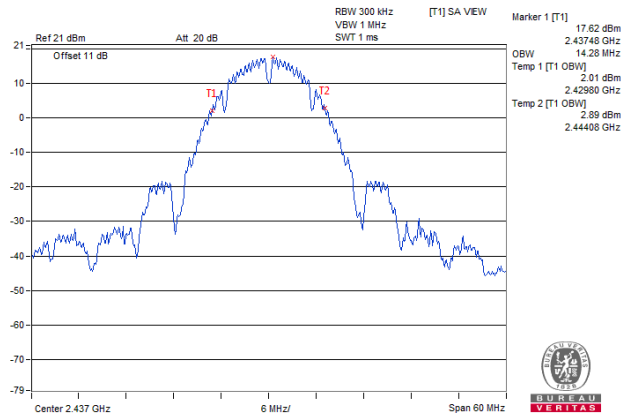

802.11g

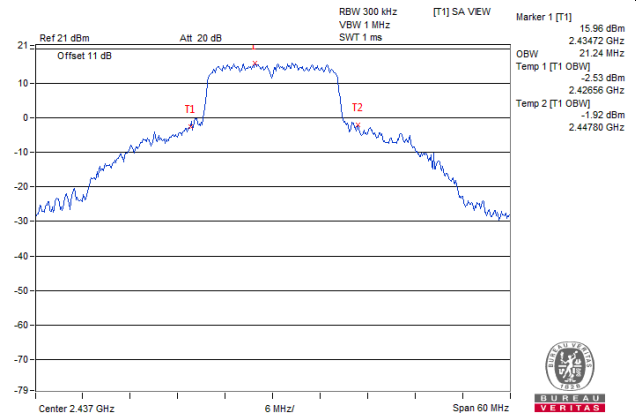

802.11n (HT20)

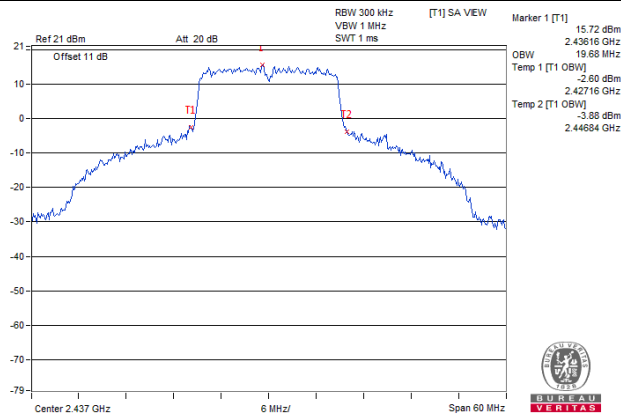

802.11n (HT40)

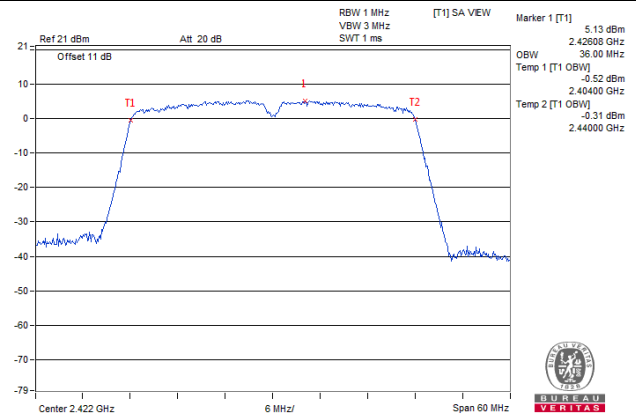

4.5 Conducted Output Power Measurement

4.5.1 Limits of Conducted Output Power Measurement

For systems using digital modulation in the 2400–2483.5 MHz bands: 1 Watt (30 dBm)

Per KDB 662911 D01 Multiple Transmitter Output Method of conducted output power measurement on IEEE 802.11 devices,

Array Gain = 0 dB (i.e., no array gain) for NANT \leq 4;

Array Gain = 0 dB (i.e., no array gain) for channel widths \geq 40 MHz for any NANT;

Array Gain = $5 \log(\text{NANT}/\text{NSS})$ dB or 3 dB, whichever is less for 20 MHz channel widths with NANT \geq 5.

For power measurements on all other devices: Array Gain = $10 \log(\text{NANT}/\text{NSS})$ dB.

4.5.2 Test Setup

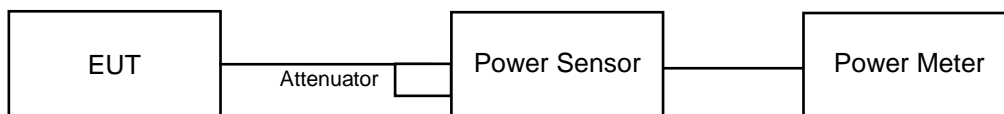

4.5.3 Test Instruments

Refer to section 4.1.2 to get information of above instrument.

4.5.4 Test Procedures

Average power sensor was used to perform output power measurement, trigger and gating function of wide band power meter is enabled to measure max output power of TX on burst. Duty factor is not added to measured value.

4.5.5 Deviation from Test Standard

No deviation.

4.5.6 EUT Operating Conditions

The software provided by client to enable the EUT under transmission condition continuously at lowest, middle and highest channel frequencies individually.

4.5.7 Test Results

CDD Mode

802.11b

Channel	Frequency (MHz)	Average Power (dBm)		Total Power (mW)	Total Power (dBm)	Limit (dBm)	Pass / Fail
		Chain 0	Chain 1				
1	2412	21.29	21.04	261.643	24.18	30	Pass
6	2437	25.27	25.00	652.739	28.15	30	Pass
11	2462	23.30	23.08	417.032	26.20	30	Pass

802.11g

Channel	Frequency (MHz)	Average Power (dBm)		Total Power (mW)	Total Power (dBm)	Limit (dBm)	Pass / Fail
		Chain 0	Chain 1				
1	2412	15.98	15.78	77.472	18.89	30	Pass
6	2437	23.90	23.65	477.21	26.79	30	Pass
11	2462	17.25	16.94	102.52	20.11	30	Pass

802.11n (HT20)

Channel	Frequency (MHz)	Average Power (dBm)		Total Power (mW)	Total Power (dBm)	Limit (dBm)	Pass / Fail
		Chain 0	Chain 1				
1	2412	13.54	13.38	44.371	16.47	30	Pass
6	2437	23.50	23.38	441.643	26.45	30	Pass
11	2462	15.10	14.84	62.838	17.98	30	Pass

802.11n (HT40)

Channel	Frequency (MHz)	Average Power (dBm)		Total Power (mW)	Total Power (dBm)	Limit (dBm)	Pass / Fail
		Chain 0	Chain 1				
3	2422	10.86	10.84	24.324	13.86	30	Pass
6	2437	16.79	16.84	96.059	19.83	30	Pass
9	2452	13.03	12.69	38.669	15.87	30	Pass

Beamforming Mode

802.11n (HT20)

Channel	Frequency (MHz)	Average Power (dBm)		Total Power (mW)	Total Power (dBm)	Limit (dBm)	Pass / Fail
		Chain 0	Chain 1				
1	2412	10.53	10.37	22.187	13.46	29.49	Pass
6	2437	20.49	20.37	220.800	23.44	29.49	Pass
11	2462	12.09	11.83	31.421	14.97	29.49	Pass

NOTE:

1. Directional gain = $3.5 \text{ dBi} + 10\log(2) = 6.51 \text{ dBi} > 6 \text{ dBi}$, so the power density limit shall be reduced to $30 - (6.51 - 6) = 29.49 \text{ dBm}$.

802.11n (HT40)

Channel	Frequency (MHz)	Average Power (dBm)		Total Power (mW)	Total Power (dBm)	Limit (dBm)	Pass / Fail
		Chain 0	Chain 1				
3	2422	7.85	7.83	12.163	10.85	29.49	Pass
6	2437	13.78	13.83	48.033	16.82	29.49	Pass
9	2452	10.02	9.68	19.336	12.86	29.49	Pass

NOTE:

1. Directional gain = $3.5 \text{ dBi} + 10\log(2) = 6.51 \text{ dBi} > 6 \text{ dBi}$, so the power density limit shall be reduced to $30 - (6.51 - 6) = 29.49 \text{ dBm}$.

4.6 Power Spectral Density Measurement

4.6.1 Limits of Power Spectral Density Measurement

The Maximum of Power Spectral Density Measurement is 8 dBm in any 3 kHz band during any time interval of continuous transmission.

4.6.2 Test Setup

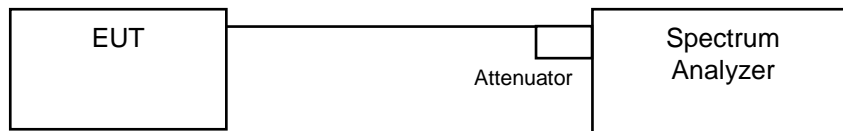

4.6.3 Test Instruments

Refer to section 4.1.2 to get information of above instrument.

4.6.4 Test Procedure

For Average Power (Duty cycle $\geq 98\%$)

- a. Set instrument center frequency to DTS channel center frequency.
- b. Set span to at least 1.5 times the OBW.
- c. Set RBW to: $3 \text{ kHz} \leq \text{RBW} \leq 100 \text{ kHz}$.
- d. Set VBW $\geq 3 \times \text{RBW}$.
- e. Detector = power averaging (RMS) or sample detector (when RMS not available).
- f. Ensure that the number of measurement points in the sweep $\geq 2 \times \text{span}/\text{RBW}$.
- g. Sweep time = auto couple.
- h. Employ trace averaging (RMS) mode over a minimum of 100 traces.
- i. Use the peak marker function to determine the maximum amplitude level.

For Average Power (Duty cycle $< 98\%$)

- a. Measure the duty cycle (x).
- b. Set instrument center frequency to DTS channel center frequency.
- c. Set span to at least 1.5 times the OBW.
- d. Set RBW to: $3 \text{ kHz} \leq \text{RBW} \leq 100 \text{ kHz}$.
- e. Set VBW $\geq 3 \times \text{RBW}$.
- f. Detector = power averaging (RMS) or sample detector (when RMS not available).
- g. Ensure that the number of measurement points in the sweep $\geq 2 \times \text{span}/\text{RBW}$.
- h. Sweep time = auto couple.
- i. Do not use sweep triggering. Allow sweep to "free run".
- j. Employ trace averaging (RMS) mode over a minimum of 100 traces.
- k. Use the peak marker function to determine the maximum amplitude level.
- l. Add $10 \log (1/x)$, where x is the duty cycle measured in step (a), to the measured PSD to compute the average PSD during the actual transmission time.

4.6.5 Deviation from Test Standard

No deviation.

4.6.6 EUT Operating Condition

The software provided by client to enable the EUT under transmission condition continuously at lowest, middle and highest channel frequencies individually.

4.6.7 Test Results

802.11b

TX Chain	Channel	Freq. (MHz)	PSD (dBm/3 kHz)	10 log (N=2) dB	Total PSD (dBm/3 kHz)	Limit (dBm/3 kHz)	Pass / Fail
0	1	2412	-10.37	3.01	-7.36	7.49	Pass
	6	2437	-7.38	3.01	-4.37	7.49	Pass
	11	2462	-8.49	3.01	-5.48	7.49	Pass
1	1	2412	-10.95	3.01	-7.94	7.49	Pass
	6	2437	-6.94	3.01	-3.93	7.49	Pass
	11	2462	-8.32	3.01	-5.31	7.49	Pass

NOTE:

- Directional gain = $3.5 \text{ dBi} + 10\log(2) = 6.51 \text{ dBi} > 6 \text{ dBi}$, so the power density limit shall be reduced to $8 - (6.51 - 6) = 7.49 \text{ dBm}$.
- Method 2) C) of power density measurement of KDB 662911 is using for calculating total power density.

802.11g

TX Chain	Channel	Freq. (MHz)	PSD (dBm/3 kHz)	10 log (N=2) dB	Total PSD (dBm/3 kHz)	Limit (dBm/3 kHz)	Pass / Fail
0	1	2412	-19.29	3.01	-16.07	7.49	Pass
	6	2437	-11.93	3.01	-8.71	7.49	Pass
	11	2462	-17.35	3.01	-14.13	7.49	Pass
1	1	2412	-19.67	3.01	-16.45	7.49	Pass
	6	2437	-11.84	3.01	-8.62	7.49	Pass
	11	2462	-17.51	3.01	-14.29	7.49	Pass

NOTE:

- Directional gain = $3.5 \text{ dBi} + 10\log(2) = 6.51 \text{ dBi} > 6 \text{ dBi}$, so the power density limit shall be reduced to $8 - (6.51 - 6) = 7.49 \text{ dBm}$.
- Method E) 2) c) of power density measurement of KDB 662911 is using for calculating total power density.

802.11n (HT20)

TX Chain	Channel	Freq. (MHz)	PSD (dBm/3 kHz)	10 log (N=2) dB	Total PSD (dBm/3 kHz)	Limit (dBm/3 kHz)	Pass / Fail
0	1	2412	-21.57	3.01	-18.56	7.49	Pass
	6	2437	-12.29	3.01	-9.28	7.49	Pass
	11	2462	-19.42	3.01	-16.41	7.49	Pass
1	1	2412	-20.94	3.01	-17.93	7.49	Pass
	6	2437	-11.52	3.01	-8.51	7.49	Pass
	11	2462	-19.28	3.01	-16.27	7.49	Pass

NOTE:

1. Directional gain = 3.5 dBi + 10log(2) = 6.51 dBi > 6 dBi , so the power density limit shall be reduced to 8-(6.51-6) = 7.49 dBm.
2. Method E) 2) c) of power density measurement of KDB 662911 is using for calculating total power density.

802.11n (HT40)

TX Chain	Channel	Freq. (MHz)	PSD (dBm/3 kHz)	10 log (N=2) dB	Total PSD (dBm/3 kHz)	Limit (dBm/3 kHz)	Pass / Fail
0	3	2422	-28.4	3.01	-25.23	7.49	Pass
	6	2437	-21.78	3.01	-18.61	7.49	Pass
	9	2452	-24.5	3.01	-21.33	7.49	Pass
1	3	2422	-28	3.01	-24.83	7.49	Pass
	6	2437	-21.64	3.01	-18.47	7.49	Pass
	9	2452	-23.25	3.01	-20.08	7.49	Pass

NOTE:

1. Directional gain = 3.5 dBi + 10log(2) = 6.51 dBi > 6 dBi , so the power density limit shall be reduced to 8-(6.51-6) = 6 dBm.
2. Method E) 2) c) of power density measurement of KDB 662911 is using for calculating total power density.

Spectrum Plot of Worst Value

802.11b

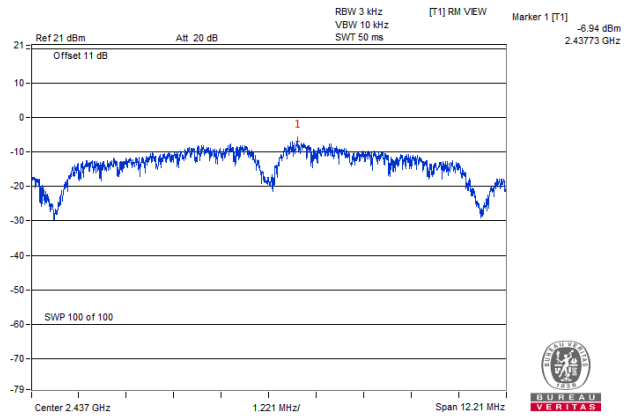

802.11g

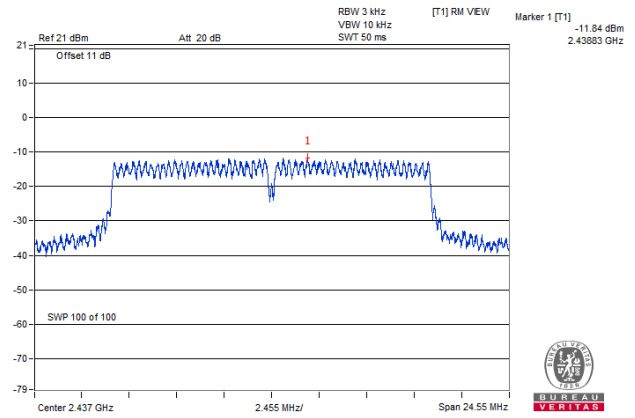

802.11n (HT20)

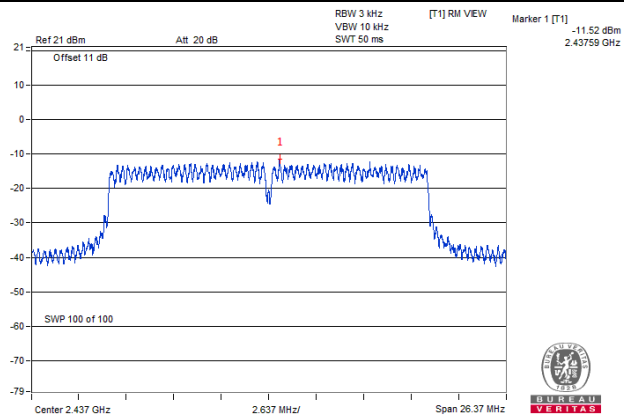

802.11n (HT40)

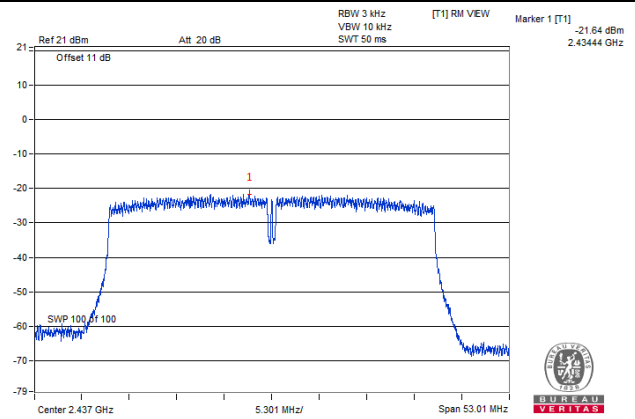

4.7 Conducted Out of Band Emission Measurement

4.7.1 Limits of Conducted Out of Band Emission Measurement

Below -30 dB of the highest emission level of operating band (in 100 kHz Resolution Bandwidth).

4.7.2 Test Setup

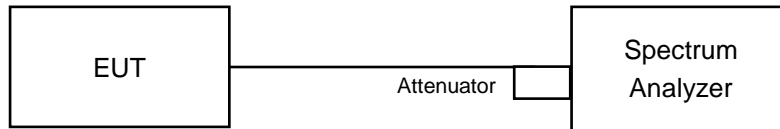

4.7.3 Test Instruments

Refer to section 4.1.2 to get information of above instrument.

4.7.4 Test Procedure

MEASUREMENT PROCEDURE REF

1. Set the RBW = 100 kHz.
2. Set the VBW \geq 300 kHz.
3. Detector = peak.
4. Sweep time = auto couple.
5. Trace mode = max hold.
6. Allow trace to fully stabilize.
7. Use the peak marker function to determine the maximum power level in any 100 kHz band segment within the fundamental EBW.

MEASUREMENT PROCEDURE OOB

1. Set RBW = 100 kHz.
2. Set VBW \geq 300 kHz.
3. Detector = peak.
4. Sweep = auto couple.
5. Trace Mode = max hold.
6. Allow trace to fully stabilize.
7. Use the peak marker function to determine the maximum amplitude level.

4.7.5 Deviation from Test Standard

No deviation.

4.7.6 EUT Operating Condition

The software provided by client to enable the EUT under transmission condition continuously at lowest, middle and highest channel frequencies individually.

4.7.7 Test Results

The conducted emission test is performed on each TX port of operating mode without summing or adding 10log (N) since the limit is relative emission limit.

The spectrum plots are attached on the following images. D1 line indicates the highest level, and D2 line indicates the 30 dB offset below D1. It shows compliance with the requirement.

802.11b CHAIN 0

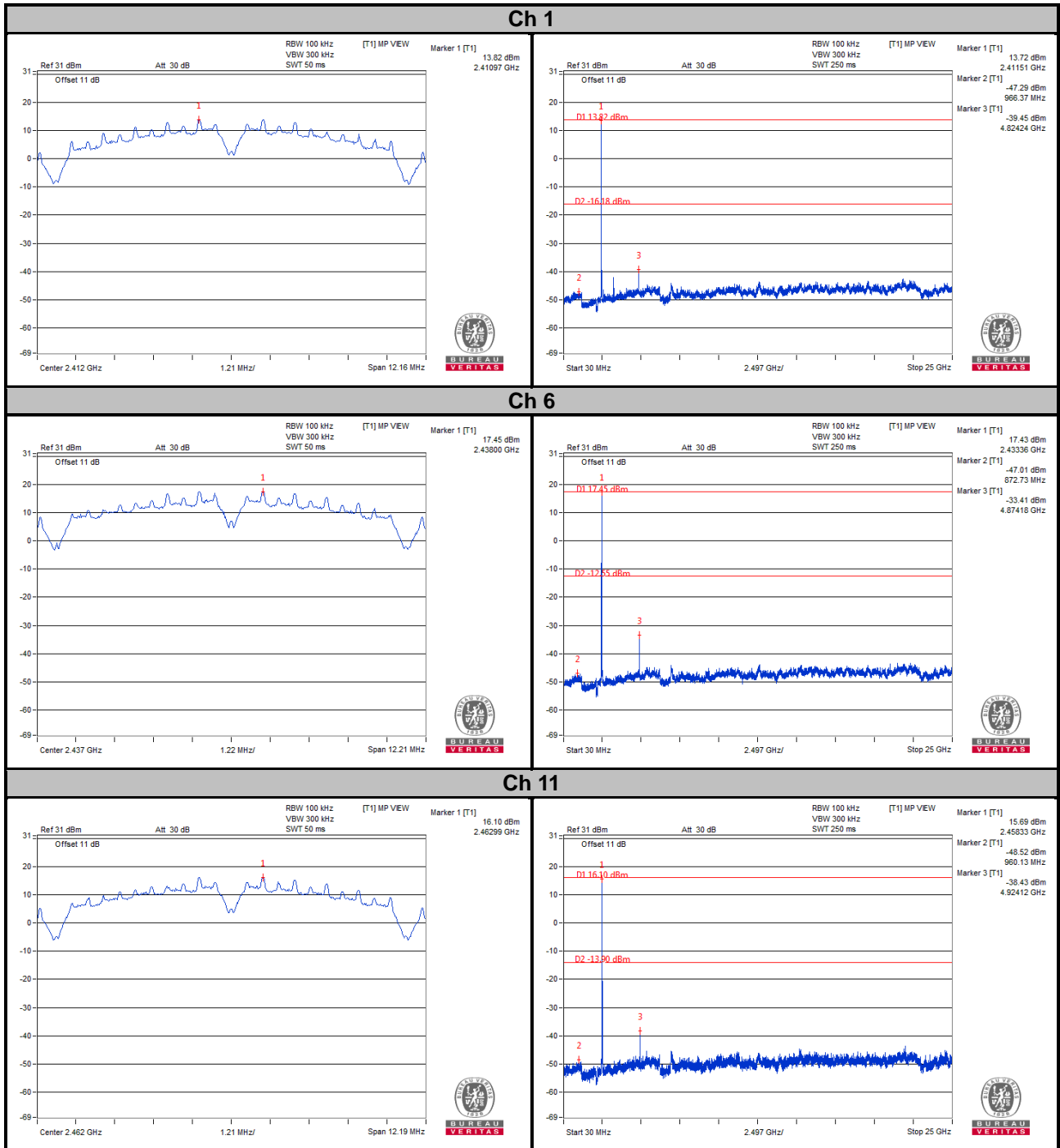

Ch 1 Band Edge

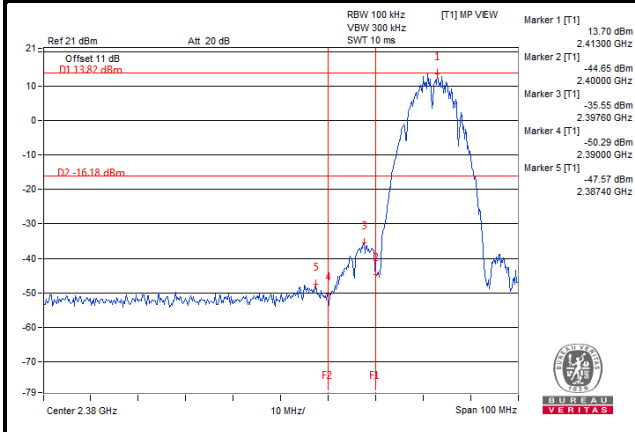

Ch 11 Band Edge

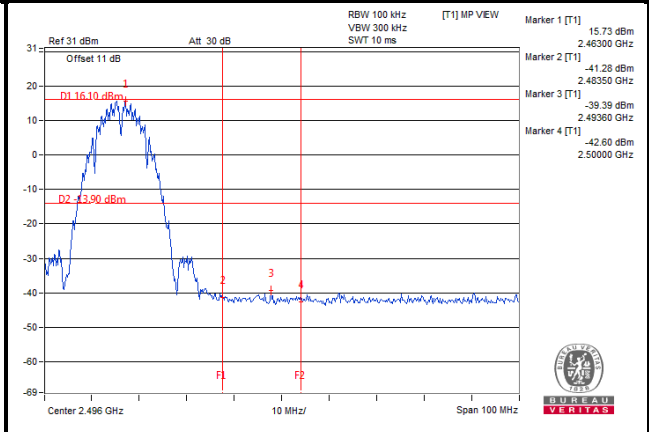

CHAIN 1

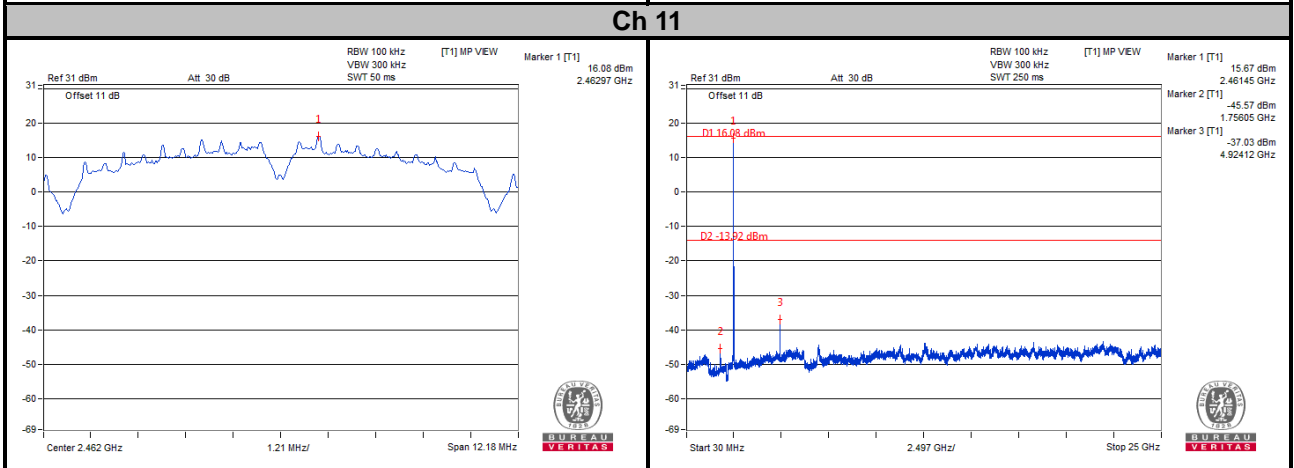
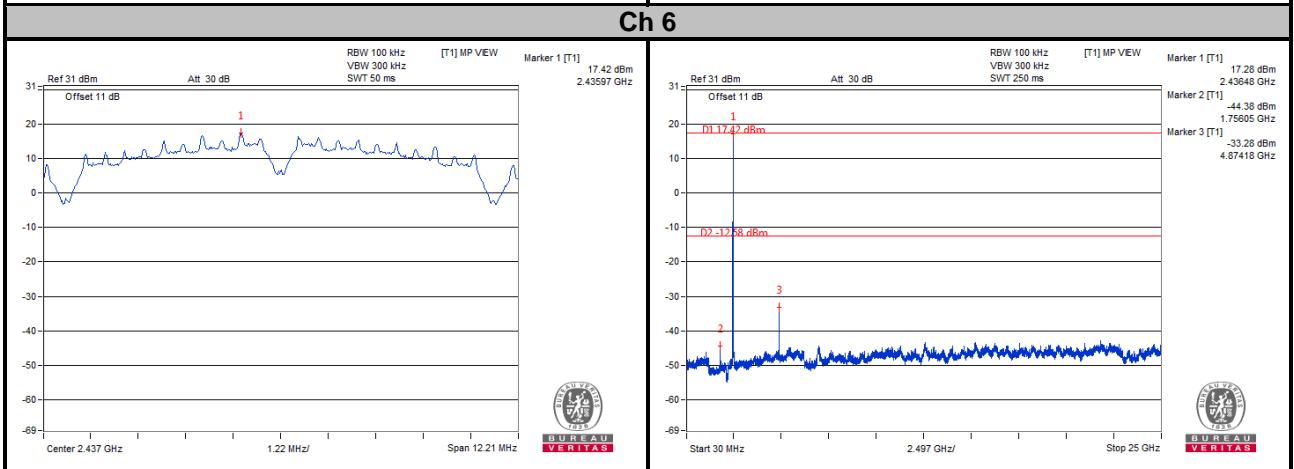
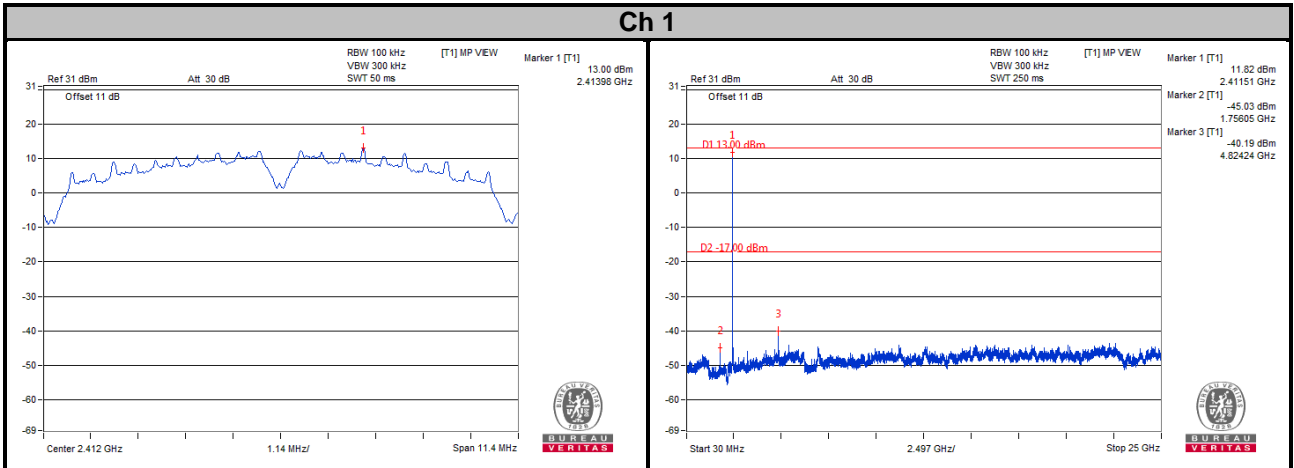

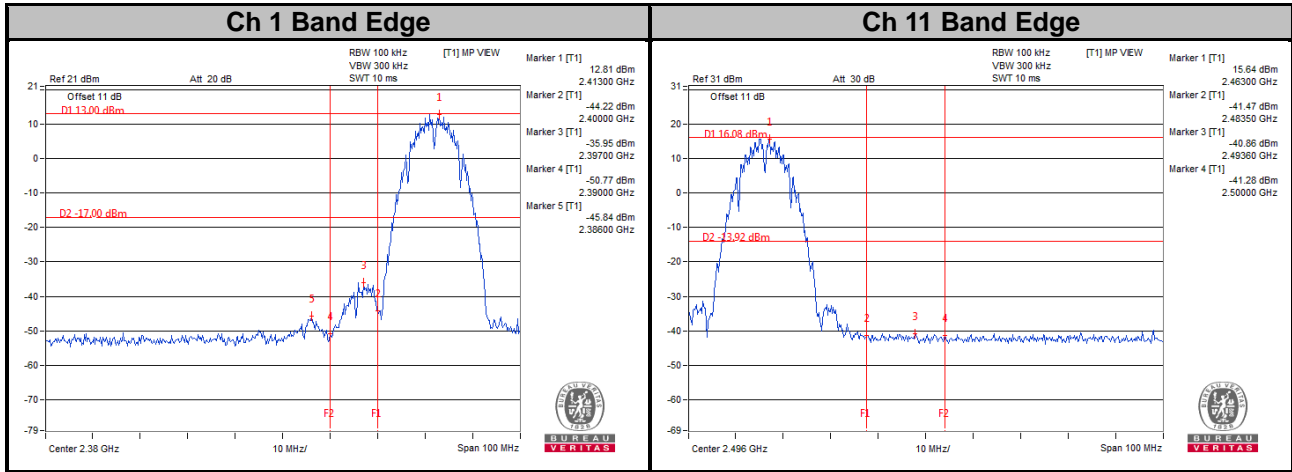

802.11g
CHAIN 0

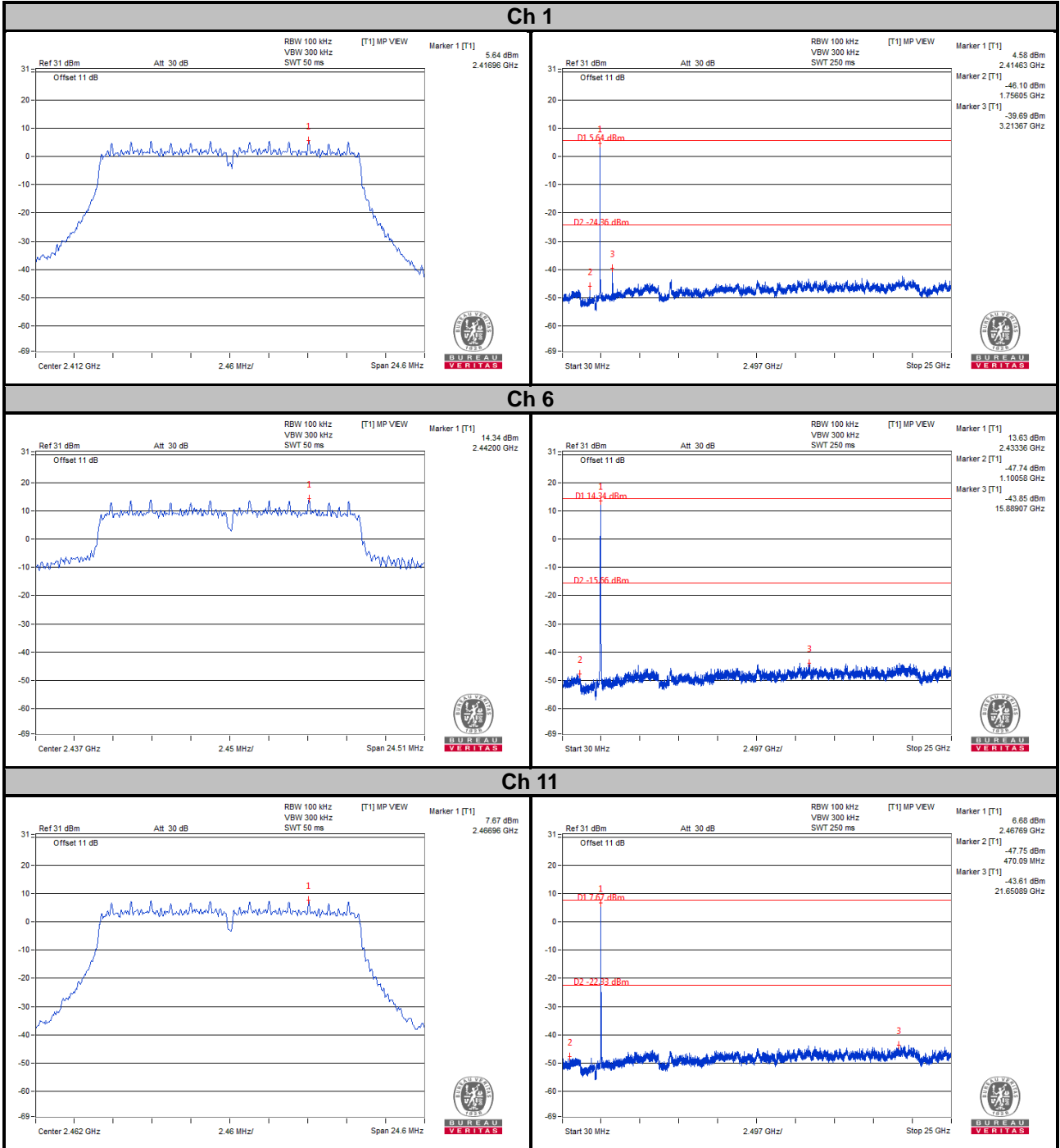

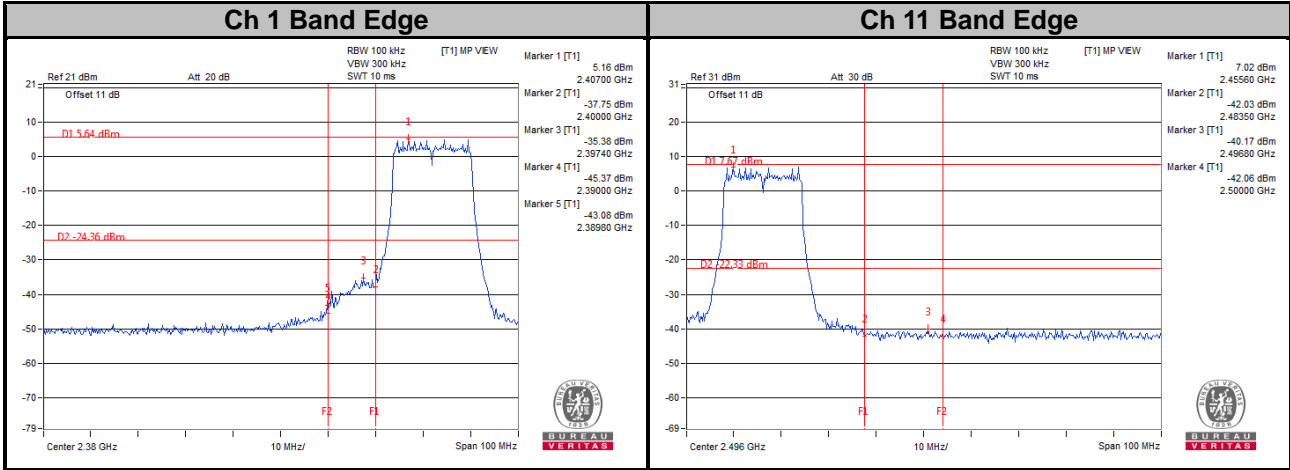

CHAIN 1

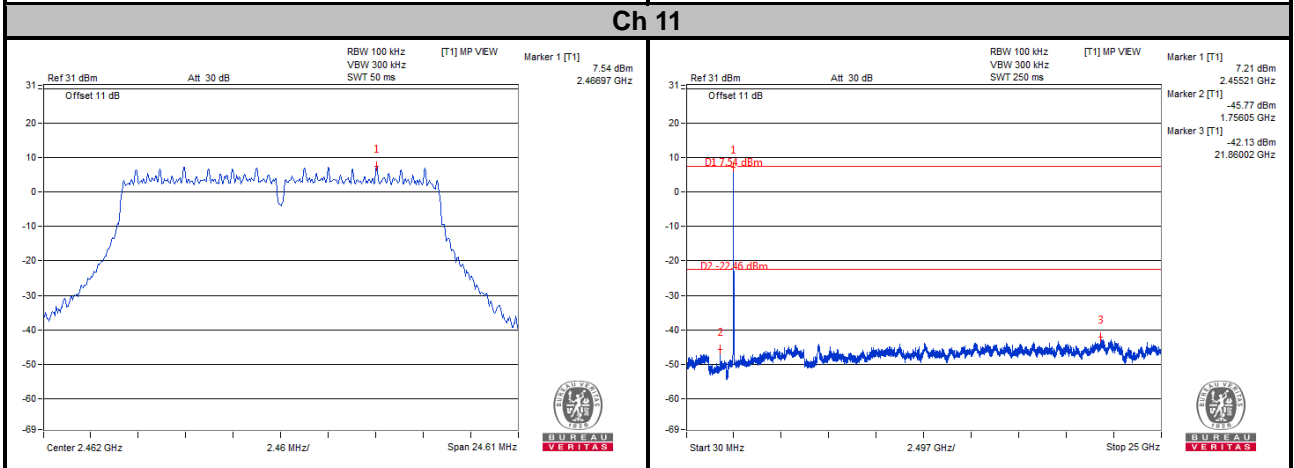
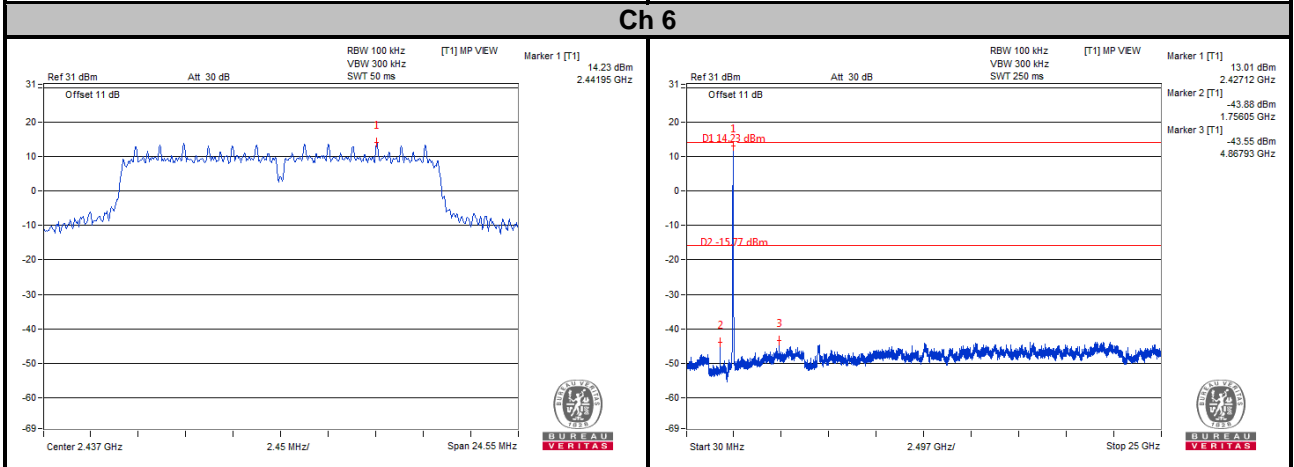
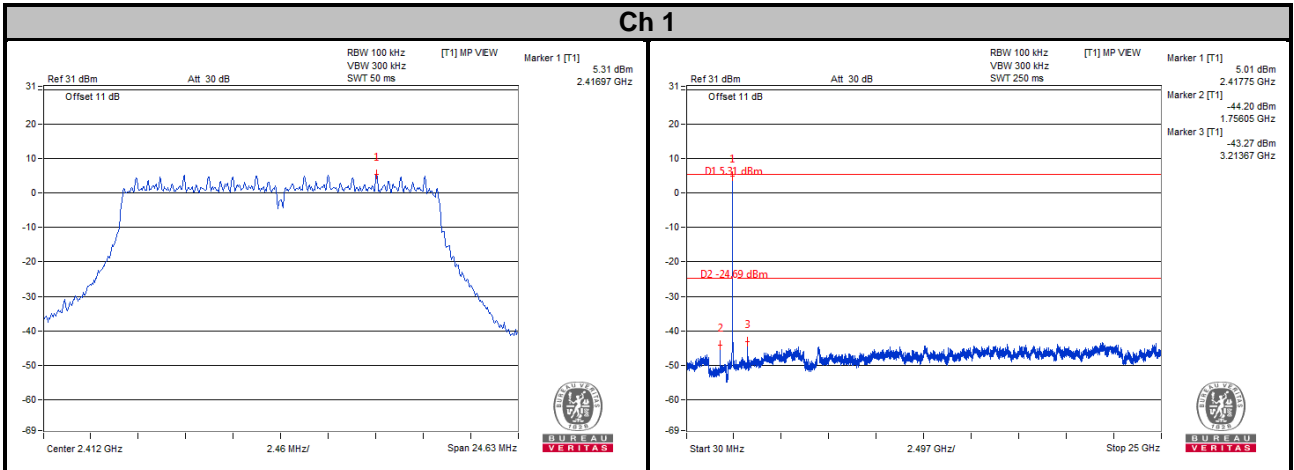

Ch 1 Band Edge

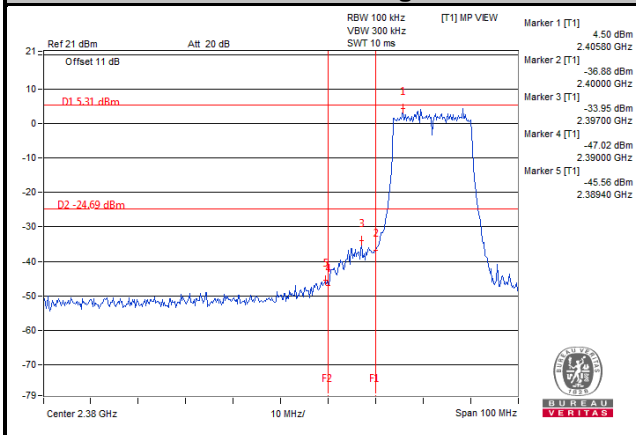

Ch 11 Band Edge

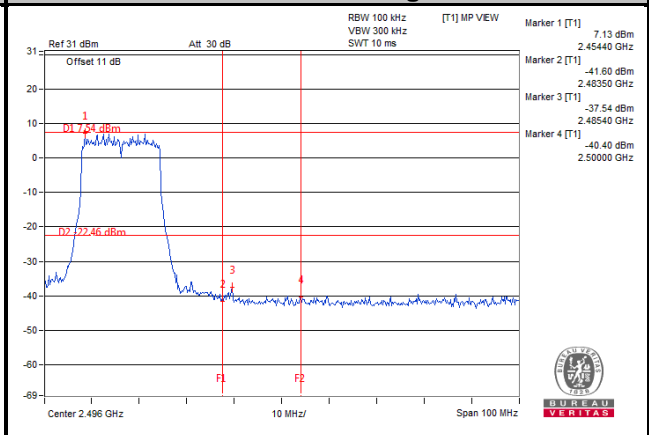

802.11n (HT20)
CHAIN 0

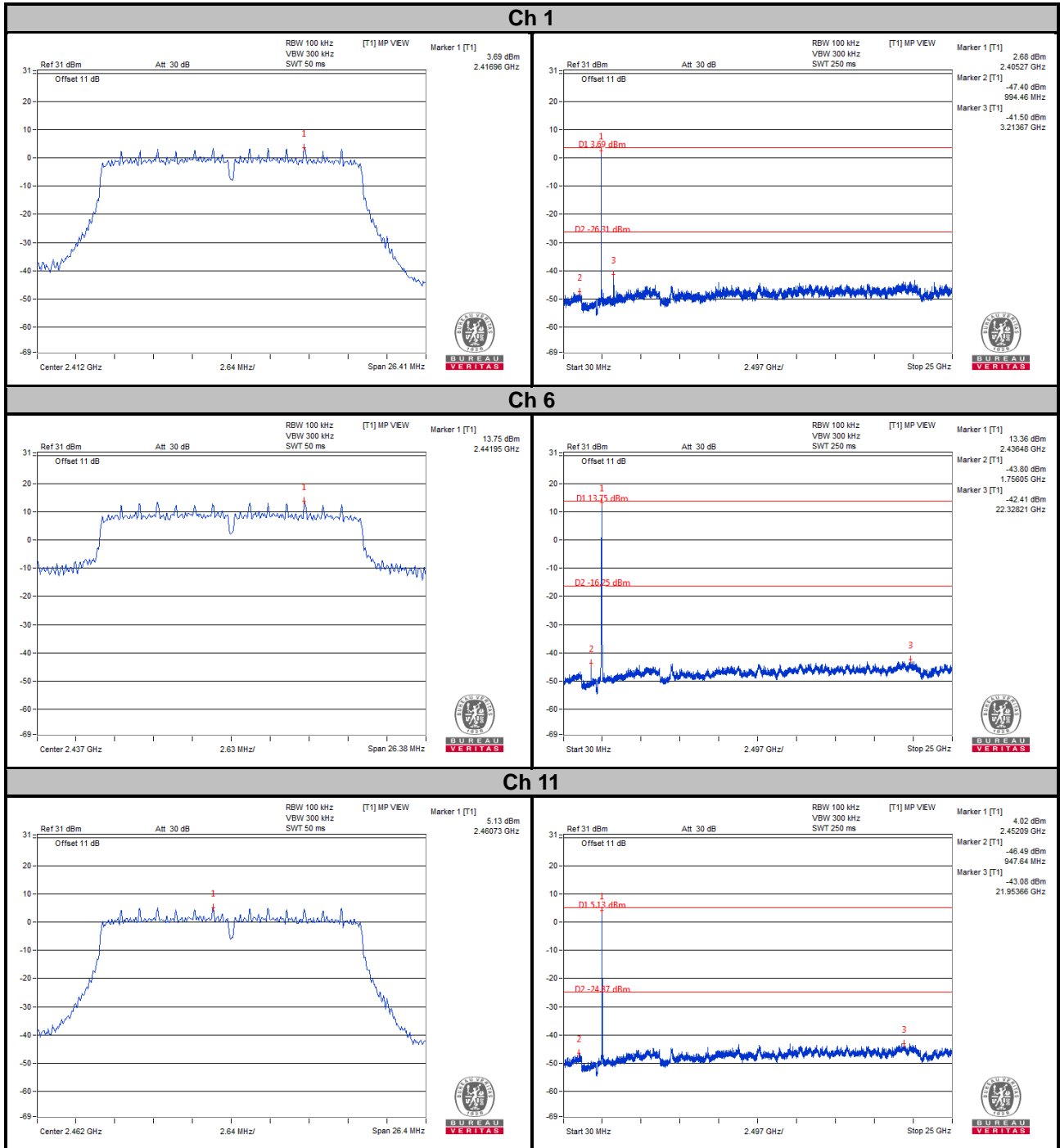

Ch 1 Band Edge

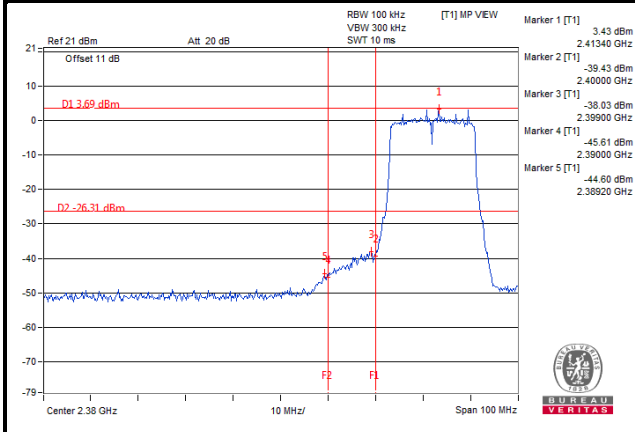

Ch 11 Band Edge

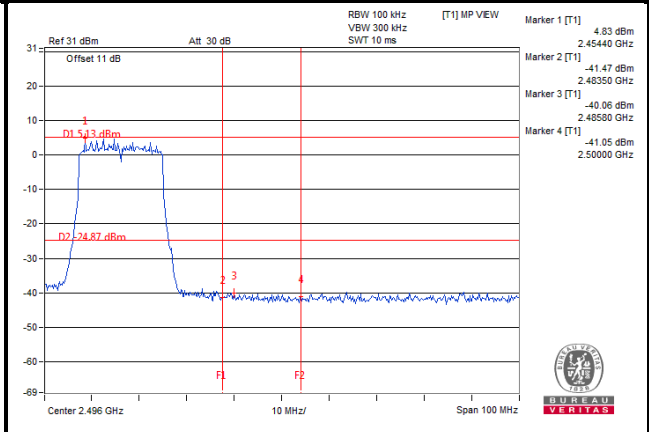

CHAIN 1

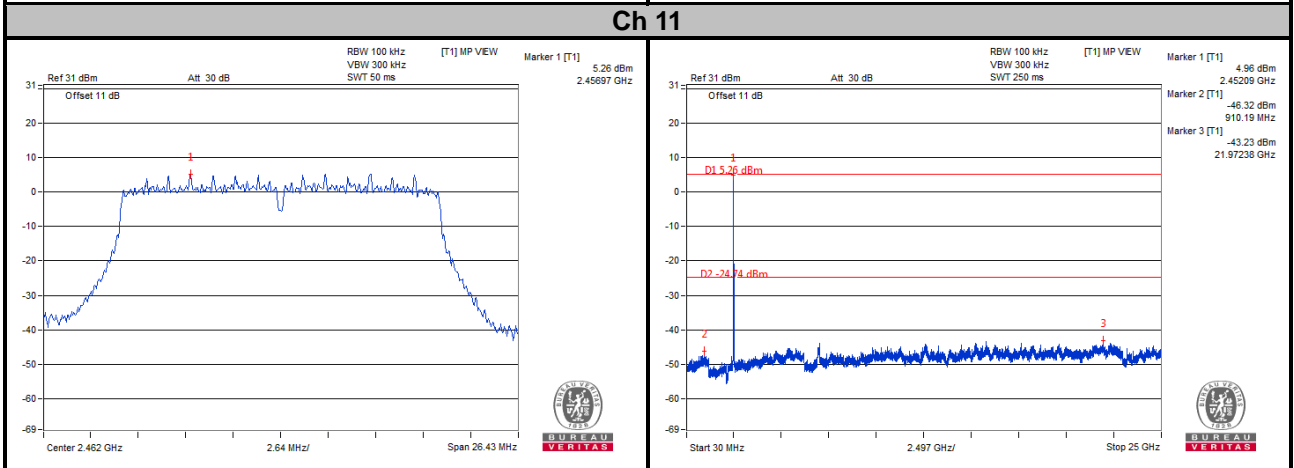
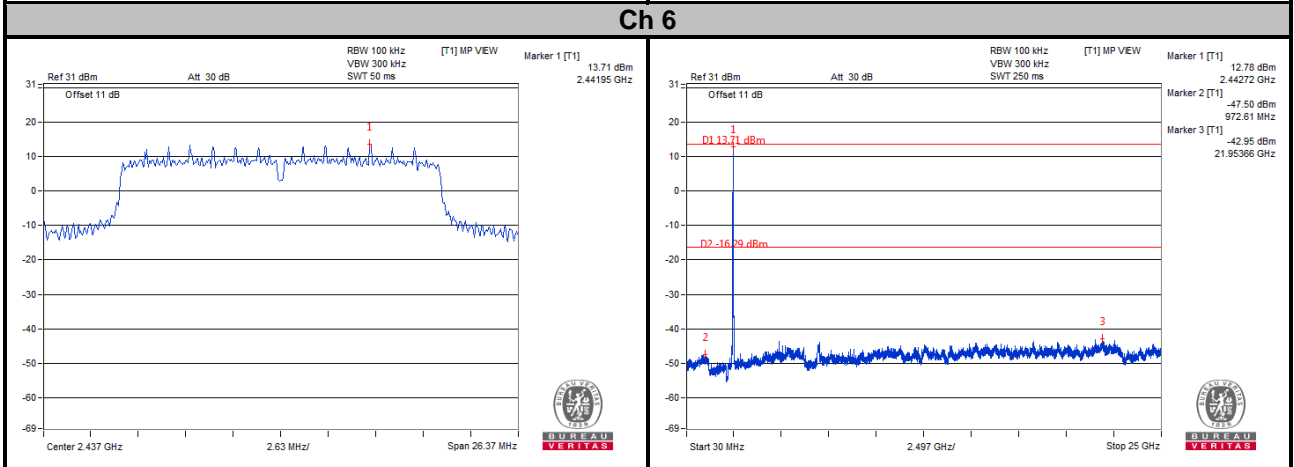
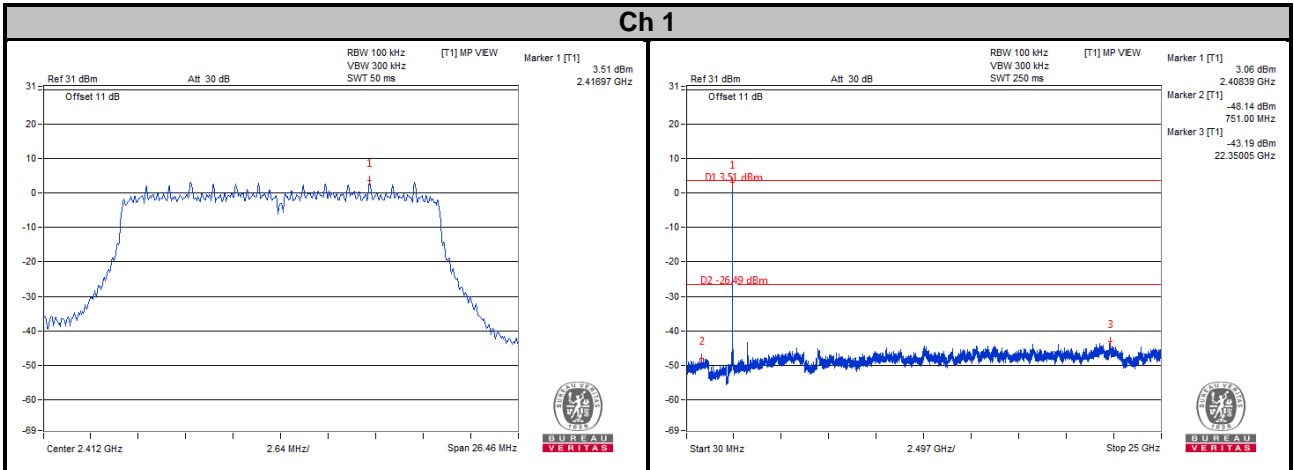

Ch 1 Band Edge

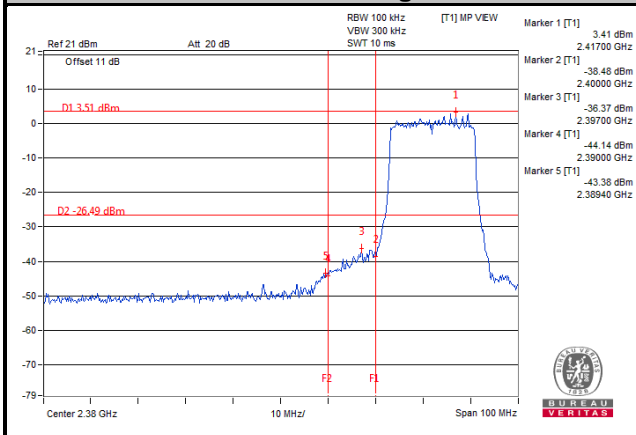

Ch 11 Band Edge

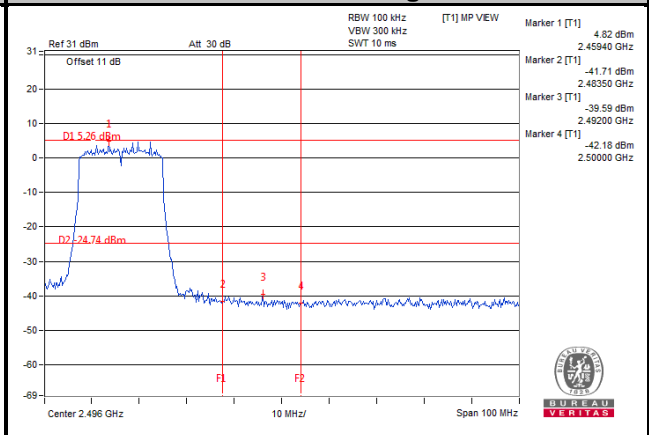

802.11n (HT40)
CHAIN 0

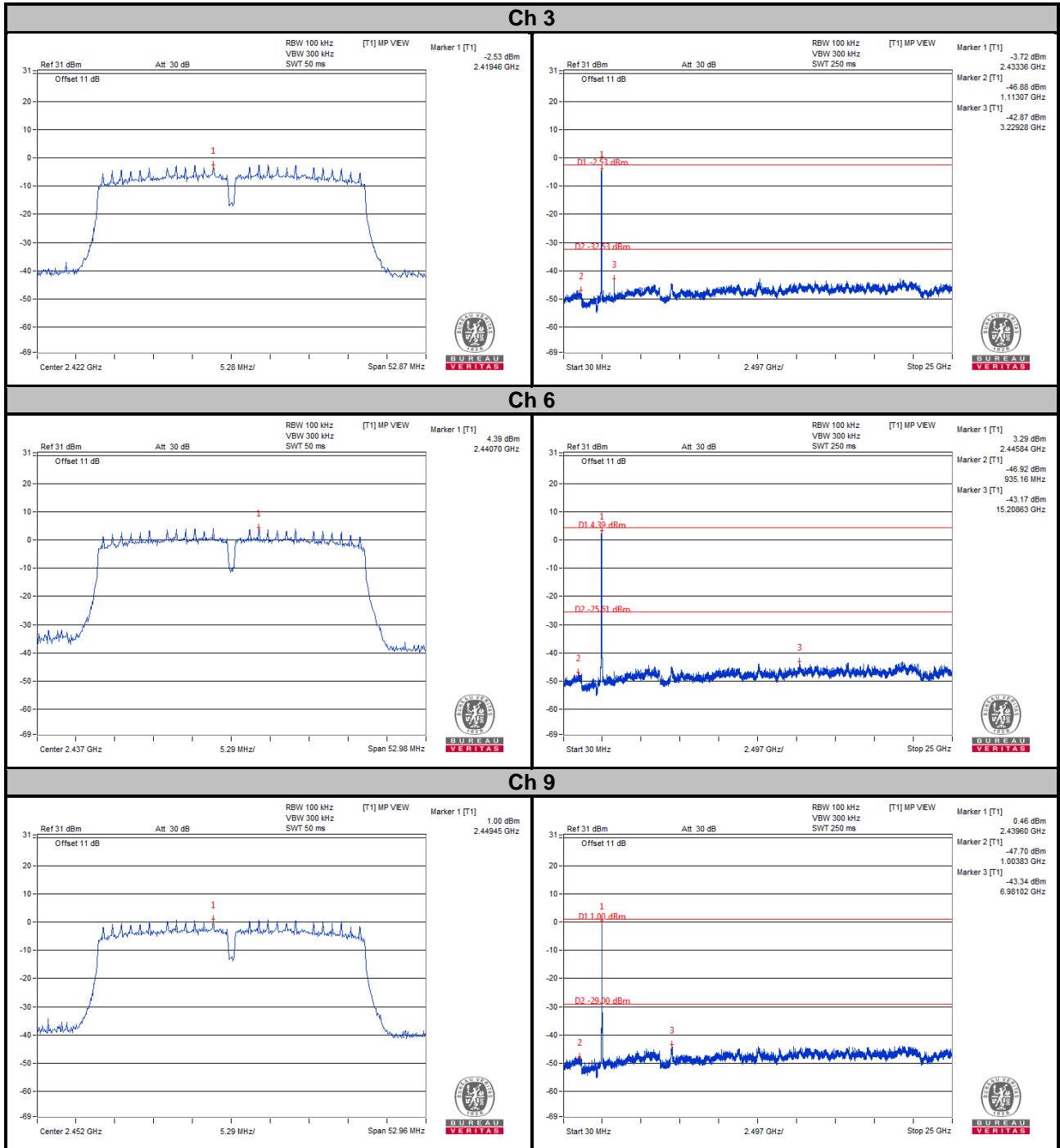

Ch 3 Band Edge

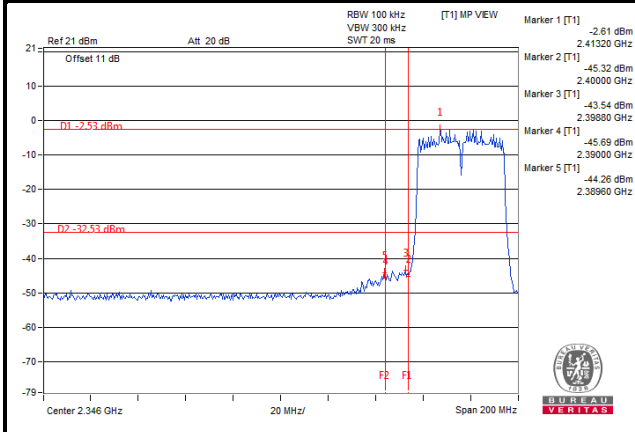

Ch 9 Band Edge

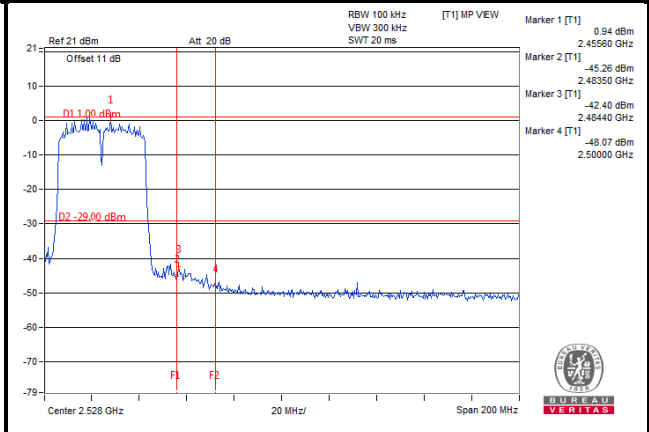

CHAIN 1

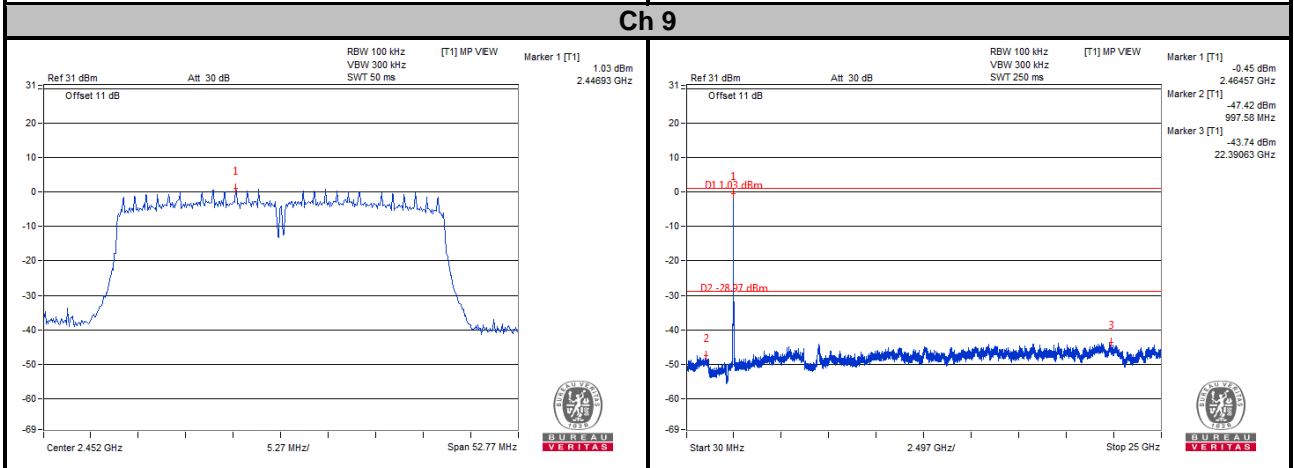
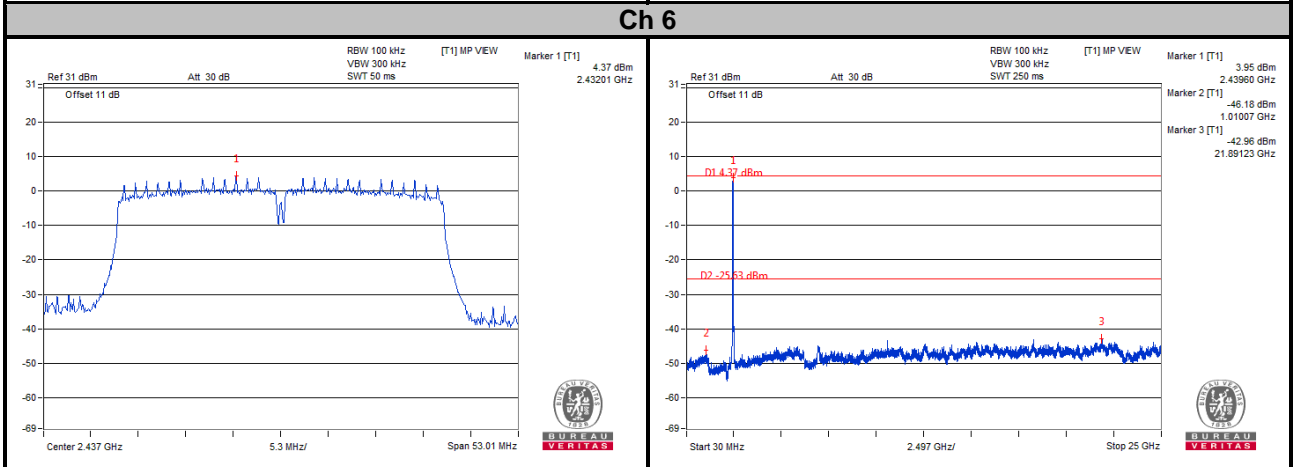
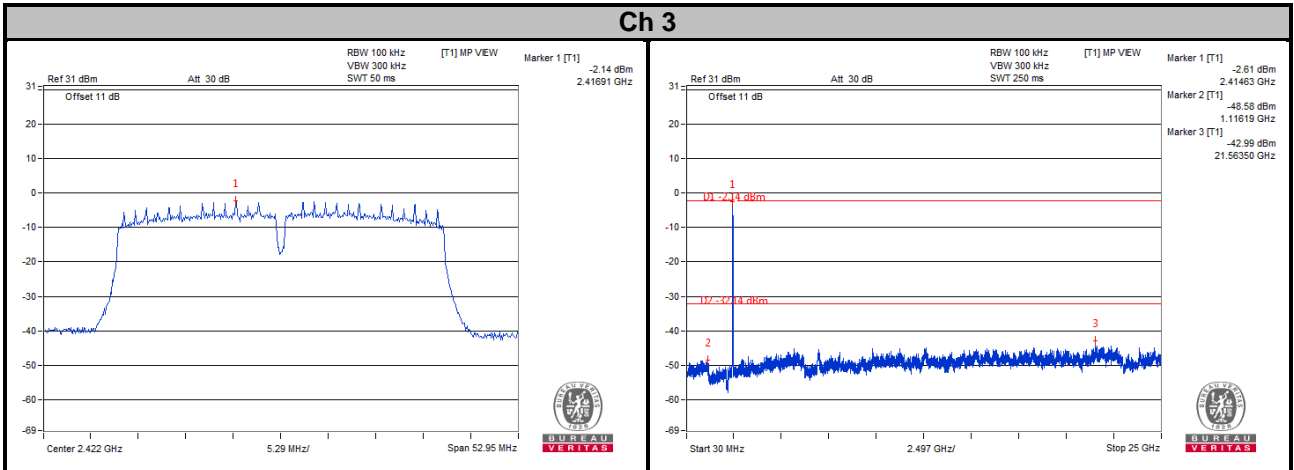

Ch 3 Band Edge

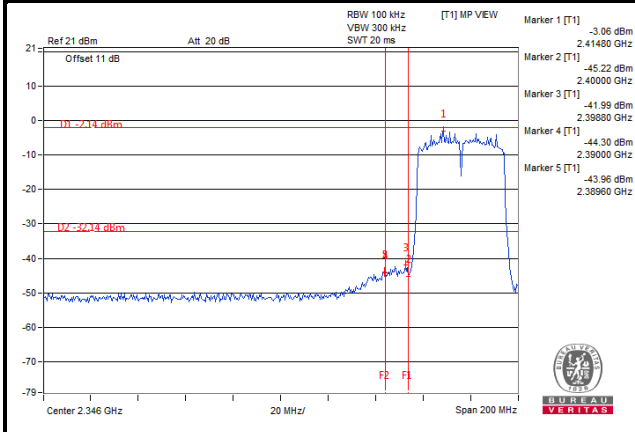

Ch 9 Band Edge

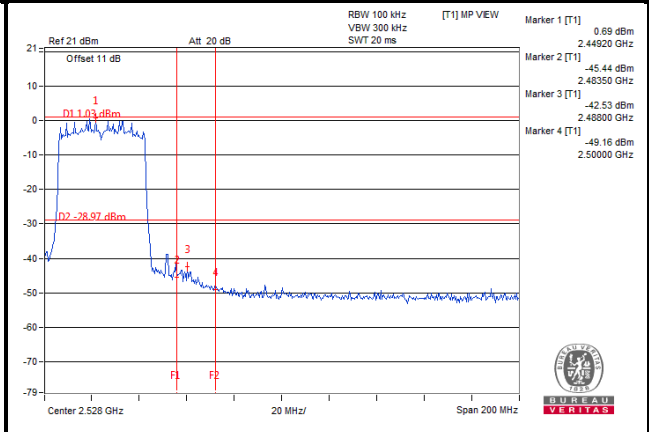

5 Pictures of Test Arrangements

Please refer to the attached file (Test Setup Photo).

Annex A- Band Edge Measurement

802.11b

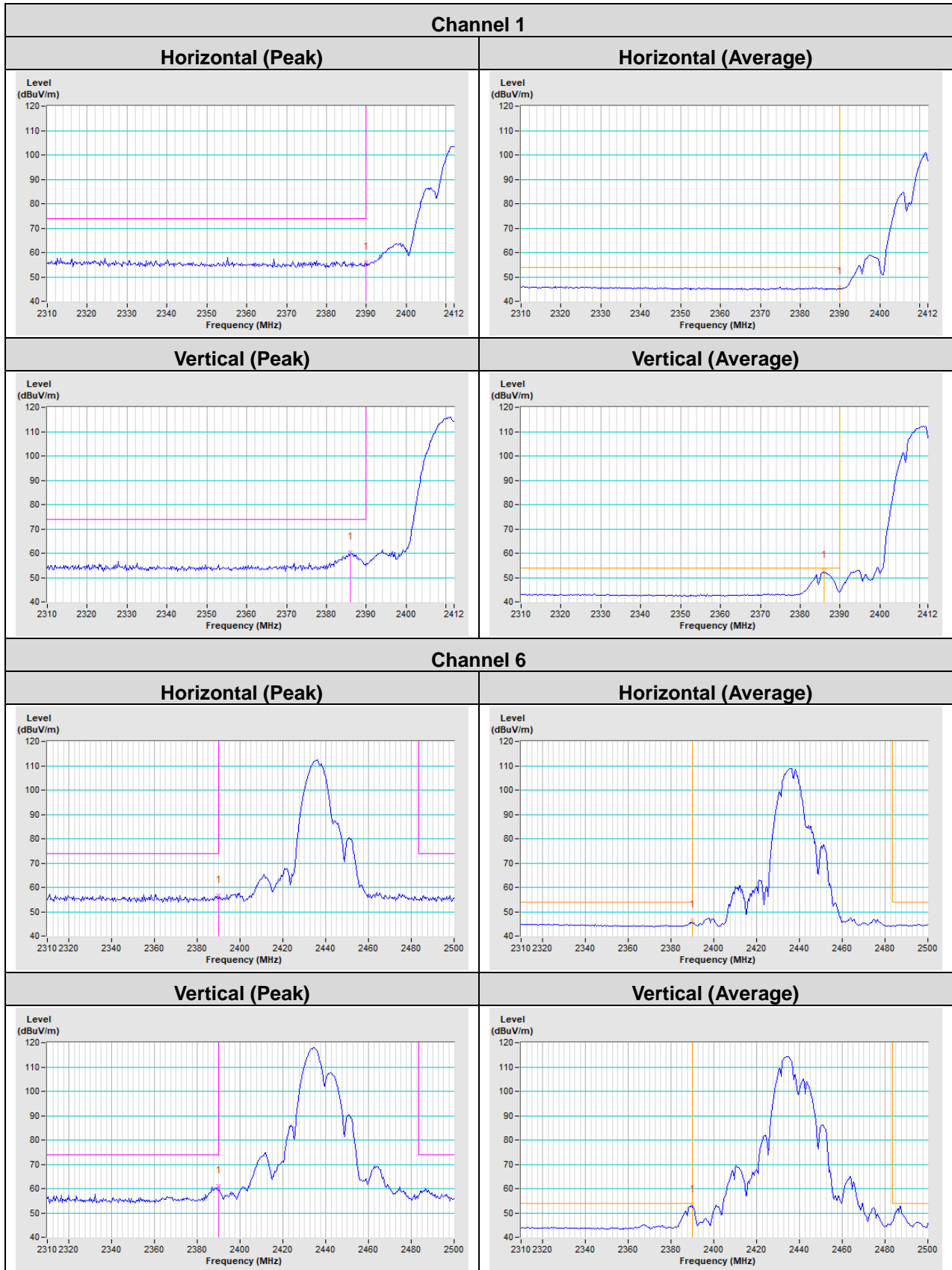

Channel 11

Horizontal (Peak)

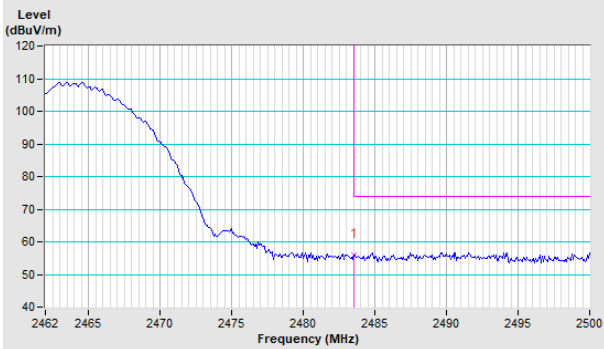

Horizontal (Average)

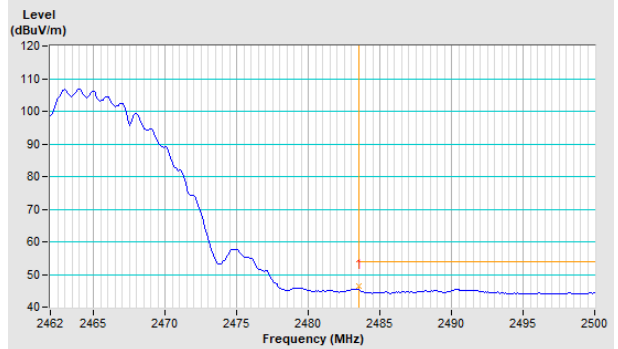

Vertical (Peak)

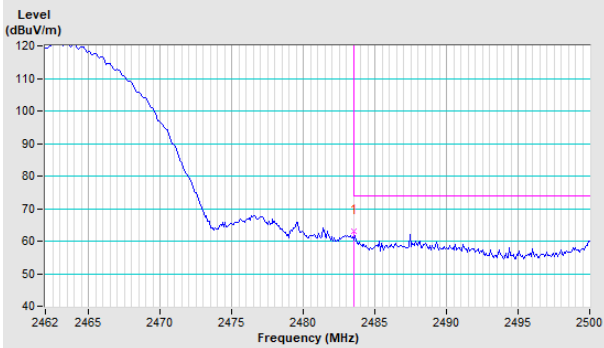

Vertical (Average)

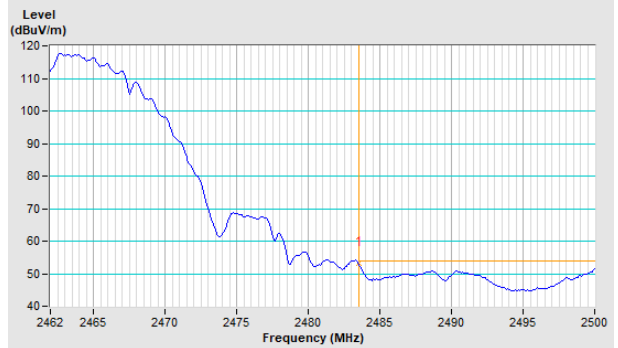

802.11g

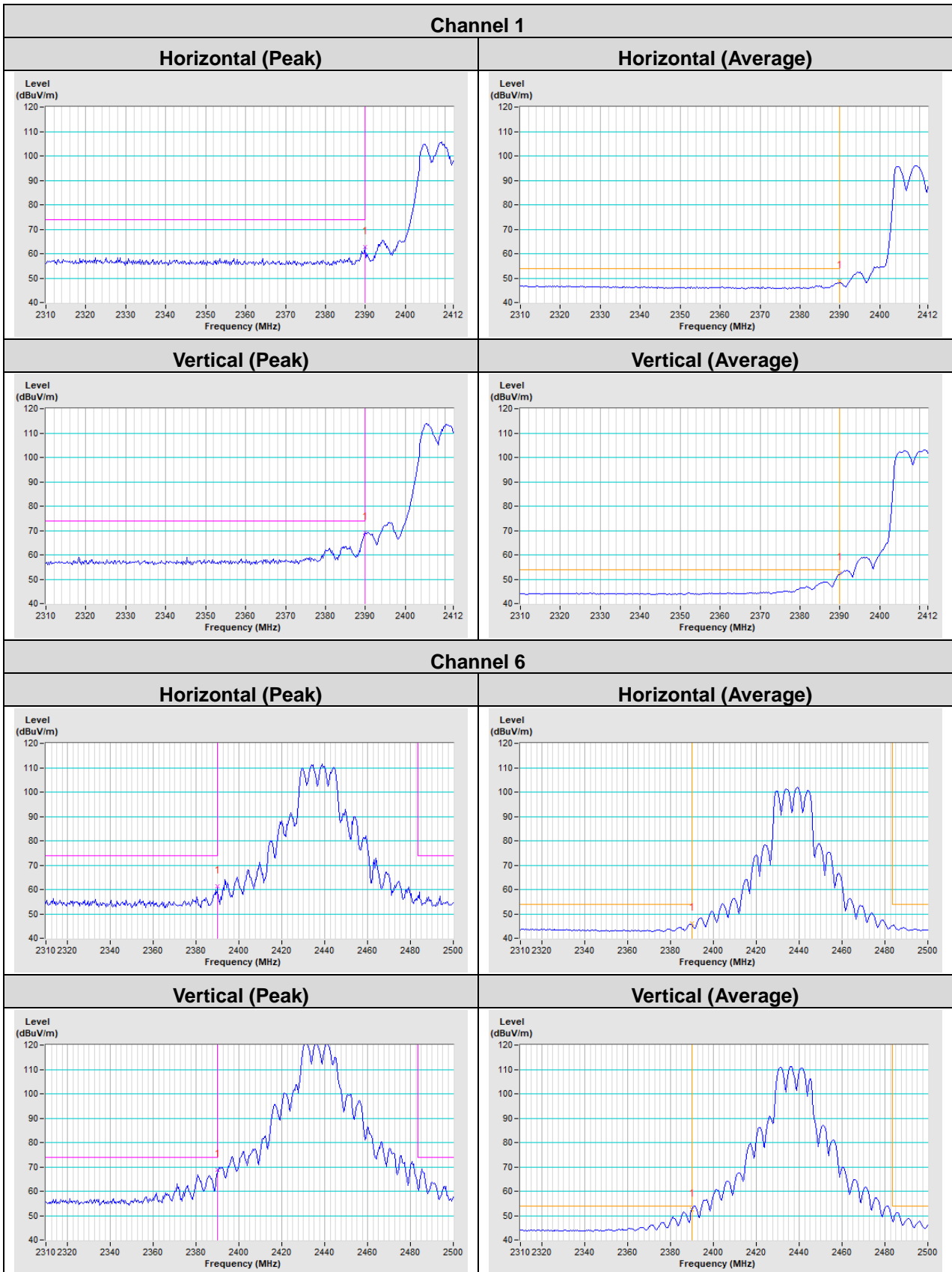

Channel 11

Horizontal (Peak)

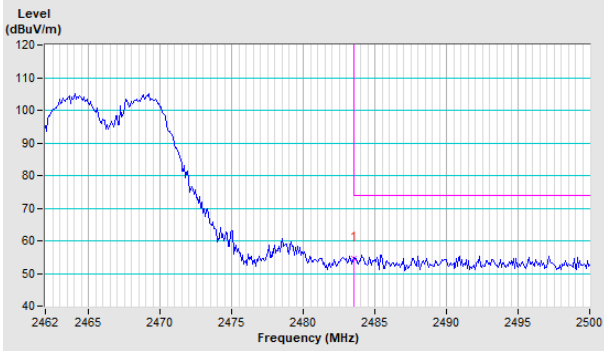

Horizontal (Average)

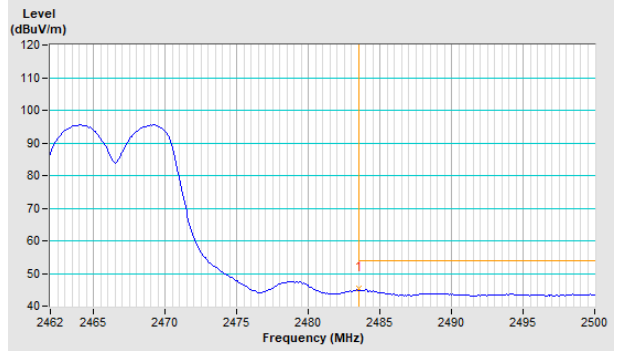

Vertical (Peak)

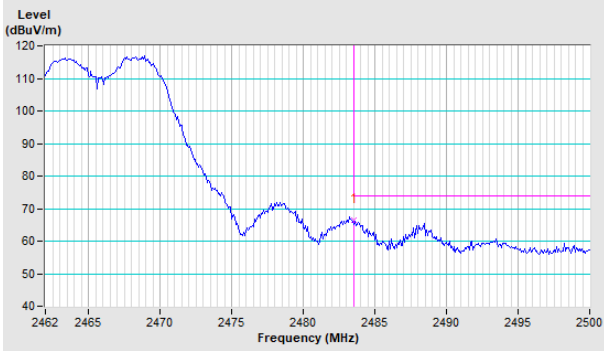

Vertical (Average)

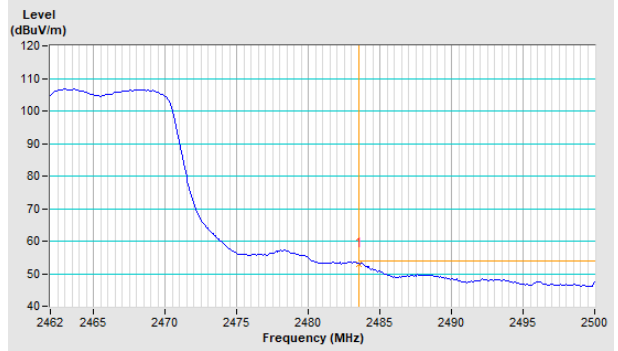

802.11n (HT20)

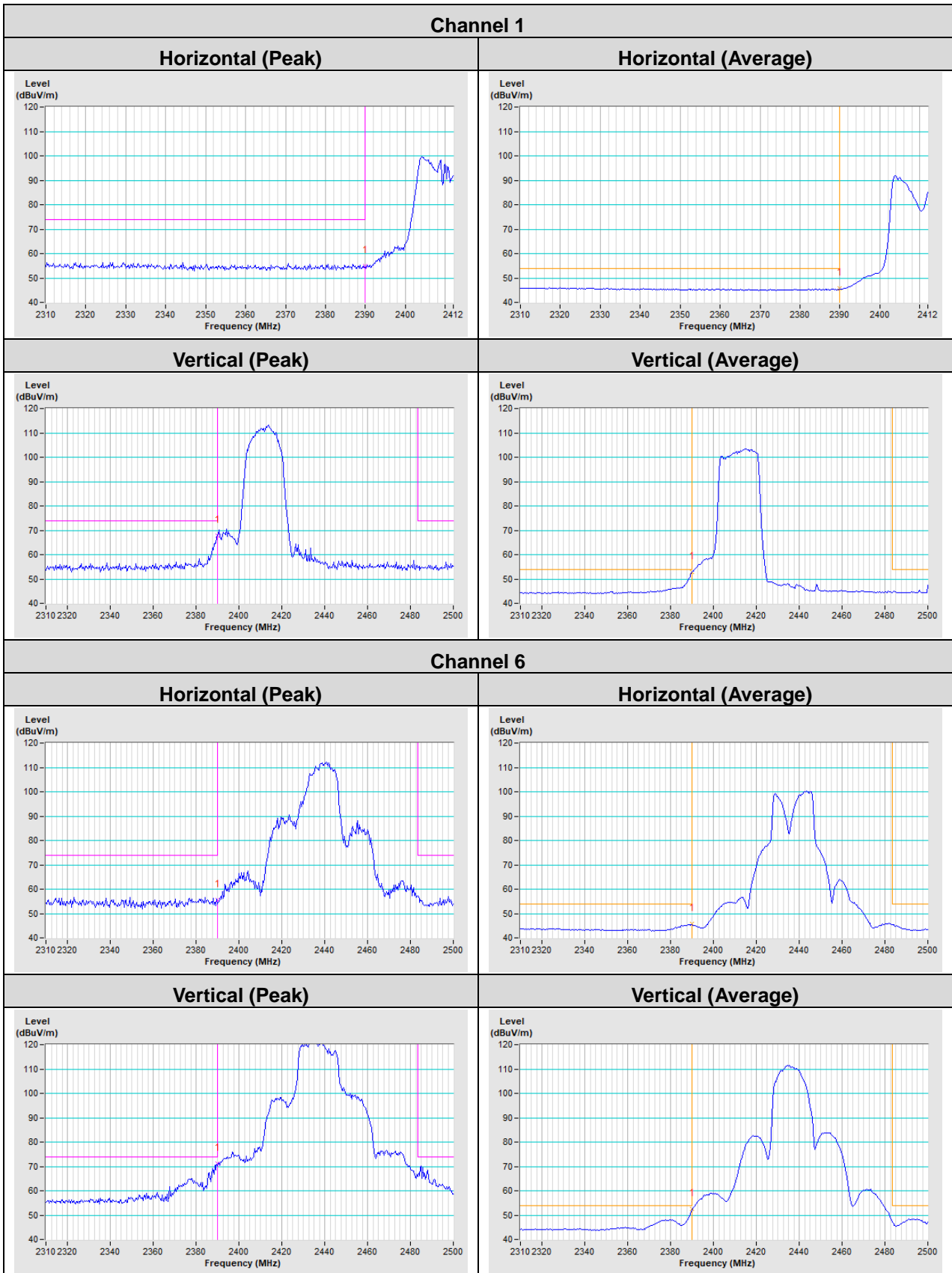

Channel 11

Horizontal (Peak)

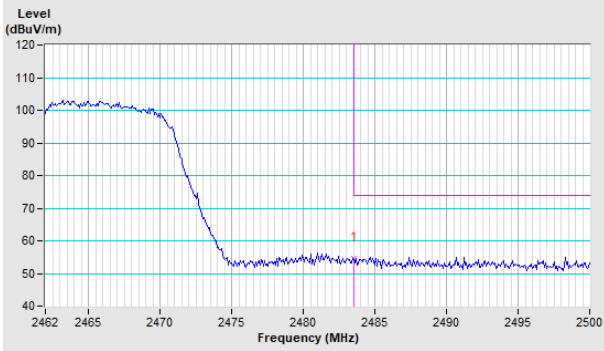

Horizontal (Average)

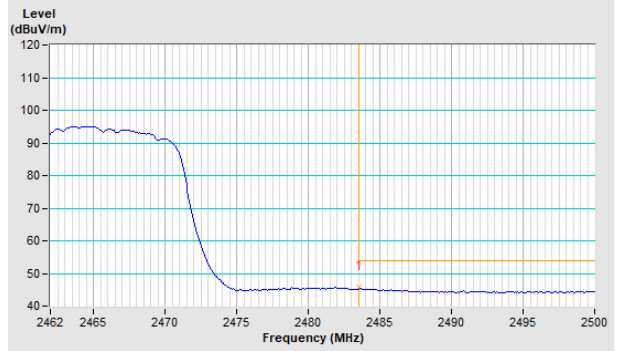

Vertical (Peak)

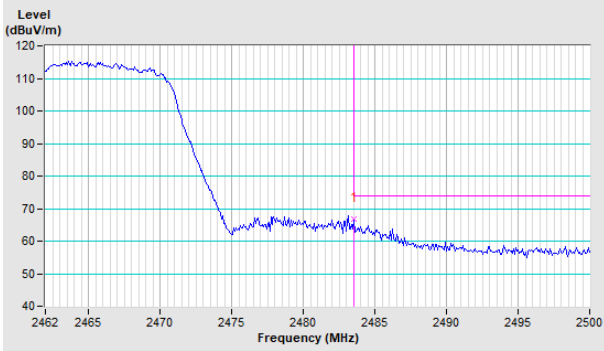

Vertical (Average)

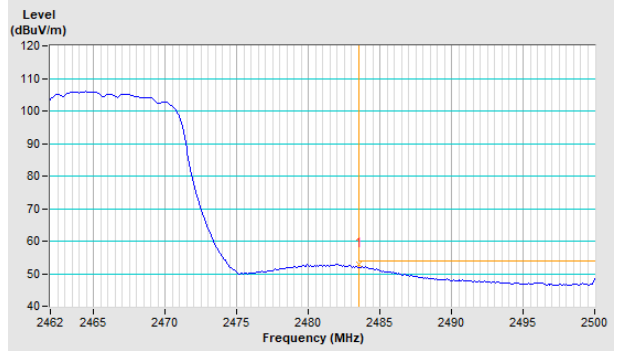

802.11n (HT40)

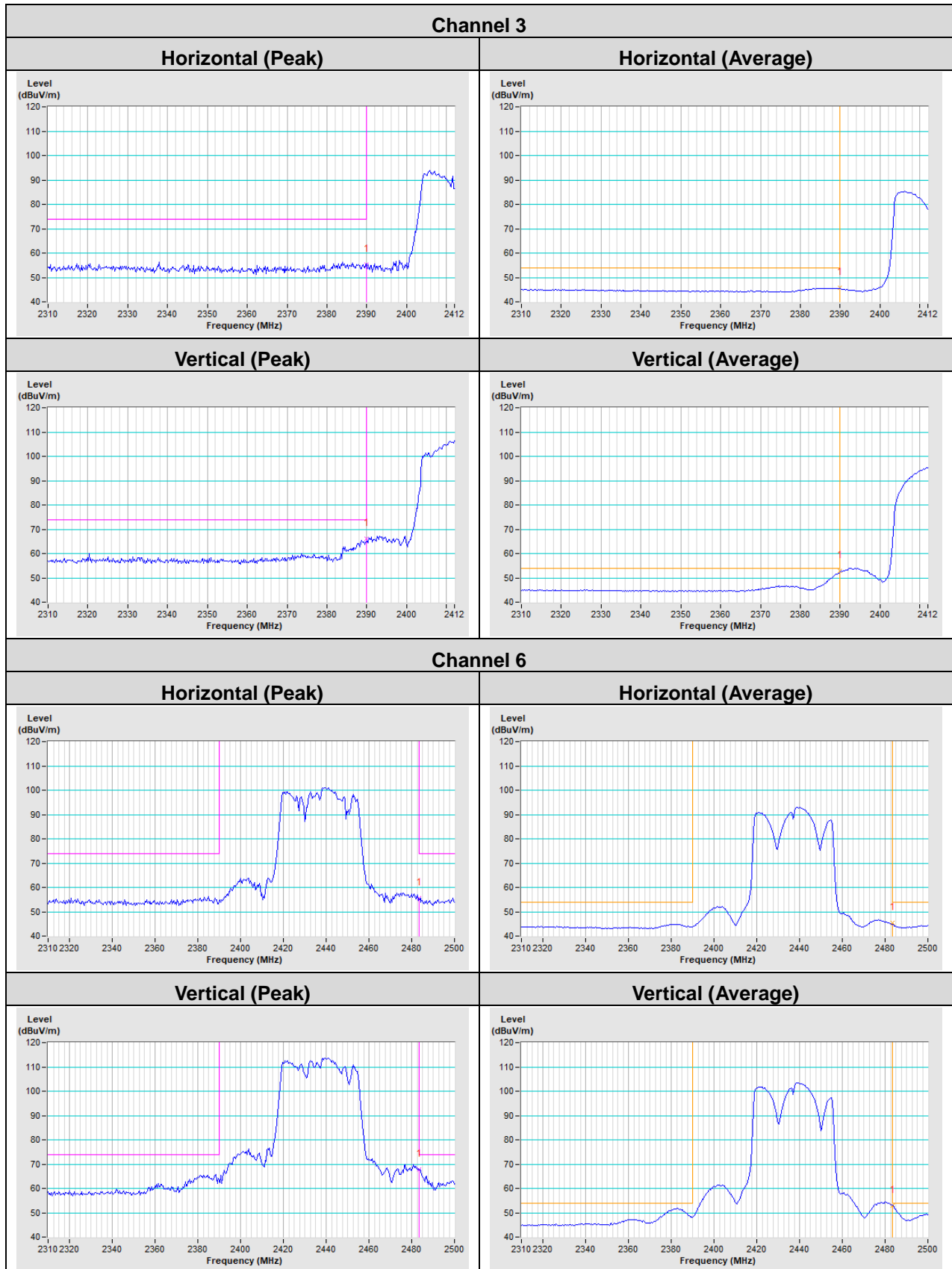

Channel 9

Horizontal (Peak)

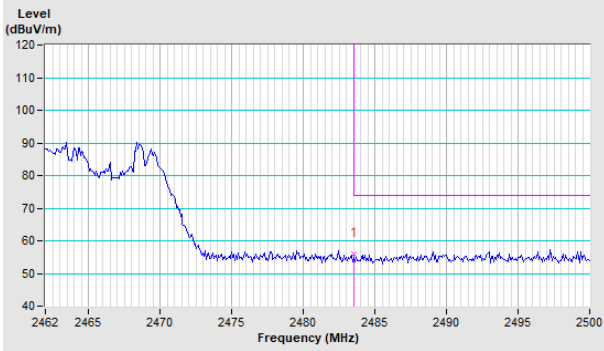

Horizontal (Average)

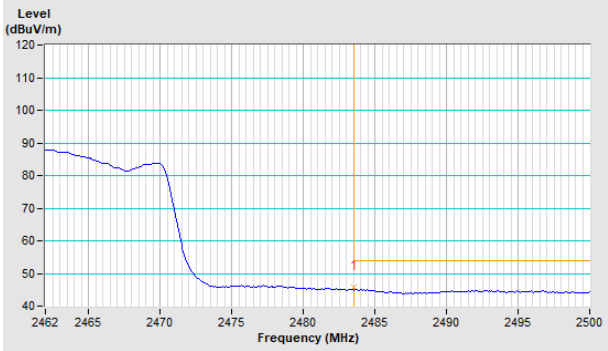

Vertical (Peak)

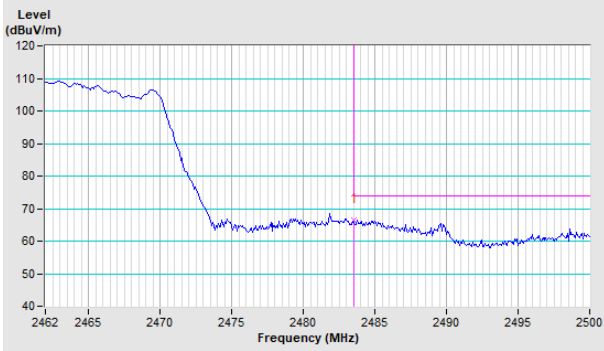

Vertical (Average)

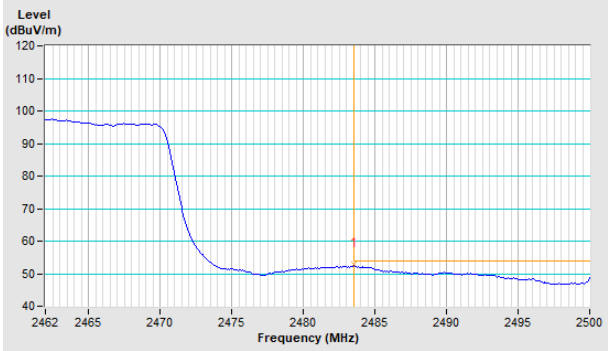

Appendix – Information of the Testing Laboratories

We, Bureau Veritas Consumer Products Services (H.K.) Ltd., Taoyuan Branch, were founded in 1988 to provide our best service in EMC, Radio, Telecom and Safety consultation. Our laboratories are FCC recognized accredited test firms and accredited according to ISO/IEC 17025.

If you have any comments, please feel free to contact us at the following:

Lin Kou EMC/RF Lab

Tel: 886-2-26052180

Fax: 886-2-26051924

Hsin Chu EMC/RF/Telecom Lab

Tel: 886-3-6668565

Fax: 886-3-6668323

Hwa Ya EMC/RF/Safety Lab

Tel: 886-3-3183232

Fax: 886-3-3270892

Email: service.adt@tw.bureauveritas.com

Web Site: www.bureauveritas-adt.com

The address and road map of all our labs can be found in our web site also.

--- END ---