

**Report No.:** RF191115E06-1

**FCC ID:** KA2BA1520PA1

**Test Model:** DBA-1520P

**Received Date:** Nov. 15, 2019

**Test Date:** Nov. 23, 2019 to Jan. 02, 2020

**Issued Date:** Feb. 24, 2020

**Applicant:** D-Link Corporation

**Address:** No.289, Xinhua 3rd Rd., Neihu District, Taipei City 11494, Taiwan

**Issued By:** Bureau Veritas Consumer Products Services (H.K.) Ltd., Taoyuan Branch  
Hsin Chu Laboratory

**Lab Address:** E-2, No.1, Li Hsin 1st Road, Hsinchu Science Park, Hsinchu City 300,  
Taiwan

**Test Location:** E-2, No.1, Li Hsin 1st Road, Hsinchu Science Park, Hsinchu City 300,  
Taiwan

**FCC Registration /  
Designation Number:** 723255 / TW2022



This report is for your exclusive use. Any copying or replication of this report to or for any other person or entity, or use of our name or trademark, is permitted only with our prior written permission. This report sets forth our findings solely with respect to the test samples identified herein. The results set forth in this report are not indicative or representative of the quality or characteristics of the lot from which a test sample was taken or any similar or identical product unless specifically and expressly noted. Our report includes all of the tests requested by you and the results thereof based upon the information that you provided to us. You have 60 days from date of issuance of this report to notify us of any material error or omission caused by our negligence, provided, however, that such notice shall be in writing and shall specifically address the issue you wish to raise. A failure to raise such issue within the prescribed time shall constitute your unqualified acceptance of the completeness of this report, the tests conducted and the correctness of the report contents. Unless specific mention, the uncertainty of measurement has been explicitly taken into account to declare the compliance or non-compliance to the specification. The report must not be used by the client to claim product certification, approval, or endorsement by TAF or any government agencies.

## Table of Contents

<b>Release Control Record</b> .....	<b>4</b>
<b>1 Certificate of Conformity</b> .....	<b>5</b>
<b>2 Summary of Test Results</b> .....	<b>6</b>
2.1 Measurement Uncertainty .....	6
2.2 Modification Record .....	6
<b>3 General Information</b> .....	<b>7</b>
3.1 General Description of EUT .....	7
3.2 Description of Test Modes .....	10
3.2.1 Test Mode Applicability and Tested Channel Detail .....	11
3.3 Duty Cycle of Test Signal .....	13
3.4 Description of Support Units .....	14
3.4.1 Configuration of System under Test .....	15
3.5 General Description of Applied Standard and references .....	17
<b>4 Test Types and Results</b> .....	<b>18</b>
4.1 Radiated Emission and Bandedge Measurement .....	18
4.1.1 Limits of Radiated Emission and Bandedge Measurement .....	18
4.1.2 Test Instruments .....	19
4.1.3 Test Procedure .....	21
4.1.4 Deviation from Test Standard .....	21
4.1.5 Test Setup .....	22
4.1.6 EUT Operating Condition .....	23
4.1.7 Test Results .....	24
4.2 Conducted Emission Measurement .....	44
4.2.1 Limits of Conducted Emission Measurement .....	44
4.2.2 Test Instruments .....	44
4.2.3 Test Procedure .....	45
4.2.4 Deviation from Test Standard .....	45
4.2.5 Test Setup .....	45
4.2.6 EUT Operating Condition .....	45
4.2.7 Test Results .....	46
4.3 Transmit Power Measurement .....	48
4.3.1 Limits of Transmit Power Measurement .....	48
4.3.2 Test Setup .....	49
4.3.3 Test Instruments .....	49
4.3.4 Test Procedure .....	49
4.3.5 Deviation from Test Standard .....	49
4.3.6 EUT Operating Condition .....	49
4.3.7 Test Result .....	50
4.4 Occupied Bandwidth Measurement .....	53
4.4.1 Test Setup .....	53
4.4.2 Test Instruments .....	53
4.4.3 Test Procedure .....	53
4.4.4 Test Results .....	54
4.5 Peak Power Spectral Density Measurement .....	60
4.5.1 Limits of Peak Power Spectral Density Measurement .....	60
4.5.2 Test Setup .....	60
4.5.3 Test Instruments .....	60
4.5.4 Test Procedure .....	60
4.5.5 Deviation from Test Standard .....	61
4.5.6 EUT Operating Condition .....	61
4.5.7 Test Results .....	62
4.6 Frequency Stability Measurement .....	68
4.6.1 Limits of Frequency Stability Measurement .....	68

4.6.2	Test Setup.....	68
4.6.3	Test Instruments .....	68
4.6.4	Test Procedure .....	68
4.6.5	Deviation from Test Standard .....	68
4.6.6	EUT Operating Condition .....	68
4.6.7	Test Results .....	69
4.7	6dB Bandwidth Measurement .....	70
4.7.1	Limits of 6dB Bandwidth Measurement.....	70
4.7.2	Test Setup.....	70
4.7.3	Test Instruments .....	70
4.7.4	Test Procedure .....	70
4.7.5	Deviation from Test Standard .....	70
4.7.6	EUT Operating Condition .....	70
4.7.7	Test Results .....	71
<b>5</b>	<b>Pictures of Test Arrangements.....</b>	<b>73</b>
	<b>Annex A- Radiated Out of Band Emission (OOBE) Measurement (For U-NII-3 band) .....</b>	<b>74</b>
	<b>Appendix – Information of the Testing Laboratories .....</b>	<b>77</b>

### Release Control Record

Issue No.	Description	Date Issued
RF191115E06-1	Original release.	Feb. 24, 2020

## 1 Certificate of Conformity

**Product:** Business Cloud Wave 2 Access Point, Nuclias Cloud-Managed AC1750 Wave 2 Access Point

**Brand:** D-Link

**Test Model:** DBA-1520P

**Sample Status:** ENGINEERING SAMPLE

**Applicant:** D-Link Corporation

**Test Date:** Nov. 23, 2019 to Jan. 02, 2020

**Standard:** 47 CFR FCC Part 15, Subpart E (Section 15.407)  
ANSI C63.10: 2013

The above equipment has been tested by **Bureau Veritas Consumer Products Services (H.K.) Ltd., Taoyuan Branch**, and found compliance with the requirement of the above standards. The test record, data evaluation & Equipment Under Test (EUT) configurations represented herein are true and accurate accounts of the measurements of the sample's EMC characteristics under the conditions specified in this report.

**Prepared by :**  , **Date:** Feb. 24, 2020  
Joyce Kuo / Specialist

**Approved by :**  , **Date:** Feb. 24, 2020  
Clark Lin / Technical Manager

## 2 Summary of Test Results

47 CFR FCC Part 15, Subpart E (Section 15.407)			
FCC Clause	Test Item	Result	Remarks
15.407(b)(6)	AC Power Conducted Emissions	PASS	Meet the requirement of limit. Minimum passing margin is -4.55dB at 0.39609MHz.
15.407(b) (1/2/3/4(i/ii)/6)	Radiated Emissions & Band Edge Measurement*	PASS	Meet the requirement of limit. Minimum passing margin is -0.2dB at 5150.00MHz and 17235.00MHz
15.407(a)(1/2/3)	Max Average Transmit Power	PASS	Meet the requirement of limit.
---	Occupied Bandwidth Measurement	-	Reference only.
15.407(a)(1/2/3)	Peak Power Spectral Density	PASS	Meet the requirement of limit.
15.407(e)	6dB bandwidth	PASS	Meet the requirement of limit. (U-NII-3 Band only)
15.407(g)	Frequency Stability	PASS	Meet the requirement of limit.
15.203	Antenna Requirement	PASS	Antenna connector is i-pex(MHF) not a standard connector.

\*For U-NII-3 band compliance with rule part 15.407(b)(4)(i), the OOB test plots were recorded in Annex A.

Note:

Determining compliance based on the results of the compliance measurement, not taking into account measurement instrumentation uncertainty.

### 2.1 Measurement Uncertainty

Where relevant, the following measurement uncertainty levels have been estimated for tests performed on the EUT as specified in CISPR 16-4-2:

Measurement	Frequency	Expanded Uncertainty (k=2) ( $\pm$ )
Conducted Emissions at mains ports	150kHz ~ 30MHz	1.8 dB
Radiated Emissions up to 1 GHz	9kHz ~ 30MHz	3.0 dB
	30MHz ~ 1GHz	4.8 dB
Radiated Emissions above 1 GHz	1GHz ~ 6GHz	5.0 dB
	6GHz ~ 18GHz	5.0 dB
	18GHz ~ 40GHz	5.3 dB

### 2.2 Modification Record

There were no modifications required for compliance.

### 3 General Information

#### 3.1 General Description of EUT

Product	Business Cloud Wave 2 Access Point, Nuclias Cloud-Managed AC1750 Wave 2 Access Point
Brand	D-Link
Test Model	DBA-1520P
Status of EUT	ENGINEERING SAMPLE
Power Supply Rating	Refer to Note
Modulation Type	CCK, DQPSK, DBPSK for DSSS 64QAM, 16QAM, QPSK, BPSK for OFDM 256QAM for OFDM in 11ac mode only
Modulation Technology	DSSS, OFDM
Transfer Rate	802.11b: up to 11Mbps 802.11a/g: up to 54Mbps 802.11n: up to 450Mbps 802.11ac: up to 1300Mbps
Operating Frequency	<b>2.4GHz:</b> 2.412 ~ 2.462 GHz <b>5GHz:</b> 5.18~ 5.24 GHz, 5.745 ~ 5.825 GHz
Number of Channel	<b>2.4GHz:</b> 802.11b, 802.11g, 802.11n (HT20): 11 802.11n (HT40): 7 <b>5GHz:</b> 802.11a, 802.11n (HT20), 802.11ac (VHT20): 9 802.11n (HT40), 802.11ac (VHT40): 4 802.11ac (VHT80): 2
Output Power	<b>2.412 ~ 2.462GHz:</b> 801.158 mW <b>CDD Mode:</b> <b>5.18 ~ 5.24GHz:</b> 555.87 mW <b>5.745 ~ 5.825GHz:</b> 687.313 mW <b>Beamforming Mode:</b> <b>5.18 ~ 5.24GHz:</b> 473.554 mW <b>5.745 ~ 5.825GHz:</b> 425.822 mW
Antenna Type	Refer to Note
Antenna Connector	Refer to Note
Accessory Device	Adapter x1
Data Cable Supplied	NA

Note:

1. Simultaneously transmission condition.

Condition	Technology	
1	WLAN (2.4GHz)	WLAN (5GHz)

Note: The emission of the simultaneous operation has been evaluated and no non-compliance was found.

2. The EUT must be supplied with a power adapter as following table:

No.	Brand	Model No.	Spec.	Plug
1	Asian Power Devices Inc.	WA-30P12R	AC Input: 100-240Vac, 0.9A, 50/60Hz DC Output: 12V, 2.5A DC Output Cable: 1.2m, Unshielded	US/EU/UK
POE Adapter (Not for sale)				
2	LEI	MU24A5480050-A1	AC Input: 100-240Vac, 0.7A, 50/60Hz DC Output: 48V, 0.5A DC Output Cable: 1.2m, Unshielded	US/EU

Note: From the above conditions, the conducted emissions and radiated emissions worse case was found in POE Adapter. Therefore only the test data of the mode was recorded in this report.

3. The antennas provided to the EUT, please refer to the following table:

Antenna NO.	Brand	Model	Antenna Net Gain(dBi)	Frequency range	Antenna Type	Connector Type	Cable Length (mm)
ANT_1	Hongbo	290-20404	4.58	2.4~2.4835GHz	PIFA	i-pex(MHF)	80
			3.86	5.15~5.25GHz			
			4.69	5.25~5.35GHz			
			4.95	5.47~5.725GHz			
ANT_2	Hongbo	290-20405	4.95	5.725~5.85GHz	PIFA	i-pex(MHF)	90
			3.33	2.4~2.4835GHz			
			4.81	5.15~5.25GHz			
			4.55	5.25~5.35GHz			
ANT_3	Hongbo	290-20406	4.54	5.47~5.725GHz	PIFA	i-pex(MHF)	120
			4.82	5.725~5.85GHz			
			2.81	2.4~2.4835GHz			
			4.71	5.15~5.25GHz			
			4.75	5.25~5.35GHz			
			4.68	5.47~5.725GHz			
			4.73	5.725~5.85GHz			

4. The EUT incorporates a MIMO function:

2.4GHz Band		
MODULATION MODE	TX & RX CONFIGURATION	
802.11b	3TX	3RX
802.11g	3TX	3RX
802.11n (HT20)	3TX	3RX
802.11n (HT40)	3TX	3RX
5GHz Band		
MODULATION MODE	TX & RX CONFIGURATION	
802.11a	3TX	3RX
802.11n (HT20)	3TX	3RX
802.11n (HT40)	3TX	3RX
802.11ac (VHT20)	3TX	3RX
802.11ac (VHT40)	3TX	3RX
802.11ac (VHT80)	3TX	3RX

Note:

- All of modulation mode support beamforming function except 2.4GHz and 802.11a modulation mode.
- The EUT support Beamforming and CDD mode, therefore both mode were investigated and the worst case scenario was identified. The worst case data were presented in test report.
- The modulation and bandwidth are similar for 802.11n mode for 20MHz (40MHz) and 802.11ac mode for 20MHz (40MHz), therefore investigated worst case to representative mode in test report. (Final test mode refer section 3.2.1)



The above EUT information is declared by manufacturer and for more detailed features description, please refer to the manufacturer's specifications or user's manual.

### 3.2 Description of Test Modes

#### FOR 5180 ~ 5240MHz

4 channels are provided for 802.11a, 802.11n (HT20), 802.11ac (VHT20):

Channel	Frequency	Channel	Frequency
36	5180 MHz	44	5220 MHz
40	5200 MHz	48	5240 MHz

2 channels are provided for 802.11n (HT40), 802.11ac (VHT40):

Channel	Frequency	Channel	Frequency
38	5190 MHz	46	5230 MHz

1 channel is provided for 802.11ac (VHT80):

Channel	Frequency
42	5210 MHz

#### FOR 5745 ~ 5825MHz:

5 channels are provided for 802.11a, 802.11n (HT20), 802.11ac (VHT20):

Channel	Frequency	Channel	Frequency
149	5745 MHz	161	5805 MHz
153	5765 MHz	165	5825 MHz
157	5785 MHz		

2 channels are provided for 802.11n (HT40), 802.11ac (VHT40):

Channel	Frequency	Channel	Frequency
151	5755 MHz	159	5795 MHz

1 channel is provided for 802.11ac (VHT80):

Channel	Frequency
155	5775 MHz

### 3.2.1 Test Mode Applicability and Tested Channel Detail

EUT Configure Mode	Applicable To				Description
	RE $\geq$ 1G	RE $<$ 1G	PLC	APCM	
-	√	√	√	√	-

Where **RE $\geq$ 1G**: Radiated Emission above 1GHz      **RE $<$ 1G**: Radiated Emission below 1GHz  
**PLC**: Power Line Conducted Emission      **APCM**: Antenna Port Conducted Measurement

**Note:** The EUT had been pre-tested on the positioned of laying-flat and wall-mount. The worst case was found when positioned of on **laying-flat** (for below 1GHz) and **wall-mount** (for above 1GHz).

#### **Radiated Emission Test (Above 1GHz):**

- Pre-Scan has been conducted to determine the worst-case mode from all possible combinations between available modulations, data rates and antenna ports (if EUT with antenna diversity architecture).
- Following channel(s) was (were) selected for the final test as listed below.

CDD Mode						
Mode	FREQ. Band (MHz)	Available Channel	Tested Channel	Modulation Technology	Modulation Type	Data Rate (Mbps)
802.11a	5180-5240	36 to 48	36, 40, 48	OFDM	BPSK	6
802.11ac (VHT20)		36 to 48	36, 40, 48	OFDM	BPSK	6.5
802.11ac (VHT40)		38 to 46	38, 46	OFDM	BPSK	13.5
802.11ac (VHT80)		42	42	OFDM	BPSK	29.3
802.11a	5745-5825	149 to 165	149, 157, 165	OFDM	BPSK	6
802.11ac (VHT20)		149 to 165	149, 157, 165	OFDM	BPSK	6.5
802.11ac (VHT40)		151 to 159	151, 159	OFDM	BPSK	13.5
802.11ac (VHT80)		155	155	OFDM	BPSK	29.3

#### **Radiated Emission Test (Below 1GHz):**

- Pre-Scan has been conducted to determine the worst-case mode from all possible combinations between available modulations, data rates and antenna ports (if EUT with antenna diversity architecture).
- Following channel(s) was (were) selected for the final test as listed below.

CDD Mode						
Mode	FREQ. Band (MHz)	Available Channel	Tested Channel	Modulation Technology	Modulation Type	Data Rate (Mbps)
802.11a	5180-5240 5745-5825	38 to 46 149 to 165	149	OFDM	BPSK	6

### Power Line Conducted Emission Test:

- Pre-Scan has been conducted to determine the worst-case mode from all possible combinations between available modulations, data rates and antenna ports (if EUT with antenna diversity architecture).
- Following channel(s) was (were) selected for the final test as listed below.

CDD Mode						
Mode	FREQ. Band (MHz)	Available Channel	Tested Channel	Modulation Technology	Modulation Type	Data Rate (Mbps)
802.11a	5180-5240 5745-5825	38 to 46 149 to 165	149	OFDM	BPSK	6

### Antenna Port Conducted Measurement:

- This item includes all test value of each mode, but only includes spectrum plot of worst value of each mode.
- Pre-Scan has been conducted to determine the worst-case mode from all possible combinations between available modulations, data rates and antenna ports (if EUT with antenna diversity architecture).
- Following channel(s) was (were) selected for the final test as listed below.

CDD Mode						
Mode	FREQ. Band (MHz)	Available Channel	Tested Channel	Modulation Technology	Modulation Type	Data Rate (Mbps)
802.11a	5180-5240	36 to 48	36, 40, 48	OFDM	BPSK	6
802.11ac (VHT20)		36 to 48	36, 40, 48	OFDM	BPSK	6.5
802.11ac (VHT40)		38 to 46	38, 46	OFDM	BPSK	13.5
802.11ac (VHT80)		42	42	OFDM	BPSK	29.3
802.11a	5745-5825	149 to 165	149, 157, 165	OFDM	BPSK	6
802.11ac (VHT20)		149 to 165	149, 157, 165	OFDM	BPSK	6.5
802.11ac (VHT40)		151 to 159	151, 159	OFDM	BPSK	13.5
802.11ac (VHT80)		155	155	OFDM	BPSK	29.3
Beamforming Mode (output power only)						
Mode	FREQ. Band (MHz)	Available Channel	Tested Channel	Modulation Technology	Modulation Type	Data Rate (Mbps)
802.11ac (VHT20)	5180-5240	36 to 48	36, 40, 48	OFDM	BPSK	6.5
802.11ac (VHT40)		38 to 46	38, 46	OFDM	BPSK	13.5
802.11ac (VHT80)		42	42	OFDM	BPSK	29.3
802.11ac (VHT20)	5745-5825	149 to 165	149, 157, 165	OFDM	BPSK	6.5
802.11ac (VHT40)		151 to 159	151, 159	OFDM	BPSK	13.5
802.11ac (VHT80)		155	155	OFDM	BPSK	29.3

### Test Condition:

Applicable To	Environmental Conditions	Input Power	Tested By
RE $\geq$ 1G	24deg. C, 65%RH	120Vac, 60Hz	Nelson Teng
RE $<$ 1G	25deg. C, 67%RH	120Vac, 60Hz	Tom Yang
PLC	25deg. C, 75%RH	120Vac, 60Hz	Andy Ho
APCM	25deg. C, 60%RH	120Vac, 60Hz	Anderson Chen

### 3.3 Duty Cycle of Test Signal

If duty cycle of test signal is  $\geq 98\%$ , duty factor is not required.

If duty cycle of test signal is  $< 98\%$ , duty factor shall be considered.

**802.11a:** Duty cycle =  $2.024/2.094 = 0.967$ , Duty factor =  $10 * \log(1/ \text{Duty cycle}) = 0.15$

**802.11ac (VHT20):** Duty cycle =  $4.965/5.05 = 0.983$

**802.11ac (VHT40):** Duty cycle =  $2.408/2.493 = 0.966$ , Duty factor =  $10 * \log(1/ \text{Duty cycle}) = 0.15$

**802.11ac (VHT80):** Duty cycle =  $1.134/1.206 = 0.94$ , Duty factor =  $10 * \log(1/ \text{Duty cycle}) = 0.27$

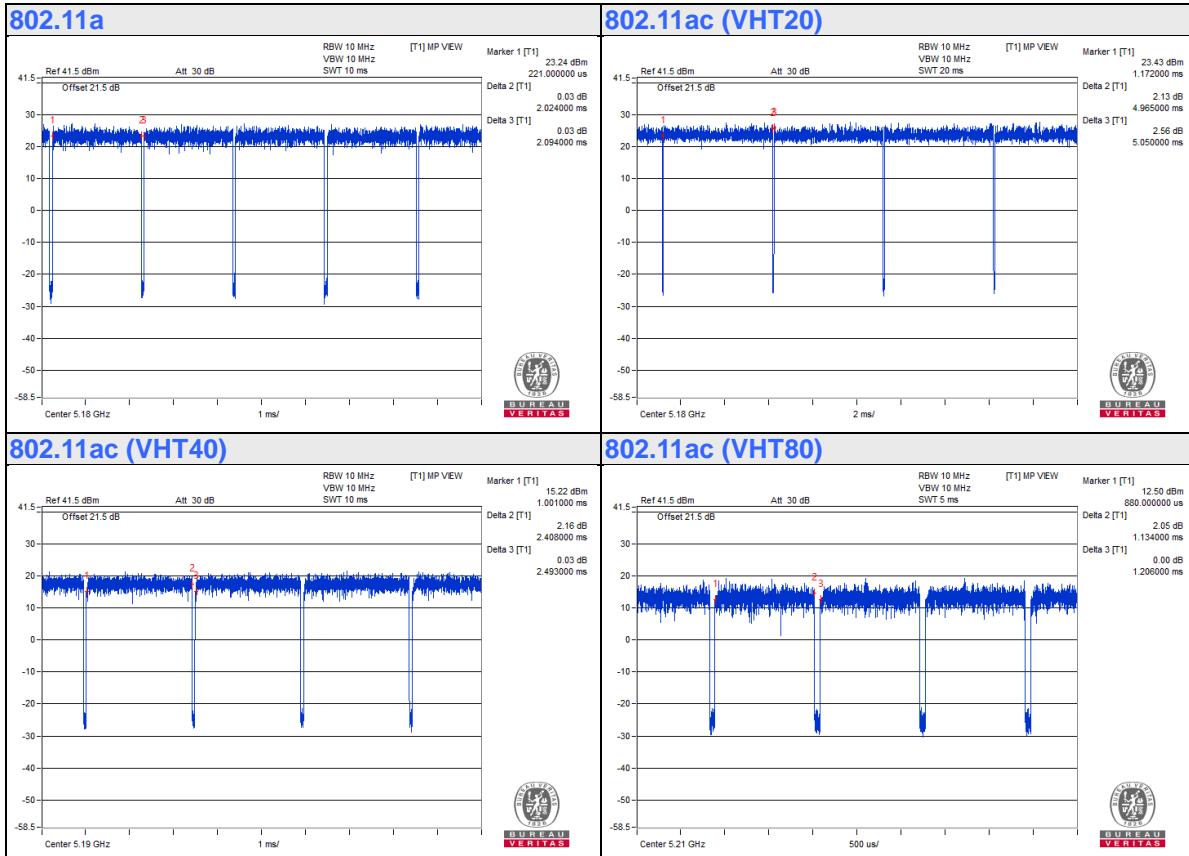

### 3.4 Description of Support Units

The EUT has been tested as an independent unit together with other necessary accessories or support units. The following support units or accessories were used to form a representative test configuration during the tests.

ID	Product	Brand	Model No.	Serial No.	FCC ID	Remarks
A.	POE	D-Link	NA	NA	NA	Supplied by client
B.	POE Adapter	LEI	MU24A5480050-A1	NA	NA	Supplied by client
C.	Laptop	DELL	E6420	B92T3R1	FCC DoC	Provided by Lab

Note:

1. All power cords of the above support units are non-shielded (1.8m).

ID	Descriptions	Qty.	Length (m)	Shielding (Yes/No)	Cores (Qty.)	Remarks
1.	RJ-45 Cable	1	10	No	0	Provided by Lab
2.	Console Cable	1	1.5	No	0	Provided by Lab
3.	DC Cable	1	1.2	No	0	Supplied by client
4.	RJ-45 Cable	1	1.5	No	0	Provided by Lab

### 3.4.1 Configuration of System under Test For Radiation:

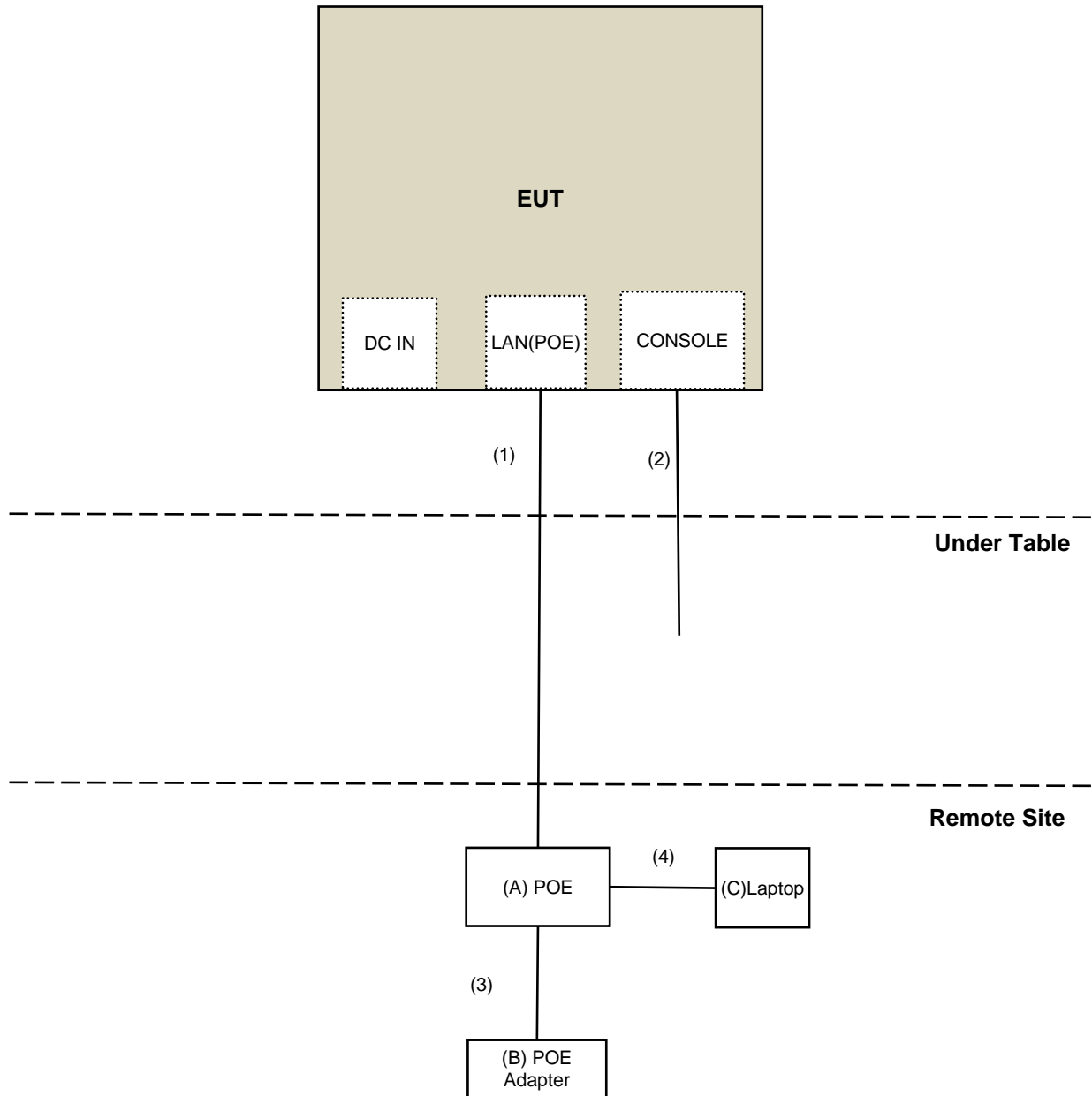

For Conduction:

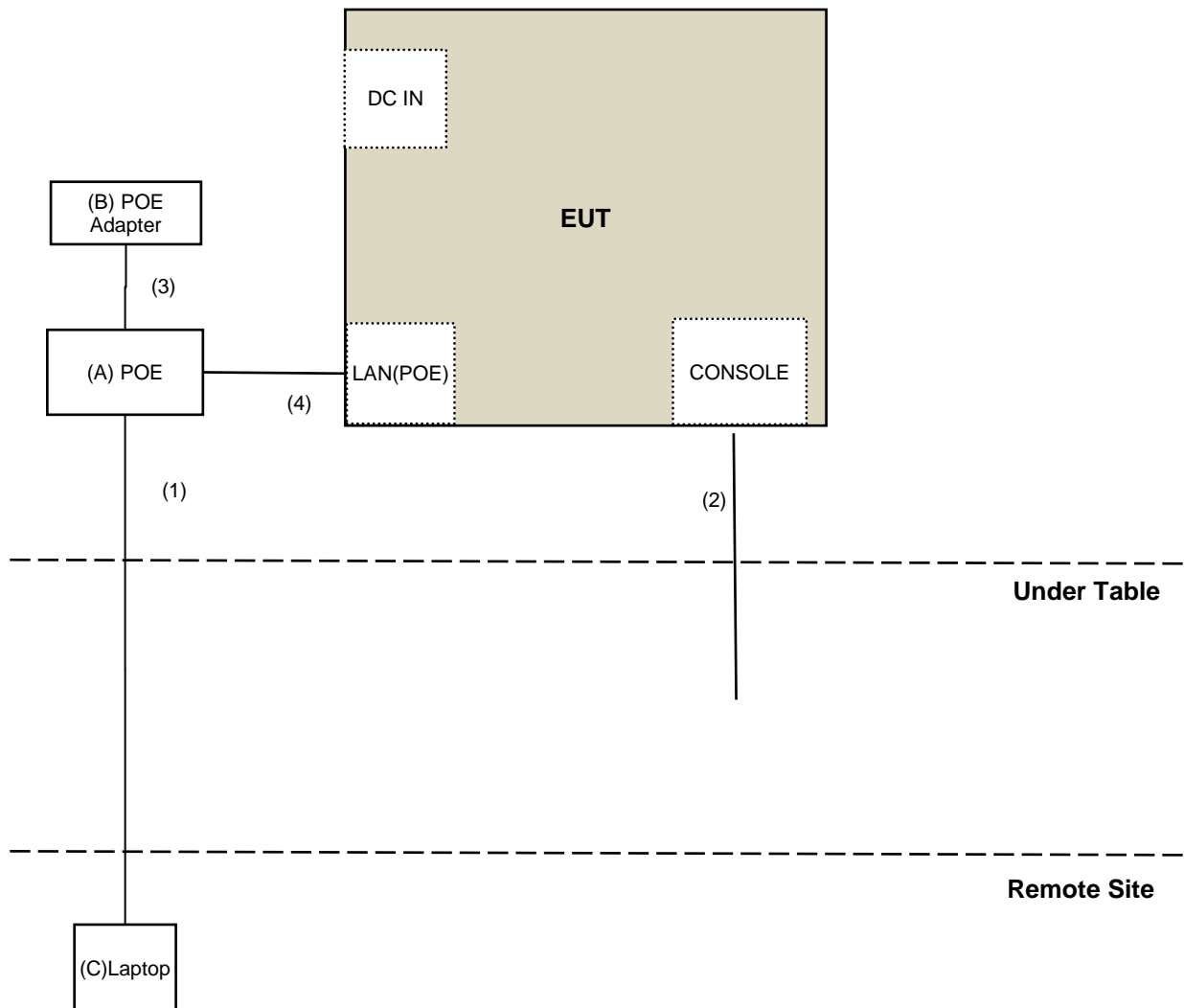



### 3.5 General Description of Applied Standard and references

The EUT is a RF Product. According to the specifications of the manufacturer, it must comply with the requirements of the following standards and references:

**Test standard:**

**FCC Part 15, Subpart E (15.407)**  
**ANSI C63.10-2013**

All test items have been performed and recorded as per the above standards.

**References Test Guidance:**

**KDB 789033 D02 General UNII Test Procedure New Rules v02r01**  
**KDB 662911 D01 Multiple Transmitter Output v02r01**

All test items have been performed as a reference to the above KDB test guidance.

## 4 Test Types and Results

### 4.1 Radiated Emission and Bandedge Measurement

#### 4.1.1 Limits of Radiated Emission and Bandedge Measurement

Radiated emissions which fall in the restricted bands must comply with the radiated emission limits specified as below table.

Frequencies (MHz)	Field Strength (microvolts/meter)	Measurement Distance (meters)
0.009 ~ 0.490	2400/F(kHz)	300
0.490 ~ 1.705	24000/F(kHz)	30
1.705 ~ 30.0	30	30
30 ~ 88	100	3
88 ~ 216	150	3
216 ~ 960	200	3
Above 960	500	3

#### NOTE:

- The lower limit shall apply at the transition frequencies.
- Emission level (dBuV/m) = 20 log Emission level (uV/m).
- For frequencies above 1000MHz, the field strength limits are based on average detector, however, the peak field strength of any emission shall not exceed the maximum permitted average limits, specified above by more than 20dB under any condition of modulation.

Limits of unwanted emission out of the restricted bands

Applicable To		Limit	
789033 D02 General UNII Test Procedure New Rules v02r01		Field Strength at 3m	
		PK:74 (dBμV/m)	AV:54 (dBμV/m)
Frequency Band	Applicable To	EIRP Limit	Equivalent Field Strength at 3m
5150~5250 MHz	15.407(b)(1)	PK:-27 (dBm/MHz)	PK:68.2(dBμV/m)
5250~5350 MHz	15.407(b)(2)		
5470~5725 MHz	15.407(b)(3)		
5725~5850 MHz	<input checked="" type="checkbox"/> 15.407(b)(4)(i)	PK:-27 (dBm/MHz) <sup>*1</sup> PK:10 (dBm/MHz) <sup>*2</sup> PK:15.6 (dBm/MHz) <sup>*3</sup> PK:27 (dBm/MHz) <sup>*4</sup>	PK: 68.2(dBμV/m) <sup>*1</sup> PK:105.2 (dBμV/m) <sup>*2</sup> PK: 110.8(dBμV/m) <sup>*3</sup> PK:122.2 (dBμV/m) <sup>*4</sup>
	<input type="checkbox"/> 15.407(b)(4)(ii)	Emission limits in section 15.247(d)	
*1 beyond 75 MHz or more above of the band edge.		*2 below the band edge increasing linearly to 10 dBm/MHz at 25 MHz above.	
*3 below the band edge increasing linearly to a level of 15.6 dBm/MHz at 5 MHz above.		*4 from 5 MHz above or below the band edge increasing linearly to a level of 27 dBm/MHz at the band edge.	

#### Note:

The following formula is used to convert the equipment isotropic radiated power (eirp) to field strength:

$$E = \frac{1000000\sqrt{30P}}{3} \mu\text{V/m, where P is the eirp (Watts).}$$

#### 4.1.2 Test Instruments

##### For OOB test:

DESCRIPTION & MANUFACTURER	MODEL NO.	SERIAL NO.	CALIBRATED DATE	CALIBRATED UNTIL
Test Receiver ESR7 R&S	ESR7	102026	Apr. 24, 2019	Apr. 23, 2020
Spectrum Analyzer Keysight	N9030B	MY57141948	May 25, 2019	May 24, 2020
Horn_Antenna SCHWARZBECK	BBHA 9120D	9120D-1819	Nov. 25, 2018	Nov. 24, 2019
Pre-Amplifier EMCI	EMC12630SE	980509	May 03, 2019	May 02, 2020
RF Cable EMCI	EMC104-SM-SM-1500	180503	May 03, 2019	May 02, 2020
RF Cable EMCI	EMC104-SM-SM-2000	180501	May 03, 2019	May 02, 2020
RF Cable EMCI	EMC104-SM-SM-6000	180505	May 03, 2019	May 02, 2020
Pre-Amplifier EMCI	EMC184045SE	980387	Jan. 28, 2019	Jan. 27, 2020
Horn_Antenna SCHWARZBECK	BBHA 9170	BBHA9170519	Nov. 25, 2018	Nov. 24, 2019
RF Cable	EMC102-KM-KM-1200	160924	Jan. 28, 2019	Jan. 27, 2020
RF Cable	EMC102-KM-KM-1200	160925	Jan. 28, 2019	Jan. 27, 2020
Software	ADT_Radiated_V8.7.08	NA	NA	NA
Boresight Antenna Tower & Turn Table Max-Full	MF-7802BS	MF780208530	NA	NA

##### Note:

1. The calibration interval of the above test instruments is 12 months and the calibrations are traceable to NML/ROC and NIST/USA.
2. The test was performed in 966 Chamber No. 5.
3. Loop antenna was used for all emissions below 30 MHz.
4. Tested Date: Nov. 23, 2019

**For other test:**

DESCRIPTION & MANUFACTURER	MODEL NO.	SERIAL NO.	CALIBRATED DATE	CALIBRATED UNTIL
Test Receiver ESR7 R&S	ESR7	102026	Apr. 24, 2019	Apr. 23, 2020
Spectrum Analyzer Keysight	N9030B	MY57141948	May 25, 2019	May 24, 2020
Pre-Amplifier EMCI	EMC001340	980142	May 30, 2019	May 29, 2020
Loop Antenna Electro-Metrics	EM-6879	264	Jan. 22, 2019	Jan. 21, 2020
RF Cable	NA	LOOPCAB-001	Jan. 14, 2019	Jan. 13, 2020
RF Cable	NA	LOOPCAB-002	Jan. 14, 2019	Jan. 13, 2020
Pre-Amplifier EMCI	EMC330N	980538	Apr. 30, 2019	Apr. 29, 2020
Trilog Broadband Antenna SCHWARZBECK	VULB9168	9168-0842	Nov. 08, 2019	Nov. 07, 2020
RF Cable	8D	966-5-1	May 03, 2019	May 02, 2020
RF Cable	8D	966-5-2	May 03, 2019	May 02, 2020
RF Cable	8D	966-5-3	May 03, 2019	May 02, 2020
Fixed attenuator Mini-Circuits	UNAT-5+	PAD-ATT5-02	Jan. 28, 2019	Jan. 27, 2020
Horn_Antenna SCHWARZBECK	BBHA 9120D	9120D-1819	Nov. 24, 2019	Nov. 23, 2020
Pre-Amplifier EMCI	EMC12630SE	980509	May 03, 2019	May 02, 2020
RF Cable EMCI	EMC104-SM-SM-1500	180503	May 03, 2019	May 02, 2020
RF Cable EMCI	EMC104-SM-SM-2000	180501	May 03, 2019	May 02, 2020
RF Cable EMCI	EMC104-SM-SM-6000	180505	May 03, 2019	May 02, 2020
Pre-Amplifier EMCI	EMC184045SE	980387	Jan. 28, 2019	Jan. 27, 2020
Horn_Antenna SCHWARZBECK	BBHA 9170	BBHA9170519	Nov. 24, 2019	Nov. 23, 2020
RF Cable	EMC102-KM-KM-1200	160924	Jan. 28, 2019	Jan. 27, 2020
RF Cable	EMC102-KM-KM-1200	160925	Jan. 28, 2019	Jan. 27, 2020
Software	ADT_Radiated_V8.7.08	NA	NA	NA
Boresight Antenna Tower & Turn Table Max-Full	MF-7802BS	MF780208530	NA	NA
Spectrum Analyzer R&S	FSV40	100964	June 04, 2019	June 03, 2020
Power meter Anritsu	ML2495A	1014008	May 13, 2019	May 12, 2020
Power sensor Anritsu	MA2411B	0917122	May 13, 2019	May 12, 2020
Fixed Attenuator Mini-Circuits	MDCS18N-10	MDCS18N-10-01	Apr. 15, 2019	Apr. 14, 2020

**Note:**

1. The calibration interval of the above test instruments is 12 months and the calibrations are traceable to NML/ROC and NIST/USA.
2. The test was performed in 966 Chamber No. 5.
3. Loop antenna was used for all emissions below 30 MHz.
4. Tested Date: Dec. 26, 2019 to Jan. 02, 2020

#### 4.1.3 Test Procedure

##### **For Radiated emission below 30MHz**

- a. The EUT was placed on the top of a rotating table 0.8 meters above the ground at a 3 meter chamber room. The table was rotated 360 degrees to determine the position of the highest radiation.
- b. The EUT was set 3 meters away from the interference-receiving antenna, which was mounted on the top of a variable-height antenna tower.
- c. Parallel, perpendicular, and ground-parallel orientations of the antenna are set to make the measurement.
- d. For each suspected emission, the EUT was arranged to its worst case and the rotatable table was turned from 0 degrees to 360 degrees to find the maximum reading.
- e. The test-receiver system was set to Quasi-Peak Detect Function and Specified Bandwidth with Maximum Hold Mode.

##### **NOTE:**

1. The resolution bandwidth and video bandwidth of test receiver/spectrum analyzer is 9kHz at frequency below 30MHz.

##### **For Radiated emission above 30MHz**

- a. The EUT was placed on the top of a rotating table 0.8 meters (for 30MHz ~ 1GHz) / 1.5 meters (for above 1GHz) above the ground at 3 meter chamber room for test. The table was rotated 360 degrees to determine the position of the highest radiation.
- b. The EUT was set 3 meters away from the interference-receiving antenna, which was mounted on the top of a variable-height antenna tower.
- c. The height of antenna is varied from one meter to four meters above the ground to determine the maximum value of the field strength. Both horizontal and vertical polarizations of the antenna are set to make the measurement.
- d. For each suspected emission, the EUT was arranged to its worst case and then the antenna was tuned to heights from 1 meter to 4 meters and the rotatable table was turned from 0 degrees to 360 degrees to find the maximum reading.
- e. The test-receiver system was set to quasi-peak detect function and specified bandwidth with maximum hold mode when the test frequency is below 1 GHz.
- f. The test-receiver system was set to peak and average detects function and specified bandwidth with maximum hold mode when the test frequency is above 1 GHz. If the peak reading value also meets average limit, measurement with the average detector is unnecessary.

##### **Note:**

1. The resolution bandwidth and video bandwidth of test receiver/spectrum analyzer is 120kHz for Quasi-peak detection (QP) at frequency below 1GHz.
2. The resolution bandwidth of test receiver/spectrum analyzer is 1 MHz and the video bandwidth is 3 MHz for Peak detection (PK) at frequency above 1GHz.
3. The resolution bandwidth of test receiver/spectrum analyzer is 1MHz and the video bandwidth is  $\geq 1/T$  (Duty cycle < 98%) or 10Hz (Duty cycle  $\geq 98\%$ ) for Average detection (AV) at frequency above 1GHz.
4. All modes of operation were investigated and the worst-case emissions are reported.

#### 4.1.4 Deviation from Test Standard

No deviation.

4.1.5 Test Setup

**For Radiated emission below 30MHz**

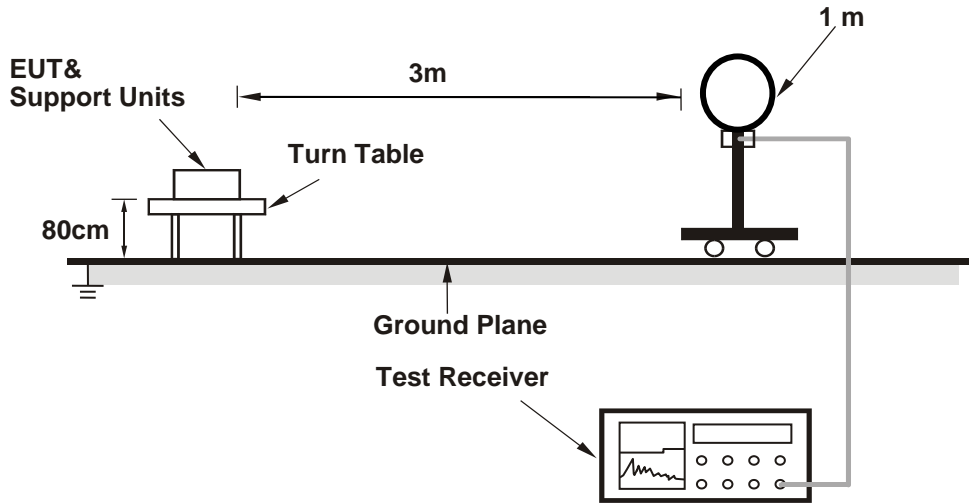

**For Radiated emission 30MHz to 1GHz**

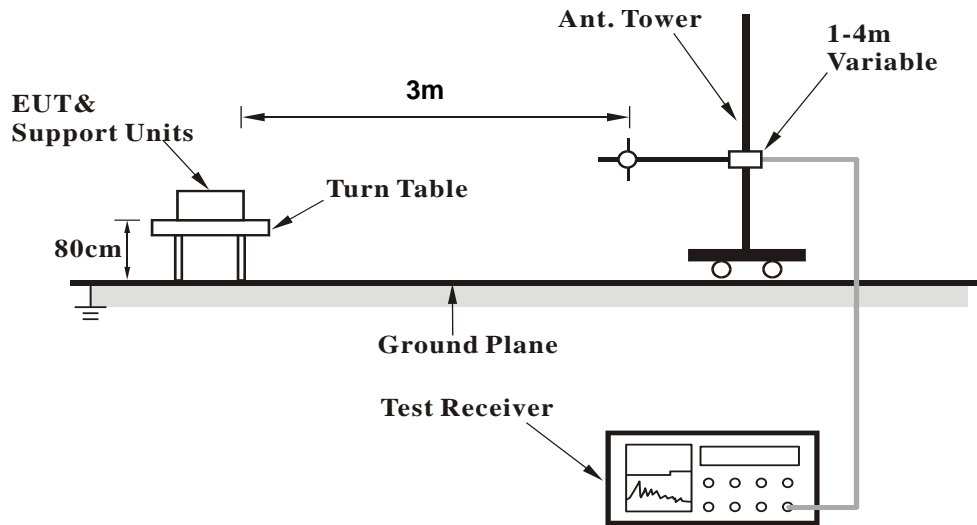

### For Radiated emission above 1GHz

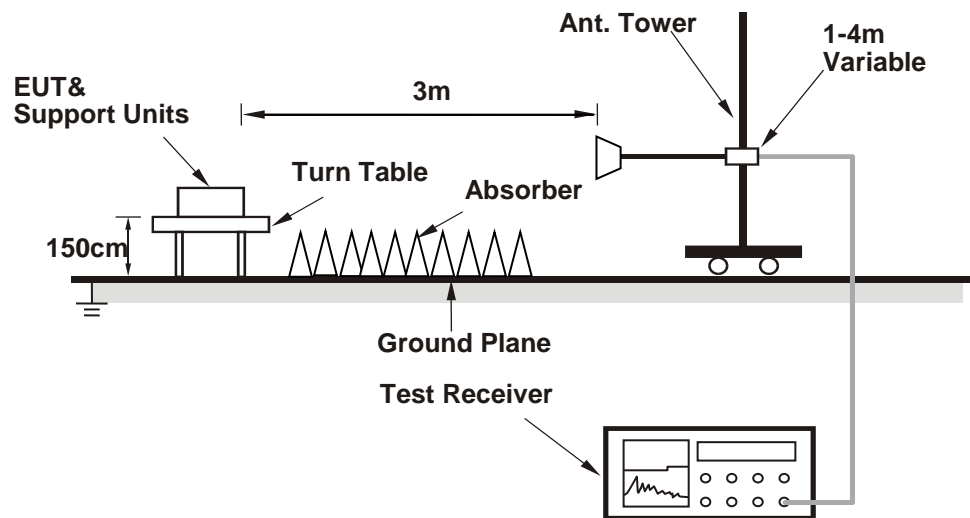

For the actual test configuration, please refer to the attached file (Test Setup Photo).

#### 4.1.6 EUT Operating Condition

- a. Connected the EUT with the Laptop which is placed on remote site.
- b. Controlling software (QDART-Connectivity(1.0.38)) has been activated to set the EUT under transmission condition continuously at specific channel frequency.

## 4.1.7 Test Results

## Above 1GHz Data:

## 802.11a

<b>CHANNEL</b>	TX Channel 36	<b>DETECTOR FUNCTION</b>	Peak (PK)
<b>FREQUENCY RANGE</b>	1GHz ~ 40GHz		Average (AV)

ANTENNA POLARITY & TEST DISTANCE: HORIZONTAL AT 3 M								
NO.	FREQ. (MHz)	EMISSION LEVEL (dBuV/m)	LIMIT (dBuV/m)	MARGIN (dB)	ANTENNA HEIGHT (m)	TABLE ANGLE (Degree)	RAW VALUE (dBuV)	CORRECTION FACTOR (dB/m)
1	5150.00	66.5 PK	74.0	-7.5	2.57 H	13	64.6	1.9
2	5150.00	52.4 AV	54.0	-1.6	2.57 H	13	50.5	1.9
3	*5180.00	118.9 PK			2.57 H	13	117.2	1.7
4	*5180.00	109.4 AV			2.57 H	13	107.7	1.7
5	#10360.00	57.8 PK	68.2	-10.4	3.09 H	107	45.7	12.1
6	15540.00	68.7 PK	74.0	-5.3	2.53 H	111	56.6	12.1
7	15540.00	53.0 AV	54.0	-1.0	2.53 H	111	40.9	12.1

ANTENNA POLARITY & TEST DISTANCE: VERTICAL AT 3 M								
NO.	FREQ. (MHz)	EMISSION LEVEL (dBuV/m)	LIMIT (dBuV/m)	MARGIN (dB)	ANTENNA HEIGHT (m)	TABLE ANGLE (Degree)	RAW VALUE (dBuV)	CORRECTION FACTOR (dB/m)
1	5150.00	66.7 PK	74.0	-7.3	2.04 V	350	64.8	1.9
2	5150.00	53.7 AV	54.0	-0.3	2.04 V	350	51.8	1.9
3	*5180.00	120.4 PK			2.04 V	350	118.7	1.7
4	*5180.00	110.0 AV			2.04 V	350	108.3	1.7
5	#10360.00	59.6 PK	68.2	-8.6	2.26 V	179	47.5	12.1
6	15540.00	63.5 PK	74.0	-10.5	1.66 V	181	51.4	12.1
7	15540.00	48.5 AV	54.0	-5.5	1.66 V	181	36.4	12.1

## REMARKS:

1. Emission Level(dBuV/m) = Raw Value(dBuV) + Correction Factor(dB/m)
2. Correction Factor(dB/m) = Antenna Factor(dB/m) + Cable Factor(dB) – Pre-Amplifier Factor(dB)
3. Margin value = Emission Level – Limit value
4. The other emission levels were very low against the limit.
5. " \* ": Fundamental frequency.
6. " # ": The radiated frequency is out of the restricted band.



<b>CHANNEL</b>	TX Channel 40	<b>DETECTOR FUNCTION</b>	Peak (PK)
<b>FREQUENCY RANGE</b>	1GHz ~ 40GHz		Average (AV)

**ANTENNA POLARITY & TEST DISTANCE: HORIZONTAL AT 3 M**

NO.	FREQ. (MHz)	EMISSION LEVEL (dBuV/m)	LIMIT (dBuV/m)	MARGIN (dB)	ANTENNA HEIGHT (m)	TABLE ANGLE (Degree)	RAW VALUE (dBuV)	CORRECTION FACTOR (dB/m)
1	5150.00	66.4 PK	74.0	-7.6	3.29 H	19	64.5	1.9
2	5150.00	52.1 AV	54.0	-1.9	3.29 H	19	50.2	1.9
3	*5200.00	121.6 PK			3.29 H	19	120.1	1.5
4	*5200.00	112.1 AV			3.29 H	19	110.6	1.5
5	#10400.00	57.2 PK	68.2	-11.0	3.08 H	94	44.8	12.4
6	15600.00	69.3 PK	74.0	-4.7	2.48 H	108	57.5	11.8
7	15600.00	53.6 AV	54.0	-0.4	2.48 H	108	41.8	11.8

**ANTENNA POLARITY & TEST DISTANCE: VERTICAL AT 3 M**

NO.	FREQ. (MHz)	EMISSION LEVEL (dBuV/m)	LIMIT (dBuV/m)	MARGIN (dB)	ANTENNA HEIGHT (m)	TABLE ANGLE (Degree)	RAW VALUE (dBuV)	CORRECTION FACTOR (dB/m)
1	5150.00	67.3 PK	74.0	-6.7	2.30 V	302	65.4	1.9
2	5150.00	53.0 AV	54.0	-1.0	2.30 V	302	51.1	1.9
3	*5200.00	122.2 PK			2.30 V	302	120.7	1.5
4	*5200.00	112.3 AV			2.30 V	302	110.8	1.5
5	#10400.00	60.1 PK	68.2	-8.1	2.31 V	163	47.7	12.4
6	15600.00	63.9 PK	74.0	-10.1	1.62 V	191	52.1	11.8
7	15600.00	48.8 AV	54.0	-5.2	1.62 V	191	37.0	11.8

**REMARKS:**

1. Emission Level(dBuV/m) = Raw Value(dBuV) + Correction Factor(dB/m)
2. Correction Factor(dB/m) = Antenna Factor(dB/m) + Cable Factor(dB) – Pre-Amplifier Factor(dB)
3. Margin value = Emission Level – Limit value
4. The other emission levels were very low against the limit.
5. " \* ": Fundamental frequency.
6. " # ": The radiated frequency is out of the restricted band.

<b>CHANNEL</b>	TX Channel 48	<b>DETECTOR FUNCTION</b>	Peak (PK)
<b>FREQUENCY RANGE</b>	1GHz ~ 40GHz		Average (AV)

**ANTENNA POLARITY & TEST DISTANCE: HORIZONTAL AT 3 M**

NO.	FREQ. (MHz)	EMISSION LEVEL (dBuV/m)	LIMIT (dBuV/m)	MARGIN (dB)	ANTENNA HEIGHT (m)	TABLE ANGLE (Degree)	RAW VALUE (dBuV)	CORRECTION FACTOR (dB/m)
1	*5240.00	121.5 PK			3.23 H	13	120.1	1.4
2	*5240.00	111.8 AV			3.23 H	13	110.4	1.4
3	5350.00	52.1 PK	74.0	-21.9	3.23 H	13	50.7	1.4
4	5350.00	41.6 AV	54.0	-12.4	3.23 H	13	40.2	1.4
5	#10480.00	56.9 PK	68.2	-11.3	3.04 H	101	44.2	12.7
6	15720.00	69.5 PK	74.0	-4.5	2.46 H	108	57.9	11.6
7	15720.00	53.6 AV	54.0	-0.4	2.46 H	108	42.0	11.6

**ANTENNA POLARITY & TEST DISTANCE: VERTICAL AT 3 M**

NO.	FREQ. (MHz)	EMISSION LEVEL (dBuV/m)	LIMIT (dBuV/m)	MARGIN (dB)	ANTENNA HEIGHT (m)	TABLE ANGLE (Degree)	RAW VALUE (dBuV)	CORRECTION FACTOR (dB/m)
1	*5240.00	123.2 PK			2.26 V	307	121.8	1.4
2	*5240.00	113.0 AV			2.26 V	307	111.6	1.4
3	5350.00	52.2 PK	74.0	-21.8	2.26 V	307	50.8	1.4
4	5350.00	41.0 AV	54.0	-13.0	2.26 V	307	39.6	1.4
5	#10480.00	59.8 PK	68.2	-8.4	2.28 V	154	47.1	12.7
6	15720.00	63.5 PK	74.0	-10.5	1.60 V	188	51.9	11.6
7	15720.00	48.4 AV	54.0	-5.6	1.60 V	188	36.8	11.6

**REMARKS:**

- Emission Level(dBuV/m) = Raw Value(dBuV) + Correction Factor(dB/m)
- Correction Factor(dB/m) = Antenna Factor(dB/m) + Cable Factor(dB) – Pre-Amplifier Factor(dB)
- Margin value = Emission Level – Limit value
- The other emission levels were very low against the limit.
- " \* ": Fundamental frequency.
- " # ": The radiated frequency is out of the restricted band.

<b>CHANNEL</b>	TX Channel 149	<b>DETECTOR FUNCTION</b>	Peak (PK)
<b>FREQUENCY RANGE</b>	1GHz ~ 40GHz		Average (AV)

**ANTENNA POLARITY & TEST DISTANCE: HORIZONTAL AT 3 M**

NO.	FREQ. (MHz)	EMISSION LEVEL (dBuV/m)	LIMIT (dBuV/m)	MARGIN (dB)	ANTENNA HEIGHT (m)	TABLE ANGLE (Degree)	RAW VALUE (dBuV)	CORRECTION FACTOR (dB/m)
1	#5647.80	67.0 PK	68.2	-1.2	2.27 H	64	65.0	2.0
2	*5745.00	122.0 PK			2.27 H	64	119.8	2.2
3	*5745.00	112.5 AV			2.27 H	64	110.3	2.2
4	#5983.89	61.1 PK	68.2	-7.1	2.27 H	64	58.2	2.9
5	11490.00	61.3 PK	74.0	-12.7	3.23 H	53	47.4	13.9
6	11490.00	48.5 AV	54.0	-5.5	3.23 H	53	34.6	13.9
7	#17235.00	68.0 PK	68.2	-0.2	2.64 H	118	50.7	17.3

**ANTENNA POLARITY & TEST DISTANCE: VERTICAL AT 3 M**

NO.	FREQ. (MHz)	EMISSION LEVEL (dBuV/m)	LIMIT (dBuV/m)	MARGIN (dB)	ANTENNA HEIGHT (m)	TABLE ANGLE (Degree)	RAW VALUE (dBuV)	CORRECTION FACTOR (dB/m)
1	#5646.21	66.1 PK	68.2	-2.1	1.57 V	344	64.1	2.0
2	*5745.00	123.9 PK			1.57 V	344	121.7	2.2
3	*5745.00	112.6 AV			1.57 V	344	110.4	2.2
4	#5964.86	61.8 PK	68.2	-6.4	1.57 V	344	58.9	2.9
5	11490.00	65.4 PK	74.0	-8.6	2.23 V	152	51.5	13.9
6	11490.00	52.2 AV	54.0	-1.8	2.23 V	152	38.3	13.9
7	#17235.00	61.7 PK	68.2	-6.5	1.67 V	356	44.4	17.3

**REMARKS:**

1. Emission Level(dBuV/m) = Raw Value(dBuV) + Correction Factor(dB/m)
2. Correction Factor(dB/m) = Antenna Factor(dB/m) + Cable Factor(dB) – Pre-Amplifier Factor(dB)
3. Margin value = Emission Level – Limit value
4. The other emission levels were very low against the limit.
5. " \* ": Fundamental frequency.
6. " # ": The radiated frequency is out of the restricted band.

<b>CHANNEL</b>	TX Channel 157	<b>DETECTOR FUNCTION</b>	Peak (PK)
<b>FREQUENCY RANGE</b>	1GHz ~ 40GHz		Average (AV)

**ANTENNA POLARITY & TEST DISTANCE: HORIZONTAL AT 3 M**

NO.	FREQ. (MHz)	EMISSION LEVEL (dBuV/m)	LIMIT (dBuV/m)	MARGIN (dB)	ANTENNA HEIGHT (m)	TABLE ANGLE (Degree)	RAW VALUE (dBuV)	CORRECTION FACTOR (dB/m)
1	#5646.97	61.0 PK	68.2	-7.2	2.24 H	61	59.0	2.0
2	*5785.00	124.0 PK			2.24 H	61	121.7	2.3
3	*5785.00	113.7 AV			2.24 H	61	111.4	2.3
4	#5996.29	60.8 PK	68.2	-7.4	2.24 H	61	57.9	2.9
5	11570.00	61.8 PK	74.0	-12.2	3.17 H	58	47.8	14.0
6	11570.00	48.9 AV	54.0	-5.1	3.17 H	58	34.9	14.0
7	#17355.00	67.6 PK	68.2	-0.6	2.61 H	132	49.7	17.9

**ANTENNA POLARITY & TEST DISTANCE: VERTICAL AT 3 M**

NO.	FREQ. (MHz)	EMISSION LEVEL (dBuV/m)	LIMIT (dBuV/m)	MARGIN (dB)	ANTENNA HEIGHT (m)	TABLE ANGLE (Degree)	RAW VALUE (dBuV)	CORRECTION FACTOR (dB/m)
1	#5648.37	61.7 PK	68.2	-6.5	1.55 V	347	59.7	2.0
2	*5785.00	123.5 PK			1.55 V	347	121.2	2.3
3	*5785.00	113.3 AV			1.55 V	347	111.0	2.3
4	#5978.63	60.8 PK	68.2	-7.4	1.55 V	347	57.9	2.9
5	11570.00	65.1 PK	74.0	-8.9	2.22 V	166	51.1	14.0
6	11570.00	52.1 AV	54.0	-1.9	2.22 V	166	38.1	14.0
7	#17355.00	61.7 PK	68.2	-6.5	1.63 V	342	43.8	17.9

**REMARKS:**

1. Emission Level(dBuV/m) = Raw Value(dBuV) + Correction Factor(dB/m)
2. Correction Factor(dB/m) = Antenna Factor(dB/m) + Cable Factor(dB) – Pre-Amplifier Factor(dB)
3. Margin value = Emission Level – Limit value
4. The other emission levels were very low against the limit.
5. " \* ": Fundamental frequency.
6. " # ": The radiated frequency is out of the restricted band.

<b>CHANNEL</b>	TX Channel 165	<b>DETECTOR FUNCTION</b>	Peak (PK)
<b>FREQUENCY RANGE</b>	1GHz ~ 40GHz		Average (AV)

**ANTENNA POLARITY & TEST DISTANCE: HORIZONTAL AT 3 M**

NO.	FREQ. (MHz)	EMISSION LEVEL (dBuV/m)	LIMIT (dBuV/m)	MARGIN (dB)	ANTENNA HEIGHT (m)	TABLE ANGLE (Degree)	RAW VALUE (dBuV)	CORRECTION FACTOR (dB/m)
1	#5633.10	61.2 PK	68.2	-7.0	2.31 H	62	59.2	2.0
2	*5825.00	123.7 PK			2.31 H	62	121.2	2.5
3	*5825.00	113.6 AV			2.31 H	62	111.1	2.5
4	#5926.93	64.9 PK	68.2	-3.3	2.31 H	62	62.2	2.7
5	11650.00	61.7 PK	74.0	-12.3	3.21 H	52	47.8	13.9
6	11650.00	48.6 AV	54.0	-5.4	3.21 H	52	34.7	13.9
7	#17475.00	67.7 PK	68.2	-0.5	2.61 H	147	48.7	19.0

**ANTENNA POLARITY & TEST DISTANCE: VERTICAL AT 3 M**

NO.	FREQ. (MHz)	EMISSION LEVEL (dBuV/m)	LIMIT (dBuV/m)	MARGIN (dB)	ANTENNA HEIGHT (m)	TABLE ANGLE (Degree)	RAW VALUE (dBuV)	CORRECTION FACTOR (dB/m)
1	#5579.27	60.1 PK	68.2	-8.1	1.57 V	347	58.0	2.1
2	*5825.00	123.3 PK			1.57 V	347	120.8	2.5
3	*5825.00	112.6 AV			1.57 V	347	110.1	2.5
4	#5932.82	62.2 PK	68.2	-6.0	1.57 V	347	59.5	2.7
5	11650.00	64.7 PK	74.0	-9.3	2.18 V	162	50.8	13.9
6	11650.00	51.6 AV	54.0	-2.4	2.18 V	162	37.7	13.9
7	#17475.00	62.0 PK	68.2	-6.2	1.67 V	354	43.0	19.0

**REMARKS:**

1. Emission Level(dBuV/m) = Raw Value(dBuV) + Correction Factor(dB/m)
2. Correction Factor(dB/m) = Antenna Factor(dB/m) + Cable Factor(dB) – Pre-Amplifier Factor(dB)
3. Margin value = Emission Level – Limit value
4. The other emission levels were very low against the limit.
5. " \* ": Fundamental frequency.
6. " # ": The radiated frequency is out of the restricted band.

**802.11ac (VHT20)**

<b>CHANNEL</b>	TX Channel 36	<b>DETECTOR FUNCTION</b>	Peak (PK)
<b>FREQUENCY RANGE</b>	1GHz ~ 40GHz		Average (AV)

**ANTENNA POLARITY & TEST DISTANCE: HORIZONTAL AT 3 M**

NO.	FREQ. (MHz)	EMISSION LEVEL (dBuV/m)	LIMIT (dBuV/m)	MARGIN (dB)	ANTENNA HEIGHT (m)	TABLE ANGLE (Degree)	RAW VALUE (dBuV)	CORRECTION FACTOR (dB/m)
1	5150.00	67.4 PK	74.0	-6.6	3.19 H	16	65.5	1.9
2	5150.00	52.5 AV	54.0	-1.5	3.19 H	16	50.6	1.9
3	*5180.00	119.8 PK			3.19 H	16	118.1	1.7
4	*5180.00	108.0 AV			3.19 H	16	106.3	1.7
5	#10360.00	57.5 PK	68.2	-10.7	3.12 H	81	45.4	12.1
6	15540.00	69.6 PK	74.0	-4.4	2.47 H	93	57.5	12.1
7	15540.00	53.7 AV	54.0	-0.3	2.47 H	93	41.6	12.1

**ANTENNA POLARITY & TEST DISTANCE: VERTICAL AT 3 M**

NO.	FREQ. (MHz)	EMISSION LEVEL (dBuV/m)	LIMIT (dBuV/m)	MARGIN (dB)	ANTENNA HEIGHT (m)	TABLE ANGLE (Degree)	RAW VALUE (dBuV)	CORRECTION FACTOR (dB/m)
1	5150.00	68.8 PK	74.0	-5.2	2.43 V	302	66.9	1.9
2	<b>5150.00</b>	<b>53.8 AV</b>	<b>54.0</b>	<b>-0.2</b>	<b>2.43 V</b>	<b>302</b>	<b>51.9</b>	<b>1.9</b>
3	*5180.00	120.5 PK			2.43 V	302	118.8	1.7
4	*5180.00	109.3 AV			2.43 V	302	107.6	1.7
5	#10360.00	60.5 PK	68.2	-7.7	2.33 V	177	48.4	12.1
6	15540.00	63.8 PK	74.0	-10.2	1.58 V	201	51.7	12.1
7	15540.00	48.8 AV	54.0	-5.2	1.58 V	201	36.7	12.1

**REMARKS:**

- Emission Level(dBuV/m) = Raw Value(dBuV) + Correction Factor(dB/m)
- Correction Factor(dB/m) = Antenna Factor(dB/m) + Cable Factor(dB) – Pre-Amplifier Factor(dB)
- Margin value = Emission Level – Limit value
- The other emission levels were very low against the limit.
- " \* ": Fundamental frequency.
- " # ": The radiated frequency is out of the restricted band.

<b>CHANNEL</b>	TX Channel 40	<b>DETECTOR FUNCTION</b>	Peak (PK)
<b>FREQUENCY RANGE</b>	1GHz ~ 40GHz		Average (AV)

**ANTENNA POLARITY & TEST DISTANCE: HORIZONTAL AT 3 M**

NO.	FREQ. (MHz)	EMISSION LEVEL (dBuV/m)	LIMIT (dBuV/m)	MARGIN (dB)	ANTENNA HEIGHT (m)	TABLE ANGLE (Degree)	RAW VALUE (dBuV)	CORRECTION FACTOR (dB/m)
1	5150.00	69.8 PK	74.0	-4.2	3.02 H	13	67.9	1.9
2	5150.00	52.7 AV	54.0	-1.3	3.02 H	13	50.8	1.9
3	*5200.00	121.5 PK			3.02 H	13	120.0	1.5
4	*5200.00	111.8 AV			3.02 H	13	110.3	1.5
5	#10400.00	57.3 PK	68.2	-10.9	3.06 H	80	44.9	12.4
6	15600.00	69.2 PK	74.0	-4.8	2.48 H	122	57.4	11.8
7	15600.00	53.6 AV	54.0	-0.4	2.48 H	122	41.8	11.8

**ANTENNA POLARITY & TEST DISTANCE: VERTICAL AT 3 M**

NO.	FREQ. (MHz)	EMISSION LEVEL (dBuV/m)	LIMIT (dBuV/m)	MARGIN (dB)	ANTENNA HEIGHT (m)	TABLE ANGLE (Degree)	RAW VALUE (dBuV)	CORRECTION FACTOR (dB/m)
1	5150.00	67.7 PK	74.0	-6.3	2.24 V	304	65.8	1.9
2	5150.00	53.3 AV	54.0	-0.7	2.24 V	304	51.4	1.9
3	*5200.00	123.3 PK			2.24 V	304	121.8	1.5
4	*5200.00	112.2 AV			2.24 V	304	110.7	1.5
5	#10400.00	59.7 PK	68.2	-8.5	2.31 V	178	47.3	12.4
6	15600.00	64.4 PK	74.0	-9.6	1.67 V	185	52.6	11.8
7	15600.00	49.1 AV	54.0	-4.9	1.67 V	185	37.3	11.8

**REMARKS:**

1. Emission Level(dBuV/m) = Raw Value(dBuV) + Correction Factor(dB/m)
2. Correction Factor(dB/m) = Antenna Factor(dB/m) + Cable Factor(dB) – Pre-Amplifier Factor(dB)
3. Margin value = Emission Level – Limit value
4. The other emission levels were very low against the limit.
5. " \* ": Fundamental frequency.
6. " # ": The radiated frequency is out of the restricted band.

<b>CHANNEL</b>	TX Channel 48	<b>DETECTOR FUNCTION</b>	Peak (PK)
<b>FREQUENCY RANGE</b>	1GHz ~ 40GHz		Average (AV)

**ANTENNA POLARITY & TEST DISTANCE: HORIZONTAL AT 3 M**

NO.	FREQ. (MHz)	EMISSION LEVEL (dBuV/m)	LIMIT (dBuV/m)	MARGIN (dB)	ANTENNA HEIGHT (m)	TABLE ANGLE (Degree)	RAW VALUE (dBuV)	CORRECTION FACTOR (dB/m)
1	*5240.00	121.8 PK			3.04 H	22	120.4	1.4
2	*5240.00	112.1 AV			3.04 H	22	110.7	1.4
3	5350.00	52.4 PK	74.0	-21.6	3.04 H	22	51.0	1.4
4	5350.00	41.4 AV	54.0	-12.6	3.04 H	22	40.0	1.4
5	#10480.00	57.7 PK	68.2	-10.5	3.09 H	91	45.0	12.7
6	15720.00	68.9 PK	74.0	-5.1	2.51 H	111	57.3	11.6
7	15720.00	53.3 AV	54.0	-0.7	2.51 H	111	41.7	11.6

**ANTENNA POLARITY & TEST DISTANCE: VERTICAL AT 3 M**

NO.	FREQ. (MHz)	EMISSION LEVEL (dBuV/m)	LIMIT (dBuV/m)	MARGIN (dB)	ANTENNA HEIGHT (m)	TABLE ANGLE (Degree)	RAW VALUE (dBuV)	CORRECTION FACTOR (dB/m)
1	*5240.00	123.6 PK			2.30 V	304	122.2	1.4
2	*5240.00	112.8 AV			2.30 V	304	111.4	1.4
3	5350.00	52.6 PK	74.0	-21.4	2.30 V	304	51.2	1.4
4	5350.00	40.0 AV	54.0	-14.0	2.30 V	304	38.6	1.4
5	#10480.00	59.8 PK	68.2	-8.4	2.31 V	155	47.1	12.7
6	15720.00	64.3 PK	74.0	-9.7	1.62 V	201	52.7	11.6
7	15720.00	49.1 AV	54.0	-4.9	1.62 V	201	37.5	11.6

**REMARKS:**

1. Emission Level(dBuV/m) = Raw Value(dBuV) + Correction Factor(dB/m)
2. Correction Factor(dB/m) = Antenna Factor(dB/m) + Cable Factor(dB) – Pre-Amplifier Factor(dB)
3. Margin value = Emission Level – Limit value
4. The other emission levels were very low against the limit.
5. " \* ": Fundamental frequency.
6. " # ": The radiated frequency is out of the restricted band.



<b>CHANNEL</b>	TX Channel 149	<b>DETECTOR FUNCTION</b>	Peak (PK)
<b>FREQUENCY RANGE</b>	1GHz ~ 40GHz		Average (AV)

**ANTENNA POLARITY & TEST DISTANCE: HORIZONTAL AT 3 M**

NO.	FREQ. (MHz)	EMISSION LEVEL (dBuV/m)	LIMIT (dBuV/m)	MARGIN (dB)	ANTENNA HEIGHT (m)	TABLE ANGLE (Degree)	RAW VALUE (dBuV)	CORRECTION FACTOR (dB/m)
1	#5650.05	65.0 PK	68.2	-3.2	2.33 H	59	63.0	2.0
2	*5745.00	122.4 PK			2.33 H	59	118.5	3.9
3	*5745.00	111.5 AV			2.33 H	59	107.6	3.9
4	#5967.69	60.3 PK	68.2	-7.9	2.33 H	59	57.4	2.9
5	11490.00	61.9 PK	74.0	-12.1	3.19 H	55	47.7	14.2
6	11490.00	48.9 AV	54.0	-5.1	3.19 H	55	34.7	14.2
7	#17235.00	67.5 PK	68.2	-0.7	2.63 H	152	50.2	17.3

**ANTENNA POLARITY & TEST DISTANCE: VERTICAL AT 3 M**

NO.	FREQ. (MHz)	EMISSION LEVEL (dBuV/m)	LIMIT (dBuV/m)	MARGIN (dB)	ANTENNA HEIGHT (m)	TABLE ANGLE (Degree)	RAW VALUE (dBuV)	CORRECTION FACTOR (dB/m)
1	#5648.72	63.9 PK	68.2	-4.3	1.43 V	344	61.9	2.0
2	*5745.00	122.2 PK			1.43 V	344	118.3	3.9
3	*5745.00	112.3 AV			1.43 V	344	108.4	3.9
4	#5984.37	60.2 PK	68.2	-8.0	1.43 V	344	57.3	2.9
5	11490.00	64.9 PK	74.0	-9.1	2.18 V	141	50.7	14.2
6	11490.00	51.9 AV	54.0	-2.1	2.18 V	141	37.7	14.2
7	#17235.00	61.8 PK	68.2	-6.4	1.63 V	360	44.5	17.3

**REMARKS:**

1. Emission Level(dBuV/m) = Raw Value(dBuV) + Correction Factor(dB/m)
2. Correction Factor(dB/m) = Antenna Factor(dB/m) + Cable Factor(dB) – Pre-Amplifier Factor(dB)
3. Margin value = Emission Level – Limit value
4. The other emission levels were very low against the limit.
5. " \* ": Fundamental frequency.
6. " # ": The radiated frequency is out of the restricted band.

<b>CHANNEL</b>	TX Channel 157	<b>DETECTOR FUNCTION</b>	Peak (PK)
<b>FREQUENCY RANGE</b>	1GHz ~ 40GHz		Average (AV)

**ANTENNA POLARITY & TEST DISTANCE: HORIZONTAL AT 3 M**

NO.	FREQ. (MHz)	EMISSION LEVEL (dBuV/m)	LIMIT (dBuV/m)	MARGIN (dB)	ANTENNA HEIGHT (m)	TABLE ANGLE (Degree)	RAW VALUE (dBuV)	CORRECTION FACTOR (dB/m)
1	#5637.34	62.5 PK	68.2	-5.7	2.31 H	57	60.5	2.0
2	*5785.00	122.3 PK			2.31 H	57	118.3	4.0
3	*5785.00	111.9 AV			2.31 H	57	107.9	4.0
4	#5926.15	61.1 PK	68.2	-7.1	2.31 H	57	58.4	2.7
5	11570.00	62.4 PK	74.0	-11.6	3.22 H	48	48.2	14.2
6	11570.00	49.1 AV	54.0	-4.9	3.22 H	48	34.9	14.2
7	#17355.00	67.2 PK	68.2	-1.0	2.63 H	135	49.5	17.7

**ANTENNA POLARITY & TEST DISTANCE: VERTICAL AT 3 M**

NO.	FREQ. (MHz)	EMISSION LEVEL (dBuV/m)	LIMIT (dBuV/m)	MARGIN (dB)	ANTENNA HEIGHT (m)	TABLE ANGLE (Degree)	RAW VALUE (dBuV)	CORRECTION FACTOR (dB/m)
1	#5647.47	62.0 PK	68.2	-6.2	1.40 V	346	60.0	2.0
2	*5785.00	123.9 PK			1.40 V	346	119.9	4.0
3	*5785.00	112.2 AV			1.40 V	346	108.2	4.0
4	#5988.35	60.9 PK	68.2	-7.3	1.40 V	346	58.0	2.9
5	11570.00	65.4 PK	74.0	-8.6	2.23 V	144	51.2	14.2
6	11570.00	52.4 AV	54.0	-1.6	2.23 V	144	38.2	14.2
7	#17355.00	61.8 PK	68.2	-6.4	1.69 V	342	44.1	17.7

**REMARKS:**

1. Emission Level(dBuV/m) = Raw Value(dBuV) + Correction Factor(dB/m)
2. Correction Factor(dB/m) = Antenna Factor(dB/m) + Cable Factor(dB) – Pre-Amplifier Factor(dB)
3. Margin value = Emission Level – Limit value
4. The other emission levels were very low against the limit.
5. " \* ": Fundamental frequency.
6. " # ": The radiated frequency is out of the restricted band.

<b>CHANNEL</b>	TX Channel 165	<b>DETECTOR FUNCTION</b>	Peak (PK)
<b>FREQUENCY RANGE</b>	1GHz ~ 40GHz		Average (AV)

**ANTENNA POLARITY & TEST DISTANCE: HORIZONTAL AT 3 M**

NO.	FREQ. (MHz)	EMISSION LEVEL (dBuV/m)	LIMIT (dBuV/m)	MARGIN (dB)	ANTENNA HEIGHT (m)	TABLE ANGLE (Degree)	RAW VALUE (dBuV)	CORRECTION FACTOR (dB/m)
1	#5621.42	59.3 PK	68.2	-8.9	2.31 H	61	57.2	2.1
2	*5825.00	123.7 PK			2.31 H	61	119.5	4.2
3	*5825.00	112.8 AV			2.31 H	61	108.6	4.2
4	#5930.67	63.6 PK	68.2	-4.6	2.31 H	61	60.9	2.7
5	11650.00	61.1 PK	74.0	-12.9	3.22 H	38	47.2	13.9
6	11650.00	48.2 AV	54.0	-5.8	3.22 H	38	34.3	13.9
7	#17475.00	67.4 PK	68.2	-0.8	2.55 H	140	48.6	18.8

**ANTENNA POLARITY & TEST DISTANCE: VERTICAL AT 3 M**

NO.	FREQ. (MHz)	EMISSION LEVEL (dBuV/m)	LIMIT (dBuV/m)	MARGIN (dB)	ANTENNA HEIGHT (m)	TABLE ANGLE (Degree)	RAW VALUE (dBuV)	CORRECTION FACTOR (dB/m)
1	#5614.10	60.4 PK	68.2	-7.8	1.46 V	343	58.3	2.1
2	*5825.00	122.5 PK			1.46 V	343	118.3	4.2
3	*5825.00	111.5 AV			1.46 V	343	107.3	4.2
4	#5925.32	61.4 PK	68.2	-6.8	1.46 V	343	58.7	2.7
5	11650.00	65.3 PK	74.0	-8.7	2.27 V	166	51.4	13.9
6	11650.00	52.4 AV	54.0	-1.6	2.27 V	166	38.5	13.9
7	#17475.00	62.4 PK	68.2	-5.8	1.69 V	345	43.6	18.8

**REMARKS:**

1. Emission Level(dBuV/m) = Raw Value(dBuV) + Correction Factor(dB/m)
2. Correction Factor(dB/m) = Antenna Factor(dB/m) + Cable Factor(dB) – Pre-Amplifier Factor(dB)
3. Margin value = Emission Level – Limit value
4. The other emission levels were very low against the limit.
5. " \* ": Fundamental frequency.
6. " # ": The radiated frequency is out of the restricted band.

**802.11ac (VHT40)**

<b>CHANNEL</b>	TX Channel 38	<b>DETECTOR FUNCTION</b>	Peak (PK)
<b>FREQUENCY RANGE</b>	1GHz ~ 40GHz		Average (AV)

<b>ANTENNA POLARITY &amp; TEST DISTANCE: HORIZONTAL AT 3 M</b>								
<b>NO.</b>	<b>FREQ. (MHz)</b>	<b>EMISSION LEVEL (dBuV/m)</b>	<b>LIMIT (dBuV/m)</b>	<b>MARGIN (dB)</b>	<b>ANTENNA HEIGHT (m)</b>	<b>TABLE ANGLE (Degree)</b>	<b>RAW VALUE (dBuV)</b>	<b>CORRECTION FACTOR (dB/m)</b>
1	5150.00	68.1 PK	74.0	-5.9	3.16 H	29	64.6	3.5
2	5150.00	52.5 AV	54.0	-1.5	3.16 H	29	49.0	3.5
3	*5190.00	115.4 PK			3.16 H	29	112.0	3.4
4	*5190.00	104.9 AV			3.16 H	29	101.5	3.4
5	#10380.00	57.3 PK	68.2	-10.9	3.21 H	21	44.0	13.3
6	15570.00	62.2 PK	74.0	-11.8	2.49 H	137	48.8	13.4
7	15570.00	52.0 AV	54.0	-2.0	2.49 H	137	38.6	13.4

<b>ANTENNA POLARITY &amp; TEST DISTANCE: VERTICAL AT 3 M</b>								
<b>NO.</b>	<b>FREQ. (MHz)</b>	<b>EMISSION LEVEL (dBuV/m)</b>	<b>LIMIT (dBuV/m)</b>	<b>MARGIN (dB)</b>	<b>ANTENNA HEIGHT (m)</b>	<b>TABLE ANGLE (Degree)</b>	<b>RAW VALUE (dBuV)</b>	<b>CORRECTION FACTOR (dB/m)</b>
1	5150.00	67.4 PK	74.0	-6.6	2.41 V	301	63.9	3.5
2	5150.00	53.6 AV	54.0	-0.4	2.41 V	301	50.1	3.5
3	*5190.00	115.3 PK			2.41 V	301	111.9	3.4
4	*5190.00	105.3 AV			2.41 V	301	101.9	3.4
5	#10380.00	58.2 PK	68.2	-10.0	2.28 V	189	44.9	13.3
6	15570.00	60.3 PK	74.0	-13.7	1.67 V	173	46.9	13.4
7	15570.00	47.4 AV	54.0	-6.6	1.67 V	173	34.0	13.4

**REMARKS:**

1. Emission Level(dBuV/m) = Raw Value(dBuV) + Correction Factor(dB/m)
2. Correction Factor(dB/m) = Antenna Factor(dB/m) + Cable Factor(dB) – Pre-Amplifier Factor(dB)
3. Margin value = Emission Level – Limit value
4. The other emission levels were very low against the limit.
5. " \* ": Fundamental frequency.
6. " # ": The radiated frequency is out of the restricted band.

<b>CHANNEL</b>	TX Channel 46	<b>DETECTOR FUNCTION</b>	Peak (PK)
<b>FREQUENCY RANGE</b>	1GHz ~ 40GHz		Average (AV)

**ANTENNA POLARITY & TEST DISTANCE: HORIZONTAL AT 3 M**

NO.	FREQ. (MHz)	EMISSION LEVEL (dBuV/m)	LIMIT (dBuV/m)	MARGIN (dB)	ANTENNA HEIGHT (m)	TABLE ANGLE (Degree)	RAW VALUE (dBuV)	CORRECTION FACTOR (dB/m)
1	*5230.00	118.6 PK			3.21 H	39	115.5	3.1
2	*5230.00	108.7 AV			3.21 H	39	105.6	3.1
3	5350.00	52.7 PK	74.0	-21.3	3.21 H	39	49.4	3.3
4	5350.00	41.5 AV	54.0	-12.5	3.21 H	39	38.2	3.3
5	#10460.00	57.8 PK	68.2	-10.4	3.26 H	28	44.3	13.5
6	15690.00	63.9 PK	74.0	-10.1	2.48 H	130	51.0	12.9
7	15690.00	53.2 AV	54.0	-0.8	2.48 H	130	40.3	12.9

**ANTENNA POLARITY & TEST DISTANCE: VERTICAL AT 3 M**

NO.	FREQ. (MHz)	EMISSION LEVEL (dBuV/m)	LIMIT (dBuV/m)	MARGIN (dB)	ANTENNA HEIGHT (m)	TABLE ANGLE (Degree)	RAW VALUE (dBuV)	CORRECTION FACTOR (dB/m)
1	*5230.00	118.4 PK			2.35 V	303	115.3	3.1
2	*5230.00	109.2 AV			2.35 V	303	106.1	3.1
3	5350.00	53.9 PK	74.0	-20.1	2.35 V	303	50.6	3.3
4	5350.00	42.2 AV	54.0	-11.8	2.35 V	303	38.9	3.3
5	#10460.00	60.1 PK	68.2	-8.1	2.30 V	186	46.6	13.5
6	15690.00	62.5 PK	74.0	-11.5	1.64 V	189	49.6	12.9
7	15690.00	47.8 AV	54.0	-6.2	1.64 V	189	34.9	12.9

**REMARKS:**

1. Emission Level(dBuV/m) = Raw Value(dBuV) + Correction Factor(dB/m)
2. Correction Factor(dB/m) = Antenna Factor(dB/m) + Cable Factor(dB) – Pre-Amplifier Factor(dB)
3. Margin value = Emission Level – Limit value
4. The other emission levels were very low against the limit.
5. " \* ": Fundamental frequency.
6. " # ": The radiated frequency is out of the restricted band.

<b>CHANNEL</b>	TX Channel 151	<b>DETECTOR FUNCTION</b>	Peak (PK)
<b>FREQUENCY RANGE</b>	1GHz ~ 40GHz		Average (AV)

**ANTENNA POLARITY & TEST DISTANCE: HORIZONTAL AT 3 M**

NO.	FREQ. (MHz)	EMISSION LEVEL (dBuV/m)	LIMIT (dBuV/m)	MARGIN (dB)	ANTENNA HEIGHT (m)	TABLE ANGLE (Degree)	RAW VALUE (dBuV)	CORRECTION FACTOR (dB/m)
1	#5633.08	65.0 PK	68.2	-3.2	2.44 H	64	63.0	2.0
2	*5755.00	117.5 PK			2.44 H	64	113.6	3.9
3	*5755.00	107.7 AV			2.44 H	64	103.8	3.9
4	#6017.44	61.0 PK	68.2	-7.2	2.44 H	64	58.1	2.9
5	11510.00	59.5 PK	74.0	-14.5	3.24 H	33	45.3	14.2
6	11510.00	46.5 AV	54.0	-7.5	3.24 H	33	32.3	14.2
7	#17265.00	61.9 PK	68.2	-6.3	2.48 H	132	44.7	17.2

**ANTENNA POLARITY & TEST DISTANCE: VERTICAL AT 3 M**

NO.	FREQ. (MHz)	EMISSION LEVEL (dBuV/m)	LIMIT (dBuV/m)	MARGIN (dB)	ANTENNA HEIGHT (m)	TABLE ANGLE (Degree)	RAW VALUE (dBuV)	CORRECTION FACTOR (dB/m)
1	#5649.79	65.9 PK	68.2	-2.3	1.02 V	341	63.9	2.0
2	*5755.00	117.2 PK			1.02 V	341	113.3	3.9
3	*5755.00	107.9 AV			1.02 V	341	104.0	3.9
4	#5933.29	61.4 PK	68.2	-6.8	1.02 V	341	58.7	2.7
5	11510.00	64.3 PK	74.0	-9.7	2.21 V	194	50.1	14.2
6	11510.00	50.1 AV	54.0	-3.9	2.21 V	194	35.9	14.2
7	#17265.00	60.7 PK	68.2	-7.5	1.55 V	347	43.5	17.2

**REMARKS:**

1. Emission Level(dBuV/m) = Raw Value(dBuV) + Correction Factor(dB/m)
2. Correction Factor(dB/m) = Antenna Factor(dB/m) + Cable Factor(dB) – Pre-Amplifier Factor(dB)
3. Margin value = Emission Level – Limit value
4. The other emission levels were very low against the limit.
5. " \* ": Fundamental frequency.
6. " # ": The radiated frequency is out of the restricted band.

<b>CHANNEL</b>	TX Channel 159	<b>DETECTOR FUNCTION</b>	Peak (PK)
<b>FREQUENCY RANGE</b>	1GHz ~ 40GHz		Average (AV)

**ANTENNA POLARITY & TEST DISTANCE: HORIZONTAL AT 3 M**

NO.	FREQ. (MHz)	EMISSION LEVEL (dBuV/m)	LIMIT (dBuV/m)	MARGIN (dB)	ANTENNA HEIGHT (m)	TABLE ANGLE (Degree)	RAW VALUE (dBuV)	CORRECTION FACTOR (dB/m)
1	#5633.02	65.7 PK	68.2	-2.5	2.49 H	60	63.7	2.0
2	*5795.00	118.2 PK			2.49 H	60	114.2	4.0
3	*5795.00	109.0 AV			2.49 H	60	105.0	4.0
4	#5935.42	65.3 PK	68.2	-2.9	2.49 H	60	62.5	2.8
5	11590.00	60.0 PK	74.0	-14.0	3.26 H	44	45.8	14.2
6	11590.00	46.1 AV	54.0	-7.9	3.26 H	44	31.9	14.2
7	#17385.00	63.6 PK	68.2	-4.6	2.43 H	129	45.8	17.8

**ANTENNA POLARITY & TEST DISTANCE: VERTICAL AT 3 M**

NO.	FREQ. (MHz)	EMISSION LEVEL (dBuV/m)	LIMIT (dBuV/m)	MARGIN (dB)	ANTENNA HEIGHT (m)	TABLE ANGLE (Degree)	RAW VALUE (dBuV)	CORRECTION FACTOR (dB/m)
1	#5648.79	66.3 PK	68.2	-1.9	1.05 V	339	64.3	2.0
2	*5795.00	119.0 PK			1.05 V	339	115.0	4.0
3	*5795.00	108.8 AV			1.05 V	339	104.8	4.0
4	#5936.56	63.8 PK	68.2	-4.4	1.05 V	339	61.0	2.8
5	11590.00	64.7 PK	74.0	-9.3	2.21 V	191	50.5	14.2
6	11590.00	50.9 AV	54.0	-3.1	2.21 V	191	36.7	14.2
7	#17385.00	61.1 PK	68.2	-7.1	1.54 V	359	43.3	17.8

**REMARKS:**

1. Emission Level(dBuV/m) = Raw Value(dBuV) + Correction Factor(dB/m)
2. Correction Factor(dB/m) = Antenna Factor(dB/m) + Cable Factor(dB) – Pre-Amplifier Factor(dB)
3. Margin value = Emission Level – Limit value
4. The other emission levels were very low against the limit.
5. " \* ": Fundamental frequency.
6. " # ": The radiated frequency is out of the restricted band.

**802.11ac (VHT80)**

<b>CHANNEL</b>	TX Channel 42	<b>DETECTOR FUNCTION</b>	Peak (PK)
<b>FREQUENCY RANGE</b>	1GHz ~ 40GHz		Average (AV)

**ANTENNA POLARITY & TEST DISTANCE: HORIZONTAL AT 3 M**

NO.	FREQ. (MHz)	EMISSION LEVEL (dBuV/m)	LIMIT (dBuV/m)	MARGIN (dB)	ANTENNA HEIGHT (m)	TABLE ANGLE (Degree)	RAW VALUE (dBuV)	CORRECTION FACTOR (dB/m)
1	5150.00	65.3 PK	74.0	-8.7	3.17 H	27	61.8	3.5
2	5150.00	52.2 AV	54.0	-1.8	3.17 H	27	48.7	3.5
3	*5210.00	111.5 PK			3.17 H	27	108.2	3.3
4	*5210.00	101.4 AV			3.17 H	27	98.1	3.3
5	5350.00	58.1 PK	74.0	-15.9	3.17 H	27	54.8	3.3
6	5350.00	45.5 AV	54.0	-8.5	3.17 H	27	42.2	3.3
7	#10420.00	56.8 PK	68.2	-11.4	3.21 H	40	43.3	13.5
8	15630.00	62.4 PK	74.0	-11.6	2.51 H	120	49.2	13.2
9	15630.00	51.9 AV	54.0	-2.1	2.51 H	120	38.7	13.2

**ANTENNA POLARITY & TEST DISTANCE: VERTICAL AT 3 M**

NO.	FREQ. (MHz)	EMISSION LEVEL (dBuV/m)	LIMIT (dBuV/m)	MARGIN (dB)	ANTENNA HEIGHT (m)	TABLE ANGLE (Degree)	RAW VALUE (dBuV)	CORRECTION FACTOR (dB/m)
1	5150.00	65.6 PK	74.0	-8.4	2.39 V	302	62.1	3.5
2	5150.00	53.6 AV	54.0	-0.4	2.39 V	302	50.1	3.5
3	*5210.00	111.6 PK			2.39 V	302	108.3	3.3
4	*5210.00	101.3 AV			2.39 V	302	98.0	3.3
5	5350.00	59.1 PK	74.0	-14.9	2.39 V	302	55.8	3.3
6	5350.00	45.7 AV	54.0	-8.3	2.39 V	302	42.4	3.3
7	#10420.00	58.5 PK	68.2	-9.7	2.28 V	184	45.0	13.5
8	15630.00	59.9 PK	74.0	-14.1	1.64 V	198	46.7	13.2
9	15630.00	47.7 AV	54.0	-6.3	1.64 V	198	34.5	13.2

**REMARKS:**

1. Emission Level(dBuV/m) = Raw Value(dBuV) + Correction Factor(dB/m)
2. Correction Factor(dB/m) = Antenna Factor(dB/m) + Cable Factor(dB) – Pre-Amplifier Factor(dB)
3. Margin value = Emission Level – Limit value
4. The other emission levels were very low against the limit.
5. " \* ": Fundamental frequency.
6. " # ": The radiated frequency is out of the restricted band.



<b>CHANNEL</b>	TX Channel 155	<b>DETECTOR FUNCTION</b>	Peak (PK)
<b>FREQUENCY RANGE</b>	1GHz ~ 40GHz		Average (AV)

**ANTENNA POLARITY & TEST DISTANCE: HORIZONTAL AT 3 M**

NO.	FREQ. (MHz)	EMISSION LEVEL (dBuV/m)	LIMIT (dBuV/m)	MARGIN (dB)	ANTENNA HEIGHT (m)	TABLE ANGLE (Degree)	RAW VALUE (dBuV)	CORRECTION FACTOR (dB/m)
1	#5649.79	60.7 PK	68.2	-7.5	2.46 H	71	58.7	2.0
2	*5775.00	108.2 PK			2.46 H	71	104.3	3.9
3	*5775.00	100.5 AV			2.46 H	71	96.6	3.9
4	#5954.39	61.1 PK	68.2	-7.1	2.46 H	71	58.2	2.9
5	11550.00	56.6 PK	74.0	-17.4	3.24 H	35	42.4	14.2
6	11550.00	44.3 AV	54.0	-9.7	3.24 H	35	30.1	14.2
7	#17325.00	62.5 PK	68.2	-5.7	2.49 H	126	45.1	17.4

**ANTENNA POLARITY & TEST DISTANCE: VERTICAL AT 3 M**

NO.	FREQ. (MHz)	EMISSION LEVEL (dBuV/m)	LIMIT (dBuV/m)	MARGIN (dB)	ANTENNA HEIGHT (m)	TABLE ANGLE (Degree)	RAW VALUE (dBuV)	CORRECTION FACTOR (dB/m)
1	1550.00	63.2 PK	74.0	-10.8	2.17 V	179	67.7	-4.5
2	1550.00	49.6 AV	54.0	-4.4	2.17 V	179	54.1	-4.5
3	#5633.04	62.6 PK	68.2	-5.6	1.02 V	339	60.6	2.0
4	*5775.00	109.6 PK			1.02 V	339	105.7	3.9
5	*5775.00	100.3 AV			1.02 V	339	96.4	3.9
6	#5937.02	61.7 PK	68.2	-6.5	1.02 V	339	58.9	2.8
7	#17325.00	59.7 PK	68.2	-8.5	1.58 V	352	42.3	17.4

**REMARKS:**

1. Emission Level(dBuV/m) = Raw Value(dBuV) + Correction Factor(dB/m)
2. Correction Factor(dB/m) = Antenna Factor(dB/m) + Cable Factor(dB) – Pre-Amplifier Factor(dB)
3. Margin value = Emission Level – Limit value
4. The other emission levels were very low against the limit.
5. " \* ": Fundamental frequency.
6. " # ": The radiated frequency is out of the restricted band.

Below 1GHz Data:

802.11a

<b>CHANNEL</b>	TX Channel 149	<b>DETECTOR FUNCTION</b>	Quasi-Peak (QP)
<b>FREQUENCY RANGE</b>	9kHz ~ 1GHz		

**ANTENNA POLARITY & TEST DISTANCE: HORIZONTAL AT 3 M**

NO.	FREQ. (MHz)	EMISSION LEVEL (dBuV/m)	LIMIT (dBuV/m)	MARGIN (dB)	ANTENNA HEIGHT (m)	TABLE ANGLE (Degree)	RAW VALUE (dBuV)	CORRECTION FACTOR (dB/m)
1	30.15	32.5 QP	40.0	-7.5	1.00 H	214	46.5	-14.0
2	99.28	35.4 QP	43.5	-8.1	2.00 H	74	52.7	-17.3
3	148.99	33.7 QP	43.5	-9.8	2.00 H	247	46.4	-12.7
4	208.97	30.1 QP	43.5	-13.4	2.00 H	115	46.2	-16.1
5	283.24	31.2 QP	46.0	-14.8	1.00 H	114	43.8	-12.6
6	350.32	30.6 QP	46.0	-15.4	1.00 H	127	41.5	-10.9

**REMARKS:**

1. Emission Level(dBuV/m) = Raw Value(dBuV) + Correction Factor(dB/m)
2. Correction Factor(dB/m) = Antenna Factor(dB/m) + Cable Factor(dB) – Pre-Amplifier Factor(dB)
3. Margin value = Emission Level – Limit value
4. The other emission levels were very low against the limit of frequency range 30MHz~1000MHz.
5. The emission levels were very low against the limit of frequency range 9kHz~30MHz: the amplitude of spurious emissions attenuated more than 20 dB below the permissible value to be report.

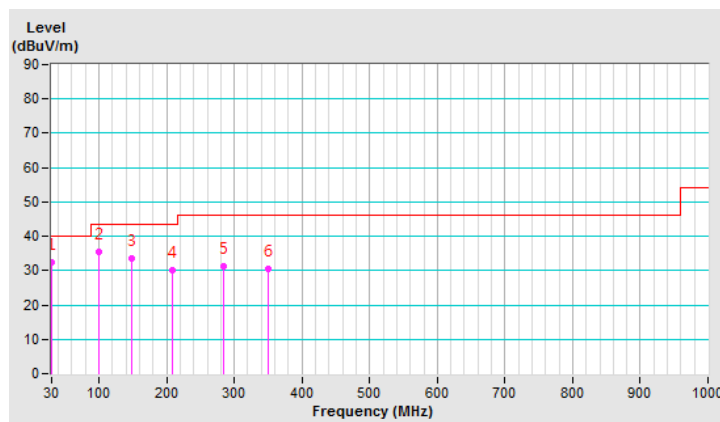

<b>CHANNEL</b>	TX Channel 149	<b>DETECTOR FUNCTION</b>	Quasi-Peak (QP)
<b>FREQUENCY RANGE</b>	9kHz ~ 1GHz		

**ANTENNA POLARITY & TEST DISTANCE: VERTICAL AT 3 M**

NO.	FREQ. (MHz)	EMISSION LEVEL (dBuV/m)	LIMIT (dBuV/m)	MARGIN (dB)	ANTENNA HEIGHT (m)	TABLE ANGLE (Degree)	RAW VALUE (dBuV)	CORRECTION FACTOR (dB/m)
1	36.28	36.9 QP	40.0	-3.1	1.00 V	310	50.6	-13.7
2	62.49	36.1 QP	40.0	-3.9	1.00 V	360	49.9	-13.8
3	146.45	29.6 QP	43.5	-13.9	1.50 V	290	42.3	-12.7
4	198.20	30.4 QP	43.5	-13.1	1.00 V	97	46.4	-16.0
5	313.17	29.5 QP	46.0	-16.5	1.00 V	360	41.2	-11.7
6	375.00	30.8 QP	46.0	-15.2	1.50 V	169	40.9	-10.1

**REMARKS:**

1. Emission Level(dBuV/m) = Raw Value(dBuV) + Correction Factor(dB/m)
2. Correction Factor(dB/m) = Antenna Factor(dB/m) + Cable Factor(dB) – Pre-Amplifier Factor(dB)
3. Margin value = Emission Level – Limit value
4. The other emission levels were very low against the limit of frequency range 30MHz~1000MHz.
5. The emission levels were very low against the limit of frequency range 9kHz~30MHz: the amplitude of spurious emissions attenuated more than 20 dB below the permissible value to be report.

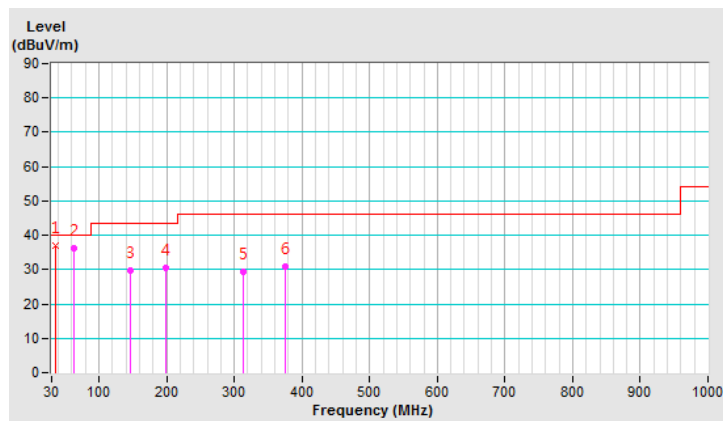

## 4.2 Conducted Emission Measurement

### 4.2.1 Limits of Conducted Emission Measurement

Frequency (MHz)	Conducted Limit (dBuV)	
	Quasi-peak	Average
0.15 - 0.5	66 - 56	56 - 46
0.50 - 5.0	56	46
5.0 - 30.0	60	50

Note: 1. The lower limit shall apply at the transition frequencies.

2. The limit decreases in line with the logarithm of the frequency in the range of 0.15 to 0.50MHz.

### 4.2.2 Test Instruments

DESCRIPTION & MANUFACTURER	MODEL NO.	SERIAL NO.	CALIBRATED DATE	CALIBRATED UNTIL
Test Receiver R&S	ESCS 30	847124/029	Oct. 23, 2019	Oct. 22, 2020
Line-Impedance Stabilization Network (for EUT) R&S	ESH3-Z5	848773/004	Oct. 23, 2019	Oct. 22, 2020
Line-Impedance Stabilization Network (for Peripheral) R&S	ESH3-Z5	835239/001	Mar. 17, 2019	Mar. 16, 2020
50 ohms Terminator	50	3	Oct. 23, 2019	Oct. 22, 2020
RF Cable	5D-FB	COCCAB-001	Sep. 27, 2019	Sep. 26, 2020
Fixed attenuator EMCI	STI02-2200-10	003	Mar. 14, 2019	Mar. 13, 2020
Software BVADT	BVADT_Cond_ V7.3.7.4	NA	NA	NA

**Note:**

1. The calibration interval of the above test instruments are 12 months and the calibrations are traceable to NML/ROC and NIST/USA.
2. The test was performed in Conduction 1.
- 3 Tested Date: Jan. 02, 2020

#### 4.2.3 Test Procedure

- The EUT was placed 0.4 meters from the conducting wall of the shielded room with EUT being connected to the power mains through a line impedance stabilization network (LISN). Other support units were connected to the power mains through another LISN. The two LISNs provide 50 ohm/ 50uH of coupling impedance for the measuring instrument.
- Both lines of the power mains connected to the EUT were checked for maximum conducted interference.
- The frequency range from 150kHz to 30MHz was searched. Emission levels under (Limit - 20dB) was not recorded.

**NOTE:** All modes of operation were investigated and the worst-case emissions are reported.

#### 4.2.4 Deviation from Test Standard

No deviation.

#### 4.2.5 Test Setup

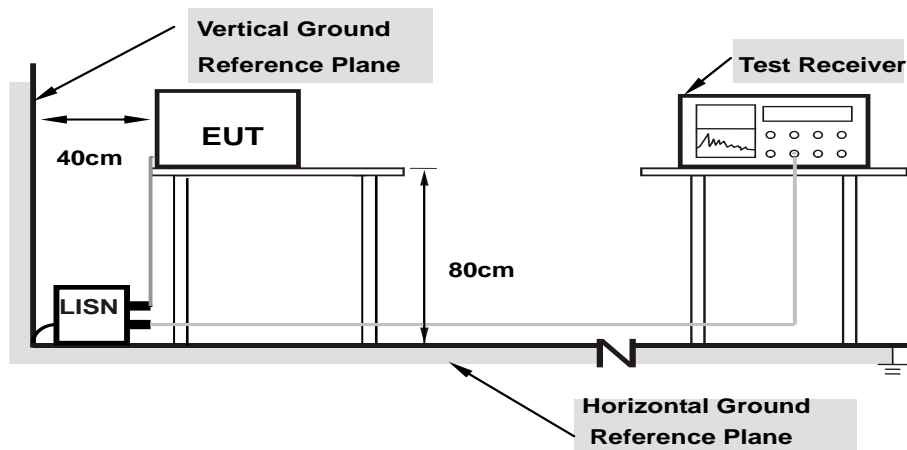

**Note: 1.Support units were connected to second LISN.**

For the actual test configuration, please refer to the attached file (Test Setup Photo).

#### 4.2.6 EUT Operating Condition

Same as 4.1.6.

#### 4.2.7 Test Results

Phase	Line (L)	Detector Function	Quasi-Peak (QP) / Average (AV)
-------	----------	-------------------	--------------------------------

No	Freq. [MHz]	Corr.	Reading Value		Emission Level		Limit		Margin	
		Factor	[dB (uV)]		[dB (uV)]		[dB (uV)]		(dB)	
	(dB)	Q.P.	AV.	Q.P.	AV.	Q.P.	AV.	Q.P.	AV.	
1	0.15391	9.99	38.08	23.22	48.07	33.21	65.79	55.79	-17.72	-22.58
2	0.19687	9.99	34.13	21.96	44.12	31.95	63.74	53.74	-19.62	-21.79
3	0.23594	9.99	30.29	24.32	40.28	34.31	62.24	52.24	-21.96	-17.93
4	0.40000	10.00	29.01	25.90	39.01	35.90	57.85	47.85	-18.84	-11.95
5	1.19141	10.06	15.09	12.10	25.15	22.16	56.00	46.00	-30.85	-23.84
6	10.48047	10.69	13.72	8.32	24.41	19.01	60.00	50.00	-35.59	-30.99

#### Remarks:

1. Q.P. and AV. are abbreviations of quasi-peak and average individually.
2. The emission levels of other frequencies were very low against the limit.
3. Margin value = Emission level – Limit value
4. Correction factor = Insertion loss + Cable loss
5. Emission Level = Correction Factor + Reading Value

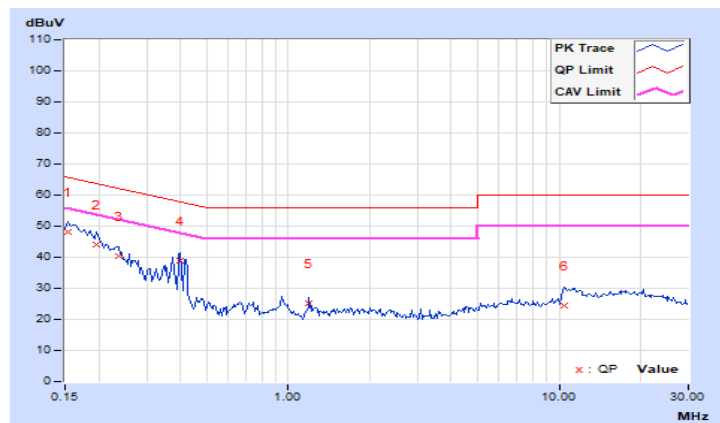

Phase	Neutral (N)	Detector Function	Quasi-Peak (QP) / Average (AV)
-------	-------------	-------------------	--------------------------------

No	Freq. [MHz]	Corr. Factor	Reading Value [dB (uV)]		Emission Level [dB (uV)]		Limit [dB (uV)]		Margin (dB)	
		(dB)	Q.P.	AV.	Q.P.	AV.	Q.P.	AV.	Q.P.	AV.
	1	0.15391	9.99	37.81	22.55	47.80	32.54	65.79	55.79	-17.99
2	0.20078	9.99	32.99	22.76	42.98	32.75	63.58	53.58	-20.60	-20.83
3	0.25547	10.00	28.60	20.31	38.60	30.31	61.58	51.58	-22.98	-21.27
<b>4</b>	<b>0.39609</b>	<b>10.01</b>	<b>34.31</b>	<b>33.37</b>	<b>44.32</b>	<b>43.38</b>	<b>57.93</b>	<b>47.93</b>	<b>-13.61</b>	<b>-4.55</b>
5	10.87891	10.63	17.78	12.56	28.41	23.19	60.00	50.00	-31.59	-26.81
6	24.03125	11.21	11.87	7.88	23.08	19.09	60.00	50.00	-36.92	-30.91

#### Remarks:

1. Q.P. and AV. are abbreviations of quasi-peak and average individually.
2. The emission levels of other frequencies were very low against the limit.
3. Margin value = Emission level – Limit value
4. Correction factor = Insertion loss + Cable loss
5. Emission Level = Correction Factor + Reading Value

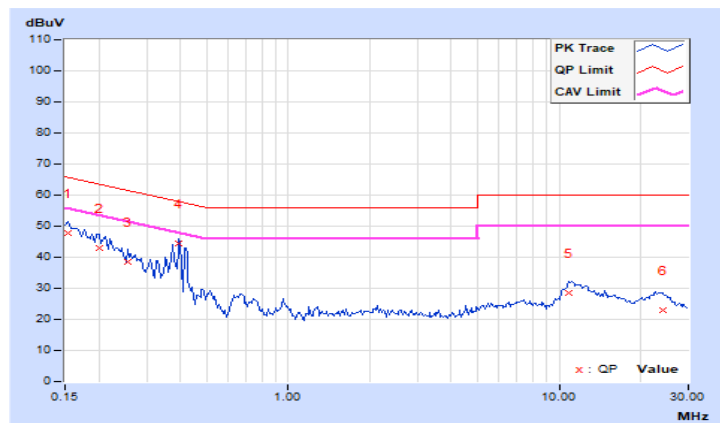

### 4.3 Transmit Power Measurement

#### 4.3.1 Limits of Transmit Power Measurement

Operation Band	EUT Category		Limit
U-NII-1		Outdoor Access Point	1 Watt (30 dBm) (Max. e.i.r.p $\leq$ 125mW(21 dBm) at any elevation angle above 30 degrees as measured from the horizon)
		Fixed point-to-point Access Point	1 Watt (30 dBm)
	√	Indoor Access Point	1 Watt (30 dBm)
		Client device	250mW (24 dBm)
U-NII-2A	---		250mW (24 dBm) or 11 dBm+10 log B*
U-NII-2C	---		250mW (24 dBm) or 11 dBm+10 log B*
U-NII-3	√		1 Watt (30 dBm)

\*B is the 26 dB emission bandwidth in megahertz

Per KDB 662911 Method of conducted output power measurement on IEEE 802.11 devices,

Array Gain = 0 dB (i.e., no array gain) for  $N_{ANT} \leq 4$ ;

Array Gain = 0 dB (i.e., no array gain) for channel widths  $\geq 40$  MHz for any  $N_{ANT}$ ;

Array Gain =  $5 \log(N_{ANT}/N_{SS})$  dB or 3 dB, whichever is less for 20-MHz channel widths with  $N_{ANT} \geq 5$ .

For power measurements on all other devices: Array Gain =  $10 \log(N_{ANT}/N_{SS})$  dB.



#### 4.3.2 Test Setup

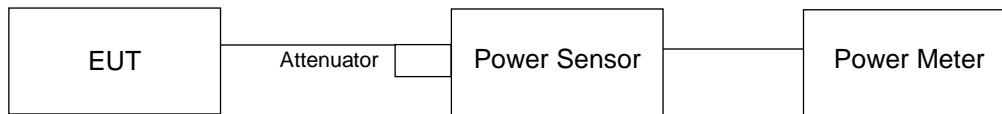

#### 4.3.3 Test Instruments

Refer to section 4.1.2 to get information of above instrument.

#### 4.3.4 Test Procedure

Method PM is used to perform output power measurement, trigger and gating function of wide band power meter is enabled to measure max output power of TX on burst. Duty factor is not added to measured value.

#### 4.3.5 Deviation from Test Standard

No deviation.

#### 4.3.6 EUT Operating Condition

The software provided by client to enable the EUT under transmission condition continuously at lowest, middle and highest channel frequencies individually.

#### 4.3.7 Test Result

#### CDD Mode

#### 802.11a

Chan.	Chan. Freq. (MHz)	Maximum Conducted Power (dBm)			Total Power (mW)	Total Power (dBm)	Limit (dBm)	Pass / Fail
		Chain 0	Chain 1	Chain 2				
36	5180	22.01	21.48	21.83	451.865	26.55	30.00	Pass
40	5200	22.17	21.22	21.94	453.565	26.57	30.00	Pass
48	5240	22.17	21.26	21.99	456.601	26.60	30.00	Pass
149	5745	23.67	23.59	23.54	687.313	28.37	30.00	Pass
157	5785	23.59	23.36	23.34	661.104	28.20	30.00	Pass
165	5825	23.63	22.85	23.17	630.918	28.00	30.00	Pass

#### 802.11ac (VHT20)

Chan.	Chan. Freq. (MHz)	Maximum Conducted Power (dBm)			Total Power (mW)	Total Power (dBm)	Limit (dBm)	Pass / Fail
		Chain 0	Chain 1	Chain 2				
36	5180	21.61	20.92	21.54	411.033	26.14	30.00	Pass
40	5200	22.17	21.57	22.06	469.059	26.71	30.00	Pass
48	5240	22.45	21.45	21.99	473.554	26.75	30.00	Pass
149	5745	23.57	23.48	23.18	658.324	28.18	30.00	Pass
157	5785	23.47	23.18	22.97	628.454	27.98	30.00	Pass
165	5825	23.49	22.79	22.84	605.774	27.82	30.00	Pass

#### 802.11ac (VHT40)

Chan.	Chan. Freq. (MHz)	Maximum Conducted Power (dBm)			Total Power (mW)	Total Power (dBm)	Limit (dBm)	Pass / Fail
		Chain 0	Chain 1	Chain 2				
38	5190	19.46	18.64	19.15	243.646	23.87	30.00	Pass
46	5230	22.85	22.63	22.55	555.87	27.45	30.00	Pass
151	5755	22.59	22.53	22.37	533.197	27.27	30.00	Pass
159	5795	23.57	23.09	23.01	631.2	28.00	30.00	Pass

**802.11ac (VHT80)**

Chan.	Chan. Freq. (MHz)	Maximum Conducted Power (dBm)			Total Power (mW)	Total Power (dBm)	Limit (dBm)	Pass / Fail
		Chain 0	Chain 1	Chain 2				
42	5210	19.33	18.39	19.03	234.711	23.71	30.00	Pass
155	5775	18.06	17.97	17.87	187.869	22.74	30.00	Pass

## Beamforming Mode

### 802.11ac (VHT20)

Chan.	Chan. Freq. (MHz)	Maximum Conducted Power (dBm)			Total Power (mW)	Total Power (dBm)	Limit (dBm)	Pass / Fail
		Chain 0	Chain 1	Chain 2				
36	5180	21.61	20.92	21.54	411.033	26.14	26.76	Pass
40	5200	22.17	21.57	22.06	469.059	26.71	26.76	Pass
48	5240	22.45	21.45	21.99	473.554	26.75	26.76	Pass
149	5745	21.23	21.22	21.02	391.647	25.93	26.39	Pass
157	5785	21.73	21.54	21.17	422.415	26.26	26.39	Pass
165	5825	21.91	20.65	21.15	401.701	26.04	26.39	Pass

- Note:** 1. For U-NII-1: The directional gain =  $10 \log[(10^{G0/20} + 10^{G1/20} + 10^{G2/20})^2 / 3] = 9.24\text{dBi} > 6\text{dBi}$ , so the power density limit shall be reduced to  $30 - (9.24 - 6) = 26.76\text{dBm}$ .
2. For U-NII-3: The directional gain =  $10 \log[(10^{G0/20} + 10^{G1/20} + 10^{G2/20})^2 / 3] = 9.61\text{dBi} > 6\text{dBi}$ , so the power density limit shall be reduced to  $30 - (9.61 - 6) = 26.39\text{dBm}$ .

### 802.11ac (VHT40)

Chan.	Chan. Freq. (MHz)	Maximum Conducted Power (dBm)			Total Power (mW)	Total Power (dBm)	Limit (dBm)	Pass / Fail
		Chain 0	Chain 1	Chain 2				
38	5190	19.46	18.64	19.15	243.646	23.87	26.76	Pass
46	5230	21.40	22.03	21.93	453.581	26.57	26.76	Pass
151	5755	21.89	21.51	21.13	425.822	26.29	26.39	Pass
159	5795	22.18	20.70	20.94	406.851	26.09	26.39	Pass

- Note:** 1. For U-NII-1: The directional gain =  $10 \log[(10^{G0/20} + 10^{G1/20} + 10^{G2/20})^2 / 3] = 9.24\text{dBi} > 6\text{dBi}$ , so the power density limit shall be reduced to  $30 - (9.24 - 6) = 26.76\text{dBm}$ .
2. For U-NII-3: The directional gain =  $10 \log[(10^{G0/20} + 10^{G1/20} + 10^{G2/20})^2 / 3] = 9.61\text{dBi} > 6\text{dBi}$ , so the power density limit shall be reduced to  $30 - (9.61 - 6) = 26.39\text{dBm}$ .

### 802.11ac (VHT80)

Chan.	Chan. Freq. (MHz)	Maximum Conducted Power (dBm)			Total Power (mW)	Total Power (dBm)	Limit (dBm)	Pass / Fail
		Chain 0	Chain 1	Chain 2				
42	5210	19.33	18.39	19.03	234.711	23.71	26.76	Pass
155	5775	18.06	17.97	17.87	187.869	22.74	26.39	Pass

- Note:** 1. For U-NII-1: The directional gain =  $10 \log[(10^{G0/20} + 10^{G1/20} + 10^{G2/20})^2 / 3] = 9.24\text{dBi} > 6\text{dBi}$ , so the power density limit shall be reduced to  $30 - (9.24 - 6) = 26.76\text{dBm}$ .
2. For U-NII-3: The directional gain =  $10 \log[(10^{G0/20} + 10^{G1/20} + 10^{G2/20})^2 / 3] = 9.61\text{dBi} > 6\text{dBi}$ , so the power density limit shall be reduced to  $30 - (9.61 - 6) = 26.39\text{dBm}$ .

## 4.4 Occupied Bandwidth Measurement

### 4.4.1 Test Setup



### 4.4.2 Test Instruments

Refer to section 4.1.2 to get information of above instrument.

### 4.4.3 Test Procedure

The transmitter output was connected to the spectrum analyzer through an attenuator. The bandwidth of the fundamental frequency was measured by spectrum analyzer with resolution bandwidth in the range of 1% to 5% of the anticipated emission bandwidth, and a video bandwidth at least 3x the resolution bandwidth and set the detector to SAMPLE. The width of a frequency band such that, below the lower and above the upper frequency limits, the mean powers emitted are each equal to a specified percentage 0.5% of the total mean power of a given emission.

#### 4.4.4 Test Results

##### 802.11a

Channel	Channel Frequency (MHz)	Occupied Bandwidth (MHz)		
		Chain 0	Chain 1	Chain 2
36	5180	16.44	16.56	16.56
40	5200	16.44	16.44	16.56
48	5240	16.56	16.56	16.44
149	5745	16.56	16.56	16.68
157	5785	16.56	16.68	16.68
165	5825	16.80	16.68	16.68

##### 802.11ac (VHT20)

Channel	Channel Frequency (MHz)	Occupied Bandwidth (MHz)		
		Chain 0	Chain 1	Chain 2
36	5180	17.64	17.64	17.64
40	5200	17.64	17.64	17.64
48	5240	17.64	17.64	17.64
149	5745	17.64	17.64	17.76
157	5785	17.76	17.64	17.76
165	5825	17.76	17.76	17.88

##### 802.11ac (VHT40)

Channel	Channel Frequency (MHz)	Occupied Bandwidth (MHz)		
		Chain 0	Chain 1	Chain 2
38	5190	36.24	36.24	36.24
46	5230	36.24	36.24	36.24
151	5755	36.24	36.24	36.24
159	5795	36.48	36.48	36.72

##### 802.11ac (VHT80)

Channel	Channel Frequency (MHz)	Occupied Bandwidth (MHz)		
		Chain 0	Chain 1	Chain 2
42	5210	75.84	76.32	76.32
155	5775	75.84	76.32	76.32

### Spectrum Plot of Max Value

**802.11a\_Chain0 / CH165**

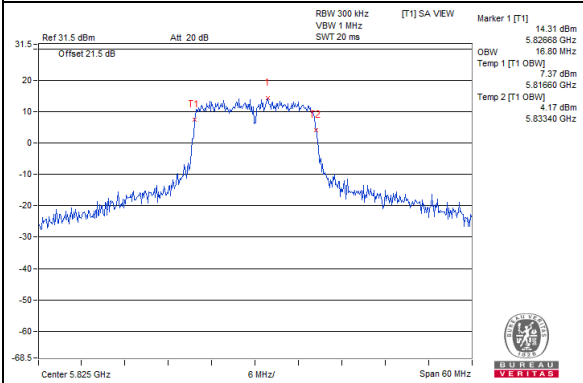

**802.11ac (VHT20)\_Chain2 / CH165**

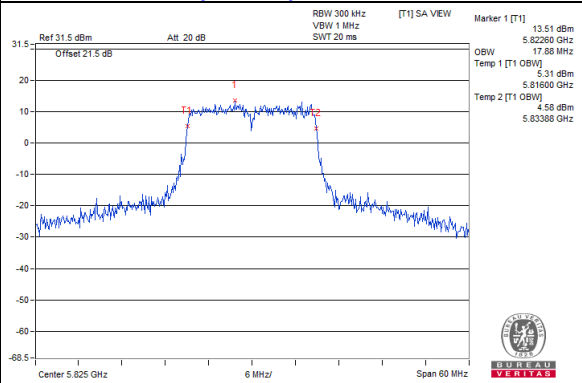

**802.11ac (VHT40)\_Chain2 / CH159**

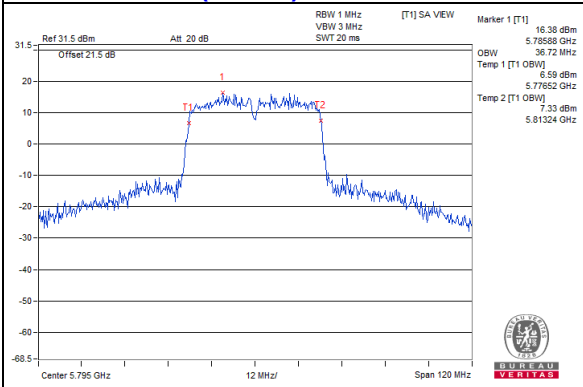

**802.11ac (VHT80)\_Chain1 / CH42**

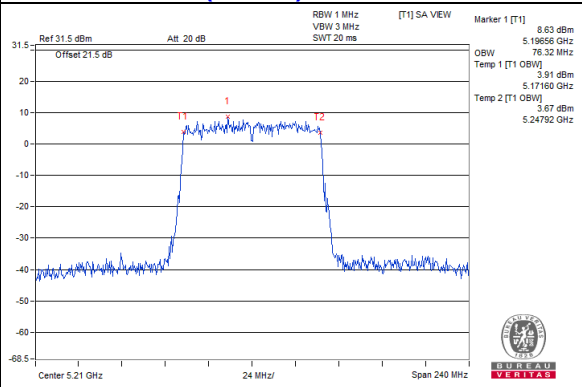

### Spectrum Plot for near by DFS band (DFS is required, if 99% OCP straddle into U-NII-2A band)

**802.11a\_Chain0 / CH48**

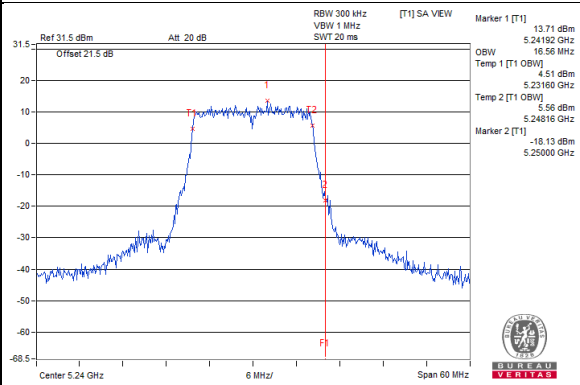

**802.11a\_Chain1 / CH48**

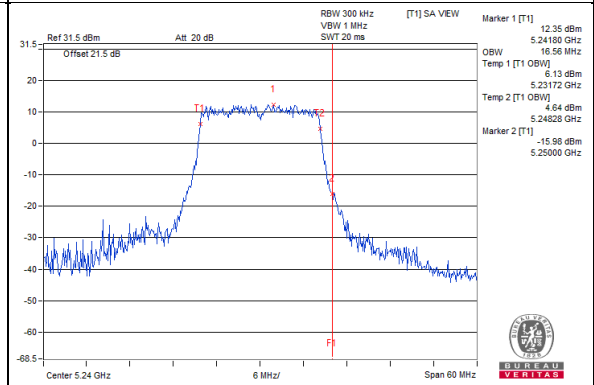

**802.11a\_Chain2 / CH48**

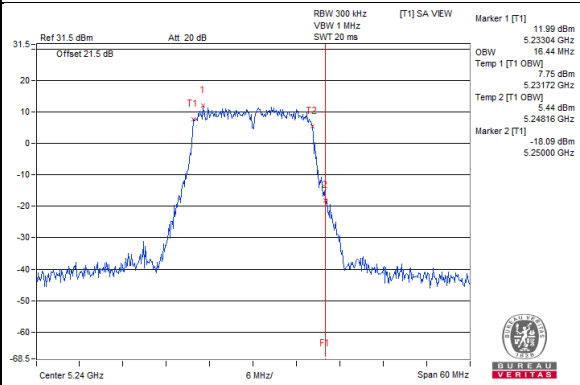

**802.11ac(VHT20)\_Chain0 / CH48**

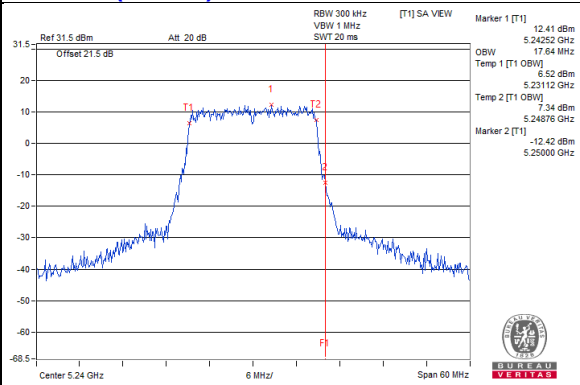

**802.11ac(VHT20)\_Chain1 / CH48**

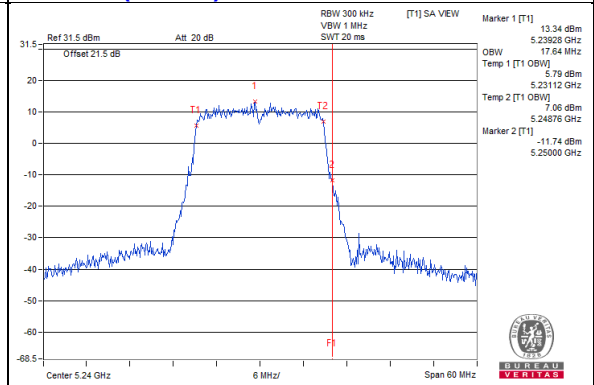

**802.11ac(VHT20)\_Chain2 / CH48**

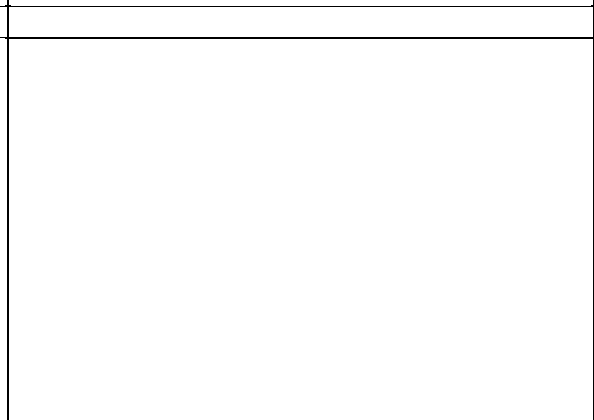
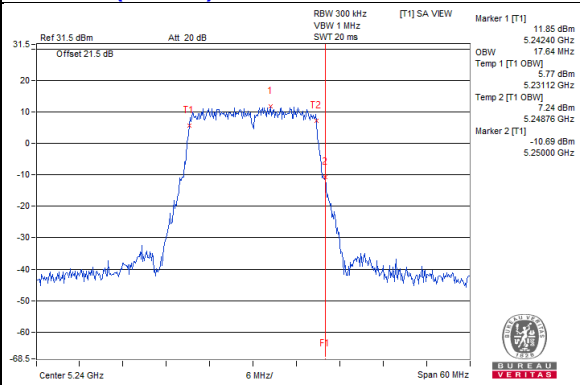



### Spectrum Plot for near by DFS band (DFS is required, if 99% OCP straddle into U-NII-2A band)

**802.11ac(VHT40)\_Chain0 / CH46**

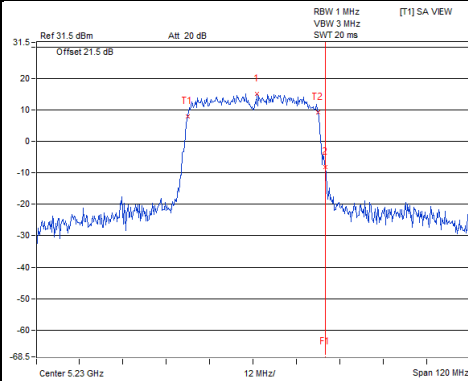

**802.11ac(VHT40)\_Chain1 / CH46**

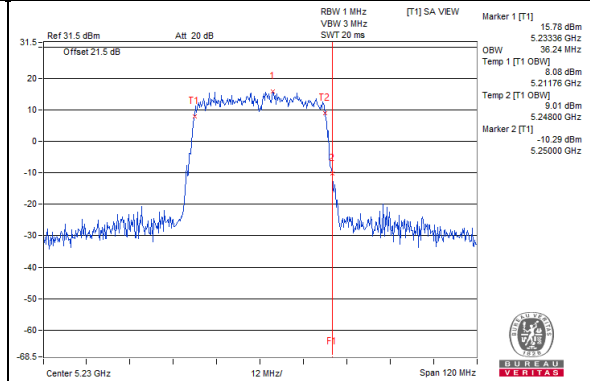

**802.11ac(VHT40)\_Chain2 / CH46**

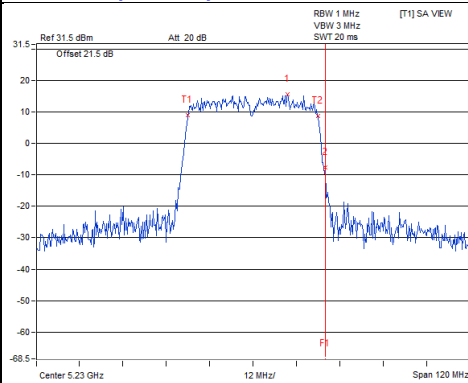

**802.11ac(VHT80)\_Chain0 / CH42**

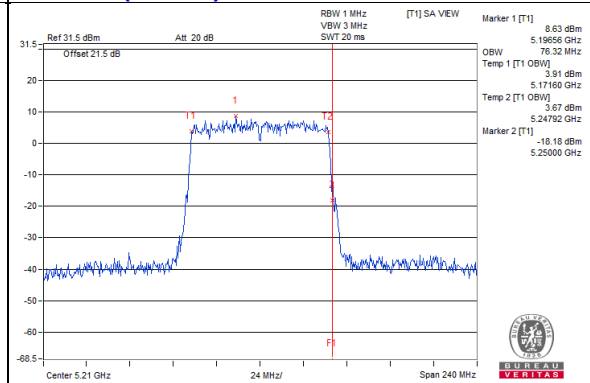
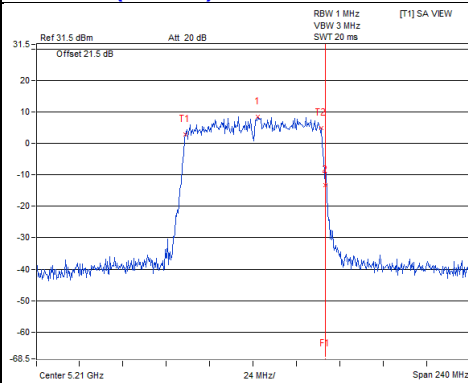

**802.11ac(VHT80)\_Chain2 / CH42**

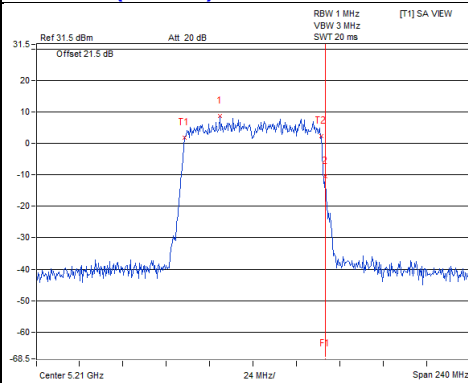

**Spectrum Plot for near by DFS band  
(DFS is required, if 99% OCP straddle into U-NII-2C band)**

**802.11a\_Chain0 / CH149**

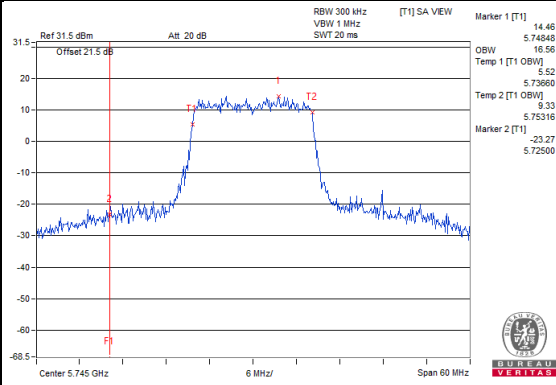

**802.11a\_Chain1 / CH149**

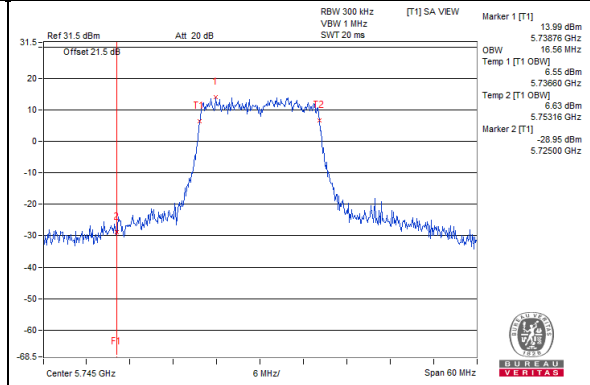

**802.11a\_Chain2 / CH149**

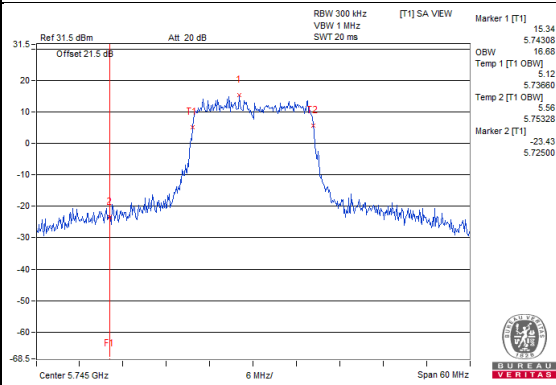

**802.11ac(VHT20)\_Chain0 / CH149**

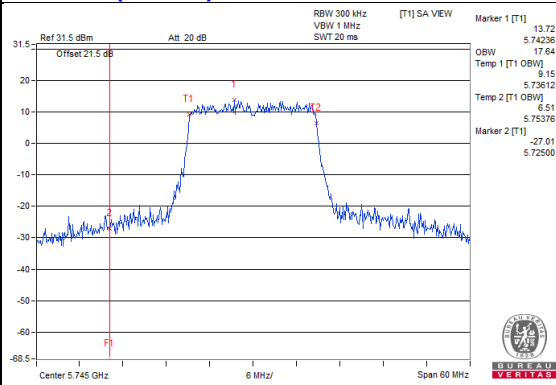

**802.11ac(VHT20)\_Chain1 / CH149**

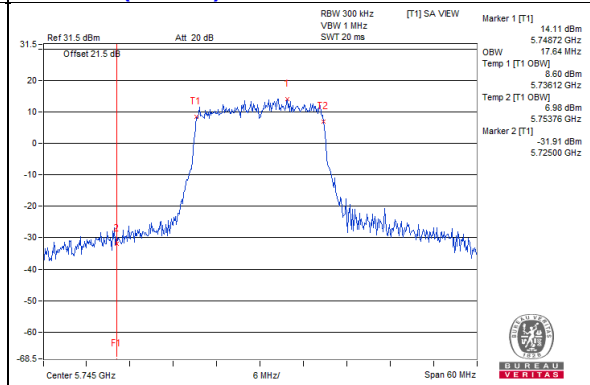

**802.11ac(VHT20)\_Chain2 / CH149**

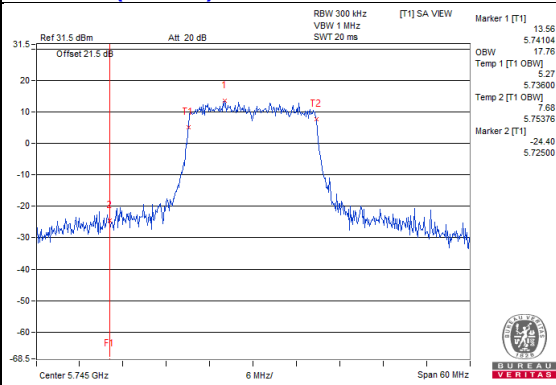

### Spectrum Plot for near by DFS band (DFS is required, if 99% OCP straddle into U-NII-2C band)

**802.11ac(VHT40)\_Chain0 / CH151**

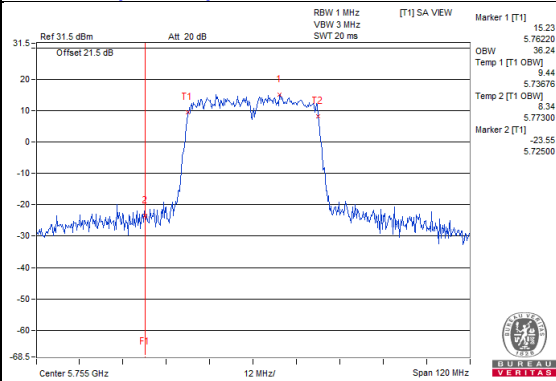

**802.11ac(VHT40)\_Chain1 / CH151**

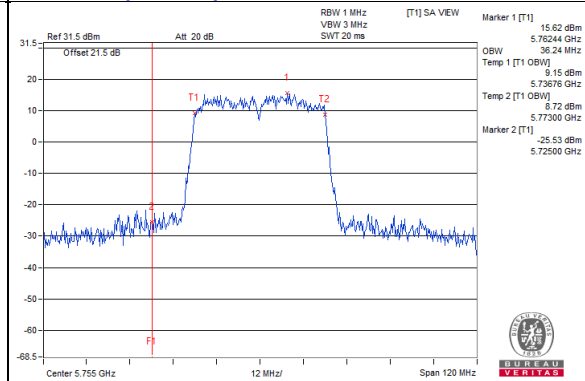

**802.11ac(VHT40)\_Chain2 / CH151**

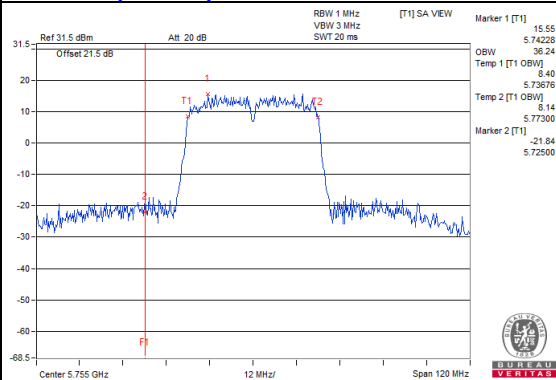

**802.11ac(VHT80)\_Chain0 / CH155**

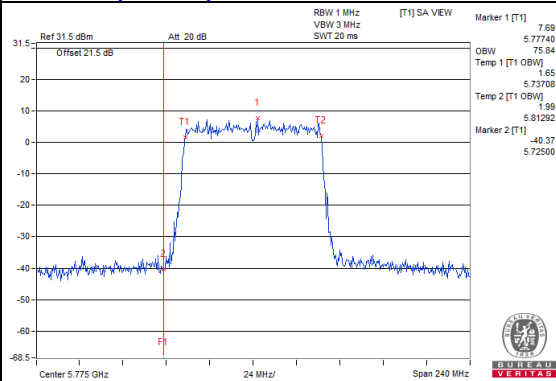

**802.11ac(VHT80)\_Chain1 / CH155**

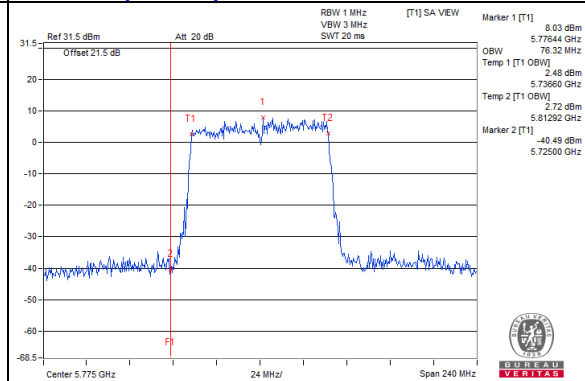

**802.11ac(VHT80)\_Chain2 / CH155**

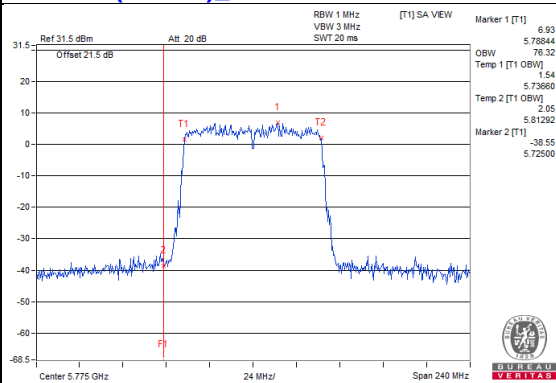

## 4.5 Peak Power Spectral Density Measurement

### 4.5.1 Limits of Peak Power Spectral Density Measurement

Operation Band	EUT Category		Limit
U-NII-1		Outdoor Access Point	17dBm/ MHz
		Fixed point-to-point Access Point	
	√	Indoor Access Point	
		Client device	11dBm/ MHz
U-NII-2A			11dBm/ MHz
U-NII-2C			11dBm/ MHz
U-NII-3	√		30dBm/ 500kHz

### 4.5.2 Test Setup

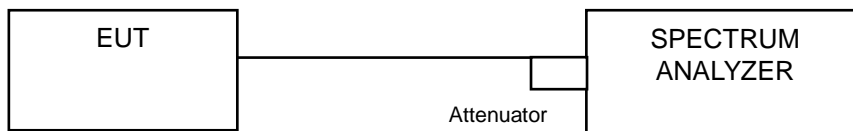

### 4.5.3 Test Instruments

Refer to section 4.1.2 to get information of above instrument.

### 4.5.4 Test Procedure

#### For 802.11ac (VHT20):

#### For U-NII-1:

Using method SA-1

1. Set span to encompass the entire emission bandwidth (EBW) of the signal.
2. Set RBW = 1 MHz, Set VBW ≥ 3 MHz, Detector = RMS
3. Sweep time = auto, trigger set to “free run”.
4. Trace average at least 100 traces in power averaging mode.
5. Record the max value

#### For U-NII-3:

1. Set span to encompass the entire emission bandwidth (EBW) of the signal.
2. Set RBW = 300 kHz, Set VBW ≥ 1 MHz, Detector = RMS
3. Use the peak marker function to determine the maximum power level in any 300 kHz band segment within the fundamental EBW.
4. Scale the observed power level to an equivalent value in 500 kHz by adjusting (reducing) the measured power by a bandwidth correction factor (BWCF) where  $BWCF = 10\log(500\text{ kHz}/300\text{ kHz})$
5. Sweep time = auto, trigger set to “free run”.
6. Trace average at least 100 traces in power averaging mode.
7. Record the max value

**For 802.11a, 802.11ac (VHT40), 802.11ac (VHT80):**

**For U-NII-1:**

Using method SA-2

1. Set span to encompass the entire emission bandwidth (EBW) of the signal.
2. Set RBW = 1 MHz, Set VBW  $\geq$  3 MHz, Detector = RMS
3. Sweep time = auto, trigger set to "free run".
4. Trace average at least 100 traces in power averaging mode.
5. Record the max value and add  $10 \log (1/\text{duty cycle})$

**For U-NII-3:**

1. Set span to encompass the entire emission bandwidth (EBW) of the signal.
2. Set RBW = 300 kHz, Set VBW  $\geq$  1 MHz, Detector = RMS
3. Use the peak marker function to determine the maximum power level in any 300 kHz band segment within the fundamental EBW.
4. Scale the observed power level to an equivalent value in 500 kHz by adjusting (reducing) the measured power by a bandwidth correction factor (BWCF) where  $\text{BWCF} = 10\log(500 \text{ kHz}/300\text{kHz})$
5. Sweep time = auto, trigger set to "free run".
6. Trace average at least 100 traces in power averaging mode.
7. Record the max value and add  $10 \log (1/\text{duty cycle})$

4.5.5 Deviation from Test Standard

No deviation.

4.5.6 EUT Operating Condition

Same as Item 4.3.6.

#### 4.5.7 Test Results

##### For U-NII-1: 802.11a

Chan.	Freq. (MHz)	PSD W/O Duty Factor (dBm/MHz)			Duty Factor (dB)	Total PSD With Duty Factor (dBm/MHz)	MAX. Limit (dBm/MHz)	Pass / Fail
		Chain 0	Chain 1	Chain 2				
36	5180	7.10	7.78	7.47	0.15	12.38	13.76	Pass
40	5200	8.15	8.18	7.36	0.15	12.83	13.76	Pass
48	5240	8.25	7.67	7.59	0.15	12.77	13.76	Pass

- Note:** 1. Method a) of power density measurement of KDB 662911 is using for calculating total power density. Total power density is summing entire spectra across corresponding frequency bins on the various outputs by computer.
2. Directional gain =  $10 \log[(10^{G0/20} + 10^{G1/20} + 10^{G2/20})^2 / 3] = 9.24\text{dBi} > 6\text{dBi}$ , so the power density limit shall be reduced to  $17-(9.24-6) = 13.76\text{dBm}$ .
3. Refer to section 3.3 for duty cycle spectrum plot.

##### 802.11ac (VHT20)

Chan.	Freq. (MHz)	PSD (dBm/MHz)			Total Power Density (dBm/MHz)	MAX. Limit (dBm/MHz)	Pass / Fail
		Chain 0	Chain 1	Chain 2			
36	5180	7.36	7.55	6.84	12.03	13.76	Pass
40	5200	8.41	8.25	7.52	12.85	13.76	Pass
48	5240	8.20	8.19	7.55	12.76	13.76	Pass

- Note:** 1. Method a) of power density measurement of KDB 662911 is using for calculating total power density. Total power density is summing entire spectra across corresponding frequency bins on the various outputs by computer.
2. Directional gain =  $10 \log[(10^{G0/20} + 10^{G1/20} + 10^{G2/20})^2 / 3] = 9.24\text{dBi} > 6\text{dBi}$ , so the power density limit shall be reduced to  $17-(9.24-6) = 13.76\text{dBm}$ .

##### 802.11ac (VHT40)

Chan.	Freq. (MHz)	PSD W/O Duty Factor (dBm/MHz)			Duty Factor (dB)	Total PSD With Duty Factor (dBm/MHz)	MAX. Limit (dBm/MHz)	Pass / Fail
		Chain 0	Chain 1	Chain 2				
38	5190	2.22	2.52	1.76	0.15	7.10	13.76	Pass
46	5230	5.83	5.63	5.61	0.15	10.61	13.76	Pass

- Note:** 1. Method a) of power density measurement of KDB 662911 is using for calculating total power density. Total power density is summing entire spectra across corresponding frequency bins on the various outputs by computer.
2. Directional gain =  $10 \log[(10^{G0/20} + 10^{G1/20} + 10^{G2/20})^2 / 3] = 9.24\text{dBi} > 6\text{dBi}$ , so the power density limit shall be reduced to  $17-(9.24-6) = 13.76\text{dBm}$ .
3. Refer to section 3.3 for duty cycle spectrum plot.

**802.11ac (VHT80)**

Chan.	Freq. (MHz)	PSD W/O Duty Factor (dBm/MHz)			Duty Factor (dB)	Total PSD With Duty Factor (dBm/MHz)	MAX. Limit (dBm/MHz)	Pass / Fail
		Chain 0	Chain 1	Chain 2				
42	5210	-1.85	-1.82	-1.71	0.27	3.25	13.76	Pass

- Note:**
- Method a) of power density measurement of KDB 662911 is using for calculating total power density. Total power density is summing entire spectra across corresponding frequency bins on the various outputs by computer.
  - Directional gain =  $10 \log[(10^{G0/20} + 10^{G1/20} + 10^{G2/20})^2 / 3] = 9.24\text{dBi} > 6\text{dBi}$  , so the power density limit shall be reduced to  $17-(9.24-6) = 13.76\text{dBm}$ .
  - Refer to section 3.3 for duty cycle spectrum plot.

### Spectrum Plot of Worst Value

#### 802.11a\_Chain 0 / CH48

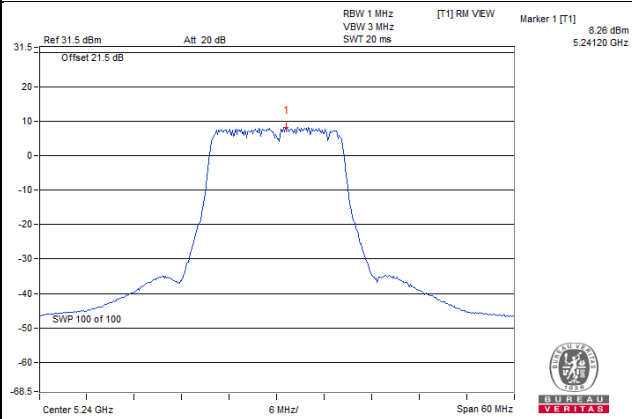

#### 802.11ac (VHT20)\_Chain 0 / CH40

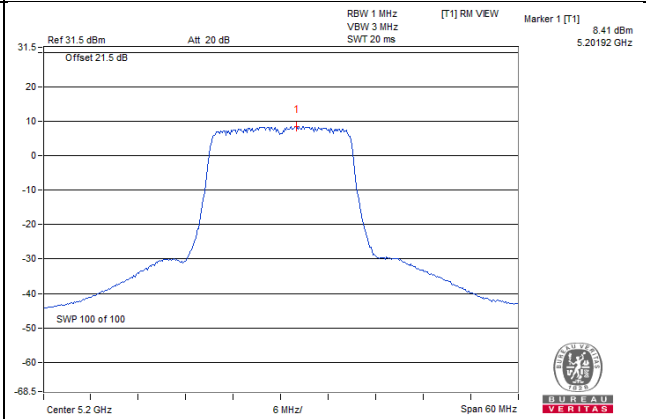

#### 802.11ac (VHT40)\_Chain 0 / CH46

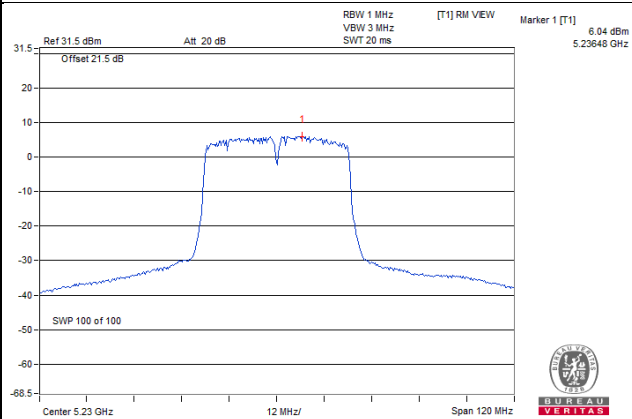

#### 802.11ac (VHT80)\_Chain 2 / CH42

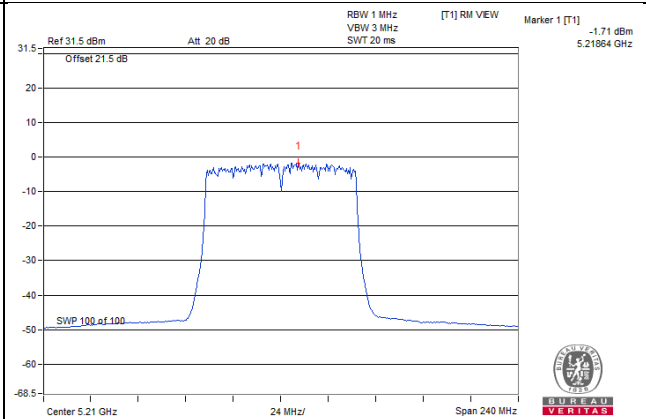



**For U-NII-3:  
802.11a**

Chan.	Freq. (MHz)	PSD W/O Duty Factor (dBm/300kHz)			Total PSD With Duty Factor		Duty Factor (dB)	Total PSD With Duty Factor (dBm/500kHz)	Limit (dBm/500kHz)	Pass /Fail
		Chain 0	Chain 1	Chain 2	mW/300kHz	dBm/300kHz				
149	5745	1.86	1.74	1.73	4.673	6.70	0.15	8.92	26.39	Pass
157	5785	2.23	2.07	1.39	4.8201	6.83	0.15	9.05	26.39	Pass
165	5825	2.12	1.48	1.23	4.5136	6.55	0.15	8.77	26.39	Pass

- Note:**
- Method b) Measure and sum spectral maxima across the outputs of KDB 662911 is using for calculating total power density.
  - Directional gain =  $10 \log[(10^{G0/20} + 10^{G1/20} + 10^{G2/20})^2 / 3] = 9.61 \text{dBi} > 6 \text{dBi}$  , so the power density limit shall be reduced to  $30 - (9.61 - 6) = 26.39 \text{dBm}$ .
  - Refer to section 3.3 for duty cycle spectrum plot.

**802.11ac (VHT20)**

Chan.	Freq. (MHz)	PSD (dBm/300kHz)			Total PSD		Total PSD (dBm/500kHz)	Limit (dBm/500kHz)	Pass /Fail
		Chain 0	Chain 1	Chain 2	mW/300kHz	dBm/300kHz			
149	5745	1.57	1.42	1.25	4.1558	6.19	8.41	26.39	Pass
157	5785	1.33	1.95	0.80	4.1273	6.16	8.38	26.39	Pass
165	5825	1.23	1.54	0.93	3.9918	6.01	8.23	26.39	Pass

- Note:**
- Method b) Measure and sum spectral maxima across the outputs of KDB 662911 is using for calculating total power density.
  - Directional gain =  $10 \log[(10^{G0/20} + 10^{G1/20} + 10^{G2/20})^2 / 3] = 9.61 \text{dBi} > 6 \text{dBi}$  , so the power density limit shall be reduced to  $30 - (9.61 - 6) = 26.39 \text{dBm}$ .

**802.11ac (VHT40)**

Total PSD mW/300kHz	Freq. (MHz)	PSD W/O Duty Factor (dBm/300kHz)			Total PSD With Duty Factor		Duty Factor (dB)	Total PSD With Duty Factor (dBm/500kHz)	Limit (dBm/500kHz)	Pass /Fail
		Chain 0	Chain 1	Chain 2	mW/300 kHz	dBm/300k Hz				
151	5755	-2.64	-2.31	-2.35	1.7746	2.49	0.15	4.71	26.39	Pass
159	5795	-1.96	-1.31	-2.44	2.0153	3.04	0.15	5.26	26.39	Pass

- Note:**
- Method b) Measure and sum spectral maxima across the outputs of KDB 662911 is using for calculating total power density.
  - Directional gain =  $10 \log[(10^{G0/20} + 10^{G1/20} + 10^{G2/20})^2 / 3] = 9.61 \text{dBi} > 6 \text{dBi}$  , so the power density limit shall be reduced to  $30 - (9.61 - 6) = 26.39 \text{dBm}$ .
  - Refer to section 3.3 for duty cycle spectrum plot.

### 802.11ac (VHT80)

Chan.	Freq. (MHz)	PSD W/O Duty Factor (dBm/300kHz)			Total PSD With Duty Factor		Duty Factor (dB)	Total PSD With Duty Factor (dBm/500kHz)	Limit (dBm/500kHz)	Pass /Fail
		Chain 0	Chain 1	Chain 2	mW/300kHz	dBm/300kHz				
155	5775	-10.89	-10.36	-11.15	0.26614	-5.75	0.27	-3.53	26.39	Pass

- Note:**
- Method b) Measure and sum spectral maxima across the outputs of KDB 662911 is using for calculating total power density.
  - Directional gain =  $10 \log[(10^{G0/20} + 10^{G1/20} + 10^{G2/20})^2 / 3] = 9.61 \text{dBi} > 6 \text{dBi}$  , so the power density limit shall be reduced to  $30 - (9.61 - 6) = 26.39 \text{dBm}$ .
  - Refer to section 3.3 for duty cycle spectrum plot.

### Spectrum Plot of Worst Value

**802.11a\_Chain 0 / CH157**

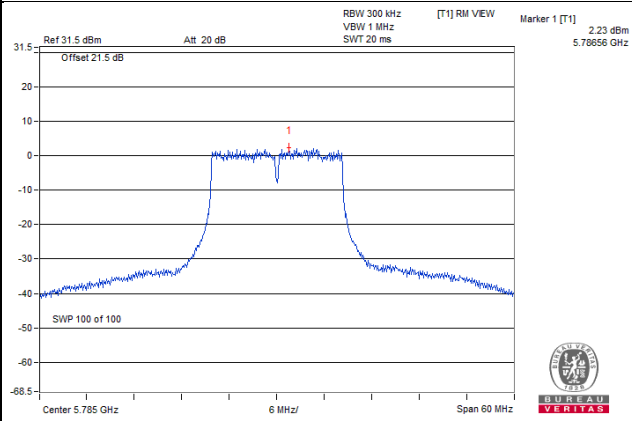

**802.11ac (VHT20)\_Chain 1 / CH157**

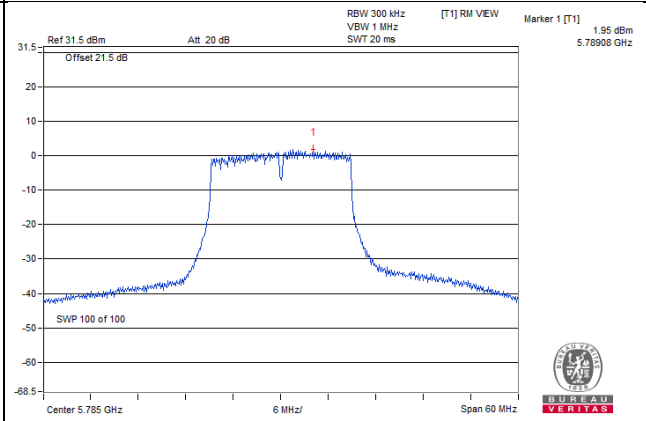

**802.11ac (VHT40)\_Chain 1 / CH159**

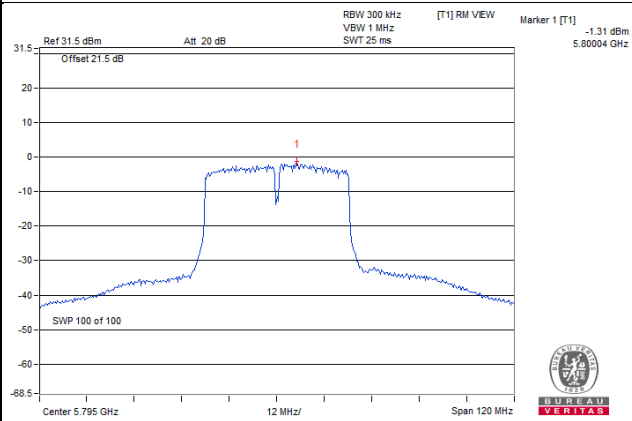

**802.11ac (VHT80)\_Chain 1 / CH155**

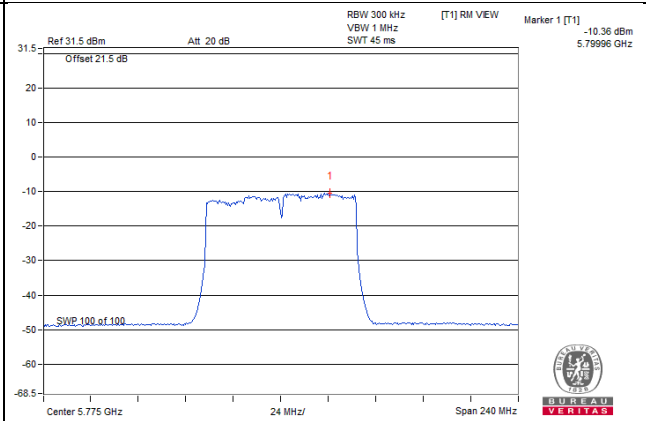

## 4.6 Frequency Stability Measurement

### 4.6.1 Limits of Frequency Stability Measurement

The frequency of the carrier signal shall be maintained within band of operation

### 4.6.2 Test Setup

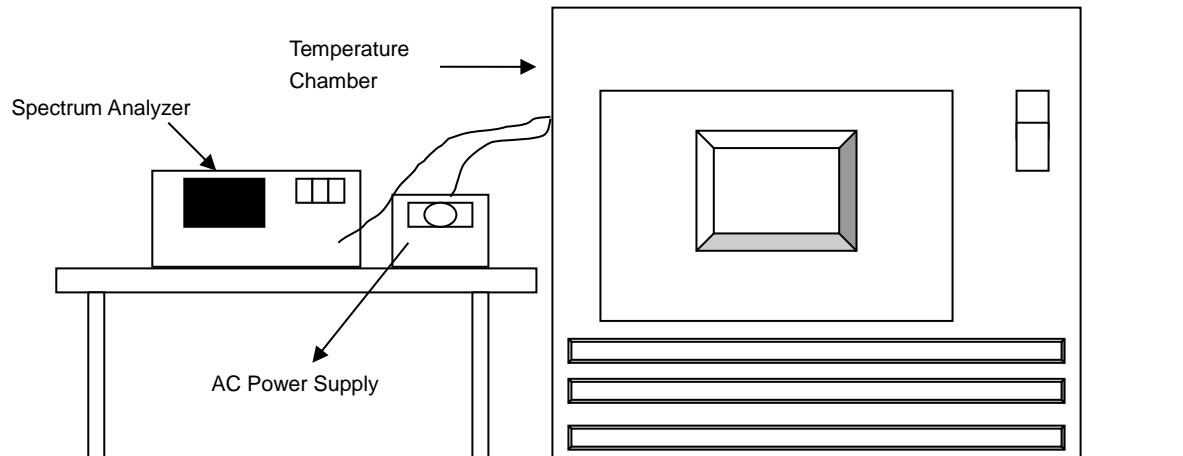

### 4.6.3 Test Instruments

Refer to section 4.1.2 to get information of above instrument.

### 4.6.4 Test Procedure

- The EUT was placed inside the environmental test chamber and powered by nominal AC voltage.
- Turn the EUT on and couple its output to a spectrum analyzer.
- Turn the EUT off and set the chamber to the highest temperature specified.
- Allow sufficient time (approximately 30 min) for the temperature of the chamber to stabilize, turn the EUT on and measure the operating frequency after 2, 5, and 10 Minutes.
- Repeat step (d) with the temperature chamber set to the next desired temperature until measurements down to the lowest specified temperature have been completed..
- The test chamber was allowed to stabilize at +20 degree C for a minimum of 30 Minutes. The supply voltage was then adjusted on the EUT from 85% to 115% and the frequency record.

### 4.6.5 Deviation from Test Standard

No deviation.

### 4.6.6 EUT Operating Condition

Set the EUT transmit at un-modulation mode to test frequency stability.

## 4.6.7 Test Results

Frequency Stability Versus Temp.									
Operating Frequency: 5180 MHz									
TEMP. (°C)	Power Supply (Vac)	0 Minute		2 Minutes		5 Minutes		10 Minutes	
		Measured Frequency (MHz)	Pass/Fail	Measured Frequency (MHz)	Pass/Fail	Measured Frequency (MHz)	Pass/Fail	Measured Frequency (MHz)	Pass/Fail
40	120	5179.9991	PASS	5179.9964	PASS	5179.9969	PASS	5180.0009	PASS
30	120	5179.9924	PASS	5179.9943	PASS	5179.9949	PASS	5179.9943	PASS
20	120	5179.9976	PASS	5180.0015	PASS	5179.9974	PASS	5179.9983	PASS
10	120	5180.0126	PASS	5180.0113	PASS	5180.0094	PASS	5180.0088	PASS
0	120	5180.0156	PASS	5180.0154	PASS	5180.0163	PASS	5180.0159	PASS

Frequency Stability Versus Voltage									
Operating Frequency: 5180 MHz									
TEMP. (°C)	Power Supply (Vac)	0 Minute		2 Minutes		5 Minutes		10 Minutes	
		Measured Frequency (MHz)	Pass/Fail	Measured Frequency (MHz)	Pass/Fail	Measured Frequency (MHz)	Pass/Fail	Measured Frequency (MHz)	Pass/Fail
20	138	5180.0125	PASS	5180.0117	PASS	5180.0101	PASS	5180.0091	PASS
	120	5180.0126	PASS	5180.0113	PASS	5180.0094	PASS	5180.0088	PASS
	102	5180.0127	PASS	5180.0119	PASS	5180.0098	PASS	5180.0097	PASS

## 4.7 6dB Bandwidth Measurement

### 4.7.1 Limits of 6dB Bandwidth Measurement

The minimum of 6dB Bandwidth Measurement is 0.5MHz.

### 4.7.2 Test Setup

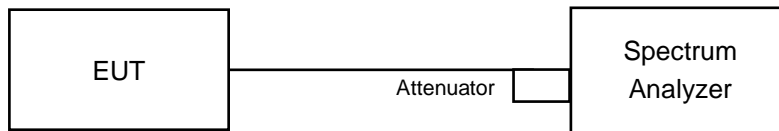

### 4.7.3 Test Instruments

Refer to section 4.1.2 to get information of above instrument.

### 4.7.4 Test Procedure

#### MEASUREMENT PROCEDURE REF

- a. Set resolution bandwidth (RBW) = 100kHz
- b. Set the video bandwidth (VBW)  $\geq 3 \times$  RBW, Detector = Peak.
- c. Trace mode = max hold.
- d. Sweep = auto couple.
- e. Measure the maximum width of the emission that is constrained by the frequencies associated with the two amplitude points (upper and lower) that are attenuated by 6 dB relative to the maximum level measured in the fundamental emission

### 4.7.5 Deviation from Test Standard

No deviation.

### 4.7.6 EUT Operating Condition

The software provided by client to enable the EUT under transmission condition continuously at lowest, middle and highest channel frequencies individually.

#### 4.7.7 Test Results

##### 802.11a

Channel	Frequency (MHz)	6dB Bandwidth (MHz)			Minimum Limit (MHz)	Pass / Fail
		Chain 0	Chain 1	Chain 2		
149	5745	16.40	16.38	16.39	0.5	PASS
157	5785	16.38	16.39	16.39	0.5	PASS
165	5825	16.38	16.39	16.40	0.5	PASS

##### 802.11ac (VHT20)

Channel	Frequency (MHz)	6dB Bandwidth (MHz)			Minimum Limit (MHz)	Pass / Fail
		Chain 0	Chain 1	Chain 2		
149	5745	17.60	16.97	17.61	0.5	PASS
157	5785	17.58	16.98	17.64	0.5	PASS
165	5825	17.60	17.35	17.62	0.5	PASS

##### 802.11ac (VHT40)

Channel	Frequency (MHz)	6dB Bandwidth (MHz)			Minimum Limit (MHz)	Pass / Fail
		Chain 0	Chain 1	Chain 2		
151	5755	35.95	35.99	35.46	0.5	PASS
159	5795	34.26	35.18	35.13	0.5	PASS

##### 802.11ac (VHT80)

Channel	Frequency (MHz)	6dB Bandwidth (MHz)			Minimum Limit (MHz)	Pass / Fail
		Chain 0	Chain 1	Chain 2		
155	5775	76.46	76.05	76.34	0.5	PASS

### Spectrum Plot of Worst Value

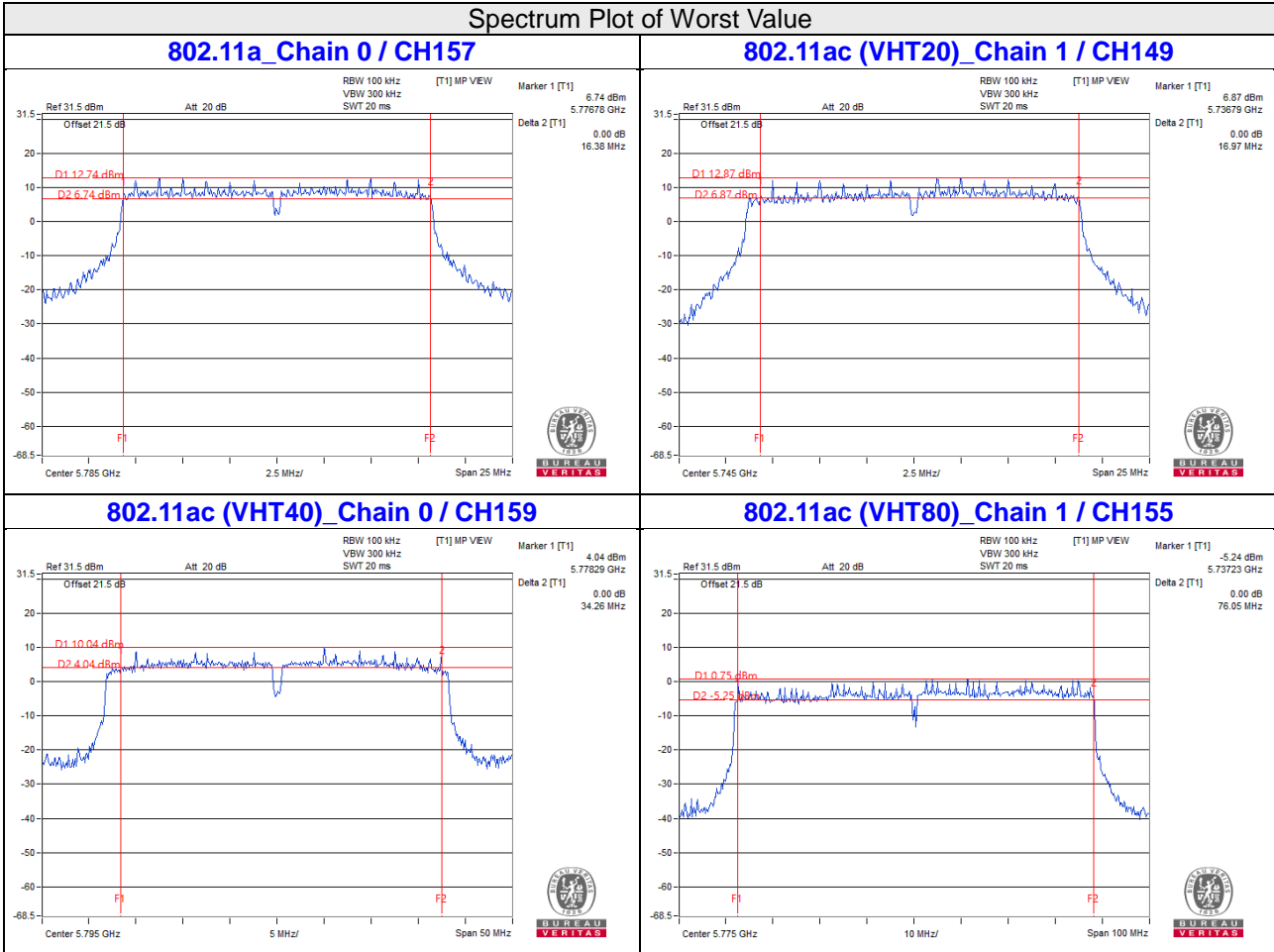



## 5 Pictures of Test Arrangements

Please refer to the attached file (Test Setup Photo).

## Annex A- Radiated Out of Band Emission (OOBE) Measurement (For U-NII-3 band)

802.11a

**CH 149 5745 MHz**

**Horizontal**

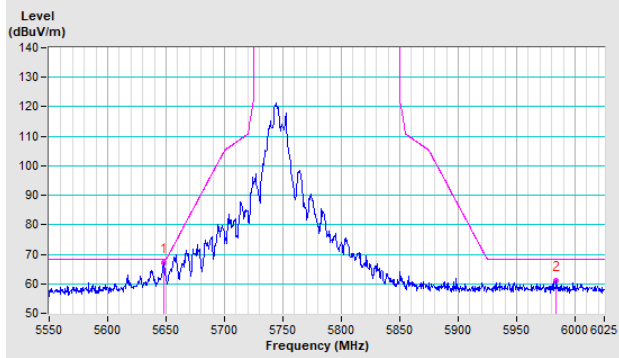

**Vertical**

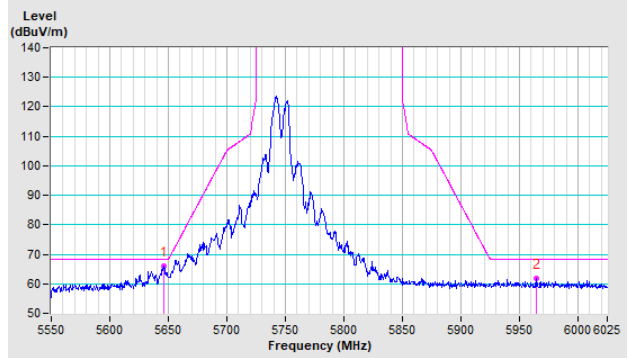

**CH 157 5785 MHz**

**Horizontal**

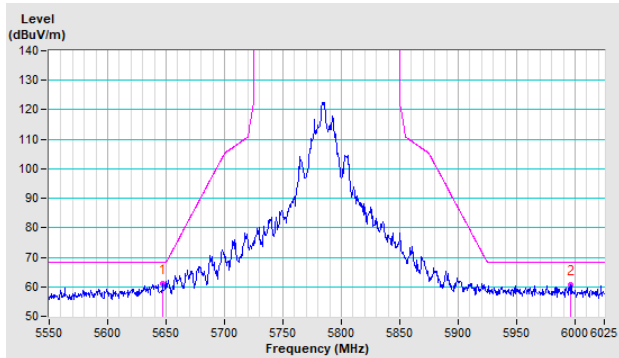

**Vertical**

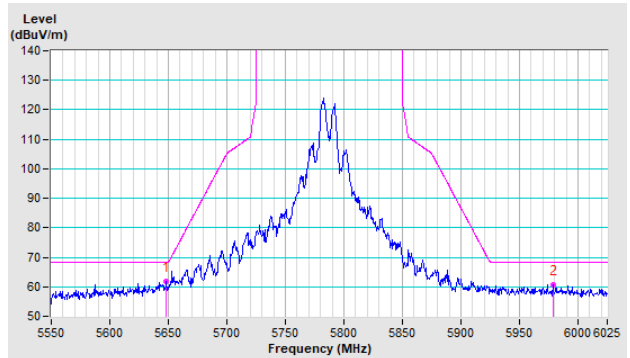

**CH 165 5825 MHz**

**Horizontal**

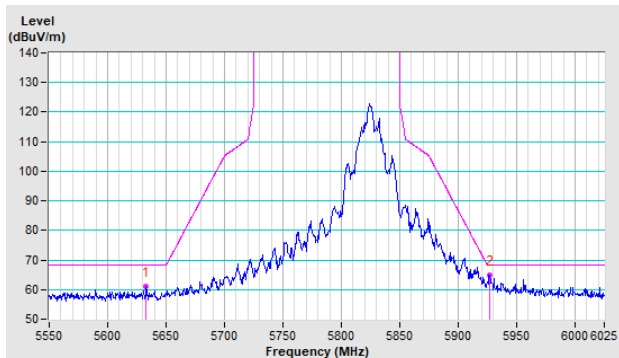

**Vertical**

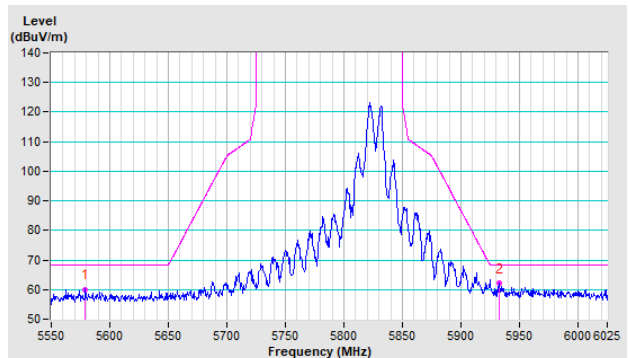

### 802.11ac (VHT20)

**CH 149 5745 MHz**

**Horizontal**

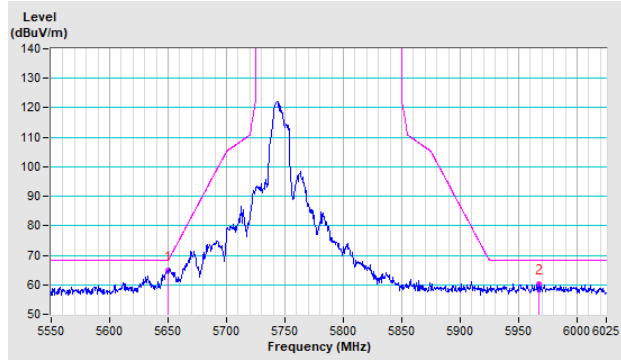

**Vertical**

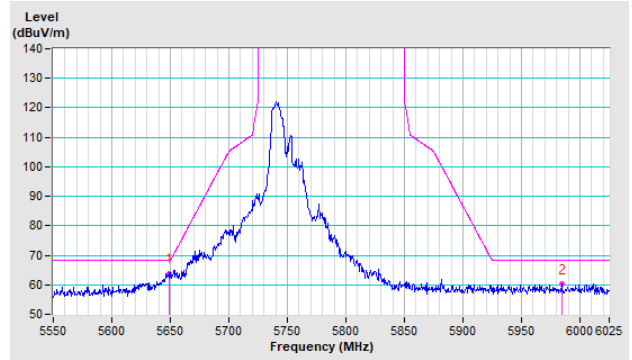

**CH 157 5785 MHz**

**Horizontal**

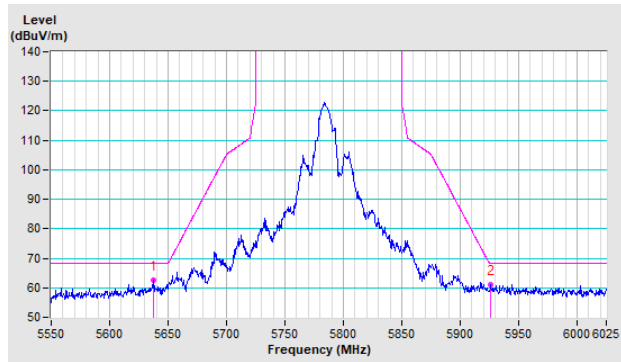

**Vertical**

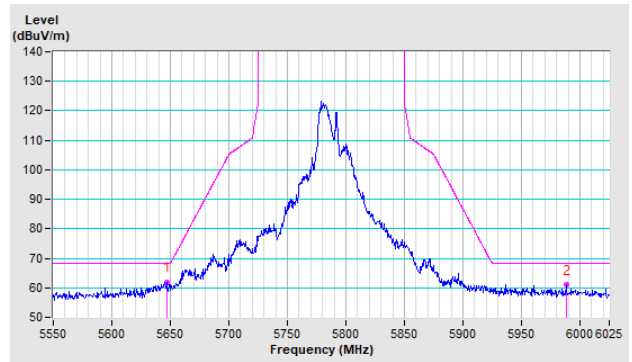

**CH 165 5825 MHz**

**Horizontal**

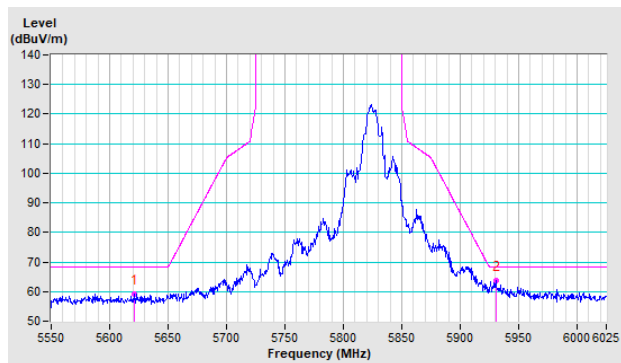

**Vertical**

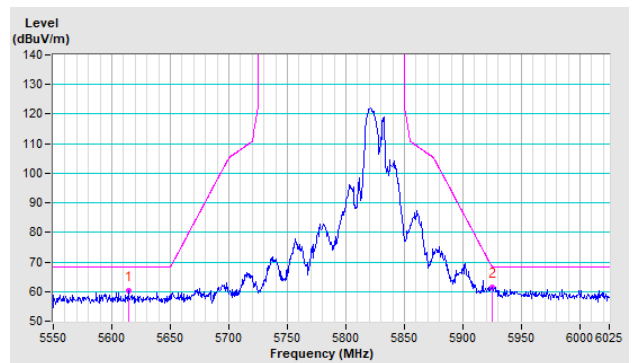

### 802.11ac (VHT40)

**CH 151 5755 MHz**

**Horizontal**

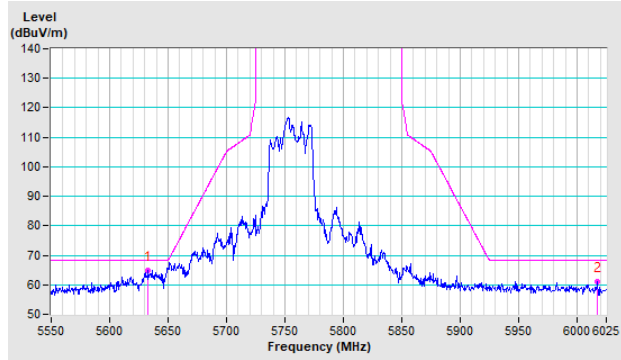

**Vertical**

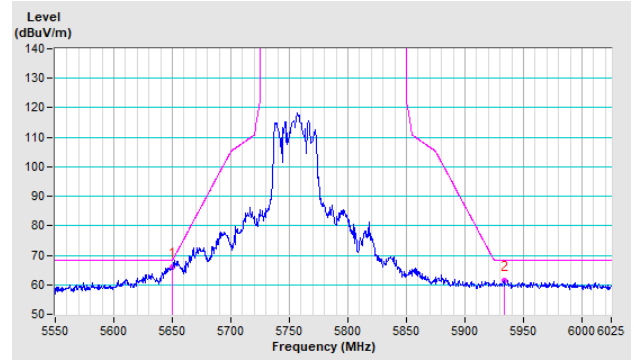

**CH 159 5795 MHz**

**Horizontal**

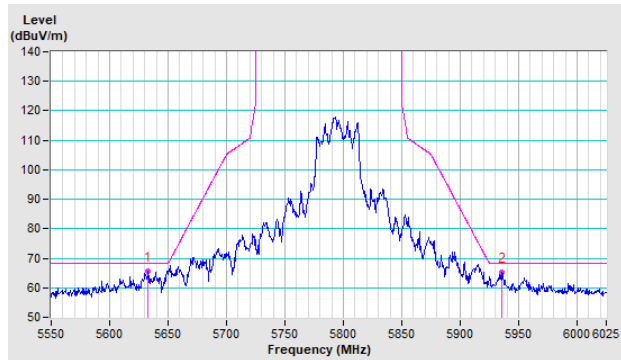

**Vertical**

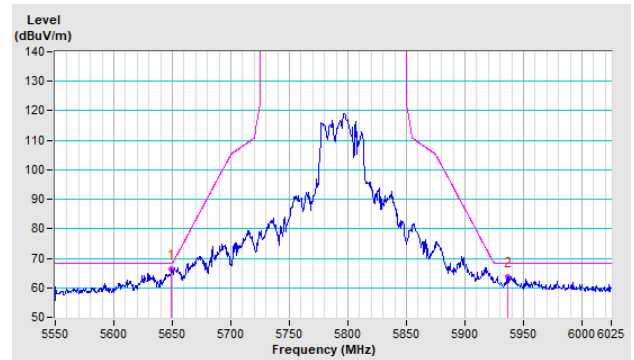

### 802.11ac (VHT80)

**CH 155 5775 MHz**

**Horizontal**

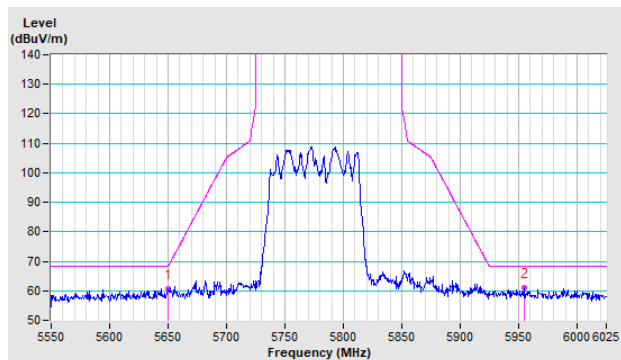

**Vertical**

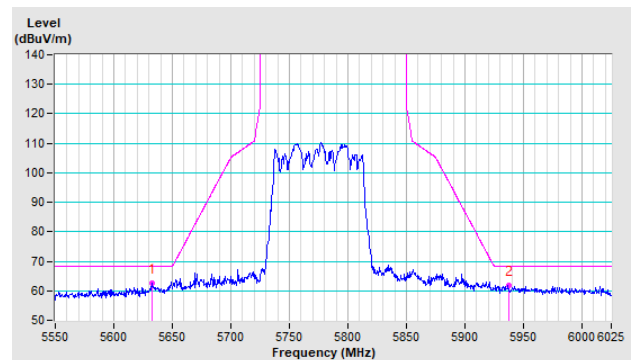

## Appendix – Information of the Testing Laboratories

We, Bureau Veritas Consumer Products Services (H.K.) Ltd., Taoyuan Branch, were founded in 1988 to provide our best service in EMC, Radio, Telecom and Safety consultation. Our laboratories are FCC recognized accredited test firms and accredited according to ISO/IEC 17025.

If you have any comments, please feel free to contact us at the following:

**Lin Kou EMC/RF Lab**

Tel: 886-2-26052180

Fax: 886-2-26051924

**Hsin Chu EMC/RF/Telecom Lab**

Tel: 886-3-6668565

Fax: 886-3-6668323

**Hwa Ya EMC/RF/Safety Lab**

Tel: 886-3-3183232

Fax: 886-3-3270892

**Email:** [service.adt@tw.bureauveritas.com](mailto:service.adt@tw.bureauveritas.com)

**Web Site:** [www.bureauveritas-adt.com](http://www.bureauveritas-adt.com)

The address and road map of all our labs can be found in our web site also.

--- END ---