

FCC Test Report

Report No.: RF160822E04G-1

FCC ID: KA2BA1210PA1

Test Model: DBA-1210P

Received Date: Aug. 22, 2016

Test Date: Sep. 02 to 19, 2016

Issued Date: Feb. 22, 2017

Applicant: D-Link Corporation

Address: No.289, Xinhua 3rd Rd., Neihu District, Taipei City 11494, Taiwan, R.O.C.

Issued By: Bureau Veritas Consumer Products Services (H.K.) Ltd., Taoyuan Branch
Hsin Chu Laboratory

Lab Address: E-2, No.1, Li Hsin 1st Road, Hsinchu Science Park, Hsinchu City 300,
Taiwan R.O.C.

Test Location (1): E-2, No.1, Li Hsin 1st Road, Hsinchu Science Park, Hsinchu City 300,
Taiwan R.O.C.

Test Location (2): No. 49, Ln. 206, Wende Rd., Shangshan Tsuen, Chiung Lin Hsiang, Hsin
Chu Hsien 307, Taiwan R.O.C.



This report is for your exclusive use. Any copying or replication of this report to or for any other person or entity, or use of our name or trademark, is permitted only with our prior written permission. This report sets forth our findings solely with respect to the test samples identified herein. The results set forth in this report are not indicative or representative of the quality or characteristics of the lot from which a test sample was taken or any similar or identical product unless specifically and expressly noted. Our report includes all of the tests requested by you and the results thereof based upon the information that you provided to us. You have 60 days from date of issuance of this report to notify us of any material error or omission caused by our negligence, provided, however, that such notice shall be in writing and shall specifically address the issue you wish to raise. A failure to raise such issue within the prescribed time shall constitute your unqualified acceptance of the completeness of this report, the tests conducted and the correctness of the report contents. Unless specific mention, the uncertainty of measurement has been explicitly taken into account to declare the compliance or non-compliance to the specification. The report must not be used by the client to claim product certification, approval, or endorsement by TAF or any government agencies.

Table of Contents

Release Control Record	4
1 Certificate of Conformity	5
2 Summary of Test Results	6
2.1 Measurement Uncertainty	6
2.2 Modification Record	6
3 General Information	7
3.1 General Description of EUT	7
3.2 Description of Test Modes	9
3.2.1 Test Mode Applicability and Tested Channel Detail	10
3.3 Duty Cycle of Test Signal	12
3.4 Description of Support Units	13
3.4.1 Configuration of System under Test	14
3.5 General Description of Applied Standard	16
4 Test Types and Results	17
4.1 Radiated Emission and Bandedge Measurement	17
4.1.1 Limits of Radiated Emission and Bandedge Measurement	17
4.1.2 Test Instruments	18
4.1.3 Test Procedure	19
4.1.4 Deviation from Test Standard	19
4.1.5 Test Setup	20
4.1.6 EUT Operating Condition	21
4.1.7 Test Results	22
4.2 Conducted Emission Measurement	41
4.2.1 Limits of Conducted Emission Measurement	41
4.2.2 Test Instruments	41
4.2.3 Test Procedure	42
4.2.4 Deviation from Test Standard	42
4.2.5 Test Setup	42
4.2.6 EUT Operating Condition	42
4.2.7 Test Results (Mode 1)	43
4.2.8 Test Results (Mode 2)	45
4.3 Transmit Power Measurement	47
4.3.1 Limits of Transmit Power Measurement	47
4.3.2 Test Setup	47
4.3.3 Test Instruments	47
4.3.4 Test Procedure	48
4.3.5 Deviation from Test Standard	48
4.3.6 EUT Operating Condition	48
4.3.7 Test Result	49
4.4 Occupied Bandwidth Measurement	51
4.4.1 Test Setup	51
4.4.2 Test Instruments	51
4.4.3 Test Procedure	51
4.4.4 Test Results	52
4.5 Peak Power Spectral Density Measurement	56
4.5.1 Limits of Peak Power Spectral Density Measurement	56
4.5.2 Test Setup	56
4.5.3 Test Instruments	56
4.5.4 Test Procedure	57
4.5.5 Deviation from Test Standard	57
4.5.6 EUT Operating Condition	57
4.5.7 Test Results	58
4.6 Frequency Stability Measurement	64

4.6.1	Limits of Frequency Stability Measurement	64
4.6.2	Test Setup.....	64
4.6.3	Test Instruments	64
4.6.4	Test Procedure	64
4.6.5	Deviation from Test Standard	65
4.6.6	EUT Operating Condition	65
4.6.7	Test Results	66
4.7	6dB Bandwidth Measurement	67
4.7.1	Limits of 6dB Bandwidth Measurement.....	67
4.7.2	Test Setup.....	67
4.7.3	Test Instruments	67
4.7.4	Test Procedure	67
4.7.5	Deviation from Test Standard	67
4.7.6	EUT Operating Condition	67
4.7.7	Test Results	68
5	Pictures of Test Arrangements.....	70
	Annex A- Radiated Out of Band Emission (OOBE) Measurement (For U-NII-3 band)	71
	Appendix – Information on the Testing Laboratories	74

Release Control Record

Issue No.	Description	Date Issued
RF160822E04G-1	Original release.	Feb. 22, 2017

1 Certificate of Conformity

Product: Business Cloud Wave 2 Access Point

Brand: D-Link

Test Model: DBA-1210P

Sample Status: ENGINEERING SAMPLE

Applicant: D-Link Corporation

Test Date: Sep. 02 to 19, 2016

Standard: 47 CFR FCC Part 15, Subpart E (Section 15.407)
ANSI C63.10: 2013

The above equipment has been tested by **Bureau Veritas Consumer Products Services (H.K.) Ltd., Taoyuan Branch**, and found compliance with the requirement of the above standards. The test record, data evaluation & Equipment Under Test (EUT) configurations represented herein are true and accurate accounts of the measurements of the sample's EMC characteristics under the conditions specified in this report.

Prepared by : Wendy Wu, **Date:** Feb. 22, 2017
Wendy Wu / Specialist

Approved by : May Chen, **Date:** Feb. 22, 2017
May Chen / Manager

2 Summary of Test Results

47 CFR FCC Part 15, Subpart E (Section 15.407)			
FCC Clause	Test Item	Result	Remarks
15.407(b)(6)	AC Power Conducted Emissions	Pass	Meet the requirement of limit. Minimum passing margin is -6.52dB at 0.27500MHz.
15.407(b) (1/2/3/4(i/ii)/6)	Radiated Emissions & Band Edge Measurement*	Pass	Meet the requirement of limit. Minimum passing margin is -0.1dB at 5150.00MHz.
15.407(a)(1/2/3)	Max Average Transmit Power	Pass	Meet the requirement of limit.
---	Occupied Bandwidth Measurement	-	Reference only.
15.407(a)(1/2/3)	Peak Power Spectral Density	Pass	Meet the requirement of limit.
15.407(e)	6dB bandwidth	Pass	Meet the requirement of limit. (U-NII-3 Band only)
15.407(g)	Frequency Stability	Pass	Meet the requirement of limit.
15.203	Antenna Requirement	Pass	Antenna connector is i-pex(MHF) not a standard connector.

*For U-NII-3 band compliance with rule part 15.407(b)(4)(i), the OOB test plots were recorded in Annex A.

2.1 Measurement Uncertainty

Where relevant, the following measurement uncertainty levels have been estimated for tests performed on the EUT as specified in CISPR 16-4-2:

Measurement	Frequency	Expanded Uncertainty (k=2) (±)
Conducted Emissions at mains ports	150kHz ~ 30MHz	1.83 dB
Radiated Emissions up to 1 GHz	30MHz ~ 1GHz	5.19 dB
Radiated Emissions above 1 GHz	1GHz ~ 6GHz	3.43 dB
	6GHz ~ 18GHz	3.49 dB
	18GHz ~ 40GHz	4.11 dB

2.2 Modification Record

There were no modifications required for compliance.

3 General Information

3.1 General Description of EUT

Product	Business Cloud Wave 2 Access Point
Brand	D-Link
Test Model	DBA-1210P
Status of EUT	ENGINEERING SAMPLE
Power Supply Rating	DC 12V from adapter or DC 48V from POE
Modulation Type	CCK, DQPSK, DBPSK for DSSS 64QAM, 16QAM, QPSK, BPSK for OFDM 256QAM for OFDM in 11ac mode only
Modulation Technology	DSSS, OFDM
Transfer Rate	802.11b: up to 11Mbps 802.11a/g: up to 54Mbps 802.11n: up to 300Mbps 802.11ac: up to 866.7Mbps
Operating Frequency	2.4GHz: 2.412GHz ~ 2.462GHz 5GHz: 5.18GHz ~ 5.24GHz, 5.745GHz ~ 5.825GHz
Number of Channel	2.4GHz: 802.11b, 802.11g, 802.11n (HT20): 11 802.11n (HT40): 7 5GHz: 802.11a, 802.11n (HT20), 802.11ac (VHT20): 9 802.11n (HT40), 802.11ac (VHT40): 4 802.11ac (VHT80): 2
Output Power	2.4GHz: CDD Mode: 861.713mW Beamforming Mode: 861.713mW 5GHz: 5.18GHz ~ 5.24GHz: CDD Mode: 426.809mW Beamforming Mode: 426.809mW 5.745GHz ~ 5.825GHz: CDD Mode: 459.267mW Beamforming Mode: 422.325mW
Antenna Type	Refer to Note
Antenna Connector	Refer to Note
Accessory Device	Adapter x 1
Data Cable Supplied	NA

Note:

1. Simultaneously transmission condition.

Condition	Technology	
1	WLAN (2.4GHz)	WLAN (5GHz)
Note: The emission of the simultaneous operation has been evaluated and no non-compliance was found.		

2. The antenna provided to the EUT, please refer to the following table:

Antenna No	Brand	Model	Antenna Gain (dBi) <Including cable loss>	Frequency range (GHz ~ GHz)	Antenna Type	Connector Type	Cable Length (mm)
Chain (1)	NA	290-20302	3.07	2.4~2.4835	PIFA	i-pex(MHF)	47
			3.46	5.15~5.85			
Chain (2)	NA	290-20301	2.85	2.4~2.4835	PIFA	i-pex(MHF)	81
			3.75	5.15~5.85			

3. The EUT must be supplied with a PoE or power adapter and following below table:

Adapter		
Brand	Model No.	Spec.
D-Link	AMS135-1201000FU	Input: 100-240V, 0.5A, 50/60Hz Output: 12V, 1A DC output cable (unshielded, 1.2m)
POE (test only not sale together and use only with adapter No.: MU24A5480050-A1)		
Brand	Model No.	Spec.
WAHSONIC	PE03G	12-48V, 1A
* Adapter (test only not sale together and use only with PoE)		
Brand	Model No.	Spec.
LEI	MU24A5480050-A1	Input: 100-240V, 50/60Hz, 0.7A Output: 48V, 0.5A DC output cable (unshielded, 1.2m)
From the above adapter and POE, the worst case was found in POE . Therefore only the test data of the modes were recorded in this report.		

4. The EUT incorporates a MIMO function.

2.4GHz Band			
MODULATION MODE	DATA RATE (MCS)	TX & RX CONFIGURATION	
802.11b	1 ~ 11Mbps	2TX	2RX
802.11g	6 ~ 54Mbps	2TX	2RX
802.11n (HT20)	MCS 0~7	2TX	2RX
	MCS 8~15	2TX	2RX
802.11n (HT40)	MCS 0~7	2TX	2RX
	MCS 8~15	2TX	2RX
5GHz Band			
MODULATION MODE	DATA RATE (MCS)	TX & RX CONFIGURATION	
802.11a	6 ~ 54Mbps	2TX	2RX
802.11n (HT20)	MCS 0~7	2TX	2RX
	MCS 8~15	2TX	2RX
802.11n (HT40)	MCS 0~7	2TX	2RX
	MCS 8~15	2TX	2RX
802.11ac (VHT20)	MCS 0~8, Nss=1	2TX	2RX
	MCS 0~8, Nss=2	2TX	2RX
802.11ac (VHT40)	MCS 0~9, Nss=1	2TX	2RX
	MCS 0~9, Nss=2	2TX	2RX
802.11ac (VHT80)	MCS 0~9, Nss=1	2TX	2RX
	MCS 0~9, Nss=2	2TX	2RX

Note:

- All of modulation mode support beamforming function except 802.11a/b/g modulation mode.
- The modulation and bandwidth are similar for 802.11n mode for 20MHz (40MHz) and 802.11ac mode for 20MHz (40MHz), therefore investigated worst case to representative mode in test report. (Final test mode refer section 3.2.1)
- The EUT support Beamforming and CDD mode, therefore both mode were investigated and the worst case scenario was identified. The worst case data were presented in test report.

5. The above EUT information is declared by manufacturer and for more detailed features description, please refer to the manufacturer's specifications or user's manual.

3.2 Description of Test Modes

FOR 5180 ~ 5240MHz

4 channels are provided for 802.11a, 802.11n (HT20), 802.11ac (VHT20):

Channel	Frequency	Channel	Frequency
36	5180 MHz	44	5220 MHz
40	5200 MHz	48	5240 MHz

2 channels are provided for 802.11n (HT40), 802.11ac (VHT40):

Channel	Frequency	Channel	Frequency
38	5190 MHz	46	5230 MHz

1 channel is provided for 802.11ac (VHT80):

Channel	Frequency
42	5210MHz

FOR 5745 ~ 5825MHz:

5 channels are provided for 802.11a, 802.11n (HT20), 802.11ac (VHT20):

Channel	Frequency	Channel	Frequency
149	5745MHz	161	5805MHz
153	5765MHz	165	5825MHz
157	5785MHz		

2 channels are provided for 802.11n (HT40), 802.11ac (VHT40):

Channel	Frequency	Channel	Frequency
151	5755MHz	159	5795MHz

1 channel is provided for 802.11ac (VHT80):

Channel	Frequency
155	5775MHz

3.2.1 Test Mode Applicability and Tested Channel Detail

EUT Configure Mode	Applicable To				Description
	RE \geq 1G	RE<1G	PLC	APCM	
1	√	√	√	√	Power from POE
2	-	-	√	-	Power from adapter

Where **RE \geq 1G**: Radiated Emission above 1GHz **RE<1G**: Radiated Emission below 1GHz
PLC: Power Line Conducted Emission **APCM**: Antenna Port Conducted Measurement

NOTE: 1. The EUT had been pre-tested on the positioned of each 2 axis. The worst case was found when positioned on **Y-plane (below 1GHz) & X-plane (above 1GHz)**.
 2. "-" means no effect.

Radiated Emission Test (Above 1GHz):

- Pre-Scan has been conducted to determine the worst-case mode from all possible combinations between available modulations, data rates and antenna ports (if EUT with antenna diversity architecture).
- Following channel(s) was (were) selected for the final test as listed below.

CDD Mode						
Mode	FREQ. Band (MHz)	Available Channel	Tested Channel	Modulation Technology	Modulation Type	Data Rate (Mbps)
802.11a	5180-5240	36 to 48	36, 40, 48	OFDM	BPSK	6
802.11ac (VHT20)		36 to 48	36, 40, 48	OFDM	BPSK	6.5
802.11ac (VHT40)		38 to 46	38, 46	OFDM	BPSK	13.5
802.11ac (VHT80)		42	42	OFDM	BPSK	29.3
802.11a	5745-5825	149 to 165	149, 157, 165	OFDM	BPSK	6
802.11ac (VHT20)		149 to 165	149, 157, 165	OFDM	BPSK	6.5
802.11ac (VHT40)		151 to 159	151, 159	OFDM	BPSK	13.5
802.11ac (VHT80)		155	155	OFDM	BPSK	29.3

Radiated Emission Test (Below 1GHz):

- Pre-Scan has been conducted to determine the worst-case mode from all possible combinations between available modulations, data rates and antenna ports (if EUT with antenna diversity architecture).
- Following channel(s) was (were) selected for the final test as listed below.

CDD Mode						
Mode	FREQ. Band (MHz)	Available Channel	Tested Channel	Modulation Technology	Modulation Type	Data Rate (Mbps)
802.11a	5745-5825	149 to 165	149	OFDM	BPSK	6

Power Line Conducted Emission Test:

- Pre-Scan has been conducted to determine the worst-case mode from all possible combinations between available modulations, data rates and antenna ports (if EUT with antenna diversity architecture).
- Following channel(s) was (were) selected for the final test as listed below.

CDD Mode						
Mode	FREQ. Band (MHz)	Available Channel	Tested Channel	Modulation Technology	Modulation Type	Data Rate (Mbps)
802.11a	5745-5825	149 to 165	149	OFDM	BPSK	6

Antenna Port Conducted Measurement:

- This item includes all test value of each mode, but only includes spectrum plot of worst value of each mode.
- Pre-Scan has been conducted to determine the worst-case mode from all possible combinations between available modulations, data rates and antenna ports (if EUT with antenna diversity architecture).
- Following channel(s) was (were) selected for the final test as listed below.

CDD Mode						
Mode	FREQ. Band (MHz)	Available Channel	Tested Channel	Modulation Technology	Modulation Type	Data Rate (Mbps)
802.11a	5180-5240	36 to 48	36, 40, 48	OFDM	BPSK	6
802.11ac (VHT20)		36 to 48	36, 40, 48	OFDM	BPSK	6.5
802.11ac (VHT40)		38 to 46	38, 46	OFDM	BPSK	13.5
802.11ac (VHT80)		42	42	OFDM	BPSK	29.3
802.11a	5745-5825	149 to 165	149, 157, 165	OFDM	BPSK	6
802.11ac (VHT20)		149 to 165	149, 157, 165	OFDM	BPSK	6.5
802.11ac (VHT40)		151 to 159	151, 159	OFDM	BPSK	13.5
802.11ac (VHT80)		155	155	OFDM	BPSK	29.3
Beamforming Mode (Output power only)						
Mode	FREQ. Band (MHz)	Available Channel	Tested Channel	Modulation Technology	Modulation Type	Data Rate (Mbps)
802.11ac (VHT20)	5180-5240	36 to 48	36, 40, 48	OFDM	BPSK	6.5
802.11ac (VHT40)		38 to 46	38, 46	OFDM	BPSK	13.5
802.11ac (VHT80)		42	42	OFDM	BPSK	29.3
802.11ac (VHT20)	5745-5825	149 to 165	149, 157, 165	OFDM	BPSK	6.5
802.11ac (VHT40)		151 to 159	151, 159	OFDM	BPSK	13.5
802.11ac (VHT80)		155	155	OFDM	BPSK	29.3

Test Condition:

APPLICABLE TO	ENVIRONMENTAL CONDITIONS	INPUT POWER	TESTED BY
RE \geq 1G	26deg. C, 68%RH	120Vac, 60Hz	Andy Ho
RE $<$ 1G	24deg. C, 72%RH	120Vac, 60Hz	Andy Ho
PLC	25deg. C, 75%RH	120Vac, 60Hz	Barry Lee
APCM	25deg. C, 60%RH	120Vac, 60Hz	Anderson Chen

3.3 Duty Cycle of Test Signal

If duty cycle of test signal is $\geq 98\%$, duty factor is not required.

If duty cycle of test signal is $< 98\%$, duty factor shall be considered.

802.11a: Duty cycle = $2.062 \text{ ms} / 2.137 \text{ ms} = 0.965$, Duty factor = $10 * \log(1/0.965) = 0.16$

802.11ac (VHT20): Duty cycle = $5.002 \text{ ms} / 5.087 \text{ ms} = 0.983$

802.11ac (VHT40): Duty cycle = $2.436 \text{ ms} / 2.515 \text{ ms} = 0.969$, Duty factor = $10 * \log(1/0.969) = 0.14$

802.11ac (VHT80): Duty cycle = $1.147 \text{ ms} / 1.248 \text{ ms} = 0.919$, Duty factor = $10 * \log(1/0.919) = 0.37$

802.11a

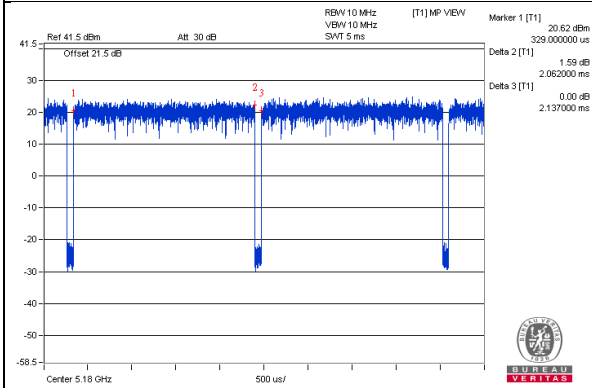

802.11ac (VHT20)

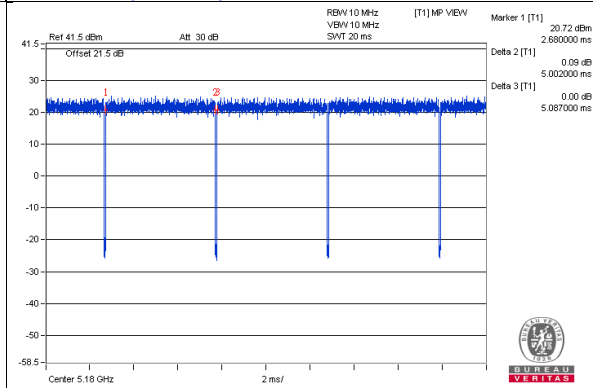

802.11ac (VHT40)

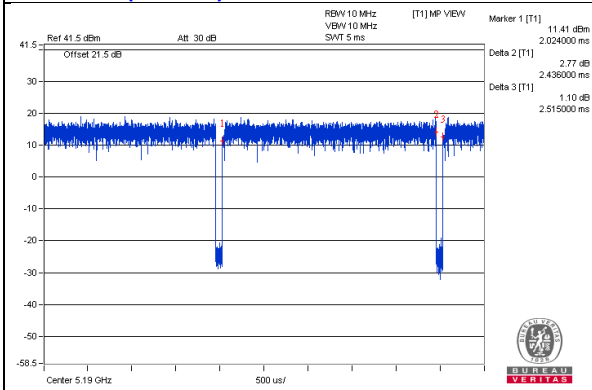

802.11ac (VHT80)

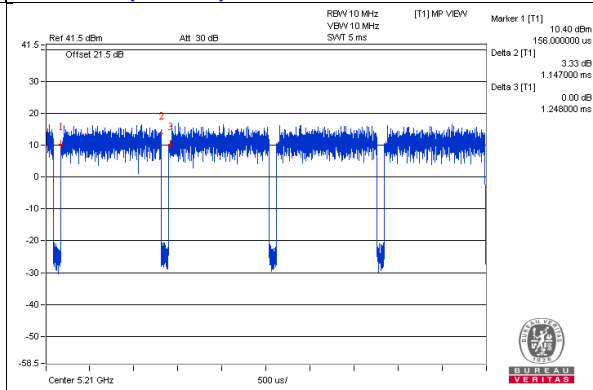

3.4 Description of Support Units

The EUT has been tested as an independent unit together with other necessary accessories or support units. The following support units or accessories were used to form a representative test configuration during the tests.

ID	Product	Brand	Model No.	Serial No.	FCC ID	Remarks
A.	Laptop	DELL	PP27L	7YLB32S	FCC DoC	Provided by Lab
B.	POE	WAHSONIC	PE03G	NA	NA	Supplied by client

Note:

1. All power cords of the above support units are non-shielded (1.8m).

ID	Descriptions	Qty.	Length (m)	Shielding (Yes/No)	Cores (Qty.)	Remarks
1.	RJ-45 Cable	1	10	No	0	Provided by Lab
2.	RJ-45 Cable	1	3	No	0	Provided by Lab
3.	DC Cable	1	1.2	No	0	Supplied by client

3.4.1 Configuration of System under Test

Mode 1:

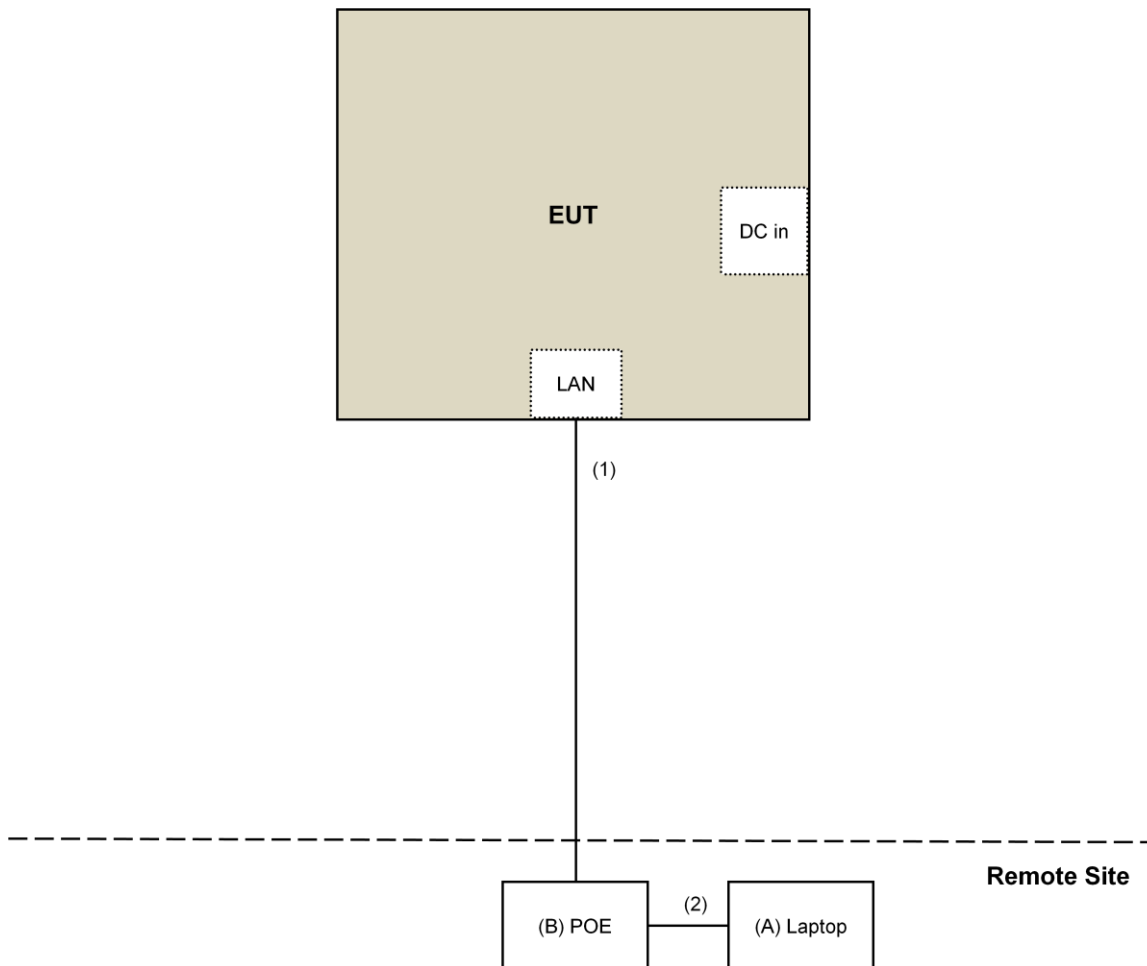

Mode 2:

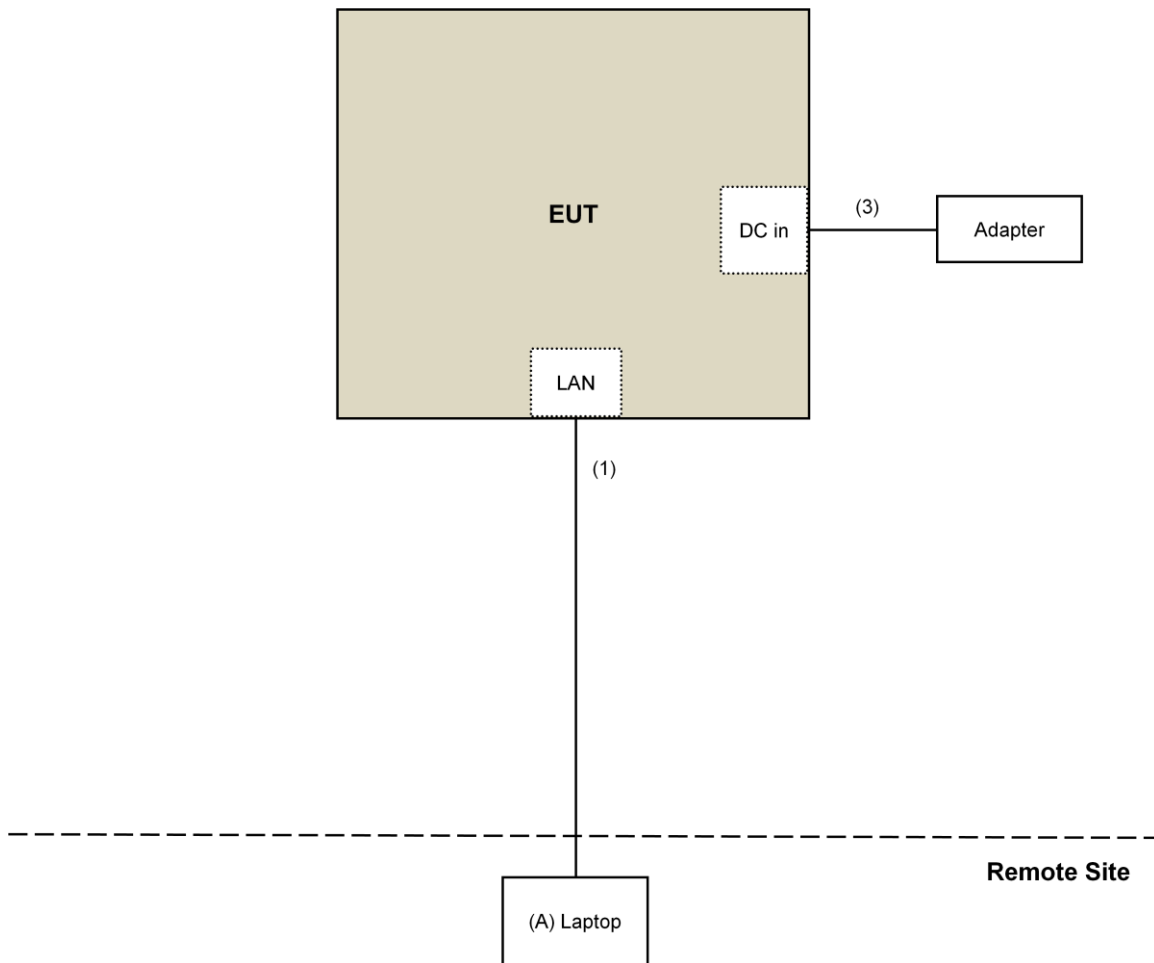

3.5 General Description of Applied Standard

The EUT is a RF Product. According to the specifications of the manufacturer, it must comply with the requirements of the following standards:

FCC Part 15, Subpart E (15.407)
KDB 789033 D02 General UNII Test Procedure New Rules v01r03
KDB 662911 D01 Multiple Transmitter Output v02r01
ANSI C63.10-2013

All test items have been performed and recorded as per the above standards.

NOTE: The EUT has been verified to comply with the requirements of FCC Part 15, Subpart B, Class B (DoC). The test report has been issued separately.

4 Test Types and Results

4.1 Radiated Emission and Bandedge Measurement

4.1.1 Limits of Radiated Emission and Bandedge Measurement

Radiated emissions which fall in the restricted bands must comply with the radiated emission limits specified as below table.

Frequencies (MHz)	Field Strength (microvolts/meter)	Measurement Distance (meters)
0.009 ~ 0.490	2400/F(kHz)	300
0.490 ~ 1.705	24000/F(kHz)	30
1.705 ~ 30.0	30	30
30 ~ 88	100	3
88 ~ 216	150	3
216 ~ 960	200	3
Above 960	500	3

NOTE:

1. The lower limit shall apply at the transition frequencies.
2. Emission level (dBuV/m) = 20 log Emission level (uV/m).
3. For frequencies above 1000MHz, the field strength limits are based on average detector, however, the peak field strength of any emission shall not exceed the maximum permitted average limits, specified above by more than 20dB under any condition of modulation.

Limits of unwanted emission out of the restricted bands

Applicable To		Limit	
789033 D02 General UNII Test Procedure New Rules v01r03		Field Strength at 3m	
		PK:74 (dBμV/m)	AV:54 (dBμV/m)
Frequency Band	Applicable To	EIRP Limit	Equivalent Field Strength at 3m
5150~5250 MHz	15.407(b)(1)	PK:-27 (dBm/MHz)	PK:68.2(dBμV/m)
5250~5350 MHz	15.407(b)(2)		
5470~5725 MHz	15.407(b)(3)		
5725~5850 MHz	<input checked="" type="checkbox"/> 15.407(b)(4)(i)	PK:-27 (dBm/MHz) ^{*1} PK:10 (dBm/MHz) ^{*2} PK:15.6 (dBm/MHz) ^{*3} PK:27 (dBm/MHz) ^{*4}	PK: 68.2(dBμV/m) ^{*1} PK:105.2 (dBμV/m) ^{*2} PK: 110.8(dBμV/m) ^{*3} PK:122.2 (dBμV/m) ^{*4}
	<input type="checkbox"/> 15.407(b)(4)(ii)	Emission limits in section 15.247(d)	
^{*1} beyond 75 MHz or more above of the band edge.		^{*2} below the band edge increasing linearly to 10 dBm/MHz at 25 MHz above.	
^{*3} below the band edge increasing linearly to a level of 15.6 dBm/MHz at 5 MHz above.		^{*4} from 5 MHz above or below the band edge increasing linearly to a level of 27 dBm/MHz at the band edge.	

Note:

The following formula is used to convert the equipment isotropic radiated power (eirp) to field strength:

$$E = \frac{1000000\sqrt{30P}}{3} \mu\text{V/m, where } P \text{ is the eirp (Watts).}$$

4.1.2 Test Instruments

DESCRIPTION & MANUFACTURER	MODEL NO.	SERIAL NO.	CALIBRATED DATE	CALIBRATED UNTIL
Test Receiver Keysight	N9038A	MY54450088	July 20, 2016	July 19, 2017
Pre-Amplifier ^(*) EMCI	EMC001340	980142	Jan. 20, 2016	Jan. 19, 2018
Loop Antenna ^(*) Electro-Metrics	EM-6879	264	Dec. 16, 2014	Dec. 15, 2016
RF Cable	NA	LOOPCAB-001 LOOPCAB-002	Jan. 18, 2016	Jan. 17, 2017
Pre-Amplifier Mini-Circuits	ZFL-1000VH2B	AMP-ZFL-01	Nov. 11, 2015	Nov. 10, 2016
Trilog Broadband Antenna SCHWARZBECK	VULB 9168	9168-406	Jan. 04, 2016	Jan. 03, 2017
RF Cable	8D	966-4-1 966-4-2 966-4-3	Apr. 02, 2016	Apr. 01, 2017
Horn_Antenna SCHWARZBECK	BBHA 9120D	9120D-783	Jan. 19, 2016	Jan. 18, 2017
Pre-Amplifier Agilent	8449B	3008A01922	Sep. 19, 2015	Sep. 18, 2016
RF Cable	EMC104-SM-SM-2000 EMC104-SM-SM-5000 EMC104-SM-SM-5000	150318 150323 150324	Mar. 30, 2016	Mar. 29, 2017
Pre-Amplifier EMCI	EMC184045	980143	Jan. 15, 2016	Jan. 14, 2017
Horn_Antenna SCHWARZBECK	BBHA 9170	BBHA9170608	Jan. 08, 2016	Jan. 07, 2017
RF Cable	SUCOFLEX 102	36432/2 36441/2	Jan. 16, 2016	Jan. 15, 2017
Software	ADT_Radiated_V8.7.08	NA	NA	NA
Antenna Tower & Turn Table Max-Full	MF-7802	MF780208410	NA	NA
Boresight Antenna Fixture	FBA-01	FBA-SIP02	NA	NA

Note:

1. The calibration interval of the above test instruments is 12 months and the calibrations are traceable to NML/ROC and NIST/USA.
2. *The calibration interval of the above test instruments is 24 months and the calibrations are traceable to NML/ROC and NIST/USA.
3. The test was performed in 966 Chamber No. 4.
4. The FCC Site Registration No. is 292998
5. The CANADA Site Registration No. is 20331-2
- 6 Loop antenna was used for all emissions below 30 MHz.
7. Tested Date: Sep. 02 to 09, 2016

4.1.3 Test Procedure

For Radiated emission below 30MHz

- a. The EUT was placed on the top of a rotating table 0.8 meters above the ground at a 3 meter chamber room. The table was rotated 360 degrees to determine the position of the highest radiation.
- b. The EUT was set 3 meters away from the interference-receiving antenna, which was mounted on the top of a variable-height antenna tower.
- c. Both X and Y axes of the antenna are set to make the measurement.
- d. For each suspected emission, the EUT was arranged to its worst case and the rotatable table was turned from 0 degrees to 360 degrees to find the maximum reading.
- e. The test-receiver system was set to Quasi-Peak Detect Function and Specified Bandwidth with Maximum Hold Mode.

NOTE:

1. The resolution bandwidth and video bandwidth of test receiver/spectrum analyzer is 9kHz at frequency below 30MHz.

For Radiated emission above 30MHz

- a. The EUT was placed on the top of a rotating table 0.8 meters (for 30MHz ~ 1GHz) / 1.5 meters (for above 1GHz) above the ground at 3 meter chamber room for test. The table was rotated 360 degrees to determine the position of the highest radiation.
- b. The EUT was set 3 meters away from the interference-receiving antenna, which was mounted on the top of a variable-height antenna tower.
- c. The height of antenna is varied from one meter to four meters above the ground to determine the maximum value of the field strength. Both horizontal and vertical polarizations of the antenna are set to make the measurement.
- d. For each suspected emission, the EUT was arranged to its worst case and then the antenna was tuned to heights from 1 meter to 4 meters and the rotatable table was turned from 0 degrees to 360 degrees to find the maximum reading.
- e. The test-receiver system was set to quasi-peak detect function and specified bandwidth with maximum hold mode when the test frequency is below 1 GHz.
- f. The test-receiver system was set to peak and average detect function and specified bandwidth with maximum hold mode when the test frequency is above 1 GHz. If the peak reading value also meets average limit, measurement with the average detector is unnecessary.

Note:

1. The resolution bandwidth and video bandwidth of test receiver/spectrum analyzer is 120kHz for Quasi-peak detection (QP) at frequency below 1GHz.
2. The resolution bandwidth of test receiver/spectrum analyzer is 1 MHz and the video bandwidth is 3 MHz for Peak detection (PK) at frequency above 1GHz.
3. The resolution bandwidth of test receiver/spectrum analyzer is 1MHz and the video bandwidth is $\geq 1/T$ (Duty cycle < 98%) or 10Hz (Duty cycle $\geq 98\%$) for Average detection (AV) at frequency above 1GHz.
4. All modes of operation were investigated and the worst-case emissions are reported.

4.1.4 Deviation from Test Standard

No deviation.

4.1.5 Test Setup

For Radiated emission below 30MHz

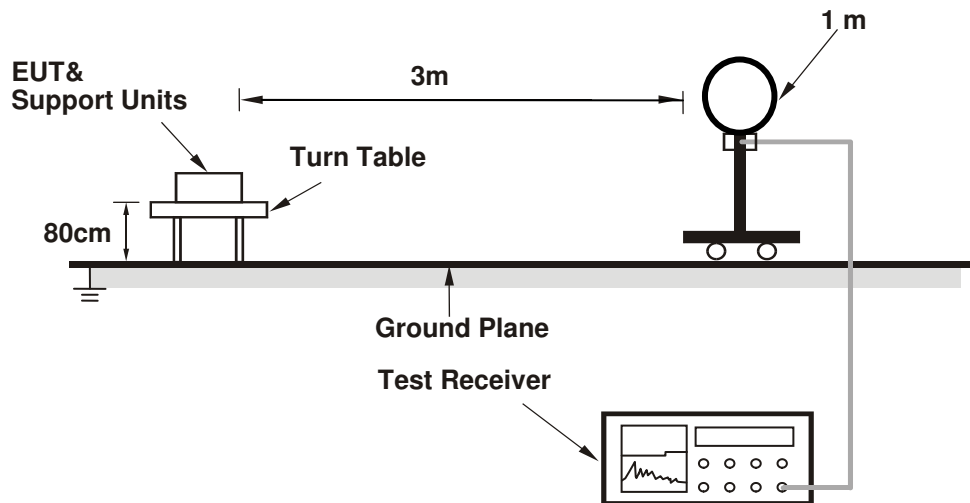

For Radiated emission 30MHz to 1GHz

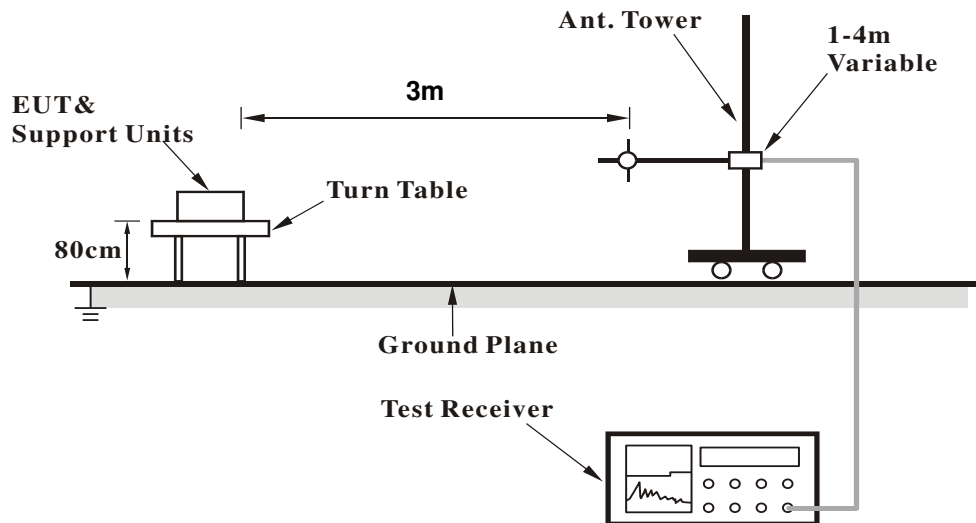

For Radiated emission above 1GHz

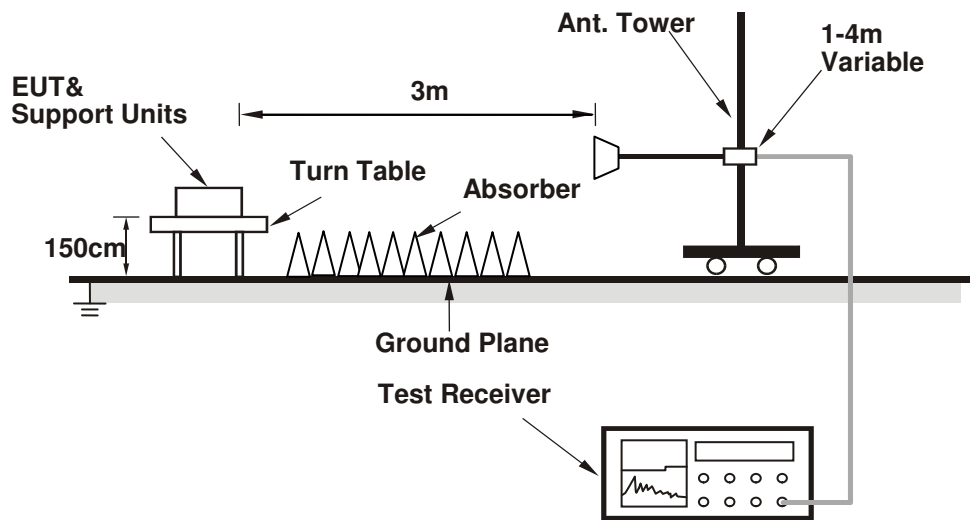

For the actual test configuration, please refer to the attached file (Test Setup Photo).

4.1.6 EUT Operating Condition

- a. Controlling software (QDART.exe Ver 3.0.187.0) has been activated to set the EUT on specific status.

4.1.7 Test Results

Above 1GHz Data:

802.11a

CHANNEL	TX Channel 36	DETECTOR FUNCTION	Peak (PK)
FREQUENCY RANGE	1GHz ~ 40GHz		Average (AV)

ANTENNA POLARITY & TEST DISTANCE: HORIZONTAL AT 3 M

NO.	FREQ. (MHz)	EMISSION LEVEL (dBuV/m)	LIMIT (dBuV/m)	MARGIN (dB)	ANTENNA HEIGHT (m)	TABLE ANGLE (Degree)	RAW VALUE (dBuV)	CORRECTION FACTOR (dB/m)
1	5150.00	64.5 PK	74.0	-9.5	3.21 H	31	62.9	1.6
2	5150.00	53.7 AV	54.0	-0.3	3.21 H	31	52.1	1.6
3	*5180.00	114.0 PK			3.21 H	31	112.3	1.7
4	*5180.00	103.1 AV			3.21 H	31	101.4	1.7
5	#10360.00	51.5 PK	74.0	-22.5	1.48 H	273	39.8	11.7
6	#10360.00	38.9 AV	54.0	-15.1	1.48 H	273	27.2	11.7
7	15540.00	51.3 PK	74.0	-22.7	1.53 H	270	38.0	13.3
8	15540.00	39.4 AV	54.0	-14.6	1.53 H	270	26.1	13.3

ANTENNA POLARITY & TEST DISTANCE: VERTICAL AT 3 M

NO.	FREQ. (MHz)	EMISSION LEVEL (dBuV/m)	LIMIT (dBuV/m)	MARGIN (dB)	ANTENNA HEIGHT (m)	TABLE ANGLE (Degree)	RAW VALUE (dBuV)	CORRECTION FACTOR (dB/m)
1	5150.00	65.8 PK	74.0	-8.2	1.05 V	77	64.2	1.6
2	5150.00	52.6 AV	54.0	-1.4	1.05 V	77	51.0	1.6
3	*5180.00	111.3 PK			1.05 V	77	109.6	1.7
4	*5180.00	102.0 AV			1.05 V	77	100.3	1.7
5	#10360.00	53.5 PK	74.0	-20.5	1.10 V	354	41.8	11.7
6	#10360.00	42.3 AV	54.0	-11.7	1.10 V	354	30.6	11.7
7	15540.00	55.8 PK	74.0	-18.2	2.09 V	111	42.5	13.3
8	15540.00	43.5 AV	54.0	-10.5	2.09 V	111	30.2	13.3

REMARKS:

1. Emission Level(dBuV/m) = Raw Value(dBuV) + Correction Factor(dB/m)
2. Correction Factor(dB/m) = Antenna Factor(dB/m) + Cable Factor(dB) – Pre-Amplifier Factor(dB)
3. The other emission levels were very low against the limit.
4. Margin value = Emission Level – Limit value
5. " * ": Fundamental frequency.
6. " # ": The radiated frequency is out of the restricted band.

CHANNEL	TX Channel 40	DETECTOR FUNCTION	Peak (PK)
FREQUENCY RANGE	1GHz ~ 40GHz		Average (AV)

ANTENNA POLARITY & TEST DISTANCE: HORIZONTAL AT 3 M

NO.	FREQ. (MHz)	EMISSION LEVEL (dBuV/m)	LIMIT (dBuV/m)	MARGIN (dB)	ANTENNA HEIGHT (m)	TABLE ANGLE (Degree)	RAW VALUE (dBuV)	CORRECTION FACTOR (dB/m)
1	5150.00	67.7 PK	74.0	-6.3	3.30 H	349	66.1	1.6
2	5150.00	52.4 AV	54.0	-1.6	3.30 H	349	50.8	1.6
3	*5200.00	115.9 PK			3.30 H	349	114.1	1.8
4	*5200.00	105.8 AV			3.30 H	349	104.0	1.8
5	#10400.00	51.1 PK	74.0	-22.9	1.50 H	260	39.2	11.9
6	#10400.00	38.6 AV	54.0	-15.4	1.50 H	260	26.7	11.9
7	15600.00	51.6 PK	74.0	-22.4	1.50 H	261	38.3	13.3
8	15600.00	39.5 AV	54.0	-14.5	1.50 H	261	26.2	13.3

ANTENNA POLARITY & TEST DISTANCE: VERTICAL AT 3 M

NO.	FREQ. (MHz)	EMISSION LEVEL (dBuV/m)	LIMIT (dBuV/m)	MARGIN (dB)	ANTENNA HEIGHT (m)	TABLE ANGLE (Degree)	RAW VALUE (dBuV)	CORRECTION FACTOR (dB/m)
1	5150.00	64.3 PK	74.0	-9.7	1.05 V	84	62.7	1.6
2	5150.00	52.5 AV	54.0	-1.5	1.05 V	84	50.9	1.6
3	*5200.00	114.5 PK			1.05 V	84	112.7	1.8
4	*5200.00	106.7 AV			1.05 V	84	104.9	1.8
5	#10400.00	54.1 PK	74.0	-19.9	1.05 V	346	42.2	11.9
6	#10400.00	42.6 AV	54.0	-11.4	1.05 V	346	30.7	11.9
7	15600.00	56.2 PK	74.0	-17.8	2.09 V	97	42.9	13.3
8	15600.00	43.7 AV	54.0	-10.3	2.09 V	97	30.4	13.3

REMARKS:

1. Emission Level(dBuV/m) = Raw Value(dBuV) + Correction Factor(dB/m)
2. Correction Factor(dB/m) = Antenna Factor(dB/m) + Cable Factor(dB) – Pre-Amplifier Factor(dB)
3. The other emission levels were very low against the limit.
4. Margin value = Emission Level – Limit value
5. " * ": Fundamental frequency.
6. " # ": The radiated frequency is out of the restricted band.

CHANNEL	TX Channel 48	DETECTOR FUNCTION	Peak (PK)
FREQUENCY RANGE	1GHz ~ 40GHz		Average (AV)

ANTENNA POLARITY & TEST DISTANCE: HORIZONTAL AT 3 M

NO.	FREQ. (MHz)	EMISSION LEVEL (dBuV/m)	LIMIT (dBuV/m)	MARGIN (dB)	ANTENNA HEIGHT (m)	TABLE ANGLE (Degree)	RAW VALUE (dBuV)	CORRECTION FACTOR (dB/m)
1	*5240.00	114.1 PK			3.09 H	360	112.3	1.8
2	*5240.00	104.6 AV			3.09 H	360	102.8	1.8
3	5350.00	51.0 PK	74.0	-23.0	1.05 H	48	48.9	2.1
4	5350.00	39.1 AV	54.0	-14.9	1.05 H	48	37.0	2.1
5	#10480.00	51.8 PK	74.0	-22.2	1.49 H	265	39.6	12.2
6	#10480.00	39.0 AV	54.0	-15.0	1.49 H	265	26.8	12.2
7	15720.00	51.4 PK	74.0	-22.6	1.45 H	276	38.2	13.2
8	15720.00	39.3 AV	54.0	-14.7	1.45 H	276	26.1	13.2

ANTENNA POLARITY & TEST DISTANCE: VERTICAL AT 3 M

NO.	FREQ. (MHz)	EMISSION LEVEL (dBuV/m)	LIMIT (dBuV/m)	MARGIN (dB)	ANTENNA HEIGHT (m)	TABLE ANGLE (Degree)	RAW VALUE (dBuV)	CORRECTION FACTOR (dB/m)
1	*5240.00	112.8 PK			1.50 V	278	111.0	1.8
2	*5240.00	103.0 AV			1.50 V	278	101.2	1.8
3	5350.00	51.9 PK	74.0	-22.1	1.50 V	278	49.8	2.1
4	5350.00	38.4 AV	54.0	-15.6	1.50 V	278	36.3	2.1
5	#10480.00	54.0 PK	74.0	-20.0	1.11 V	357	41.8	12.2
6	#10480.00	42.5 AV	54.0	-11.5	1.11 V	357	30.3	12.2
7	15720.00	56.3 PK	74.0	-17.7	2.09 V	86	43.1	13.2
8	15720.00	43.9 AV	54.0	-10.1	2.09 V	86	30.7	13.2

REMARKS:

1. Emission Level(dBuV/m) = Raw Value(dBuV) + Correction Factor(dB/m)
2. Correction Factor(dB/m) = Antenna Factor(dB/m) + Cable Factor(dB) – Pre-Amplifier Factor(dB)
3. The other emission levels were very low against the limit.
4. Margin value = Emission Level – Limit value
5. " * ": Fundamental frequency.
6. " # ": The radiated frequency is out of the restricted band.

CHANNEL	TX Channel 149	DETECTOR FUNCTION	Peak (PK)
FREQUENCY RANGE	1GHz ~ 40GHz		Average (AV)

ANTENNA POLARITY & TEST DISTANCE: HORIZONTAL AT 3 M

NO.	FREQ. (MHz)	EMISSION LEVEL (dBuV/m)	LIMIT (dBuV/m)	MARGIN (dB)	ANTENNA HEIGHT (m)	TABLE ANGLE (Degree)	RAW VALUE (dBuV)	CORRECTION FACTOR (dB/m)
1	#5617.93	58.1 PK	68.2	-10.1	1.16 H	360	55.5	2.6
2	#5679.20	63.1 PK	89.8	-26.7	1.16 H	360	60.4	2.7
3	*5745.00	115.1 PK			1.16 H	360	112.3	2.8
4	*5745.00	105.8 AV			1.16 H	360	103.0	2.8
5	#5907.20	57.6 PK	81.3	-23.7	1.16 H	360	54.6	3.0
6	#6023.10	57.8 PK	68.2	-10.4	1.16 H	360	54.4	3.4
7	11490.00	51.8 PK	74.0	-22.2	1.53 H	189	38.3	13.5
8	11490.00	39.8 AV	54.0	-14.2	1.53 H	189	26.3	13.5
9	#17235.00	55.2 PK	74.0	-18.8	1.64 H	223	36.8	18.4
10	#17235.00	43.9 AV	54.0	-10.1	1.64 H	223	25.5	18.4

ANTENNA POLARITY & TEST DISTANCE: VERTICAL AT 3 M

NO.	FREQ. (MHz)	EMISSION LEVEL (dBuV/m)	LIMIT (dBuV/m)	MARGIN (dB)	ANTENNA HEIGHT (m)	TABLE ANGLE (Degree)	RAW VALUE (dBuV)	CORRECTION FACTOR (dB/m)
1	#5609.37	57.6 PK	68.2	-10.6	1.39 V	277	55.0	2.6
2	#5690.12	62.5 PK	97.9	-35.4	1.39 V	277	59.7	2.8
3	*5745.00	115.8 PK			1.39 V	277	113.0	2.8
4	*5745.00	106.2 AV			1.39 V	277	103.4	2.8
5	#5902.45	56.0 PK	84.8	-28.8	1.39 V	277	53.1	2.9
6	#5930.95	56.5 PK	68.2	-11.7	1.39 V	277	53.4	3.1
7	11490.00	52.3 PK	74.0	-21.7	1.61 V	164	38.8	13.5
8	11490.00	40.2 AV	54.0	-13.8	1.61 V	164	26.7	13.5
9	#17235.00	55.5 PK	74.0	-18.5	1.44 V	216	37.1	18.4
10	#17235.00	44.0 AV	54.0	-10.0	1.44 V	216	25.6	18.4

REMARKS:

- Emission Level(dBuV/m) = Raw Value(dBuV) + Correction Factor(dB/m)
- Correction Factor(dB/m) = Antenna Factor(dB/m) + Cable Factor(dB) – Pre-Amplifier Factor(dB)
- The other emission levels were very low against the limit.
- Margin value = Emission Level – Limit value
- " * ": Fundamental frequency.
- " # ": The radiated frequency is out of the restricted band.

CHANNEL	TX Channel 157	DETECTOR FUNCTION	Peak (PK)
FREQUENCY RANGE	1GHz ~ 40GHz		Average (AV)

ANTENNA POLARITY & TEST DISTANCE: HORIZONTAL AT 3 M

NO.	FREQ. (MHz)	EMISSION LEVEL (dBuV/m)	LIMIT (dBuV/m)	MARGIN (dB)	ANTENNA HEIGHT (m)	TABLE ANGLE (Degree)	RAW VALUE (dBuV)	CORRECTION FACTOR (dB/m)
1	#5624.57	56.3 PK	68.2	-11.9	1.50 H	360	53.7	2.6
2	#5680.15	55.7 PK	90.5	-34.8	1.50 H	360	53.0	2.7
3	*5785.00	114.5 PK			1.50 H	360	111.6	2.9
4	*5785.00	104.8 AV			1.50 H	360	101.9	2.9
5	#5908.15	55.5 PK	80.6	-25.1	1.50 H	360	52.4	3.1
6	#5945.20	55.5 PK	68.2	-12.7	1.50 H	360	52.4	3.1
7	11570.00	51.7 PK	74.0	-22.3	1.50 H	177	38.5	13.2
8	11570.00	39.6 AV	54.0	-14.4	1.50 H	177	26.4	13.2
9	#17355.00	55.9 PK	74.0	-18.1	1.68 H	216	36.8	19.1
10	#17355.00	44.4 AV	54.0	-9.6	1.68 H	216	25.3	19.1

ANTENNA POLARITY & TEST DISTANCE: VERTICAL AT 3 M

NO.	FREQ. (MHz)	EMISSION LEVEL (dBuV/m)	LIMIT (dBuV/m)	MARGIN (dB)	ANTENNA HEIGHT (m)	TABLE ANGLE (Degree)	RAW VALUE (dBuV)	CORRECTION FACTOR (dB/m)
1	#5572.80	55.9 PK	68.2	-12.3	1.50 V	275	53.4	2.5
2	#5677.77	57.3 PK	88.8	-31.5	1.50 V	275	54.7	2.6
3	*5785.00	116.0 PK			1.50 V	275	113.1	2.9
4	*5785.00	105.1 AV			1.50 V	275	102.2	2.9
5	#5882.50	56.7 PK	99.6	-42.9	1.50 V	275	53.8	2.9
6	#5921.93	56.9 PK	70.5	-13.6	1.50 V	275	53.8	3.1
7	#5985.57	57.0 PK	68.2	-11.2	1.50 V	275	53.7	3.3
8	11570.00	51.9 PK	74.0	-22.1	1.57 V	157	38.7	13.2
9	11570.00	40.0 AV	54.0	-14.0	1.57 V	157	26.8	13.2
10	#17355.00	55.5 PK	74.0	-18.5	1.40 V	221	36.4	19.1
11	#17355.00	43.9 AV	54.0	-10.1	1.40 V	221	24.8	19.1

REMARKS:

- Emission Level(dBuV/m) = Raw Value(dBuV) + Correction Factor(dB/m)
- Correction Factor(dB/m) = Antenna Factor(dB/m) + Cable Factor(dB) – Pre-Amplifier Factor(dB)
- The other emission levels were very low against the limit.
- Margin value = Emission Level – Limit value
- " * ": Fundamental frequency.
- " # ": The radiated frequency is out of the restricted band.

CHANNEL	TX Channel 165	DETECTOR FUNCTION	Peak (PK)
FREQUENCY RANGE	1GHz ~ 40GHz		Average (AV)

ANTENNA POLARITY & TEST DISTANCE: HORIZONTAL AT 3 M

NO.	FREQ. (MHz)	EMISSION LEVEL (dBuV/m)	LIMIT (dBuV/m)	MARGIN (dB)	ANTENNA HEIGHT (m)	TABLE ANGLE (Degree)	RAW VALUE (dBuV)	CORRECTION FACTOR (dB/m)
1	#5606.05	57.9 PK	68.2	-10.3	1.25 H	9	55.3	2.6
2	#5697.25	57.3 PK	103.2	-45.9	1.25 H	9	54.5	2.8
3	*5825.00	116.4 PK			1.25 H	9	113.5	2.9
4	*5825.00	105.7 AV			1.25 H	9	102.8	2.9
5	#5923.82	57.7 PK	69.1	-11.4	1.25 H	9	54.6	3.1
6	#5977.50	57.8 PK	68.2	-10.4	1.25 H	9	54.6	3.2
7	11650.00	52.2 PK	74.0	-21.8	1.46 H	169	39.0	13.2
8	11650.00	39.8 AV	54.0	-14.2	1.46 H	169	26.6	13.2
9	#17475.00	55.8 PK	74.0	-18.2	1.68 H	205	36.4	19.4
10	#17475.00	44.5 AV	54.0	-9.5	1.68 H	205	25.1	19.4

ANTENNA POLARITY & TEST DISTANCE: VERTICAL AT 3 M

NO.	FREQ. (MHz)	EMISSION LEVEL (dBuV/m)	LIMIT (dBuV/m)	MARGIN (dB)	ANTENNA HEIGHT (m)	TABLE ANGLE (Degree)	RAW VALUE (dBuV)	CORRECTION FACTOR (dB/m)
1	#5573.27	56.5 PK	68.2	-11.7	1.50 V	278	54.0	2.5
2	#5705.80	56.4 PK	106.8	-50.4	1.50 V	278	53.6	2.8
3	*5825.00	115.3 PK			1.50 V	278	112.4	2.9
4	*5825.00	105.2 AV			1.50 V	278	102.3	2.9
5	#5906.25	56.4 PK	82.0	-25.6	1.50 V	278	53.4	3.0
6	#5959.45	56.2 PK	68.2	-12.0	1.50 V	278	53.0	3.2
7	11650.00	52.1 PK	74.0	-21.9	1.61 V	171	38.9	13.2
8	11650.00	40.2 AV	54.0	-13.8	1.61 V	171	27.0	13.2
9	#17475.00	54.9 PK	74.0	-19.1	1.38 V	226	35.5	19.4
10	#17475.00	43.6 AV	54.0	-10.4	1.38 V	226	24.2	19.4

REMARKS:

1. Emission Level(dBuV/m) = Raw Value(dBuV) + Correction Factor(dB/m)
2. Correction Factor(dB/m) = Antenna Factor(dB/m) + Cable Factor(dB) – Pre-Amplifier Factor(dB)
3. The other emission levels were very low against the limit.
4. Margin value = Emission Level – Limit value
5. " * ": Fundamental frequency.
6. " # ": The radiated frequency is out of the restricted band.

802.11ac (VHT20)

CHANNEL	TX Channel 36	DETECTOR FUNCTION	Peak (PK)
FREQUENCY RANGE	1GHz ~ 40GHz		Average (AV)

ANTENNA POLARITY & TEST DISTANCE: HORIZONTAL AT 3 M								
NO.	FREQ. (MHz)	EMISSION LEVEL (dBuV/m)	LIMIT (dBuV/m)	MARGIN (dB)	ANTENNA HEIGHT (m)	TABLE ANGLE (Degree)	RAW VALUE (dBuV)	CORRECTION FACTOR (dB/m)
1	5150.00	65.9 PK	74.0	-8.1	3.70 H	37	64.3	1.6
2	5150.00	53.7 AV	54.0	-0.3	3.70 H	37	52.1	1.6
3	*5180.00	113.9 PK			3.70 H	37	112.2	1.7
4	*5180.00	103.2 AV			3.70 H	37	101.5	1.7
5	#10360.00	51.2 PK	74.0	-22.8	1.48 H	176	39.5	11.7
6	#10360.00	39.2 AV	54.0	-14.8	1.48 H	176	27.5	11.7
7	15540.00	56.0 PK	74.0	-18.0	1.66 H	221	42.7	13.3
8	15540.00	44.4 AV	54.0	-9.6	1.66 H	221	31.1	13.3

ANTENNA POLARITY & TEST DISTANCE: VERTICAL AT 3 M								
NO.	FREQ. (MHz)	EMISSION LEVEL (dBuV/m)	LIMIT (dBuV/m)	MARGIN (dB)	ANTENNA HEIGHT (m)	TABLE ANGLE (Degree)	RAW VALUE (dBuV)	CORRECTION FACTOR (dB/m)
1	5150.00	64.8 PK	74.0	-9.2	1.07 V	81	63.2	1.6
2	5150.00	48.5 AV	54.0	-5.5	1.07 V	81	46.9	1.6
3	*5180.00	111.7 PK			1.07 V	81	110.0	1.7
4	*5180.00	103.5 AV			1.07 V	81	101.8	1.7
5	#10360.00	52.7 PK	74.0	-21.3	1.52 V	163	41.0	11.7
6	#10360.00	40.5 AV	54.0	-13.5	1.52 V	163	28.8	11.7
7	15540.00	55.4 PK	74.0	-18.6	1.37 V	214	42.1	13.3
8	15540.00	43.8 AV	54.0	-10.2	1.37 V	214	30.5	13.3

REMARKS:

- Emission Level(dBuV/m) = Raw Value(dBuV) + Correction Factor(dB/m)
- Correction Factor(dB/m) = Antenna Factor(dB/m) + Cable Factor(dB) – Pre-Amplifier Factor(dB)
- The other emission levels were very low against the limit.
- Margin value = Emission Level – Limit value
- " * ": Fundamental frequency.
- " # ": The radiated frequency is out of the restricted band.

CHANNEL	TX Channel 40	DETECTOR FUNCTION	Peak (PK)
FREQUENCY RANGE	1GHz ~ 40GHz		Average (AV)

ANTENNA POLARITY & TEST DISTANCE: HORIZONTAL AT 3 M

NO.	FREQ. (MHz)	EMISSION LEVEL (dBuV/m)	LIMIT (dBuV/m)	MARGIN (dB)	ANTENNA HEIGHT (m)	TABLE ANGLE (Degree)	RAW VALUE (dBuV)	CORRECTION FACTOR (dB/m)
1	5150.00	67.7 PK	74.0	-6.3	3.70 H	360	66.1	1.6
2	5150.00	51.8 AV	54.0	-2.2	3.70 H	360	50.2	1.6
3	*5200.00	117.1 PK			3.70 H	360	115.3	1.8
4	*5200.00	106.1 AV			3.70 H	360	104.3	1.8
5	#10400.00	51.4 PK	74.0	-22.6	1.43 H	164	39.5	11.9
6	#10400.00	39.4 AV	54.0	-14.6	1.43 H	164	27.5	11.9
7	15600.00	56.1 PK	74.0	-17.9	1.69 H	226	42.8	13.3
8	15600.00	44.6 AV	54.0	-9.4	1.69 H	226	31.3	13.3

ANTENNA POLARITY & TEST DISTANCE: VERTICAL AT 3 M

NO.	FREQ. (MHz)	EMISSION LEVEL (dBuV/m)	LIMIT (dBuV/m)	MARGIN (dB)	ANTENNA HEIGHT (m)	TABLE ANGLE (Degree)	RAW VALUE (dBuV)	CORRECTION FACTOR (dB/m)
1	5150.00	62.7 PK	74.0	-11.3	1.06 V	83	61.1	1.6
2	5150.00	47.1 AV	54.0	-6.9	1.06 V	83	45.5	1.6
3	*5200.00	115.6 PK			1.06 V	83	113.8	1.8
4	*5200.00	105.4 AV			1.06 V	83	103.6	1.8
5	#10400.00	52.2 PK	74.0	-21.8	1.53 V	167	40.3	11.9
6	#10400.00	40.3 AV	54.0	-13.7	1.53 V	167	28.4	11.9
7	15600.00	55.4 PK	74.0	-18.6	1.38 V	200	42.1	13.3
8	15600.00	43.7 AV	54.0	-10.3	1.38 V	200	30.4	13.3

REMARKS:

1. Emission Level(dBuV/m) = Raw Value(dBuV) + Correction Factor(dB/m)
2. Correction Factor(dB/m) = Antenna Factor(dB/m) + Cable Factor(dB) – Pre-Amplifier Factor(dB)
3. The other emission levels were very low against the limit.
4. Margin value = Emission Level – Limit value
5. " * ": Fundamental frequency.
6. " # ": The radiated frequency is out of the restricted band.

CHANNEL	TX Channel 48	DETECTOR FUNCTION	Peak (PK)
FREQUENCY RANGE	1GHz ~ 40GHz		Average (AV)

ANTENNA POLARITY & TEST DISTANCE: HORIZONTAL AT 3 M

NO.	FREQ. (MHz)	EMISSION LEVEL (dBuV/m)	LIMIT (dBuV/m)	MARGIN (dB)	ANTENNA HEIGHT (m)	TABLE ANGLE (Degree)	RAW VALUE (dBuV)	CORRECTION FACTOR (dB/m)
1	*5240.00	115.1 PK			3.70 H	360	113.3	1.8
2	*5240.00	104.9 AV			3.70 H	360	103.1	1.8
3	5350.00	52.4 PK	74.0	-21.6	3.70 H	360	50.3	2.1
4	5350.00	40.0 AV	54.0	-14.0	3.70 H	360	37.9	2.1
5	#10480.00	51.3 PK	74.0	-22.7	1.47 H	173	39.1	12.2
6	#10480.00	39.4 AV	54.0	-14.6	1.47 H	173	27.2	12.2
7	15720.00	55.8 PK	74.0	-18.2	1.74 H	234	42.6	13.2
8	15720.00	44.5 AV	54.0	-9.5	1.74 H	234	31.3	13.2

ANTENNA POLARITY & TEST DISTANCE: VERTICAL AT 3 M

NO.	FREQ. (MHz)	EMISSION LEVEL (dBuV/m)	LIMIT (dBuV/m)	MARGIN (dB)	ANTENNA HEIGHT (m)	TABLE ANGLE (Degree)	RAW VALUE (dBuV)	CORRECTION FACTOR (dB/m)
1	*5240.00	115.6 PK			1.07 V	91	113.8	1.8
2	*5240.00	106.9 AV			1.07 V	91	105.1	1.8
3	5350.00	52.7 PK	74.0	-21.3	1.07 V	91	50.6	2.1
4	5350.00	42.1 AV	54.0	-11.9	1.07 V	91	40.0	2.1
5	#10480.00	52.6 PK	74.0	-21.4	1.56 V	168	40.4	12.2
6	#10480.00	40.6 AV	54.0	-13.4	1.56 V	168	28.4	12.2
7	15720.00	55.1 PK	74.0	-18.9	1.36 V	205	41.9	13.2
8	15720.00	43.3 AV	54.0	-10.7	1.36 V	205	30.1	13.2

REMARKS:

1. Emission Level(dBuV/m) = Raw Value(dBuV) + Correction Factor(dB/m)
2. Correction Factor(dB/m) = Antenna Factor(dB/m) + Cable Factor(dB) – Pre-Amplifier Factor(dB)
3. The other emission levels were very low against the limit.
4. Margin value = Emission Level – Limit value
5. " * ": Fundamental frequency.
6. " # ": The radiated frequency is out of the restricted band.

CHANNEL	TX Channel 149	DETECTOR FUNCTION	Peak (PK)
FREQUENCY RANGE	1GHz ~ 40GHz		Average (AV)

ANTENNA POLARITY & TEST DISTANCE: HORIZONTAL AT 3 M

NO.	FREQ. (MHz)	EMISSION LEVEL (dBuV/m)	LIMIT (dBuV/m)	MARGIN (dB)	ANTENNA HEIGHT (m)	TABLE ANGLE (Degree)	RAW VALUE (dBuV)	CORRECTION FACTOR (dB/m)
1	#5610.32	56.9 PK	68.2	-11.3	1.09 H	2	54.3	2.6
2	#5685.37	61.1 PK	94.4	-33.3	1.09 H	2	58.3	2.8
3	#5697.25	62.9 PK	103.2	-40.3	1.09 H	2	60.1	2.8
4	*5745.00	115.2 PK			1.09 H	2	112.4	2.8
5	*5745.00	104.1 AV			1.09 H	2	101.3	2.8
6	#5891.52	56.9 PK	92.9	-36.0	1.09 H	2	54.0	2.9
7	#5956.60	57.0 PK	68.2	-11.2	1.09 H	2	53.8	3.2
8	11490.00	51.0 PK	74.0	-23.0	1.44 H	180	37.5	13.5
9	11490.00	39.1 AV	54.0	-14.9	1.44 H	180	25.6	13.5
10	#17235.00	55.5 PK	74.0	-18.5	1.80 H	235	37.1	18.4
11	#17235.00	44.0 AV	54.0	-10.0	1.80 H	235	25.6	18.4

ANTENNA POLARITY & TEST DISTANCE: VERTICAL AT 3 M

NO.	FREQ. (MHz)	EMISSION LEVEL (dBuV/m)	LIMIT (dBuV/m)	MARGIN (dB)	ANTENNA HEIGHT (m)	TABLE ANGLE (Degree)	RAW VALUE (dBuV)	CORRECTION FACTOR (dB/m)
1	#5622.20	55.9 PK	68.2	-12.3	1.30 V	69	53.3	2.6
2	#5684.43	62.3 PK	93.7	-31.4	1.30 V	69	59.5	2.8
3	*5745.00	116.4 PK			1.30 V	69	113.6	2.8
4	*5745.00	105.2 AV			1.30 V	69	102.4	2.8
5	#5911.95	56.7 PK	77.8	-21.1	1.30 V	69	53.6	3.1
6	#5992.70	58.1 PK	68.2	-10.1	1.30 V	69	54.7	3.4
7	11490.00	52.5 PK	74.0	-21.5	1.57 V	180	39.0	13.5
8	11490.00	40.5 AV	54.0	-13.5	1.57 V	180	27.0	13.5
9	#17235.00	55.2 PK	74.0	-18.8	1.38 V	201	36.8	18.4
10	#17235.00	43.6 AV	54.0	-10.4	1.38 V	201	25.2	18.4

REMARKS:

- Emission Level(dBuV/m) = Raw Value(dBuV) + Correction Factor(dB/m)
- Correction Factor(dB/m) = Antenna Factor(dB/m) + Cable Factor(dB) – Pre-Amplifier Factor(dB)
- The other emission levels were very low against the limit.
- Margin value = Emission Level – Limit value
- " * ": Fundamental frequency.
- " # ": The radiated frequency is out of the restricted band.

CHANNEL	TX Channel 157	DETECTOR FUNCTION	Peak (PK)
FREQUENCY RANGE	1GHz ~ 40GHz		Average (AV)

ANTENNA POLARITY & TEST DISTANCE: HORIZONTAL AT 3 M

NO.	FREQ. (MHz)	EMISSION LEVEL (dBuV/m)	LIMIT (dBuV/m)	MARGIN (dB)	ANTENNA HEIGHT (m)	TABLE ANGLE (Degree)	RAW VALUE (dBuV)	CORRECTION FACTOR (dB/m)
1	#5637.40	57.8 PK	68.2	-10.4	1.05 H	360	55.2	2.6
2	#5727.18	63.2 PK	152.2	-89.0	1.05 H	360	60.4	2.8
3	*5785.00	115.6 PK			1.05 H	360	112.7	2.9
4	*5785.00	104.4 AV			1.05 H	360	101.5	2.9
5	#5892.48	56.0 PK	92.2	-36.2	1.05 H	360	53.1	2.9
6	#5938.55	56.5 PK	68.2	-11.7	1.05 H	360	53.4	3.1
7	11570.00	50.6 PK	74.0	-23.4	1.48 H	176	37.4	13.2
8	11570.00	38.9 AV	54.0	-15.1	1.48 H	176	25.7	13.2
9	#17355.00	55.7 PK	74.0	-18.3	1.83 H	244	36.6	19.1
10	#17355.00	44.1 AV	54.0	-9.9	1.83 H	244	25.0	19.1

ANTENNA POLARITY & TEST DISTANCE: VERTICAL AT 3 M

NO.	FREQ. (MHz)	EMISSION LEVEL (dBuV/m)	LIMIT (dBuV/m)	MARGIN (dB)	ANTENNA HEIGHT (m)	TABLE ANGLE (Degree)	RAW VALUE (dBuV)	CORRECTION FACTOR (dB/m)
1	#5560.45	56.8 PK	68.2	-11.4	1.30 V	69	54.3	2.5
2	#5615.55	57.9 PK	68.2	-10.3	1.30 V	69	55.3	2.6
3	*5785.00	116.2 PK			1.30 V	69	113.3	2.9
4	*5785.00	105.1 AV			1.30 V	69	102.2	2.9
5	#5919.55	56.4 PK	72.2	-15.8	1.30 V	69	53.3	3.1
6	#5937.12	55.9 PK	68.2	-12.3	1.30 V	69	52.8	3.1
7	11570.00	52.8 PK	74.0	-21.2	1.56 V	165	39.6	13.2
8	11570.00	40.5 AV	54.0	-13.5	1.56 V	165	27.3	13.2
9	#17355.00	54.8 PK	74.0	-19.2	1.35 V	187	35.7	19.1
10	#17355.00	43.3 AV	54.0	-10.7	1.35 V	187	24.2	19.1

REMARKS:

1. Emission Level(dBuV/m) = Raw Value(dBuV) + Correction Factor(dB/m)
2. Correction Factor(dB/m) = Antenna Factor(dB/m) + Cable Factor(dB) – Pre-Amplifier Factor(dB)
3. The other emission levels were very low against the limit.
4. Margin value = Emission Level – Limit value
5. " * ": Fundamental frequency.
6. " # ": The radiated frequency is out of the restricted band.

CHANNEL	TX Channel 165	DETECTOR FUNCTION	Peak (PK)
FREQUENCY RANGE	1GHz ~ 40GHz		Average (AV)

ANTENNA POLARITY & TEST DISTANCE: HORIZONTAL AT 3 M

NO.	FREQ. (MHz)	EMISSION LEVEL (dBuV/m)	LIMIT (dBuV/m)	MARGIN (dB)	ANTENNA HEIGHT (m)	TABLE ANGLE (Degree)	RAW VALUE (dBuV)	CORRECTION FACTOR (dB/m)
1	#5588.48	56.7 PK	68.2	-11.5	1.20 H	360	54.2	2.5
2	#5708.65	57.0 PK	107.6	-50.6	1.20 H	360	54.2	2.8
3	*5825.00	114.5 PK			1.20 H	360	111.6	2.9
4	*5825.00	103.2 AV			1.20 H	360	100.3	2.9
5	#5881.55	61.2 PK	100.3	-39.1	1.20 H	360	58.3	2.9
6	#6003.62	57.2 PK	68.2	-11.0	1.20 H	360	53.8	3.4
7	11650.00	50.5 PK	74.0	-23.5	1.45 H	190	37.3	13.2
8	11650.00	39.0 AV	54.0	-15.0	1.45 H	190	25.8	13.2
9	#17475.00	56.4 PK	74.0	-17.6	1.85 H	244	37.0	19.4
10	#17475.00	44.5 AV	54.0	-9.5	1.85 H	244	25.1	19.4

ANTENNA POLARITY & TEST DISTANCE: VERTICAL AT 3 M

NO.	FREQ. (MHz)	EMISSION LEVEL (dBuV/m)	LIMIT (dBuV/m)	MARGIN (dB)	ANTENNA HEIGHT (m)	TABLE ANGLE (Degree)	RAW VALUE (dBuV)	CORRECTION FACTOR (dB/m)
1	#5638.82	57.0 PK	68.2	-11.2	1.10 V	71	54.4	2.6
2	#5709.60	56.5 PK	107.9	-51.4	1.10 V	71	53.7	2.8
3	*5825.00	114.8 PK			1.10 V	71	111.9	2.9
4	*5825.00	103.9 AV			1.10 V	71	101.0	2.9
5	#5884.87	66.2 PK	97.9	-31.7	1.10 V	71	63.3	2.9
6	#5917.65	57.8 PK	73.6	-15.8	1.10 V	71	54.7	3.1
7	#5978.45	56.7 PK	68.2	-11.5	1.10 V	71	53.4	3.3
8	11650.00	53.1 PK	74.0	-20.9	1.54 V	167	39.9	13.2
9	11650.00	40.6 AV	54.0	-13.4	1.54 V	167	27.4	13.2
10	#17475.00	54.8 PK	74.0	-19.2	1.37 V	173	35.4	19.4
11	#17475.00	43.2 AV	54.0	-10.8	1.37 V	173	23.8	19.4

REMARKS:

1. Emission Level(dBuV/m) = Raw Value(dBuV) + Correction Factor(dB/m)
2. Correction Factor(dB/m) = Antenna Factor(dB/m) + Cable Factor(dB) – Pre-Amplifier Factor(dB)
3. The other emission levels were very low against the limit.
4. Margin value = Emission Level – Limit value
5. " * ": Fundamental frequency.
6. " # ": The radiated frequency is out of the restricted band.

802.11ac (VHT40)

CHANNEL	TX Channel 38	DETECTOR FUNCTION	Peak (PK)
FREQUENCY RANGE	1GHz ~ 40GHz		Average (AV)

ANTENNA POLARITY & TEST DISTANCE: HORIZONTAL AT 3 M

NO.	FREQ. (MHz)	EMISSION LEVEL (dBuV/m)	LIMIT (dBuV/m)	MARGIN (dB)	ANTENNA HEIGHT (m)	TABLE ANGLE (Degree)	RAW VALUE (dBuV)	CORRECTION FACTOR (dB/m)
1	5150.00	64.3 PK	74.0	-9.7	3.48 H	360	62.7	1.6
2	5150.00	53.1 AV	54.0	-0.9	3.48 H	360	51.5	1.6
3	*5190.00	106.8 PK			3.48 H	360	105.0	1.8
4	*5190.00	97.7 AV			3.48 H	360	95.9	1.8
5	5350.00	52.8 PK	74.0	-21.2	3.48 H	360	50.7	2.1
6	5350.00	40.7 AV	54.0	-13.3	3.48 H	360	38.6	2.1
7	#10380.00	50.8 PK	74.0	-23.2	1.48 H	188	39.0	11.8
8	#10380.00	39.1 AV	54.0	-14.9	1.48 H	188	27.3	11.8
9	15570.00	55.5 PK	74.0	-18.5	1.80 H	224	42.2	13.3
10	15570.00	44.0 AV	54.0	-10.0	1.80 H	224	30.7	13.3

ANTENNA POLARITY & TEST DISTANCE: VERTICAL AT 3 M

NO.	FREQ. (MHz)	EMISSION LEVEL (dBuV/m)	LIMIT (dBuV/m)	MARGIN (dB)	ANTENNA HEIGHT (m)	TABLE ANGLE (Degree)	RAW VALUE (dBuV)	CORRECTION FACTOR (dB/m)
1	5150.00	59.8 PK	74.0	-14.2	1.05 V	88	58.2	1.6
2	5150.00	49.5 AV	54.0	-4.5	1.05 V	88	47.9	1.6
3	*5190.00	104.7 PK			1.05 V	88	102.9	1.8
4	*5190.00	95.6 AV			1.05 V	88	93.8	1.8
5	5350.00	53.2 PK	74.0	-20.8	1.05 V	88	51.1	2.1
6	5350.00	41.1 AV	54.0	-12.9	1.05 V	88	39.0	2.1
7	#10380.00	52.6 PK	74.0	-21.4	1.55 V	172	40.8	11.8
8	#10380.00	40.4 AV	54.0	-13.6	1.55 V	172	28.6	11.8
9	15570.00	54.5 PK	74.0	-19.5	1.31 V	180	41.2	13.3
10	15570.00	43.1 AV	54.0	-10.9	1.31 V	180	29.8	13.3

REMARKS:

1. Emission Level(dBuV/m) = Raw Value(dBuV) + Correction Factor(dB/m)
2. Correction Factor(dB/m) = Antenna Factor(dB/m) + Cable Factor(dB) – Pre-Amplifier Factor(dB)
3. The other emission levels were very low against the limit.
4. Margin value = Emission Level – Limit value
5. " * ": Fundamental frequency.
6. " # ": The radiated frequency is out of the restricted band.

CHANNEL	TX Channel 46	DETECTOR FUNCTION	Peak (PK)
FREQUENCY RANGE	1GHz ~ 40GHz		Average (AV)

ANTENNA POLARITY & TEST DISTANCE: HORIZONTAL AT 3 M

NO.	FREQ. (MHz)	EMISSION LEVEL (dBuV/m)	LIMIT (dBuV/m)	MARGIN (dB)	ANTENNA HEIGHT (m)	TABLE ANGLE (Degree)	RAW VALUE (dBuV)	CORRECTION FACTOR (dB/m)
1	5150.00	66.8 PK	74.0	-7.2	3.61 H	32	65.2	1.6
2	5150.00	53.2 AV	54.0	-0.8	3.61 H	32	51.6	1.6
3	*5230.00	113.1 PK			3.62 H	32	111.3	1.8
4	*5230.00	104.0 AV			3.62 H	32	102.2	1.8
5	5350.00	58.5 PK	74.0	-15.5	3.62 H	32	56.4	2.1
6	5350.00	45.0 AV	54.0	-9.0	3.62 H	32	42.9	2.1
7	#10460.00	50.8 PK	74.0	-23.2	1.49 H	196	38.7	12.1
8	#10460.00	39.4 AV	54.0	-14.6	1.49 H	196	27.3	12.1
9	15690.00	55.3 PK	74.0	-18.7	1.75 H	214	42.1	13.2
10	15690.00	44.0 AV	54.0	-10.0	1.75 H	214	30.8	13.2

ANTENNA POLARITY & TEST DISTANCE: VERTICAL AT 3 M

NO.	FREQ. (MHz)	EMISSION LEVEL (dBuV/m)	LIMIT (dBuV/m)	MARGIN (dB)	ANTENNA HEIGHT (m)	TABLE ANGLE (Degree)	RAW VALUE (dBuV)	CORRECTION FACTOR (dB/m)
1	5150.00	62.4 PK	74.0	-11.6	1.05 V	72	60.8	1.6
2	5150.00	51.8 AV	54.0	-2.2	1.05 V	72	50.2	1.6
3	*5230.00	112.0 PK			1.05 V	72	110.2	1.8
4	*5230.00	102.1 AV			1.05 V	72	100.3	1.8
5	5350.00	55.0 PK	74.0	-19.0	1.05 V	72	52.9	2.1
6	5350.00	43.4 AV	54.0	-10.6	1.05 V	72	41.3	2.1
7	#10460.00	52.8 PK	74.0	-21.2	1.51 V	171	40.7	12.1
8	#10460.00	40.8 AV	54.0	-13.2	1.51 V	171	28.7	12.1
9	15690.00	55.0 PK	74.0	-19.0	1.35 V	177	41.8	13.2
10	15690.00	43.6 AV	54.0	-10.4	1.35 V	177	30.4	13.2

REMARKS:

1. Emission Level(dBuV/m) = Raw Value(dBuV) + Correction Factor(dB/m)
2. Correction Factor(dB/m) = Antenna Factor(dB/m) + Cable Factor(dB) – Pre-Amplifier Factor(dB)
3. The other emission levels were very low against the limit.
4. Margin value = Emission Level – Limit value
5. " * ": Fundamental frequency.
6. " # ": The radiated frequency is out of the restricted band.

CHANNEL	TX Channel 151	DETECTOR FUNCTION	Peak (PK)
FREQUENCY RANGE	1GHz ~ 40GHz		Average (AV)

ANTENNA POLARITY & TEST DISTANCE: HORIZONTAL AT 3 M

NO.	FREQ. (MHz)	EMISSION LEVEL (dBuV/m)	LIMIT (dBuV/m)	MARGIN (dB)	ANTENNA HEIGHT (m)	TABLE ANGLE (Degree)	RAW VALUE (dBuV)	CORRECTION FACTOR (dB/m)
1	#5611.27	56.9 PK	68.2	-11.3	3.91 H	3	54.3	2.6
2	#5648.80	60.6 PK	68.2	-7.6	3.91 H	3	58.0	2.6
3	#5692.50	69.6 PK	99.7	-30.1	3.91 H	3	66.8	2.8
4	*5755.00	111.6 PK			3.91 H	3	108.7	2.9
5	*5755.00	101.5 AV			3.91 H	3	98.6	2.9
6	#5864.45	58.3 PK	108.2	-49.9	3.91 H	3	55.3	3.0
7	#5986.52	56.4 PK	68.2	-11.8	3.91 H	3	53.1	3.3
8	11510.00	50.3 PK	74.0	-23.7	1.48 H	198	36.8	13.5
9	11510.00	39.2 AV	54.0	-14.8	1.48 H	198	25.7	13.5
10	#17265.00	55.0 PK	74.0	-19.0	1.77 H	205	36.5	18.5
11	#17265.00	43.7 AV	54.0	-10.3	1.77 H	205	25.2	18.5

ANTENNA POLARITY & TEST DISTANCE: VERTICAL AT 3 M

NO.	FREQ. (MHz)	EMISSION LEVEL (dBuV/m)	LIMIT (dBuV/m)	MARGIN (dB)	ANTENNA HEIGHT (m)	TABLE ANGLE (Degree)	RAW VALUE (dBuV)	CORRECTION FACTOR (dB/m)
1	#5612.70	56.3 PK	68.2	-11.9	1.45 V	228	53.7	2.6
2	#5655.93	62.1 PK	72.6	-10.5	1.45 V	228	59.5	2.6
3	*5755.00	112.5 PK			1.45 V	277	109.6	2.9
4	*5755.00	102.3 AV			1.45 V	277	99.4	2.9
5	#5915.75	56.7 PK	75.0	-18.3	1.45 V	278	53.6	3.1
6	#5969.43	57.0 PK	68.2	-11.2	1.45 V	278	53.8	3.2
7	11510.00	53.2 PK	74.0	-20.8	1.56 V	161	39.7	13.5
8	11510.00	41.1 AV	54.0	-12.9	1.56 V	161	27.6	13.5
9	#17265.00	54.3 PK	74.0	-19.7	1.35 V	162	35.8	18.5
10	#17265.00	43.2 AV	54.0	-10.8	1.35 V	162	24.7	18.5

REMARKS:

1. Emission Level(dBuV/m) = Raw Value(dBuV) + Correction Factor(dB/m)
2. Correction Factor(dB/m) = Antenna Factor(dB/m) + Cable Factor(dB) – Pre-Amplifier Factor(dB)
3. The other emission levels were very low against the limit.
4. Margin value = Emission Level – Limit value
5. " * ": Fundamental frequency.
6. " # ": The radiated frequency is out of the restricted band.

CHANNEL	TX Channel 159	DETECTOR FUNCTION	Peak (PK)
FREQUENCY RANGE	1GHz ~ 40GHz		Average (AV)

ANTENNA POLARITY & TEST DISTANCE: HORIZONTAL AT 3 M

NO.	FREQ. (MHz)	EMISSION LEVEL (dBuV/m)	LIMIT (dBuV/m)	MARGIN (dB)	ANTENNA HEIGHT (m)	TABLE ANGLE (Degree)	RAW VALUE (dBuV)	CORRECTION FACTOR (dB/m)
1	#5598.93	56.6 PK	68.2	-11.6	3.91 H	1	54.1	2.5
2	#5711.02	64.3 PK	108.3	-44.0	3.91 H	1	61.5	2.8
3	*5795.00	110.8 PK			3.91 H	1	107.9	2.9
4	*5795.00	101.1 AV			3.91 H	1	98.2	2.9
5	#5890.10	61.5 PK	94.0	-32.5	3.91 H	1	58.6	2.9
6	#5974.65	55.6 PK	68.2	-12.6	3.91 H	1	52.4	3.2
7	11590.00	50.8 PK	74.0	-23.2	1.42 H	204	37.7	13.1
8	11590.00	39.7 AV	54.0	-14.3	1.42 H	204	26.6	13.1
9	#17385.00	55.5 PK	74.0	-18.5	1.82 H	206	36.2	19.3
10	#17385.00	44.1 AV	54.0	-9.9	1.82 H	206	24.8	19.3

ANTENNA POLARITY & TEST DISTANCE: VERTICAL AT 3 M

NO.	FREQ. (MHz)	EMISSION LEVEL (dBuV/m)	LIMIT (dBuV/m)	MARGIN (dB)	ANTENNA HEIGHT (m)	TABLE ANGLE (Degree)	RAW VALUE (dBuV)	CORRECTION FACTOR (dB/m)
1	#5570.43	56.6 PK	68.2	-11.6	1.04 V	77	54.1	2.5
2	#5605.57	57.5 PK	68.2	-10.7	1.04 V	77	54.9	2.6
3	#5678.73	60.9 PK	89.5	-28.6	1.04 V	77	58.3	2.6
4	*5795.00	112.6 PK			1.04 V	77	109.7	2.9
5	*5795.00	102.4 AV			1.04 V	77	99.5	2.9
6	#5892.95	64.9 PK	91.9	-27.0	1.04 V	77	62.0	2.9
7	#5989.37	57.3 PK	68.2	-10.9	1.04 V	77	53.9	3.4
8	11590.00	53.7 PK	74.0	-20.3	1.56 V	171	40.6	13.1
9	11590.00	41.5 AV	54.0	-12.5	1.56 V	171	28.4	13.1
10	#17385.00	54.4 PK	74.0	-19.6	1.33 V	160	35.1	19.3
11	#17385.00	43.0 AV	54.0	-11.0	1.33 V	160	23.7	19.3

REMARKS:

1. Emission Level(dBuV/m) = Raw Value(dBuV) + Correction Factor(dB/m)
2. Correction Factor(dB/m) = Antenna Factor(dB/m) + Cable Factor(dB) – Pre-Amplifier Factor(dB)
3. The other emission levels were very low against the limit.
4. Margin value = Emission Level – Limit value
5. " * ": Fundamental frequency.
6. " # ": The radiated frequency is out of the restricted band.

802.11ac (VHT80)

CHANNEL	TX Channel 42	DETECTOR FUNCTION	Peak (PK)
FREQUENCY RANGE	1GHz ~ 40GHz		Average (AV)

ANTENNA POLARITY & TEST DISTANCE: HORIZONTAL AT 3 M

NO.	FREQ. (MHz)	EMISSION LEVEL (dBuV/m)	LIMIT (dBuV/m)	MARGIN (dB)	ANTENNA HEIGHT (m)	TABLE ANGLE (Degree)	RAW VALUE (dBuV)	CORRECTION FACTOR (dB/m)
1	5150.00	63.8 PK	74.0	-10.2	3.53 H	9	62.2	1.6
2	5150.00	53.9 AV	54.0	-0.1	3.53 H	9	52.3	1.6
3	*5210.00	104.9 PK			3.53 H	9	103.1	1.8
4	*5210.00	94.9 AV			3.53 H	9	93.1	1.8
5	5350.00	52.2 PK	74.0	-21.8	3.53 H	9	50.1	2.1
6	5350.00	41.4 AV	54.0	-12.6	3.53 H	9	39.3	2.1
7	#10420.00	50.9 PK	74.0	-23.1	1.40 H	217	38.9	12.0
8	#10420.00	39.7 AV	54.0	-14.3	1.40 H	217	27.7	12.0
9	15630.00	56.0 PK	74.0	-18.0	1.88 H	215	42.7	13.3
10	15630.00	44.5 AV	54.0	-9.5	1.88 H	215	31.2	13.3

ANTENNA POLARITY & TEST DISTANCE: VERTICAL AT 3 M

NO.	FREQ. (MHz)	EMISSION LEVEL (dBuV/m)	LIMIT (dBuV/m)	MARGIN (dB)	ANTENNA HEIGHT (m)	TABLE ANGLE (Degree)	RAW VALUE (dBuV)	CORRECTION FACTOR (dB/m)
1	5150.00	61.2 PK	74.0	-12.8	1.06 V	88	59.6	1.6
2	5150.00	52.7 AV	54.0	-1.3	1.06 V	88	51.1	1.6
3	*5210.00	103.2 PK			1.06 V	88	101.4	1.8
4	*5210.00	93.4 AV			1.06 V	88	91.6	1.8
5	5350.00	53.7 PK	74.0	-20.3	1.06 V	88	51.6	2.1
6	5350.00	41.9 AV	54.0	-12.1	1.06 V	88	39.8	2.1
7	#10420.00	53.3 PK	74.0	-20.7	1.59 V	166	41.3	12.0
8	#10420.00	41.2 AV	54.0	-12.8	1.59 V	166	29.2	12.0
9	15630.00	54.4 PK	74.0	-19.6	1.38 V	155	41.1	13.3
10	15630.00	42.9 AV	54.0	-11.1	1.38 V	155	29.6	13.3

REMARKS:

1. Emission Level(dBuV/m) = Raw Value(dBuV) + Correction Factor(dB/m)
2. Correction Factor(dB/m) = Antenna Factor(dB/m) + Cable Factor(dB) – Pre-Amplifier Factor(dB)
3. The other emission levels were very low against the limit.
4. Margin value = Emission Level – Limit value
5. " * ": Fundamental frequency.
6. " # ": The radiated frequency is out of the restricted band.

CHANNEL	TX Channel 155	DETECTOR FUNCTION	Peak (PK)
FREQUENCY RANGE	1GHz ~ 40GHz		Average (AV)

ANTENNA POLARITY & TEST DISTANCE: HORIZONTAL AT 3 M

NO.	FREQ. (MHz)	EMISSION LEVEL (dBuV/m)	LIMIT (dBuV/m)	MARGIN (dB)	ANTENNA HEIGHT (m)	TABLE ANGLE (Degree)	RAW VALUE (dBuV)	CORRECTION FACTOR (dB/m)
1	#5633.12	62.6 PK	68.2	-5.6	3.98 H	0	60.0	2.6
2	#5654.98	65.1 PK	71.9	-6.8	3.98 H	0	62.5	2.6
3	#5667.32	74.4 PK	81.1	-6.7	3.98 H	0	71.8	2.6
4	#5686.32	80.2 PK	95.1	-14.9	3.98 H	0	77.4	2.8
5	*5775.00	108.7 PK			3.98 H	0	105.8	2.9
6	*5775.00	98.6 AV			3.98 H	0	95.7	2.9
7	#5883.45	68.6 PK	98.9	-30.3	3.98 H	0	65.7	2.9
8	#5949.00	58.5 PK	68.2	-9.7	3.98 H	0	55.3	3.2
9	11550.00	51.2 PK	74.0	-22.8	1.37 H	229	37.9	13.3
10	11550.00	39.7 AV	54.0	-14.3	1.37 H	229	26.4	13.3
11	#17325.00	55.8 PK	74.0	-18.2	1.93 H	227	36.9	18.9
12	#17325.00	44.2 AV	54.0	-9.8	1.93 H	227	25.3	18.9

ANTENNA POLARITY & TEST DISTANCE: VERTICAL AT 3 M

NO.	FREQ. (MHz)	EMISSION LEVEL (dBuV/m)	LIMIT (dBuV/m)	MARGIN (dB)	ANTENNA HEIGHT (m)	TABLE ANGLE (Degree)	RAW VALUE (dBuV)	CORRECTION FACTOR (dB/m)
1	#5607.48	62.7 PK	68.2	-5.5	1.15 V	74	60.1	2.6
2	#5635.50	65.6 PK	68.2	-2.6	1.15 V	74	63.0	2.6
3	#5654.50	68.6 PK	71.5	-2.9	1.15 V	74	66.0	2.6
4	#5668.27	76.9 PK	81.8	-4.9	1.15 V	74	74.3	2.6
5	#5675.87	80.2 PK	87.4	-7.2	1.15 V	74	77.6	2.6
6	*5775.00	108.8 PK			1.15 V	74	105.9	2.9
7	*5775.00	99.2 AV			1.15 V	74	96.3	2.9
8	#5939.98	62.4 PK	68.2	-5.8	1.15 V	74	59.3	3.1
9	#5991.75	60.5 PK	68.2	-7.7	1.15 V	74	57.1	3.4
10	11550.00	53.8 PK	74.0	-20.2	1.64 V	175	40.5	13.3
11	11550.00	41.6 AV	54.0	-12.4	1.64 V	175	28.3	13.3
12	#17325.00	55.0 PK	74.0	-19.0	1.32 V	165	36.1	18.9
13	#17325.00	43.4 AV	54.0	-10.6	1.32 V	165	24.5	18.9

REMARKS:

1. Emission Level(dBuV/m) = Raw Value(dBuV) + Correction Factor(dB/m)
2. Correction Factor(dB/m) = Antenna Factor(dB/m) + Cable Factor(dB) – Pre-Amplifier Factor(dB)
3. The other emission levels were very low against the limit.
4. Margin value = Emission Level – Limit value
5. " * ": Fundamental frequency.
6. " # ": The radiated frequency is out of the restricted band.

Below 1GHz Data:

802.11a

CHANNEL	TX Channel 149	DETECTOR FUNCTION	Quasi-Peak (QP)
FREQUENCY RANGE	9kHz ~ 1GHz		

ANTENNA POLARITY & TEST DISTANCE: HORIZONTAL AT 3 M

NO.	FREQ. (MHz)	EMISSION LEVEL (dBuV/m)	LIMIT (dBuV/m)	MARGIN (dB)	ANTENNA HEIGHT (m)	TABLE ANGLE (Degree)	RAW VALUE (dBuV)	CORRECTION FACTOR (dB/m)
1	37.76	31.6 QP	40.0	-8.4	1.00 H	223	40.8	-9.2
2	91.15	30.3 QP	43.5	-13.2	2.00 H	105	44.8	-14.5
3	140.46	27.7 QP	43.5	-15.8	2.00 H	179	36.6	-8.9
4	250.00	30.3 QP	46.0	-15.7	1.05 H	174	40.3	-10.0
5	532.82	27.7 QP	46.0	-18.3	1.50 H	223	30.0	-2.3
6	874.97	32.6 QP	46.0	-13.4	1.50 H	310	29.2	3.4

ANTENNA POLARITY & TEST DISTANCE: VERTICAL AT 3 M

NO.	FREQ. (MHz)	EMISSION LEVEL (dBuV/m)	LIMIT (dBuV/m)	MARGIN (dB)	ANTENNA HEIGHT (m)	TABLE ANGLE (Degree)	RAW VALUE (dBuV)	CORRECTION FACTOR (dB/m)
1	37.54	36.1 QP	40.0	-3.9	1.00 V	221	45.4	-9.3
2	58.75	34.6 QP	40.0	-5.4	1.50 V	233	43.6	-9.0
3	100.71	33.4 QP	43.5	-10.1	1.50 V	212	46.2	-12.8
4	176.37	28.3 QP	43.5	-15.2	1.00 V	221	38.1	-9.8
5	532.80	28.1 QP	46.0	-17.9	1.00 V	246	30.4	-2.3
6	886.34	29.5 QP	46.0	-16.5	1.50 V	302	26.0	3.5

REMARKS:

1. Emission Level(dBuV/m) = Raw Value(dBuV) + Correction Factor(dB/m)
2. Correction Factor(dB/m) = Antenna Factor(dB/m) + Cable Factor(dB) – Pre-Amplifier Factor(dB)
3. The other emission levels were very low against the limit.
4. Margin value = Emission Level – Limit value

4.2 Conducted Emission Measurement

4.2.1 Limits of Conducted Emission Measurement

Frequency (MHz)	Conducted Limit (dBuV)	
	Quasi-peak	Average
0.15 - 0.5	66 - 56	56 - 46
0.50 - 5.0	56	46
5.0 - 30.0	60	50

Note: 1. The lower limit shall apply at the transition frequencies.

2. The limit decreases in line with the logarithm of the frequency in the range of 0.15 to 0.50MHz.

4.2.2 Test Instruments

DESCRIPTION & MANUFACTURER	MODEL NO.	SERIAL NO.	CALIBRATED DATE	CALIBRATED UNTIL
Test Receiver R&S	ESCS 30	100375	May 09, 2016	May 08, 2017
Line-Impedance Stabilization Network (for EUT) SCHWARZBECK	NSLK-8127	8127-522	Aug. 31, 2016	Aug. 30, 2017
Line-Impedance Stabilization Network (for Peripheral) R&S	ENV216	100072	June 13, 2016	June 12, 2017
RF Cable	5D-FB	COACAB-002	Mar. 04, 2016	Mar. 03, 2017
10 dB PAD Mini-Circuits	HAT-10+	CONATT-003	Sep. 14, 2015	Sep. 13, 2016
50 ohms Terminator	N/A	EMC-03	Sep. 23, 2015	Sep. 22, 2016
50 ohms Terminator	N/A	EMC-02	Oct. 01, 2015	Sep. 30, 2016
Software BVADT	BVADT_Cond_ V7.3.7.4	NA	NA	NA

Note:

1. The calibration interval of the above test instruments are 12 months and the calibrations are traceable to NML/ROC and NIST/USA.
2. The test was performed in Shielded Room No. C.
- 3 The VCCI Con C Registration No. is C-3611.
- 4 Tested Date: Sep. 09, 2016

4.2.3 Test Procedure

- The EUT was placed 0.4 meters from the conducting wall of the shielded room with EUT being connected to the power mains through a line impedance stabilization network (LISN). Other support units were connected to the power mains through another LISN. The two LISNs provide 50 ohm/ 50uH of coupling impedance for the measuring instrument.
- Both lines of the power mains connected to the EUT were checked for maximum conducted interference.
- The frequency range from 150kHz to 30MHz was searched. Emission levels under (Limit - 20dB) was not recorded.

NOTE: All modes of operation were investigated and the worst-case emissions are reported.

4.2.4 Deviation from Test Standard

No deviation.

4.2.5 Test Setup

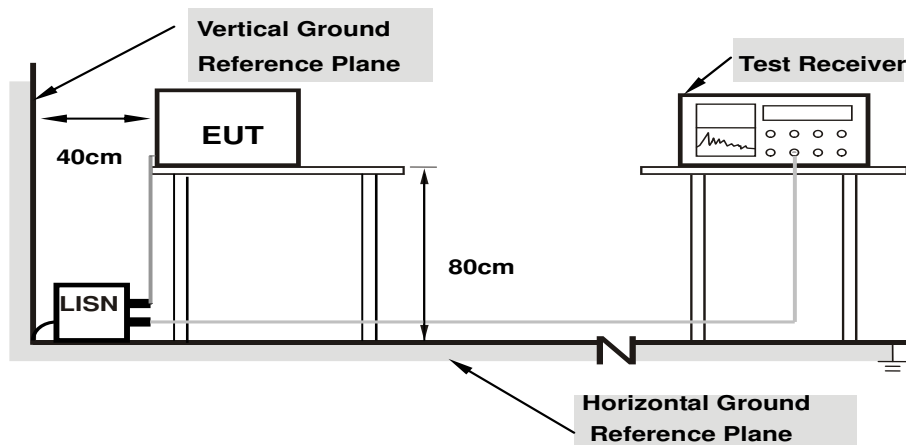

Note: 1.Support units were connected to second LISN.

For the actual test configuration, please refer to the attached file (Test Setup Photo).

4.2.6 EUT Operating Condition

Same as 4.1.6.

4.2.7 Test Results (Mode 1)

Phase	Line (L)	Detector Function	Quasi-Peak (QP) / Average (AV)
-------	----------	-------------------	--------------------------------

No	Freq. [MHz]	Corr.	Reading Value		Emission Level		Limit		Margin	
		Factor (dB)	[dB (uV)]		[dB (uV)]		[dB (uV)]		(dB)	
		Q.P.	AV.	Q.P.	AV.	Q.P.	AV.	Q.P.	AV.	
1	0.15000	10.30	39.24	25.55	49.54	35.85	66.00	56.00	-16.46	-20.15
2	0.18516	10.27	33.95	20.27	44.22	30.54	64.25	54.25	-20.03	-23.71
3	0.39219	10.28	30.80	29.38	41.08	39.66	58.02	48.02	-16.94	-8.36
4	2.88281	10.38	19.18	10.45	29.56	20.83	56.00	46.00	-26.44	-25.17
5	11.38281	10.84	21.02	16.29	31.86	27.13	60.00	50.00	-28.14	-22.87
6	15.20313	11.13	18.14	12.05	29.27	23.18	60.00	50.00	-30.73	-26.82

REMARKS:

1. Q.P. and AV. are abbreviations of quasi-peak and average individually.
2. The emission levels of other frequencies were very low against the limit.
3. Margin value = Emission level - Limit value
4. Correction factor = Insertion loss + Cable loss
5. Emission Level = Correction Factor + Reading Value.

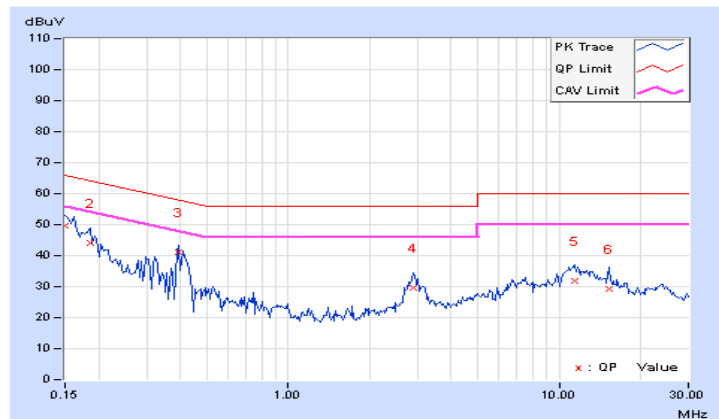

Phase	Neutral (N)	Detector Function	Quasi-Peak (QP) / Average (AV)
-------	-------------	-------------------	--------------------------------

No	Freq. [MHz]	Corr. Factor	Reading Value [dB (uV)]		Emission Level [dB (uV)]		Limit [dB (uV)]		Margin (dB)	
		(dB)	Q.P.	AV.	Q.P.	AV.	Q.P.	AV.	Q.P.	AV.
	1	0.15000	10.28	39.24	24.98	49.52	35.26	66.00	56.00	-16.48
2	0.18516	10.26	33.67	18.91	43.93	29.17	64.25	54.25	-20.32	-25.08
3	0.39219	10.26	27.46	24.32	37.72	34.58	58.02	48.02	-20.30	-13.44
4	2.93359	10.35	19.30	11.08	29.65	21.43	56.00	46.00	-26.35	-24.57
5	7.45313	10.55	17.42	12.19	27.97	22.74	60.00	50.00	-32.03	-27.26
6	13.47266	10.84	18.77	13.91	29.61	24.75	60.00	50.00	-30.39	-25.25

REMARKS:

1. Q.P. and AV. are abbreviations of quasi-peak and average individually.
2. The emission levels of other frequencies were very low against the limit.
3. Margin value = Emission level - Limit value
4. Correction factor = Insertion loss + Cable loss
5. Emission Level = Correction Factor + Reading Value.

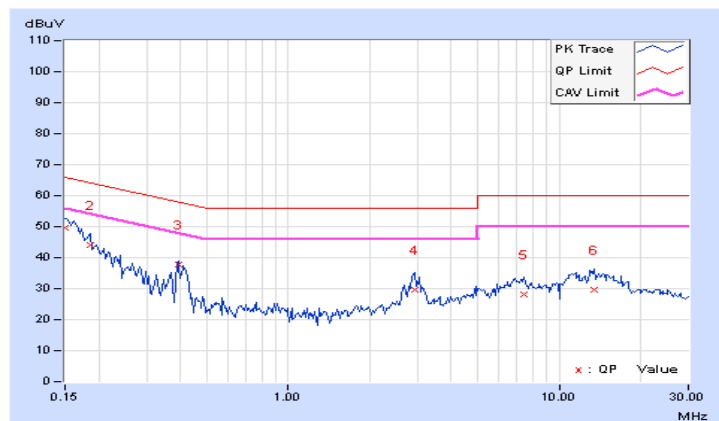

4.2.8 Test Results (Mode 2)

Phase	Line (L)	Detector Function	Quasi-Peak (QP) / Average (AV)
-------	----------	-------------------	--------------------------------

No	Freq. [MHz]	Corr. Factor	Reading Value [dB (uV)]		Emission Level [dB (uV)]		Limit [dB (uV)]		Margin (dB)	
		(dB)	Q.P.	AV.	Q.P.	AV.	Q.P.	AV.	Q.P.	AV.
	1	0.27500	10.27	36.54	34.18	46.81	44.45	60.97	50.97	-14.16
2	0.79063	10.23	30.85	24.63	41.08	34.86	56.00	46.00	-14.92	-11.14
3	0.96641	10.21	26.93	20.57	37.14	30.78	56.00	46.00	-18.86	-15.22
4	1.92578	10.27	28.88	20.53	39.15	30.80	56.00	46.00	-16.85	-15.20
5	7.47266	10.63	29.34	22.36	39.97	32.99	60.00	50.00	-20.03	-17.01
6	15.08594	11.12	23.13	13.56	34.25	24.68	60.00	50.00	-25.75	-25.32

REMARKS:

1. Q.P. and AV. are abbreviations of quasi-peak and average individually.
2. The emission levels of other frequencies were very low against the limit.
3. Margin value = Emission level - Limit value
4. Correction factor = Insertion loss + Cable loss
5. Emission Level = Correction Factor + Reading Value.

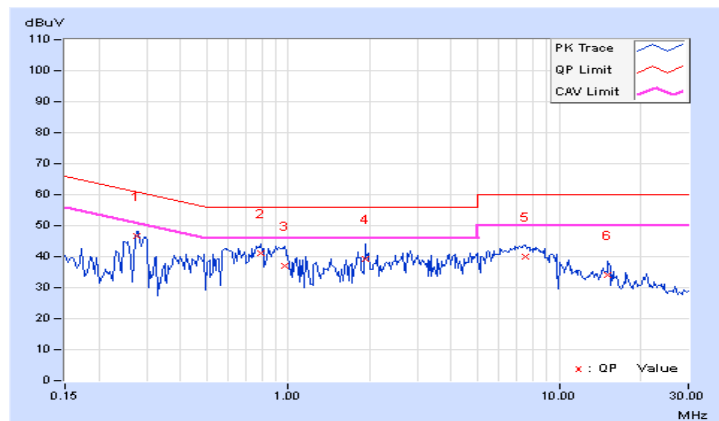

Phase	Neutral (N)	Detector Function	Quasi-Peak (QP) / Average (AV)
-------	-------------	-------------------	--------------------------------

No	Freq. [MHz]	Corr. Factor	Reading Value [dB (uV)]		Emission Level [dB (uV)]		Limit [dB (uV)]		Margin (dB)	
		(dB)	Q.P.	AV.	Q.P.	AV.	Q.P.	AV.	Q.P.	AV.
	1	0.27500	10.25	32.37	28.22	42.62	38.47	60.97	50.97	-18.35
2	0.81406	10.21	25.97	17.43	36.18	27.64	56.00	46.00	-19.82	-18.36
3	2.87500	10.35	23.59	15.10	33.94	25.45	56.00	46.00	-22.06	-20.55
4	4.91016	10.48	22.21	13.54	32.69	24.02	56.00	46.00	-23.31	-21.98
5	7.37109	10.54	24.41	16.07	34.95	26.61	60.00	50.00	-25.05	-23.39
6	15.25781	10.95	22.55	13.10	33.50	24.05	60.00	50.00	-26.50	-25.95

REMARKS:

1. Q.P. and AV. are abbreviations of quasi-peak and average individually.
2. The emission levels of other frequencies were very low against the limit.
3. Margin value = Emission level - Limit value
4. Correction factor = Insertion loss + Cable loss
5. Emission Level = Correction Factor + Reading Value.

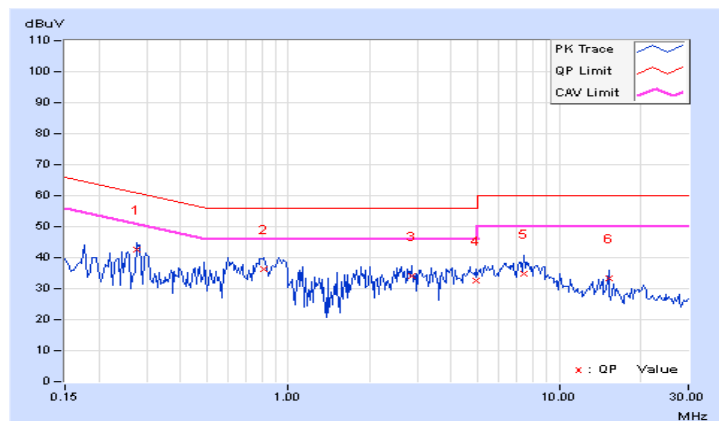

4.3 Transmit Power Measurement

4.3.1 Limits of Transmit Power Measurement

Operation Band	EUT Category		Limit
U-NII-1		Outdoor Access Point	1 Watt (30 dBm) (Max. e.i.r.p \leq 125mW(21 dBm) at any elevation angle above 30 degrees as measured from the horizon)
		Fixed point-to-point Access Point	1 Watt (30 dBm)
	√	Indoor Access Point	1 Watt (30 dBm)
		Mobile and Portable client device	250mW (24 dBm)
U-NII-2A			250mW (24 dBm) or 11 dBm+10 log B*
U-NII-2C			250mW (24 dBm) or 11 dBm+10 log B*
U-NII-3		√	1 Watt (30 dBm)

*B is the 26 dB emission bandwidth in megahertz

Per KDB 662911 Method of conducted output power measurement on IEEE 802.11 devices,

Array Gain = 0 dB (i.e., no array gain) for $N_{ANT} \leq 4$;

Array Gain = 0 dB (i.e., no array gain) for channel widths ≥ 40 MHz for any N_{ANT} ;

Array Gain = $5 \log(N_{ANT}/N_{SS})$ dB or 3 dB, whichever is less for 20-MHz channel widths with $N_{ANT} \geq 5$.

For power measurements on all other devices: Array Gain = $10 \log(N_{ANT}/N_{SS})$ dB.

4.3.2 Test Setup

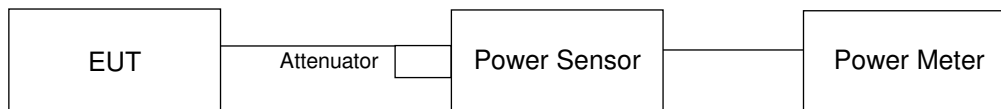

4.3.3 Test Instruments

DESCRIPTION & MANUFACTURER	MODEL NO.	SERIAL NO.	CALIBRATED DATE	CALIBRATED UNTIL
Power meter Anritsu	ML2495A	1014008	May 5, 2016	May 4, 2017
Power sensor Anritsu	MA2411B	0917122	May 5, 2016	May 4, 2017

- NOTE:**
1. The test was performed in Oven room 2.
 2. The calibration interval of the above test instruments is 12 months and the calibrations are traceable to NML/ROC and NIST/USA.
 3. Tested Date: Sep. 19, 2016

4.3.4 Test Procedure

Method PM is used to perform output power measurement, trigger and gating function of wide band power meter is enabled to measure max output power of TX on burst. Duty factor is not added to measured value.

4.3.5 Deviation from Test Standard

No deviation.

4.3.6 EUT Operating Condition

The software provided by client to enable the EUT under transmission condition continuously at lowest, middle and highest channel frequencies individually.

4.3.7 Test Result

CDD Mode

802.11a

Chan.	Chan. Freq. (MHz)	Maximum Conducted Power (dBm)		Total Power (mW)	Total Power (dBm)	Limit (dBm)	Pass / Fail
		Chain 0	Chain 1				
36	5180	20.17	19.18	186.786	22.71	30	Pass
40	5200	23.37	22.36	389.457	25.90	30	Pass
48	5240	22.51	21.33	314.069	24.97	30	Pass
149	5745	23.90	23.30	459.267	26.62	30	Pass
157	5785	23.60	22.24	396.581	25.98	30	Pass
165	5825	23.42	21.89	374.311	25.73	30	Pass

802.11ac (VHT20)

Chan.	Chan. Freq. (MHz)	Maximum Conducted Power (dBm)		Total Power (mW)	Total Power (dBm)	Limit (dBm)	Pass / Fail
		Chain 0	Chain 1				
36	5180	20.19	19.25	188.612	22.76	30	Pass
40	5200	23.42	22.33	390.788	25.92	30	Pass
48	5240	23.99	22.46	426.809	26.30	30	Pass
149	5745	23.89	22.49	422.325	26.26	30	Pass
157	5785	23.61	22.26	397.882	26.00	30	Pass
165	5825	23.68	22.04	393.302	25.95	30	Pass

802.11ac (VHT40)

Chan.	Chan. Freq. (MHz)	Maximum Conducted Power (dBm)		Total Power (mW)	Total Power (dBm)	Limit (dBm)	Pass / Fail
		Chain 0	Chain 1				
38	5190	16.80	15.69	84.931	19.29	30	Pass
46	5230	23.75	22.00	395.626	25.97	30	Pass
151	5755	23.84	22.30	411.927	26.15	30	Pass
159	5795	23.49	22.23	390.466	25.92	30	Pass

802.11ac (VHT80)

Chan.	Chan. Freq. (MHz)	Maximum Conducted Power (dBm)		Total Power (mW)	Total Power (dBm)	Limit (dBm)	Pass / Fail
		Chain 0	Chain 1				
42	5210	17.18	16.10	92.978	19.68	30	Pass
155	5775	22.43	20.70	292.475	24.66	30	Pass

Beamforming Mode

802.11ac (VHT20)

Chan.	Chan. Freq. (MHz)	Maximum Conducted Power (dBm)		Total Power (mW)	Total Power (dBm)	Limit (dBm)	Pass / Fail
		Chain 0	Chain 1				
36	5180	20.19	19.25	188.612	22.76	29.38	Pass
40	5200	23.42	22.33	390.788	25.92	29.38	Pass
48	5240	23.99	22.46	426.809	26.30	29.38	Pass
149	5745	23.89	22.49	422.325	26.26	29.38	Pass
157	5785	23.61	22.26	397.882	26.00	29.38	Pass
165	5825	23.68	22.04	393.302	25.95	29.38	Pass

Note: 1. Directional gain = $10 \log[(10^{G1/20} + 10^{G2/20})^2 / 2] = 6.62\text{dBi} > 6\text{dBi}$, so the power limit shall be reduced to $30-(6.62-6) = 29.38\text{dBm}$

802.11ac (VHT40)

Chan.	Chan. Freq. (MHz)	Maximum Conducted Power (dBm)		Total Power (mW)	Total Power (dBm)	Limit (dBm)	Pass / Fail
		Chain 0	Chain 1				
38	5190	16.80	15.69	84.931	19.29	29.38	Pass
46	5230	23.75	22.00	395.626	25.97	29.38	Pass
151	5755	23.84	22.30	411.927	26.15	29.38	Pass
159	5795	23.49	22.23	390.466	25.92	29.38	Pass

Note: 1. Directional gain = $10 \log[(10^{G1/20} + 10^{G2/20})^2 / 2] = 6.62\text{dBi} > 6\text{dBi}$, so the power limit shall be reduced to $30-(6.62-6) = 29.38\text{dBm}$

802.11ac (VHT80)

Chan.	Chan. Freq. (MHz)	Maximum Conducted Power (dBm)		Total Power (mW)	Total Power (dBm)	Limit (dBm)	Pass / Fail
		Chain 0	Chain 1				
42	5210	17.18	16.10	92.978	19.68	29.38	Pass
155	5775	22.43	20.70	292.475	24.66	29.38	Pass

Note: 1. Directional gain = $10 \log[(10^{G1/20} + 10^{G2/20})^2 / 2] = 6.62\text{dBi} > 6\text{dBi}$, so the power limit shall be reduced to $30-(6.62-6) = 29.38\text{dBm}$

4.4 Occupied Bandwidth Measurement

4.4.1 Test Setup



4.4.2 Test Instruments

DESCRIPTION & MANUFACTURER	MODEL NO.	SERIAL NO.	CALIBRATED DATE	CALIBRATED UNTIL
Spectrum Analyzer R&S	FSP40	100060	May 11, 2016	May 10, 2017

- NOTE:**
1. The test was performed in Oven room 2.
 2. The calibration interval of the above test instruments is 12 months and the calibrations are traceable to NML/ROC and NIST/USA.
 3. Tested Date: Sep. 19, 2016

4.4.3 Test Procedure

The transmitter output was connected to the spectrum analyzer through an attenuator. The bandwidth of the fundamental frequency was measured by spectrum analyzer with resolution bandwidth in the range of 1% to 5% of the anticipated emission bandwidth, and a video bandwidth at least 3x the resolution bandwidth and set the detector to SAMPLE. The width of a frequency band such that, below the lower and above the upper frequency limits, the mean powers emitted are each equal to a specified percentage 0.5 %of the total mean power of a given emission.

4.4.4 Test Results

802.11a

Channel	Channel Frequency (MHz)	Occupied Bandwidth (MHz)	
		Chain 0	Chain 1
36	5180	16.56	16.68
40	5200	19.08	23.64
48	5240	16.68	19.44
149	5745	26.16	31.92
157	5785	26.40	31.68
165	5825	25.68	22.92

802.11ac (VHT20)

Channel	Channel Frequency (MHz)	Occupied Bandwidth (MHz)	
		Chain 0	Chain 1
36	5180	17.76	17.76
40	5200	20.16	24.36
48	5240	20.04	19.80
149	5745	25.68	27.24
157	5785	27.36	29.04
165	5825	27.36	23.52

802.11ac (VHT40)

Channel	Channel Frequency (MHz)	Occupied Bandwidth (MHz)	
		Chain 0	Chain 1
38	5190	36.24	36.24
46	5230	37.68	37.44
151	5755	49.92	53.52
159	5795	52.80	57.12

802.11ac (VHT80)

Channel	Channel Frequency (MHz)	Occupied Bandwidth (MHz)	
		Chain 0	Chain 1
42	5210	76.32	76.32
155	5775	76.32	76.32

Spectrum Plot of Worst Value

802.11a_Chain1 / CH149

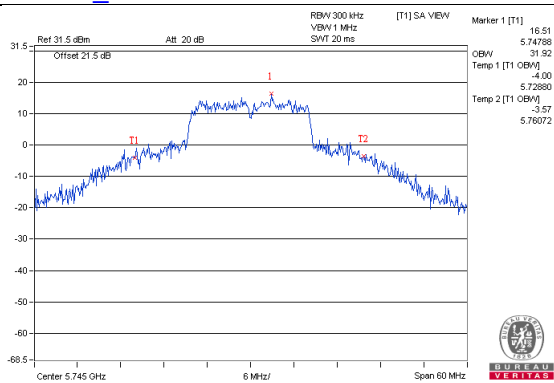

802.11ac (VHT20)_Chain1 / CH157

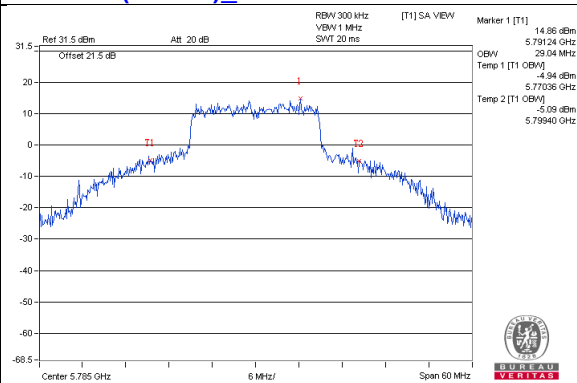

802.11ac (VHT40)_Chain1 / CH159

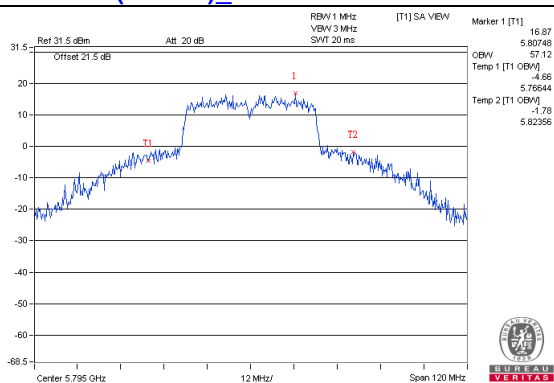

802.11ac (VHT80)_Chain0 / CH155

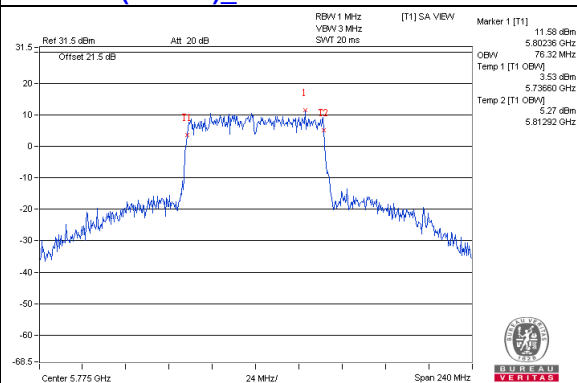

Spectrum Plot for near by DFS band (DFS is required, if 99% OCP straddle into U-NII-2A band)

802.11a_Chain0 / CH48

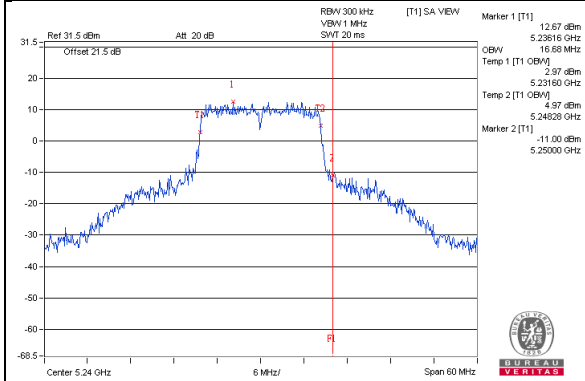

802.11a_Chain1 / CH48

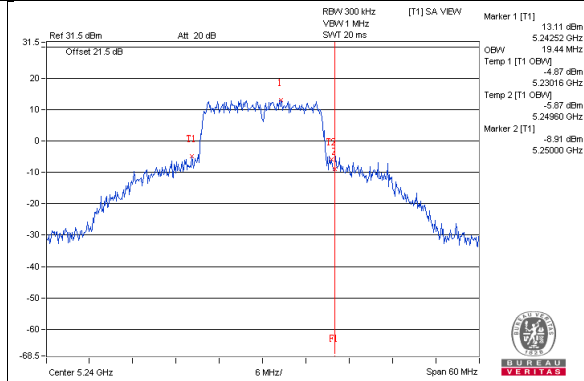

802.11ac(VHT20)_Chain0 / CH48

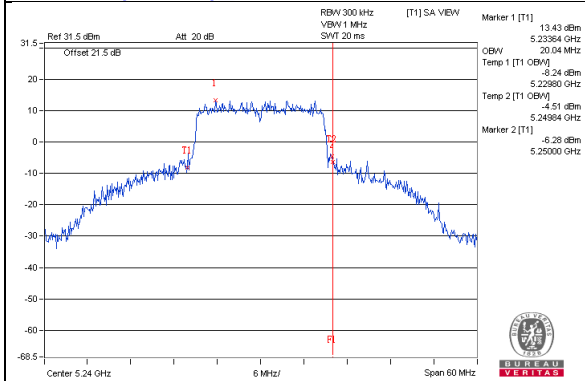

802.11ac(VHT20)_Chain1 / CH48

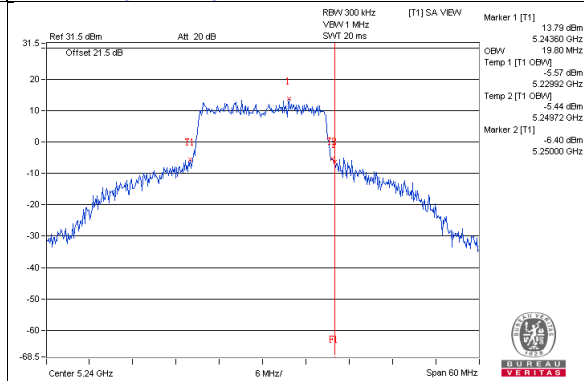

802.11ac(VHT40)_Chain0 / CH46

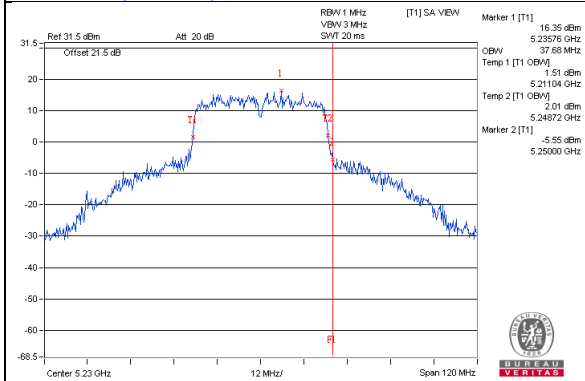

802.11ac(VHT40)_Chain1 / CH46

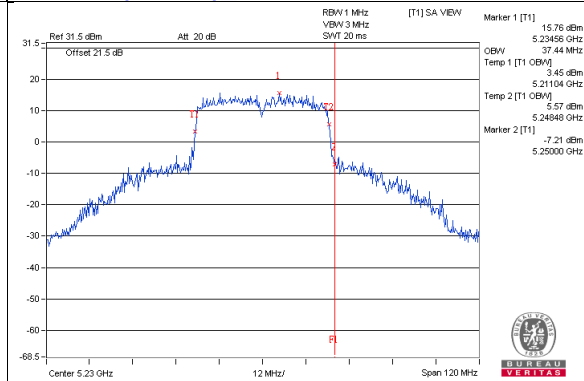

802.11ac(VHT80)_Chain0 / CH42

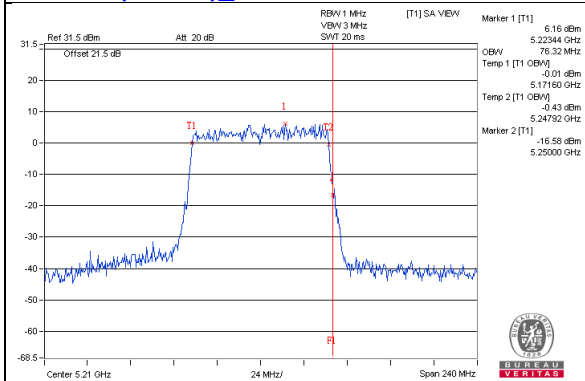

802.11ac(VHT80)_Chain1 / CH42

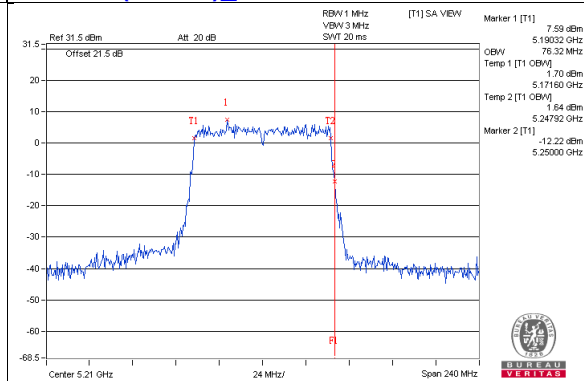

**Spectrum Plot for near by DFS band
(DFS is required, if 99% OCP straddle into U-NII-2C band)**

802.11a_Chain0 / CH149

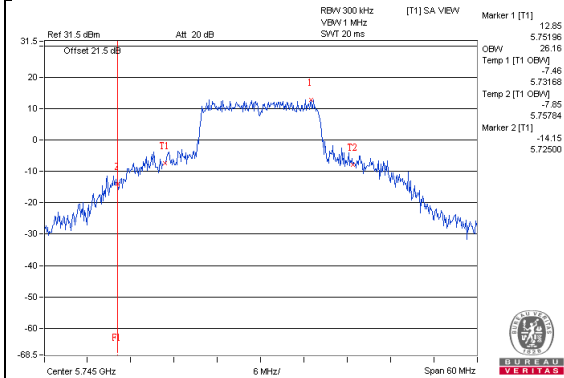

802.11a_Chain1 / CH149

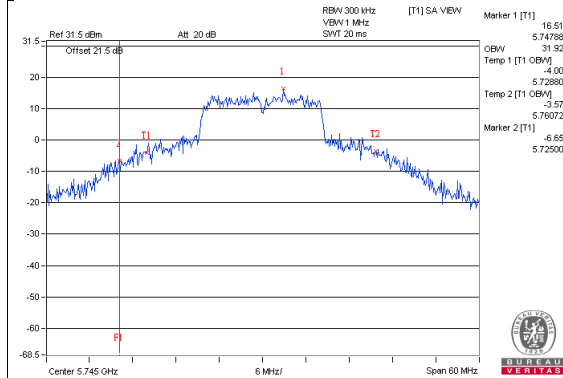

802.11ac(VHT20)_Chain0 / CH149

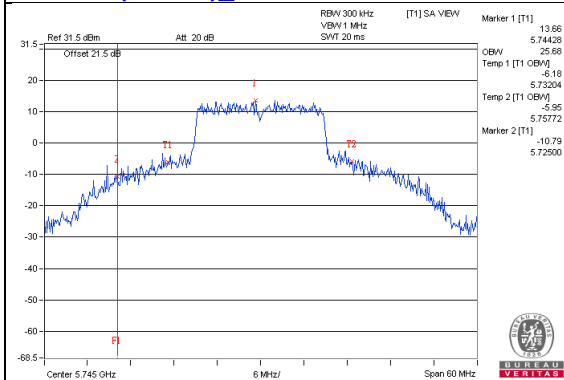

802.11ac(VHT20)_Chain1 / CH149

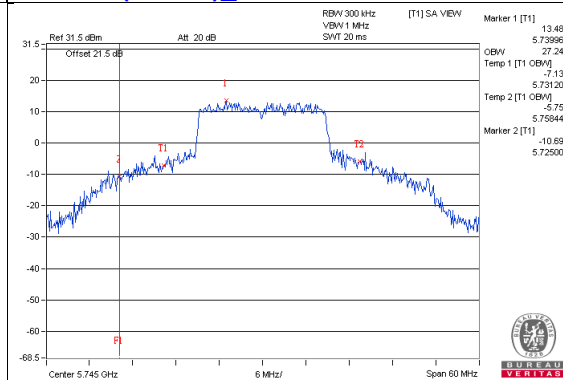

802.11ac(VHT40)_Chain0 / CH151

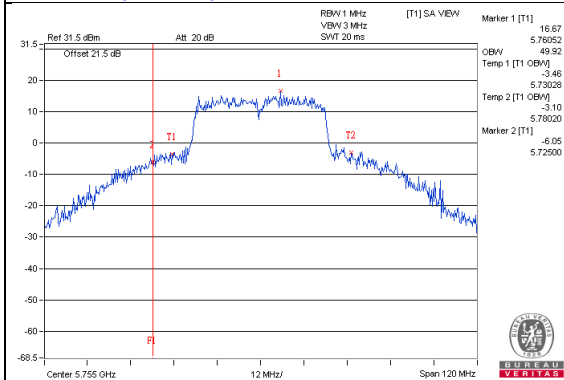

802.11ac(VHT40)_Chain1 / CH151

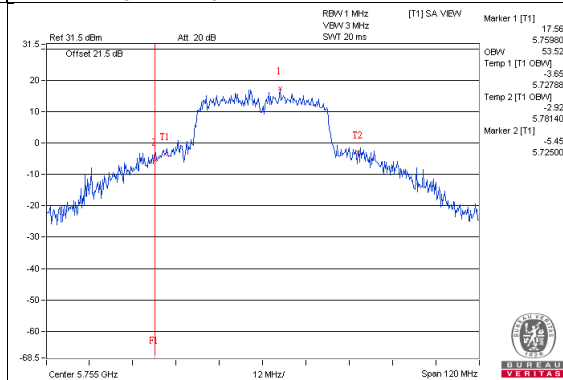

802.11ac(VHT80)_Chain0 / CH155

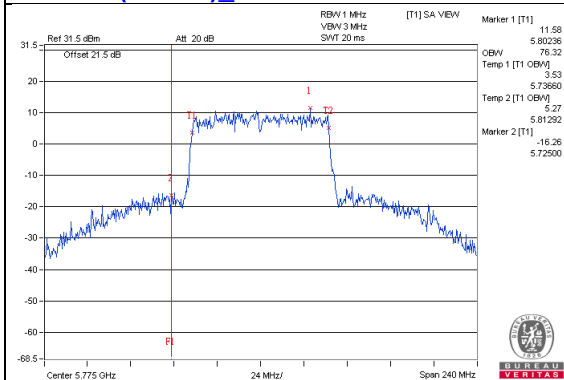

802.11ac(VHT80)_Chain1 / CH155

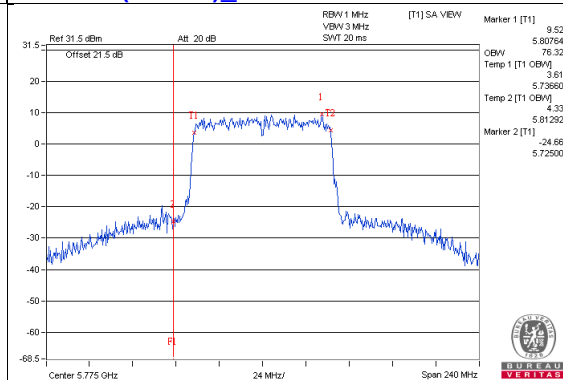

4.5 Peak Power Spectral Density Measurement

4.5.1 Limits of Peak Power Spectral Density Measurement

Operation Band	EUT Category		Limit
U-NII-1		Outdoor Access Point	17dBm/ MHz
		Fixed point-to-point Access Point	
	√	Indoor Access Point	
		Mobile and Portable client device	11dBm/ MHz
U-NII-2A			11dBm/ MHz
U-NII-2C			11dBm/ MHz
U-NII-3	√		30dBm/ 500kHz

4.5.2 Test Setup

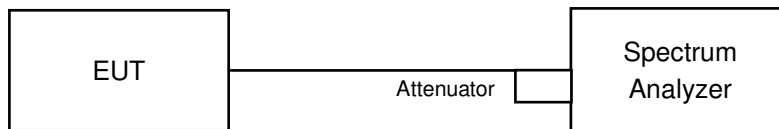

4.5.3 Test Instruments

DESCRIPTION & MANUFACTURER	MODEL NO.	SERIAL NO.	CALIBRATED DATE	CALIBRATED UNTIL
Spectrum Analyzer R&S	FSP40	100060	May 11, 2016	May 10, 2017

- NOTE:**
1. The test was performed in Oven room 2.
 2. The calibration interval of the above test instruments is 12 months and the calibrations are traceable to NML/ROC and NIST/USA.
 3. Tested Date: Sep. 19, 2016

4.5.4 Test Procedure

802.11ac (VHT20)

For U-NII-1:

Using method SA-1

1. Set span to encompass the entire emission bandwidth (EBW) of the signal.
2. Set RBW = 1 MHz, Set VBW \geq 3 MHz, Detector = RMS
3. Sweep time = auto, trigger set to "free run".
4. Trace average at least 100 traces in power averaging mode.
5. Record the max value

For U-NII-3:

1. Set span to encompass the entire emission bandwidth (EBW) of the signal.
2. Set RBW = 300 kHz, Set VBW \geq 1 MHz, Detector = RMS
3. Use the peak marker function to determine the maximum power level in any 300 kHz band segment within the fundamental EBW.
4. Scale the observed power level to an equivalent value in 500 kHz by adjusting (reducing) the measured power by a bandwidth correction factor (BWCF) where $BWCF = 10\log(500 \text{ kHz}/300\text{kHz})$
5. Sweep time = auto, trigger set to "free run".
6. Trace average at least 100 traces in power averaging mode.
7. Record the max value

802.11a, 802.11ac (VHT40), 802.11ac (VHT80)

For U-NII-1:

Using method SA-2

1. Set span to encompass the entire emission bandwidth (EBW) of the signal.
2. Set RBW = 1 MHz, Set VBW \geq 3 MHz, Detector = RMS
3. Sweep time = auto, trigger set to "free run".
4. Trace average at least 100 traces in power averaging mode.
5. Record the max value and add $10 \log(1/\text{duty cycle})$

For U-NII-3:

1. Set span to encompass the entire emission bandwidth (EBW) of the signal.
2. Set RBW = 300 kHz, Set VBW \geq 1 MHz, Detector = RMS
3. Use the peak marker function to determine the maximum power level in any 300 kHz band segment within the fundamental EBW.
4. Scale the observed power level to an equivalent value in 500 kHz by adjusting (reducing) the measured power by a bandwidth correction factor (BWCF) where $BWCF = 10\log(500 \text{ kHz}/300\text{kHz})$
5. Sweep time = auto, trigger set to "free run".
6. Trace average at least 100 traces in power averaging mode.
7. Record the max value and add $10 \log(1/\text{duty cycle})$

4.5.5 Deviation from Test Standard

No deviation.

4.5.6 EUT Operating Condition

Same as Item 4.3.6.

4.5.7 Test Results

For U-NII-1:

802.11a

Chan.	Chan. Freq. (MHz)	PSD W/O Duty Factor (dBm/MHz)		Duty Factor (dB)	Total PSD With Duty Factor (dBm/MHz)	MAX. Limit (dBm/MHz)	Pass / Fail
		Chain 0	Chain 1				
36	5180	5.70	6.66	0.16	9.37	16.38	Pass
40	5200	8.99	9.60	0.16	12.47	16.38	Pass
48	5240	7.89	9.04	0.16	11.67	16.38	Pass

- Note:**
- Method a) of power density measurement of KDB 662911 is using for calculating total power density. Total power density is summing entire spectra across corresponding frequency bins on the various outputs by computer.
 - Directional gain = $10 \log[(10^{G1/20} + 10^{G2/20})^2 / 2] = 6.62\text{dBi} > 6\text{dBi}$, so the power density limit shall be reduced to $17 - (6.62 - 6) = 16.38\text{dBm}$.
 - Refer to section 3.3 for duty cycle spectrum plot.

802.11ac (VHT20)

Chan.	Chan. Freq. (MHz)	PSD (dBm/MHz)		Total Power Density (dBm/MHz)	MAX. Limit (dBm/MHz)	Pass / Fail
		Chain 0	Chain 1			
36	5180	5.69	6.05	8.88	16.38	Pass
40	5200	8.91	9.48	12.21	16.38	Pass
48	5240	8.91	8.60	11.77	16.38	Pass

- Note:**
- Method a) of power density measurement of KDB 662911 is using for calculating total power density. Total power density is summing entire spectra across corresponding frequency bins on the various outputs by computer.
 - Directional gain = $10 \log[(10^{G1/20} + 10^{G2/20})^2 / 2] = 6.62\text{dBi} > 6\text{dBi}$, so the power density limit shall be reduced to $17 - (6.62 - 6) = 16.38\text{dBm}$.

802.11ac (VHT40)

Chan.	Chan. Freq. (MHz)	PSD W/O Duty Factor (dBm/MHz)		Duty Factor (dB)	Total PSD With Duty Factor (dBm/MHz)	MAX. Limit (dBm/MHz)	Pass / Fail
		Chain 0	Chain 1				
38	5190	-0.81	0.13	0.14	2.83	16.38	Pass
46	5230	5.70	5.55	0.14	8.77	16.38	Pass

- Note:**
- Method a) of power density measurement of KDB 662911 is using for calculating total power density. Total power density is summing entire spectra across corresponding frequency bins on the various outputs by computer.
 - Directional gain = $10 \log[(10^{G1/20} + 10^{G2/20})^2 / 2] = 6.62\text{dBi} > 6\text{dBi}$, so the power density limit shall be reduced to $17 - (6.62 - 6) = 16.38\text{dBm}$.
 - Refer to section 3.3 for duty cycle spectrum plot.

802.11ac (VHT80)

Chan.	Chan. Freq. (MHz)	PSD W/O Duty Factor (dBm/MHz)		Duty Factor (dB)	Total PSD With Duty Factor (dBm/MHz)	MAX. Limit (dBm/MHz)	Pass / Fail
		Chain 0	Chain 1				
42	5210	-4.77	-3.31	0.37	-0.60	16.38	Pass

- Note:**
- Method a) of power density measurement of KDB 662911 is using for calculating total power density. Total power density is summing entire spectra across corresponding frequency bins on the various outputs by computer.
 - Directional gain = $10 \log[(10^{G1/20} + 10^{G2/20})^2 / 2] = 6.62\text{dBi} > 6\text{dBi}$, so the power density limit shall be reduced to $17-(6.62-6) = 16.38\text{dBm}$.
 - Refer to section 3.3 for duty cycle spectrum plot.

Spectrum Plot of Worst Value

802.11a_Chain 1 / CH40

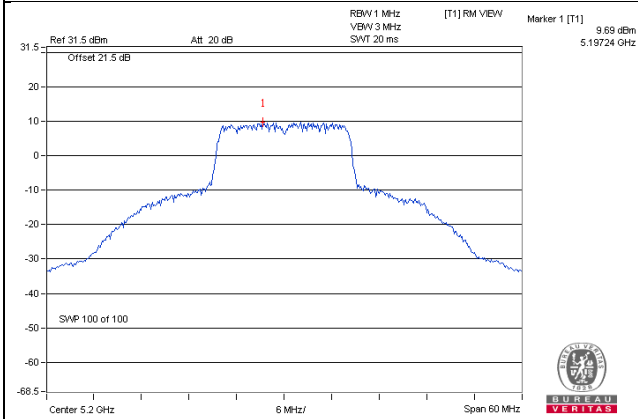

802.11ac (VHT20)_Chain 1 / CH40

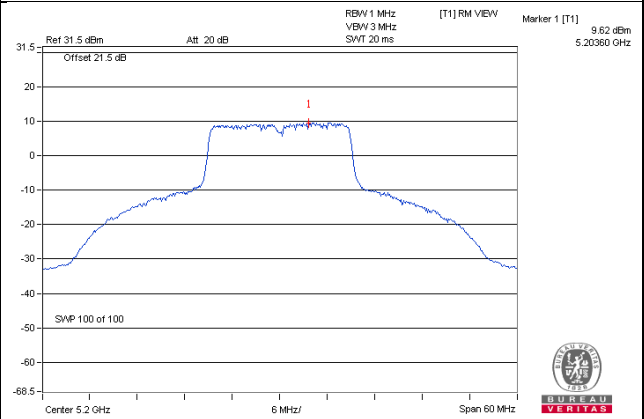

802.11ac (VHT40)_Chain 0 / CH46

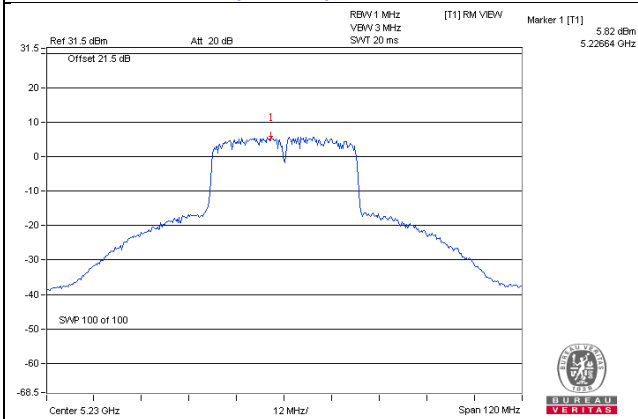

802.11ac (VHT80)_Chain 1 / CH42

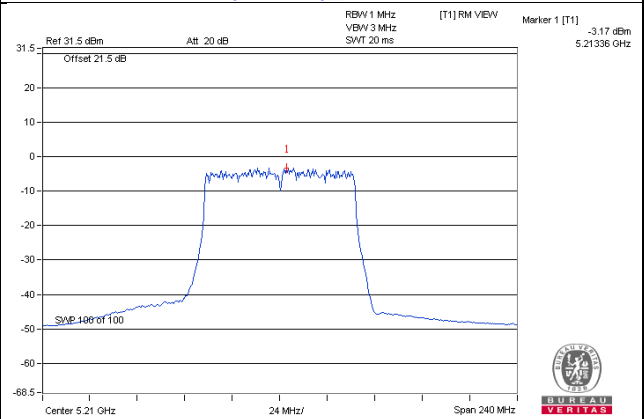

For U-NII-3:

802.11a

TX chain	Chan.	Chan. Freq. (MHz)	PSD W/O Duty Factor		10 log (N=2) dB	Duty Factor (dB)	Total PSD With Duty Factor (dBm/500kHz)	Limit (dBm/500kHz)	Pass /Fail
			(dBm/300kHz)	(dBm/500kHz)					
0	149	5745	1.24	3.46	3.01	0.16	6.63	29.38	Pass
	157	5785	0.84	3.06	3.01	0.16	6.23	29.38	Pass
	165	5825	0.83	3.05	3.01	0.16	6.22	29.38	Pass
1	149	5745	2.57	4.79	3.01	0.16	7.96	29.38	Pass
	157	5785	2.34	4.56	3.01	0.16	7.73	29.38	Pass
	165	5825	0.39	2.61	3.01	0.16	5.78	29.38	Pass

Note: 1. Directional gain = $10 \log[(10^{G1/20} + 10^{G2/20})^2 / 2]$ = 6.62dBi > 6dBi , so the power density limit shall be reduced to $30-(6.62-6) = 29.38$ dBm.

2. Refer to section 3.3 for duty cycle spectrum plot.

802.11ac (VHT20)

TX chain	Channel	Freq. (MHz)	PSD (dBm/300kHz)	PSD (dBm/500kHz)	10 log (N=2) dB	Total PSD (dBm/500kHz)	Limit (dBm/500kHz)	Pass /Fail
0	149	5745	1.40	3.62	3.01	6.63	29.38	Pass
	157	5785	0.68	2.90	3.01	5.91	29.38	Pass
	165	5825	0.79	3.01	3.01	6.02	29.38	Pass
1	149	5745	0.95	3.17	3.01	6.18	29.38	Pass
	157	5785	1.68	3.90	3.01	6.91	29.38	Pass
	165	5825	0.69	2.91	3.01	5.92	29.38	Pass

Note: 1. Directional gain = $10 \log[(10^{G1/20} + 10^{G2/20})^2 / 2]$ = 6.62dBi > 6dBi , so the power density limit shall be reduced to $30-(6.62-6) = 29.38$ dBm.

802.11ac (VHT40)

TX chain	Chan.	Chan. Freq. (MHz)	PSD W/O Duty Factor		10 log (N=2) dB	Duty Factor (dB)	Total PSD With Duty Factor (dBm/500kHz)	Limit (dBm/500kHz)	Pass /Fail
			(dBm/300kHz)	(dBm/500kHz)					
0	151	5755	-2.46	-0.24	3.01	0.14	2.91	29.38	Pass
	159	5795	-2.73	-0.51	3.01	0.14	2.64	29.38	Pass
1	151	5755	-2.22	0.00	3.01	0.14	3.15	29.38	Pass
	159	5795	-1.71	0.51	3.01	0.14	3.66	29.38	Pass

Note: 1. Directional gain = $10 \log[(10^{G1/20} + 10^{G2/20})^2 / 2]$ = 6.62dBi > 6dBi , so the power density limit shall be reduced to $30-(6.62-6) = 29.38$ dBm.

2. Refer to section 3.3 for duty cycle spectrum plot.

802.11ac (VHT80)

TX chain	Chan.	Chan. Freq. (MHz)	PSD W/O Duty Factor		10 log (N=2) dB	Duty Factor (dB)	Total PSD With Duty Factor (dBm/500kHz)	Limit (dBm/500kHz)	Pass /Fail
			(dBm/300kHz)	(dBm/500kHz)					
0	155	5775	-7.44	-5.22	3.01	0.37	-1.84	29.38	Pass
1	155	5775	-8.19	-5.97	3.01	0.37	-2.59	29.38	Pass

Note: 1. Directional gain = $10 \log[(10^{G1/20} + 10^{G2/20})^2 / 2]$ = 6.62dBi > 6dBi , so the power density limit shall be reduced to $30-(6.62-6) = 29.38\text{dBm}$.

2. Refer to section 3.3 for duty cycle spectrum plot.

Spectrum Plot of Worst Value

802.11a – Chain 1: CH 149

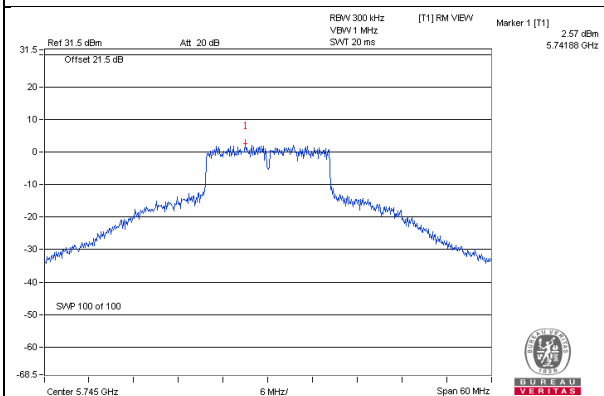

802.11ac (VHT20) – Chain 1: CH 157

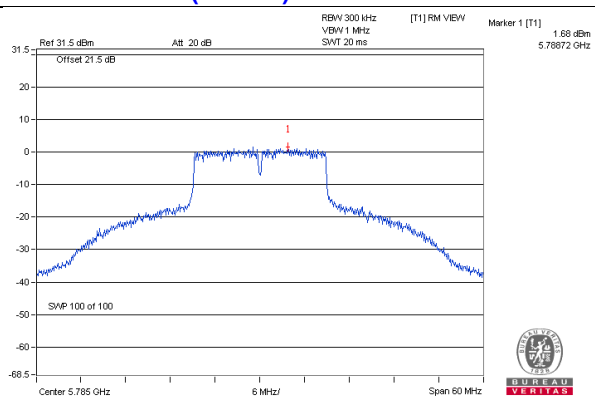

802.11ac (VHT40) – Chain 1: CH 159

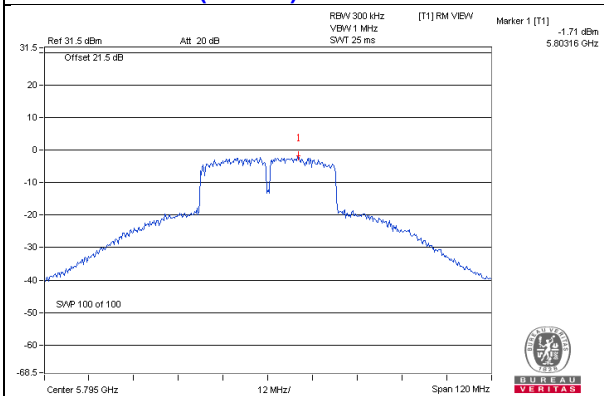

802.11ac (VHT80) – Chain 0: CH 155

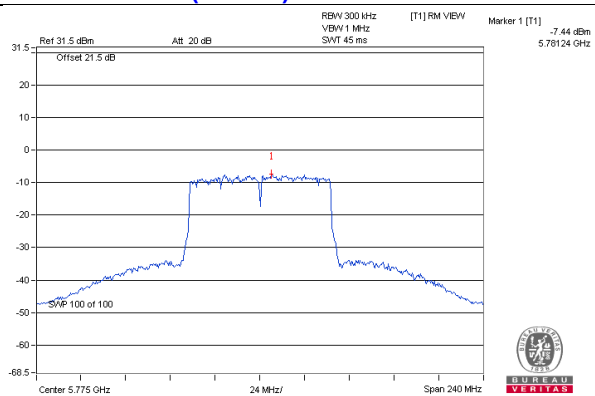

4.6 Frequency Stability Measurement

4.6.1 Limits of Frequency Stability Measurement

The frequency of the carrier signal shall be maintained within band of operation

4.6.2 Test Setup

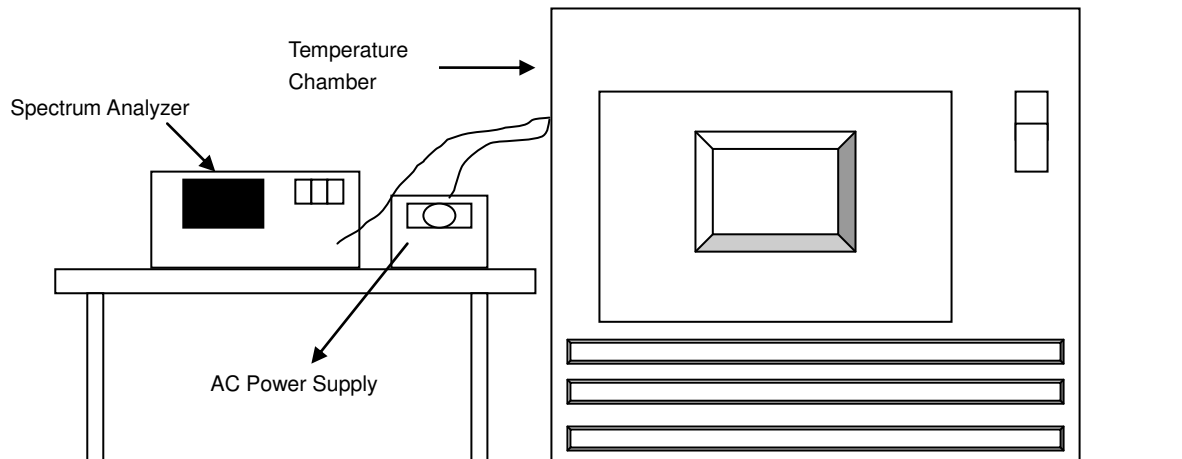

4.6.3 Test Instruments

DESCRIPTION & MANUFACTURER	MODEL NO.	SERIAL NO.	CALIBRATED DATE	CALIBRATED UNTIL
Spectrum Analyzer R&S	FSP40	100060	May 11, 2016	May 10, 2017
Temperature & Humidity Chamber Giant Force	GTH-150-40-SP-AR	MAA0812-008	Jan. 15, 2016	Jan. 14, 2017
Digital Multimeter FLUKE	87III	73680266	Nov. 10, 2015	Nov. 09, 2016
AC Power Source Extech Electronics	6205	1440452	NA	NA

- NOTE:**
1. The test was performed in Oven room 2.
 2. The calibration interval of the above test instruments is 12 months and the calibrations are traceable to NML/ROC and NIST/USA.
 3. Tested Date: Sep. 19, 2016

4.6.4 Test Procedure

- a. The EUT was placed inside the environmental test chamber and powered by nominal AC voltage.
- b. Turn the EUT on and couple its output to a spectrum analyzer.
- c. Turn the EUT off and set the chamber to the highest temperature specified.
- d. Allow sufficient time (approximately 30 min) for the temperature of the chamber to stabilize, turn the EUT on and measure the operating frequency after 2, 5, and 10 Minutes.
- e. Repeat step 2 and 3 with the temperature chamber set to the lowest temperature.
- f. The test chamber was allowed to stabilize at +20 degree C for a minimum of 30 Minutes. The supply voltage was then adjusted on the EUT from 85% to 115% and the frequency record.

4.6.5 Deviation from Test Standard

No deviation.

4.6.6 EUT Operating Condition

Set the EUT transmit at un-modulation mode to test frequency stability.

4.6.7 Test Results

Frequency Stability Versus Temp.									
Operating Frequency: 5180 MHz									
TEMP. (°C)	Power Supply (Vac)	0 Minute		2 Minute		5 Minute		10 Minute	
		Measured Frequency (MHz)	Pass/Fail	Measured Frequency (MHz)	Pass/Fail	Measured Frequency (MHz)	Pass/Fail	Measured Frequency (MHz)	Pass/Fail
50	120	5179.996	Pass	5179.9986	Pass	5179.9992	Pass	5179.9969	Pass
40	120	5180.015	Pass	5180.0145	Pass	5180.016	Pass	5180.0158	Pass
30	120	5180.0025	Pass	5180.0066	Pass	5180.0049	Pass	5180.0053	Pass
20	120	5179.9994	Pass	5180.001	Pass	5180.0024	Pass	5180.0027	Pass
10	120	5180.0217	Pass	5180.0242	Pass	5180.0226	Pass	5180.0234	Pass
0	120	5179.9986	Pass	5179.9981	Pass	5179.9968	Pass	5179.9987	Pass
-10	120	5180.0252	Pass	5180.0262	Pass	5180.0256	Pass	5180.0215	Pass
-20	120	5179.9864	Pass	5179.9842	Pass	5179.9849	Pass	5179.9871	Pass
-30	120	5180.019	Pass	5180.0193	Pass	5180.0191	Pass	5180.0164	Pass

Frequency Stability Versus Voltage									
Operating Frequency: 5180 MHz									
TEMP. (°C)	Power Supply (Vac)	0 Minute		2 Minute		5 Minute		10 Minute	
		Measured Frequency (MHz)	Pass/Fail	Measured Frequency (MHz)	Pass/Fail	Measured Frequency (MHz)	Pass/Fail	Measured Frequency (MHz)	Pass/Fail
20	138	5179.9995	Pass	5180.0006	Pass	5180.0022	Pass	5180.0017	Pass
	120	5179.9994	Pass	5180.001	Pass	5180.0024	Pass	5180.0027	Pass
	102	5179.9991	Pass	5180.0016	Pass	5180.0031	Pass	5180.0025	Pass

4.7 6dB Bandwidth Measurement

4.7.1 Limits of 6dB Bandwidth Measurement

The minimum of 6dB Bandwidth Measurement is 0.5MHz.

4.7.2 Test Setup

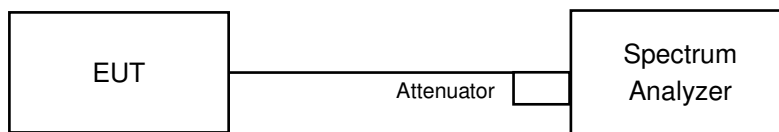

4.7.3 Test Instruments

DESCRIPTION & MANUFACTURER	MODEL NO.	SERIAL NO.	CALIBRATED DATE	CALIBRATED UNTIL
Spectrum Analyzer R&S	FSP40	100060	May 11, 2016	May 10, 2017

- NOTE:**
1. The test was performed in Oven room 2.
 2. The calibration interval of the above test instruments is 12 months and the calibrations are traceable to NML/ROC and NIST/USA.
 3. Tested Date: Sep. 19, 2016

4.7.4 Test Procedure

MEASUREMENT PROCEDURE REF

- a. Set resolution bandwidth (RBW) = 100kHz
- b. Set the video bandwidth (VBW) $\geq 3 \times$ RBW, Detector = Peak.
- c. Trace mode = max hold.
- d. Sweep = auto couple.
- e. Measure the maximum width of the emission that is constrained by the frequencies associated with the two amplitude points (upper and lower) that are attenuated by 6 dB relative to the maximum level measured in the fundamental emission

4.7.5 Deviation from Test Standard

No deviation.

4.7.6 EUT Operating Condition

The software provided by client to enable the EUT under transmission condition continuously at lowest, middle and highest channel frequencies individually.

4.7.7 Test Results

802.11a

Channel	Frequency (MHz)	6dB Bandwidth (MHz)		Minimum Limit (MHz)	Pass / Fail
		Chain 0	Chain 1		
149	5745	16.07	16.37	0.5	PASS
157	5785	15.46	15.94	0.5	PASS
165	5825	15.49	16.36	0.5	PASS

802.11ac (VHT20)

Channel	Frequency (MHz)	6dB Bandwidth (MHz)		Minimum Limit (MHz)	Pass / Fail
		Chain 0	Chain 1		
149	5745	16.61	17.60	0.5	PASS
157	5785	17.62	16.82	0.5	PASS
165	5825	17.57	17.57	0.5	PASS

802.11ac (VHT40)

Channel	Frequency (MHz)	6dB Bandwidth (MHz)		Minimum Limit (MHz)	Pass / Fail
		Chain 0	Chain 1		
151	5755	35.18	35.21	0.5	PASS
159	5795	35.42	35.33	0.5	PASS

802.11ac (VHT80)

Channel	Frequency (MHz)	6dB Bandwidth (MHz)		Minimum Limit (MHz)	Pass / Fail
		Chain 0	Chain 1		
155	5775	75.43	75.43	0.5	PASS

Spectrum Plot of Worst Value

802.11a / Chain 0 : CH157

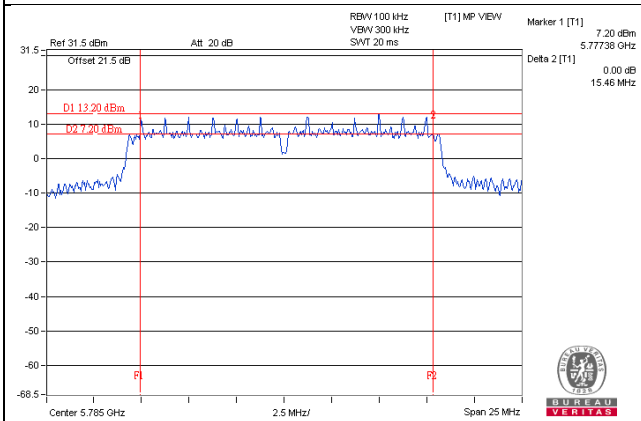

802.11ac(VHT20) / Chain 0 : CH149

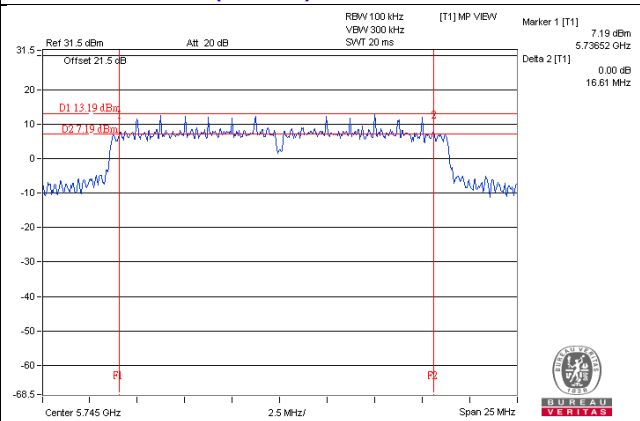

802.11ac(VHT40) / Chain 0 : CH151

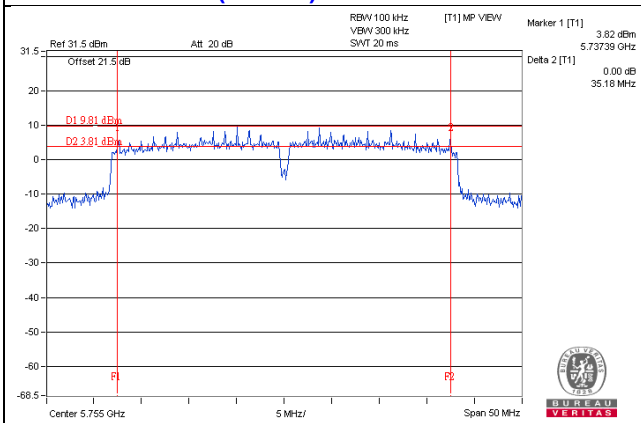

802.11ac(VHT80) / Chain 0 : CH155

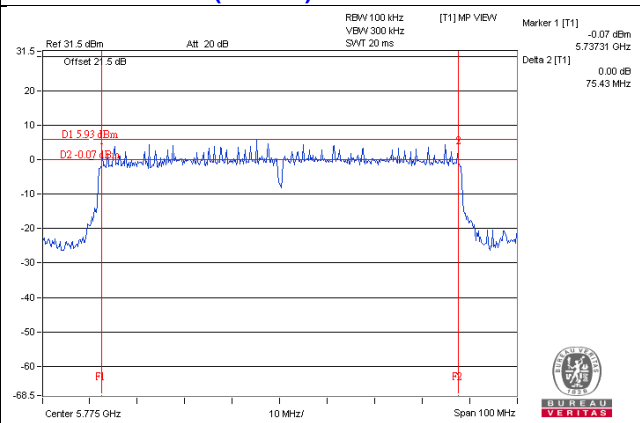

5 Pictures of Test Arrangements

Please refer to the attached file (Test Setup Photo).

Annex A- Radiated Out of Band Emission (OOBE) Measurement (For U-NII-3 band)

802.11a

CH 149 5745 MHz

Horizontal

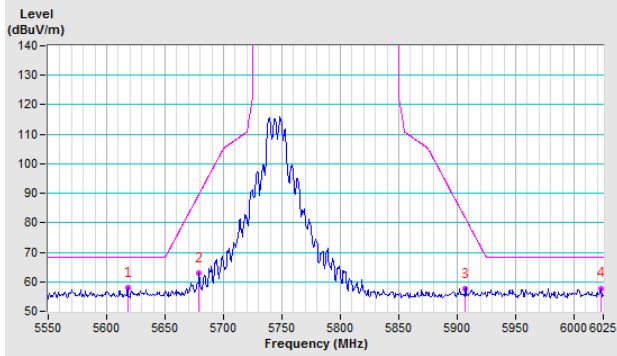

Vertical

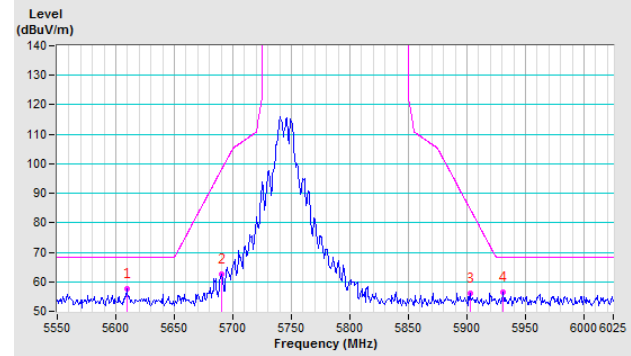

CH 157 5785 MHz

Horizontal

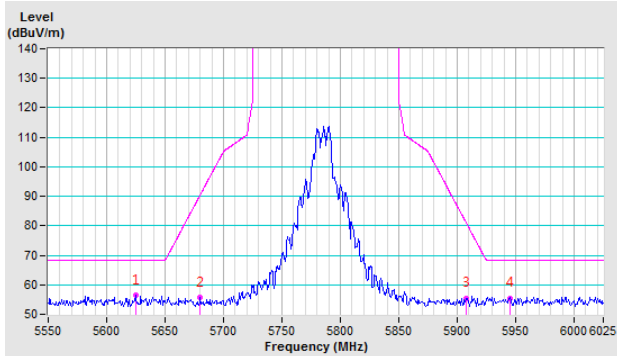

Vertical

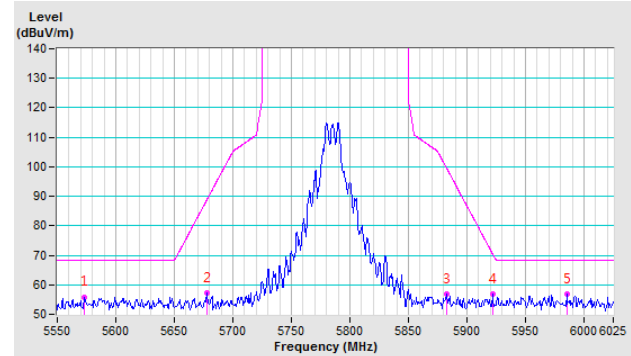

CH 165 5825 MHz

Horizontal

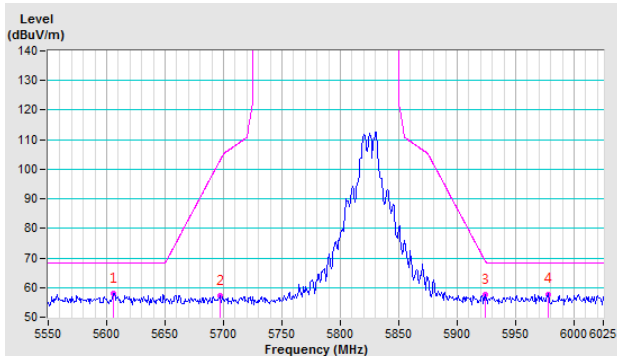

Vertical

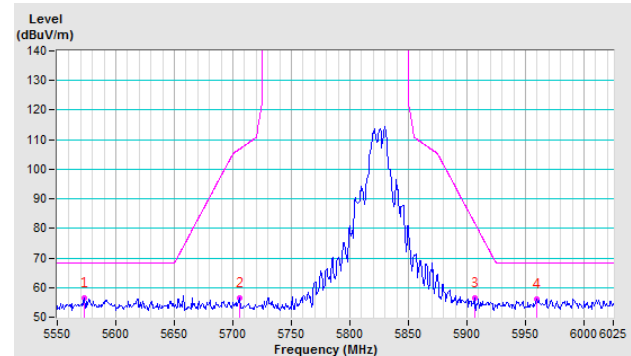

802.11ac (VHT20)

CH 149 5745 MHz

Horizontal

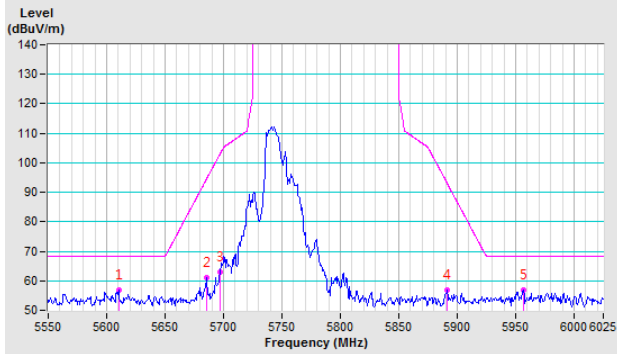

Vertical

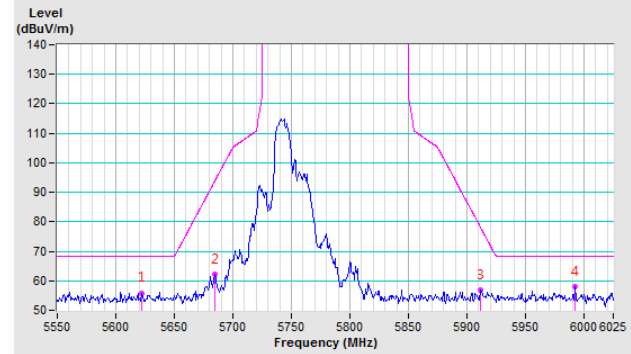

CH 157 5785 MHz

Horizontal

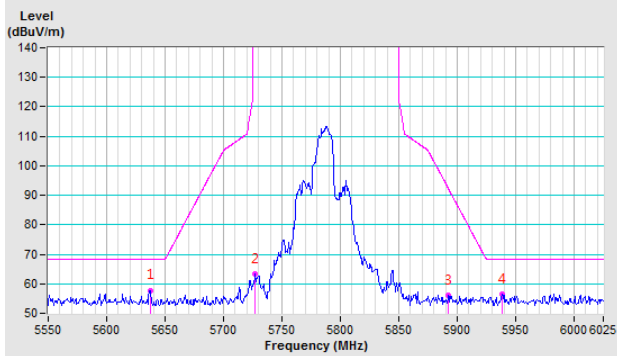

Vertical

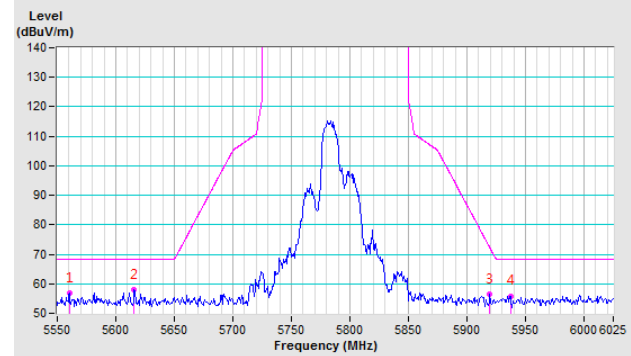

CH 165 5825 MHz

Horizontal

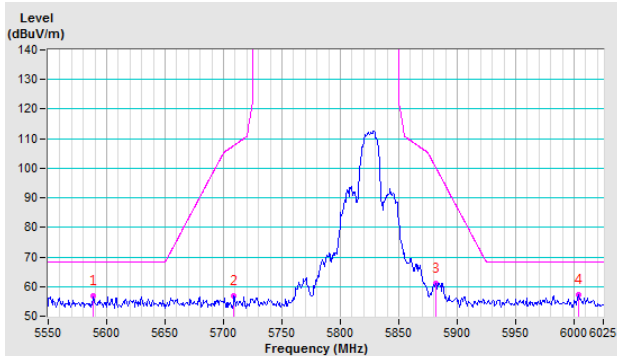

Vertical

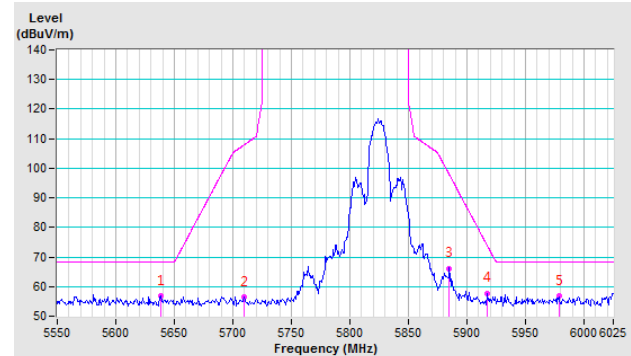

802.11ac (VHT40)

CH 151 5755 MHz

Horizontal

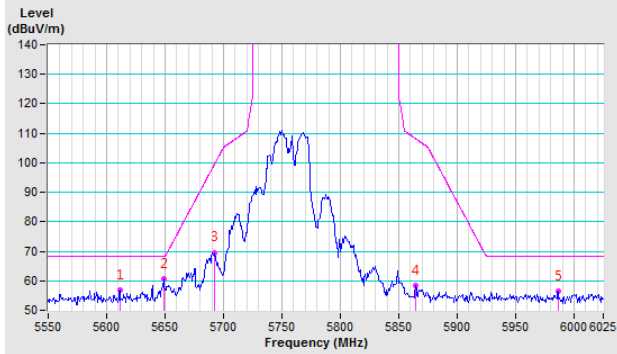

Vertical

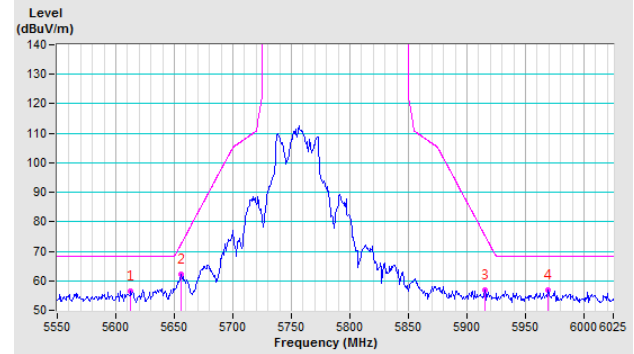

CH 159 5795 MHz

Horizontal

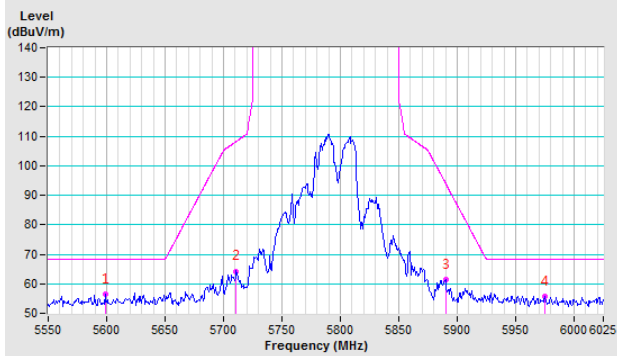

Vertical

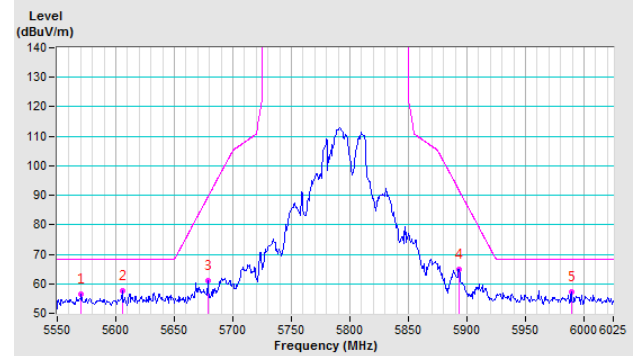

802.11ac (VHT80)

CH 155 5775 MHz

Horizontal

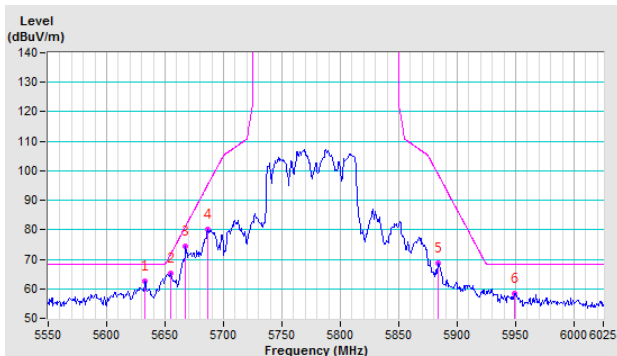

Vertical

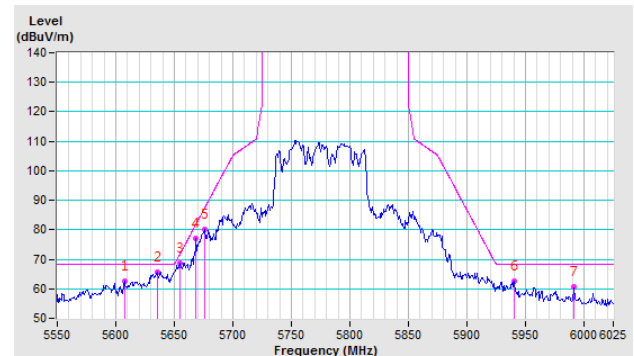

Appendix – Information on the Testing Laboratories

We, Bureau Veritas Consumer Products Services (H.K.) Ltd., Taoyuan Branch, were founded in 1988 to provide our best service in EMC, Radio, Telecom and Safety consultation. Our laboratories are accredited and approved according to ISO/IEC 17025.

If you have any comments, please feel free to contact us at the following:

Linko EMC/RF Lab

Tel: 886-2-26052180

Fax: 886-2-26051924

Hsin Chu EMC/RF/Telecom Lab

Tel: 886-3-6668565

Fax: 886-3-6668323

Hwa Ya EMC/RF/Safety Lab

Tel: 886-3-3183232

Fax: 886-3-3270892

Email: service.adt@tw.bureauveritas.com

Web Site: www.bureauveritas-adt.com

The address and road map of all our labs can be found in our web site also.

--- END ---