



# FCC DFS TEST REPORT

Applicant : D-Link Corporation

---

Address : 14420 Myford Road Suite 100, Irvine, California  
92606, United States

---

Equipment : Nuclias Connect AX3000 Outdoor Access Point

---

Model No. : DAP-X3060OU

---

Trade Name : D-Link

---

FCC ID : KA2APX3060OUA1

---

**I HEREBY CERTIFY THAT :**

The sample was received on Mar. 13, 2024 and the testing was completed on May. 02, 2024 at CerpPASS Technology Corp. The test result refers exclusively to the test presented test model / sample. Without written approval of CerpPASS Technology Corp., the test report shall not be reproduced except in full.

Approved by:

---

Kevin Liang / Supervisor

Laboratory Accreditation:

CerpPASS Technology Corporation Test Laboratory





## CONTENTS

1.	Summary of Test Procedure and Test Results .....	4
1.1.	Applicable Standards .....	4
2.	Test Configuration of Equipment under Test .....	5
2.1.	Feature of Equipment under Test.....	5
2.2.	Description of Test System.....	6
2.3.	General Information of Test.....	7
2.4.	Measurement Uncertainty .....	7
3.	Test Equipment and Ancillaries Used for Tests .....	8
4.	Antenna Requirements .....	9
4.1.	Standard Applicable .....	9
4.2.	Antenna Construction and Directional Gain.....	10
5.	Dynamic Frequency Selection .....	11
5.1.	List of Measurement and Examinations .....	11
5.2.	Test Setup .....	13
5.3.	DFS Detection Threshold.....	14
5.4.	Channel Availability Check Time .....	18
5.5.	Radar Burst at the Beginning of the Channel Availability Check Time .....	20
5.6.	Radar Burst at the End of the Channel Availability Check Time .....	22
5.7.	Channel Loading .....	24
5.8.	U-NII Detection Bandwidth.....	25
5.9.	Statistical Performance Check .....	37
5.10.	In-Service Monitoring .....	89
5.11.	Non-Occupancy Period .....	91
5.12.	EUT Setup Photos .....	93



**History of this test report**

Report No.	Issued Date	Description
24020130-TRFCC03	May. 30, 2024	Original



# 1. Summary of Test Procedure and Test Results

## 1.1. Applicable Standards

**ANSI C63.10:2013**

**FCC Rules and Regulations Part 15 Subpart E §15.407**

**KDB 789033**

**KDB 905462**

FCC Rule	Description of Test	Result
15.407	Dynamic Frequency Selection	PASS

\*The lab has reduced the uncertainty risk factor from test equipment, environment and staff technicians which according to the standard on contract. Therefore, the test result will only be determined by standard requirement, measurement uncertainty evaluation is not considered.



## 2. Test Configuration of Equipment under Test

### 2.1. Feature of Equipment under Test

Operation Frequency Range	802.11b/g/n/(Turbo QAM)/ax: 2400-2483.5MHz 802.11a/n/ac/ax: 5150-5250MHz, 5250-5350MHz, 5470-5725MHz, 5725-5850MHz
Center Frequency Range	802.11b/g/n/(Turbo QAM)/ax: 2412MHz~2462MHz 802.11a/n/ac/ax: 5180-5240MHz, 5260-5320MHz, 5500-5720MHz, 5745-5825MHz
Modulation Type	WLAN: 2.4GHz: 802.11b: CCK, DQPSK, DBPSK 802.11g/n: BPSK, QPSK, 16QAM, 64QAM, 256QAM(TurboQAM) 802.11ax: BPSK, QPSK, 16QAM, 64QAM, 256QAM, 1024QAM 5GHz: 802.11n/a: BPSK, QPSK, 16QAM, 64QAM 802.11ac: BPSK, QPSK, 16QAM, 64QAM, 256QAM 802.11ax: BPSK, QPSK, 16QAM, 64QAM, 256QAM, 1024QAM
Modulation Technology	DSSS, OFDM, OFDMA
Data Rate	WLAN: 2.4GHz: 802.11b: 1, 2, 5.5, 11Mbps 802.11g: 6, 9, 12, 18, 24, 36, 48, 54Mbps 802.11n: MCS0 – MCS15, HT20/40 MCS0 – MCS9, VHT20/40(TurboQAM) 802.11ax: MCS0 – MCS11, HE20/40 5GHz: 802.11a: 6, 9, 12, 18, 24, 36, 48, 54Mbps 802.11n: MCS0 – MCS15, HT20/40 802.11ac: MCS0 – MCS9, VHT20/40/80/160 802.11ax: MCS0 – MCS11, HE20/40/80/160
Antenna Type	Embedded Antenna
Antenna Gain	2400-2500MHz: ANT C: 5.0dBi, ANT D: 3.4dBi 5150-5250MHz: ANT A: 5.4dBi, ANT B: 5.5dBi 5250-5350MHz: ANT A: 5.1dBi, ANT B: 5.8dBi 5470-5725MHz: ANT A: 4.6dBi, ANT B: 7.3dBi 5725-5850MHz: ANT A: 4.5dBi, ANT B: 7.9dBi

Note:

1. EUT support TPC Function.
2. WLAN 2.4G and WLAN 5G can simultaneously transmission.
3. EUT support Master Mode.
4. WLAN 2.4G TurboQAM & 5GHz 11ac support beamforming Function.
5. WLAN 2.4 GHz / 5GHz 11ax support beamforming Function.
6. For more details, please refer to the User's manual of the EUT.



## 2.2. Description of Test System

DFS				
Equipment	Brand	Model	Length/Type	Power cord/Length/Type
Notebook	Lenovo	S2292L	N/A	Adapter / 1.8m / NS
RJ45 Cable*2	TE CONNECTIVITY	CAT5E	1.2m / NS	N/A
POE	UBIQUITI	GP-V480-032G	N/A	0.6m / NS
Notebook	DELL	Latitude 9420	N/A	Adapter / 1.8m / NS



### 2.3. General Information of Test

☒ Test Site	CerpPASS Technology Corporation Test Laboratory Address: No.10, Ln. 2, Lianfu St., Luzhu Dist., Taoyuan City 33848, Taiwan (R.O.C.) Tel: +886-3-3226-888 Fax: +886-3-3226-881	
	FCC	TW1439, TW1079
	IC	4934E-1, 4934E-2
Frequency Range Investigated	Conducted: from 150kHz to 30 MHz Radiation: from 30 MHz to 40,000MHz	
Test Distance	The test distance of radiated emission from antenna to EUT is 3 M.	

Test Item	Test Site	Test period	Environmental Conditions	Tested By
DFS	RFDFS01-NK	2024/4/1~2024/5/2	23.5~25.9°C / 38~46%	Eason Hsu

### 2.4. Measurement Uncertainty

ISO/IEC 17025 requires that an estimate of the measurement uncertainties associated with the emissions test results be included in the report. The measurement uncertainties given below are based on a 95% confidence level (based on a coverage factor (k=2))

Measurement Item	Uncertainty
Channel Move Time	±5.6%
Channel Closing Transmission Time	±7.4%
Threshold	±2.5dB



### 3. Test Equipment and Ancillaries Used for Tests

Test Item	DFS				
Test Site	RFDFS01-NK				
Instrument	Manufacturer	Model No	Serial No	Calibration Date	Valid Date
CAX Signal Analyzer	KEYSIGHT	N9000B	MY57100291	2023/10/11	2024/10/10
MXG-B RF Vector Signal Generator + Frequency Extender	KEYSIGHT	N5182B+ N5182BX07	MY53051383+ MY59362519	2024/02/16	2025/02/15
IOT0047A	KEYSIGHT	V23.9.1.10	NA	NA	NA
N7607C Signal Studio	KEYSIGHT	v1.5.5.0	NA	NA	NA
InServiceMonitorUtility	Theda	v10.0.0.0	NA	NA	NA





## 4. Antenna Requirements

### 4.1. Standard Applicable

For intentional device, according to FCC 47 CFR Section 15.203, an intentional radiator shall be designed to ensure that no antenna other than that furnished by the responsible party shall be used with the device.

And according to FCC 47 CFR Section 15.407 (a), if transmitting antennas of directional gain greater than 6dBi are used, the power shall be reduced by the amount in dB that the directional gain of the antenna exceeds 6dBi.



### 4.2. Antenna Construction and Directional Gain

Antenna Type	Embedded Antenna
Antenna Gain	5250-5350MHz: ANT A: 5.1dBi, ANT B: 5.8dBi 5470-5725MHz: ANT A: 4.6dBi, ANT B: 7.3dBi

#### **(Non-Beamforming)**

5250MHz -5350MHz
For Power directional gain= $G_{ant}= 5.80$ dBi For PSD directional gain = $10 \log[(10^{G1/20} + 10^{G2/20} + \dots + 10^{GN/20})^2 / N_{ANT}]$ = 8.47 dBi
5470MHz -5725MHz
For Power directional gain= $G_{ant}= 7.30$ dBi For PSD directional gain = $10 \log[(10^{G1/20} + 10^{G2/20} + \dots + 10^{GN/20})^2 / N_{ANT}]$ = 9.06 dBi

\*MIMO type: Cyclic Delay Diversity (CDD) mode.

#### **(Beamforming)**

5250MHz -5350MHz
For Power directional gain= 8.47 dBi For PSD directional gain = 8.47 dBi
5470MHz -5725MHz
For Power directional gain=9.06 dBi For PSD directional gain = 9.06 dBi

\*MIMO type: Cyclic Delay Diversity (CDD) mode.



## 5. Dynamic Frequency Selection

### 5.1. List of Measurement and Examinations

#### EUT Applicability of DFS requirements and Frequency Range

Operation Mode		Operating Frequency Range	
		5250-5350MHz	5470-5725MHz
Master	√	√	√
Client without radar detection	--	--	--
Client with radar detection	--	--	--

#### DEVICES WITH RADAR DETECTION

MAXIMUM TRANSMIT POWER	VALUE (SEE Note 1 and 2)
≥ 200 milliwatt	-64 dBm
EIRP < 200 milliwatt and power spectral density < 10 dBm/MHz	-62 dBm
EIRP < 200 milliwatt that do not meet the power spectral density requirement	-64 dBm

Note 1: This is the level at the input of the receiver assuming a 0 dBi receive antenna.

Note 2: Throughout these test procedures an additional 1 dB has been added to the amplitude of the test transmission waveforms to account for variations in measurement equipment. This will ensure that the test signal is at or above the detection threshold level to trigger a DFS response.

Note3: EIRP is based on the highest antenna gain. For MIMO devices refer to KDB Publication 662911

**Table1: Applicability of DFS requirements prior to use of a channel**

REQUIREMENT RADAR	OPERATIONAL MODE		
	MASTER	CLIENT WITHOUT RADAR DETECTION	CLIENT WITH RADAR DETECTION
Non-Occupancy Period	V	Not required	V
DFS Detection Threshold	V	Not required	V
Channel Availability Check Time	V	Not required	Not required
U-NII Detection Bandwidth	V	Not required	V



**Table2: Applicability of DFS requirements during normal operation**

REQUIREMENT RADAR	OPERATIONAL MODE		
	MASTER	CLIENT WITHOUT RADAR DETECTION	CLIENT WITH RADAR DETECTION
DFS Detection Threshold	√	Not required	√
Channel Closing Transmission Time	√	√	√
Channel Move Time	√	√	√
U-NII Detection Bandwidth	√	Not required	√

Additional requirements for devices with multiple bandwidth modes	Master or Client with radar detection	Client without radar detection
U-NII Detection Bandwidth and Statistical Performance Check	All BW modes must be tested	Not required
Channel Move Time and Channel Closing Transmission Time	Test using widest BW mode available	Test using the widest BW mode available for the link
All other	Any single BW mode	Not required

Note: Frequencies selected for statistical performance check (Section 7.8.4) should include several frequencies within the radar detection bandwidth and frequencies near the edge of the radar detection bandwidth. For 802.11 devices it is suggested to select frequencies in each of the bonded 20 MHz channels and the channel center frequency.



## 5.2. Test Setup

### Setup for Master with injection at the Master

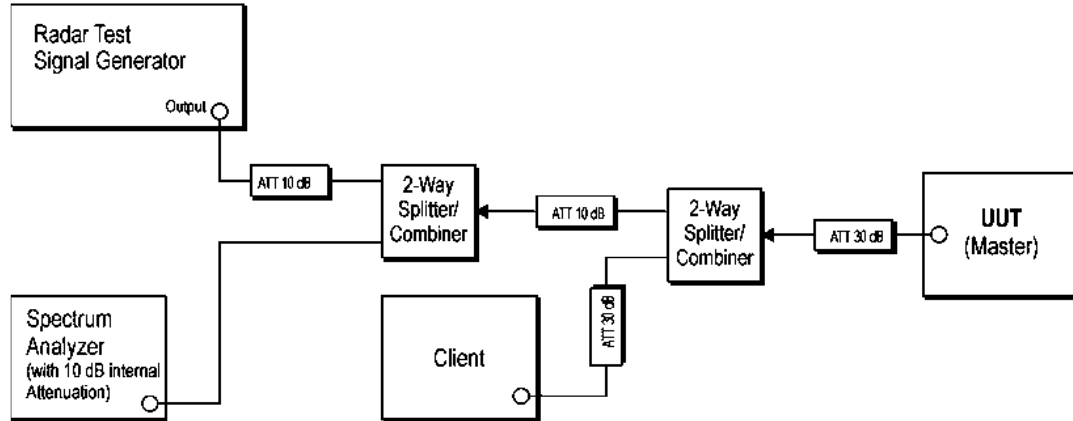

Figure 1: Example Conducted Setup where UUT is a Master and Radar Test Waveforms are injected into the Master



### 5.3. DFS Detection Threshold

DFS Detection Threshold is the level used by the DFS mechanism to detect radar interference.

#### 5.3.1. Test Limit

Limits Clause 4.7.2.1.2

DFS Detection Thresholds for Master Devices and Client Devices with Radar

Detection

MAXIMUM TRANSMIT POWER	VALUE (SEE Note 1 and 2)
≥ 200 milliwatt	-64 dBm
EIRP < 200 milliwatt and power spectral density < 10 dBm/MHz	-62 dBm
EIRP < 200 milliwatt that do not meet the power spectral density requirement	-64 dBm

Note 1: This is the level at the input of the receiver assuming a 0 dBi receive antenna.

Note 2: Throughout these test procedures an additional 1 dB has been added to the amplitude of the test transmission waveforms to account for variations in measurement equipment. This will ensure that the test signal is at or above the detection threshold level to trigger a DFS response.

Note3: EIRP is based on the highest antenna gain. For MIMO devices refer to KDB Publication 662911

Non Beamforming:

Max. output power	Band: 5250-5350MHz
	802.11a: 18.91dBm
	802.11ax HE20: 19.41dBm
	802.11ax HE40: 21.06dBm
	802.11ax HE80: 16.35dBm
	Band: 5470-5725MHz
	802.11a: 18.06dBm
	802.11ax HE20: 18.52dBm
	802.11ax HE40: 20.19dBm
	802.11ax HE80: 17.77dBm

Beamforming:

Max. output power	Band: 5250-5350MHz
	802.11ax HE20: 16.68dBm
	802.11ax HE40: 17.74dBm
	802.11ax HE80: 13.49dBm
	Band: 5470-5725MHz
	802.11ax HE20: 16.00dBm
	802.11ax HE40: 18.30dBm
	802.11ax HE80: 16.11dBm



### 5.3.2. Test Result of DFS Detection Threshold

EIRP < 200 milliwatt and power spectral density < 10 dBm/MHz, The device installed with 2\*Tx and 2\*Rx antenna delivery. Antenna corresponding gains are 0dBi for 5GHz. 0dBi gain was used to set the -62dBm threshold level during calibration of the test setup.  
Radar VALUE -62dBm



### Calibration Plot (Master)-

Radar Type 0

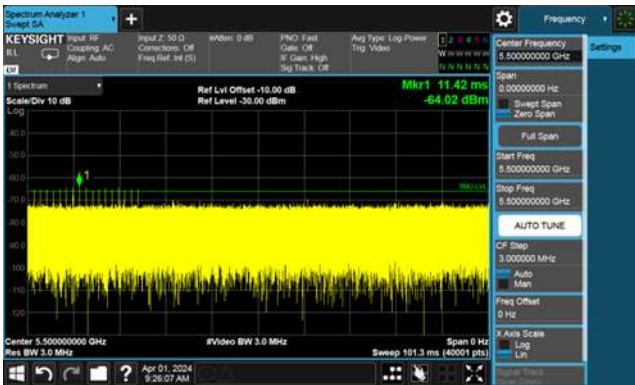

Radar Type 3



Radar Type 1

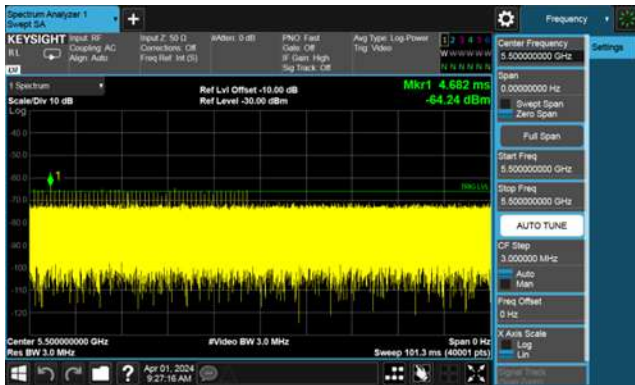

Radar Type 4



Radar Type 2

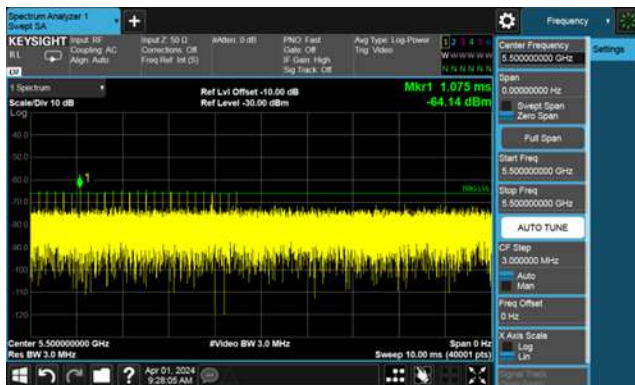

Radar Type 5

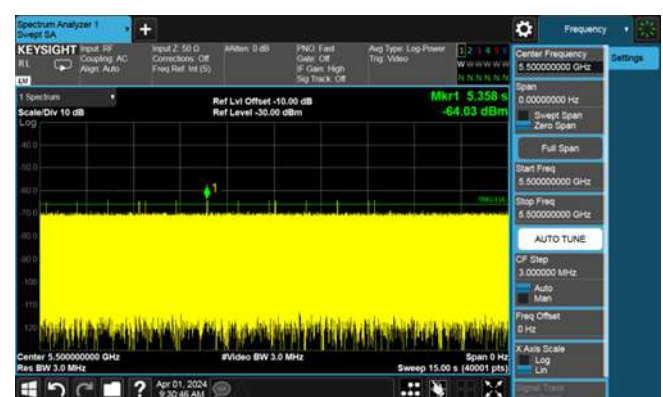





### Radars Type 6





#### 5.4. Channel Availability Check Time

The Channel Availability Check is defined as the mechanism by which an RLAN device checks a channel for the presence of radar signals.

There shall be no transmissions by the device within the channel being checked during this process. If no radars have been detected, the channel becomes an Available Channel valid for a period of time.

The RLAN shall only start transmissions on Available Channels.

At power-up, the RLAN is assumed to have no Available Channels.

##### 5.4.1. Test Limit

Limits Clause 4.7.2.1.2

Table D.2: DFS requirement values

Parameter	Value
Channel Availability Check	> 60s



### 5.4.2. Test Result of Channel Availability Check

Modulation Standard: 802.11ax HE160

CH 114 @5500MHz





### 5.5. Radar Burst at the Beginning of the Channel Availability Check Time

The steps below define the procedure to verify successful radar detection on the test Channel during a period equal to the Channel Availability Check Time and avoidance of operation on that Channel when a radar Burst with a level equal to the DFS Detection Threshold + 1 dB occurs at the beginning of the Channel Availability Check Time. This is illustrated in **Figure 15**.

- a) The Radar Waveform generator and UUT are connected using the applicable test setup described in the sections on configuration for Conducted Tests or Radiated Tests and the power of the UUT is switched off.
- b) The UUT is powered on at  $T_0$ .  $T_1$  denotes the instant when the UUT has completed its power-up sequence ( $T_{power\_up}$ ). The Channel Availability Check Time commences on Chr at instant  $T_1$  and will end no sooner than  $T_1 + T_{ch\_avail\_check}$ .
- c) A single Burst of one of the Short Pulse Radar Types 0-4 will commence within a 6 second window starting at  $T_1$ . An additional 1 dB is added to the radar test signal to ensure it is at or above the DFS Detection Threshold, accounting for equipment variations/errors.
- d) Visual indication or measured results on the UUT of successful detection of the radar Burst will be recorded and reported. Observation of Chr for UUT emissions will continue for 2.5 minutes after the radar Burst has been generated.
- e) Verify that during the 2.5 minute measurement window no UUT transmissions occurred on Chr. The Channel Availability Check results will be recorded.

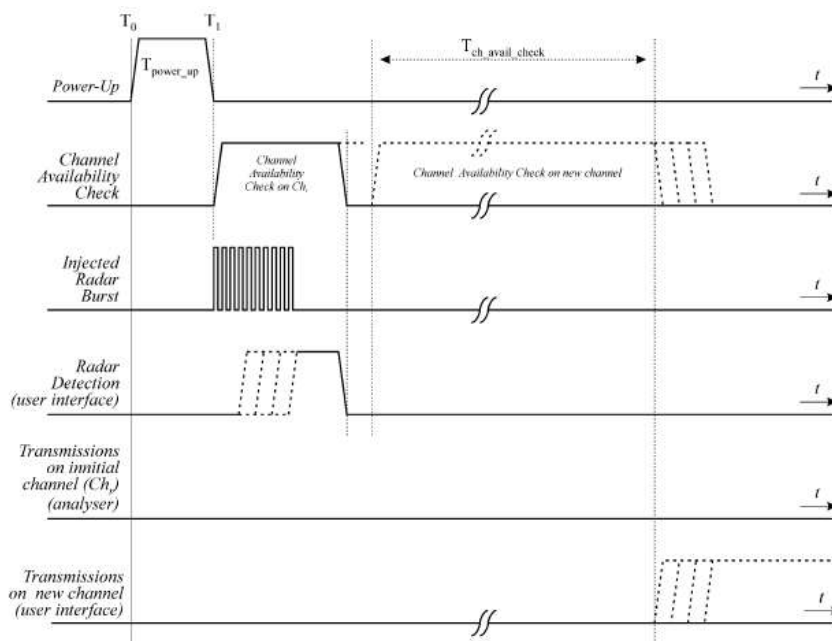

Figure 15: Example of timing for radar testing at the beginning of the Channel Availability Check Time



### 5.5.1. Test Result of radar burst at the beginning of the Channel Availability Check Time

Modulation Standard: 802.11ax HE160

CH 114 @5500MHz





### 5.6. Radar Burst at the End of the Channel Availability Check Time

The steps below define the procedure to verify successful radar detection on the test Channel during a period equal to the Channel Availability Check Time and avoidance of operation on that Channel when a radar Burst with a level equal to the DFS Detection Threshold + 1dB occurs at the end of the Channel Availability Check Time. This is illustrated in **Figure 16**.

- a) The Radar Waveform generator and UUT are connected using the applicable test setup described in the sections for Conducted Tests or Radiated Tests and the power of the UUT is switched off.
- b) The UUT is powered on at  $T_0$ .  $T_1$  denotes the instant when the UUT has completed its power-up sequence ( $T_{power\_up}$ ). The Channel Availability Check Time commences on Chr at instant  $T_1$  and will end no sooner than  $T_1 + T_{ch\_avail\_check}$ .
- c) A single Burst of one of the Short Pulse Radar Types 0-4 will commence within a 6 second window starting at  $T_1 + 54$  seconds. An additional 1 dB is added to the radar test signal to ensure it is at or above the DFS Detection Threshold, accounting for equipment variations/errors.
- d) Visual indication or measured results on the UUT of successful detection of the radar Burst will be recorded and reported. Observation of Chr for UUT emissions will continue for 2.5 minutes after the radar Burst has been generated.
- e) Verify that during the 2.5 minute measurement window no UUT transmissions occurred on Chr. The Channel Availability Check results will be recorded.

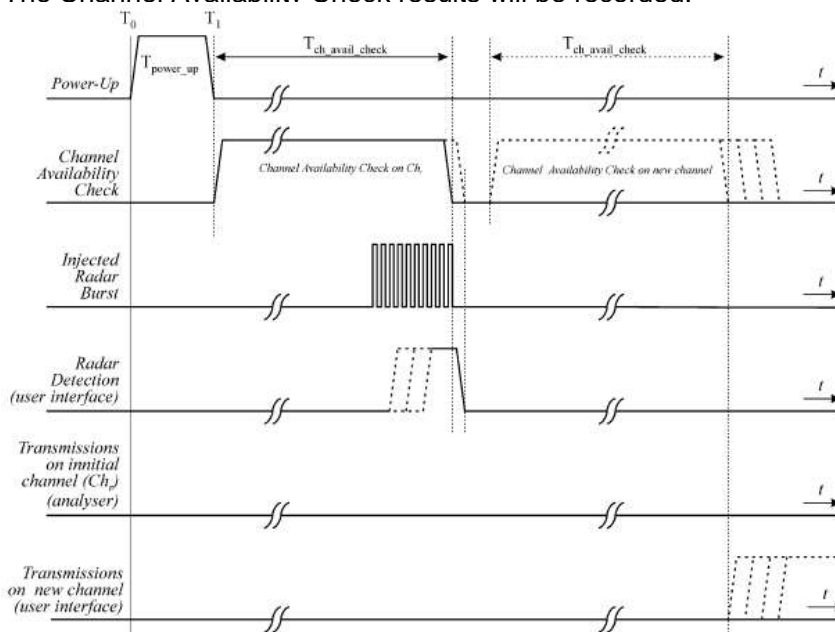

Figure 16: Example of timing for radar testing towards the end of the Channel Availability Check Time



5.6.1. Test Result of radar burst at the end of the Channel Availability Check Time

Modulation Standard: 802.11ax HE160

CH 114 @5500MHz





### 5.7. Channel Loading

A link is established between the Client, use IOT0047A ver. V23.9.1.10 Software to simulate data transfer is streamed to generate WLAN traffic.

Timing plots are required with calculations demonstrating a minimum channel loading of approximately 17% or greater. For example, channel loading can be estimated by setting the spectrum analyzer for zero span and approximate the Time On/ (Time On + Off Time). This can be done with any appropriate channel BW and modulation type

5570MHz, 802.11ax HE160, Band 3  
Time On/ (Time On + Off Time) =20.820%

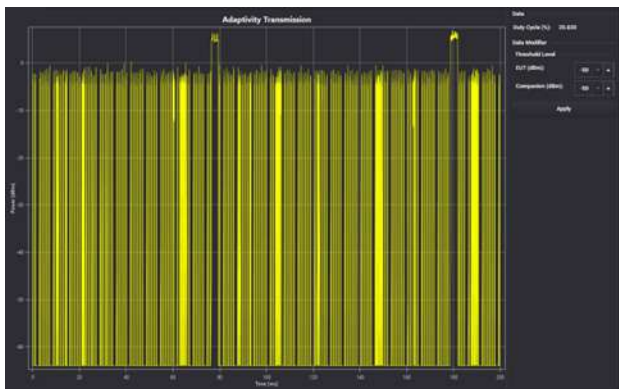





### 5.8. U-NII Detection Bandwidth

Additional requirements for devices with multiple bandwidth modes	Master or Client with radar detection	Client without radar detection
U-NII Detection Bandwidth and Statistical Performance Check	All BW modes must be tested	Not required
Note: Frequencies selected for statistical performance check (Section 7.8.4) should include several frequencies within the radar detection bandwidth and frequencies near the edge of the radar detection bandwidth. For 802.11 devices it is suggested to select frequencies in each of the bonded 20 MHz channels and the channel center frequency.		

#### 5.8.1. Test Limit

Limits Clause 4.7.2.1.2 Table D.2: DFS requirement values

Parameter	Value
U-NII Detection Bandwidth	Minimum 100% of the U-NII 99% transmission
Note : During the U-NII Detection Bandwidth detection test, radar type 0 should be used. For each frequency step the minimum percentage of detection is 90 percent. Measurements are performed with no data traffic.	



5.8.2. Test Result of U-NII Detection Bandwidth

20 MHz Signal Bandwidth											
EUT Frequency = 5500MHz											
Radar	DFS Detection Trials (1=Detection, Blank= No Detection)										
Frequency (MHz)	1	2	3	4	5	6	7	8	9	10	Detection Rate (%)
5491(FL)	1	1	1	1	1	1	1	1	1	1	100%
5492	1	1	1	1	1	1	1	1	1	1	100%
5493	1	1	1	1	1	1	1	1	1	1	100%
5494	1	1	1	1	1	1	1	1	1	1	100%
5495	1	1	1	1	1	1	1	1	1	1	100%
5496	1	1	1	1	1	1	1	1	1	1	100%
5497	1	1	1	1	1	1	1	1	1	1	100%
5498	1	1	1	1	1	1	1	1	1	1	100%
5499	1	1	1	1	1	1	1	1	1	1	100%
5500	1	1	1	1	1	1	1	1	1	1	100%
5501	1	1	1	1	1	1	1	1	1	1	100%
5502	1	1	1	1	1	1	1	1	1	1	100%
5503	1	1	1	1	1	1	1	1	1	1	100%
5504	1	1	1	1	1	1	1	1	1	1	100%
5505	1	1	1	1	1	1	1	1	1	1	100%
5506	1	1	1	1	1	1	1	1	1	1	100%
5507	1	1	1	1	1	1	1	1	1	1	100%
5508	1	1	1	1	1	1	1	1	1	1	100%
5509	1	1	1	1	1	1	1	1	1	1	100%
5510(FH)	1	1	1	1	1	1	1	1	1	1	100%
20 MHz Detection Bandwidth = Fh - Fl = 5510MHz - 5491MHz = 19MHz											
EUT 99% Bandwidth = 18.826MHz											



40 MHz Signal Bandwidth											
EUT Frequency = 5510MHz											
Radar Frequency (MHz)	DFS Detection Trials (1=Detection, Blank= No Detection)										Detection Rate (%)
	1	2	3	4	5	6	7	8	9	10	
5491(FL)	1	1	1	1	1	1	1	1	1	1	100%
5492	1	1	1	1	1	1	1	1	1	1	100%
5493	1	1	1	1	1	1	1	1	1	1	100%
5494	1	1	1	1	1	1	1	1	1	1	100%
5495	1	1	1	1	1	1	1	1	1	1	100%
5496	1	1	1	1	1	1	1	1	1	1	100%
5497	1	1	1	1	1	1	1	1	1	1	100%
5498	1	1	1	1	1	1	1	1	1	1	100%
5499	1	1	1	1	1	1	1	1	1	1	100%
5500	1	1	1	1	1	1	1	1	1	1	100%
5501	1	1	1	1	1	1	1	1	1	1	100%
5502	1	1	1	1	1	1	1	1	1	1	100%
5503	1	1	1	1	1	1	1	1	1	1	100%
5504	1	1	1	1	1	1	1	1	1	1	100%
5505	1	1	1	1	1	1	1	1	1	1	100%
5506	1	1	1	1	1	1	1	1	1	1	100%
5507	1	1	1	1	1	1	1	1	1	1	100%
5508	1	1	1	1	1	1	1	1	1	1	100%
5509	1	1	1	1	1	1	1	1	1	1	100%
5510	1	1	1	1	1	1	1	1	1	1	100%
5511	1	1	1	1	1	1	1	1	1	1	100%
5512	1	1	1	1	1	1	1	1	1	1	100%
5513	1	1	1	1	1	1	1	1	1	1	100%
5514	1	1	1	1	1	1	1	1	1	1	100%
5515	1	1	1	1	1	1	1	1	1	1	100%
5516	1	1	1	1	1	1	1	1	1	1	100%
5517	1	1	1	1	1	1	1	1	1	1	100%
5518	1	1	1	1	1	1	1	1	1	1	100%
5519	1	1	1	1	1	1	1	1	1	1	100%



5520	1	1	1	1	1	1	1	1	1	1	100%
5521	1	1	1	1	1	1	1	1	1	1	100%
5522	1	1	1	1	1	1	1	1	1	1	100%
5523	1	1	1	1	1	1	1	1	1	1	100%
5524	1	1	1	1	1	1	1	1	1	1	100%
5525	1	1	1	1	1	1	1	1	1	1	100%
5526	1	1	1	1	1	1	1	1	1	1	100%
5527	1	1	1	1	1	1	1	1	1	1	100%
5528	1	1	1	1	1	1	1	1	1	1	100%
5529(FH)	1	1	1	1	1	1	1	1	1	1	100%
40 MHz Detection Bandwidth = $F_h - F_l = 5529\text{MHz} - 5491\text{MHz} = 38\text{MHz}$											
EUT 99% Bandwidth = 37.738MHz											



80 MHz Signal Bandwidth											
EUT Frequency = 5530MHz											
Radar Frequency (MHz)	DFS Detection Trials (1=Detection, Blank= No Detection)										Detection Rate (%)
	1	2	3	4	5	6	7	8	9	10	
5492(FL)	1	1	1	1	1	1	1	1	1	1	100%
5493	1	1	1	1	1	1	1	1	1	1	100%
5494	1	1	1	1	1	1	1	1	1	1	100%
5495	1	1	1	1	1	1	1	1	1	1	100%
5496	1	1	1	1	1	1	1	1	1	1	100%
5497	1	1	1	1	1	1	1	1	1	1	100%
5498	1	1	1	1	1	1	1	1	1	1	100%
5499	1	1	1	1	1	1	1	1	1	1	100%
5500	1	1	1	1	1	1	1	1	1	1	100%
5501	1	1	1	1	1	1	1	1	1	1	100%
5502	1	1	1	1	1	1	1	1	1	1	100%
5503	1	1	1	1	1	1	1	1	1	1	100%
5504	1	1	1	1	1	1	1	1	1	1	100%
5505	1	1	1	1	1	1	1	1	1	1	100%
5506	1	1	1	1	1	1	1	1	1	1	100%
5507	1	1	1	1	1	1	1	1	1	1	100%
5508	1	1	1	1	1	1	1	1	1	1	100%
5509	1	1	1	1	1	1	1	1	1	1	100%
5510	1	1	1	1	1	1	1	1	1	1	100%
5511	1	1	1	1	1	1	1	1	1	1	100%
5512	1	1	1	1	1	1	1	1	1	1	100%
5513	1	1	1	1	1	1	1	1	1	1	100%
5514	1	1	1	1	1	1	1	1	1	1	100%
5515	1	1	1	1	1	1	1	1	1	1	100%
5516	1	1	1	1	1	1	1	1	1	1	100%
5517	1	1	1	1	1	1	1	1	1	1	100%
5518	1	1	1	1	1	1	1	1	1	1	100%
5519	1	1	1	1	1	1	1	1	1	1	100%
5520	1	1	1	1	1	1	1	1	1	1	100%



5521	1	1	1	1	1	1	1	1	1	1	100%
5522	1	1	1	1	1	1	1	1	1	1	100%
5523	1	1	1	1	1	1	1	1	1	1	100%
5524	1	1	1	1	1	1	1	1	1	1	100%
5525	1	1	1	1	1	1	1	1	1	1	100%
5526	1	1	1	1	1	1	1	1	1	1	100%
5527	1	1	1	1	1	1	1	1	1	1	100%
5528	1	1	1	1	1	1	1	1	1	1	100%
5529	1	1	1	1	1	1	1	1	1	1	100%
5530	1	1	1	1	1	1	1	1	1	1	100%
5531	1	1	1	1	1	1	1	1	1	1	100%
5532	1	1	1	1	1	1	1	1	1	1	100%
5533	1	1	1	1	1	1	1	1	1	1	100%
5534	1	1	1	1	1	1	1	1	1	1	100%
5535	1	1	1	1	1	1	1	1	1	1	100%
5536	1	1	1	1	1	1	1	1	1	1	100%
5537	1	1	1	1	1	1	1	1	1	1	100%
5538	1	1	1	1	1	1	1	1	1	1	100%
5539	1	1	1	1	1	1	1	1	1	1	100%
5540	1	1	1	1	1	1	1	1	1	1	100%
5541	1	1	1	1	1	1	1	1	1	1	100%
5542	1	1	1	1	1	1	1	1	1	1	100%
5543	1	1	1	1	1	1	1	1	1	1	100%
5544	1	1	1	1	1	1	1	1	1	1	100%
5545	1	1	1	1	1	1	1	1	1	1	100%
5546	1	1	1	1	1	1	1	1	1	1	100%
5547	1	1	1	1	1	1	1	1	1	1	100%
5548	1	1	1	1	1	1	1	1	1	1	100%
5549	1	1	1	1	1	1	1	1	1	1	100%
5550	1	1	1	1	1	1	1	1	1	1	100%
5551	1	1	1	1	1	1	1	1	1	1	100%
5552	1	1	1	1	1	1	1	1	1	1	100%
5553	1	1	1	1	1	1	1	1	1	1	100%
5554	1	1	1	1	1	1	1	1	1	1	100%
5555	1	1	1	1	1	1	1	1	1	1	100%
5556	1	1	1	1	1	1	1	1	1	1	100%



5557	1	1	1	1	1	1	1	1	1	1	100%
5558	1	1	1	1	1	1	1	1	1	1	100%
5559	1	1	1	1	1	1	1	1	1	1	100%
5560	1	1	1	1	1	1	1	1	1	1	100%
5561	1	1	1	1	1	1	1	1	1	1	100%
5562	1	1	1	1	1	1	1	1	1	1	100%
5563	1	1	1	1	1	1	1	1	1	1	100%
5564	1	1	1	1	1	1	1	1	1	1	100%
5565	1	1	1	1	1	1	1	1	1	1	100%
5566	1	1	1	1	1	1	1	1	1	1	100%
5567	1	1	1	1	1	1	1	1	1	1	100%
5568	1	1	1	1	1	1	1	1	1	1	100%
5569(FH)	1	1	1	1	1	1	1	1	1	1	100%
80 MHz Detection Bandwidth = Fh - Fl = 5569MHz - 5492MHz = 77MHz											
EUT 99% Bandwidth = 76.806MHz											



160 MHz Signal Bandwidth											
EUT Frequency = 5570MHz											
Radar Frequency (MHz)	DFS Detection Trials (1=Detection, Blank= No Detection)										Detection Rate (%)
	1	2	3	4	5	6	7	8	9	10	
5492(FL)	1	1	1	1	1	1	1	1	1	1	100%
5493	1	1	1	1	1	1	1	1	1	1	100%
5494	1	1	1	1	1	1	1	1	1	1	100%
5495	1	1	1	1	1	1	1	1	1	1	100%
5496	1	1	1	1	1	1	1	1	1	1	100%
5497	1	1	1	1	1	1	1	1	1	1	100%
5498	1	1	1	1	1	1	1	1	1	1	100%
5499	1	1	1	1	1	1	1	1	1	1	100%
5500	1	1	1	1	1	1	1	1	1	1	100%
5501	1	1	1	1	1	1	1	1	1	1	100%
5502	1	1	1	1	1	1	1	1	1	1	100%
5503	1	1	1	1	1	1	1	1	1	1	100%
5504	1	1	1	1	1	1	1	1	1	1	100%
5505	1	1	1	1	1	1	1	1	1	1	100%
5506	1	1	1	1	1	1	1	1	1	1	100%
5507	1	1	1	1	1	1	1	1	1	1	100%
5508	1	1	1	1	1	1	1	1	1	1	100%
5509	1	1	1	1	1	1	1	1	1	1	100%
5510	1	1	1	1	1	1	1	1	1	1	100%
5511	1	1	1	1	1	1	1	1	1	1	100%
5512	1	1	1	1	1	1	1	1	1	1	100%
5513	1	1	1	1	1	1	1	1	1	1	100%
5514	1	1	1	1	1	1	1	1	1	1	100%
5515	1	1	1	1	1	1	1	1	1	1	100%
5516	1	1	1	1	1	1	1	1	1	1	100%
5517	1	1	1	1	1	1	1	1	1	1	100%
5518	1	1	1	1	1	1	1	1	1	1	100%
5519	1	1	1	1	1	1	1	1	1	1	100%
5520	1	1	1	1	1	1	1	1	1	1	100%





5521	1	1	1	1	1	1	1	1	1	1	100%
5522	1	1	1	1	1	1	1	1	1	1	100%
5523	1	1	1	1	1	1	1	1	1	1	100%
5524	1	1	1	1	1	1	1	1	1	1	100%
5525	1	1	1	1	1	1	1	1	1	1	100%
5526	1	1	1	1	1	1	1	1	1	1	100%
5527	1	1	1	1	1	1	1	1	1	1	100%
5528	1	1	1	1	1	1	1	1	1	1	100%
5529	1	1	1	1	1	1	1	1	1	1	100%
5530	1	1	1	1	1	1	1	1	1	1	100%
5531	1	1	1	1	1	1	1	1	1	1	100%
5532	1	1	1	1	1	1	1	1	1	1	100%
5533	1	1	1	1	1	1	1	1	1	1	100%
5534	1	1	1	1	1	1	1	1	1	1	100%
5535	1	1	1	1	1	1	1	1	1	1	100%
5536	1	1	1	1	1	1	1	1	1	1	100%
5537	1	1	1	1	1	1	1	1	1	1	100%
5538	1	1	1	1	1	1	1	1	1	1	100%
5539	1	1	1	1	1	1	1	1	1	1	100%
5540	1	1	1	1	1	1	1	1	1	1	100%
5541	1	1	1	1	1	1	1	1	1	1	100%
5542	1	1	1	1	1	1	1	1	1	1	100%
5543	1	1	1	1	1	1	1	1	1	1	100%
5544	1	1	1	1	1	1	1	1	1	1	100%
5545	1	1	1	1	1	1	1	1	1	1	100%
5546	1	1	1	1	1	1	1	1	1	1	100%
5547	1	1	1	1	1	1	1	1	1	1	100%
5548	1	1	1	1	1	1	1	1	1	1	100%
5549	1	1	1	1	1	1	1	1	1	1	100%
5550	1	1	1	1	1	1	1	1	1	1	100%
5551	1	1	1	1	1	1	1	1	1	1	100%
5552	1	1	1	1	1	1	1	1	1	1	100%
5553	1	1	1	1	1	1	1	1	1	1	100%
5554	1	1	1	1	1	1	1	1	1	1	100%
5555	1	1	1	1	1	1	1	1	1	1	100%
5556	1	1	1	1	1	1	1	1	1	1	100%



5557	1	1	1	1	1	1	1	1	1	1	100%
5558	1	1	1	1	1	1	1	1	1	1	100%
5559	1	1	1	1	1	1	1	1	1	1	100%
5560	1	1	1	1	1	1	1	1	1	1	100%
5561	1	1	1	1	1	1	1	1	1	1	100%
5562	1	1	1	1	1	1	1	1	1	1	100%
5563	1	1	1	1	1	1	1	1	1	1	100%
5564	1	1	1	1	1	1	1	1	1	1	100%
5565	1	1	1	1	1	1	1	1	1	1	100%
5566	1	1	1	1	1	1	1	1	1	1	100%
5567	1	1	1	1	1	1	1	1	1	1	100%
5568	1	1	1	1	1	1	1	1	1	1	100%
5569	1	1	1	1	1	1	1	1	1	1	100%
5570	1	1	1	1	1	1	1	1	1	1	100%
5571	1	1	1	1	1	1	1	1	1	1	100%
5572	1	1	1	1	1	1	1	1	1	1	100%
5573	1	1	1	1	1	1	1	1	1	1	100%
5574	1	1	1	1	1	1	1	1	1	1	100%
5575	1	1	1	1	1	1	1	1	1	1	100%
5576	1	1	1	1	1	1	1	1	1	1	100%
5577	1	1	1	1	1	1	1	1	1	1	100%
5578	1	1	1	1	1	1	1	1	1	1	100%
5579	1	1	1	1	1	1	1	1	1	1	100%
5580	1	1	1	1	1	1	1	1	1	1	100%
5581	1	1	1	1	1	1	1	1	1	1	100%
5582	1	1	1	1	1	1	1	1	1	1	100%
5583	1	1	1	1	1	1	1	1	1	1	100%
5584	1	1	1	1	1	1	1	1	1	1	100%
5585	1	1	1	1	1	1	1	1	1	1	100%
5586	1	1	1	1	1	1	1	1	1	1	100%
5587	1	1	1	1	1	1	1	1	1	1	100%
5588	1	1	1	1	1	1	1	1	1	1	100%
5589	1	1	1	1	1	1	1	1	1	1	100%
5590	1	1	1	1	1	1	1	1	1	1	100%
5591	1	1	1	1	1	1	1	1	1	1	100%
5592	1	1	1	1	1	1	1	1	1	1	100%



5593	1	1	1	1	1	1	1	1	1	1	100%
5594	1	1	1	1	1	1	1	1	1	1	100%
5595	1	1	1	1	1	1	1	1	1	1	100%
5596	1	1	1	1	1	1	1	1	1	1	100%
5597	1	1	1	1	1	1	1	1	1	1	100%
5598	1	1	1	1	1	1	1	1	1	1	100%
5599	1	1	1	1	1	1	1	1	1	1	100%
5600	1	1	1	1	1	1	1	1	1	1	100%
5601	1	1	1	1	1	1	1	1	1	1	100%
5602	1	1	1	1	1	1	1	1	1	1	100%
5603	1	1	1	1	1	1	1	1	1	1	100%
5604	1	1	1	1	1	1	1	1	1	1	100%
5605	1	1	1	1	1	1	1	1	1	1	100%
5606	1	1	1	1	1	1	1	1	1	1	100%
5607	1	1	1	1	1	1	1	1	1	1	100%
5608	1	1	1	1	1	1	1	1	1	1	100%
5609	1	1	1	1	1	1	1	1	1	1	100%
5610	1	1	1	1	1	1	1	1	1	1	100%
5611	1	1	1	1	1	1	1	1	1	1	100%
5612	1	1	1	1	1	1	1	1	1	1	100%
5613	1	1	1	1	1	1	1	1	1	1	100%
5614	1	1	1	1	1	1	1	1	1	1	100%
5615	1	1	1	1	1	1	1	1	1	1	100%
5616	1	1	1	1	1	1	1	1	1	1	100%
5617	1	1	1	1	1	1	1	1	1	1	100%
5618	1	1	1	1	1	1	1	1	1	1	100%
5619	1	1	1	1	1	1	1	1	1	1	100%
5620	1	1	1	1	1	1	1	1	1	1	100%
5621	1	1	1	1	1	1	1	1	1	1	100%
5622	1	1	1	1	1	1	1	1	1	1	100%
5623	1	1	1	1	1	1	1	1	1	1	100%
5624	1	1	1	1	1	1	1	1	1	1	100%
5625	1	1	1	1	1	1	1	1	1	1	100%
5626	1	1	1	1	1	1	1	1	1	1	100%
5627	1	1	1	1	1	1	1	1	1	1	100%
5628	1	1	1	1	1	1	1	1	1	1	100%



5629	1	1	1	1	1	1	1	1	1	1	100%
5630	1	1	1	1	1	1	1	1	1	1	100%
5631	1	1	1	1	1	1	1	1	1	1	100%
5632	1	1	1	1	1	1	1	1	1	1	100%
5633	1	1	1	1	1	1	1	1	1	1	100%
5634	1	1	1	1	1	1	1	1	1	1	100%
5635	1	1	1	1	1	1	1	1	1	1	100%
5636	1	1	1	1	1	1	1	1	1	1	100%
5637	1	1	1	1	1	1	1	1	1	1	100%
5638	1	1	1	1	1	1	1	1	1	1	100%
5639	1	1	1	1	1	1	1	1	1	1	100%
5640	1	1	1	1	1	1	1	1	1	1	100%
5641	1	1	1	1	1	1	1	1	1	1	100%
5642	1	1	1	1	1	1	1	1	1	1	100%
5643	1	1	1	1	1	1	1	1	1	1	100%
5644	1	1	1	1	1	1	1	1	1	1	100%
5645	1	1	1	1	1	1	1	1	1	1	100%
5646	1	1	1	1	1	1	1	1	1	1	100%
5647	1	1	1	1	1	1	1	1	1	1	100%
5648(FH)	1	1	1	1	1	1	1	1	1	1	100%
160 MHz Detection Bandwidth = Fh - Fl = 5648MHz - 5492MHz = 156MHz											
EUT 99% Bandwidth = 155.66MHz											



### 5.9. Statistical Performance Check

Additional requirements for devices with multiple bandwidth modes	Master or Client with radar detection	Client without radar detection
Note: Frequencies selected for statistical performance check (Section 7.8.4) should include several frequencies within the radar detection bandwidth and frequencies near the edge of the radar detection bandwidth. For 802.11 devices it is suggested to select frequencies in each of the bonded 20 MHz channels and the channel center frequency.		



For 802. 11ax HE20, Band 3

Type1					
Trial Number	Pulse Width (us)	PRI (us)	Number of Pulses	Waveform Length(us)	1=Detection Blank=No Detection
1	1	938	57	53466	1
2	1	698	76	53048	1
3	1	618	86	53148	1
4	1	538	99	53262	1
5	1	878	61	53558	1
6	1	3066	18	55188	1
7	1	638	83	52954	1
8	1	918	58	53244	1
9	1	838	63	52794	1
10	1	858	62	53196	1
11	1	798	67	53466	1
12	1	718	74	53132	1
13	1	578	92	53176	1
14	1	598	89	53222	1
15	1	558	95	53010	1
16	1	2536	21	53256	1
17	1	966	55	53130	1
18	1	827	64	52928	1
19	1	2501	22	55022	1
20	1	2595	21	54495	1
21	1	1114	48	53472	1
22	1	1302	41	53382	1
23	1	3045	18	54810	1
24	1	1624	33	53592	1
25	1	2878	19	54682	1
26	1	1027	52	53404	1
27	1	2485	22	54670	1
28	1	1600	33	52800	1
29	1	1172	46	53912	1
30	1	1177	45	52965	1
Detection Percentage				Limit >60%	100%



Type2

Trial Number	Pulse Width (us)	PRI (us)	Number of Pulses	Waveform Length(us)	1=Detection Blank=No Detection
1	3.2	179	26	4654	1
2	1.1	207	23	4761	1
3	2.1	230	24	5520	1
4	4.8	200	29	5800	1
5	3.9	214	28	5992	1
6	2.9	222	26	5772	1
7	3.2	204	26	5304	1
8	2.5	192	25	4800	1
9	3.1	164	26	4264	1
10	1.2	156	23	3588	1
11	3.9	210	27	5670	1
12	4.6	201	29	5829	1
13	3.2	162	26	4212	1
14	2.2	197	25	4925	1
15	4.5	163	29	4727	1
16	3	203	26	5278	1
17	5	168	29	4872	1
18	2.4	217	25	5425	1
19	2.9	191	26	4966	1
20	2.3	166	25	4150	1
21	3.7	150	27	4050	1
22	2.2	176	25	4400	1
23	4.9	195	29	5655	1
24	2.9	202	26	5252	1
25	2.5	178	25	4450	1
26	1.1	206	23	4738	1
27	3.8	155	27	4185	1
28	4.7	157	29	4553	1
29	2.4	224	25	5600	1
30	4.2	159	28	4452	1
Detection Percentage				Limit >60%	100%



Type3

Trial Number	Pulse Width (us)	PRI (us)	Number of Pulses	Waveform Length(us)	1=Detection Blank=No Detection
1	8.2	355	17	6035	0
2	6.1	487	16	7792	1
3	7.1	344	16	5504	1
4	9.8	288	18	5184	1
5	8.9	230	18	4140	1
6	7.9	432	17	7344	1
7	8.2	207	17	3519	1
8	7.5	443	17	7531	1
9	8.1	439	17	7463	1
10	6.2	223	16	3568	1
11	8.9	208	18	3744	1
12	9.6	463	18	8334	1
13	8.2	441	17	7497	1
14	7.2	323	16	5168	1
15	9.5	297	18	5346	1
16	8	412	17	7004	1
17	10	324	18	5832	1
18	7.4	271	17	4607	1
19	7.9	349	17	5933	1
20	7.3	409	16	6544	1
21	8.7	373	18	6714	1
22	7.2	254	16	4064	1
23	9.9	274	18	4932	1
24	7.9	278	17	4726	1
25	7.5	317	17	5389	0
26	6.1	260	16	4160	1
27	8.8	211	18	3798	1
28	9.7	272	18	4896	0
29	7.4	264	17	4488	1
30	9.2	284	18	5112	1
Detection Percentage				Limit >60%	90%





Type4

Trial Number	Pulse Width (us)	PRI (us)	Number of Pulses	Waveform Length(us)	1=Detection Blank=No Detection
1	16	355	14	4970	1
2	11.3	487	12	5844	0
3	13.5	344	13	4472	1
4	19.4	288	16	4608	0
5	17.5	230	15	3450	1
6	15.3	432	14	6048	1
7	15.9	207	14	2898	1
8	14.3	443	13	5759	1
9	15.8	439	14	6146	1
10	11.5	223	12	2676	1
11	17.4	208	15	3120	1
12	19	463	16	7408	1
13	16	441	14	6174	1
14	13.8	323	13	4199	1
15	18.9	297	16	4752	1
16	15.5	412	14	5768	1
17	19.9	324	16	5184	1
18	14.1	271	13	3523	1
19	15.2	349	14	4886	1
20	13.8	409	13	5317	1
21	17.1	373	15	5595	1
22	13.8	254	13	3302	1
23	19.8	274	16	4384	1
24	15.3	278	14	3892	1
25	14.5	317	13	4121	1
26	11.3	260	12	3120	1
27	17.3	211	15	3165	1
28	19.2	272	16	4352	1
29	14.2	264	13	3432	0
30	18.2	284	15	4260	0
Detection Percentage				Limit >60%	87%

In addition an average minimum percentage of successful detection across all four Short pulse radar

test waveforms is as follows:  $\frac{P_d1+P_d2+P_d3+P_d4}{4} = (100\%+100\%+90\%+87\%)/4 = 94\% (>80\%)$



Type5

Trial Number	1=Detection Blank=No Detection
1	1
2	1
3	1
4	0
5	1
6	1
7	1
8	1
9	1
10	1
11	1
12	1
13	1
14	1
15	1
16	1
17	1
18	1
19	1
20	1
21	1
22	1
23	1
24	1
25	1
26	1
27	1
28	0
29	1
30	1
Detection Percentage	93%

See the type 5 Radar Characteristics at the Section 5.9.1. of this report



Type6

Trial Number	Pulse Width (us)	PRI (us)	Number of Pulses	Waveform Length(us)	1=Detection Blank=No Detection
1	1	333.335	9	0.3333	1
2	1	333.335	9	0.3333	1
3	1	333.335	9	0.3333	1
4	1	333.335	9	0.3333	1
5	1	333.335	9	0.3333	1
6	1	333.335	9	0.3333	1
7	1	333.335	9	0.3333	1
8	1	333.335	9	0.3333	1
9	1	333.335	9	0.3333	1
10	1	333.335	9	0.3333	1
11	1	333.335	9	0.3333	1
12	1	333.335	9	0.3333	1
13	1	333.335	9	0.3333	1
14	1	333.335	9	0.3333	1
15	1	333.335	9	0.3333	1
16	1	333.335	9	0.3333	1
17	1	333.335	9	0.3333	1
18	1	333.335	9	0.3333	1
19	1	333.335	9	0.3333	1
20	1	333.335	9	0.3333	1
21	1	333.335	9	0.3333	1
22	1	333.335	9	0.3333	1
23	1	333.335	9	0.3333	1
24	1	333.335	9	0.3333	1
25	1	333.335	9	0.3333	1
26	1	333.335	9	0.3333	1
27	1	333.335	9	0.3333	1
28	1	333.335	9	0.3333	1
29	1	333.335	9	0.3333	1
30	1	333.335	9	0.3333	1
Detection Percentage				Limit >70%	100%



For 802. 11ax HE40, Band 3

Type1

Trial Number	Pulse Width (us)	PRI (us)	Number of Pulses	Waveform Length(us)	1=Detection Blank=No Detection
1	1	938	57	53466	1
2	1	698	76	53048	1
3	1	618	86	53148	1
4	1	538	99	53262	1
5	1	878	61	53558	1
6	1	3066	18	55188	1
7	1	638	83	52954	1
8	1	918	58	53244	1
9	1	838	63	52794	1
10	1	858	62	53196	1
11	1	798	67	53466	1
12	1	718	74	53132	1
13	1	578	92	53176	1
14	1	598	89	53222	1
15	1	558	95	53010	1
16	1	2536	21	53256	1
17	1	966	55	53130	1
18	1	827	64	52928	1
19	1	2501	22	55022	1
20	1	2595	21	54495	1
21	1	1114	48	53472	1
22	1	1302	41	53382	1
23	1	3045	18	54810	1
24	1	1624	33	53592	1
25	1	2878	19	54682	1
26	1	1027	52	53404	1
27	1	2485	22	54670	1
28	1	1600	33	52800	1
29	1	1172	46	53912	1
30	1	1177	45	52965	1
Detection Percentage				Limit >60%	100%



Type2

Trial Number	Pulse Width (us)	PRI (us)	Number of Pulses	Waveform Length(us)	1=Detection Blank=No Detection
1	3.2	179	26	4654	1
2	1.1	207	23	4761	0
3	2.1	230	24	5520	1
4	4.8	200	29	5800	1
5	3.9	214	28	5992	1
6	2.9	222	26	5772	1
7	3.2	204	26	5304	1
8	2.5	192	25	4800	1
9	3.1	164	26	4264	1
10	1.2	156	23	3588	1
11	3.9	210	27	5670	1
12	4.6	201	29	5829	1
13	3.2	162	26	4212	1
14	2.2	197	25	4925	1
15	4.5	163	29	4727	1
16	3	203	26	5278	1
17	5	168	29	4872	1
18	2.4	217	25	5425	1
19	2.9	191	26	4966	1
20	2.3	166	25	4150	1
21	3.7	150	27	4050	1
22	2.2	176	25	4400	1
23	4.9	195	29	5655	1
24	2.9	202	26	5252	0
25	2.5	178	25	4450	1
26	1.1	206	23	4738	1
27	3.8	155	27	4185	0
28	4.7	157	29	4553	1
29	2.4	224	25	5600	1
30	4.2	159	28	4452	1
Detection Percentage				Limit >60%	90%



Type3

Trial Number	Pulse Width (us)	PRI (us)	Number of Pulses	Waveform Length(us)	1=Detection Blank=No Detection
1	8.2	355	17	6035	1
2	6.1	487	16	7792	1
3	7.1	344	16	5504	1
4	9.8	288	18	5184	1
5	8.9	230	18	4140	1
6	7.9	432	17	7344	1
7	8.2	207	17	3519	1
8	7.5	443	17	7531	1
9	8.1	439	17	7463	1
10	6.2	223	16	3568	1
11	8.9	208	18	3744	1
12	9.6	463	18	8334	1
13	8.2	441	17	7497	1
14	7.2	323	16	5168	1
15	9.5	297	18	5346	1
16	8	412	17	7004	1
17	10	324	18	5832	1
18	7.4	271	17	4607	1
19	7.9	349	17	5933	1
20	7.3	409	16	6544	1
21	8.7	373	18	6714	1
22	7.2	254	16	4064	1
23	9.9	274	18	4932	1
24	7.9	278	17	4726	1
25	7.5	317	17	5389	1
26	6.1	260	16	4160	1
27	8.8	211	18	3798	1
28	9.7	272	18	4896	1
29	7.4	264	17	4488	1
30	9.2	284	18	5112	1
Detection Percentage				Limit >60%	100%



Type4

Trial Number	Pulse Width (us)	PRI (us)	Number of Pulses	Waveform Length(us)	1=Detection Blank=No Detection
1	16	355	14	4970	1
2	11.3	487	12	5844	1
3	13.5	344	13	4472	1
4	19.4	288	16	4608	1
5	17.5	230	15	3450	1
6	15.3	432	14	6048	1
7	15.9	207	14	2898	1
8	14.3	443	13	5759	1
9	15.8	439	14	6146	1
10	11.5	223	12	2676	1
11	17.4	208	15	3120	1
12	19	463	16	7408	1
13	16	441	14	6174	1
14	13.8	323	13	4199	1
15	18.9	297	16	4752	1
16	15.5	412	14	5768	1
17	19.9	324	16	5184	1
18	14.1	271	13	3523	1
19	15.2	349	14	4886	1
20	13.8	409	13	5317	1
21	17.1	373	15	5595	1
22	13.8	254	13	3302	1
23	19.8	274	16	4384	1
24	15.3	278	14	3892	1
25	14.5	317	13	4121	1
26	11.3	260	12	3120	1
27	17.3	211	15	3165	1
28	19.2	272	16	4352	0
29	14.2	264	13	3432	1
30	18.2	284	15	4260	0
Detection Percentage				Limit >60%	93%

In addition an average minimum percentage of successful detection across all four Short pulse radar

test waveforms is as follows:  $\frac{P_d1+P_d2+P_d3+P_d4}{4} = (100\%+90\%+100\%+93\%)/4 = 96\% (>80\%)$



Type5

Trial Number	1=Detection Blank=No Detection
1	0
2	1
3	1
4	1
5	1
6	1
7	1
8	1
9	1
10	1
11	1
12	1
13	1
14	1
15	1
16	1
17	1
18	1
19	1
20	1
21	1
22	1
23	1
24	1
25	1
26	1
27	1
28	0
29	1
30	1
Detection Percentage	93%

See the type 5 Radar Characteristics at the Section 5.9.1. of this report





Type6

Trial Number	Pulse Width (us)	PRI (us)	Number of Pulses	Waveform Length(us)	1=Detection Blank=No Detection
1	1	333.335	9	0.3333	1
2	1	333.335	9	0.3333	1
3	1	333.335	9	0.3333	1
4	1	333.335	9	0.3333	1
5	1	333.335	9	0.3333	1
6	1	333.335	9	0.3333	1
7	1	333.335	9	0.3333	1
8	1	333.335	9	0.3333	1
9	1	333.335	9	0.3333	1
10	1	333.335	9	0.3333	1
11	1	333.335	9	0.3333	1
12	1	333.335	9	0.3333	1
13	1	333.335	9	0.3333	1
14	1	333.335	9	0.3333	1
15	1	333.335	9	0.3333	1
16	1	333.335	9	0.3333	1
17	1	333.335	9	0.3333	1
18	1	333.335	9	0.3333	1
19	1	333.335	9	0.3333	1
20	1	333.335	9	0.3333	1
21	1	333.335	9	0.3333	1
22	1	333.335	9	0.3333	1
23	1	333.335	9	0.3333	1
24	1	333.335	9	0.3333	1
25	1	333.335	9	0.3333	1
26	1	333.335	9	0.3333	1
27	1	333.335	9	0.3333	1
28	1	333.335	9	0.3333	1
29	1	333.335	9	0.3333	1
30	1	333.335	9	0.3333	1
Detection Percentage				Limit >70%	100%



For 802. 11ax HE80, Band 3

Type1

Trial Number	Pulse Width (us)	PRI (us)	Number of Pulses	Waveform Length(us)	1=Detection Blank=No Detection
1	1	938	57	53466	1
2	1	698	76	53048	1
3	1	618	86	53148	1
4	1	538	99	53262	1
5	1	878	61	53558	1
6	1	3066	18	55188	1
7	1	638	83	52954	1
8	1	918	58	53244	1
9	1	838	63	52794	1
10	1	858	62	53196	1
11	1	798	67	53466	1
12	1	718	74	53132	1
13	1	578	92	53176	1
14	1	598	89	53222	1
15	1	558	95	53010	1
16	1	2536	21	53256	1
17	1	966	55	53130	1
18	1	827	64	52928	1
19	1	2501	22	55022	1
20	1	2595	21	54495	1
21	1	1114	48	53472	1
22	1	1302	41	53382	1
23	1	3045	18	54810	1
24	1	1624	33	53592	1
25	1	2878	19	54682	1
26	1	1027	52	53404	1
27	1	2485	22	54670	1
28	1	1600	33	52800	1
29	1	1172	46	53912	1
30	1	1177	45	52965	1
Detection Percentage				Limit >60%	100%



Type2

Trial Number	Pulse Width (us)	PRI (us)	Number of Pulses	Waveform Length(us)	1=Detection Blank=No Detection
1	3.2	179	26	4654	1
2	1.1	207	23	4761	1
3	2.1	230	24	5520	1
4	4.8	200	29	5800	1
5	3.9	214	28	5992	1
6	2.9	222	26	5772	1
7	3.2	204	26	5304	1
8	2.5	192	25	4800	1
9	3.1	164	26	4264	1
10	1.2	156	23	3588	1
11	3.9	210	27	5670	1
12	4.6	201	29	5829	1
13	3.2	162	26	4212	1
14	2.2	197	25	4925	1
15	4.5	163	29	4727	1
16	3	203	26	5278	1
17	5	168	29	4872	1
18	2.4	217	25	5425	1
19	2.9	191	26	4966	1
20	2.3	166	25	4150	1
21	3.7	150	27	4050	1
22	2.2	176	25	4400	1
23	4.9	195	29	5655	1
24	2.9	202	26	5252	1
25	2.5	178	25	4450	1
26	1.1	206	23	4738	1
27	3.8	155	27	4185	1
28	4.7	157	29	4553	1
29	2.4	224	25	5600	1
30	4.2	159	28	4452	1
Detection Percentage				Limit >60%	100%



Type3

Trial Number	Pulse Width (us)	PRI (us)	Number of Pulses	Waveform Length(us)	1=Detection Blank=No Detection
1	8.2	355	17	6035	0
2	6.1	487	16	7792	1
3	7.1	344	16	5504	1
4	9.8	288	18	5184	1
5	8.9	230	18	4140	1
6	7.9	432	17	7344	1
7	8.2	207	17	3519	1
8	7.5	443	17	7531	1
9	8.1	439	17	7463	1
10	6.2	223	16	3568	1
11	8.9	208	18	3744	1
12	9.6	463	18	8334	1
13	8.2	441	17	7497	1
14	7.2	323	16	5168	1
15	9.5	297	18	5346	1
16	8	412	17	7004	1
17	10	324	18	5832	1
18	7.4	271	17	4607	1
19	7.9	349	17	5933	1
20	7.3	409	16	6544	1
21	8.7	373	18	6714	1
22	7.2	254	16	4064	1
23	9.9	274	18	4932	1
24	7.9	278	17	4726	1
25	7.5	317	17	5389	1
26	6.1	260	16	4160	1
27	8.8	211	18	3798	1
28	9.7	272	18	4896	1
29	7.4	264	17	4488	0
30	9.2	284	18	5112	0
Detection Percentage				Limit >60%	90%



Type4

Trial Number	Pulse Width (us)	PRI (us)	Number of Pulses	Waveform Length(us)	1=Detection Blank=No Detection
1	16	355	14	4970	0
2	11.3	487	12	5844	1
3	13.5	344	13	4472	1
4	19.4	288	16	4608	1
5	17.5	230	15	3450	1
6	15.3	432	14	6048	1
7	15.9	207	14	2898	1
8	14.3	443	13	5759	1
9	15.8	439	14	6146	1
10	11.5	223	12	2676	1
11	17.4	208	15	3120	1
12	19	463	16	7408	1
13	16	441	14	6174	1
14	13.8	323	13	4199	1
15	18.9	297	16	4752	1
16	15.5	412	14	5768	1
17	19.9	324	16	5184	1
18	14.1	271	13	3523	1
19	15.2	349	14	4886	1
20	13.8	409	13	5317	1
21	17.1	373	15	5595	1
22	13.8	254	13	3302	1
23	19.8	274	16	4384	1
24	15.3	278	14	3892	1
25	14.5	317	13	4121	1
26	11.3	260	12	3120	0
27	17.3	211	15	3165	1
28	19.2	272	16	4352	0
29	14.2	264	13	3432	0
30	18.2	284	15	4260	0
Detection Percentage				Limit >60%	83%

In addition an average minimum percentage of successful detection across all four Short pulse radar

test waveforms is as follows:  $\frac{P_d1+P_d2+P_d3+P_d4}{4} = (100\%+100\%+90\%+83\%)/4 = 93\% (>80\%)$



Type5

Trial Number	1=Detection Blank=No Detection
1	1
2	1
3	1
4	1
5	1
6	1
7	1
8	1
9	1
10	1
11	1
12	1
13	1
14	1
15	1
16	1
17	1
18	1
19	1
20	1
21	1
22	1
23	1
24	1
25	1
26	1
27	1
28	1
29	1
30	1
Detection Percentage	100%

See the type 5 Radar Characteristics at the Section 5.9.1. of this report



Type6

Trial Number	Pulse Width (us)	PRI (us)	Number of Pulses	Waveform Length(us)	1=Detection Blank=No Detection
1	1	333.335	9	0.3333	1
2	1	333.335	9	0.3333	1
3	1	333.335	9	0.3333	1
4	1	333.335	9	0.3333	1
5	1	333.335	9	0.3333	1
6	1	333.335	9	0.3333	1
7	1	333.335	9	0.3333	1
8	1	333.335	9	0.3333	1
9	1	333.335	9	0.3333	1
10	1	333.335	9	0.3333	1
11	1	333.335	9	0.3333	1
12	1	333.335	9	0.3333	1
13	1	333.335	9	0.3333	1
14	1	333.335	9	0.3333	1
15	1	333.335	9	0.3333	1
16	1	333.335	9	0.3333	1
17	1	333.335	9	0.3333	1
18	1	333.335	9	0.3333	1
19	1	333.335	9	0.3333	1
20	1	333.335	9	0.3333	1
21	1	333.335	9	0.3333	1
22	1	333.335	9	0.3333	1
23	1	333.335	9	0.3333	1
24	1	333.335	9	0.3333	1
25	1	333.335	9	0.3333	1
26	1	333.335	9	0.3333	1
27	1	333.335	9	0.3333	1
28	1	333.335	9	0.3333	1
29	1	333.335	9	0.3333	1
30	1	333.335	9	0.3333	1
Detection Percentage				Limit >70%	100%



For 802. 11ax HE160, Band 3

Type1

Trial Number	Pulse Width (us)	PRI (us)	Number of Pulses	Waveform Length(us)	1=Detection Blank=No Detection
1	1	938	57	53466	1
2	1	698	76	53048	1
3	1	618	86	53148	1
4	1	538	99	53262	1
5	1	878	61	53558	0
6	1	3066	18	55188	1
7	1	638	83	52954	1
8	1	918	58	53244	1
9	1	838	63	52794	1
10	1	858	62	53196	1
11	1	798	67	53466	1
12	1	718	74	53132	1
13	1	578	92	53176	1
14	1	598	89	53222	1
15	1	558	95	53010	1
16	1	2536	21	53256	1
17	1	966	55	53130	1
18	1	827	64	52928	1
19	1	2501	22	55022	1
20	1	2595	21	54495	1
21	1	1114	48	53472	1
22	1	1302	41	53382	1
23	1	3045	18	54810	1
24	1	1624	33	53592	1
25	1	2878	19	54682	1
26	1	1027	52	53404	1
27	1	2485	22	54670	1
28	1	1600	33	52800	0
29	1	1172	46	53912	1
30	1	1177	45	52965	1
Detection Percentage				Limit >60%	93%





Type2

Trial Number	Pulse Width (us)	PRI (us)	Number of Pulses	Waveform Length(us)	1=Detection Blank=No Detection
1	3.2	179	26	4654	1
2	1.1	207	23	4761	1
3	2.1	230	24	5520	1
4	4.8	200	29	5800	1
5	3.9	214	28	5992	1
6	2.9	222	26	5772	1
7	3.2	204	26	5304	1
8	2.5	192	25	4800	1
9	3.1	164	26	4264	1
10	1.2	156	23	3588	0
11	3.9	210	27	5670	1
12	4.6	201	29	5829	1
13	3.2	162	26	4212	1
14	2.2	197	25	4925	1
15	4.5	163	29	4727	1
16	3	203	26	5278	1
17	5	168	29	4872	1
18	2.4	217	25	5425	1
19	2.9	191	26	4966	1
20	2.3	166	25	4150	1
21	3.7	150	27	4050	1
22	2.2	176	25	4400	1
23	4.9	195	29	5655	1
24	2.9	202	26	5252	1
25	2.5	178	25	4450	1
26	1.1	206	23	4738	1
27	3.8	155	27	4185	1
28	4.7	157	29	4553	1
29	2.4	224	25	5600	0
30	4.2	159	28	4452	0
Detection Percentage				Limit >60%	90%



Type3

Trial Number	Pulse Width (us)	PRI (us)	Number of Pulses	Waveform Length(us)	1=Detection Blank=No Detection
1	8.2	355	17	6035	0
2	6.1	487	16	7792	1
3	7.1	344	16	5504	1
4	9.8	288	18	5184	1
5	8.9	230	18	4140	1
6	7.9	432	17	7344	1
7	8.2	207	17	3519	1
8	7.5	443	17	7531	1
9	8.1	439	17	7463	1
10	6.2	223	16	3568	1
11	8.9	208	18	3744	1
12	9.6	463	18	8334	1
13	8.2	441	17	7497	1
14	7.2	323	16	5168	1
15	9.5	297	18	5346	1
16	8	412	17	7004	1
17	10	324	18	5832	1
18	7.4	271	17	4607	1
19	7.9	349	17	5933	1
20	7.3	409	16	6544	1
21	8.7	373	18	6714	1
22	7.2	254	16	4064	1
23	9.9	274	18	4932	1
24	7.9	278	17	4726	1
25	7.5	317	17	5389	1
26	6.1	260	16	4160	1
27	8.8	211	18	3798	1
28	9.7	272	18	4896	0
29	7.4	264	17	4488	1
30	9.2	284	18	5112	0
Detection Percentage				Limit >60%	90%



Type4

Trial Number	Pulse Width (us)	PRI (us)	Number of Pulses	Waveform Length(us)	1=Detection Blank=No Detection
1	16	355	14	4970	0
2	11.3	487	12	5844	1
3	13.5	344	13	4472	1
4	19.4	288	16	4608	1
5	17.5	230	15	3450	1
6	15.3	432	14	6048	1
7	15.9	207	14	2898	1
8	14.3	443	13	5759	1
9	15.8	439	14	6146	1
10	11.5	223	12	2676	1
11	17.4	208	15	3120	1
12	19	463	16	7408	1
13	16	441	14	6174	1
14	13.8	323	13	4199	1
15	18.9	297	16	4752	1
16	15.5	412	14	5768	1
17	19.9	324	16	5184	0
18	14.1	271	13	3523	1
19	15.2	349	14	4886	1
20	13.8	409	13	5317	1
21	17.1	373	15	5595	1
22	13.8	254	13	3302	1
23	19.8	274	16	4384	1
24	15.3	278	14	3892	1
25	14.5	317	13	4121	1
26	11.3	260	12	3120	1
27	17.3	211	15	3165	0
28	19.2	272	16	4352	0
29	14.2	264	13	3432	0
30	18.2	284	15	4260	0
Detection Percentage				Limit >60%	80%

In addition an average minimum percentage of successful detection across all four Short pulse radar

test waveforms is as follows:  $\frac{P_d1+P_d2+P_d3+P_d4}{4} = (93\%+90\%+90\%+80\%)/4 = 88\% (>80\%)$



Type5

Trial Number	1=Detection Blank=No Detection
1	1
2	1
3	1
4	1
5	1
6	1
7	1
8	1
9	1
10	0
11	1
12	0
13	0
14	1
15	0
16	1
17	0
18	1
19	1
20	1
21	1
22	1
23	1
24	1
25	1
26	1
27	1
28	1
29	1
30	1
Detection Percentage	83%

See the type 5 Radar Characteristics at the Section 5.9.1. of this report



Type6

Trial Number	Pulse Width (us)	PRI (us)	Number of Pulses	Waveform Length(us)	1=Detection Blank=No Detection
1	1	333.335	9	0.3333	1
2	1	333.335	9	0.3333	1
3	1	333.335	9	0.3333	1
4	1	333.335	9	0.3333	1
5	1	333.335	9	0.3333	1
6	1	333.335	9	0.3333	1
7	1	333.335	9	0.3333	1
8	1	333.335	9	0.3333	1
9	1	333.335	9	0.3333	1
10	1	333.335	9	0.3333	1
11	1	333.335	9	0.3333	1
12	1	333.335	9	0.3333	1
13	1	333.335	9	0.3333	1
14	1	333.335	9	0.3333	1
15	1	333.335	9	0.3333	1
16	1	333.335	9	0.3333	1
17	1	333.335	9	0.3333	1
18	1	333.335	9	0.3333	1
19	1	333.335	9	0.3333	1
20	1	333.335	9	0.3333	1
21	1	333.335	9	0.3333	1
22	1	333.335	9	0.3333	1
23	1	333.335	9	0.3333	1
24	1	333.335	9	0.3333	1
25	1	333.335	9	0.3333	1
26	1	333.335	9	0.3333	1
27	1	333.335	9	0.3333	1
28	1	333.335	9	0.3333	1
29	1	333.335	9	0.3333	1
30	1	333.335	9	0.3333	1
Detection Percentage				Limit >70%	100%



For TDWR Band 802. 11ax HE20  
Type 1 Radar Statistical Performance

Trial Number	Pulse Width (us)	PRI (us)	Number of Pulses	Waveform Length(us)	1=Detection Blank=No Detection
1	1	938	57	53466	1
2	1	698	76	53048	1
3	1	618	86	53148	1
4	1	538	99	53262	1
5	1	878	61	53558	1
6	1	3066	18	55188	1
7	1	638	83	52954	1
8	1	918	58	53244	1
9	1	838	63	52794	1
10	1	858	62	53196	1
11	1	798	67	53466	1
12	1	718	74	53132	1
13	1	578	92	53176	1
14	1	598	89	53222	1
15	1	558	95	53010	1
16	1	2536	21	53256	1
17	1	966	55	53130	1
18	1	827	64	52928	1
19	1	2501	22	55022	1
20	1	2595	21	54495	1
21	1	1114	48	53472	1
22	1	1302	41	53382	1
23	1	3045	18	54810	1
24	1	1624	33	53592	1
25	1	2878	19	54682	1
26	1	1027	52	53404	1
27	1	2485	22	54670	1
28	1	1600	33	52800	1
29	1	1172	46	53912	1
30	1	1177	45	52965	1
Detection Percentage				Limit >60%	100%



For TDWR Band 802. 11ax HE40  
Type 1 Radar Statistical Performance

Trial Number	Pulse Width (us)	PRI (us)	Number of Pulses	Waveform Length(us)	1=Detection Blank=No Detection
1	1	938	57	53466	1
2	1	698	76	53048	1
3	1	618	86	53148	1
4	1	538	99	53262	1
5	1	878	61	53558	1
6	1	3066	18	55188	1
7	1	638	83	52954	1
8	1	918	58	53244	1
9	1	838	63	52794	1
10	1	858	62	53196	1
11	1	798	67	53466	1
12	1	718	74	53132	1
13	1	578	92	53176	1
14	1	598	89	53222	1
15	1	558	95	53010	1
16	1	2536	21	53256	1
17	1	966	55	53130	1
18	1	827	64	52928	1
19	1	2501	22	55022	1
20	1	2595	21	54495	1
21	1	1114	48	53472	1
22	1	1302	41	53382	1
23	1	3045	18	54810	1
24	1	1624	33	53592	1
25	1	2878	19	54682	1
26	1	1027	52	53404	1
27	1	2485	22	54670	1
28	1	1600	33	52800	1
29	1	1172	46	53912	1
30	1	1177	45	52965	1
Detection Percentage				Limit >60%	100%



For TDWR Band 802. 11ax HE80  
Type 1 Radar Statistical Performance

Trial Number	Pulse Width (us)	PRI (us)	Number of Pulses	Waveform Length(us)	1=Detection Blank=No Detection
1	1	938	57	53466	1
2	1	698	76	53048	1
3	1	618	86	53148	1
4	1	538	99	53262	1
5	1	878	61	53558	1
6	1	3066	18	55188	1
7	1	638	83	52954	1
8	1	918	58	53244	1
9	1	838	63	52794	1
10	1	858	62	53196	1
11	1	798	67	53466	1
12	1	718	74	53132	1
13	1	578	92	53176	1
14	1	598	89	53222	1
15	1	558	95	53010	1
16	1	2536	21	53256	1
17	1	966	55	53130	1
18	1	827	64	52928	1
19	1	2501	22	55022	1
20	1	2595	21	54495	1
21	1	1114	48	53472	1
22	1	1302	41	53382	1
23	1	3045	18	54810	1
24	1	1624	33	53592	1
25	1	2878	19	54682	1
26	1	1027	52	53404	1
27	1	2485	22	54670	1
28	1	1600	33	52800	1
29	1	1172	46	53912	1
30	1	1177	45	52965	1
Detection Percentage				Limit >60%	100%





For TDWR Band 802. 11ax HE160  
Type 1 Radar Statistical Performance

Trial Number	Pulse Width (us)	PRI (us)	Number of Pulses	Waveform Length(us)	1=Detection Blank=No Detection
1	1	938	57	53466	1
2	1	698	76	53048	1
3	1	618	86	53148	1
4	1	538	99	53262	1
5	1	878	61	53558	1
6	1	3066	18	55188	1
7	1	638	83	52954	1
8	1	918	58	53244	1
9	1	838	63	52794	1
10	1	858	62	53196	1
11	1	798	67	53466	1
12	1	718	74	53132	1
13	1	578	92	53176	1
14	1	598	89	53222	1
15	1	558	95	53010	1
16	1	2536	21	53256	1
17	1	966	55	53130	1
18	1	827	64	52928	1
19	1	2501	22	55022	1
20	1	2595	21	54495	1
21	1	1114	48	53472	1
22	1	1302	41	53382	1
23	1	3045	18	54810	1
24	1	1624	33	53592	1
25	1	2878	19	54682	1
26	1	1027	52	53404	1
27	1	2485	22	54670	1
28	1	1600	33	52800	1
29	1	1172	46	53912	1
30	1	1177	45	52965	1
Detection Percentage				Limit >60%	100%



5.9.1. Test Result (Type 5 Radar Statistical Performance)

Trial Number 1							
Burst ID	Burst Offset (us)	Pulse Width (us)	Chirp Width (MHz)	Number of Pulses per Burst	PRI-1 (us)	PRI-2 (us)	PRI-3 (us)
1	395530.0	68.4	13	2	1587.0	1114.0	-
2	588564.0	76.7	13	2	2000.0	1155.0	-
3	783794.0	53.2	13	1	1147.0	-	-
4	177933.0	85.7	13	3	1433.0	1695.0	1394.0
5	370624.0	94.3	13	3	1670.0	1426.0	1935.0
6	564893.0	77.6	13	2	1294.0	1671.0	-
7	759583.0	65.7	13	1	1512.0	-	-
8	154262.0	93.5	13	3	1444.0	1130.0	1468.0
9	395530.0	68.4	13	2	1587.0	1114.0	-
10	588564.0	76.7	13	2	2000.0	1155.0	-
11	783794.0	53.2	13	1	1147.0	-	-
12	177933.0	85.7	13	3	1433.0	1695.0	1394.0
13	370624.0	94.3	13	3	1670.0	1426.0	1935.0
14	564893.0	77.6	13	2	1294.0	1671.0	-
15	759583.0	65.7	13	1	1512.0	-	-



Trial Number 2							
Burst ID	Burst Offset (us)	Pulse Width (us)	Chirp Width (MHz)	Number of Pulses per Burst	PRI-1 (us)	PRI-2 (us)	PRI-3 (us)
1	653020.0	75.0	5	2	1880.0	1527.0	-
2	1015643.0	99.4	5	3	1401.0	1262.0	1257.0
3	1379398.0	67.4	5	2	1531.0	1403.0	-
4	245489.0	73.6	5	2	1449.0	1041.0	-
5	609113.0	65.9	5	1	1432.0	-	-
6	970852.0	83.8	5	3	1356.0	1292.0	1419.0
7	1335913.0	65.5	5	1	1543.0	-	-
8	200406.0	98.6	5	3	1548.0	1796.0	1728.0

Trial Number 3							
Burst ID	Burst Offset (us)	Pulse Width (us)	Chirp Width (MHz)	Number of Pulses per Burst	PRI-1 (us)	PRI-2 (us)	PRI-3 (us)
1	409565.0	73.8	9	2	1806.0	1538.0	-
2	673692.0	69.5	9	2	1117.0	1649.0	-
3	938562.0	51.9	9	1	1651.0	-	-
4	113209.0	84.6	9	3	1976.0	1032.0	1271.0
5	376726.0	95.4	9	3	1060.0	1903.0	1388.0
6	641212.0	68.0	9	2	1368.0	1351.0	-
7	903714.0	89.6	9	3	1338.0	1514.0	1573.0
8	80863.0	81.9	9	2	1022.0	1689.0	-
9	344067.0	88.3	9	3	1810.0	1330.0	1838.0
10	609331.0	53.7	9	1	1597.0	-	-
11	871542.0	91.3	9	3	1961.0	1106.0	1001.0



Trial Number 4							
Burst ID	Burst Offset (us)	Pulse Width (us)	Chirp Width (MHz)	Number of Pulses per Burst	PRI-1 (us)	PRI-2 (us)	PRI-3 (us)
1	26541.0	68.1	19	2	1339.0	1355.0	-
2	171821.0	58.7	19	1	1251.0	-	-
3	316229.0	75.3	19	2	1136.0	1640.0	-
4	461864.0	56.4	19	1	1753.0	-	-
5	8677.0	99.7	19	3	1196.0	1708.0	1159.0
6	153995.0	57.7	19	1	1013.0	-	-
7	299238.0	59.5	19	1	1072.0	-	-
8	443177.0	80.0	19	2	1482.0	1369.0	-
9	587671.0	82.0	19	2	1993.0	1197.0	-
10	135674.0	82.8	19	2	1883.0	1005.0	-
11	279928.0	88.0	19	3	1061.0	1928.0	1101.0
12	424279.0	93.2	19	3	1207.0	1907.0	1223.0
13	570132.0	70.4	19	2	1526.0	1360.0	-
14	117439.0	95.3	19	3	1171.0	1955.0	1775.0
15	262502.0	81.9	19	2	1690.0	1545.0	-
16	406573.0	98.5	19	3	1975.0	1169.0	1062.0
17	553328.0	65.0	19	1	1767.0	-	-
18	99799.0	85.4	19	3	1011.0	1637.0	1425.0
19	244095.0	91.6	19	3	1878.0	1445.0	1325.0
20	390012.0	67.3	19	2	1091.0	1218.0	-



Trial Number 5							
Burst ID	Burst Offset (us)	Pulse Width (us)	Chirp Width (MHz)	Number of Pulses per Burst	PRI-1 (us)	PRI-2 (us)	PRI-3 (us)
1	629614.0	67.9	16	2	1320.0	1133.0	-
2	96856.0	62.3	16	1	1957.0	-	-
3	267719.0	53.3	16	1	1592.0	-	-
4	436784.0	90.0	16	3	1900.0	1153.0	1346.0
5	608289.0	77.1	16	2	1166.0	1646.0	-
6	75610.0	83.9	16	3	1278.0	1232.0	1459.0
7	245638.0	89.1	16	3	1240.0	1384.0	1939.0
8	416355.0	81.8	16	2	1833.0	1676.0	-
9	588736.0	50.3	16	1	1075.0	-	-
10	54571.0	87.1	16	3	1116.0	1996.0	1756.0
11	225175.0	71.3	16	2	1225.0	1815.0	-
12	394825.0	97.5	16	3	1884.0	1465.0	1132.0
13	565361.0	90.6	16	3	1561.0	1040.0	1354.0
14	33643.0	86.3	16	3	1596.0	1183.0	1792.0
15	203957.0	97.6	16	3	1365.0	1073.0	1361.0
16	373812.0	84.7	16	3	1021.0	1718.0	1854.0
17	544060.0	99.7	16	3	1150.0	1244.0	1988.0



Trial Number 6							
Burst ID	Burst Offset (us)	Pulse Width (us)	Chirp Width (MHz)	Number of Pulses per Burst	PRI-1 (us)	PRI-2 (us)	PRI-3 (us)
1	15438.0	92.9	12	3	1085.0	1564.0	1407.0
2	222486.0	67.7	12	2	1744.0	1747.0	-
3	430731.0	65.8	12	1	1092.0	-	-
4	637784.0	56.3	12	1	1851.0	-	-
5	845342.0	53.7	12	1	1727.0	-	-
6	196720.0	83.5	12	3	1679.0	1930.0	1025.0
7	404955.0	65.8	12	1	1519.0	-	-
8	610711.0	85.9	12	3	1134.0	1034.0	1808.0
9	818057.0	76.3	12	2	1606.0	1926.0	-
10	171459.0	81.5	12	2	1891.0	1714.0	-
11	377969.0	89.4	12	3	1310.0	1594.0	1827.0
12	586875.0	63.4	12	1	1568.0	-	-
13	792834.0	69.6	12	2	1307.0	1925.0	-
14	146044.0	74.5	12	2	1264.0	1846.0	-



Trial Number 7							
Burst ID	Burst Offset (us)	Pulse Width (us)	Chirp Width (MHz)	Number of Pulses per Burst	PRI-1 (us)	PRI-2 (us)	PRI-3 (us)
1	329022.0	96.6	13	3	1182.0	1609.0	1581.0
2	521718.0	96.7	13	3	1829.0	1799.0	1154.0
3	714222.0	86.5	13	3	1923.0	1396.0	1865.0
4	112450.0	73.3	13	2	1908.0	1318.0	-
5	306283.0	55.8	13	1	1688.0	-	-
6	500239.0	55.4	13	1	1145.0	-	-
7	690932.0	85.3	13	3	1336.0	1504.0	1820.0
8	88645.0	79.4	13	2	1344.0	1893.0	-
9	282508.0	65.7	13	1	1476.0	-	-
10	475842.0	68.6	13	2	1008.0	1028.0	-
11	667887.0	77.7	13	2	1972.0	1835.0	-
12	64845.0	79.6	13	2	1882.0	1331.0	-
13	257755.0	94.9	13	3	1830.0	1070.0	1349.0
14	452335.0	61.4	13	1	1451.0	-	-
15	643395.0	90.6	13	3	1233.0	1562.0	1887.0



Trial Number 8							
Burst ID	Burst Offset (us)	Pulse Width (us)	Chirp Width (MHz)	Number of Pulses per Burst	PRI-1 (us)	PRI-2 (us)	PRI-3 (us)
1	51446.0	52.6	10	1	1210.0	-	-
2	292696.0	84.1	10	3	1314.0	1725.0	1529.0
3	533989.0	97.7	10	3	1139.0	1868.0	1805.0
4	775564.0	97.3	10	3	1341.0	1446.0	1755.0
5	21542.0	98.8	10	3	1544.0	1386.0	1302.0
6	263385.0	72.2	10	2	1771.0	1184.0	-
7	505581.0	67.6	10	2	1175.0	1027.0	-
8	747058.0	75.7	10	2	1026.0	1871.0	-
9	989976.0	60.9	10	1	1798.0	-	-
10	234024.0	64.2	10	1	1138.0	-	-
11	475207.0	78.8	10	2	1784.0	1604.0	-
12	715825.0	87.5	10	3	1511.0	1712.0	1683.0





Trial Number 9							
Burst ID	Burst Offset (us)	Pulse Width (us)	Chirp Width (MHz)	Number of Pulses per Burst	PRI-1 (us)	PRI-2 (us)	PRI-3 (us)
1	823112.0	54.1	13	1	1415.0	-	-
2	174965.0	50.7	13	1	1221.0	-	-
3	382216.0	52.3	13	1	1974.0	-	-
4	587395.0	99.8	13	3	1558.0	1696.0	1949.0
5	796897.0	68.4	13	2	1014.0	1099.0	-
6	149042.0	80.8	13	2	1736.0	1505.0	-
7	356750.0	62.5	13	1	1778.0	-	-
8	563824.0	74.8	13	2	1149.0	1204.0	-
9	772314.0	50.8	13	1	1049.0	-	-
10	123796.0	54.0	13	1	1417.0	-	-
11	331215.0	63.0	13	1	1730.0	-	-
12	537402.0	91.8	13	3	1143.0	1270.0	1347.0
13	744805.0	79.3	13	2	1274.0	1992.0	-
14	98172.0	64.3	13	1	1937.0	-	-

Trial Number 10							
Burst ID	Burst Offset (us)	Pulse Width (us)	Chirp Width (MHz)	Number of Pulses per Burst	PRI-1 (us)	PRI-2 (us)	PRI-3 (us)
1	535615.0	63.4	6	1	1043.0	-	-
2	898668.0	52.0	6	1	1863.0	-	-
3	1259235.0	97.2	6	3	1973.0	1605.0	1583.0
4	127106.0	78.7	6	2	1466.0	1743.0	-
5	490358.0	74.2	6	2	1280.0	1219.0	-
6	852409.0	88.7	6	3	1293.0	1934.0	1273.0
7	1217152.0	54.3	6	1	1991.0	-	-
8	82296.0	95.4	6	3	1580.0	1555.0	1791.0



Trial Number 11							
Burst ID	Burst Offset (us)	Pulse Width (us)	Chirp Width (MHz)	Number of Pulses per Burst	PRI-1 (us)	PRI-2 (us)	PRI-3 (us)
1	209249.0	73.7	16	2	1208.0	1497.0	-
2	378386.0	97.4	16	3	1942.0	1754.0	1613.0
3	548411.0	91.7	16	3	1999.0	1702.0	1462.0
4	17733.0	66.2	16	1	1393.0	-	-
5	187952.0	70.8	16	2	1968.0	1821.0	-
6	359277.0	52.3	16	1	1740.0	-	-
7	528886.0	78.9	16	2	1308.0	1984.0	-
8	700166.0	70.9	16	2	1050.0	1358.0	-
9	167197.0	75.6	16	2	1437.0	1430.0	-
10	338262.0	59.1	16	1	1697.0	-	-
11	508324.0	77.0	16	2	1397.0	1304.0	-
12	678689.0	67.9	16	2	1803.0	1083.0	-
13	146031.0	81.2	16	2	1720.0	1932.0	-
14	316923.0	78.7	16	2	1247.0	1121.0	-
15	488056.0	63.3	16	1	1634.0	-	-
16	657326.0	68.9	16	2	1849.0	1423.0	-
17	125509.0	59.3	16	1	1093.0	-	-



Trial Number 12							
Burst ID	Burst Offset (us)	Pulse Width (us)	Chirp Width (MHz)	Number of Pulses per Burst	PRI-1 (us)	PRI-2 (us)	PRI-3 (us)
1	263736.0	98.9	19	3	1381.0	1680.0	1488.0
2	416459.0	82.3	19	2	1716.0	1855.0	-
3	567902.0	86.7	19	3	1211.0	1400.0	1919.0
4	92979.0	89.7	19	3	1861.0	1068.0	1282.0
5	245155.0	98.6	19	3	1507.0	1194.0	1461.0
6	397609.0	71.1	19	2	1921.0	1789.0	-
7	551431.0	55.9	19	1	1947.0	-	-
8	74413.0	67.9	19	2	1350.0	1372.0	-
9	226559.0	84.4	19	3	1203.0	1107.0	1443.0
10	380056.0	58.8	19	1	1715.0	-	-
11	533408.0	65.6	19	1	1017.0	-	-
12	55547.0	78.5	19	2	1911.0	1704.0	-
13	207876.0	82.3	19	2	1845.0	1686.0	-
14	359771.0	90.1	19	3	1938.0	1071.0	1266.0
15	511297.0	90.2	19	3	1989.0	1089.0	1950.0
16	36803.0	83.1	19	2	1943.0	1406.0	-
17	189652.0	58.8	19	1	1742.0	-	-
18	341809.0	77.0	19	2	1187.0	1657.0	-
19	495737.0	55.0	19	1	1012.0	-	-



Trial Number 13							
Burst ID	Burst Offset (us)	Pulse Width (us)	Chirp Width (MHz)	Number of Pulses per Burst	PRI-1 (us)	PRI-2 (us)	PRI-3 (us)
1	22911.0	58.1	13	1	1929.0	-	-
2	216473.0	52.1	13	1	1910.0	-	-
3	410004.0	59.9	13	1	1971.0	-	-
4	603671.0	60.2	13	1	1812.0	-	-
5	794160.0	95.9	13	3	1399.0	1906.0	1608.0
6	192251.0	79.9	13	2	1626.0	1859.0	-
7	385590.0	78.5	13	2	1238.0	1917.0	-
8	579862.0	53.8	13	1	1763.0	-	-
9	773423.0	64.7	13	1	1800.0	-	-
10	168898.0	61.4	13	1	1390.0	-	-
11	361606.0	83.2	13	2	1692.0	1858.0	-
12	553866.0	84.7	13	3	1533.0	1677.0	1638.0
13	747241.0	88.7	13	3	1703.0	1528.0	1058.0
14	144710.0	78.3	13	2	1258.0	1951.0	-
15	337856.0	69.3	13	2	1731.0	1717.0	-

Trial Number 14							
Burst ID	Burst Offset (us)	Pulse Width (us)	Chirp Width (MHz)	Number of Pulses per Burst	PRI-1 (us)	PRI-2 (us)	PRI-3 (us)
1	22911.0	58.1	13	1	1929.0	-	-
2	216473.0	52.1	13	1	1910.0	-	-
3	410004.0	59.9	13	1	1971.0	-	-
4	603671.0	60.2	13	1	1812.0	-	-
5	794160.0	95.9	13	3	1399.0	1906.0	1608.0
6	192251.0	79.9	13	2	1626.0	1859.0	-
7	385590.0	78.5	13	2	1238.0	1917.0	-
8	579862.0	53.8	13	1	1763.0	-	-
9	773423.0	64.7	13	1	1800.0	-	-
10	168898.0	61.4	13	1	1390.0	-	-
11	361606.0	83.2	13	2	1692.0	1858.0	-
12	553866.0	84.7	13	3	1533.0	1677.0	1638.0



Trial Number 15							
Burst ID	Burst Offset (us)	Pulse Width (us)	Chirp Width (MHz)	Number of Pulses per Burst	PRI-1 (us)	PRI-2 (us)	PRI-3 (us)
1	361323.0	93.3	18	3	1983.0	1912.0	1535.0
2	515261.0	69.1	18	2	1102.0	1794.0	-
3	39025.0	86.9	18	3	1044.0	1152.0	1148.0
4	190900.0	84.9	18	3	1894.0	1948.0	1118.0
5	343941.0	72.3	18	2	1094.0	1916.0	-
6	497624.0	51.7	18	1	1447.0	-	-
7	20319.0	58.3	18	1	1429.0	-	-
8	172999.0	60.8	18	1	1979.0	-	-
9	325872.0	57.1	18	1	1641.0	-	-
10	475841.0	88.9	18	3	1886.0	1964.0	1489.0
11	1489.0	72.0	18	2	1909.0	1297.0	-
12	153647.0	90.9	18	3	1261.0	1566.0	1370.0
13	307096.0	59.8	18	1	1552.0	-	-
14	458804.0	70.0	18	2	1759.0	1291.0	-
15	610798.0	67.2	18	2	1625.0	1881.0	-
16	134759.0	91.2	18	3	1382.0	1832.0	1661.0
17	288306.0	56.5	18	1	1483.0	-	-
18	441296.0	51.2	18	1	1237.0	-	-
19	592780.0	74.1	18	2	1471.0	1245.0	-



Trial Number 16							
Burst ID	Burst Offset (us)	Pulse Width (us)	Chirp Width (MHz)	Number of Pulses per Burst	PRI-1 (us)	PRI-2 (us)	PRI-3 (us)
1	158286.0	76.9	12	2	1110.0	1140.0	-
2	366024.0	50.2	12	1	1316.0	-	-
3	573452.0	62.9	12	1	1520.0	-	-
4	780619.0	64.7	12	1	1902.0	-	-
5	132455.0	83.8	12	3	1410.0	1097.0	1621.0
6	340207.0	65.4	12	1	1944.0	-	-
7	548208.0	53.2	12	1	1024.0	-	-
8	755333.0	51.7	12	1	1603.0	-	-
9	107117.0	78.7	12	2	1804.0	1168.0	-
10	314500.0	72.4	12	2	1030.0	1343.0	-
11	522447.0	53.8	12	1	1327.0	-	-
12	728517.0	73.6	12	2	1524.0	1553.0	-
13	81611.0	66.7	12	2	1722.0	1122.0	-
14	288948.0	82.5	12	2	1404.0	1019.0	-



Trial Number 17							
Burst ID	Burst Offset (us)	Pulse Width (us)	Chirp Width (MHz)	Number of Pulses per Burst	PRI-1 (us)	PRI-2 (us)	PRI-3 (us)
1	345766.0	87.6	20	3	1565.0	1055.0	1840.0
2	490019.0	85.2	20	3	1735.0	1541.0	1408.0
3	39073.0	84.8	20	3	1534.0	1889.0	1463.0
4	183923.0	77.9	20	2	1749.0	1460.0	-
5	328777.0	76.5	20	2	1518.0	1485.0	-
6	474728.0	60.9	20	1	1540.0	-	-
7	21394.0	83.0	20	2	1080.0	1010.0	-
8	165992.0	80.4	20	2	1824.0	1752.0	-
9	310973.0	67.5	20	2	1764.0	1181.0	-
10	456884.0	62.1	20	1	1495.0	-	-
11	3515.0	86.4	20	3	1773.0	1966.0	1263.0
12	147928.0	84.3	20	3	1593.0	1188.0	1788.0
13	293225.0	76.9	20	2	1226.0	1537.0	-
14	436922.0	95.8	20	3	1192.0	1298.0	1844.0
15	584015.0	55.2	20	1	1644.0	-	-
16	130832.0	59.0	20	1	1402.0	-	-
17	274684.0	94.5	20	3	1296.0	1700.0	1283.0
18	418579.0	91.9	20	3	1970.0	1978.0	1165.0
19	563464.0	85.2	20	3	1732.0	1551.0	1189.0
20	112787.0	69.5	20	2	1038.0	1224.0	-



Trial Number 18							
Burst ID	Burst Offset (us)	Pulse Width (us)	Chirp Width (MHz)	Number of Pulses per Burst	PRI-1 (us)	PRI-2 (us)	PRI-3 (us)
1	429224.0	86.4	10	3	1259.0	1918.0	1455.0
2	670241.0	92.2	10	3	1598.0	1719.0	1895.0
3	912880.0	80.4	10	2	1816.0	1899.0	-
4	158603.0	54.3	10	1	1335.0	-	-
5	400824.0	53.1	10	1	1303.0	-	-
6	641915.0	69.4	10	2	1503.0	1546.0	-
7	883823.0	69.1	10	2	1279.0	1639.0	-
8	128373.0	100.0	10	3	1375.0	1438.0	1595.0
9	370379.0	79.6	10	2	1239.0	1705.0	-
10	611194.0	88.4	10	3	1374.0	1579.0	1623.0
11	855665.0	53.3	10	1	1016.0	-	-
12	98897.0	65.3	10	1	1709.0	-	-

Trial Number 19							
Burst ID	Burst Offset (us)	Pulse Width (us)	Chirp Width (MHz)	Number of Pulses per Burst	PRI-1 (us)	PRI-2 (us)	PRI-3 (us)
1	292143.0	55.3	12	1	1920.0	-	-
2	499633.0	58.3	12	1	1797.0	-	-
3	706377.0	72.3	12	2	1610.0	1039.0	-
4	58989.0	84.8	12	3	1131.0	1761.0	1721.0
5	266161.0	82.5	12	2	1875.0	1431.0	-
6	474469.0	63.3	12	1	1095.0	-	-
7	680544.0	80.0	12	2	1119.0	1913.0	-
8	33519.0	90.3	12	3	1660.0	1853.0	1123.0
9	240319.0	91.1	12	3	1539.0	1783.0	1172.0
10	447400.0	96.6	12	3	1525.0	1036.0	1385.0
11	654516.0	82.7	12	2	1710.0	1990.0	-
12	8083.0	50.7	12	1	1234.0	-	-
13	215435.0	78.4	12	2	1047.0	1109.0	-
14	421325.0	99.5	12	3	1299.0	1965.0	1869.0





Trial Number 20							
Burst ID	Burst Offset (us)	Pulse Width (us)	Chirp Width (MHz)	Number of Pulses per Burst	PRI-1 (us)	PRI-2 (us)	PRI-3 (us)
1	733725.0	88.6	10	3	1501.0	1067.0	1927.0
2	977882.0	57.4	10	1	1723.0	-	-
3	221197.0	96.6	10	3	1086.0	1658.0	1324.0
4	462915.0	69.7	10	2	1751.0	1945.0	-
5	705071.0	77.9	10	2	1642.0	1317.0	-
6	947923.0	62.0	10	1	1866.0	-	-
7	191373.0	88.4	10	3	1997.0	1077.0	1366.0
8	432561.0	97.3	10	3	1790.0	1896.0	1367.0
9	674004.0	96.2	10	3	1391.0	1787.0	1672.0
10	915842.0	95.4	10	3	1020.0	1892.0	1414.0
11	162176.0	54.8	10	1	1084.0	-	-
12	403553.0	80.4	10	2	1850.0	1436.0	-

Trial Number 21							
Burst ID	Burst Offset (us)	Pulse Width (us)	Chirp Width (MHz)	Number of Pulses per Burst	PRI-1 (us)	PRI-2 (us)	PRI-3 (us)
1	483470.0	74.7	15	2	1619.0	1611.0	-
2	666072.0	57.1	15	1	1560.0	-	-
3	98810.0	91.9	15	3	1392.0	1475.0	1276.0
4	279914.0	83.1	15	2	1809.0	1772.0	-
5	462536.0	50.7	15	1	1003.0	-	-
6	642324.0	79.2	15	2	1574.0	1600.0	-
7	76831.0	58.7	15	1	1186.0	-	-
8	257785.0	71.0	15	2	1521.0	1567.0	-
9	438554.0	79.0	15	2	1777.0	1960.0	-
10	620397.0	68.5	15	2	1284.0	1428.0	-
11	54310.0	73.5	15	2	1904.0	1352.0	-
12	235506.0	70.5	15	2	1864.0	1115.0	-
13	417036.0	76.6	15	2	1045.0	1300.0	-
14	597974.0	81.2	15	2	1160.0	1675.0	-
15	32086.0	61.8	15	1	1277.0	-	-
16	212751.0	94.9	15	3	1450.0	1206.0	1860.0



Trial Number 22							
Burst ID	Burst Offset (us)	Pulse Width (us)	Chirp Width (MHz)	Number of Pulses per Burst	PRI-1 (us)	PRI-2 (us)	PRI-3 (us)
1	526149.0	78.5	9	2	1653.0	1698.0	-
2	767135.0	89.8	9	3	1174.0	1962.0	1167.0
3	12955.0	59.4	9	1	1982.0	-	-
4	254612.0	79.6	9	2	1633.0	1890.0	-
5	496588.0	76.0	9	2	1112.0	1811.0	-
6	739728.0	53.6	9	1	1144.0	-	-
7	980872.0	80.9	9	2	1220.0	1053.0	-
8	225249.0	61.6	9	1	1724.0	-	-
9	467279.0	53.4	9	1	1901.0	-	-
10	709720.0	59.9	9	1	1379.0	-	-
11	951847.0	60.4	9	1	1453.0	-	-
12	194839.0	91.4	9	3	1768.0	1726.0	1227.0



Trial Number 23							
Burst ID	Burst Offset (us)	Pulse Width (us)	Chirp Width (MHz)	Number of Pulses per Burst	PRI-1 (us)	PRI-2 (us)	PRI-3 (us)
1	261858.0	77.0	20	2	1191.0	1363.0	-
2	407646.0	58.1	20	1	1248.0	-	-
3	552319.0	62.1	20	1	1836.0	-	-
4	99107.0	76.9	20	2	1334.0	1236.0	-
5	243514.0	80.0	20	2	1914.0	1852.0	-
6	389464.0	52.0	20	1	1701.0	-	-
7	531093.0	88.6	20	3	1693.0	1995.0	1905.0
8	81159.0	72.9	20	2	1922.0	1387.0	-
9	225245.0	98.5	20	3	1839.0	1746.0	1389.0
10	371906.0	57.9	20	1	1193.0	-	-
11	514197.0	95.9	20	3	1659.0	1870.0	1066.0
12	63561.0	53.5	20	1	1162.0	-	-
13	207510.0	92.0	20	3	1745.0	1654.0	1458.0
14	353638.0	57.3	20	1	1834.0	-	-
15	497515.0	70.5	20	2	1684.0	1586.0	-
16	45553.0	70.0	20	2	1042.0	1664.0	-
17	189821.0	84.0	20	3	1765.0	1630.0	1176.0
18	335330.0	76.1	20	2	1557.0	1057.0	-
19	478825.0	93.2	20	3	1985.0	1018.0	1340.0
20	27594.0	96.8	20	3	1760.0	1614.0	1817.0



Trial Number 24							
Burst ID	Burst Offset (us)	Pulse Width (us)	Chirp Width (MHz)	Number of Pulses per Burst	PRI-1 (us)	PRI-2 (us)	PRI-3 (us)
1	247117.0	50.1	12	1	1841.0	-	-
2	453362.0	93.5	12	3	1590.0	1081.0	1413.0
3	660875.0	68.8	12	2	1707.0	1577.0	-
4	14140.0	56.3	12	1	1056.0	-	-
5	220734.0	86.0	12	3	1953.0	1108.0	1987.0
6	428367.0	75.2	12	2	1572.0	1536.0	-
7	636681.0	54.4	12	1	1517.0	-	-
8	843157.0	71.1	12	2	1329.0	1243.0	-
9	195585.0	76.2	12	2	1940.0	1770.0	-
10	403231.0	80.2	12	2	1098.0	1209.0	-
11	610202.0	79.7	12	2	1588.0	1214.0	-
12	815229.0	90.9	12	3	1615.0	1862.0	1601.0
13	170267.0	68.7	12	2	1377.0	1441.0	-
14	377306.0	67.4	12	2	1872.0	1313.0	-

Trial Number 25							
Burst ID	Burst Offset (us)	Pulse Width (us)	Chirp Width (MHz)	Number of Pulses per Burst	PRI-1 (us)	PRI-2 (us)	PRI-3 (us)
1	628071.0	94.0	11	3	1643.0	1748.0	1941.0
2	853391.0	70.8	11	2	1177.0	1201.0	-
3	156223.0	56.3	11	1	1006.0	-	-
4	378734.0	96.7	11	3	1230.0	1163.0	1332.0
5	601331.0	90.6	11	3	1217.0	1582.0	1498.0
6	825462.0	74.5	11	2	1569.0	1281.0	-
7	128265.0	92.6	11	3	1065.0	1669.0	1222.0
8	351161.0	89.0	11	3	1493.0	1135.0	1380.0
9	573425.0	96.5	11	3	1607.0	1822.0	1602.0
10	798431.0	70.5	11	2	1141.0	1178.0	-
11	100737.0	94.0	11	3	1009.0	1629.0	1956.0
12	324661.0	55.8	11	1	1290.0	-	-
13	546278.0	87.7	11	3	1435.0	1963.0	1164.0



Trial Number 26							
Burst ID	Burst Offset (us)	Pulse Width (us)	Chirp Width (MHz)	Number of Pulses per Burst	PRI-1 (us)	PRI-2 (us)	PRI-3 (us)
1	1253842.0	68.6	5	2	1306.0	1161.0	-
2	119486.0	83.1	5	2	1420.0	1315.0	-
3	482958.0	60.9	5	1	1687.0	-	-
4	845641.0	77.7	5	2	1776.0	1158.0	-
5	1208428.0	77.4	5	2	1793.0	1510.0	-
6	74748.0	66.8	5	2	1576.0	1323.0	-
7	438300.0	63.7	5	1	1333.0	-	-
8	800152.0	91.2	5	3	1409.0	1681.0	1275.0

Trial Number 27							
Burst ID	Burst Offset (us)	Pulse Width (us)	Chirp Width (MHz)	Number of Pulses per Burst	PRI-1 (us)	PRI-2 (us)	PRI-3 (us)
1	545865.0	83.6	16	3	1632.0	1195.0	1000.0
2	14067.0	89.4	16	3	1173.0	1627.0	1656.0
3	184953.0	55.8	16	1	1532.0	-	-
4	353759.0	90.9	16	3	1981.0	1554.0	1998.0
5	526388.0	54.7	16	1	1825.0	-	-
6	694806.0	97.7	16	3	1734.0	1202.0	1250.0
7	163568.0	67.5	16	2	1571.0	1434.0	-
8	333410.0	96.7	16	3	1589.0	1469.0	1268.0
9	504006.0	68.3	16	2	1750.0	1954.0	-
10	675297.0	78.3	16	2	1591.0	1082.0	-
11	142890.0	55.0	16	1	1427.0	-	-
12	312479.0	84.9	16	3	1129.0	1936.0	1199.0
13	482953.0	74.6	16	2	1959.0	1856.0	-
14	655022.0	63.3	16	1	1885.0	-	-
15	121457.0	99.8	16	3	1035.0	1515.0	1120.0
16	292606.0	63.6	16	1	1647.0	-	-
17	461322.0	87.3	16	3	1931.0	1051.0	1831.0



Trial Number 28							
Burst ID	Burst Offset (us)	Pulse Width (us)	Chirp Width (MHz)	Number of Pulses per Burst	PRI-1 (us)	PRI-2 (us)	PRI-3 (us)
1	565136.0	85.6	19	3	1946.0	1078.0	1015.0
2	89970.0	68.6	19	2	1029.0	1780.0	-
3	243121.0	54.2	19	1	1111.0	-	-
4	396034.0	61.2	19	1	1104.0	-	-
5	546225.0	97.1	19	3	1157.0	1969.0	1100.0
6	70998.0	98.3	19	3	1142.0	1699.0	1622.0
7	224093.0	62.4	19	1	1655.0	-	-
8	376127.0	80.2	19	2	1126.0	1769.0	-
9	527806.0	87.5	19	3	1216.0	1448.0	1179.0
10	52247.0	85.8	19	3	1847.0	1348.0	1472.0
11	204582.0	88.1	19	3	1023.0	1124.0	1631.0
12	357941.0	65.3	19	1	1848.0	-	-
13	510977.0	52.5	19	1	1470.0	-	-
14	33698.0	52.3	19	1	1312.0	-	-
15	186023.0	74.1	19	2	1915.0	1200.0	-
16	339327.0	54.9	19	1	1479.0	-	-
17	491053.0	76.2	19	2	1376.0	1502.0	-
18	14858.0	60.4	19	1	1758.0	-	-
19	167387.0	81.5	19	2	1491.0	1103.0	-



Trial Number 29							
Burst ID	Burst Offset (us)	Pulse Width (us)	Chirp Width (MHz)	Number of Pulses per Burst	PRI-1 (us)	PRI-2 (us)	PRI-3 (us)
1	507709.0	50.5	10	1	1857.0	-	-
2	750249.0	55.7	10	1	1246.0	-	-
3	989003.0	85.8	10	3	1774.0	1002.0	1967.0
4	235634.0	76.9	10	2	1125.0	1474.0	-
5	477675.0	75.1	10	2	1254.0	1052.0	-
6	718312.0	92.3	10	3	1180.0	1486.0	1492.0
7	960895.0	78.1	10	2	1301.0	1757.0	-
8	205370.0	92.2	10	3	1898.0	1252.0	1713.0
9	446940.0	89.0	10	3	1260.0	1706.0	1411.0
10	689225.0	70.9	10	2	1578.0	1620.0	-
11	932305.0	63.1	10	1	1782.0	-	-
12	176231.0	55.3	10	1	1522.0	-	-



Trial Number 30							
Burst ID	Burst Offset (us)	Pulse Width (us)	Chirp Width (MHz)	Number of Pulses per Burst	PRI-1 (us)	PRI-2 (us)	PRI-3 (us)
1	277485.0	83.4	17	3	1454.0	1205.0	1801.0
2	437880.0	97.3	17	3	1319.0	1826.0	1635.0
3	598445.0	90.4	17	3	1079.0	1986.0	1674.0
4	97088.0	91.8	17	3	1563.0	1151.0	1802.0
5	257251.0	98.2	17	3	1876.0	1977.0	1766.0
6	419893.0	59.5	17	1	1952.0	-	-
7	580724.0	80.0	17	2	1253.0	1137.0	-
8	77366.0	86.5	17	3	1054.0	1128.0	1828.0
9	238032.0	91.1	17	3	1105.0	1599.0	1442.0
10	398605.0	93.5	17	3	1867.0	1373.0	1087.0
11	562025.0	60.7	17	1	1033.0	-	-
12	57684.0	67.2	17	2	1288.0	1405.0	-
13	219083.0	61.8	17	1	1585.0	-	-
14	379234.0	79.4	17	2	1933.0	1667.0	-
15	540896.0	81.4	17	2	1096.0	1464.0	-
16	37916.0	65.7	17	1	1496.0	-	-
17	198794.0	76.0	17	2	1733.0	1255.0	-
18	359754.0	81.0	17	2	1326.0	1668.0	-





### 5.10.In-Service Monitoring

The In-Service Monitoring is defined as the process by which an RLAN monitors the Operating Channel for the presence of radar signals.

Additional requirements for devices with multiple bandwidth modes	Master or Client with radar detection	Client without radar detection
U-NII Detection Bandwidth and Statistical Performance Check	All BW modes must be tested	Not required
Channel Move Time and Channel Closing Transmission Time	Test using widest BW mode available	Test using the widest BW mode available for the link
All other	Any single BW mode	Not required
Note: Frequencies selected for statistical performance check (Section 7.8.4) should include several frequencies within the radar detection bandwidth and frequencies near the edge of the radar detection bandwidth. For 802.11 devices it is suggested to select frequencies in each of the bonded 20 MHz channels and the channel center frequency.		

#### 5.10.1. Test Limit

Parameter	Value
Channel Move Time	< 10 s (See Note 1)
Channel Closing Transmission Time	< 200 ms+ an aggregate of 60 milliseconds over remaining 10 second period. (See Notes 1 and Notes 2.)
<p>Note 1: Channel Move Time and the Channel Closing Transmission Time should be performed with Radar Type 0. The measurement timing begins at the end of the Radar Type 0 burst.</p> <p>Note 2: The Channel Closing Transmission Time is comprised of 200 milliseconds starting at the beginning of the Channel Move Time plus any additional intermittent control signals required to facilitate a Channel move (an aggregate of 60 milliseconds) during the remainder of the 10 second period. The aggregate duration of control signals will not count quiet periods in between transmissions.</p>	

#### Limits Clause 4.7.2.2.2

The In-Service Monitoring shall be used to continuously monitor an Operating Channel.

The In-Service-Monitoring shall start immediately after the RLAN has started transmissions on an Operating Channel.



### 5.10.2. Test Result of In-Service Monitoring (Master)

Modulation Standard: 802.11ax HE160, 5570MHz

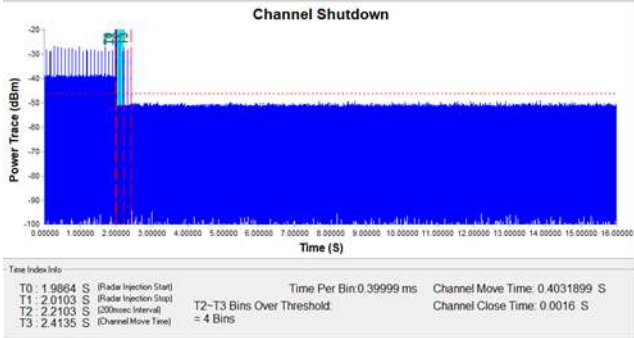



### 5.11. Non-Occupancy Period

The Channel Shutdown is defined as the process initiated by the RLAN device immediately after a radar signal has been detected on an Operating Channel.

The master device shall instruct all associated slave devices to stop transmitting on this channel, which they shall do within the Channel Move Time.

Slave devices with a Radar Interference Detection function, shall stop their own transmissions within the Channel Move Time.

The aggregate duration of all transmissions of the RLAN device on this channel during the Channel Move Time shall be limited to the Channel Closing Transmission Time. The aggregate duration of all transmissions shall not include quiet periods in between transmissions.

#### 5.11.1. Test Limit

Radar Test Signal	Master (min)	Client (min)
0	> 30	> 30



### 5.11.2. Test Result of Non-Occupancy Period

(Master)

Modulation Standard: 802.11ax HE160, 5570MHz

