



# FCC RADIO TEST REPORT

Applicant : D-Link Corporation  
Address : No. 289, XinHu 3rd Rd., Neihu District,  
Taipei 11494, TAIWAN  
Equipment : Nuclias Connect AX3000 Access Point  
Model No. : DAP-X3060  
Trade Name : D-Link  
FCC ID. : KA2APX3060A1

## I HEREBY CERTIFY THAT:

The sample was received on Jun. 21, 2023 and the testing was completed on Aug. 15, 2023 at CerpPASS Technology Corp. The test result refers exclusively to the test presented test model / sample. Without written approval of CerpPASS Technology Corp., the test report shall not be reproduced except in full.

Approved by:

Mark Liao / Supervisor

Laboratory Accreditation:

CerpPASS Technology Corporation Test Laboratory





CONTENTS

- 1. Summary of Test Procedure and Test Results ..... 5
  - 1.1. Applicable Standards .....5
- 2. Test Configuration of Equipment under Test ..... 6
  - 2.1. Feature of Equipment under Test.....6
  - 2.2. Carrier Frequency of Channels ..... 7
  - 2.3. Test Mode and Test Software .....9
  - 2.4. Description of Test System..... 10
  - 2.5. General Information of Test..... 11
  - 2.6. Measurement Uncertainty ..... 11
- 3. Test Equipment and Ancillaries Used for Tests ..... 12
- 4. Antenna Requirements ..... 14
  - 4.1. Standard Applicable ..... 14
  - 4.2. Antenna Construction and Directional Gain..... 14
- 5. Test of AC Power Line Conducted Emission ..... 16
  - 5.1. Test Limit ..... 16
  - 5.2. Test Procedures ..... 16
  - 5.3. Typical Test Setup ..... 17
  - 5.4. Test Result and Data..... 18
  - 5.5. Test Photographs ..... 20
- 6. Test of Spurious Emission (Radiated)..... 21
  - 6.1. Test Limit ..... 21
  - 6.2. Test Procedures ..... 22
  - 6.3. Typical Test Setup ..... 23
  - 6.4. Test Result and Data (9kHz ~ 30MHz)..... 24
  - 6.5. Test Result and Data (30MHz ~ 1GHz) ..... 24
  - 6.6. Test Result and Data (1GHz ~ 40GHz)..... 26
  - 6.7. Restricted Bands of Operation ..... 114
  - 6.8. Test Photographs (30MHz ~ 1GHz) ..... 115
  - 6.9. Test Photographs (1GHz ~ 40GHz) ..... 116
- 7. On Time, Duty Cycle and Measurement methods ..... 118
  - 7.1. Test Limit ..... 118
  - 7.2. Test Procedure ..... 118
  - 7.3. Test Setup Layout ..... 118
  - 7.4. Test Result and Data..... 118
  - 7.5. Measurement Methods ..... 118
- 8. 6dB Bandwidth & 99% Occupied Bandwidth ..... 120
  - 8.1. Test Limit ..... 120
  - 8.2. Test Procedure ..... 120
  - 8.3. Test Setup Layout ..... 120
  - 8.4. Test Result and Data..... 121
- 9. 26dB Bandwidth & 99% Occupied Bandwidth ..... 138
  - 9.1. Test Limit ..... 138



- 9.2. Test Procedure ..... 138
- 9.3. Test Setup Layout ..... 138
- 9.4. Test Result and Data ..... 138
- 10. Average Power..... 189
  - 10.1. Test Limit ..... 189
  - 10.2. Test Procedure ..... 190
  - 10.3. Test Setup Layout ..... 190
  - 10.4. Test Result and Data..... 191
- 11. Power Spectral Density ..... 204
  - 11.1. Test Limit ..... 204
  - 11.2. Test Procedure ..... 204
  - 11.3. Test Setup Layout ..... 204
  - 11.4. Test Result and Data ..... 205
- 12. Radio Frequency Exposure ..... 236
  - 12.1. Applicable Standards ..... 236
  - 12.2. EUT Specification..... 237
  - 12.3. Test Result..... 238



### History of this test report

Report No.	Issued Date	Description
23050291-TRFCC02	Nov. 24, 2023	Original



# 1. Summary of Test Procedure and Test Results

## 1.1. Applicable Standards

**ANSI C63.10:2013**

**FCC Rules and Regulations Part 15 Subpart E §15.407**

**KDB 789033**

FCC Rule	Description of Test	Result
15.203	Antenna Requirement	PASS
15.207(a)	AC Power Line Conducted Emission	PASS
15.407(b) 15.209	Radiated Spurious Emission	PASS
15.407(a)	26 dB & Occupied Bandwidth	PASS
15.407	6 dB Bandwidth	PASS
15.407 (a) & (a)(3)	Average Power	PASS
15.407(a)	Power Spectral Density	PASS

\*The lab has reduced the uncertainty risk factor from test equipment, environment and staff technicians which according to the standard on contract. Therefore, the test result will only be determined by standard requirement, measurement uncertainty evaluation is not considered.

\*This EUT has been also tested and compiled with the requirement of FCC Part 15, Subpart B, recorded in a separate test report (23050291-TEFV01).



## 2. Test Configuration of Equipment under Test

### 2.1. Feature of Equipment under Test

Operation Frequency Range	802.11b/g/n/Turbo QAM/ax: 2400-2483.5MHz 802.11a/n/ac/ax: 5150-5250MHz, 5250-5350MHz, 5470-5725MHz, 5725-5850MHz
Center Frequency Range	802.11b/g/n/Turbo QAM/ax: 2412-2462MHz 802.11a/n/ac/ax: 5180-5240MHz, 5260-5320MHz, 5500-5700MHz, 5745-5825MHz
Modulation Type	2.4GHz 802.11b: CCK, DQPSK, DBPSK 802.11g/n: BPSK, QPSK, 16QAM, 64QAM, 256QAM(TurboQAM) 802.11ax: BPSK, QPSK, 16QAM, 64QAM, 256QAM, 1024QAM 5GHz 802.11n/a: BPSK, QPSK, 16QAM, 64QAM 802.11ac: BPSK, QPSK, 16QAM, 64QAM, 256QAM 802.11ax: BPSK, QPSK, 16QAM, 64QAM, 256QAM, 1024QAM
Modulation Technology	DSSS, OFDM, OFDMA
Data Rate	2.4GHz 802.11b: 1, 2, 5.5, 11Mbps 802.11g: 6, 9, 12, 18, 24, 36, 48, 54Mbps 802.11n: MCS0 – MCS15, HT20/40 MCS0 – MCS9, VHT20/40(Turbo QAM) 802.11ax: MCS0 – MCS11, HE20/40 5GHz 802.11a: 6, 9, 12, 18, 24, 36, 48, 54Mbps 802.11n: MCS0 – MCS15, HT20/40 802.11ac: MCS0 – MCS9, VHT20/40/80/160 802.11ax: MCS0 – MCS11, HE20/40/80/160
Antenna Type	PIFA Antenna
Antenna Gain	2400-2483.5MHz: ANT A: 3.46dBi, ANT B: 3.13dBi 5150-5250MHz: ANT C: 2.51dBi, ANT D: 3.15dBi 5250-5350MHz: ANT C: 2.70dBi, ANT D: 3.37dBi 5470-5725MHz: ANT C: 3.03dBi, ANT D: 3.17dBi 5725-5850MHz: ANT C: 2.68dBi, ANT D: 3.27dBi
Adapter	Brand: APD Model: WA-30P12R
Adapter	Brand: AMIGO Model: AMS200-1201500F

Note:

1. WLAN 2.4G 802.11n supports TurboQAM.
2. EUT supports TPC function.
3. EUT supports DFS master mode.
4. WLAN 2.4GHz 802.11n/TurboQAM/ax & WLAN 5GHz 802.11n/ac/ax support beamforming function.
5. WLAN 2.4G and WLAN 5G can simultaneously transmission.
6. For more details, please refer to the User's manual of the EUT.



## 2.2. Carrier Frequency of Channels

Band: 5150MHz-5250MHz

802.11a, 802.11n HT20, 802.11ac VHT20, 802.11ax HE20

Channel	Frequency(MHz)	Channel	Frequency(MHz)
<b>*36</b>	<b>5180</b>	44	5220
<b>*40</b>	<b>5200</b>	<b>*48</b>	<b>5240</b>

802.11n HT40, 802.11ac VHT40, 802.11ax HE40

Channel	Frequency(MHz)	Channel	Frequency(MHz)
<b>*38</b>	<b>5190</b>	<b>*46</b>	<b>5230</b>

802.11ac VHT80, 802.11ax HE80

Channel	Frequency(MHz)
<b>*42</b>	<b>5210</b>

Band: 5250MHz-5350MHz

802.11a, 802.11n HT20, 802.11ac VHT20, 802.11ax HE20

Channel	Frequency(MHz)	Channel	Frequency(MHz)
<b>*52</b>	<b>5260</b>	<b>*60</b>	<b>5300</b>
56	5280	<b>*64</b>	<b>5320</b>

802.11n HT40, 802.11ac VHT40, 802.11ax HE40

Channel	Frequency(MHz)	Channel	Frequency(MHz)
<b>*54</b>	<b>5270</b>	<b>*62</b>	<b>5310</b>

802.11ac VHT80, 802.11ax HE80

Channel	Frequency(MHz)
<b>*58</b>	<b>5290</b>

Band: 5150MHz -5350MHz: Straddle Channel

802.11ac VHT160, 802.11ax HE160

Channel	Frequency(MHz)
<b>*50</b>	<b>5250</b>

Band: 5470MHz-5725MHz

802.11a, 802.11n HT20, 802.11ac VHT20, 802.11ax HE20

Channel	Frequency(MHz)	Channel	Frequency(MHz)
<b>*100</b>	<b>5500</b>	124	5620
104	5520	128	5640
108	5540	132	5660
112	5560	136	5680
116	5580	<b>*140</b>	<b>5700</b>
<b>*120</b>	<b>5600</b>		

802.11n HT40, 802.11ac VHT40, 802.11ax HE40

Channel	Frequency(MHz)	Channel	Frequency(MHz)
<b>*102</b>	<b>5510</b>	126	5630
110	5550	<b>*134</b>	<b>5670</b>
<b>*118</b>	<b>5590</b>		

802.11ac VHT80, 802.11ax HE80

Channel	Frequency(MHz)	Channel	Frequency(MHz)
<b>*106</b>	<b>5530</b>	<b>*122</b>	<b>5610</b>

802.11ac VHT160, 802.11ax HE160

Channel	Frequency(MHz)
<b>*114</b>	<b>5570</b>



Band 3: Straddle Channel

802.11a, 802.11n HT 20, 802.11ac VHT20, 802.11ax HE20

Channel	Frequency(MHz)
<b>*144</b>	<b>5720</b>

802.11n HT40, 802.11ac VHT40, 802.11ax HE40

Channel	Frequency(MHz)
<b>*142</b>	<b>5710</b>

802.11ac VHT80, 802.11ax HE80

Channel	Frequency(MHz)
<b>*138</b>	<b>5690</b>

Band: 5725MHz-5850MHz

802.11a, 802.11n HT20, 802.11ac VHT20, 802.11ax HE20

Channel	Frequency(MHz)	Channel	Frequency(MHz)
<b>*149</b>	<b>5745</b>	161	5805
153	5765	<b>*165</b>	<b>5825</b>
<b>*157</b>	<b>5785</b>		

802.11n HT40, 802.11ac VHT40, 802.11ax HE40

Channel	Frequency(MHz)	Channel	Frequency(MHz)
<b>*151</b>	<b>5755</b>	<b>*159</b>	<b>5795</b>

802.11ac VHT80, 802.11ax HE80

Channel	Frequency(MHz)
<b>*155</b>	<b>5775</b>

Note: Channels remarked \* are selected to perform test.





**2.3. Test Mode and Test Software**

- a. During testing, the interface cables and equipment positions were varied according to ANSI C63.10.
- b. An executive program, "QSPR ver. 5.0-00197" under Windows 10 system was executed to transmit and receive data via WLAN.
- c. The following test modes were performed for the test:

<b>Conducted Emissions from the AC mains power ports</b>	
Test Mode 1	802.11ax HE20 (7.3Mbps), TX Mode, AC 240V/60Hz from Adapter: WA-30P12R
Test Mode 2	802.11ax HE20 (7.3Mbps), TX Mode, AC 240V/60Hz from Adapter: AMS200-1201500F
Test Mode 3	802.11ax HE20 (7.3Mbps), TX Mode, AC 120V/60Hz from Adapter: WA-30P12R
caused "Test Mode 3" generated the worst case, it was reported as the final data.	
<b>Radiated Emissions (Below 1GHz)</b>	
Test Mode 1	802.11ax HE20 (7.3Mbps), TX Mode, AC 240V/60Hz from Adapter: WA-30P12R
Test Mode 2	802.11ax HE20 (7.3Mbps), TX Mode, AC 240V/60Hz from Adapter: AMS200-1201500F
Test Mode 3	802.11ax HE20 (7.3Mbps), TX Mode, AC 120V/60Hz from Adapter: WA-30P12R
caused "Test Mode 3" generated the worst case, it was reported as the final data.	
<b>Radiated Emissions (Above 1GHz)</b>	
Test Mode 1	802.11a (6Mbps), TX Mode, AC 120V/60Hz from Adapter: WA-30P12R
Test Mode 2	802.11ac VHT20 (6.5Mbps), TX Mode, AC 120V/60Hz from Adapter: WA-30P12R
Test Mode 3	802.11ac VHT40 (13.5Mbps), TX Mode, AC 120V/60Hz from Adapter: WA-30P12R
Test Mode 4	802.11ac VHT80 (29.3Mbps), TX Mode, AC 120V/60Hz from Adapter: WA-30P12R
Test Mode 5	802.11ac VHT160 (58.5Mbps), TX Mode, AC 120V/60Hz from Adapter: WA-30P12R
Test Mode 6	802.11ax HE20 (7.3Mbps), TX Mode, AC 120V/60Hz from Adapter: WA-30P12R
Test Mode 7	802.11ax HE40 (14.6Mbps), TX Mode, AC 120V/60Hz from Adapter: WA-30P12R
Test Mode 8	802.11ax HE80 (30.6Mbps), TX Mode, AC 120V/60Hz from Adapter: WA-30P12R
Test Mode 9	802.11ax HE160 (61.3Mbps), TX Mode, AC 120V/60Hz from Adapter: WA-30P12R
caused "Test Mode 1, 6-9" generated the worst case, these were reported as the final data.	

Note: The EUT supports non-beamforming and beamforming function, after engineering evaluation, non-beamforming generated the worst case, it was reported as the final data.

The EUT incorporates a MIMO function

Modulation Type	TX CONFIGURATION
802.11a	2TX
802.11n HT20	2TX
802.11n HT40	2TX
802.11ac VHT20	2TX
802.11ac VHT40	2TX
802.11ac VHT80	2TX
802.11ac VHT160	2TX
802.11ax HE20	2TX
802.11ax HE40	2TX
802.11ax HE80	2TX
802.11ax HE160	2TX



### 2.4. Description of Test System

RF Conducted				
Equipment	Brand	Model	Length/Type	Power cord/ Length/Type
Notebook	lenovo	S1GL2W	N/A	Adapter / 1.8m / NS
RJ45 Cable	TE CONNECTIVITY	CAT5E	1.2m / NS	N/A

Radiated Emissions				
Equipment	Brand	Model	Length/Type	Power cord/ Length/Type
Notebook	ASUS	P2430U	N/A	Adapter / 1.8m / NS
RJ45 Cable	TE CONNECTIVITY	CAT5E	15m / NS	N/A

AC Power Line Conducted Emission				
Equipment	Brand	Model	Length/Type	Power cord/ Length/Type
Notebook	ASUS	P2430U	N/A	Adapter / 1.8m / NS
RJ45 Cable	TE CONNECTIVITY	CAT5E	15m / NS	N/A

**2.5. General Information of Test**

☒ Test Site	CerpPASS Technology Corporation Test Laboratory Address: No.10, Ln. 2, Lianfu St., Luzhu Dist., Taoyuan City 33848, Taiwan (R.O.C.) Tel: +886-3-3226-888 Fax: +886-3-3226-881	
	FCC	TW1439, TW1079
	IC	4934E-1, 4934E-2
Frequency Range Investigated	Conducted: from 150kHz to 30 MHz Radiation: from 30 MHz to 40,000MHz	
Test Distance	The test distance of radiated emission from antenna to EUT is 3 M.	

**Non-beamforming**

Test Item	Test Site	Test Period	Environmental Conditions	Tested By
RF Conducted	RFCON01-NK	2023/07/15~ 2023/08/03	23.2~26.5°C / 47~57%	Leon Huang
Radiated Emissions	3M02-NK	2023/07/14~ 2023/07/25	22~26°C / 41~58%	Leon Huang
AC Power Line Conducted Emission	CON02-NK	2023/07/28	23°C / 67%	Leon Huang

**Beamforming and Co-Located**

Test Item	Test Site	Test Period	Environmental Conditions	Tested By
RF Conducted	RFCON01-NK	2023/07/15~ 2023/08/15	23.2~26.5°C / 47~57%	Leon Huang

**2.6. Measurement Uncertainty**

ISO/IEC 17025 requires that an estimate of the measurement uncertainties associated with the emissions test results be included in the report. The measurement uncertainties given below are based on a 95% confidence level (based on a coverage factor (k=2)).

Measurement Item	Uncertainty
AC Power Line Conduction(150K~30MHz)	±3.28dB
Radiated Spurious Emission(9KHz~30MHz)	±3.5dB
Radiated Spurious Emission(30MHz~1GHz)	±5.1dB
Radiated Spurious Emission(1GHz~40GHz)	±5.2dB
6dB Bandwidth	±5.4%
26dB Bandwidth	±4.4%
Occupied Bandwidth	±4.5%
Peak Output Power(Conducted Power Meter)	±1.1dB
Power Spectral Density	±2.0dB
Duty Cycle	±3.5%
Frequency Stability	±0.23KHz



### 3. Test Equipment and Ancillaries Used for Tests

Test Item	Radiated Emissions				
Test Site	Semi Anechoic Room(3M02-NK)				
Instrument	Manufacturer	Model No	Serial No	Calibration Date	Valid Date
Bilog Antenna	Schwarzbeck	VULB9168	275	2022/11/18	2023/11/17
Active Loop Antenna	Schwarzbeck	FMZB 1513	414	2023/02/03	2024/02/02
Horn Antenna	EMCO	3115	31589	2023/03/23	2024/03/22
Horn Antenna	EMCO	3116	31970	2023/03/03	2024/03/02
EMI Receiver	ROHDE & SCHWARZ	ESCI	101423	2023/07/05	2024/07/04
Spectrum Analyzer	ROHDE & SCHWARZ	FSV 40-N	102151	2022/08/19	2023/08/18
Preamplifier	Agilent	8449B	3008A01954	2023/03/08	2024/03/07
Preamplifier	EMC INSTRUMENTS	EMC184045	980065	2022/11/11	2023/11/10
Preamplifier	EM Electronics corp.	EM330	60658	2022/10/04	2023/10/03
High Pass Filter	Warison	WFIL-H3000-18000F-03	WR377WC2B1	2022/09/01	2023/08/31
Cable-4m (9k-3G)	EMEC	RG-223	18274M	2022/07/27	2023/07/26
Cable-3in1 (30M-1G)	HARBOUR INDUSTRIES	LL142	CCE1315	2023/02/25	2024/02/24
Cable-0.5m (1G-40G)	HUBER SUHNER	SUCOFLEX 104	805443/4	2023/03/07	2024/03/06
Cable-3m (1G-40G)	HUBER SUHNER	SUCOFLEX 104	805796/4	2023/03/07	2024/03/06
Cable-8m (1G-26.5G)	WOKEN	WCBA-WCA203 SM	CCE1374	2023/03/07	2024/03/06
Cable-0.5m (30M-40G)	HUBER SUHNER	SUCOFLEX 102	28420/2	2023/03/07	2024/03/06
Cable-3m (10M-40G)	HUBER SUHNER	SF102	804619/2	2022/10/11	2023/10/10
E3	AUDIX	v8.2014-8-6	RK-000529	NA	NA

Test Item	RF Conducted				
Test Site	RFCON01-NK				
Instrument	Manufacturer	Model No	Serial No	Calibration Date	Valid Date
CAX Signal Analyzer	KEYSIGHT	N9000B	MY57100339	2022/11/29	2023/11/28
Power Meter	Anritsu	ML2495A	1224005	2023/03/07	2024/03/06
Power Sensor	Anritsu	MA2411B	1207295	2023/03/07	2024/03/06
Attenuator	KEYSIGHT	8491B	MY39250703	2023/03/08	2024/03/07



Test Item	AC Power Line Conducted Emission				
Test Site	CON02-NK				
Instrument	Manufacturer	Model No	Serial No	Calibration Date	Valid Date
EMI Receiver	ROHDE & SCHWARZ	ESR 7	101906	2023/05/08	2024/05/07
TWO-LINE V-NETWORK	ROHDE & SCHWARZ	ENV216	102185	2022/08/24	2023/08/23
Cable-6m (9k~300M)	NA	EMC5D-BM-B M-6	130606	2023/03/13	2024/03/12
E3	AUDIX	v8.2014-8-6	RK-000531	NA	NA



## 4. Antenna Requirements

### 4.1. Standard Applicable

For intentional device, according to FCC 47 CFR Section 15.203, an intentional radiator shall be designed to ensure that no antenna other than that furnished by the responsible party shall be used with the device.

And according to FCC 47 CFR Section 15.407 (a), if transmitting antennas of directional gain greater than 6dBi are used, the power shall be reduced by the amount in dB that the directional gain of the antenna exceeds 6dBi.

### 4.2. Antenna Construction and Directional Gain

Antenna Type	PIFA Antenna
Antenna Gain	5150-5250MHz: ANT C: 2.51dBi, ANT D: 3.15dBi 5250-5350MHz: ANT C: 2.70dBi, ANT D: 3.37dBi 5470-5725MHz: ANT C: 3.03dBi, ANT D: 3.17dBi 5725-5850MHz: ANT C: 2.68dBi, ANT D: 3.27dBi

<b>Non-beamforming</b>	
5150-5250MHz:	
For Power directional gain= $G_{ant}$	= 3.15 dBi
For PSD directional gain = $10 \log[(10^{G1/20} + 10^{G2/20} + \dots + 10^{GN/20})^2 / N_{ANT}]$	= 5.85 dBi
5250-5350MHz:	
For Power directional gain= $G_{ant}$	= 3.37 dBi
For PSD directional gain = $10 \log[(10^{G1/20} + 10^{G2/20} + \dots + 10^{GN/20})^2 / N_{ANT}]$	= 6.05 dBi
5470-5725MHz:	
For Power directional gain= $G_{ant}$	= 3.17 dBi
For PSD directional gain = $10 \log[(10^{G1/20} + 10^{G2/20} + \dots + 10^{GN/20})^2 / N_{ANT}]$	= 6.11 dBi
5725-5850MHz:	
For Power directional gain= $G_{ant}$	= 3.27 dBi
For PSD directional gain = $10 \log[(10^{G1/20} + 10^{G2/20} + \dots + 10^{GN/20})^2 / N_{ANT}]$	= 5.99 (dBi)

\*MIMO type: Cyclic Delay Diversity (CDD) mode.



<b>Beamforming</b>
<b>5150-5250MHz:</b>
For Power directional gain= $10 \log[(10^{G1/20} + 10^{G2/20} + \dots + 10^{GN/20})^2 / N_{ANT}]$ = 5.85 dBi
For PSD directional gain = $10 \log[(10^{G1/20} + 10^{G2/20} + \dots + 10^{GN/20})^2 / N_{ANT}]$ = 5.85 dBi
<b>5250-5350MHz:</b>
For Power directional gain= $10 \log[(10^{G1/20} + 10^{G2/20} + \dots + 10^{GN/20})^2 / N_{ANT}]$ = 6.05 dBi
For PSD directional gain = $10 \log[(10^{G1/20} + 10^{G2/20} + \dots + 10^{GN/20})^2 / N_{ANT}]$ = 6.05 dBi
<b>5470-5725MHz:</b>
For Power directional gain= $10 \log[(10^{G1/20} + 10^{G2/20} + \dots + 10^{GN/20})^2 / N_{ANT}]$ = 6.11 dBi
For PSD directional gain = $10 \log[(10^{G1/20} + 10^{G2/20} + \dots + 10^{GN/20})^2 / N_{ANT}]$ = 6.11 dBi
<b>5725-5850MHz:</b>
For Power directional gain= $10 \log[(10^{G1/20} + 10^{G2/20} + \dots + 10^{GN/20})^2 / N_{ANT}]$ = 5.99 dBi
For PSD directional gain = $10 \log[(10^{G1/20} + 10^{G2/20} + \dots + 10^{GN/20})^2 / N_{ANT}]$ = 5.99 dBi



## 5. Test of AC Power Line Conducted Emission

### 5.1. Test Limit

Conducted Emissions were measured from 150 kHz to 30 MHz with a bandwidth of 9 KHz, according to the methods defined in ANSI C63.10-2013. The EUT was placed on a nonmetallic stand in a shielded room 0.8 meters above the ground plane. The interface cables and equipment positioning were varied within limits of reasonable applications to determine the position produced maximum conducted emissions.

Frequency (MHz)	Quasi Peak (dB $\mu$ V)	Average (dB $\mu$ V)
0.15 – 0.5	66-56*	56-46*
0.5 – 5.0	56	46
5.0 – 30.0	60	50

\*Decreases with the logarithm of the frequency.

### 5.2. Test Procedures

- The EUT was placed 0.4 meter from the conducting wall of the shielding room was kept at least 80 centimeters from any other grounded conducting surface.
- Connect EUT to the power mains through a line impedance stabilization network (LISN).
- All the support units are connecting to the other LISN.
- The LISN provides 50 ohm coupling impedance for the measuring instrument.
- The FCC states that a 50 ohm, 50 micro-Henry LISN should be used.
- Both sides of AC line were checked for maximum conducted interference.
- The frequency range from 150 kHz to 30 MHz was searched.
- Set the test-receiver system to Peak Detect Function and Specified Bandwidth with Maximum Hold Mode.





### 5.3. Typical Test Setup

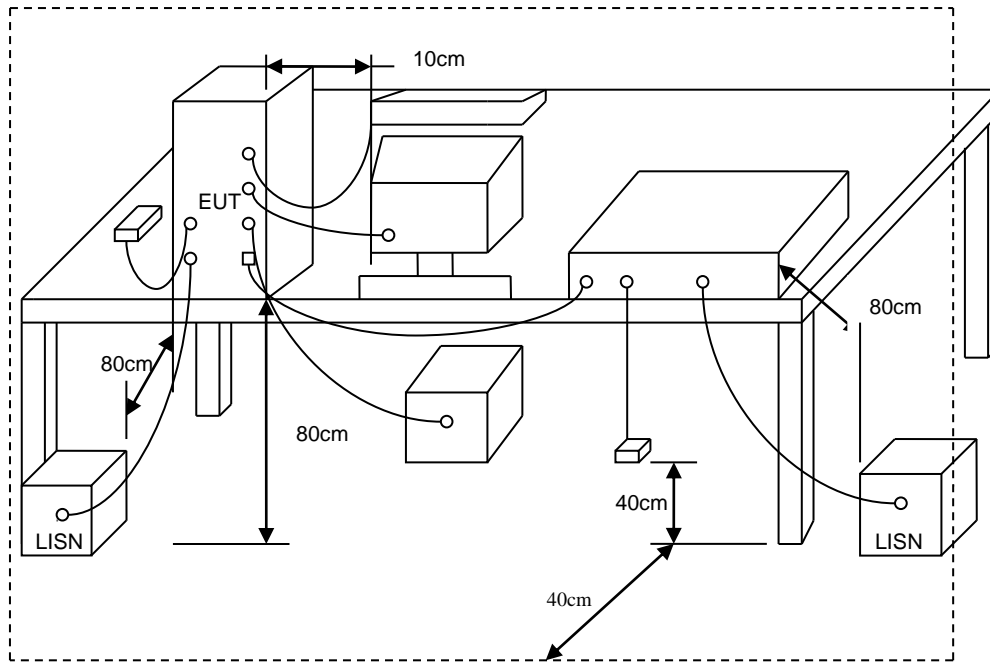



5.4. Test Result and Data

Power	: AC 120V / 60Hz from Adapter	Pol/Phase	: LINE
Test Mode	: Mode 3, 11ax HE20 CH165		

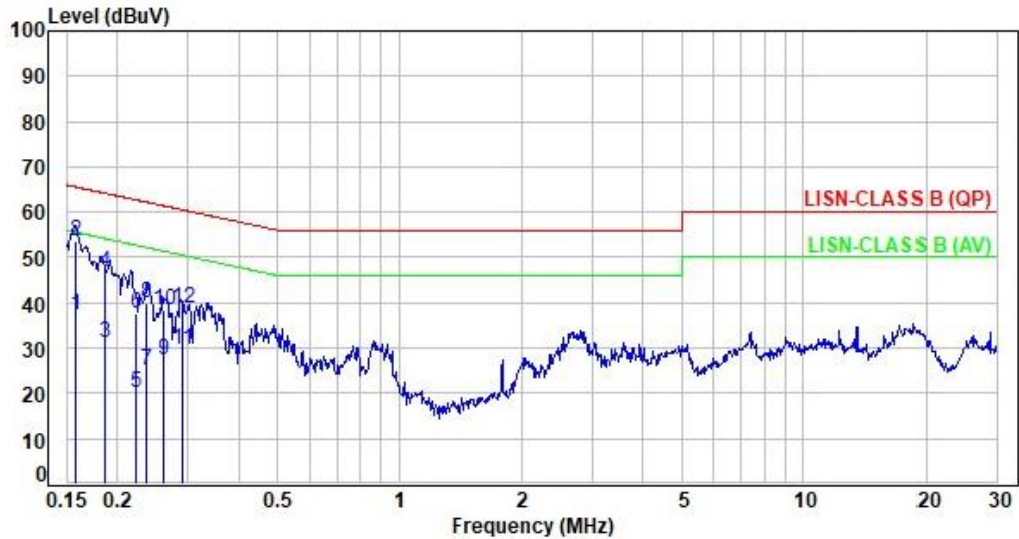

No.	Frequency (MHz)	Factor (dB)	Reading (dBuV)	Level (dBuV)	Limit (dBuV)	Margin (dB)	Detector	P/F
1	0.16	9.65	27.61	37.26	55.56	-18.30	Average	P
2	0.16	9.65	43.82	53.47	65.56	-12.09	QP	P
3	0.19	9.64	21.57	31.21	54.21	-23.00	Average	P
4	0.19	9.64	36.97	46.61	64.21	-17.60	QP	P
5	0.22	9.64	10.51	20.15	52.72	-32.57	Average	P
6	0.22	9.64	28.01	37.65	62.72	-25.07	QP	P
7	0.24	9.64	15.27	24.91	52.22	-27.31	Average	P
8	0.24	9.64	30.27	39.91	62.22	-22.31	QP	P
9	0.26	9.64	17.67	27.31	51.39	-24.08	Average	P
10	0.26	9.64	28.74	38.38	61.39	-23.01	QP	P
11	0.29	9.66	20.01	29.67	50.54	-20.87	Average	P
12	0.29	9.66	29.06	38.72	60.54	-21.82	QP	P

Note: Level=Reading+Factor  
 Margin=Level-Limit  
 Factor=(LISN or ISN or Current Probe)Factor + Cable Loss



Power	: AC 120V / 60Hz from Adapter	Pol/Phase	: NEUTRAL
Test Mode	: Mode 3, 11ax HE20 CH165		

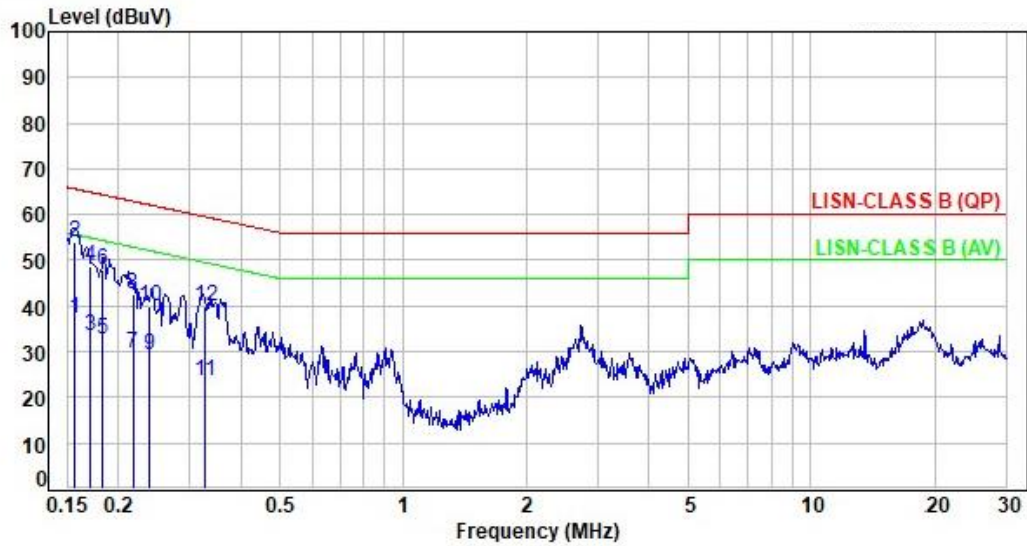

No.	Frequency (MHz)	Factor (dB)	Reading (dBuV)	Level (dBuV)	Limit (dBuV)	Margin (dB)	Detector	P/F
1	0.16	9.66	27.79	37.45	55.63	-18.18	Average	P
2	0.16	9.66	44.16	53.82	65.63	-11.81	QP	P
3	0.17	9.66	23.71	33.37	54.91	-21.54	Average	P
4	0.17	9.66	39.12	48.78	64.91	-16.13	QP	P
5	0.18	9.65	22.87	32.52	54.38	-21.86	Average	P
6	0.18	9.65	38.08	47.73	64.38	-16.65	QP	P
7	0.22	9.65	20.19	29.84	52.92	-23.08	Average	P
8	0.22	9.65	33.12	42.77	62.92	-20.15	QP	P
9	0.24	9.65	19.48	29.13	52.15	-23.02	Average	P
10	0.24	9.65	30.42	40.07	62.15	-22.08	QP	P
11	0.33	9.66	13.86	23.52	49.53	-26.01	Average	P
12	0.33	9.66	30.42	40.08	59.53	-19.45	QP	P

Note: Level=Reading+Factor  
 Margin=Level-Limit  
 Factor=(LISN or ISN or Current Probe)Factor + Cable Loss



## 6. Test of Spurious Emission (Radiated)

### 6.1. Test Limit

Undesirable emission limits. Except as shown in paragraph (b)(7) of this section, the maximum emissions outside of the frequency bands of operation shall be attenuated in accordance with the following limits:

- (1) For transmitters operating in the 5.15-5.25 GHz band: All emissions outside of the 5.15-5.35 GHz band shall not exceed an e.i.r.p. of  $-27$  dBm/MHz.
- (2) For transmitters operating in the 5.25-5.35 GHz band: All emissions outside of the 5.15-5.35 GHz band shall not exceed an e.i.r.p. of  $-27$  dBm/MHz.
- (3) For transmitters operating in the 5.47-5.725 GHz band: All emissions outside of the 5.47-5.725 GHz band shall not exceed an e.i.r.p. of  $-27$  dBm/MHz.
- (4) For transmitters operating in the 5.725-5.85 GHz band:  
All emissions shall be limited to a level of  $-27$  dBm/MHz at 75 MHz or more above or below the band edge increasing linearly to 10 dBm/MHz at 25 MHz above or below the band edge, and from 25MHz above or below the band edge increasing linearly to a level of 15.6 dBm/MHz at 5 MHz above or below the band edge, and from 5 MHz above or below the band edge increasing linearly to a level of 27dBm/MHz at the band edge.
- (5) The emission measurements shall be performed using a minimum resolution bandwidth of 1 MHz. A lower resolution bandwidth may be employed near the band edge, when necessary, provided the measured energy is integrated to show the total power over 1 MHz.
- (6) Unwanted emissions below 1 GHz must comply with the general field strength limits set forth in §15.209. Further, any U-NII devices using an AC power line are required to comply also with the conducted limits set forth in §15.207.
- (7) The provisions of §15.205 apply to intentional radiators operating under this section.
- (8) When measuring the emission limits, the nominal carrier frequency shall be adjusted as close to the upper and lower frequency band edges as the design of the equipment permits.



## 6.2. Test Procedures

- a. The EUT was placed on a rotatable table top 0.8 meter above ground.
- b. The EUT was set 3 meters from the interference receiving antenna which was mounted on the top of a variable height antenna tower.
- c. The table was rotated 360 degrees to determine the position of the highest radiation.
- d. The antenna is a broadband antenna and its height is varied between one meter and four meters above ground to find the maximum value of the field strength both horizontal polarization and vertical polarization of the antenna are set to make the measurement.
- e. For each suspected emission the EUT was arranged to its worst case and then tune the antenna tower (from 1 M to 4 M) and turn table (from 0 degree to 360 degrees) to find the maximum reading.
- f. Set the test-receiver system to Peak or CISPR quasi-peak Detect Function and specified bandwidth with Maximum Hold Mode.
- g. If the emission level of the EUT in peak mode was 3 dB lower than the limit specified, then testing will be stopped and peak values of EUT will be reported, otherwise, the emissions which do not have 3 dB margin will be repeated one by one using the quasi-peak method and reported.
- h. For testing above 1GHz, the emission level of the EUT in peak mode was 20dB lower than average limit (that means the emission level in peak mode also complies with the limit in average mode), then testing will be stopped and peak values of EUT will be reported, otherwise, the emissions will be measured in average mode again and reported.
- i. "Cone of radiation" has been considered to be 3dB bandwidth of the measurement antenna.

Note:

- 1.The supporting fixture shall permit orientation of the EUT in each of three orthogonal axis positions such that emissions from the EUT are maximized.  
(X-AXIS is the worst.)
- 2.Due to the test software function limit the operation band setting(200dBuV/m). There's no corresponding limitation in the actual test item.



### 6.3. Typical Test Setup

Below 30MHz test setup

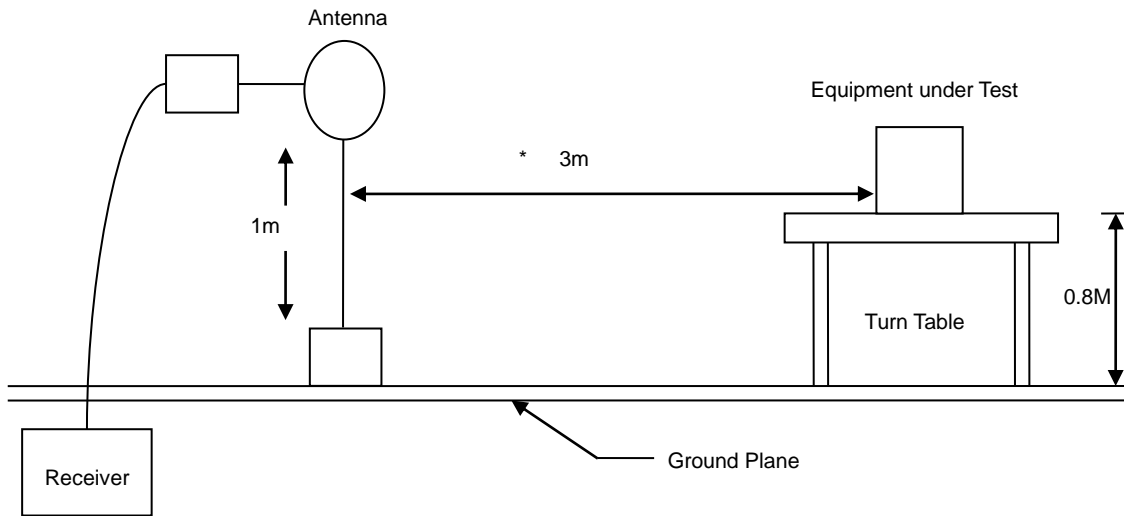

30MHz- 1GHz Test Setup

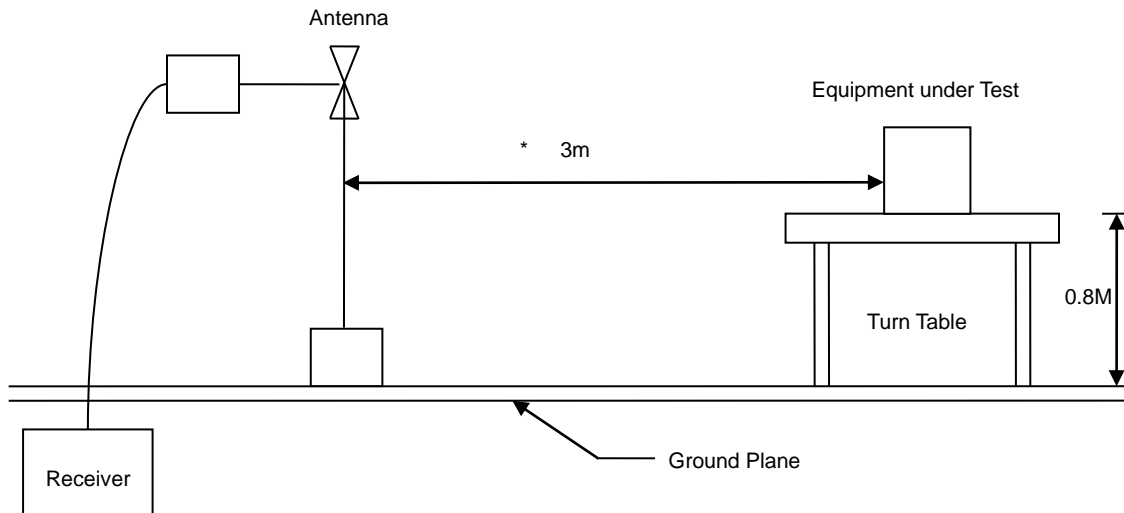

Above 1GHz Test Setup

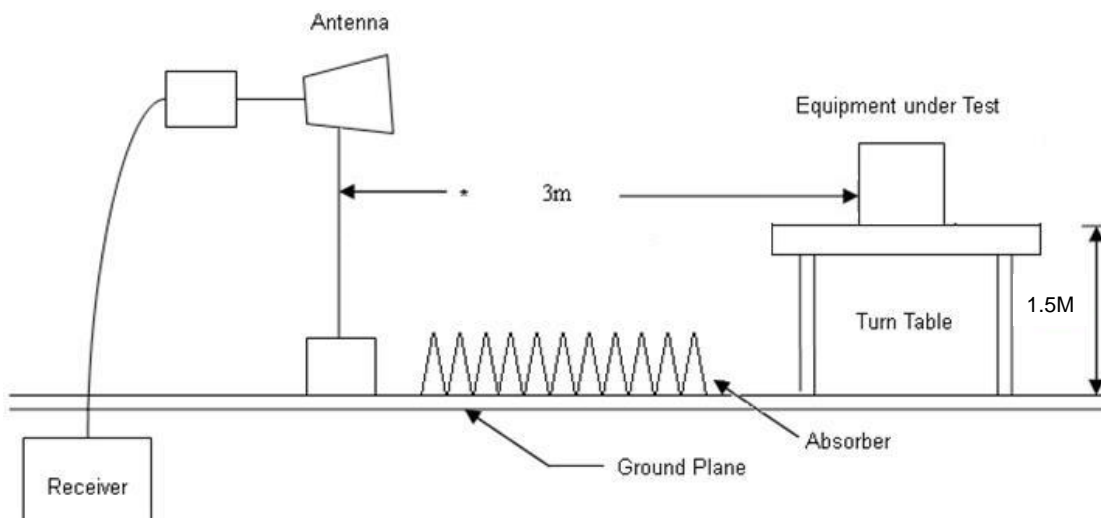



### 6.4. Test Result and Data (9kHz ~ 30MHz)

The 9kHz - 30MHz spurious emission is under limit 20dB more.

### 6.5. Test Result and Data (30MHz ~ 1GHz)

Power	: AC 120V / 60Hz from Adapter	Pol/Phase	: VERTICAL
Test Mode	: Mode 3, 11ax HE20 CH157		:

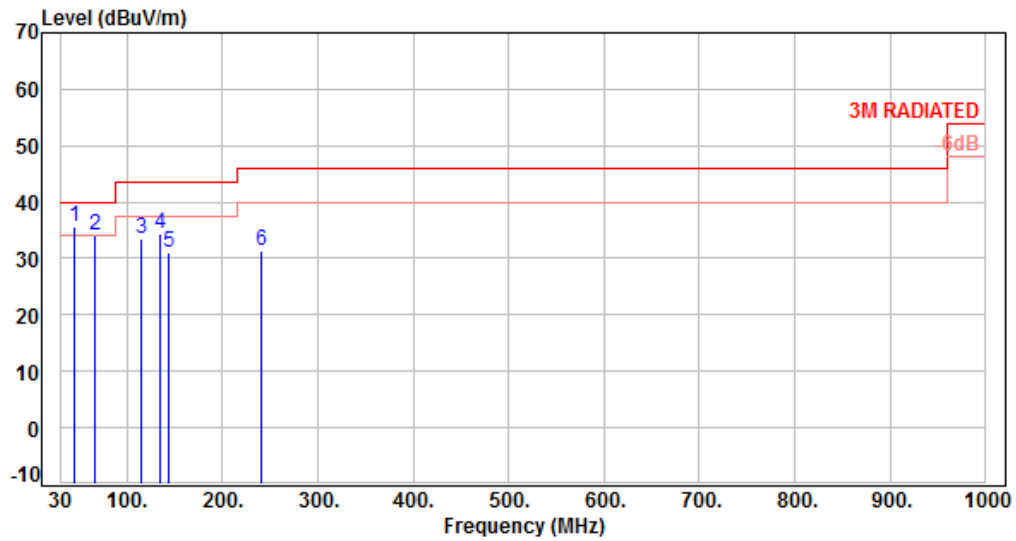

No.	Frequency (MHz)	Factor (dB)	Reading (dBuV)	Level (dBuV/m)	Limit (dBuV/m)	Margin (dB)	Detector	Height (cm)	Azimuth (deg)	P/F
1	45.52	-10.26	45.88	35.62	40.00	-4.38	Peak	400	360	P
2	66.86	-12.81	46.79	33.98	40.00	-6.02	Peak	400	360	P
3	115.36	-13.83	47.25	33.42	43.50	-10.08	Peak	400	360	P
4	134.76	-12.03	46.54	34.51	43.50	-8.99	Peak	400	360	P
5	144.46	-10.91	41.93	31.02	43.50	-12.48	Peak	400	360	P
6	241.46	-12.41	43.64	31.23	46.00	-14.77	Peak	400	360	P

Note: Level=Reading+Factor  
Margin=Level-Limit  
Factor=Antenna Factor + cable loss - Amplifier Factor



Power	: AC 120V / 60Hz from Adapter	Pol/Phase	: HORIZONTAL
Test Mode	: Mode 3, 11ax HE20 CH157		

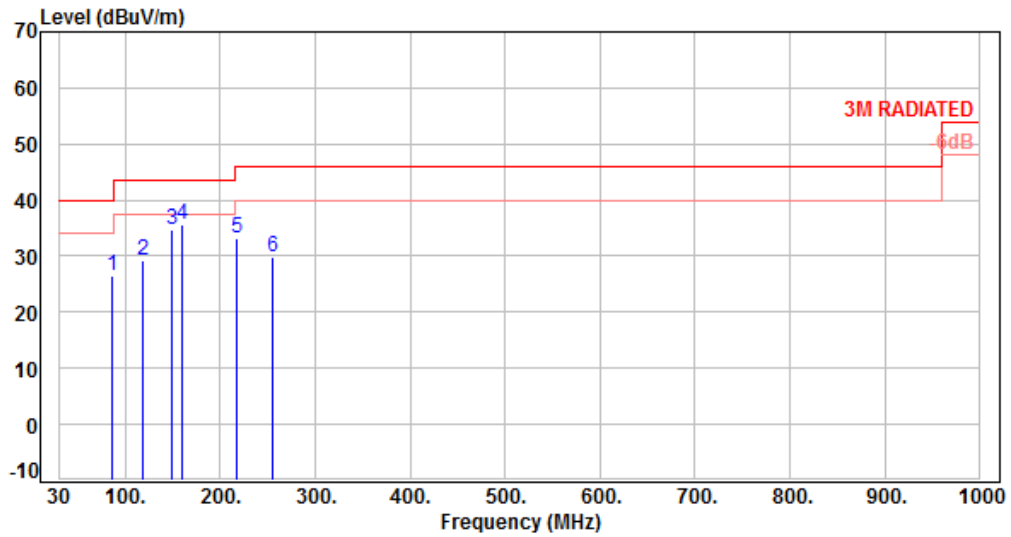

No.	Frequency (MHz)	Factor (dB)	Reading (dBuV)	Level (dBuV/m)	Limit (dBuV/m)	Margin (dB)	Detector	Height (cm)	Azimuth (deg)	P/F
1	86.26	-16.87	43.39	26.52	40.00	-13.48	Peak	400	360	P
2	119.24	-13.66	42.96	29.30	43.50	-14.20	Peak	400	360	P
3	148.34	-10.86	45.50	34.64	43.50	-8.86	Peak	400	360	P
4	159.98	-10.90	46.63	35.73	43.50	-7.77	Peak	400	360	P
5	218.18	-13.76	46.98	33.22	46.00	-12.78	Peak	400	360	P
6	255.04	-11.90	41.74	29.84	46.00	-16.16	Peak	400	360	P

Note: Level=Reading+Factor  
Margin=Level-Limit  
Factor=Antenna Factor + cable loss - Amplifier Factor





### 6.6. Test Result and Data (1GHz ~ 40GHz)

Power	: AC 120V / 60Hz from Adapter	Pol/Phase	: VERTICAL
Test Mode	: Mode 1, Band 1, CH36		

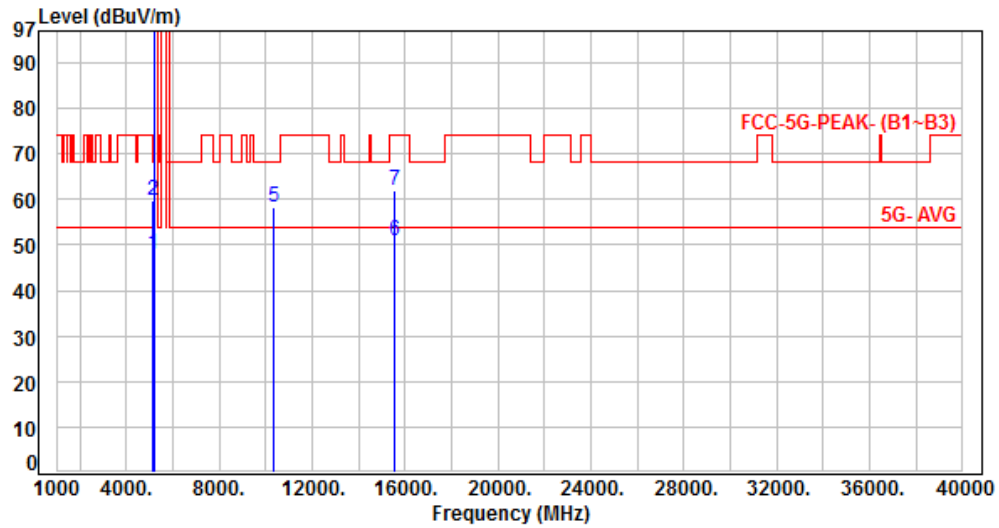

No.	Frequency (MHz)	Factor (dB)	Reading (dBuV)	Level (dBuV/m)	Limit (dBuV/m)	Margin (dB)	Detector	Height (cm)	Azimuth (deg)	P/F
1	5150.00	6.70	41.10	47.80	54.00	-6.20	Average	100	5	P
2	5150.00	6.70	53.04	59.74	74.00	-14.26	Peak	100	5	P
3	5180.00	6.85	95.63	102.48	200.00	-97.52	Average	100	5	P
4	5180.00	6.85	104.93	111.78	200.00	-88.22	Peak	100	5	P
5	10360.00	15.84	42.40	58.24	68.20	-9.96	Peak	100	349	P
6	15540.00	19.60	31.18	50.78	54.00	-3.22	Average	100	164	P
7	15540.00	19.60	42.45	62.05	74.00	-11.95	Peak	100	164	P

Note: Level=Reading+Factor  
Margin=Level-Limit  
Factor=Antenna Factor + cable loss - Amplifier Factor



Power	: AC 120V / 60Hz from Adapter	Pol/Phase	: HORIZONTAL
Test Mode	: Mode 1, Band 1, CH36		

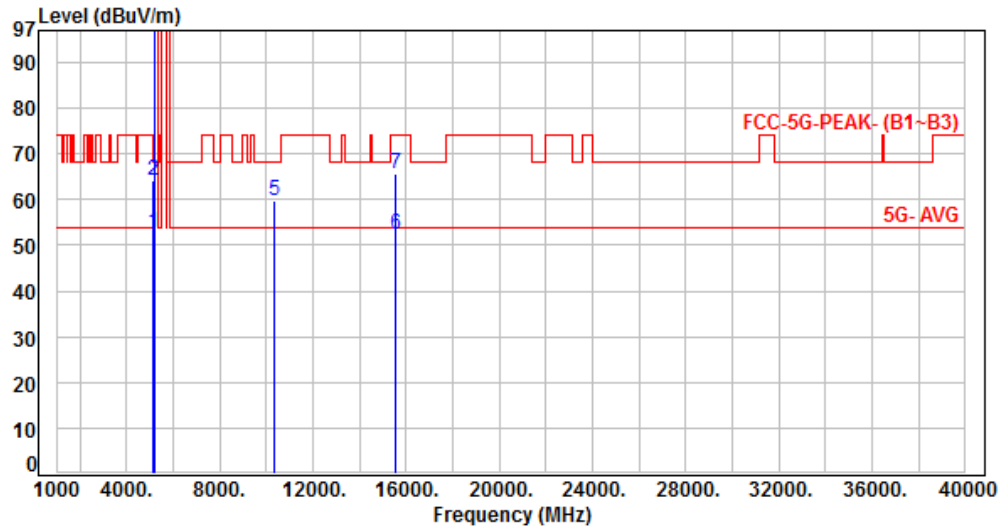

No.	Frequency (MHz)	Factor (dB)	Reading (dBuV)	Level (dBuV/m)	Limit (dBuV/m)	Margin (dB)	Detector	Height (cm)	Azimuth (deg)	P/F
1	5150.00	6.70	45.98	52.68	54.00	-1.32	Average	100	22	P
2	5150.00	6.70	57.37	64.07	74.00	-9.93	Peak	100	22	P
3	5180.00	6.85	99.11	105.96	200.00	-94.04	Average	100	22	P
4	5180.00	6.85	108.71	115.56	200.00	-84.44	Peak	100	22	P
5	10360.00	15.84	43.82	59.66	68.20	-8.54	Peak	100	86	P
6	15540.00	19.60	32.77	52.37	54.00	-1.63	Average	198	75	P
7	15540.00	19.60	45.87	65.47	74.00	-8.53	Peak	198	75	P

Note: Level=Reading+Factor  
Margin=Level-Limit  
Factor=Antenna Factor + cable loss - Amplifier Factor



Power	: AC 120V / 60Hz from Adapter	Pol/Phase	: VERTICAL
Test Mode	: Mode 1, Band 1, CH40		

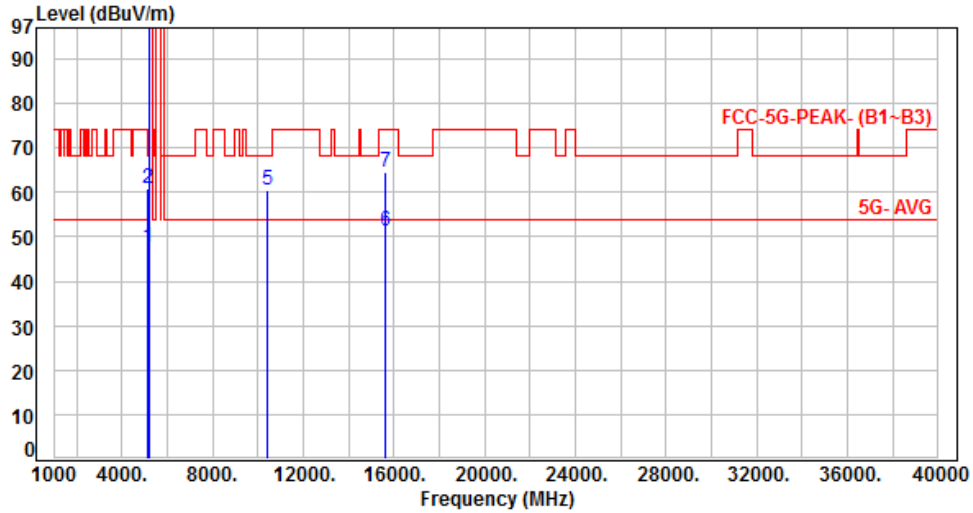

No.	Frequency (MHz)	Factor (dB)	Reading (dBuV)	Level (dBuV/m)	Limit (dBuV/m)	Margin (dB)	Detector	Height (cm)	Azimuth (deg)	P/F
1	5150.00	6.70	40.82	47.52	54.00	-6.48	Average	100	358	P
2	5150.00	6.70	54.04	60.74	74.00	-13.26	Peak	100	358	P
3	5200.00	6.95	96.77	103.72	200.00	-96.28	Average	100	358	P
4	5200.00	6.95	106.20	113.15	200.00	-86.85	Peak	100	358	P
5	10400.00	15.75	44.57	60.32	68.20	-7.88	Peak	204	349	P
6	15600.00	19.55	31.79	51.34	54.00	-2.66	Average	297	49	P
7	15600.00	19.55	45.05	64.60	74.00	-9.40	Peak	297	49	P

Note: Level=Reading+Factor  
 Margin=Level-Limit  
 Factor=Antenna Factor + cable loss - Amplifier Factor



Power	: AC 120V / 60Hz from Adapter	Pol/Phase	: HORIZONTAL
Test Mode	: Mode 1, Band 1, CH40		

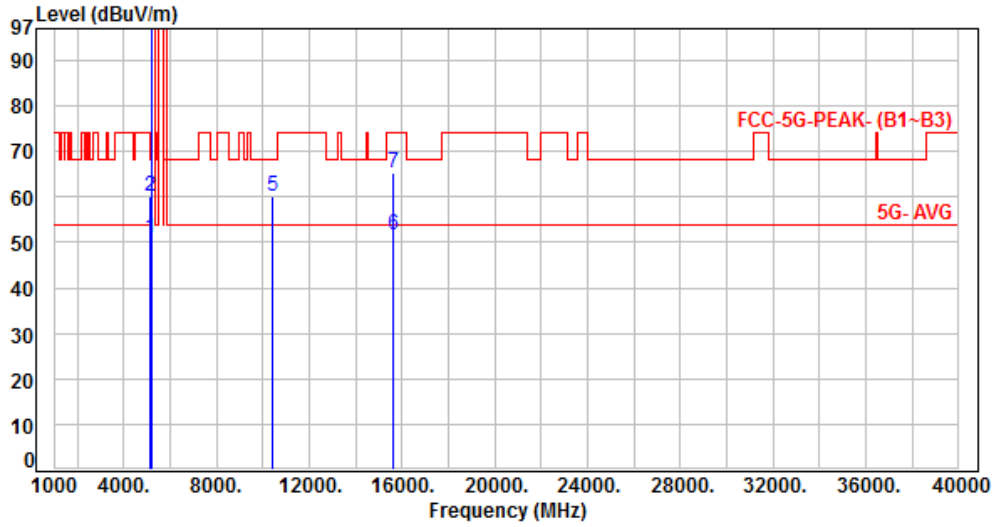

No.	Frequency (MHz)	Factor (dB)	Reading (dBuV)	Level (dBuV/m)	Limit (dBuV/m)	Margin (dB)	Detector	Height (cm)	Azimuth (deg)	P/F
1	5150.00	6.70	44.37	51.07	54.00	-2.93	Average	100	52	P
2	5150.00	6.70	53.38	60.08	74.00	-13.92	Peak	100	52	P
3	5200.00	6.95	100.11	107.06	200.00	-92.94	Average	100	52	P
4	5200.00	6.95	109.62	116.57	200.00	-83.43	Peak	100	52	P
5	10400.00	15.75	44.48	60.23	68.20	-7.97	Peak	136	23	P
6	15600.00	19.55	32.03	51.58	54.00	-2.42	Average	198	292	P
7	15600.00	19.55	45.76	65.31	74.00	-8.69	Peak	198	292	P

Note: Level=Reading+Factor  
Margin=Level-Limit  
Factor=Antenna Factor + cable loss - Amplifier Factor



Power	: AC 120V / 60Hz from Adapter	Pol/Phase	: VERTICAL
Test Mode	: Mode 1, Band 1, CH48		

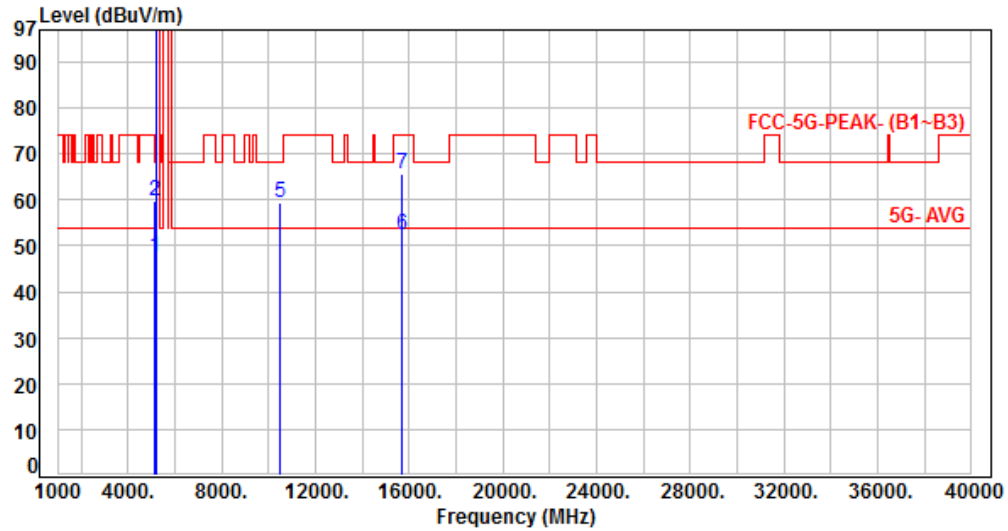

No.	Frequency (MHz)	Factor (dB)	Reading (dBuV)	Level (dBuV/m)	Limit (dBuV/m)	Margin (dB)	Detector	Height (cm)	Azimuth (deg)	P/F
1	5150.00	6.70	40.78	47.48	54.00	-6.52	Average	106	358	P
2	5150.00	6.70	53.14	59.84	74.00	-14.16	Peak	106	358	P
3	5240.00	7.00	96.32	103.32	200.00	-96.68	Average	106	358	P
4	5240.00	7.00	105.47	112.47	200.00	-87.53	Peak	106	358	P
5	10480.00	15.88	43.34	59.22	68.20	-8.98	Peak	208	0	P
6	15720.00	19.16	33.06	52.22	54.00	-1.78	Average	267	50	P
7	15720.00	19.16	46.42	65.58	74.00	-8.42	Peak	267	50	P

Note: Level=Reading+Factor  
Margin=Level-Limit  
Factor=Antenna Factor + cable loss - Amplifier Factor



Power	: AC 120V / 60Hz from Adapter	Pol/Phase	: HORIZONTAL
Test Mode	: Mode 1, Band 1, CH48		

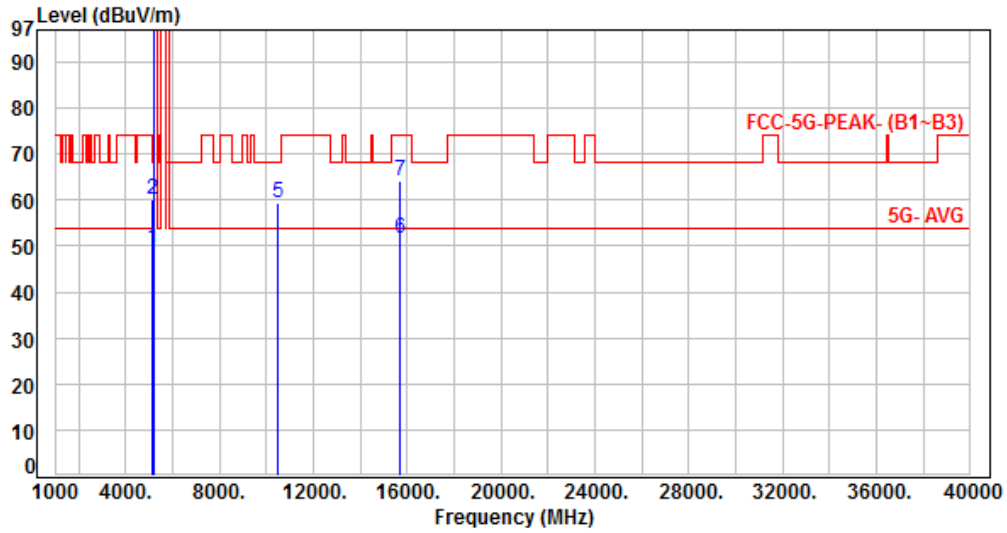

No.	Frequency (MHz)	Factor (dB)	Reading (dBuV)	Level (dBuV/m)	Limit (dBuV/m)	Margin (dB)	Detector	Height (cm)	Azimuth (deg)	P/F
1	5150.00	6.70	42.75	49.45	54.00	-4.55	Average	100	50	P
2	5150.00	6.70	53.58	60.28	74.00	-13.72	Peak	100	50	P
3	5240.00	7.00	99.50	106.50	200.00	-93.50	Average	100	50	P
4	5240.00	7.00	109.12	116.12	200.00	-83.88	Peak	100	50	P
5	10480.00	15.88	43.60	59.48	68.20	-8.72	Peak	133	40	P
6	15720.00	19.16	32.32	51.48	54.00	-2.52	Average	100	285	P
7	15720.00	19.16	44.94	64.10	74.00	-9.90	Peak	100	285	P

Note: Level=Reading+Factor  
Margin=Level-Limit  
Factor=Antenna Factor + cable loss - Amplifier Factor



Power	: AC 120V / 60Hz from Adapter	Pol/Phase	: VERTICAL
Test Mode	: Mode 1, Band 1, CH36		

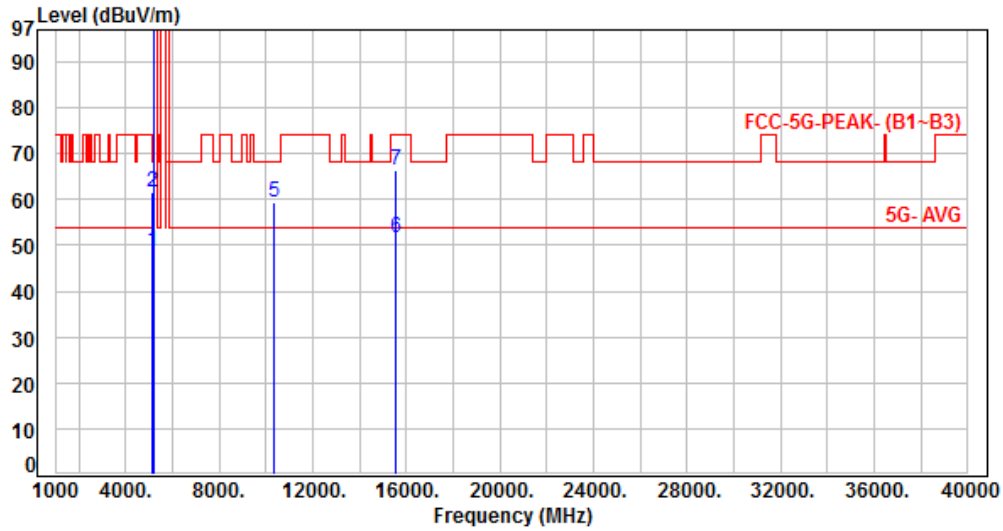

No.	Frequency (MHz)	Factor (dB)	Reading (dBuV)	Level (dBuV/m)	Limit (dBuV/m)	Margin (dB)	Detector	Height (cm)	Azimuth (deg)	P/F
1	5150.00	6.70	41.99	48.69	54.00	-5.31	Average	100	0	P
2	5150.00	6.70	54.74	61.44	74.00	-12.56	Peak	100	0	P
3	5180.00	6.85	93.77	100.62	200.00	-99.38	Average	100	0	P
4	5180.00	6.85	107.45	114.30	200.00	-85.70	Peak	100	0	P
5	10360.00	15.84	43.62	59.46	68.20	-8.74	Peak	129	330	P
6	15540.00	19.60	31.92	51.52	54.00	-2.48	Average	188	49	P
7	15540.00	19.60	46.87	66.47	74.00	-7.53	Peak	188	49	P

Note: Level=Reading+Factor  
 Margin=Level-Limit  
 Factor=Antenna Factor + cable loss - Amplifier Factor



Power	: AC 120V / 60Hz from Adapter	Pol/Phase	: HORIZONTAL
Test Mode	: Mode 6, Band 1, CH36		

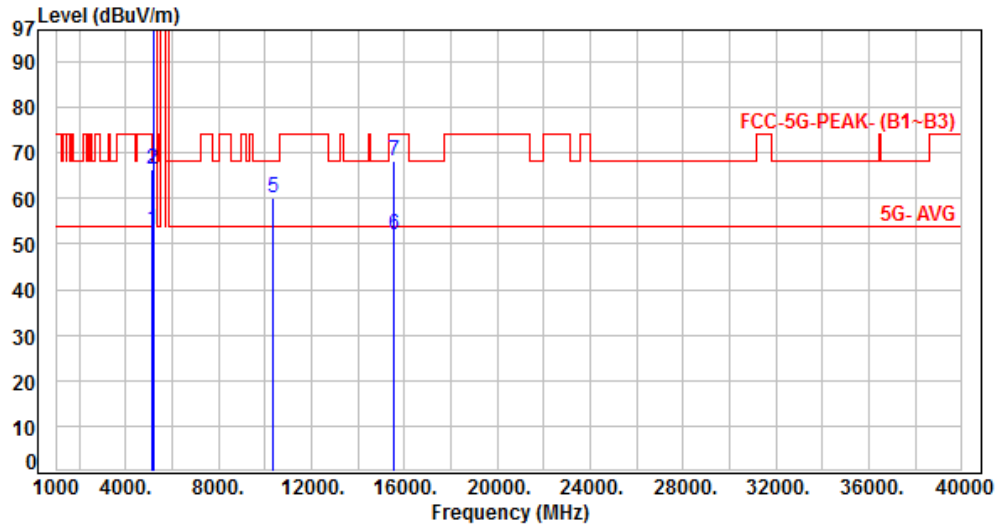

No.	Frequency (MHz)	Factor (dB)	Reading (dBuV)	Level (dBuV/m)	Limit (dBuV/m)	Margin (dB)	Detector	Height (cm)	Azimuth (deg)	P/F
1	5150.00	6.70	46.29	52.99	54.00	-1.01	Average	100	48	P
2	5150.00	6.70	59.57	66.27	74.00	-7.73	Peak	100	48	P
3	5180.00	6.85	99.20	106.05	200.00	-93.95	Average	100	48	P
4	5180.00	6.85	112.28	119.13	200.00	-80.87	Peak	100	48	P
5	10360.00	15.84	44.26	60.10	68.20	-8.10	Peak	139	42	P
6	15540.00	19.60	32.22	51.82	54.00	-2.18	Average	198	75	P
7	15540.00	19.60	48.54	68.14	74.00	-5.86	Peak	198	75	P

Note: Level=Reading+Factor

Margin=Level-Limit

Factor=Antenna Factor + cable loss - Amplifier Factor





Power	: AC 120V / 60Hz from Adapter	Pol/Phase	: VERTICAL
Test Mode	: Mode 6, Band 1, CH40		

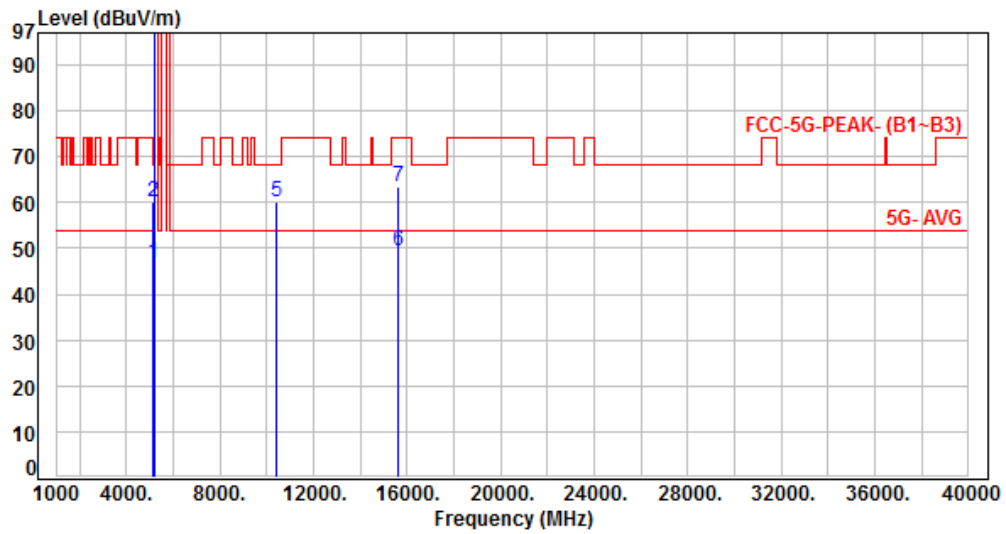

No.	Frequency (MHz)	Factor (dB)	Reading (dBuV)	Level (dBuV/m)	Limit (dBuV/m)	Margin (dB)	Detector	Height (cm)	Azimuth (deg)	P/F
1	5150.00	6.70	40.21	46.91	54.00	-7.09	Average	100	0	P
2	5150.00	6.70	53.58	60.28	74.00	-13.72	Peak	100	0	P
3	5200.00	6.95	94.77	101.72	200.00	-98.28	Average	100	0	P
4	5200.00	6.95	108.44	115.39	200.00	-84.61	Peak	100	0	P
5	10400.00	15.75	44.31	60.06	68.20	-8.14	Peak	226	0	P
6	15600.00	19.55	29.83	49.38	54.00	-4.62	Average	100	118	P
7	15600.00	19.55	43.87	63.42	74.00	-10.58	Peak	100	118	P

Note: Level=Reading+Factor  
 Margin=Level-Limit  
 Factor=Antenna Factor + cable loss - Amplifier Factor



Power	: AC 120V / 60Hz from Adapter	Pol/Phase	: HORIZONTAL
Test Mode	: Mode 6, Band 1, CH40		

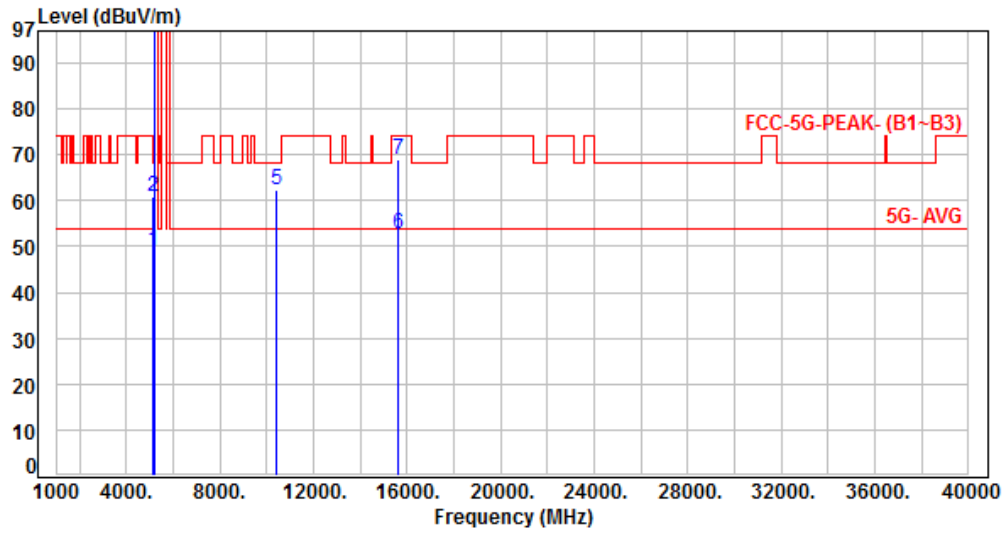

No.	Frequency (MHz)	Factor (dB)	Reading (dBuV)	Level (dBuV/m)	Limit (dBuV/m)	Margin (dB)	Detector	Height (cm)	Azimuth (deg)	P/F
1	5150.00	6.70	42.35	49.05	54.00	-4.95	Average	100	49	P
2	5150.00	6.70	54.32	61.02	74.00	-12.98	Peak	100	49	P
3	5200.00	6.95	99.65	106.60	200.00	-93.40	Average	100	49	P
4	5200.00	6.95	113.14	120.09	200.00	-79.91	Peak	100	49	P
5	10400.00	15.75	46.50	62.25	68.20	-5.95	Peak	191	35	P
6	15600.00	19.55	33.23	52.78	54.00	-1.22	Average	201	72	P
7	15600.00	19.55	49.29	68.84	74.00	-5.16	Peak	201	72	P

Note: Level=Reading+Factor  
 Margin=Level-Limit  
 Factor=Antenna Factor + cable loss - Amplifier Factor



Power	: AC 120V / 60Hz from Adapter	Pol/Phase	: VERTICAL
Test Mode	: Mode 6, Band 1, CH48		

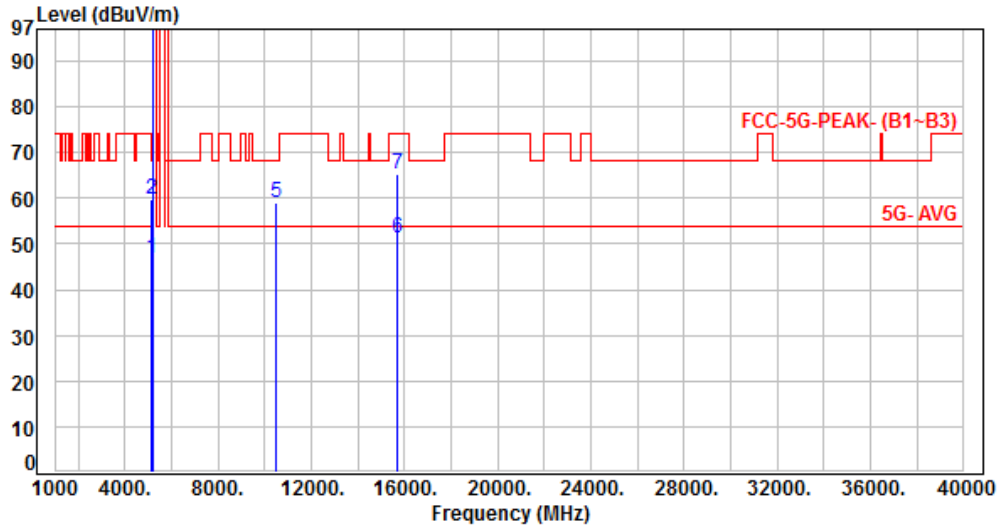

No.	Frequency (MHz)	Factor (dB)	Reading (dBuV)	Level (dBuV/m)	Limit (dBuV/m)	Margin (dB)	Detector	Height (cm)	Azimuth (deg)	P/F
1	5150.00	6.70	40.30	47.00	54.00	-7.00	Average	100	333	P
2	5150.00	6.70	52.89	59.59	74.00	-14.41	Peak	100	333	P
3	5240.00	7.00	97.69	104.69	200.00	-95.31	Average	100	333	P
4	5240.00	7.00	110.89	117.89	200.00	-82.11	Peak	100	333	P
5	10480.00	15.88	43.18	59.06	68.20	-9.14	Peak	100	360	P
6	15720.00	19.16	32.16	51.32	54.00	-2.68	Average	313	312	P
7	15720.00	19.16	46.09	65.25	74.00	-8.75	Peak	313	312	P

Note: Level=Reading+Factor  
Margin=Level-Limit  
Factor=Antenna Factor + cable loss - Amplifier Factor



Power	: AC 120V / 60Hz from Adapter	Pol/Phase	: HORIZONTAL
Test Mode	: Mode 6, Band 1, CH48		:

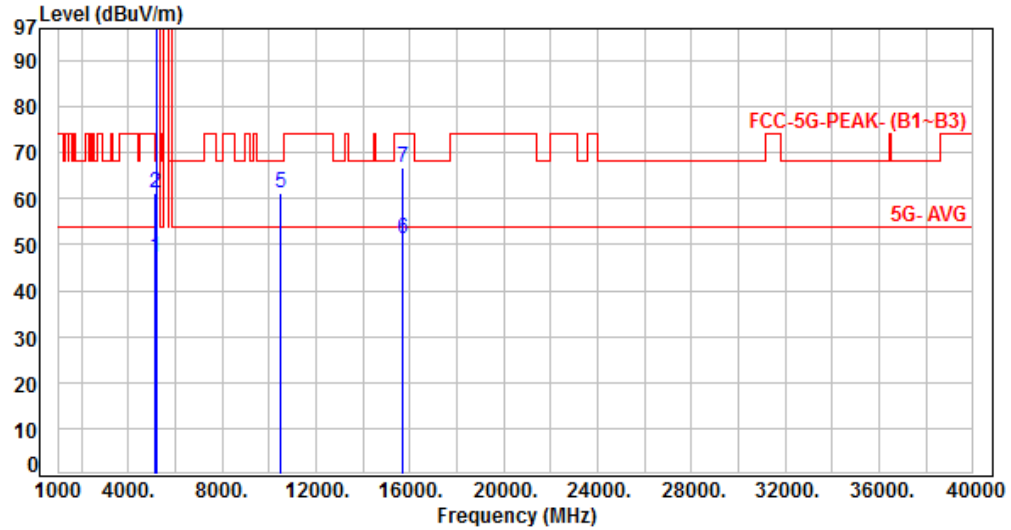

No.	Frequency (MHz)	Factor (dB)	Reading (dBuV)	Level (dBuV/m)	Limit (dBuV/m)	Margin (dB)	Detector	Height (cm)	Azimuth (deg)	P/F
1	5150.00	6.70	40.33	47.03	54.00	-6.97	Average	236	295	P
2	5150.00	6.70	54.52	61.22	74.00	-12.78	Peak	236	295	P
3	5240.00	7.00	100.29	107.29	200.00	-92.71	Average	236	295	P
4	5240.00	7.00	113.58	120.58	200.00	-79.42	Peak	236	295	P
5	10480.00	15.88	45.16	61.04	68.20	-7.16	Peak	100	43	P
6	15720.00	19.16	32.29	51.45	54.00	-2.55	Average	135	110	P
7	15720.00	19.16	47.55	66.71	74.00	-7.29	Peak	135	110	P

Note: Level=Reading+Factor  
Margin=Level-Limit  
Factor=Antenna Factor + cable loss - Amplifier Factor



Power	: AC 120V / 60Hz from Adapter	Pol/Phase	: VERTICAL
Test Mode	: Mode 7, Band 1, CH38		

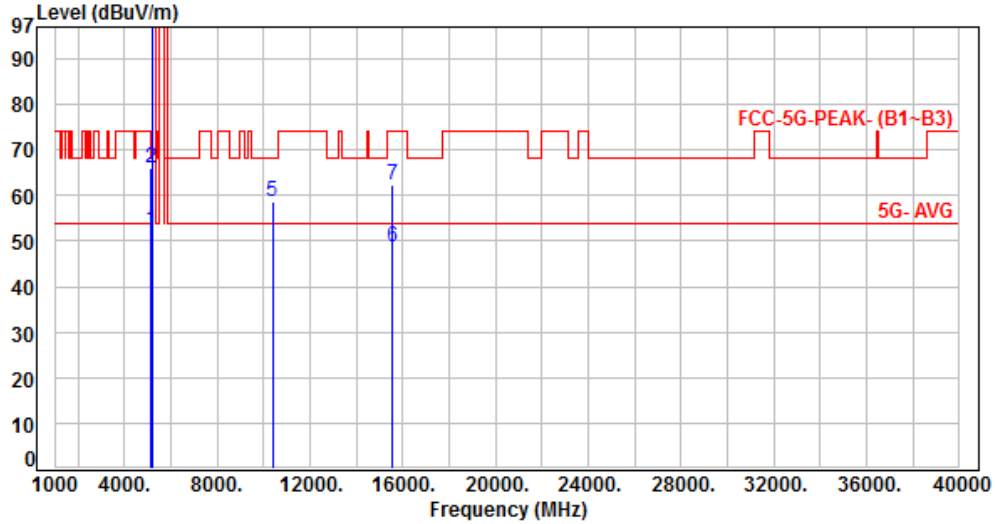

No.	Frequency (MHz)	Factor (dB)	Reading (dBuV)	Level (dBuV/m)	Limit (dBuV/m)	Margin (dB)	Detector	Height (cm)	Azimuth (deg)	P/F
1	5150.00	6.70	45.59	52.29	54.00	-1.71	Average	100	5	P
2	5150.00	6.70	59.19	65.89	74.00	-8.11	Peak	100	5	P
3	5190.00	6.90	90.51	97.41	200.00	-102.59	Average	100	5	P
4	5190.00	6.90	102.40	109.30	200.00	-90.70	Peak	100	5	P
5	10380.00	15.80	43.02	58.82	68.20	-9.38	Peak	100	225	P
6	15570.00	19.56	29.10	48.66	54.00	-5.34	Average	100	324	P
7	15570.00	19.56	42.83	62.39	74.00	-11.61	Peak	100	324	P

Note: Level=Reading+Factor  
 Margin=Level-Limit  
 Factor=Antenna Factor + cable loss - Amplifier Factor



Power	: AC 120V / 60Hz from Adapter	Pol/Phase	: HORIZONTAL
Test Mode	: Mode 7, Band 1, CH38		:

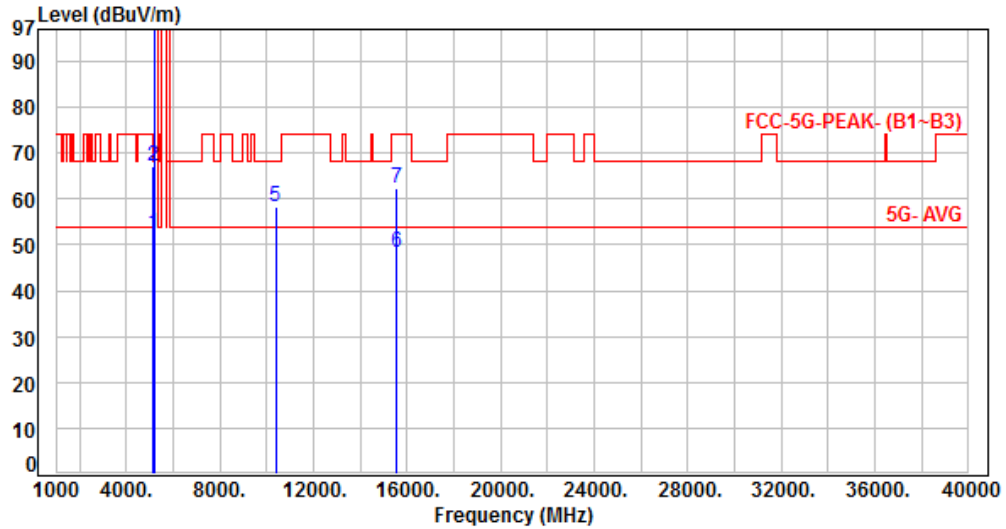

No.	Frequency (MHz)	Factor (dB)	Reading (dBuV)	Level (dBuV/m)	Limit (dBuV/m)	Margin (dB)	Detector	Height (cm)	Azimuth (deg)	P/F
1	5150.00	6.70	45.69	52.39	54.00	-1.61	Average	241	293	P
2	5150.00	6.70	60.25	66.95	74.00	-7.05	Peak	241	293	P
3	5190.00	6.90	92.52	99.42	200.00	-100.58	Average	241	293	P
4	5190.00	6.90	105.67	112.57	200.00	-87.43	Peak	241	293	P
5	10380.00	15.80	42.33	58.13	68.20	-10.07	Peak	100	344	P
6	15570.00	19.56	28.84	48.40	54.00	-5.60	Average	100	102	P
7	15570.00	19.56	42.77	62.33	74.00	-11.67	Peak	100	102	P

Note: Level=Reading+Factor  
 Margin=Level-Limit  
 Factor=Antenna Factor + cable loss - Amplifier Factor



Power	: AC 120V / 60Hz from Adapter	Pol/Phase	: VERTICAL
Test Mode	: Mode 7, Band 1, CH46		

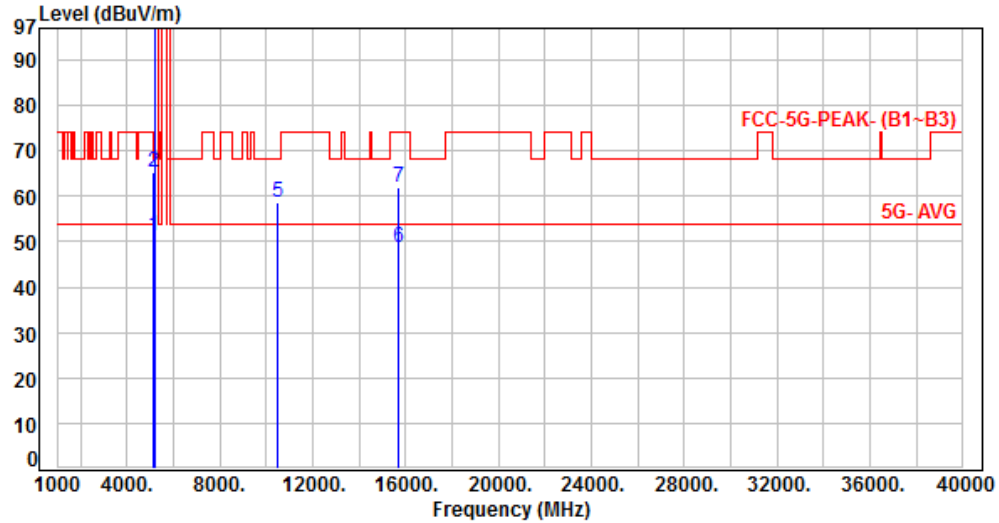

No.	Frequency (MHz)	Factor (dB)	Reading (dBuV)	Level (dBuV/m)	Limit (dBuV/m)	Margin (dB)	Detector	Height (cm)	Azimuth (deg)	P/F
1	5150.00	6.70	44.67	51.37	54.00	-2.63	Average	141	338	P
2	5150.00	6.70	58.57	65.27	74.00	-8.73	Peak	141	338	P
3	5230.00	6.99	94.50	101.49	200.00	-98.51	Average	141	338	P
4	5230.00	6.99	106.86	113.85	200.00	-86.15	Peak	141	338	P
5	10460.00	15.77	42.77	58.54	68.20	-9.66	Peak	100	222	P
6	15690.00	19.35	29.27	48.62	54.00	-5.38	Average	100	328	P
7	15690.00	19.35	42.55	61.90	74.00	-12.10	Peak	100	328	P

Note: Level=Reading+Factor  
Margin=Level-Limit  
Factor=Antenna Factor + cable loss - Amplifier Factor



Power	: AC 120V / 60Hz from Adapter	Pol/Phase	: HORIZONTAL
Test Mode	: Mode 7, Band 1, CH46		

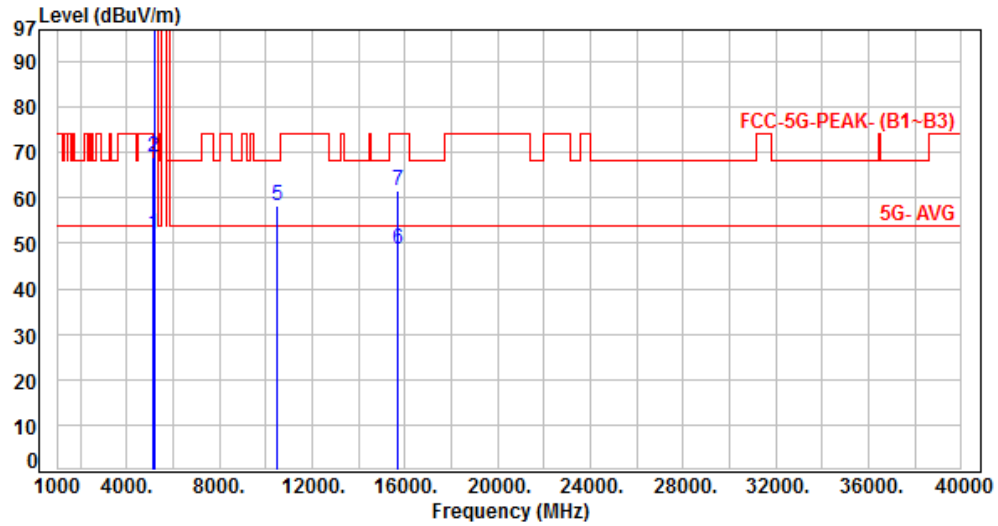

No.	Frequency (MHz)	Factor (dB)	Reading (dBuV)	Level (dBuV/m)	Limit (dBuV/m)	Margin (dB)	Detector	Height (cm)	Azimuth (deg)	P/F
1	5150.00	6.70	45.27	51.97	54.00	-2.03	Average	235	293	P
2	5150.00	6.70	62.44	69.14	74.00	-4.86	Peak	235	293	P
3	5230.00	6.99	96.49	103.48	200.00	-96.52	Average	235	293	P
4	5230.00	6.99	108.06	115.05	200.00	-84.95	Peak	235	293	P
5	10460.00	15.77	42.66	58.43	68.20	-9.77	Peak	100	346	P
6	15690.00	19.35	29.41	48.76	54.00	-5.24	Average	100	113	P
7	15690.00	19.35	42.21	61.56	74.00	-12.44	Peak	100	113	P

Note: Level=Reading+Factor  
 Margin=Level-Limit  
 Factor=Antenna Factor + cable loss - Amplifier Factor





Power	: AC 120V / 60Hz from Adapter	Pol/Phase	: VERTICAL
Test Mode	: Mode 8, Band 1, CH42		

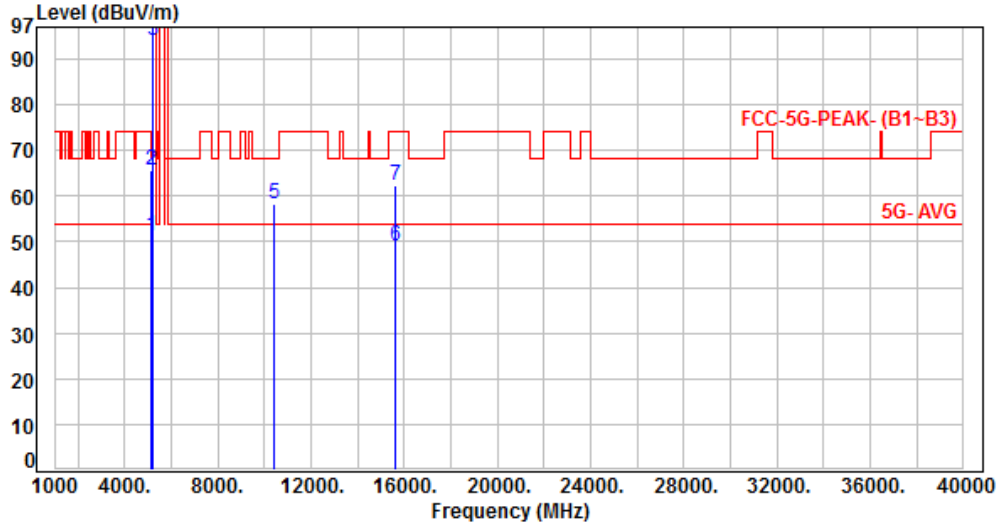

No.	Frequency (MHz)	Factor (dB)	Reading (dBuV)	Level (dBuV/m)	Limit (dBuV/m)	Margin (dB)	Detector	Height (cm)	Azimuth (deg)	P/F
1	5150.00	6.70	44.45	51.15	54.00	-2.85	Average	100	5	P
2	5150.00	6.70	58.80	65.50	74.00	-8.50	Peak	100	5	P
3	5210.00	6.97	87.26	94.23	200.00	-105.77	Average	100	5	P
4	5210.00	6.97	99.00	105.97	200.00	-94.03	Peak	100	5	P
5	10420.00	15.74	42.69	58.43	68.20	-9.77	Peak	100	225	P
6	15630.00	19.48	29.63	49.11	54.00	-4.89	Average	100	328	P
7	15630.00	19.48	42.79	62.27	74.00	-11.73	Peak	100	328	P

Note: Level=Reading+Factor  
 Margin=Level-Limit  
 Factor=Antenna Factor + cable loss - Amplifier Factor



Power	: AC 120V / 60Hz from Adapter	Pol/Phase	: HORIZONTAL
Test Mode	: Mode 8, Band 1, CH42		

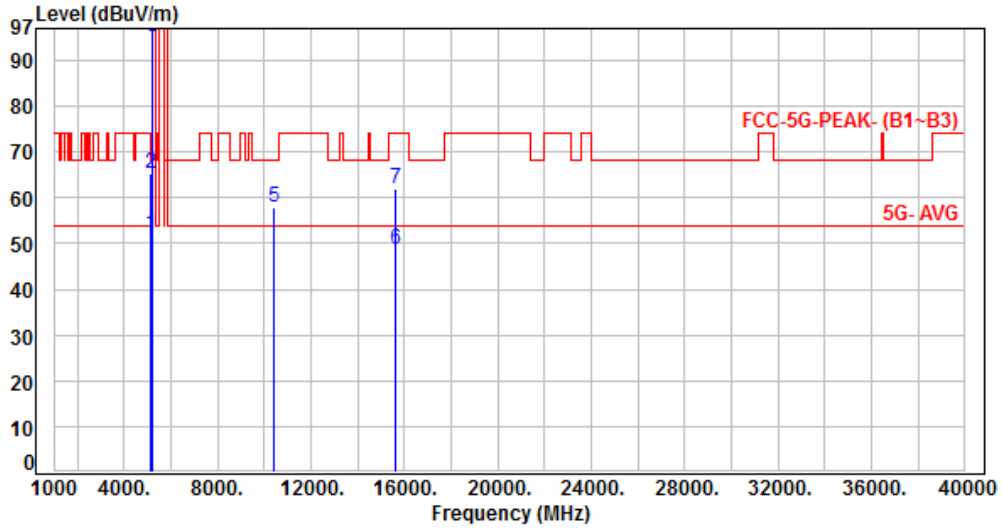

No.	Frequency (MHz)	Factor (dB)	Reading (dBuV)	Level (dBuV/m)	Limit (dBuV/m)	Margin (dB)	Detector	Height (cm)	Azimuth (deg)	P/F
1	5150.00	6.70	45.37	52.07	54.00	-1.93	Average	240	293	P
2	5150.00	6.70	58.46	65.16	74.00	-8.84	Peak	240	293	P
3	5210.00	6.97	88.28	95.25	200.00	-104.75	Average	240	293	P
4	5210.00	6.97	101.17	108.14	200.00	-91.86	Peak	240	293	P
5	10420.00	15.74	42.27	58.01	68.20	-10.19	Peak	100	349	P
6	15630.00	19.48	29.16	48.64	54.00	-5.36	Average	100	109	P
7	15630.00	19.48	42.44	61.92	74.00	-12.08	Peak	100	109	P

Note: Level=Reading+Factor  
Margin=Level-Limit  
Factor=Antenna Factor + cable loss - Amplifier Factor



Power	: AC 120V / 60Hz from Adapter	Pol/Phase	: VERTICAL
Test Mode	: Mode 9, Band 1, CH50		

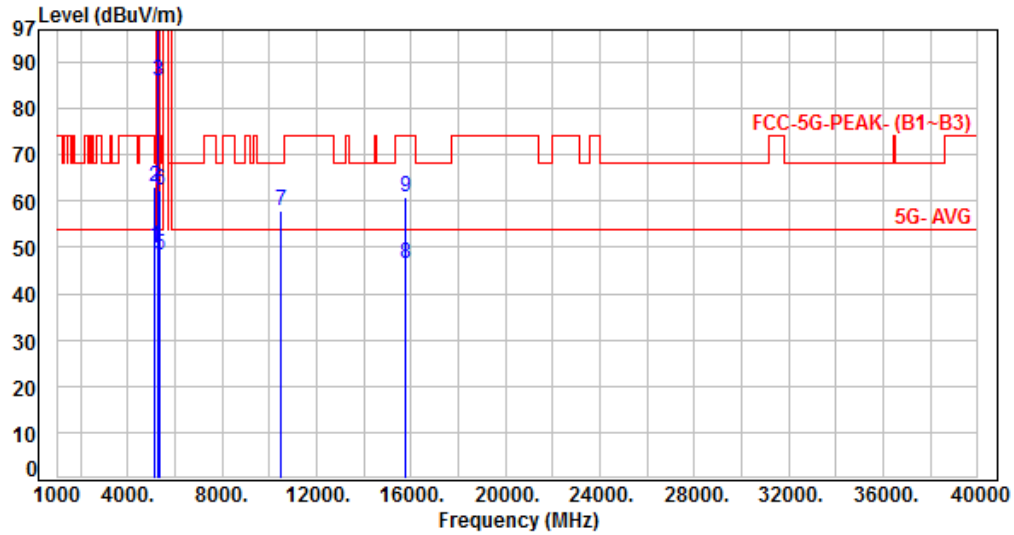

No.	Frequency (MHz)	Factor (dB)	Reading (dBuV)	Level (dBuV/m)	Limit (dBuV/m)	Margin (dB)	Detector	Height (cm)	Azimuth (deg)	P/F
1	5150.00	6.70	43.43	50.13	54.00	-3.87	Average	100	30	P
2	5150.00	6.70	56.41	63.11	74.00	-10.89	Peak	100	30	P
3	5250.00	7.01	78.75	85.76	200.00	-114.24	Average	100	30	P
4	5250.00	7.01	91.32	98.33	200.00	-101.67	Peak	100	30	P
5	5350.00	7.22	41.26	48.48	54.00	-5.52	Average	100	30	P
6	5350.00	7.22	54.93	62.15	74.00	-11.85	Peak	100	30	P
7	10500.00	15.71	42.19	57.90	68.20	-10.30	Peak	100	49	P
8	15750.00	17.99	28.36	46.35	54.00	-7.65	Average	100	247	P
9	15750.00	17.99	42.83	60.82	74.00	-13.18	Peak	100	247	P

Note: Level=Reading+Factor  
 Margin=Level-Limit  
 Factor=Antenna Factor + cable loss - Amplifier Factor



Power	: AC 120V / 60Hz from Adapter	Pol/Phase	: HORIZONTAL
Test Mode	: Mode 9, Band 1, CH50		

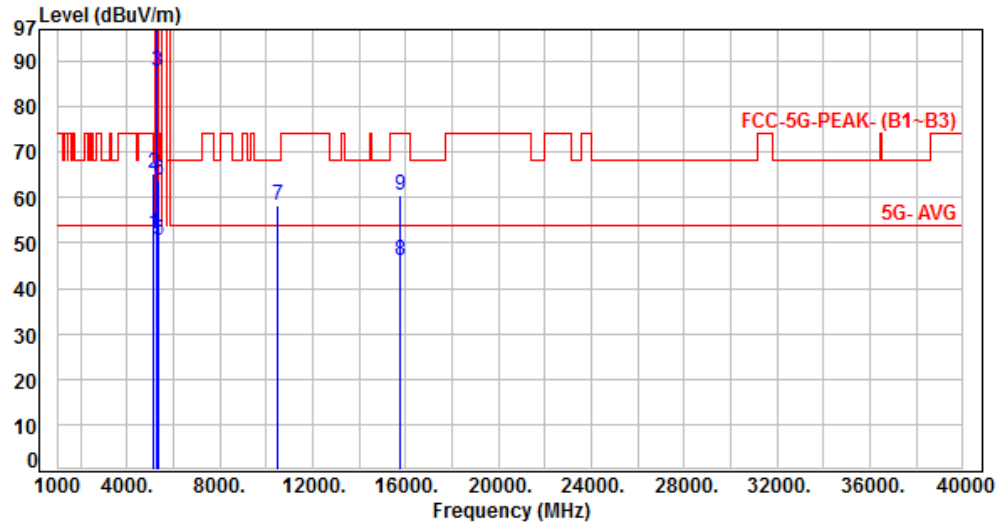

No.	Frequency (MHz)	Factor (dB)	Reading (dBuV)	Level (dBuV/m)	Limit (dBuV/m)	Margin (dB)	Detector	Height (cm)	Azimuth (deg)	P/F
1	5150.00	6.70	45.42	52.12	54.00	-1.88	Average	400	298	P
2	5150.00	6.70	58.46	65.16	74.00	-8.84	Peak	400	298	P
3	5250.00	7.01	80.88	87.89	200.00	-112.11	Average	400	298	P
4	5250.00	7.01	93.40	100.41	200.00	-99.59	Peak	400	298	P
5	5350.00	7.22	43.41	50.63	54.00	-3.37	Average	400	298	P
6	5350.00	7.22	56.67	63.89	74.00	-10.11	Peak	400	298	P
7	10500.00	15.71	42.53	58.24	68.20	-9.96	Peak	100	348	P
8	15750.00	17.99	28.08	46.07	54.00	-7.93	Average	100	158	P
9	15750.00	17.99	42.36	60.35	74.00	-13.65	Peak	100	158	P

Note: Level=Reading+Factor  
 Margin=Level-Limit  
 Factor=Antenna Factor + cable loss - Amplifier Factor



Power	: AC 120V / 60Hz from Adapter	Pol/Phase	: VERTICAL
Test Mode	: Mode 1, Band 2, CH52		

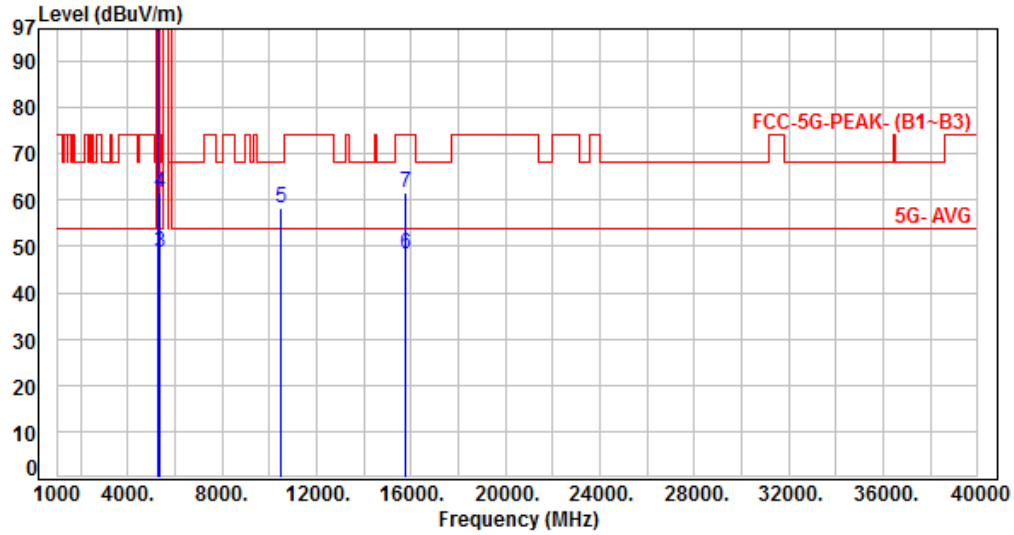

No.	Frequency (MHz)	Factor (dB)	Reading (dBuV)	Level (dBuV/m)	Limit (dBuV/m)	Margin (dB)	Detector	Height (cm)	Azimuth (deg)	P/F
1	5260.00	7.04	99.33	106.37	200.00	-93.63	Average	213	338	P
2	5260.00	7.04	109.09	116.13	200.00	-83.87	Peak	213	338	P
3	5350.00	7.22	41.49	48.71	54.00	-5.29	Average	213	338	P
4	5350.00	7.22	54.19	61.41	74.00	-12.59	Peak	213	338	P
5	10520.00	16.01	42.39	58.40	68.20	-9.80	Peak	100	344	P
6	15780.00	18.72	29.44	48.16	54.00	-5.84	Average	100	102	P
7	15780.00	18.72	42.85	61.57	74.00	-12.43	Peak	100	102	P

Note: Level=Reading+Factor  
Margin=Level-Limit  
Factor=Antenna Factor + cable loss - Amplifier Factor



Power	: AC 120V / 60Hz from Adapter	Pol/Phase	: HORIZONTAL
Test Mode	: Mode 1, Band 2, CH52		

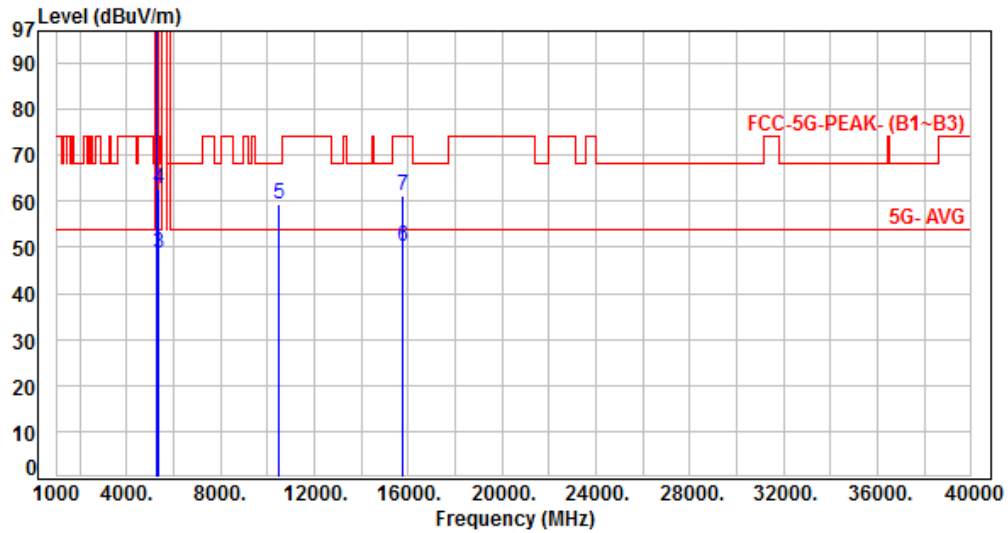

No.	Frequency (MHz)	Factor (dB)	Reading (dBuV)	Level (dBuV/m)	Limit (dBuV/m)	Margin (dB)	Detector	Height (cm)	Azimuth (deg)	P/F
1	5260.00	7.04	100.70	107.74	200.00	-92.26	Average	248	294	P
2	5260.00	7.04	110.21	117.25	200.00	-82.75	Peak	248	294	P
3	5350.00	7.22	41.63	48.85	54.00	-5.15	Average	248	294	P
4	5350.00	7.22	55.50	62.72	74.00	-11.28	Peak	248	294	P
5	10520.00	16.01	43.23	59.24	68.20	-8.96	Peak	100	226	P
6	15780.00	18.72	31.44	50.16	54.00	-3.84	Average	100	318	P
7	15780.00	18.72	42.60	61.32	74.00	-12.68	Peak	100	318	P

Note: Level=Reading+Factor  
 Margin=Level-Limit  
 Factor=Antenna Factor + cable loss - Amplifier Factor



Power	: AC 120V / 60Hz from Adapter	Pol/Phase	: VERTICAL
Test Mode	: Mode 1, Band 2, CH60		

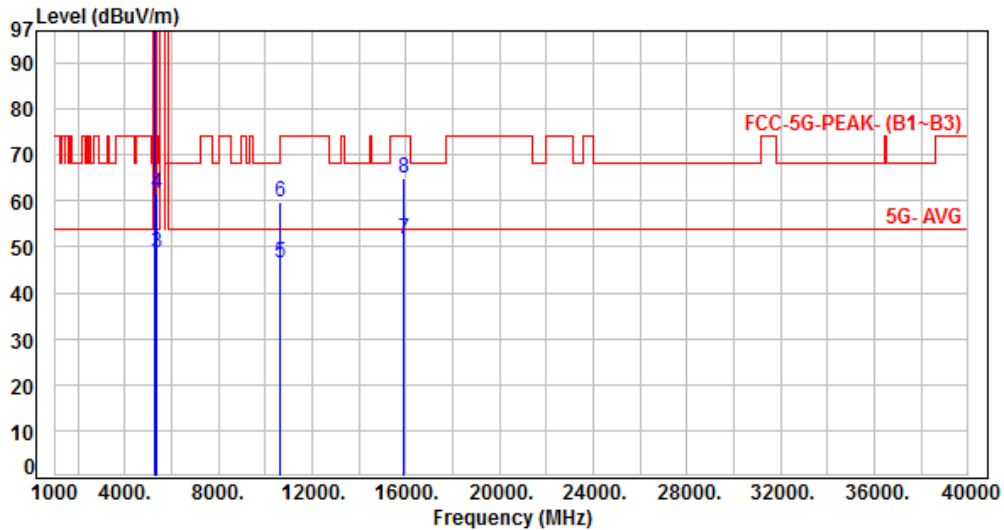

No.	Frequency (MHz)	Factor (dB)	Reading (dBuV)	Level (dBuV/m)	Limit (dBuV/m)	Margin (dB)	Detector	Height (cm)	Azimuth (deg)	P/F
1	5300.00	7.17	100.71	107.88	200.00	-92.12	Average	217	15	P
2	5300.00	7.17	110.49	117.66	200.00	-82.34	Peak	217	15	P
3	5350.00	7.22	41.63	48.85	54.00	-5.15	Average	217	15	P
4	5350.00	7.22	54.41	61.63	74.00	-12.37	Peak	217	15	P
5	10600.00	16.12	30.27	46.39	54.00	-7.61	Average	100	346	P
6	10600.00	16.12	43.55	59.67	74.00	-14.33	Peak	100	346	P
7	15900.00	18.77	32.71	51.48	54.00	-2.52	Average	100	99	P
8	15900.00	18.77	46.03	64.80	74.00	-9.20	Peak	100	99	P

Note: Level=Reading+Factor  
 Margin=Level-Limit  
 Factor=Antenna Factor + cable loss - Amplifier Factor



Power	: AC 120V / 60Hz from Adapter	Pol/Phase	: HORIZONTAL
Test Mode	: Mode 1, Band 2, CH60		

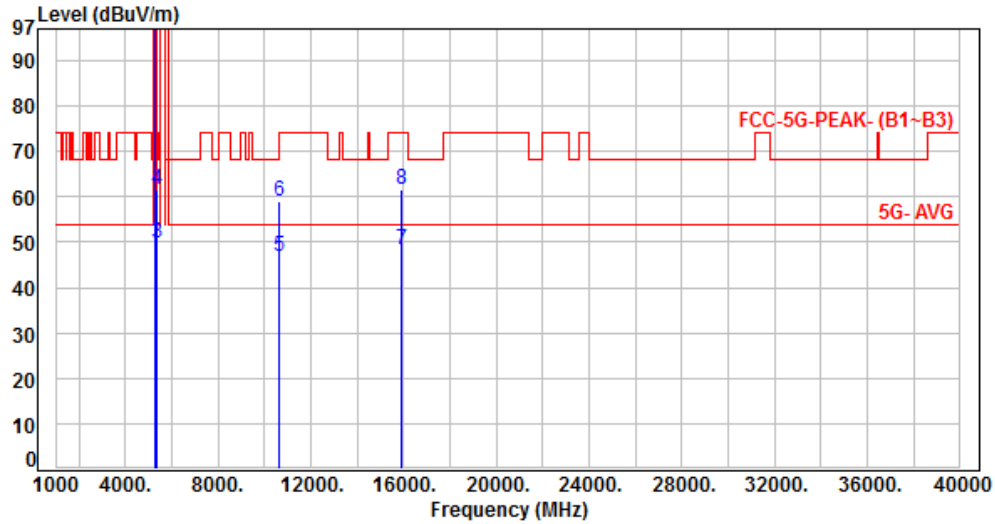

No.	Frequency (MHz)	Factor (dB)	Reading (dBuV)	Level (dBuV/m)	Limit (dBuV/m)	Margin (dB)	Detector	Height (cm)	Azimuth (deg)	P/F
1	5300.00	7.17	100.75	107.92	200.00	-92.08	Average	246	292	P
2	5300.00	7.17	110.15	117.32	200.00	-82.68	Peak	246	292	P
3	5350.00	7.22	42.43	49.65	54.00	-4.35	Average	246	292	P
4	5350.00	7.22	54.53	61.75	74.00	-12.25	Peak	246	292	P
5	10600.00	16.12	30.88	47.00	54.00	-7.00	Average	100	226	P
6	10600.00	16.12	42.73	58.85	74.00	-15.15	Peak	100	226	P
7	15900.00	18.77	29.58	48.35	54.00	-5.65	Average	100	326	P
8	15900.00	18.77	42.73	61.50	74.00	-12.50	Peak	100	326	P

Note: Level=Reading+Factor  
 Margin=Level-Limit  
 Factor=Antenna Factor + cable loss - Amplifier Factor





Power	: AC 120V / 60Hz from Adapter	Pol/Phase	: VERTICAL
Test Mode	: Mode 1, Band 2, CH64		

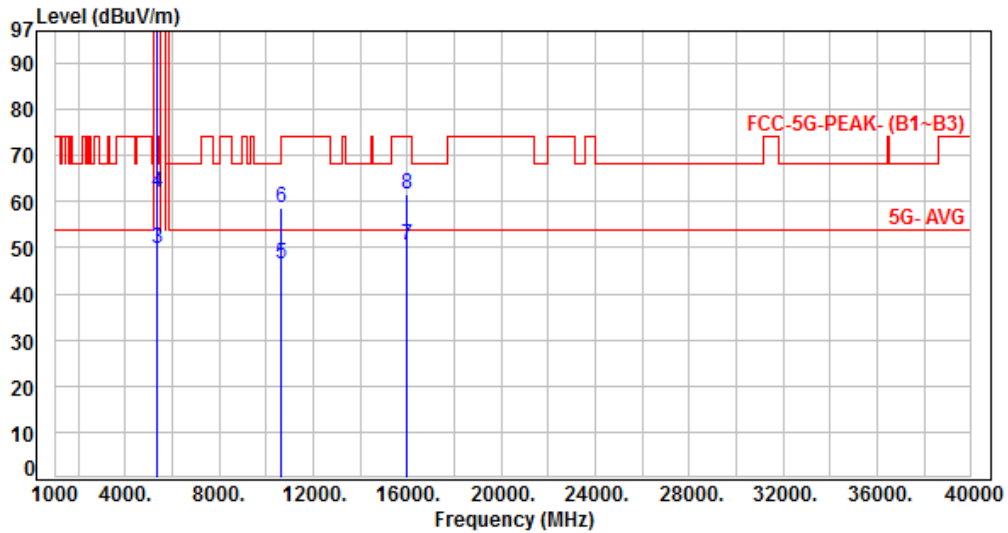

No.	Frequency (MHz)	Factor (dB)	Reading (dBuV)	Level (dBuV/m)	Limit (dBuV/m)	Margin (dB)	Detector	Height (cm)	Azimuth (deg)	P/F
1	5320.00	7.19	98.13	105.32	200.00	-94.68	Average	226	13	P
2	5320.00	7.19	107.83	115.02	200.00	-84.98	Peak	226	13	P
3	5350.00	7.22	42.50	49.72	54.00	-4.28	Average	226	13	P
4	5350.00	7.22	54.68	61.90	74.00	-12.10	Peak	226	13	P
5	10640.00	16.25	30.26	46.51	54.00	-7.49	Average	100	340	P
6	10640.00	16.25	42.46	58.71	74.00	-15.29	Peak	100	340	P
7	15960.00	18.80	31.75	50.55	54.00	-3.45	Average	100	108	P
8	15960.00	18.80	42.61	61.41	74.00	-12.59	Peak	100	108	P

Note: Level=Reading+Factor  
Margin=Level-Limit  
Factor=Antenna Factor + cable loss - Amplifier Factor



Power	: AC 120V / 60Hz from Adapter	Pol/Phase	: HORIZONTAL
Test Mode	: Mode 1, Band 2, CH64		

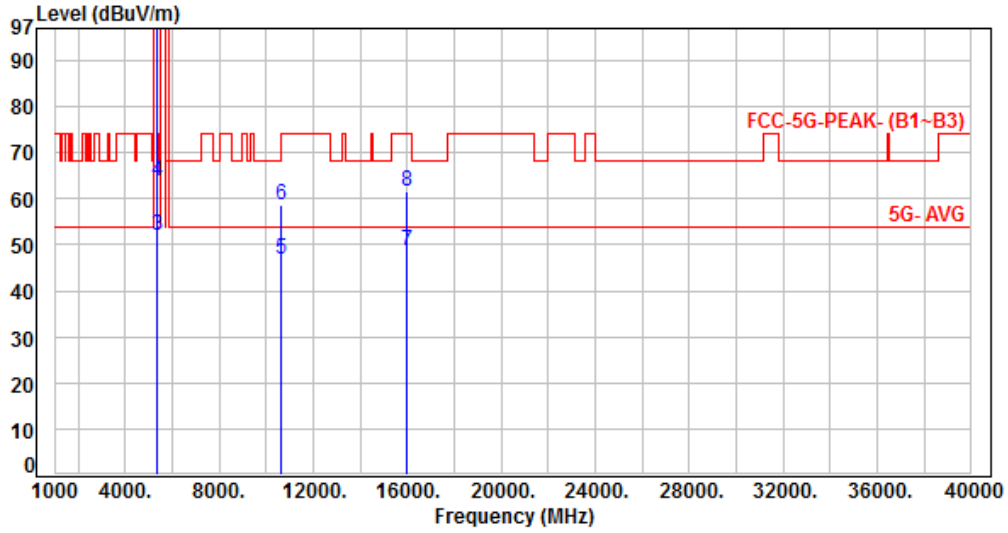

No.	Frequency (MHz)	Factor (dB)	Reading (dBuV)	Level (dBuV/m)	Limit (dBuV/m)	Margin (dB)	Detector	Height (cm)	Azimuth (deg)	P/F
1	5320.00	7.19	100.33	107.52	200.00	-92.48	Average	257	297	P
2	5320.00	7.19	109.72	116.91	200.00	-83.09	Peak	257	297	P
3	5350.00	7.22	44.72	51.94	54.00	-2.06	Average	257	297	P
4	5350.00	7.22	56.71	63.93	74.00	-10.07	Peak	257	297	P
5	10640.00	16.25	30.47	46.72	54.00	-7.28	Average	100	217	P
6	10640.00	16.25	42.38	58.63	74.00	-15.37	Peak	100	217	P
7	15960.00	18.80	29.71	48.51	54.00	-5.49	Average	100	321	P
8	15960.00	18.80	42.65	61.45	74.00	-12.55	Peak	100	321	P

Note: Level=Reading+Factor

Margin=Level-Limit

Factor=Antenna Factor + cable loss - Amplifier Factor



Power	: AC 120V / 60Hz from Adapter	Pol/Phase	: VERTICAL
Test Mode	: Mode 6, Band 2, CH52		

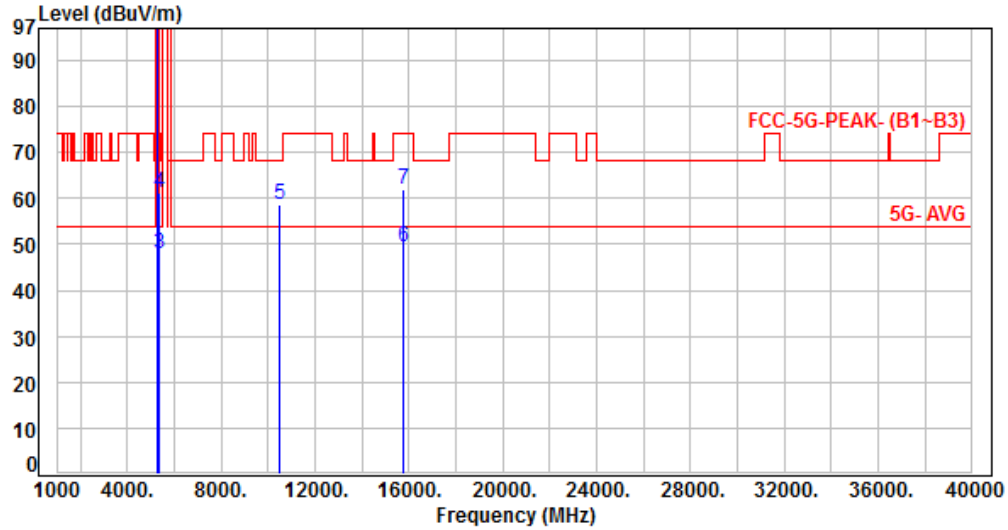

No.	Frequency (MHz)	Factor (dB)	Reading (dBuV)	Level (dBuV/m)	Limit (dBuV/m)	Margin (dB)	Detector	Height (cm)	Azimuth (deg)	P/F
1	5260.00	7.04	97.30	104.34	200.00	-95.66	Average	113	30	P
2	5260.00	7.04	110.46	117.50	200.00	-82.50	Peak	113	30	P
3	5350.00	7.22	40.78	48.00	54.00	-6.00	Average	113	30	P
4	5350.00	7.22	54.07	61.29	74.00	-12.71	Peak	113	30	P
5	10520.00	16.01	42.61	58.62	68.20	-9.58	Peak	100	337	P
6	15780.00	18.72	30.85	49.57	54.00	-4.43	Average	100	109	P
7	15780.00	18.72	43.15	61.87	74.00	-12.13	Peak	100	109	P

Note: Level=Reading+Factor  
 Margin=Level-Limit  
 Factor=Antenna Factor + cable loss - Amplifier Factor



Power	: AC 120V / 60Hz from Adapter	Pol/Phase	: HORIZONTAL
Test Mode	: Mode 6, Band 2, CH52		

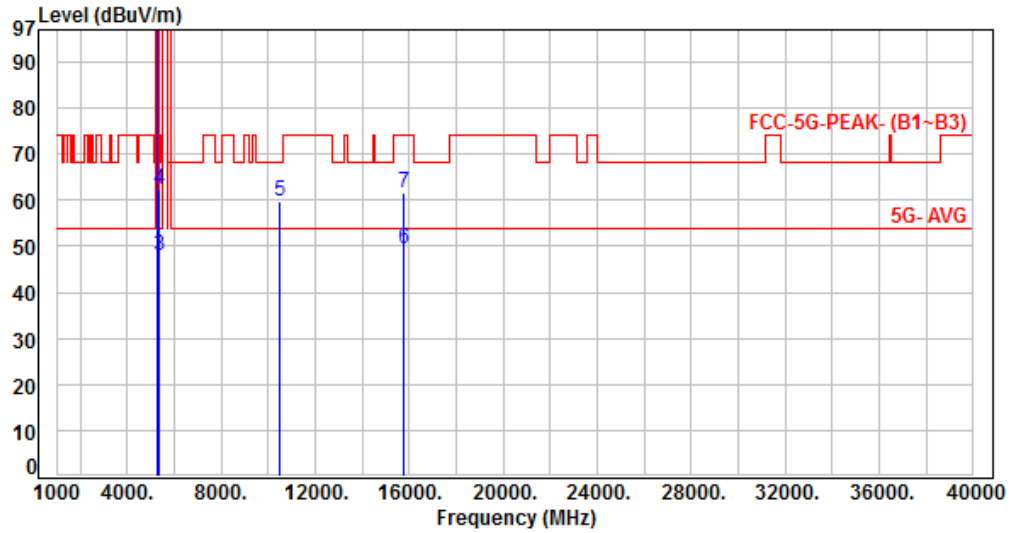

No.	Frequency (MHz)	Factor (dB)	Reading (dBuV)	Level (dBuV/m)	Limit (dBuV/m)	Margin (dB)	Detector	Height (cm)	Azimuth (deg)	P/F
1	5260.00	7.04	100.07	107.11	200.00	-92.89	Average	206	327	P
2	5260.00	7.04	113.54	120.58	200.00	-79.42	Peak	206	327	P
3	5350.00	7.22	40.82	48.04	54.00	-5.96	Average	206	327	P
4	5350.00	7.22	54.97	62.19	74.00	-11.81	Peak	206	327	P
5	10520.00	16.01	43.70	59.71	68.20	-8.49	Peak	100	215	P
6	15780.00	18.72	30.68	49.40	54.00	-4.60	Average	100	318	P
7	15780.00	18.72	42.96	61.68	74.00	-12.32	Peak	100	318	P

Note: Level=Reading+Factor  
 Margin=Level-Limit  
 Factor=Antenna Factor + cable loss - Amplifier Factor



Power	: AC 120V / 60Hz from Adapter	Pol/Phase	: VERTICAL
Test Mode	: Mode 6, Band 2, CH60		

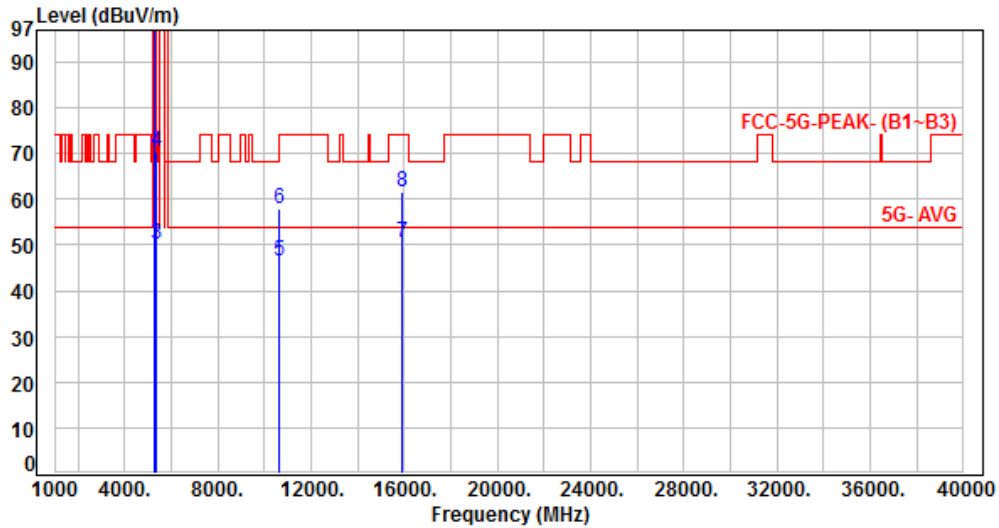

No.	Frequency (MHz)	Factor (dB)	Reading (dBuV)	Level (dBuV/m)	Limit (dBuV/m)	Margin (dB)	Detector	Height (cm)	Azimuth (deg)	P/F
1	5300.00	7.17	99.84	107.01	200.00	-92.99	Average	216	16	P
2	5300.00	7.17	113.24	120.41	200.00	-79.59	Peak	216	16	P
3	5350.00	7.22	42.81	50.03	54.00	-3.97	Average	216	16	P
4	5350.00	7.22	63.22	70.44	74.00	-3.56	Peak	216	16	P
5	10600.00	16.12	30.52	46.64	54.00	-7.36	Average	100	336	P
6	10600.00	16.12	41.94	58.06	74.00	-15.94	Peak	100	336	P
7	15900.00	18.77	31.84	50.61	54.00	-3.39	Average	100	112	P
8	15900.00	18.77	42.72	61.49	74.00	-12.51	Peak	100	112	P

Note: Level=Reading+Factor  
Margin=Level-Limit  
Factor=Antenna Factor + cable loss - Amplifier Factor



Power	: AC 120V / 60Hz from Adapter	Pol/Phase	: HORIZONTAL
Test Mode	: Mode 6, Band 2, CH60		

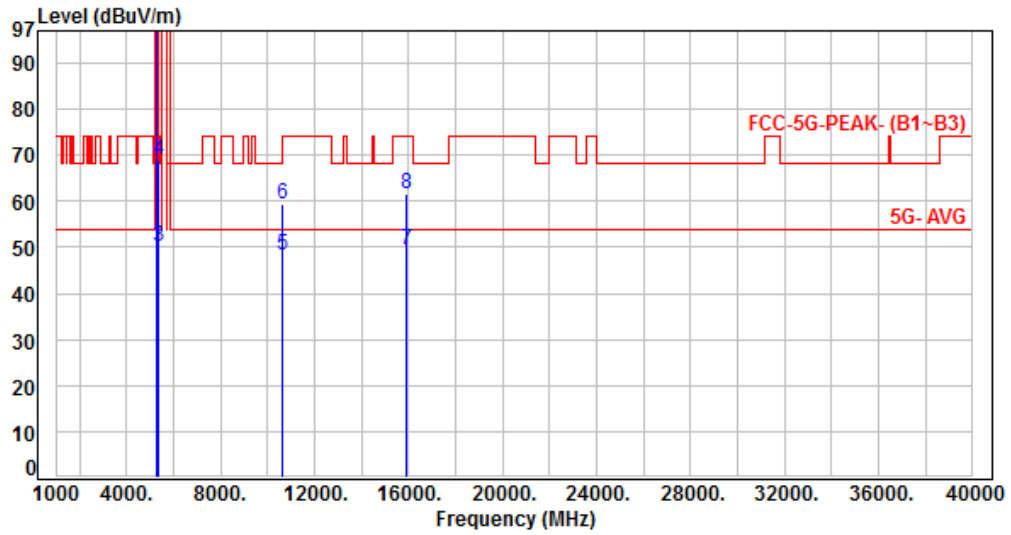

No.	Frequency (MHz)	Factor (dB)	Reading (dBuV)	Level (dBuV/m)	Limit (dBuV/m)	Margin (dB)	Detector	Height (cm)	Azimuth (deg)	P/F
1	5300.00	7.17	99.97	107.14	200.00	-92.86	Average	154	325	P
2	5300.00	7.17	112.75	119.92	200.00	-80.08	Peak	154	325	P
3	5350.00	7.22	43.08	50.30	54.00	-3.70	Average	154	325	P
4	5350.00	7.22	61.60	68.82	74.00	-5.18	Peak	154	325	P
5	10600.00	16.12	32.16	48.28	54.00	-5.72	Average	100	224	P
6	10600.00	16.12	43.26	59.38	74.00	-14.62	Peak	100	224	P
7	15900.00	18.77	30.47	49.24	54.00	-4.76	Average	100	319	P
8	15900.00	18.77	42.73	61.50	74.00	-12.50	Peak	100	319	P

Note: Level=Reading+Factor  
 Margin=Level-Limit  
 Factor=Antenna Factor + cable loss - Amplifier Factor



Power	: AC 120V / 60Hz from Adapter	Pol/Phase	: VERTICAL
Test Mode	: Mode 6, Band 2, CH64		

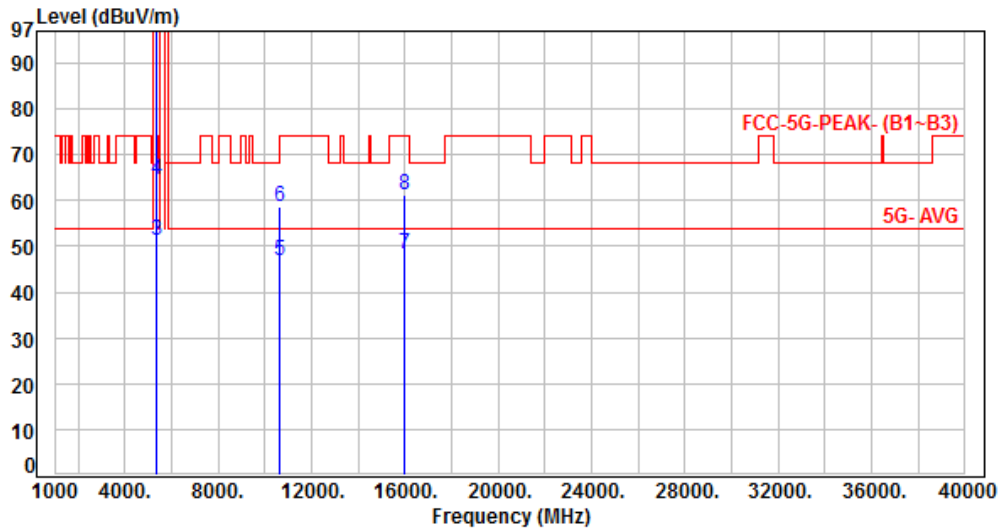

No.	Frequency (MHz)	Factor (dB)	Reading (dBuV)	Level (dBuV/m)	Limit (dBuV/m)	Margin (dB)	Detector	Height (cm)	Azimuth (deg)	P/F
1	5320.00	7.19	97.92	105.11	200.00	-94.89	Average	228	17	P
2	5320.00	7.19	111.44	118.63	200.00	-81.37	Peak	228	17	P
3	5350.00	7.22	43.99	51.21	54.00	-2.79	Average	228	17	P
4	5350.00	7.22	57.18	64.40	74.00	-9.60	Peak	228	17	P
5	10640.00	16.25	30.46	46.71	54.00	-7.29	Average	100	339	P
6	10640.00	16.25	42.33	58.58	74.00	-15.42	Peak	100	339	P
7	15960.00	18.80	29.54	48.34	54.00	-5.66	Average	100	110	P
8	15960.00	18.80	42.58	61.38	74.00	-12.62	Peak	100	110	P

Note: Level=Reading+Factor  
Margin=Level-Limit  
Factor=Antenna Factor + cable loss - Amplifier Factor



Power	: AC 120V / 60Hz from Adapter	Pol/Phase	: HORIZONTAL
Test Mode	: Mode 6, Band 2, CH64		

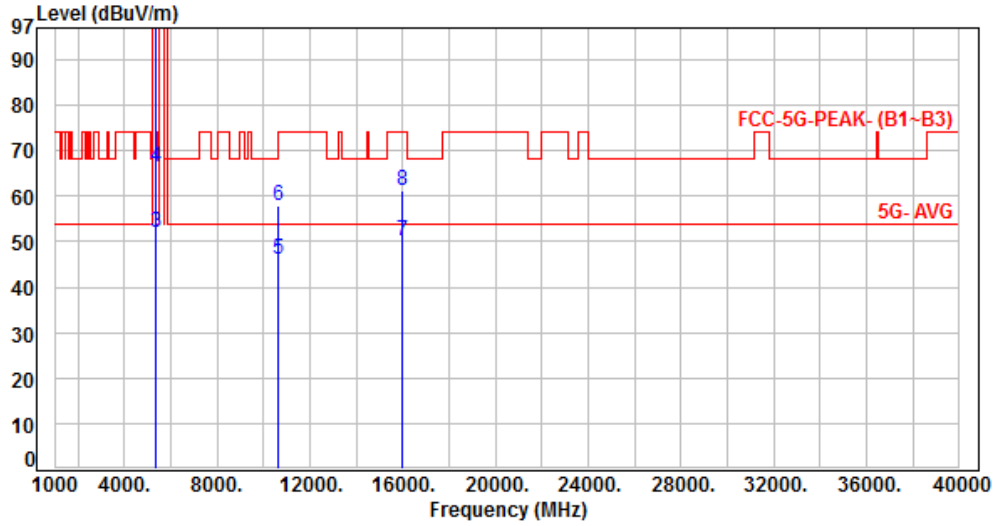

No.	Frequency (MHz)	Factor (dB)	Reading (dBuV)	Level (dBuV/m)	Limit (dBuV/m)	Margin (dB)	Detector	Height (cm)	Azimuth (deg)	P/F
1	5320.00	7.19	98.30	105.49	200.00	-94.51	Average	154	325	P
2	5320.00	7.19	111.98	119.17	200.00	-80.83	Peak	154	325	P
3	5350.00	7.22	44.89	52.11	54.00	-1.89	Average	154	325	P
4	5350.00	7.22	59.25	66.47	74.00	-7.53	Peak	154	325	P
5	10640.00	16.25	29.83	46.08	54.00	-7.92	Average	100	226	P
6	10640.00	16.25	41.69	57.94	74.00	-16.06	Peak	100	226	P
7	15960.00	18.80	31.42	50.22	54.00	-3.78	Average	100	319	P
8	15960.00	18.80	42.45	61.25	74.00	-12.75	Peak	100	319	P

Note: Level=Reading+Factor  
Margin=Level-Limit  
Factor=Antenna Factor + cable loss - Amplifier Factor





Power	: AC 120V / 60Hz from Adapter	Pol/Phase	: VERTICAL
Test Mode	: Mode 7, Band 2, CH54		

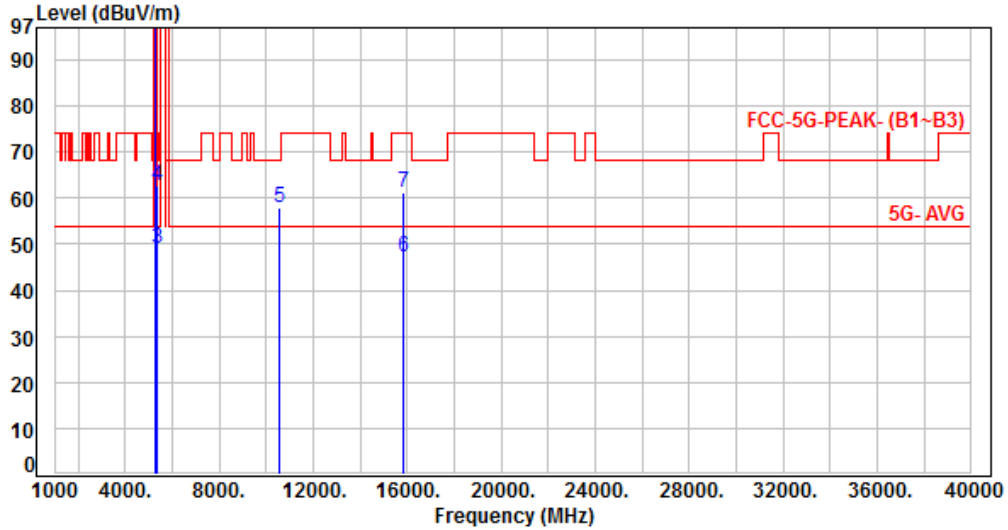

No.	Frequency (MHz)	Factor (dB)	Reading (dBuV)	Level (dBuV/m)	Limit (dBuV/m)	Margin (dB)	Detector	Height (cm)	Azimuth (deg)	P/F
1	5270.00	7.07	95.43	102.50	200.00	-97.50	Average	175	341	P
2	5270.00	7.07	107.58	114.65	200.00	-85.35	Peak	175	341	P
3	5350.00	7.22	42.01	49.23	54.00	-4.77	Average	175	341	P
4	5350.00	7.22	55.35	62.57	74.00	-11.43	Peak	175	341	P
5	10540.00	16.04	41.85	57.89	68.20	-10.31	Peak	100	346	P
6	15810.00	18.61	28.69	47.30	54.00	-6.70	Average	100	103	P
7	15810.00	18.61	42.68	61.29	74.00	-12.71	Peak	100	103	P

Note: Level=Reading+Factor  
 Margin=Level-Limit  
 Factor=Antenna Factor + cable loss - Amplifier Factor



Power	: AC 120V / 60Hz from Adapter	Pol/Phase	: HORIZONTAL
Test Mode	: Mode 7, Band 2, CH54		

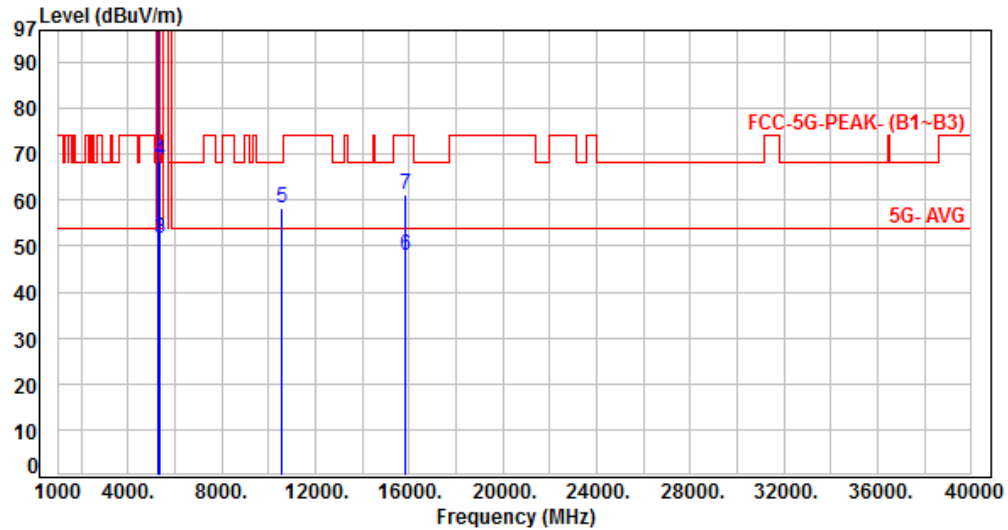

No.	Frequency (MHz)	Factor (dB)	Reading (dBuV)	Level (dBuV/m)	Limit (dBuV/m)	Margin (dB)	Detector	Height (cm)	Azimuth (deg)	P/F
1	5270.00	7.07	96.93	104.00	200.00	-96.00	Average	289	299	P
2	5270.00	7.07	110.37	117.44	200.00	-82.56	Peak	289	299	P
3	5350.00	7.22	44.58	51.80	54.00	-2.20	Average	289	299	P
4	5350.00	7.22	61.54	68.76	74.00	-5.24	Peak	289	299	P
5	10540.00	16.04	42.17	58.21	68.20	-9.99	Peak	100	229	P
6	15810.00	18.61	29.51	48.12	54.00	-5.88	Average	100	316	P
7	15810.00	18.61	42.70	61.31	74.00	-12.69	Peak	100	316	P

Note: Level=Reading+Factor  
 Margin=Level-Limit  
 Factor=Antenna Factor + cable loss - Amplifier Factor



Power	: AC 120V / 60Hz from Adapter	Pol/Phase	: VERTICAL
Test Mode	: Mode 7, Band 2, CH62		

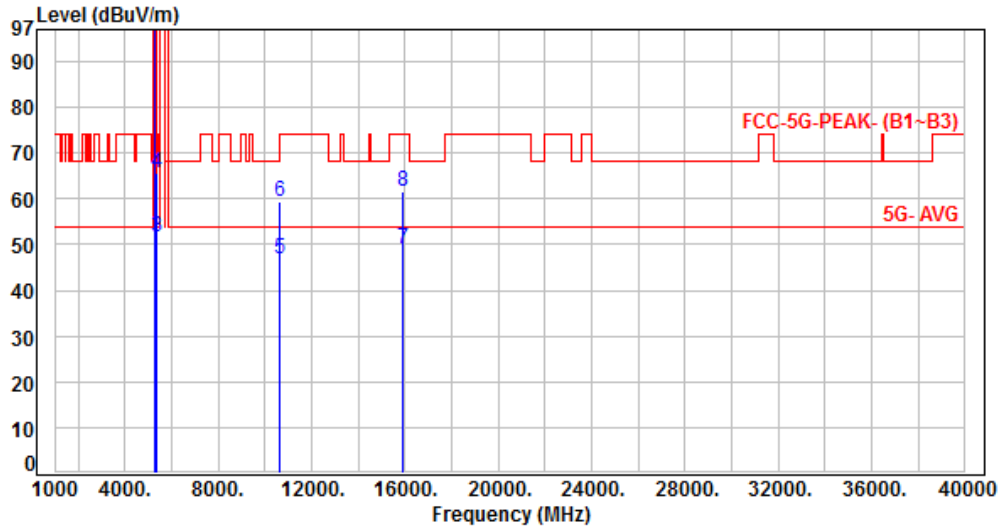

No.	Frequency (MHz)	Factor (dB)	Reading (dBuV)	Level (dBuV/m)	Limit (dBuV/m)	Margin (dB)	Detector	Height (cm)	Azimuth (deg)	P/F
1	5310.00	7.18	92.89	100.07	200.00	-99.93	Average	218	13	P
2	5310.00	7.18	106.50	113.68	200.00	-86.32	Peak	218	13	P
3	5350.00	7.22	44.28	51.50	54.00	-2.50	Average	218	13	P
4	5350.00	7.22	58.30	65.52	74.00	-8.48	Peak	218	13	P
5	10620.00	16.19	30.64	46.83	54.00	-7.17	Average	100	335	P
6	10620.00	16.19	43.29	59.48	74.00	-14.52	Peak	100	335	P
7	15930.00	18.76	30.18	48.94	54.00	-5.06	Average	100	108	P
8	15930.00	18.76	42.85	61.61	74.00	-12.39	Peak	100	108	P

Note: Level=Reading+Factor

Margin=Level-Limit

Factor=Antenna Factor + cable loss - Amplifier Factor



Power	: AC 120V / 60Hz from Adapter	Pol/Phase	: HORIZONTAL
Test Mode	: Mode 7, Band 2, CH62		:

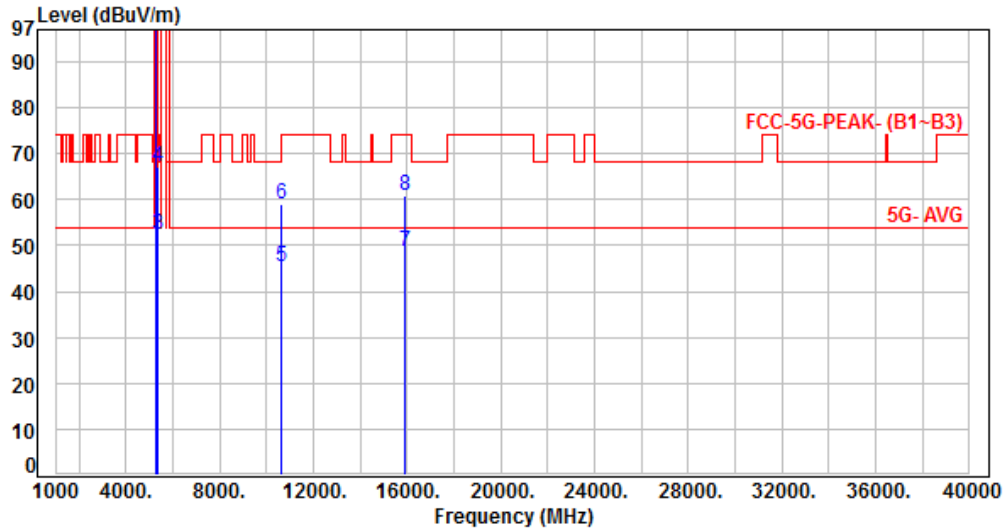

No.	Frequency (MHz)	Factor (dB)	Reading (dBuV)	Level (dBuV/m)	Limit (dBuV/m)	Margin (dB)	Detector	Height (cm)	Azimuth (deg)	P/F
1	5310.00	7.18	92.70	99.88	200.00	-100.12	Average	137	329	P
2	5310.00	7.18	105.15	112.33	200.00	-87.67	Peak	137	329	P
3	5350.00	7.22	45.09	52.31	54.00	-1.69	Average	137	329	P
4	5350.00	7.22	59.84	67.06	74.00	-6.94	Peak	137	329	P
5	10620.00	16.19	29.30	45.49	54.00	-8.51	Average	100	223	P
6	10620.00	16.19	42.93	59.12	74.00	-14.88	Peak	100	223	P
7	15930.00	18.76	29.81	48.57	54.00	-5.43	Average	100	325	P
8	15930.00	18.76	42.28	61.04	74.00	-12.96	Peak	100	325	P

Note: Level=Reading+Factor  
 Margin=Level-Limit  
 Factor=Antenna Factor + cable loss - Amplifier Factor



Power	: AC 120V / 60Hz from Adapter	Pol/Phase	: VERTICAL
Test Mode	: Mode 8, Band 2, CH58		

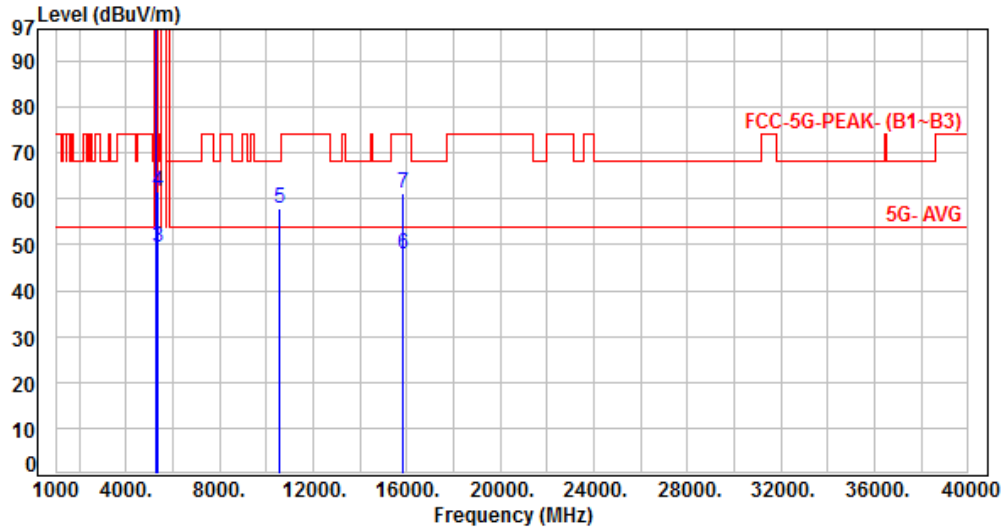

No.	Frequency (MHz)	Factor (dB)	Reading (dBUV)	Level (dBUV/m)	Limit (dBUV/m)	Margin (dB)	Detector	Height (cm)	Azimuth (deg)	P/F
1	5290.00	7.13	88.54	95.67	200.00	-104.33	Average	138	341	P
2	5290.00	7.13	100.48	107.61	200.00	-92.39	Peak	138	341	P
3	5350.00	7.22	42.17	49.39	54.00	-4.61	Average	138	341	P
4	5350.00	7.22	54.48	61.70	74.00	-12.30	Peak	138	341	P
5	10580.00	16.09	41.83	57.92	68.20	-10.28	Peak	100	341	P
6	15870.00	18.72	29.27	47.99	54.00	-6.01	Average	100	113	P
7	15870.00	18.72	42.49	61.21	74.00	-12.79	Peak	100	113	P

Note: Level=Reading+Factor  
 Margin=Level-Limit  
 Factor=Antenna Factor + cable loss - Amplifier Factor



Power	: AC 120V / 60Hz from Adapter	Pol/Phase	: HORIZONTAL
Test Mode	: Mode 8, Band 2, CH58		

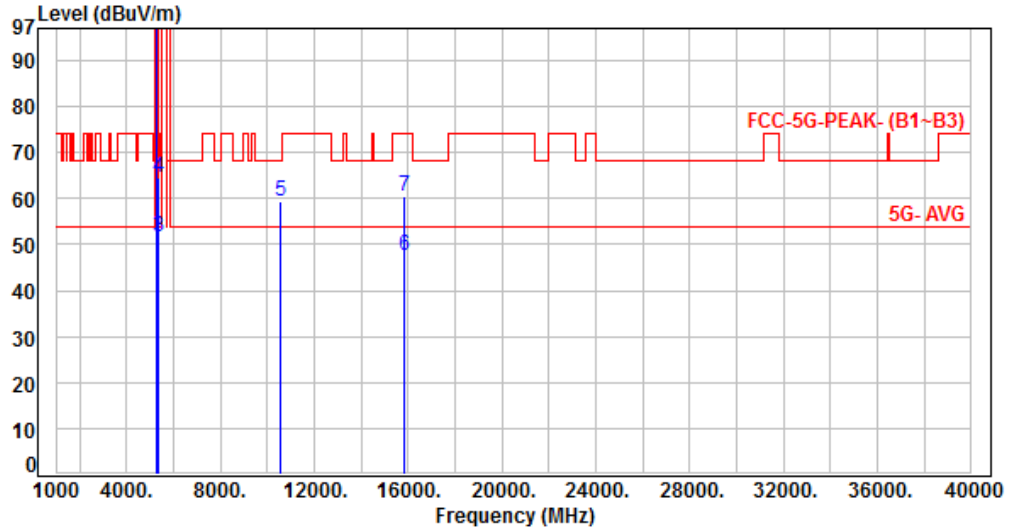

No.	Frequency (MHz)	Factor (dB)	Reading (dBuV)	Level (dBuV/m)	Limit (dBuV/m)	Margin (dB)	Detector	Height (cm)	Azimuth (deg)	P/F
1	5290.00	7.13	89.43	96.56	200.00	-103.44	Average	395	290	P
2	5290.00	7.13	100.73	107.86	200.00	-92.14	Peak	395	290	P
3	5350.00	7.22	44.56	51.78	54.00	-2.22	Average	395	290	P
4	5350.00	7.22	57.42	64.64	74.00	-9.36	Peak	395	290	P
5	10580.00	16.09	43.14	59.23	68.20	-8.97	Peak	100	227	P
6	15870.00	18.72	28.74	47.46	54.00	-6.54	Average	100	321	P
7	15870.00	18.72	41.76	60.48	74.00	-13.52	Peak	100	321	P

Note: Level=Reading+Factor  
 Margin=Level-Limit  
 Factor=Antenna Factor + cable loss - Amplifier Factor



Power	: AC 120V / 60Hz from Adapter	Pol/Phase	: VERTICAL
Test Mode	: Mode 1, Band 3, CH100		:

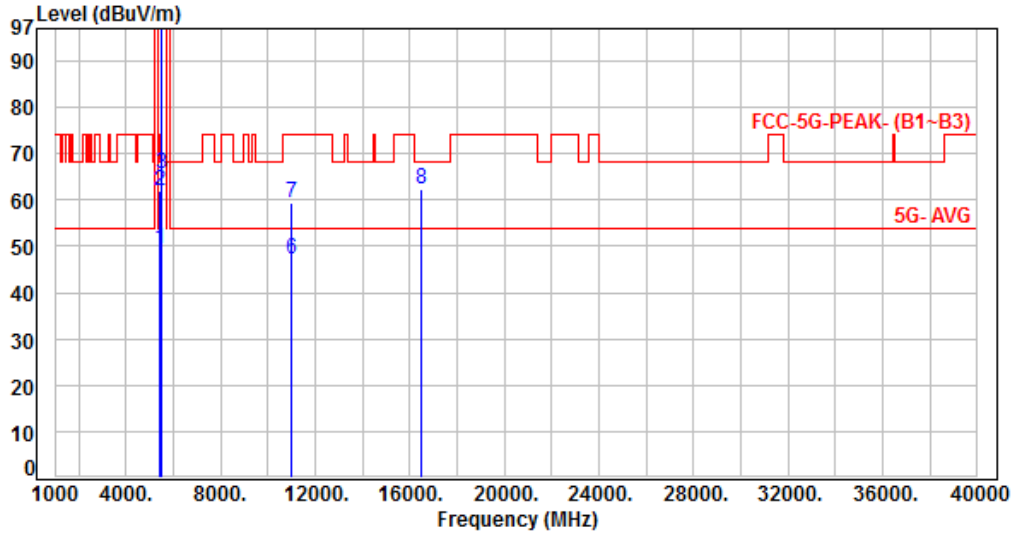

No.	Frequency (MHz)	Factor (dB)	Reading (dBuV)	Level (dBuV/m)	Limit (dBuV/m)	Margin (dB)	Detector	Height (cm)	Azimuth (deg)	P/F
1	5460.00	7.45	41.85	49.30	54.00	-4.70	Average	100	359	P
2	5460.00	7.45	54.39	61.84	74.00	-12.16	Peak	100	359	P
3	5470.00	7.46	58.04	65.50	68.20	-2.70	Peak	100	359	P
4	5500.00	7.49	97.62	105.11	200.00	-94.89	Average	100	359	P
5	5500.00	7.49	107.40	114.89	200.00	-85.11	Peak	100	359	P
6	11000.00	16.84	30.40	47.24	54.00	-6.76	Average	100	346	P
7	11000.00	16.84	42.49	59.33	74.00	-14.67	Peak	100	346	P
8	16500.00	19.88	42.55	62.43	68.20	-5.77	Peak	100	100	P

Note: Level=Reading+Factor  
 Margin=Level-Limit  
 Factor=Antenna Factor + cable loss - Amplifier Factor



Power	: AC 120V / 60Hz from Adapter	Pol/Phase	: HORIZONTAL
Test Mode	: Mode 1, Band 3, CH100		

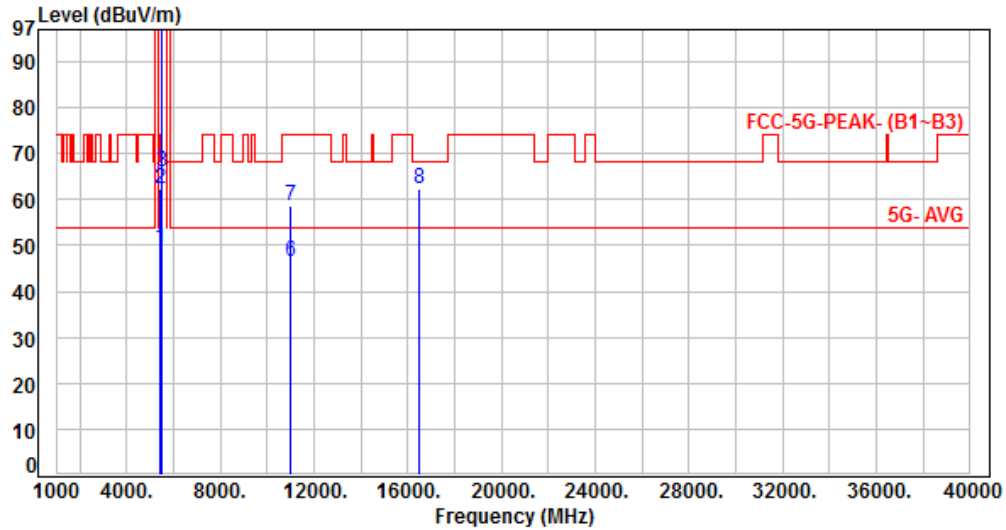

No.	Frequency (MHz)	Factor (dB)	Reading (dBuV)	Level (dBuV/m)	Limit (dBuV/m)	Margin (dB)	Detector	Height (cm)	Azimuth (deg)	P/F
1	5460.00	7.45	41.84	49.29	54.00	-4.71	Average	100	41	P
2	5460.00	7.45	54.71	62.16	74.00	-11.84	Peak	100	41	P
3	5470.00	7.46	58.43	65.89	68.20	-2.31	Peak	100	41	P
4	5500.00	7.49	97.16	104.65	200.00	-95.35	Average	100	41	P
5	5500.00	7.49	106.54	114.03	200.00	-85.97	Peak	100	41	P
6	11000.00	16.84	29.68	46.52	54.00	-7.48	Average	100	226	P
7	11000.00	16.84	41.95	58.79	74.00	-15.21	Peak	100	226	P
8	16500.00	19.88	42.37	62.25	68.20	-5.95	Peak	100	319	P

Note: Level=Reading+Factor  
 Margin=Level-Limit  
 Factor=Antenna Factor + cable loss - Amplifier Factor





Power	: AC 120V / 60Hz from Adapter	Pol/Phase	: VERTICAL
Test Mode	: Mode 1, Band 3, CH120		

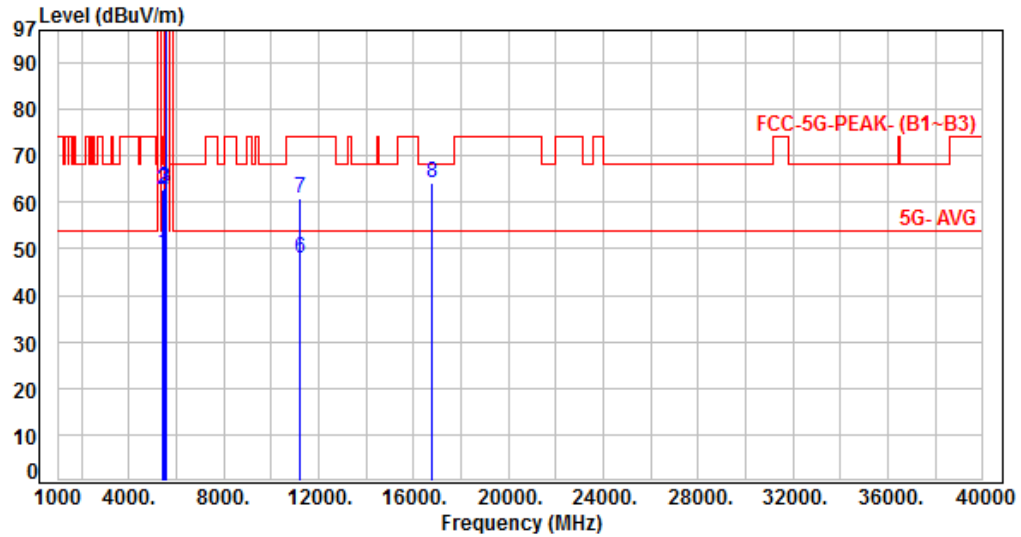

No.	Frequency (MHz)	Factor (dB)	Reading (dBuV)	Level (dBuV/m)	Limit (dBuV/m)	Margin (dB)	Detector	Height (cm)	Azimuth (deg)	P/F
1	5460.00	7.45	41.78	49.23	54.00	-4.77	Average	105	13	P
2	5460.00	7.45	55.17	62.62	74.00	-11.38	Peak	105	13	P
3	5470.00	7.46	55.50	62.96	68.20	-5.24	Peak	105	13	P
4	5600.00	7.43	98.29	105.72	200.00	-94.28	Average	105	13	P
5	5600.00	7.43	107.65	115.08	200.00	-84.92	Peak	105	13	P
6	11200.00	17.07	30.87	47.94	54.00	-6.06	Average	100	347	P
7	11200.00	17.07	43.69	60.76	74.00	-13.24	Peak	100	347	P
8	16800.00	21.73	42.57	64.30	68.20	-3.90	Peak	100	107	P

Note: Level=Reading+Factor  
 Margin=Level-Limit  
 Factor=Antenna Factor + cable loss - Amplifier Factor



Power	: AC 120V / 60Hz from Adapter	Pol/Phase	: HORIZONTAL
Test Mode	: Mode 1, Band 3, CH120		

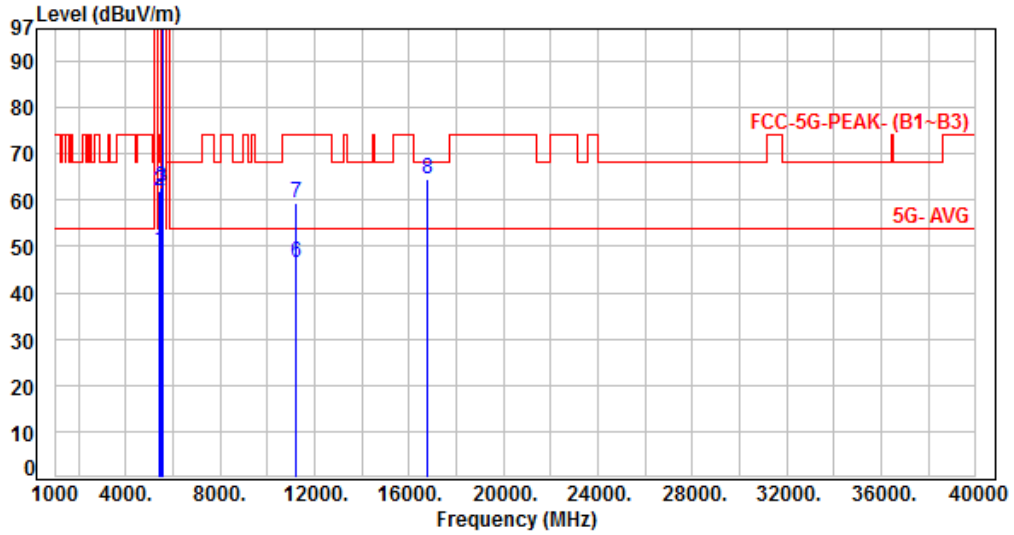

No.	Frequency (MHz)	Factor (dB)	Reading (dBuV)	Level (dBuV/m)	Limit (dBuV/m)	Margin (dB)	Detector	Height (cm)	Azimuth (deg)	P/F
1	5460.00	7.45	41.49	48.94	54.00	-5.06	Average	100	36	P
2	5460.00	7.45	54.58	62.03	74.00	-11.97	Peak	100	36	P
3	5470.00	7.46	55.29	62.75	68.20	-5.45	Peak	100	36	P
4	5600.00	7.43	98.58	106.01	200.00	-93.99	Average	100	36	P
5	5600.00	7.43	107.79	115.22	200.00	-84.78	Peak	100	36	P
6	11200.00	17.07	29.42	46.49	54.00	-7.51	Average	100	222	P
7	11200.00	17.07	42.40	59.47	74.00	-14.53	Peak	100	222	P
8	16800.00	21.73	42.93	64.66	68.20	-3.54	Peak	100	323	P

Note: Level=Reading+Factor  
 Margin=Level-Limit  
 Factor=Antenna Factor + cable loss - Amplifier Factor



Power	: AC 120V / 60Hz from Adapter	Pol/Phase	: VERTICAL
Test Mode	: Mode 1, Band 3, CH140		

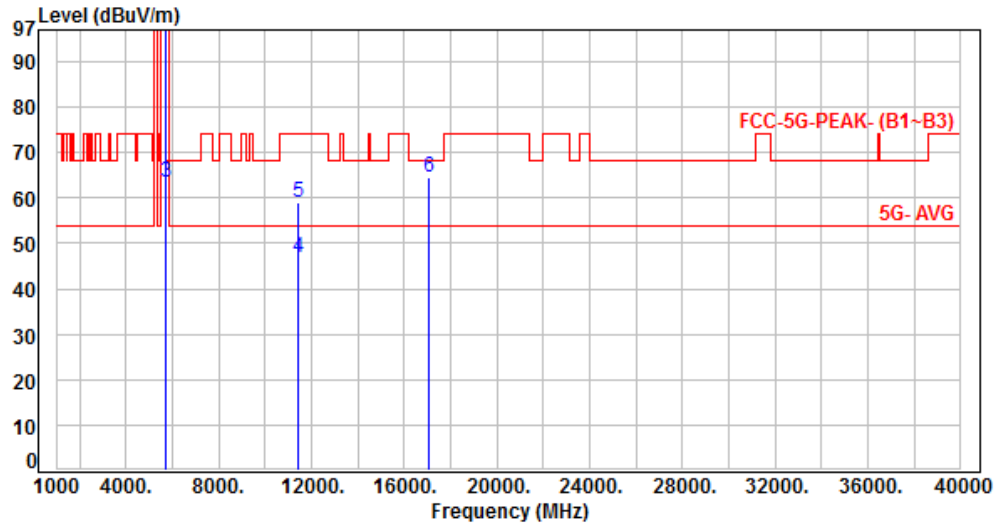

No.	Frequency (MHz)	Factor (dB)	Reading (dBuV)	Level (dBuV/m)	Limit (dBuV/m)	Margin (dB)	Detector	Height (cm)	Azimuth (deg)	P/F
1	5700.00	7.37	94.41	101.78	200.00	-98.22	Average	100	11	P
2	5700.00	7.37	103.81	111.18	200.00	-88.82	Peak	100	11	P
3	5725.00	7.33	56.08	63.41	68.20	-4.79	Peak	100	11	P
4	11400.00	17.31	29.56	46.87	54.00	-7.13	Average	100	336	P
5	11400.00	17.31	41.52	58.83	74.00	-15.17	Peak	100	336	P
6	17100.00	23.23	41.49	64.72	68.20	-3.48	Peak	100	108	P

Note: Level=Reading+Factor  
Margin=Level-Limit  
Factor=Antenna Factor + cable loss - Amplifier Factor



Power	: AC 120V / 60Hz from Adapter	Pol/Phase	: HORIZONTAL
Test Mode	: Mode 1, Band 3, CH140		:

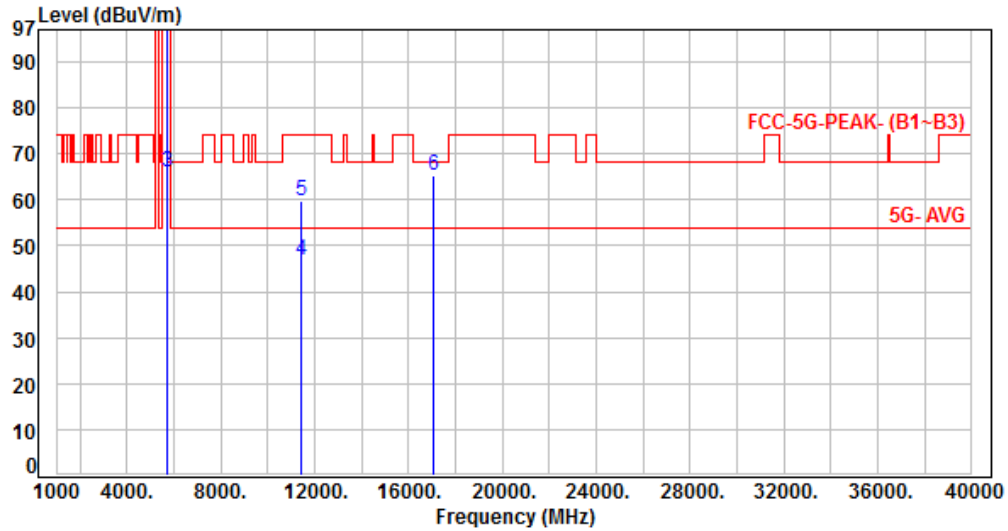

No.	Frequency (MHz)	Factor (dB)	Reading (dBuV)	Level (dBuV/m)	Limit (dBuV/m)	Margin (dB)	Detector	Height (cm)	Azimuth (deg)	P/F
1	5700.00	7.37	97.51	104.88	200.00	-95.12	Average	279	296	P
2	5700.00	7.37	107.05	114.42	200.00	-85.58	Peak	279	296	P
3	5725.00	7.33	58.74	66.07	68.20	-2.13	Peak	279	296	P
4	11400.00	17.31	29.36	46.67	54.00	-7.33	Average	100	227	P
5	11400.00	17.31	42.37	59.68	74.00	-14.32	Peak	100	227	P
6	17100.00	23.23	42.08	65.31	68.20	-2.89	Peak	100	318	P

Note: Level=Reading+Factor  
 Margin=Level-Limit  
 Factor=Antenna Factor + cable loss - Amplifier Factor



Power	: AC 120V / 60Hz from Adapter	Pol/Phase	: VERTICAL
Test Mode	: Mode 6, Band 3, CH100		

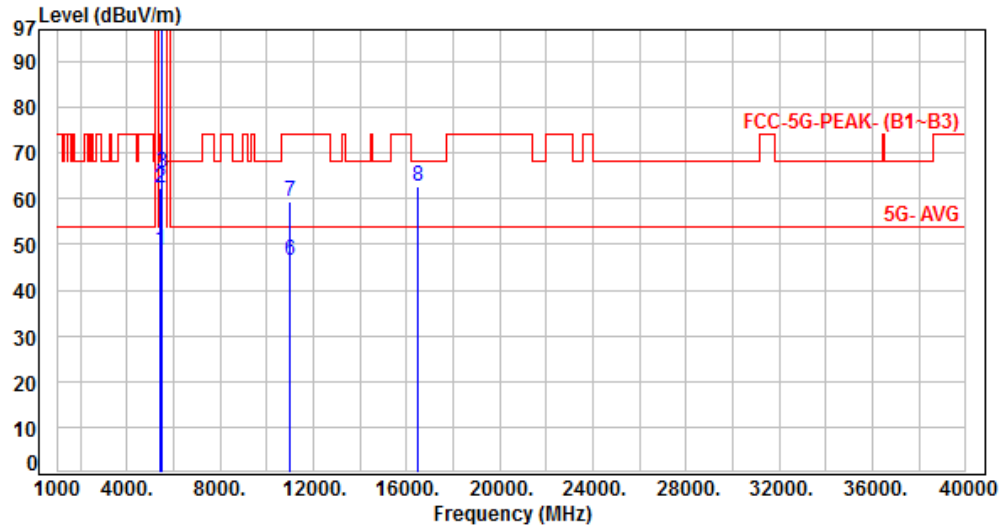

No.	Frequency (MHz)	Factor (dB)	Reading (dBuV)	Level (dBuV/m)	Limit (dBuV/m)	Margin (dB)	Detector	Height (cm)	Azimuth (deg)	P/F
1	5460.00	7.45	41.25	48.70	54.00	-5.30	Average	100	351	P
2	5460.00	7.45	55.04	62.49	74.00	-11.51	Peak	100	351	P
3	5470.00	7.46	58.37	65.83	68.20	-2.37	Peak	100	351	P
4	5500.00	7.49	96.05	103.54	200.00	-96.46	Average	100	351	P
5	5500.00	7.49	109.59	117.08	200.00	-82.92	Peak	100	351	P
6	11000.00	16.84	29.47	46.31	54.00	-7.69	Average	100	338	P
7	11000.00	16.84	42.68	59.52	74.00	-14.48	Peak	100	338	P
8	16500.00	19.88	42.82	62.70	68.20	-5.50	Peak	100	101	P

Note: Level=Reading+Factor  
Margin=Level-Limit  
Factor=Antenna Factor + cable loss - Amplifier Factor



Power	: AC 120V / 60Hz from Adapter	Pol/Phase	: HORIZONTAL
Test Mode	: Mode 6, Band 3, CH100		

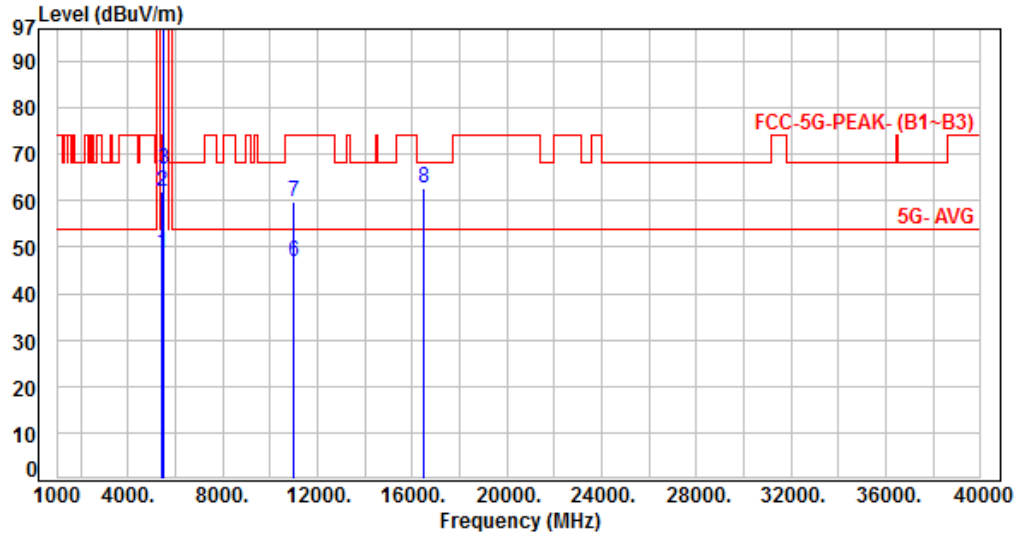

No.	Frequency (MHz)	Factor (dB)	Reading (dBuV)	Level (dBuV/m)	Limit (dBuV/m)	Margin (dB)	Detector	Height (cm)	Azimuth (deg)	P/F
1	5460.00	7.45	41.27	48.72	54.00	-5.28	Average	100	44	P
2	5460.00	7.45	54.51	61.96	74.00	-12.04	Peak	100	44	P
3	5470.00	7.46	59.26	66.72	68.20	-1.48	Peak	100	44	P
4	5500.00	7.49	95.41	102.90	200.00	-97.10	Average	100	44	P
5	5500.00	7.49	108.71	116.20	200.00	-83.80	Peak	100	44	P
6	11000.00	16.84	29.83	46.67	54.00	-7.33	Average	100	223	P
7	11000.00	16.84	42.91	59.75	74.00	-14.25	Peak	100	223	P
8	16500.00	19.88	42.86	62.74	68.20	-5.46	Peak	100	320	P

Note: Level=Reading+Factor  
 Margin=Level-Limit  
 Factor=Antenna Factor + cable loss - Amplifier Factor



Power	: AC 120V / 60Hz from Adapter	Pol/Phase	: VERTICAL
Test Mode	: Mode 6, Band 3, CH120		

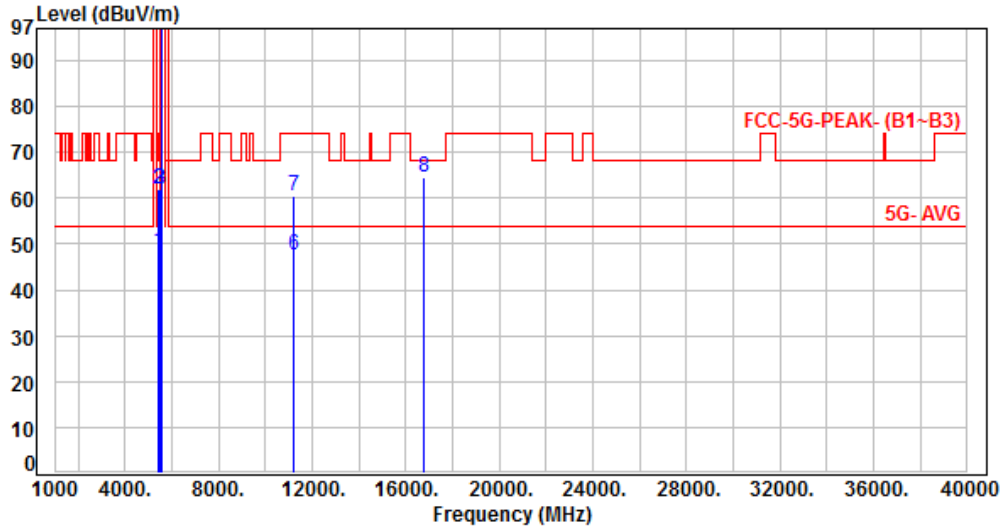

No.	Frequency (MHz)	Factor (dB)	Reading (dBuV)	Level (dBuV/m)	Limit (dBuV/m)	Margin (dB)	Detector	Height (cm)	Azimuth (deg)	P/F
1	5460.00	7.45	40.94	48.39	54.00	-5.61	Average	107	17	P
2	5460.00	7.45	54.45	61.90	74.00	-12.10	Peak	107	17	P
3	5470.00	7.46	54.43	61.89	68.20	-6.31	Peak	107	17	P
4	5600.00	7.43	97.07	104.50	200.00	-95.50	Average	107	17	P
5	5600.00	7.43	110.11	117.54	200.00	-82.46	Peak	107	17	P
6	11200.00	17.07	30.66	47.73	54.00	-6.27	Average	100	339	P
7	11200.00	17.07	43.54	60.61	74.00	-13.39	Peak	100	339	P
8	16800.00	21.73	42.95	64.68	68.20	-3.52	Peak	100	105	P

Note: Level=Reading+Factor  
 Margin=Level-Limit  
 Factor=Antenna Factor + cable loss - Amplifier Factor



Power	: AC 120V / 60Hz from Adapter	Pol/Phase	: HORIZONTAL
Test Mode	: Mode 6, Band 3, CH120		

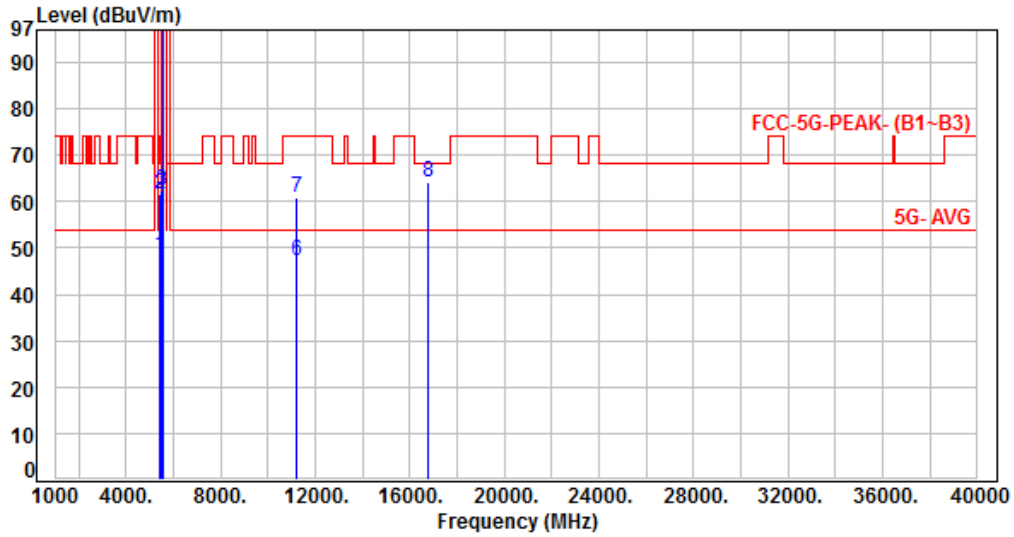

No.	Frequency (MHz)	Factor (dB)	Reading (dBuV)	Level (dBuV/m)	Limit (dBuV/m)	Margin (dB)	Detector	Height (cm)	Azimuth (deg)	P/F
1	5460.00	7.45	40.92	48.37	54.00	-5.63	Average	100	39	P
2	5460.00	7.45	54.20	61.65	74.00	-12.35	Peak	100	39	P
3	5470.00	7.46	54.96	62.42	68.20	-5.78	Peak	100	39	P
4	5600.00	7.43	97.64	105.07	200.00	-94.93	Average	100	39	P
5	5600.00	7.43	110.52	117.95	200.00	-82.05	Peak	100	39	P
6	11200.00	17.07	30.17	47.24	54.00	-6.76	Average	100	213	P
7	11200.00	17.07	43.63	60.70	74.00	-13.30	Peak	100	213	P
8	16800.00	21.73	42.36	64.09	68.20	-4.11	Peak	100	325	P

Note: Level=Reading+Factor  
 Margin=Level-Limit  
 Factor=Antenna Factor + cable loss - Amplifier Factor





Power	: AC 120V / 60Hz from Adapter	Pol/Phase	: VERTICAL
Test Mode	: Mode 6, Band 3, CH140		

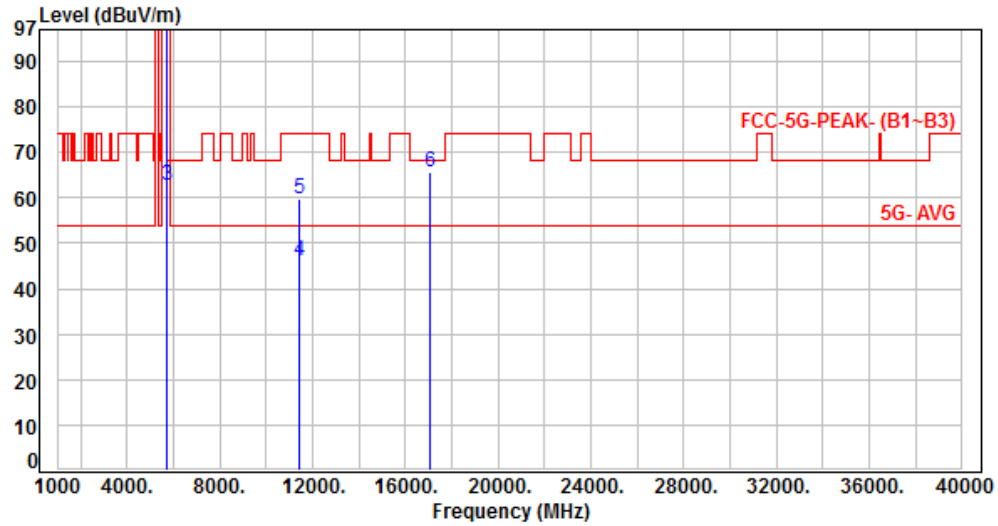

No.	Frequency (MHz)	Factor (dB)	Reading (dBuV)	Level (dBuV/m)	Limit (dBuV/m)	Margin (dB)	Detector	Height (cm)	Azimuth (deg)	P/F
1	5700.00	7.37	93.02	100.39	200.00	-99.61	Average	101	14	P
2	5700.00	7.37	106.70	114.07	200.00	-85.93	Peak	101	14	P
3	5725.00	7.33	55.25	62.58	68.20	-5.62	Peak	101	14	P
4	11400.00	17.31	28.93	46.24	54.00	-7.76	Average	100	344	P
5	11400.00	17.31	42.39	59.70	74.00	-14.30	Peak	100	344	P
6	17100.00	23.23	42.44	65.67	68.20	-2.53	Peak	100	110	P

Note: Level=Reading+Factor  
 Margin=Level-Limit  
 Factor=Antenna Factor + cable loss - Amplifier Factor



Power	: AC 120V / 60Hz from Adapter	Pol/Phase	: HORIZONTAL
Test Mode	: Mode 6, Band 3, CH140		:

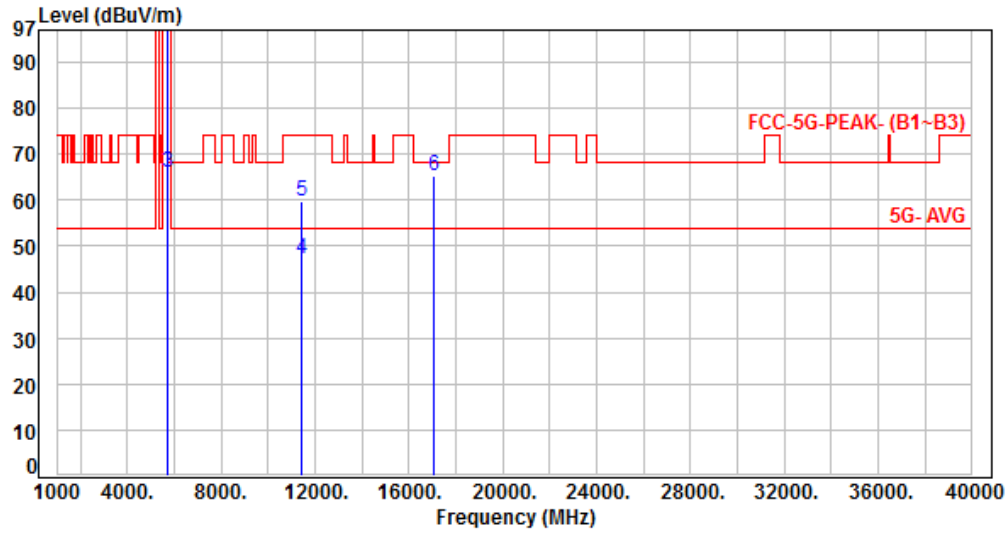

No.	Frequency (MHz)	Factor (dB)	Reading (dBuV)	Level (dBuV/m)	Limit (dBuV/m)	Margin (dB)	Detector	Height (cm)	Azimuth (deg)	P/F
1	5700.00	7.37	96.17	103.54	200.00	-96.46	Average	278	299	P
2	5700.00	7.37	108.76	116.13	200.00	-83.87	Peak	278	299	P
3	5725.00	7.33	58.75	66.08	68.20	-2.12	Peak	278	299	P
4	11400.00	17.31	29.83	47.14	54.00	-6.86	Average	100	219	P
5	11400.00	17.31	42.33	59.64	74.00	-14.36	Peak	100	219	P
6	17100.00	23.23	41.94	65.17	68.20	-3.03	Peak	100	324	P

Note: Level=Reading+Factor  
 Margin=Level-Limit  
 Factor=Antenna Factor + cable loss - Amplifier Factor



Power	: AC 120V / 60Hz from Adapter	Pol/Phase	: VERTICAL
Test Mode	: Mode 7, Band 3, CH102		

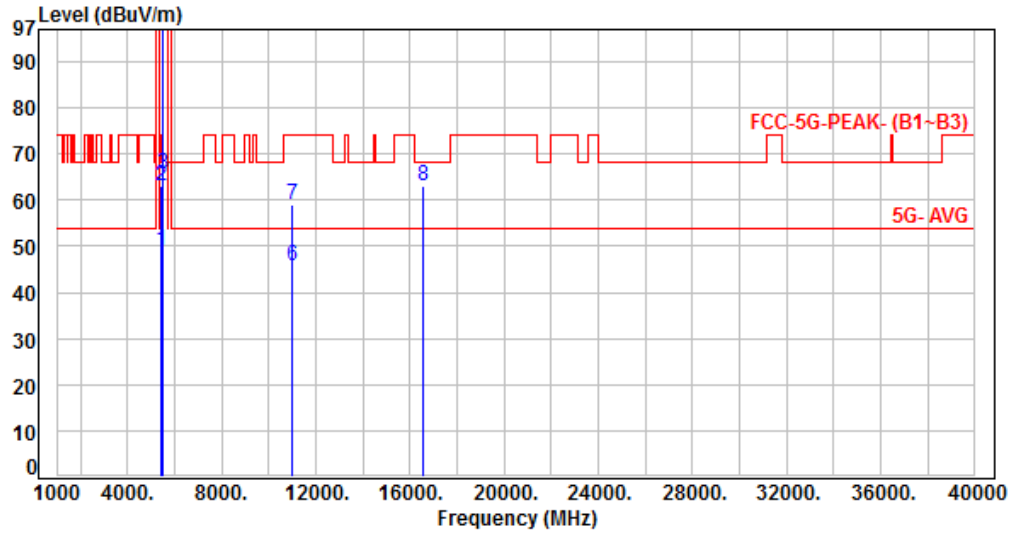

No.	Frequency (MHz)	Factor (dB)	Reading (dBuV)	Level (dBuV/m)	Limit (dBuV/m)	Margin (dB)	Detector	Height (cm)	Azimuth (deg)	P/F
1	5460.00	7.45	41.47	48.92	54.00	-5.08	Average	100	349	P
2	5460.00	7.45	55.75	63.20	74.00	-10.80	Peak	100	349	P
3	5470.00	7.46	58.04	65.50	68.20	-2.70	Peak	100	349	P
4	5510.00	7.47	89.80	97.27	200.00	-102.73	Average	100	349	P
5	5510.00	7.47	101.63	109.10	200.00	-90.90	Peak	100	349	P
6	11020.00	16.81	28.85	45.66	54.00	-8.34	Average	100	329	P
7	11020.00	16.81	42.19	59.00	74.00	-15.00	Peak	100	329	P
8	16530.00	20.00	43.18	63.18	68.20	-5.02	Peak	100	112	P

Note: Level=Reading+Factor  
 Margin=Level-Limit  
 Factor=Antenna Factor + cable loss - Amplifier Factor



Power	: AC 120V / 60Hz from Adapter	Pol/Phase	: HORIZONTAL
Test Mode	: Mode 7, Band 3, CH102		

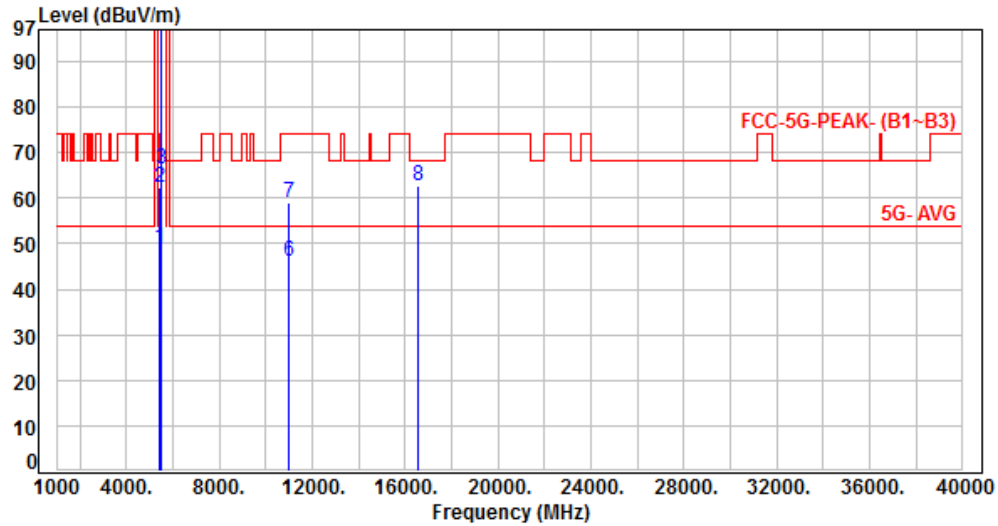

No.	Frequency (MHz)	Factor (dB)	Reading (dBuV)	Level (dBuV/m)	Limit (dBuV/m)	Margin (dB)	Detector	Height (cm)	Azimuth (deg)	P/F
1	5460.00	7.45	41.46	48.91	54.00	-5.09	Average	312	298	P
2	5460.00	7.45	54.79	62.24	74.00	-11.76	Peak	312	298	P
3	5470.00	7.46	59.10	66.56	68.20	-1.64	Peak	312	298	P
4	5510.00	7.47	92.01	99.48	200.00	-100.52	Average	312	298	P
5	5510.00	7.47	103.76	111.23	200.00	-88.77	Peak	312	298	P
6	11020.00	16.81	29.28	46.09	54.00	-7.91	Average	100	214	P
7	11020.00	16.81	42.31	59.12	74.00	-14.88	Peak	100	214	P
8	16530.00	20.00	42.59	62.59	68.20	-5.61	Peak	100	326	P

Note: Level=Reading+Factor  
 Margin=Level-Limit  
 Factor=Antenna Factor + cable loss - Amplifier Factor



Power	: AC 120V / 60Hz from Adapter	Pol/Phase	: VERTICAL
Test Mode	: Mode 7, Band 3, CH118		

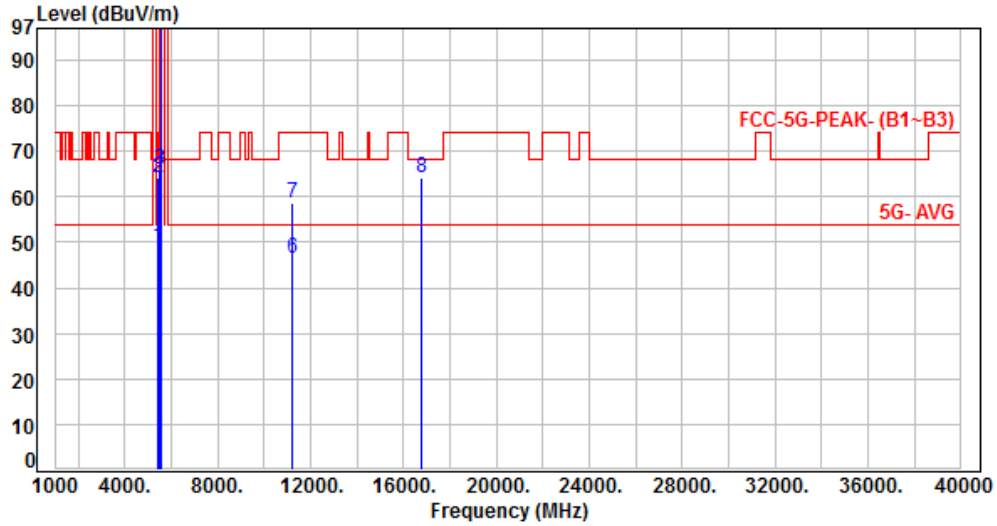

No.	Frequency (MHz)	Factor (dB)	Reading (dBuV)	Level (dBuV/m)	Limit (dBuV/m)	Margin (dB)	Detector	Height (cm)	Azimuth (deg)	P/F
1	5460.00	7.45	41.45	48.90	54.00	-5.10	Average	100	321	P
2	5460.00	7.45	56.91	64.36	74.00	-9.64	Peak	100	321	P
3	5470.00	7.46	58.42	65.88	68.20	-2.32	Peak	100	321	P
4	5590.00	7.43	93.02	100.45	200.00	-99.55	Average	100	321	P
5	5590.00	7.43	105.46	112.89	200.00	-87.11	Peak	100	321	P
6	11180.00	17.06	29.39	46.45	54.00	-7.55	Average	100	336	P
7	11180.00	17.06	41.73	58.79	74.00	-15.21	Peak	100	336	P
8	16770.00	21.68	42.58	64.26	68.20	-3.94	Peak	100	110	P

Note: Level=Reading+Factor  
 Margin=Level-Limit  
 Factor=Antenna Factor + cable loss - Amplifier Factor



Power	: AC 120V / 60Hz from Adapter	Pol/Phase	: HORIZONTAL
Test Mode	: Mode 7, Band 3, CH118		:

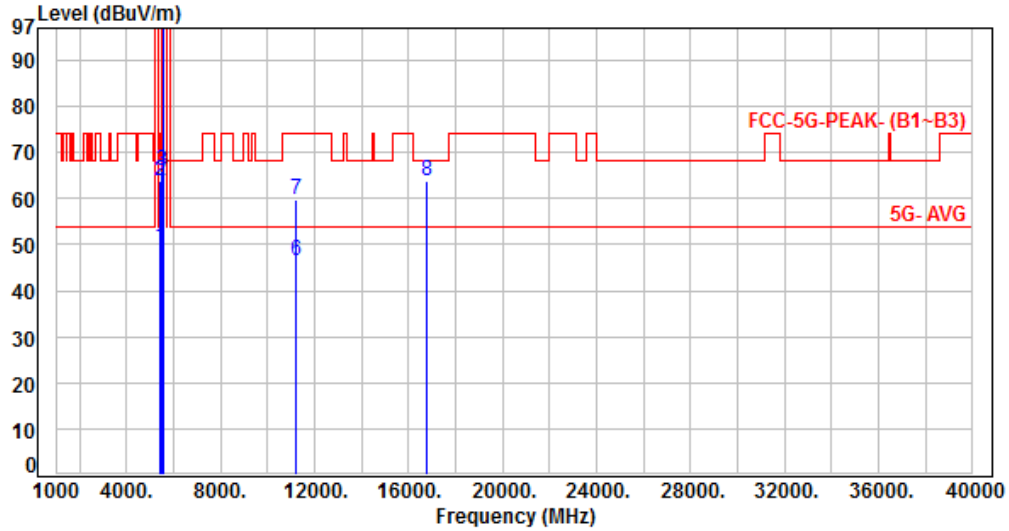

No.	Frequency (MHz)	Factor (dB)	Reading (dBuV)	Level (dBuV/m)	Limit (dBuV/m)	Margin (dB)	Detector	Height (cm)	Azimuth (deg)	P/F
1	5460.00	7.45	41.92	49.37	54.00	-4.63	Average	107	41	P
2	5460.00	7.45	56.54	63.99	74.00	-10.01	Peak	107	41	P
3	5470.00	7.46	58.44	65.90	68.20	-2.30	Peak	107	41	P
4	5590.00	7.43	94.27	101.70	200.00	-98.30	Average	107	41	P
5	5590.00	7.43	106.60	114.03	200.00	-85.97	Peak	107	41	P
6	11180.00	17.06	29.39	46.45	54.00	-7.55	Average	100	220	P
7	11180.00	17.06	42.83	59.89	74.00	-14.11	Peak	100	220	P
8	16770.00	21.68	42.08	63.76	68.20	-4.44	Peak	100	323	P

Note: Level=Reading+Factor  
 Margin=Level-Limit  
 Factor=Antenna Factor + cable loss - Amplifier Factor



Power	: AC 120V / 60Hz from Adapter	Pol/Phase	: VERTICAL
Test Mode	: Mode 7, Band 3, CH134		

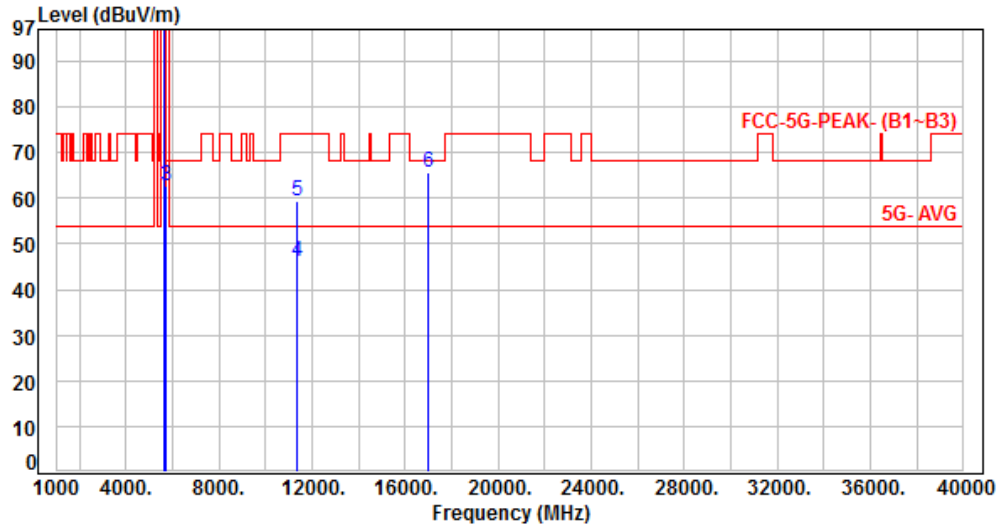

No.	Frequency (MHz)	Factor (dB)	Reading (dBuV)	Level (dBuV/m)	Limit (dBuV/m)	Margin (dB)	Detector	Height (cm)	Azimuth (deg)	P/F
1	5670.00	7.36	89.87	97.23	200.00	-102.77	Average	101	13	P
2	5670.00	7.36	102.07	109.43	200.00	-90.57	Peak	101	13	P
3	5725.00	7.33	55.34	62.67	68.20	-5.53	Peak	101	13	P
4	11340.00	17.17	28.98	46.15	54.00	-7.85	Average	100	336	P
5	11340.00	17.17	42.37	59.54	74.00	-14.46	Peak	100	336	P
6	17010.00	23.12	42.60	65.72	68.20	-2.48	Peak	100	103	P

Note: Level=Reading+Factor  
 Margin=Level-Limit  
 Factor=Antenna Factor + cable loss - Amplifier Factor



Power	: AC 120V / 60Hz from Adapter	Pol/Phase	: HORIZONTAL
Test Mode	: Mode 7, Band 3, CH134		

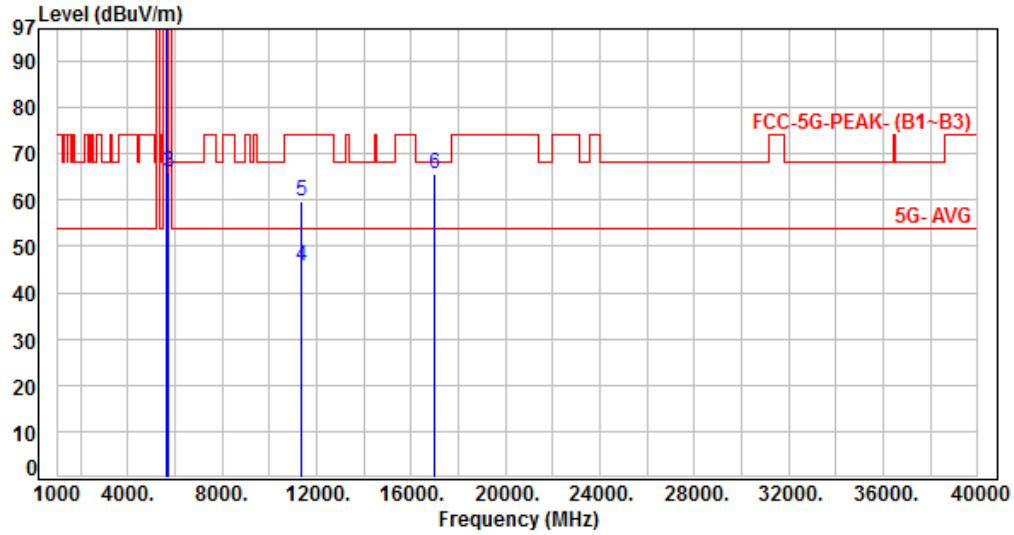

No.	Frequency (MHz)	Factor (dB)	Reading (dBuV)	Level (dBuV/m)	Limit (dBuV/m)	Margin (dB)	Detector	Height (cm)	Azimuth (deg)	P/F
1	5670.00	7.36	93.27	100.63	200.00	-99.37	Average	268	297	P
2	5670.00	7.36	105.35	112.71	200.00	-87.29	Peak	268	297	P
3	5725.00	7.33	58.81	66.14	68.20	-2.06	Peak	268	297	P
4	11340.00	17.17	28.45	45.62	54.00	-8.38	Average	100	219	P
5	11340.00	17.17	42.46	59.63	74.00	-14.37	Peak	100	219	P
6	17010.00	23.12	42.39	65.51	68.20	-2.69	Peak	100	324	P

Note: Level=Reading+Factor  
Margin=Level-Limit  
Factor=Antenna Factor + cable loss - Amplifier Factor





Power	: AC 120V / 60Hz from Adapter	Pol/Phase	: VERTICAL
Test Mode	: Mode 8, Band 3, CH106		:

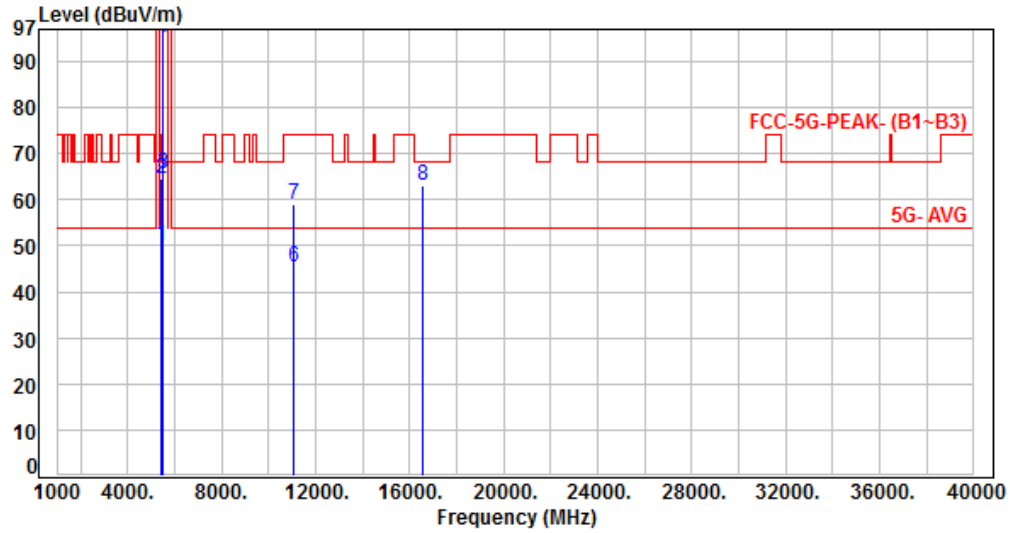

No.	Frequency (MHz)	Factor (dB)	Reading (dBuV)	Level (dBuV/m)	Limit (dBuV/m)	Margin (dB)	Detector	Height (cm)	Azimuth (deg)	P/F
1	5460.00	7.45	42.77	50.22	54.00	-3.78	Average	102	6	P
2	5460.00	7.45	57.01	64.46	74.00	-9.54	Peak	102	6	P
3	5470.00	7.46	58.22	65.68	68.20	-2.52	Peak	102	6	P
4	5530.00	7.44	87.64	95.08	200.00	-104.92	Average	102	6	P
5	5530.00	7.44	100.72	108.16	200.00	-91.84	Peak	102	6	P
6	11060.00	16.82	28.72	45.54	54.00	-8.46	Average	100	345	P
7	11060.00	16.82	42.16	58.98	74.00	-15.02	Peak	100	345	P
8	16590.00	20.46	42.55	63.01	68.20	-5.19	Peak	100	112	P

Note: Level=Reading+Factor  
 Margin=Level-Limit  
 Factor=Antenna Factor + cable loss - Amplifier Factor



Power	: AC 120V / 60Hz from Adapter	Pol/Phase	: HORIZONTAL
Test Mode	: Mode 8, Band 3, CH106		:

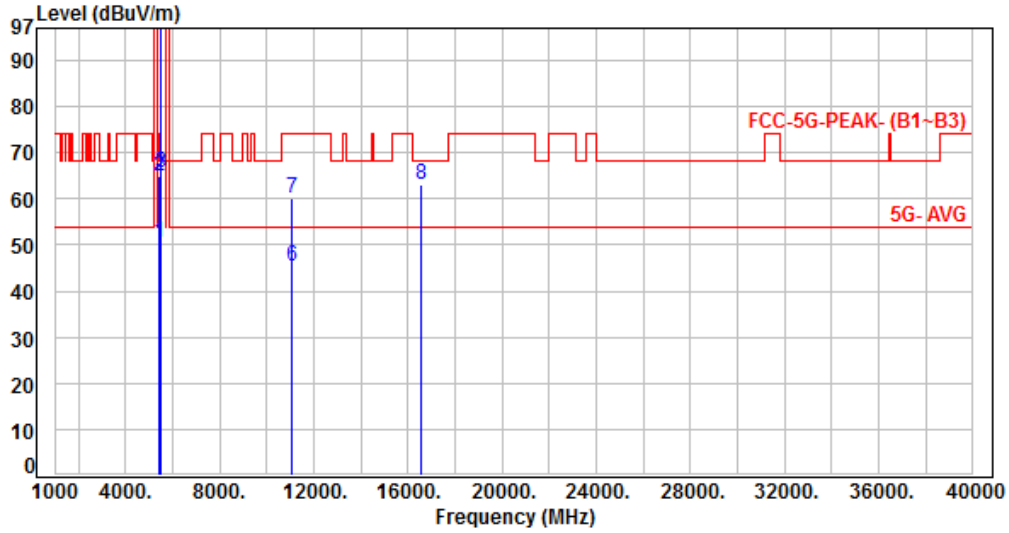

No.	Frequency (MHz)	Factor (dB)	Reading (dBuV)	Level (dBuV/m)	Limit (dBuV/m)	Margin (dB)	Detector	Height (cm)	Azimuth (deg)	P/F
1	5460.00	7.45	43.24	50.69	54.00	-3.31	Average	325	297	P
2	5460.00	7.45	57.31	64.76	74.00	-9.24	Peak	325	297	P
3	5470.00	7.46	58.20	65.66	68.20	-2.54	Peak	325	297	P
4	5530.00	7.44	90.10	97.54	200.00	-102.46	Average	325	297	P
5	5530.00	7.44	103.82	111.26	200.00	-88.74	Peak	325	297	P
6	11060.00	16.82	28.59	45.41	54.00	-8.59	Average	100	216	P
7	11060.00	16.82	43.14	59.96	74.00	-14.04	Peak	100	216	P
8	16590.00	20.46	42.75	63.21	68.20	-4.99	Peak	100	331	P

Note: Level=Reading+Factor  
 Margin=Level-Limit  
 Factor=Antenna Factor + cable loss - Amplifier Factor



Power	: AC 120V / 60Hz from Adapter	Pol/Phase	: VERTICAL
Test Mode	: Mode 8, Band 3, CH122		

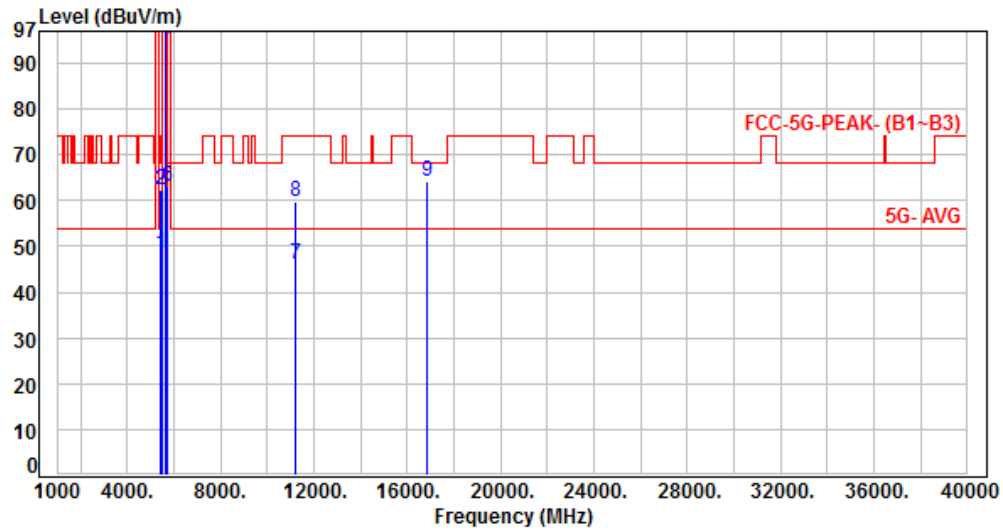

No.	Frequency (MHz)	Factor (dB)	Reading (dBuV)	Level (dBuV/m)	Limit (dBuV/m)	Margin (dB)	Detector	Height (cm)	Azimuth (deg)	P/F
1	5460.00	7.45	41.01	48.46	54.00	-5.54	Average	100	14	P
2	5460.00	7.45	54.96	62.41	74.00	-11.59	Peak	100	14	P
3	5470.00	7.46	55.01	62.47	68.20	-5.73	Peak	100	14	P
4	5610.00	7.42	87.71	95.13	200.00	-104.87	Average	100	14	P
5	5610.00	7.42	101.01	108.43	200.00	-91.57	Peak	100	14	P
6	5725.00	7.33	55.73	63.06	68.20	-5.14	Peak	100	14	P
7	11220.00	17.09	29.16	46.25	54.00	-7.75	Average	100	347	P
8	11220.00	17.09	42.49	59.58	74.00	-14.42	Peak	100	347	P
9	16830.00	21.79	42.30	64.09	68.20	-4.11	Peak	100	100	P

Note: Level=Reading+Factor  
 Margin=Level-Limit  
 Factor=Antenna Factor + cable loss - Amplifier Factor



Power	: AC 120V / 60Hz from Adapter	Pol/Phase	: HORIZONTAL
Test Mode	: Mode 8, Band 3, CH122		

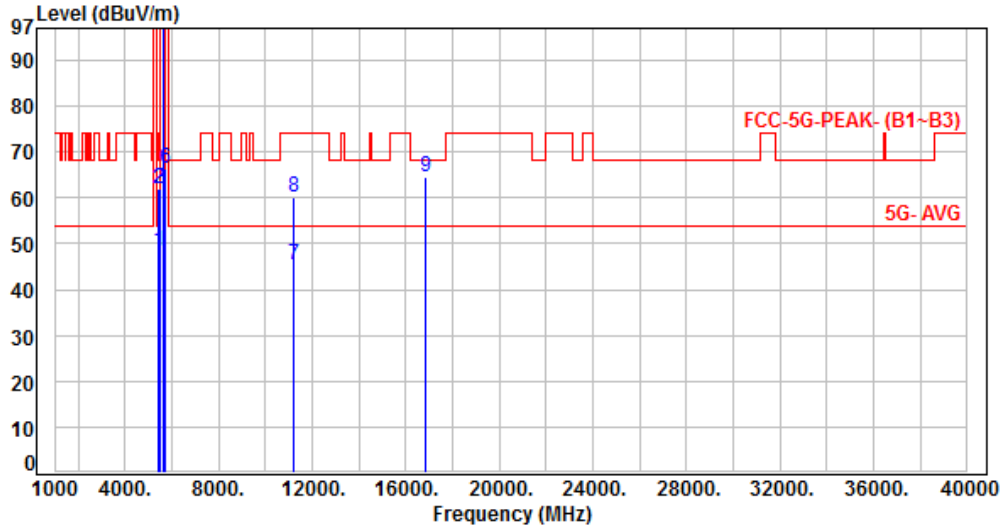

No.	Frequency (MHz)	Factor (dB)	Reading (dBuV)	Level (dBuV/m)	Limit (dBuV/m)	Margin (dB)	Detector	Height (cm)	Azimuth (deg)	P/F
1	5460.00	7.45	40.98	48.43	54.00	-5.57	Average	301	297	P
2	5460.00	7.45	54.34	61.79	74.00	-12.21	Peak	301	297	P
3	5470.00	7.46	54.65	62.11	68.20	-6.09	Peak	301	297	P
4	5610.00	7.42	90.48	97.90	200.00	-102.10	Average	301	297	P
5	5610.00	7.42	102.99	110.41	200.00	-89.59	Peak	301	297	P
6	5725.00	7.33	58.91	66.24	68.20	-1.96	Peak	301	297	P
7	11220.00	17.09	28.40	45.49	54.00	-8.51	Average	100	222	P
8	11220.00	17.09	43.19	60.28	74.00	-13.72	Peak	100	222	P
9	16830.00	21.79	42.82	64.61	68.20	-3.59	Peak	100	322	P

Note: Level=Reading+Factor  
 Margin=Level-Limit  
 Factor=Antenna Factor + cable loss - Amplifier Factor



Power	: AC 120V / 60Hz from Adapter	Pol/Phase	: VERTICAL
Test Mode	: Mode 9, Band 3, CH114		

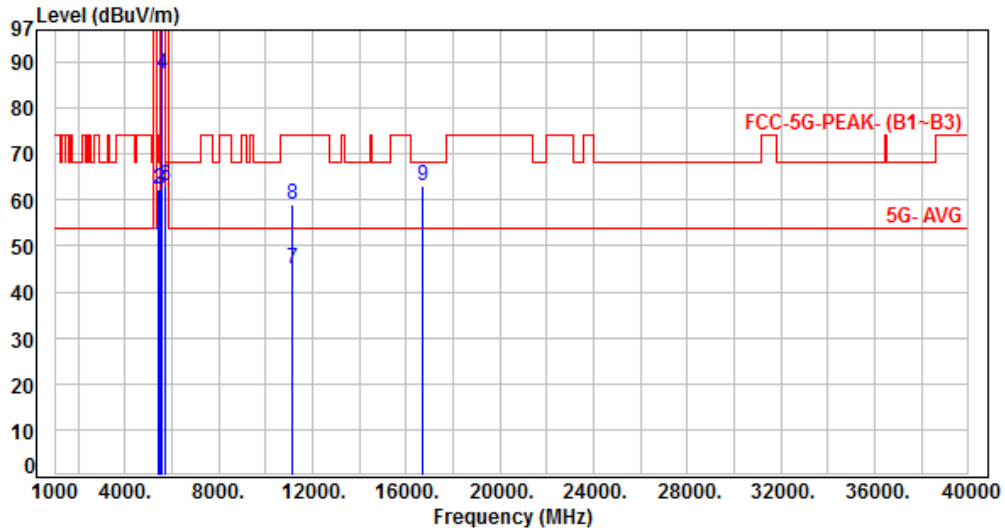

No.	Frequency (MHz)	Factor (dB)	Reading (dBuV)	Level (dBuV/m)	Limit (dBuV/m)	Margin (dB)	Detector	Height (cm)	Azimuth (deg)	P/F
1	5460.00	7.45	42.58	50.03	54.00	-3.97	Average	106	8	P
2	5460.00	7.45	54.76	62.21	74.00	-11.79	Peak	106	8	P
3	5470.00	7.46	54.90	62.36	68.20	-5.84	Peak	106	8	P
4	5570.00	7.42	80.08	87.50	200.00	-112.50	Average	106	8	P
5	5570.00	7.42	92.29	99.71	200.00	-100.29	Peak	106	8	P
6	5725.00	7.33	55.79	63.12	68.20	-5.08	Peak	106	8	P
7	11140.00	16.67	28.36	45.03	54.00	-8.97	Average	100	93	P
8	11140.00	16.67	42.16	58.83	74.00	-15.17	Peak	100	93	P
9	16710.00	20.44	42.64	63.08	68.20	-5.12	Peak	100	166	P

Note: Level=Reading+Factor  
Margin=Level-Limit  
Factor=Antenna Factor + cable loss - Amplifier Factor



Power	: AC 120V / 60Hz from Adapter	Pol/Phase	: HORIZONTAL
Test Mode	: Mode 9, Band 3, CH114		

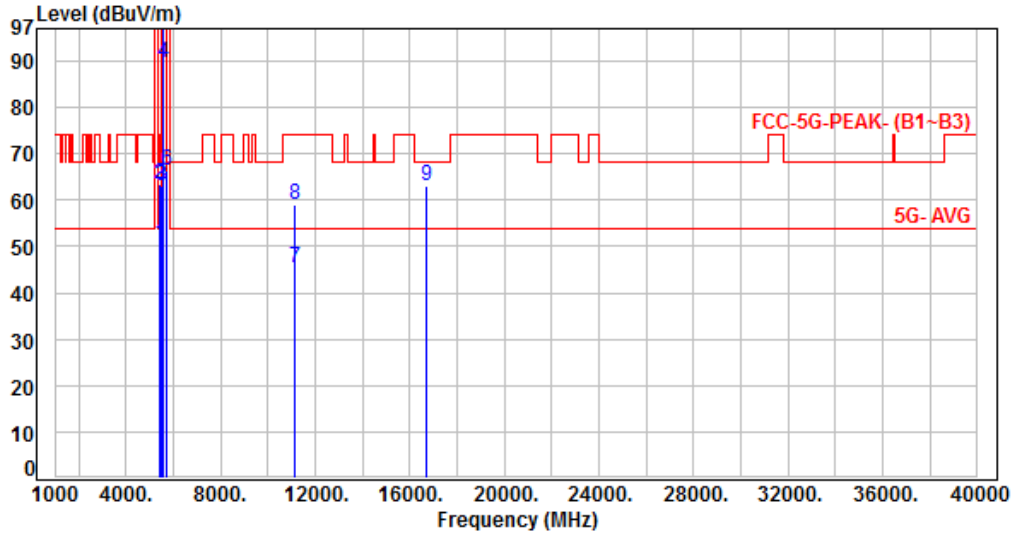

No.	Frequency (MHz)	Factor (dB)	Reading (dBuV)	Level (dBuV/m)	Limit (dBuV/m)	Margin (dB)	Detector	Height (cm)	Azimuth (deg)	P/F
1	5460.00	7.45	42.97	50.42	54.00	-3.58	Average	321	293	P
2	5460.00	7.45	55.86	63.31	74.00	-10.69	Peak	321	293	P
3	5470.00	7.46	55.54	63.00	68.20	-5.20	Peak	321	293	P
4	5570.00	7.42	82.18	89.60	200.00	-110.40	Average	321	293	P
5	5570.00	7.42	93.41	100.83	200.00	-99.17	Peak	321	293	P
6	5725.00	7.33	59.06	66.39	68.20	-1.81	Peak	321	293	P
7	11140.00	16.67	28.73	45.40	54.00	-8.60	Average	100	168	P
8	11140.00	16.67	42.34	59.01	74.00	-14.99	Peak	100	168	P
9	16710.00	20.44	42.68	63.12	68.20	-5.08	Peak	100	265	P

Note: Level=Reading+Factor  
 Margin=Level-Limit  
 Factor=Antenna Factor + cable loss - Amplifier Factor



Power	: AC 120V / 60Hz from Adapter	Pol/Phase	: VERTICAL
Test Mode	: Mode 1, Band 3 Straddle Channel, CH144		:

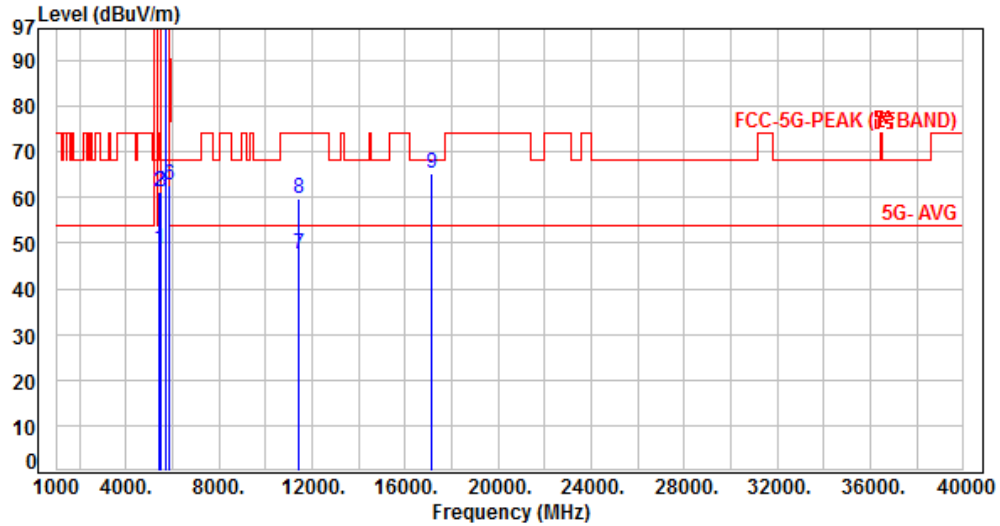

No.	Frequency (MHz)	Factor (dB)	Reading (dBuV)	Level (dBuV/m)	Limit (dBuV/m)	Margin (dB)	Detector	Height (cm)	Azimuth P/F (deg)
1	5460.00	7.45	41.26	48.71	54.00	-5.29	Average	109	14 P
2	5460.00	7.45	53.82	61.27	74.00	-12.73	Peak	109	14 P
3	5470.00	7.46	53.79	61.25	68.20	-6.95	Peak	109	14 P
4	5720.00	7.34	99.16	106.50	200.00	-93.50	Average	109	14 P
5	5720.00	7.34	108.79	116.13	200.00	-83.87	Peak	109	14 P
6	5850.00	7.43	55.10	62.53	122.20	-59.67	Peak	109	14 P
7	11440.00	17.03	30.48	47.51	54.00	-6.49	Average	100	251 P
8	11440.00	17.03	42.56	59.59	74.00	-14.41	Peak	100	251 P
9	17160.00	22.27	43.11	65.38	68.20	-2.82	Peak	100	113 P

Note: Level=Reading+Factor  
 Margin=Level-Limit  
 Factor=Antenna Factor + cable loss - Amplifier Factor



Power	: AC 120V / 60Hz from Adapter	Pol/Phase	: HORIZONTAL
Test Mode	: Mode 1, Band 3 Straddle Channel, CH144		:

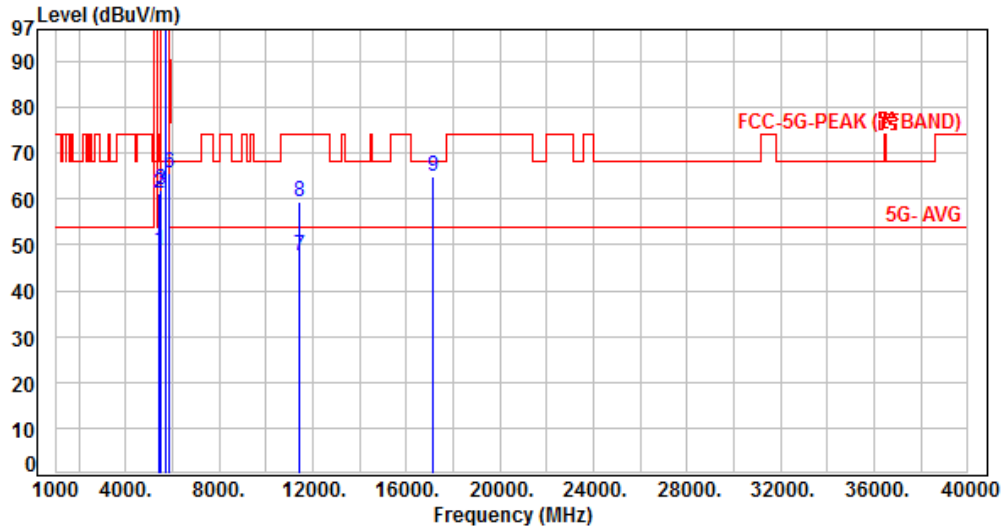

No.	Frequency (MHz)	Factor (dB)	Reading (dBuV)	Level (dBuV/m)	Limit (dBuV/m)	Margin (dB)	Detector	Height (cm)	Azimuth (deg)	P/F
1	5460.00	7.45	41.27	48.72	54.00	-5.28	Average	252	291	P
2	5460.00	7.45	53.94	61.39	74.00	-12.61	Peak	252	291	P
3	5470.00	7.46	54.59	62.05	68.20	-6.15	Peak	252	291	P
4	5720.00	7.34	102.98	110.32	200.00	-89.68	Average	252	291	P
5	5720.00	7.34	112.79	120.13	200.00	-79.87	Peak	252	291	P
6	5850.00	7.43	58.04	65.47	122.20	-56.73	Peak	252	291	P
7	11440.00	17.03	30.55	47.58	54.00	-6.42	Average	100	311	P
8	11440.00	17.03	42.39	59.42	74.00	-14.58	Peak	100	311	P
9	17160.00	22.27	42.72	64.99	68.20	-3.21	Peak	100	85	P

Note: Level=Reading+Factor  
Margin=Level-Limit  
Factor=Antenna Factor + cable loss - Amplifier Factor





Power	: AC 120V / 60Hz from Adapter	Pol/Phase	: VERTICAL
Test Mode	: Mode 6, Band 3 Straddle Channel, CH144		:

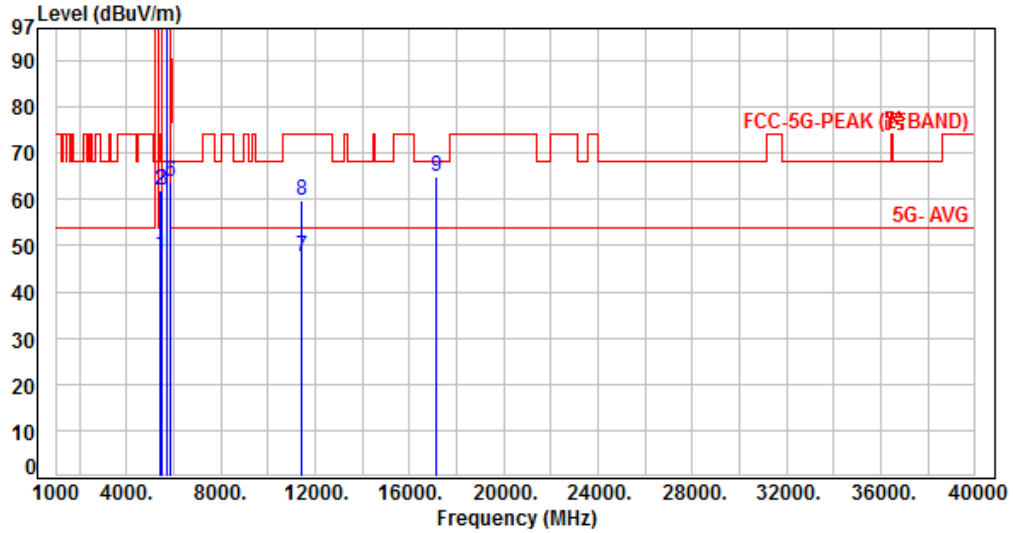

No.	Frequency (MHz)	Factor (dB)	Reading (dBuV)	Level (dBuV/m)	Limit (dBuV/m)	Margin (dB)	Detector	Height (cm)	Azimuth (deg)	P/F
1	5460.00	7.45	40.68	48.13	54.00	-5.87	Average	100	15	P
2	5460.00	7.45	54.62	62.07	74.00	-11.93	Peak	100	15	P
3	5470.00	7.46	54.38	61.84	68.20	-6.36	Peak	100	15	P
4	5720.00	7.34	98.15	105.49	200.00	-94.51	Average	100	15	P
5	5720.00	7.34	110.76	118.10	200.00	-81.90	Peak	100	15	P
6	5850.00	7.43	56.42	63.85	122.20	-58.35	Peak	100	15	P
7	11440.00	17.03	30.65	47.68	54.00	-6.32	Average	100	278	P
8	11440.00	17.03	42.63	59.66	74.00	-14.34	Peak	100	278	P
9	17160.00	22.27	42.58	64.85	68.20	-3.35	Peak	100	317	P

Note: Level=Reading+Factor  
Margin=Level-Limit  
Factor=Antenna Factor + cable loss - Amplifier Factor



Power	: AC 120V / 60Hz from Adapter	Pol/Phase	: HORIZONTAL
Test Mode	: Mode 6, Band 3 Straddle Channel, CH144		:

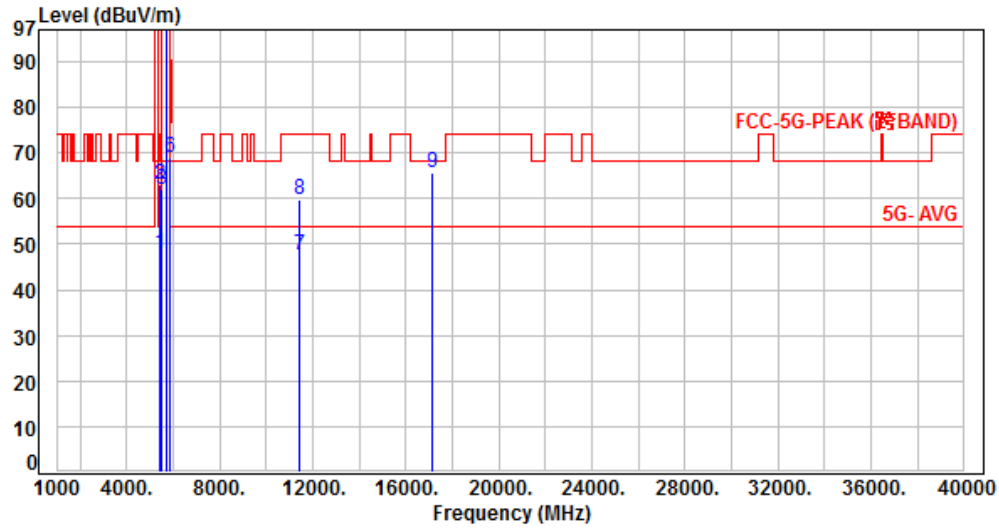

No.	Frequency (MHz)	Factor (dB)	Reading (dBuV)	Level (dBuV/m)	Limit (dBuV/m)	Margin (dB)	Detector	Height (cm)	Azimuth (deg)	P/F
1	5460.00	7.45	40.61	48.06	54.00	-5.94	Average	237	292	P
2	5460.00	7.45	55.47	62.92	74.00	-11.08	Peak	237	292	P
3	5470.00	7.46	54.68	62.14	68.20	-6.06	Peak	237	292	P
4	5720.00	7.34	101.80	109.14	200.00	-90.86	Average	237	292	P
5	5720.00	7.34	133.85	141.19	200.00	-58.81	Peak	237	292	P
6	5850.00	7.43	61.63	69.06	122.20	-53.14	Peak	237	292	P
7	11440.00	17.03	30.72	47.75	54.00	-6.25	Average	100	247	P
8	11440.00	17.03	42.80	59.83	74.00	-14.17	Peak	100	247	P
9	17160.00	22.27	43.36	65.63	68.20	-2.57	Peak	100	194	P

Note: Level=Reading+Factor  
Margin=Level-Limit  
Factor=Antenna Factor + cable loss - Amplifier Factor



Power	: AC 120V / 60Hz from Adapter	Pol/Phase	: VERTICAL
Test Mode	: Mode 7, Band 3 Straddle Channel, CH142		

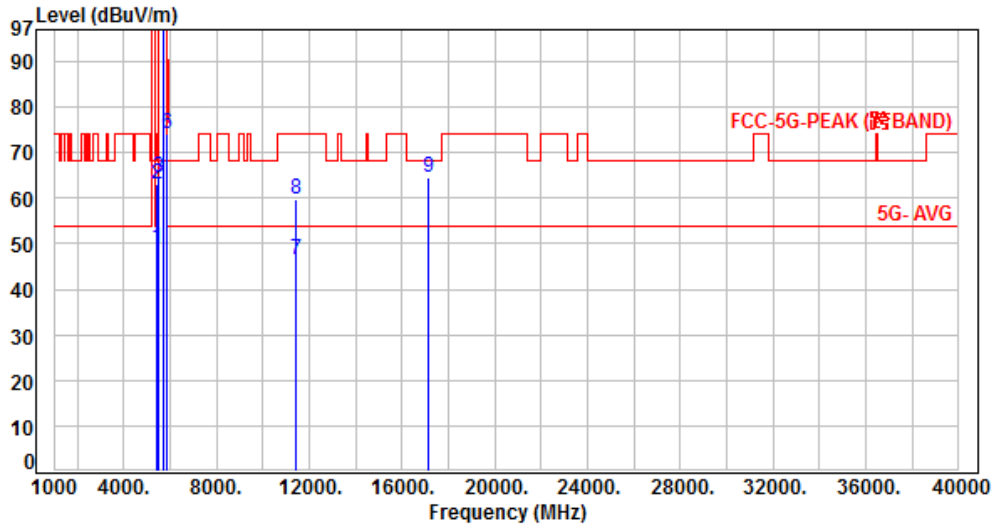

No.	Frequency (MHz)	Factor (dB)	Reading (dBuV)	Level (dBuV/m)	Limit (dBuV/m)	Margin (dB)	Detector	Height (cm)	Azimuth (deg)	P/F
1	5460.00	7.45	41.70	49.15	54.00	-4.85	Average	100	16	P
2	5460.00	7.45	55.74	63.19	74.00	-10.81	Peak	100	16	P
3	5470.00	7.46	57.06	64.52	68.20	-3.68	Peak	100	16	P
4	5710.00	7.36	95.08	102.44	200.00	-97.56	Average	100	16	P
5	5710.00	7.36	107.52	114.88	200.00	-85.12	Peak	100	16	P
6	5850.00	7.43	66.71	74.14	122.20	-48.06	Peak	100	16	P
7	11420.00	16.98	29.47	46.45	54.00	-7.55	Average	100	328	P
8	11420.00	16.98	42.72	59.70	74.00	-14.30	Peak	100	328	P
9	17130.00	22.21	42.26	64.47	68.20	-3.73	Peak	100	227	P

Note: Level=Reading+Factor  
 Margin=Level-Limit  
 Factor=Antenna Factor + cable loss - Amplifier Factor



Power	: AC 120V / 60Hz from Adapter	Pol/Phase	: HORIZONTAL
Test Mode	: Mode 7, Band 3 Straddle Channel, CH142		:

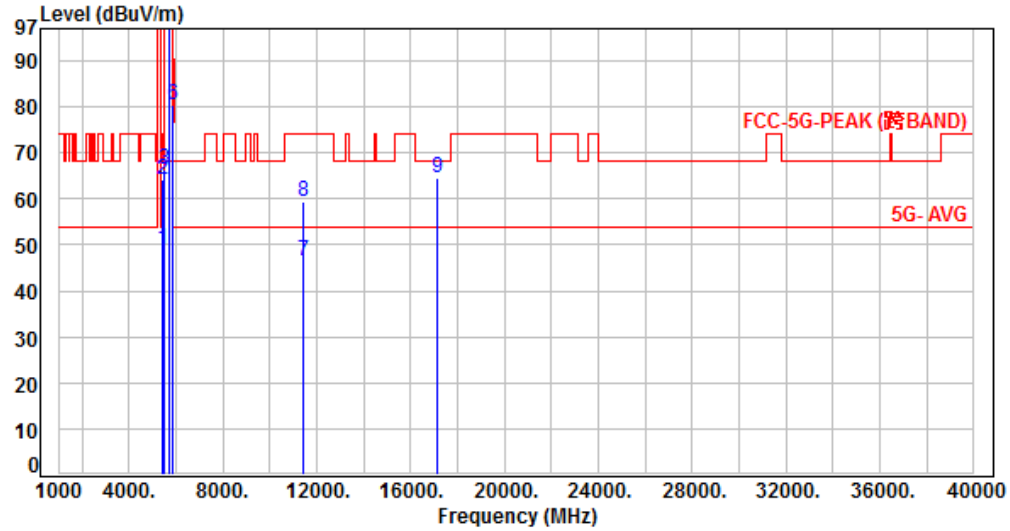

No.	Frequency (MHz)	Factor (dB)	Reading (dBuV)	Level (dBuV/m)	Limit (dBuV/m)	Margin (dB)	Detector	Height (cm)	Azimuth (deg)	P/F
1	5460.00	7.45	41.72	49.17	54.00	-4.83	Average	253	295	P
2	5460.00	7.45	56.72	64.17	74.00	-9.83	Peak	253	295	P
3	5470.00	7.46	58.94	66.40	68.20	-1.80	Peak	253	295	P
4	5710.00	7.36	99.00	106.36	200.00	-93.64	Average	253	295	P
5	5710.00	7.36	111.07	118.43	200.00	-81.57	Peak	253	295	P
6	5850.00	7.43	72.83	80.26	122.20	-41.94	Peak	253	295	P
7	11420.00	16.98	29.52	46.50	54.00	-7.50	Average	100	165	P
8	11420.00	16.98	42.34	59.32	74.00	-14.68	Peak	100	165	P
9	17130.00	22.21	42.48	64.69	68.20	-3.51	Peak	100	206	P

Note: Level=Reading+Factor  
Margin=Level-Limit  
Factor=Antenna Factor + cable loss - Amplifier Factor



Power	: AC 120V / 60Hz from Adapter	Pol/Phase	: VERTICAL
Test Mode	: Mode 8, Band 3 Straddle Channel, CH138		:

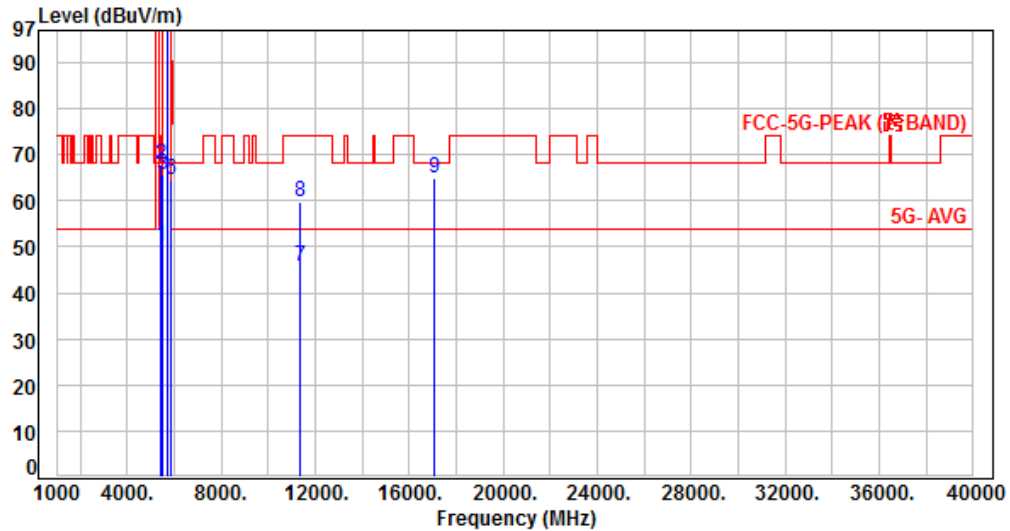

No.	Frequency (MHz)	Factor (dB)	Reading (dBuV)	Level (dBuV/m)	Limit (dBuV/m)	Margin (dB)	Detector	Height (cm)	Azimuth (deg)	P/F
1	5460.00	7.45	42.88	50.33	54.00	-3.67	Average	100	13	P
2	5460.00	7.45	60.25	67.70	74.00	-6.30	Peak	100	13	P
3	5470.00	7.46	58.04	65.50	68.20	-2.70	Peak	100	13	P
4	5690.00	7.37	90.07	97.44	200.00	-102.56	Average	100	13	P
5	5690.00	7.37	102.89	110.26	200.00	-89.74	Peak	100	13	P
6	5850.00	7.43	57.16	64.59	122.20	-57.61	Peak	100	13	P
7	11380.00	16.87	28.94	45.81	54.00	-8.19	Average	100	93	P
8	11380.00	16.87	42.85	59.72	74.00	-14.28	Peak	100	93	P
9	17070.00	22.13	42.84	64.97	68.20	-3.23	Peak	100	224	P

Note: Level=Reading+Factor  
Margin=Level-Limit  
Factor=Antenna Factor + cable loss - Amplifier Factor



Power	: AC 120V / 60Hz from Adapter	Pol/Phase	: HORIZONTAL
Test Mode	: Mode 8, Band 3 Straddle Channel, CH138		:

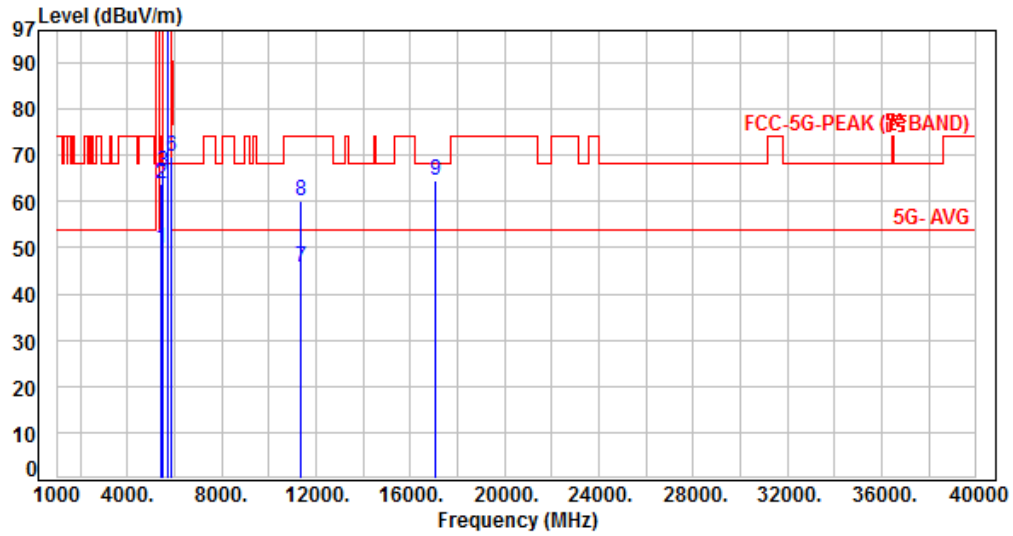

No.	Frequency (MHz)	Factor (dB)	Reading (dBuV)	Level (dBuV/m)	Limit (dBuV/m)	Margin (dB)	Detector	Height (cm)	Azimuth (deg)	P/F
1	5460.00	7.45	42.18	49.63	54.00	-4.37	Average	263	290	P
2	5460.00	7.45	56.53	63.98	74.00	-10.02	Peak	263	290	P
3	5470.00	7.46	58.91	66.37	68.20	-1.83	Peak	263	290	P
4	5690.00	7.37	92.79	100.16	200.00	-99.84	Average	263	290	P
5	5690.00	7.37	105.96	113.33	200.00	-86.67	Peak	263	290	P
6	5850.00	7.43	62.27	69.70	122.20	-52.50	Peak	263	290	P
7	11380.00	16.87	28.93	45.80	54.00	-8.20	Average	100	261	P
8	11380.00	16.87	43.18	60.05	74.00	-13.95	Peak	100	261	P
9	17070.00	22.13	42.51	64.64	68.20	-3.56	Peak	100	115	P

Note: Level=Reading+Factor  
Margin=Level-Limit  
Factor=Antenna Factor + cable loss - Amplifier Factor



Power	: AC 120V / 60Hz from Adapter	Pol/Phase	: VERTICAL
Test Mode	: Mode 1, Band 4, CH149		

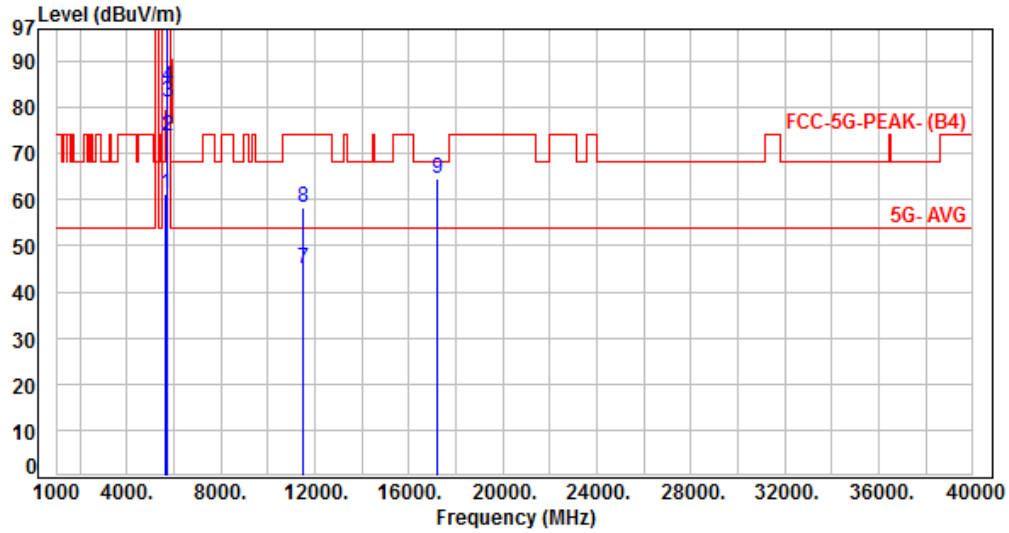

No.	Frequency (MHz)	Factor (dB)	Reading (dBuV)	Level (dBuV/m)	Limit (dBuV/m)	Margin (dB)	Detector	Height (cm)	Azimuth (deg)	P/F
1	5650.00	7.35	53.98	61.33	68.20	-6.87	Peak	100	12	P
2	5700.00	7.37	66.45	73.82	105.20	-31.38	Peak	100	12	P
3	5720.00	7.34	73.75	81.09	110.80	-29.71	Peak	100	12	P
4	5725.00	7.33	77.27	84.60	122.20	-37.60	Peak	100	12	P
5	5745.00	7.30	98.26	105.56	200.00	-94.44	Average	100	12	P
6	5745.00	7.30	107.68	114.98	200.00	-85.02	Peak	100	12	P
7	11490.00	16.08	29.07	45.15	54.00	-8.85	Average	100	308	P
8	11490.00	16.08	42.23	58.31	74.00	-15.69	Peak	100	308	P
9	17235.00	22.07	42.30	64.37	68.20	-3.83	Peak	100	152	P

Note: Level=Reading+Factor  
Margin=Level-Limit  
Factor=Antenna Factor + cable loss - Amplifier Factor



Power	: AC 120V / 60Hz from Adapter	Pol/Phase	: HORIZONTAL
Test Mode	: Mode 1, Band 4, CH149		

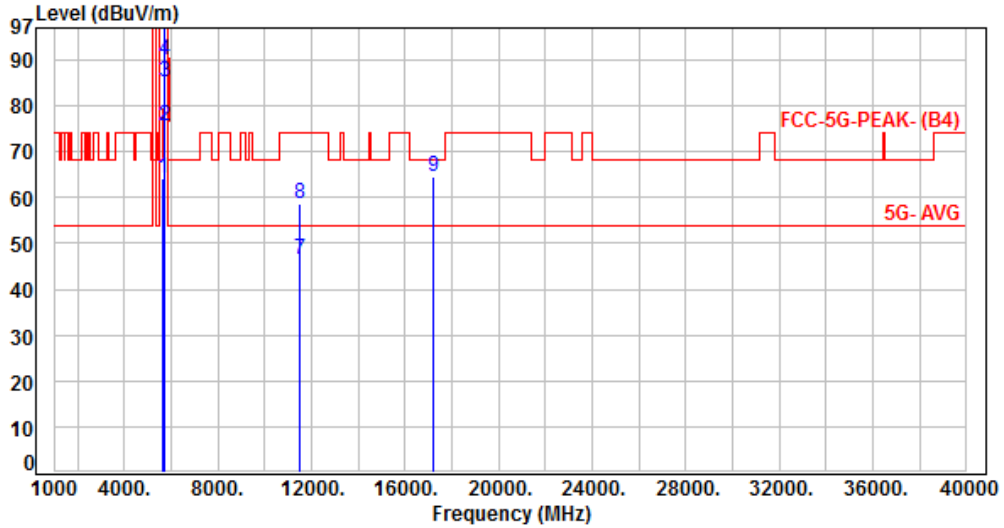

No.	Frequency (MHz)	Factor (dB)	Reading (dBuV)	Level (dBuV/m)	Limit (dBuV/m)	Margin (dB)	Detector	Height (cm)	Azimuth (deg)	P/F
1	5650.00	7.35	56.66	64.01	68.20	-4.19	Peak	287	299	P
2	5700.00	7.37	68.08	75.45	105.20	-29.75	Peak	287	299	P
3	5720.00	7.34	77.68	85.02	110.80	-25.78	Peak	287	299	P
4	5725.00	7.33	82.84	90.17	122.20	-32.03	Peak	287	299	P
5	5745.00	7.30	103.38	110.68	200.00	-89.32	Average	287	299	P
6	5745.00	7.30	113.33	120.63	200.00	-79.37	Peak	287	299	P
7	11490.00	16.08	30.28	46.36	54.00	-7.64	Average	100	164	P
8	11490.00	16.08	42.55	58.63	74.00	-15.37	Peak	100	164	P
9	17235.00	22.07	42.52	64.59	68.20	-3.61	Peak	100	257	P

Note: Level=Reading+Factor  
 Margin=Level-Limit  
 Factor=Antenna Factor + cable loss - Amplifier Factor





Power	: AC 120V / 60Hz from Adapter	Pol/Phase	: VERTICAL
Test Mode	: Mode 1, Band 4, CH157		

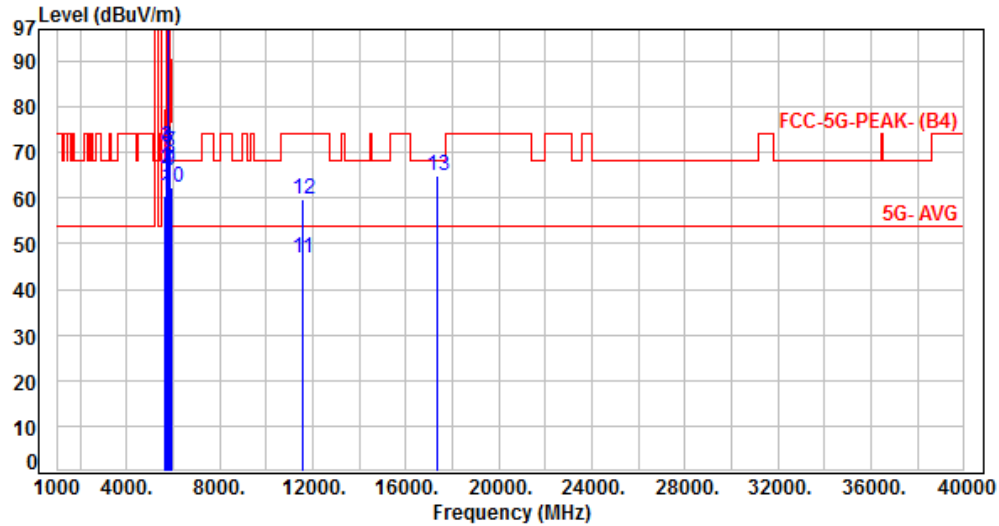

No.	Frequency (MHz)	Factor (dB)	Reading (dBuV)	Level (dBuV/m)	Limit (dBuV/m)	Margin (dB)	Detector	Height (cm)	Azimuth (deg)	P/F
1	5650.00	7.35	53.32	60.67	68.20	-7.53	Peak	100	323	P
2	5700.00	7.37	58.91	66.28	105.20	-38.92	Peak	100	323	P
3	5720.00	7.34	63.71	71.05	110.80	-39.75	Peak	100	323	P
4	5725.00	7.33	63.68	71.01	122.20	-51.19	Peak	100	323	P
5	5785.00	7.37	98.53	105.90	200.00	-94.10	Average	100	323	P
6	5785.00	7.37	108.22	115.59	200.00	-84.41	Peak	100	323	P
7	5850.00	7.43	62.76	70.19	122.20	-52.01	Peak	100	323	P
8	5855.00	7.45	61.19	68.64	110.80	-42.16	Peak	100	323	P
9	5875.00	7.54	58.39	65.93	105.20	-39.27	Peak	100	323	P
10	5925.00	7.66	54.80	62.46	68.20	-5.74	Peak	100	323	P
11	11570.00	16.28	30.59	46.87	54.00	-7.13	Average	100	124	P
12	11570.00	16.28	43.44	59.72	74.00	-14.28	Peak	100	124	P
13	17355.00	22.87	41.91	64.78	68.20	-3.42	Peak	100	266	P

Note: Level=Reading+Factor  
 Margin=Level-Limit  
 Factor=Antenna Factor + cable loss - Amplifier Factor



Power	: AC 120V / 60Hz from Adapter	Pol/Phase	: HORIZONTAL
Test Mode	: Mode 1, Band 4, CH157		

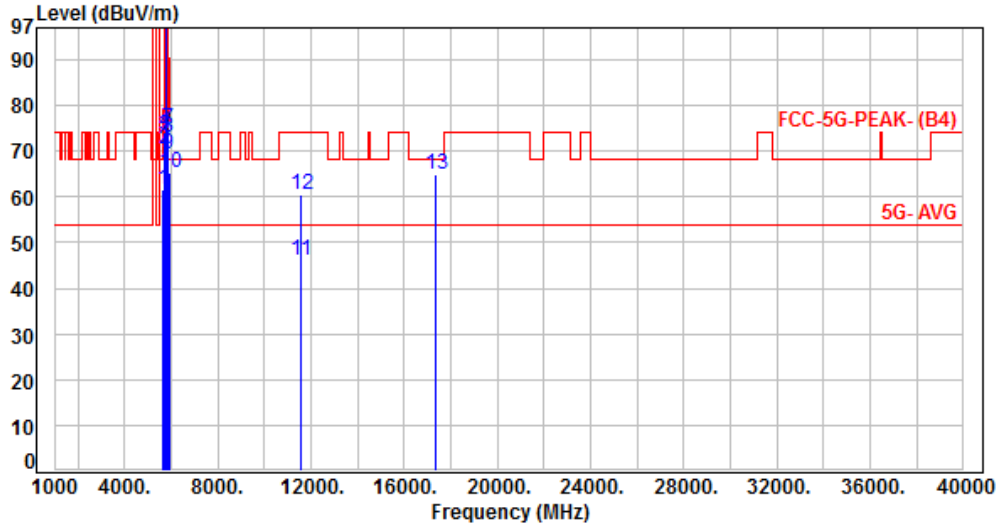

No.	Frequency (MHz)	Factor (dB)	Reading (dBuV)	Level (dBuV/m)	Limit (dBuV/m)	Margin (dB)	Detector	Height (cm)	Azimuth (deg)	P/F
1	5650.00	7.35	54.22	61.57	68.20	-6.63	Peak	271	298	P
2	5700.00	7.37	62.93	70.30	105.20	-34.90	Peak	271	298	P
3	5720.00	7.34	66.19	73.53	110.80	-37.27	Peak	271	298	P
4	5725.00	7.33	66.74	74.07	122.20	-48.13	Peak	271	298	P
5	5785.00	7.37	103.53	110.90	200.00	-89.10	Average	271	298	P
6	5785.00	7.37	112.97	120.34	200.00	-79.66	Peak	271	298	P
7	5850.00	7.43	67.44	74.87	122.20	-47.33	Peak	271	298	P
8	5855.00	7.45	65.44	72.89	110.80	-37.91	Peak	271	298	P
9	5875.00	7.54	61.94	69.48	105.20	-35.72	Peak	271	298	P
10	5925.00	7.66	57.77	65.43	68.20	-2.77	Peak	271	298	P
11	11570.00	16.28	29.82	46.10	54.00	-7.90	Average	100	247	P
12	11570.00	16.28	44.36	60.64	74.00	-13.36	Peak	100	247	P
13	17355.00	22.87	42.11	64.98	68.20	-3.22	Peak	100	314	P

Note: Level=Reading+Factor  
Margin=Level-Limit  
Factor=Antenna Factor + cable loss - Amplifier Factor



Power	: AC 120V / 60Hz from Adapter	Pol/Phase	: VERTICAL
Test Mode	: Mode 1, Band 4, CH165		

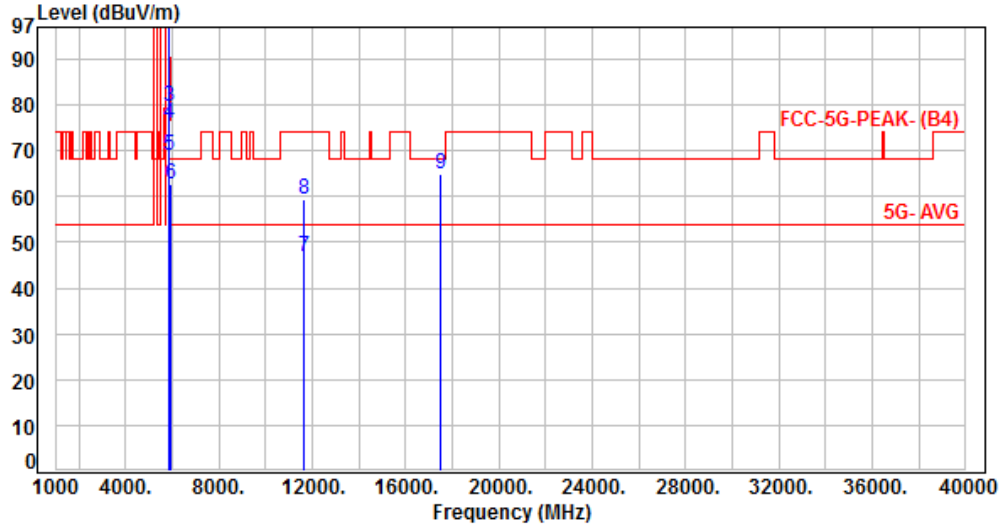

No.	Frequency (MHz)	Factor (dB)	Reading (dBuV)	Level (dBuV/m)	Limit (dBuV/m)	Margin (dB)	Detector	Height (cm)	Azimuth (deg)	P/F
1	5825.00	7.42	97.94	105.36	200.00	-94.64	Average	100	319	P
2	5825.00	7.42	107.29	114.71	200.00	-85.29	Peak	100	319	P
3	5850.00	7.43	72.41	79.84	122.20	-42.36	Peak	100	319	P
4	5855.00	7.45	68.41	75.86	110.80	-34.94	Peak	100	319	P
5	5875.00	7.54	61.58	69.12	105.20	-36.08	Peak	100	319	P
6	5925.00	7.66	54.97	62.63	68.20	-5.57	Peak	100	319	P
7	11650.00	16.44	30.52	46.96	54.00	-7.04	Average	100	177	P
8	11650.00	16.44	42.91	59.35	74.00	-14.65	Peak	100	177	P
9	17475.00	23.45	41.58	65.03	68.20	-3.17	Peak	100	246	P

Note: Level=Reading+Factor  
 Margin=Level-Limit  
 Factor=Antenna Factor + cable loss - Amplifier Factor



Power	: AC 120V / 60Hz from Adapter	Pol/Phase	: HORIZONTAL
Test Mode	: Mode 1, Band 4, CH165		:

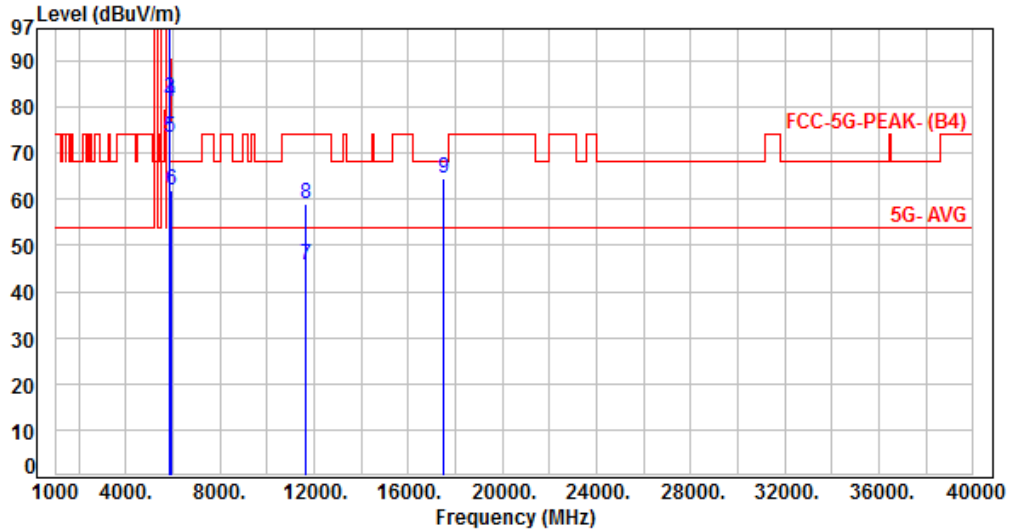

No.	Frequency (MHz)	Factor (dB)	Reading (dBuV)	Level (dBuV/m)	Limit (dBuV/m)	Margin (dB)	Detector	Height (cm)	Azimuth (deg)	P/F
1	5825.00	7.42	99.23	106.65	200.00	-93.35	Average	280	297	P
2	5825.00	7.42	109.26	116.68	200.00	-83.32	Peak	280	297	P
3	5850.00	7.43	74.29	81.72	122.20	-40.48	Peak	280	297	P
4	5855.00	7.45	73.84	81.29	110.80	-29.51	Peak	280	297	P
5	5875.00	7.54	65.83	73.37	105.20	-31.83	Peak	280	297	P
6	5925.00	7.66	54.12	61.78	68.20	-6.42	Peak	280	297	P
7	11650.00	16.44	29.39	45.83	54.00	-8.17	Average	100	311	P
8	11650.00	16.44	42.73	59.17	74.00	-14.83	Peak	100	311	P
9	17475.00	23.45	41.23	64.68	68.20	-3.52	Peak	100	316	P

Note: Level=Reading+Factor  
 Margin=Level-Limit  
 Factor=Antenna Factor + cable loss - Amplifier Factor



Power	: AC 120V / 60Hz from Adapter	Pol/Phase	: VERTICAL
Test Mode	: Mode 6, Band 4, CH149		

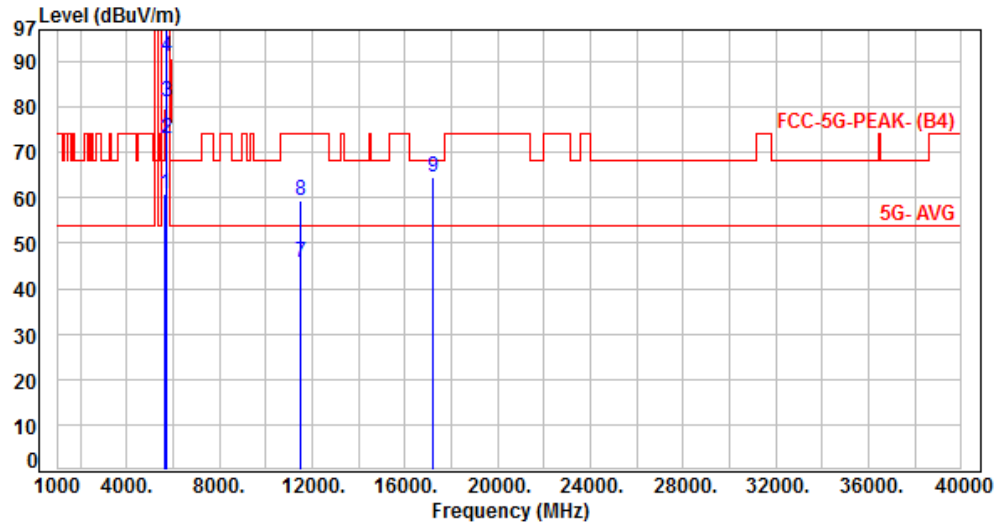

No.	Frequency (MHz)	Factor (dB)	Reading (dBUV)	Level (dBUV/m)	Limit (dBUV/m)	Margin (dB)	Detector	Height (cm)	Azimuth (deg)	P/F
1	5650.00	7.35	53.59	60.94	68.20	-7.26	Peak	100	13	P
2	5700.00	7.37	65.62	72.99	105.20	-32.21	Peak	100	13	P
3	5720.00	7.34	73.78	81.12	110.80	-29.68	Peak	100	13	P
4	5725.00	7.33	83.72	91.05	122.20	-31.15	Peak	100	13	P
5	5745.00	7.30	96.87	104.17	200.00	-95.83	Average	100	13	P
6	5745.00	7.30	109.68	116.98	200.00	-83.02	Peak	100	13	P
7	11490.00	16.08	29.61	45.69	54.00	-8.31	Average	100	311	P
8	11490.00	16.08	43.45	59.53	74.00	-14.47	Peak	100	311	P
9	17235.00	22.07	42.31	64.38	68.20	-3.82	Peak	100	214	P

Note: Level=Reading+Factor  
 Margin=Level-Limit  
 Factor=Antenna Factor + cable loss - Amplifier Factor



Power	: AC 120V / 60Hz from Adapter	Pol/Phase	: HORIZONTAL
Test Mode	: Mode 6, Band 4, CH149		:

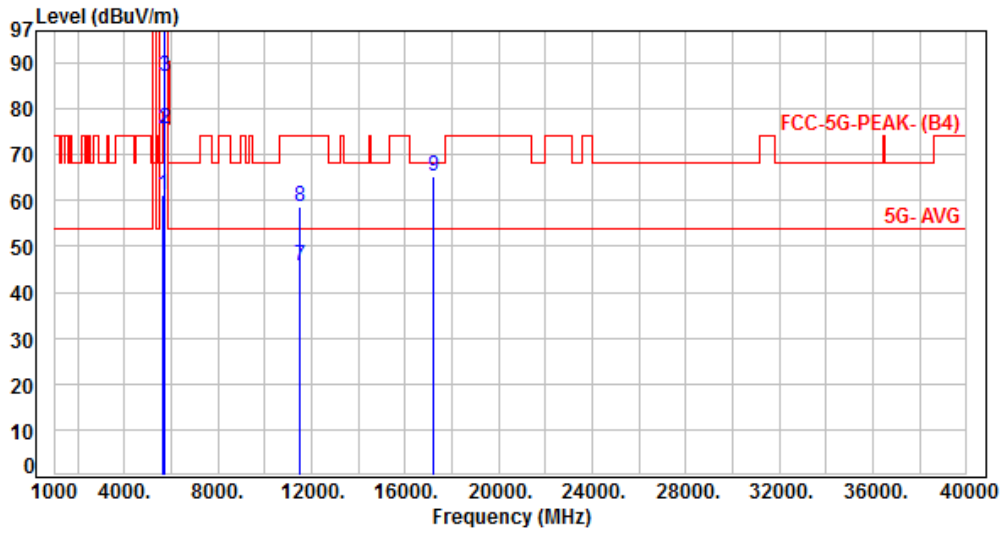

No.	Frequency (MHz)	Factor (dB)	Reading (dBUV)	Level (dBUV/m)	Limit (dBUV/m)	Margin (dB)	Detector	Height (cm)	Azimuth (deg)	P/F
1	5650.00	7.35	53.73	61.08	68.20	-7.12	Peak	258	298	P
2	5700.00	7.37	68.27	75.64	105.20	-29.56	Peak	258	298	P
3	5720.00	7.34	79.79	87.13	110.80	-23.67	Peak	258	298	P
4	5725.00	7.33	88.36	95.69	122.20	-26.51	Peak	258	298	P
5	5745.00	7.30	102.05	109.35	200.00	-90.65	Average	258	298	P
6	5745.00	7.30	114.48	121.78	200.00	-78.22	Peak	258	298	P
7	11490.00	16.08	29.68	45.76	54.00	-8.24	Average	100	193	P
8	11490.00	16.08	42.64	58.72	74.00	-15.28	Peak	100	193	P
9	17235.00	22.07	43.12	65.19	68.20	-3.01	Peak	100	166	P

Note: Level=Reading+Factor  
 Margin=Level-Limit  
 Factor=Antenna Factor + cable loss - Amplifier Factor



Power	: AC 120V / 60Hz from Adapter	Pol/Phase	: VERTICAL
Test Mode	: Mode 6, Band 4, CH157		

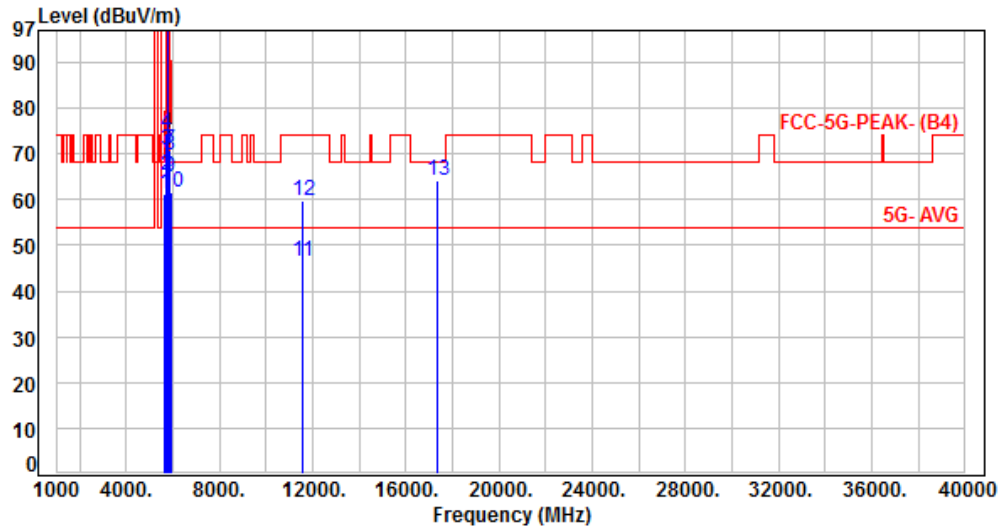

No.	Frequency (MHz)	Factor (dB)	Reading (dBuV)	Level (dBuV/m)	Limit (dBuV/m)	Margin (dB)	Detector	Height (cm)	Azimuth (deg)	P/F
1	5650.00	7.35	53.81	61.16	68.20	-7.04	Peak	100	329	P
2	5700.00	7.37	57.76	65.13	105.20	-40.07	Peak	100	329	P
3	5720.00	7.34	63.59	70.93	110.80	-39.87	Peak	100	329	P
4	5725.00	7.33	67.10	74.43	122.20	-47.77	Peak	100	329	P
5	5785.00	7.37	97.30	104.67	200.00	-95.33	Average	100	329	P
6	5785.00	7.37	110.15	117.52	200.00	-82.48	Peak	100	329	P
7	5850.00	7.43	63.42	70.85	122.20	-51.35	Peak	100	329	P
8	5855.00	7.45	62.21	69.66	110.80	-41.14	Peak	100	329	P
9	5875.00	7.54	57.48	65.02	105.20	-40.18	Peak	100	329	P
10	5925.00	7.66	54.07	61.73	68.20	-6.47	Peak	100	329	P
11	11570.00	16.28	30.02	46.30	54.00	-7.70	Average	100	317	P
12	11570.00	16.28	43.52	59.80	74.00	-14.20	Peak	100	317	P
13	17355.00	22.87	41.42	64.29	68.20	-3.91	Peak	100	241	P

Note: Level=Reading+Factor  
 Margin=Level-Limit  
 Factor=Antenna Factor + cable loss - Amplifier Factor



Power	: AC 120V / 60Hz from Adapter	Pol/Phase	: HORIZONTAL
Test Mode	: Mode 6, Band 4, CH157		

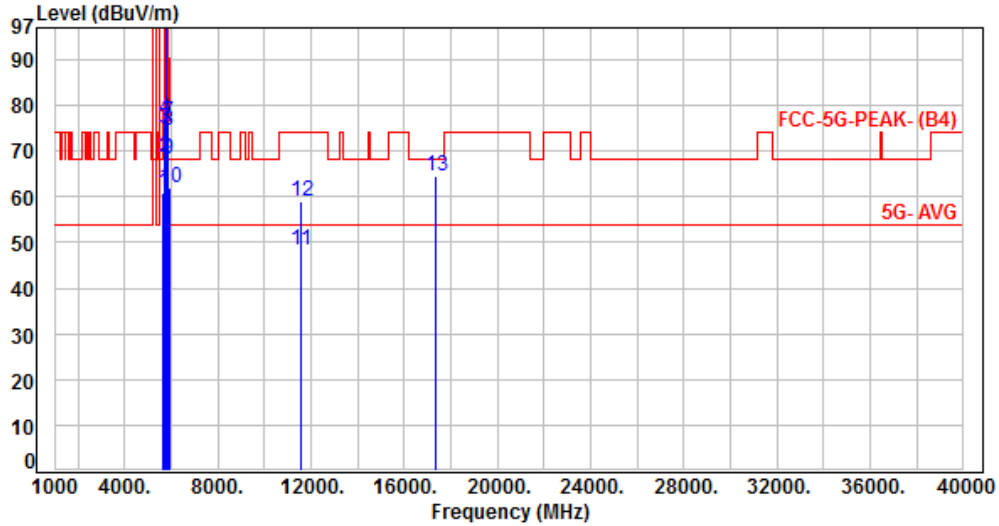

No.	Frequency (MHz)	Factor (dB)	Reading (dBuV)	Level (dBuV/m)	Limit (dBuV/m)	Margin (dB)	Detector	Height (cm)	Azimuth (deg)	P/F
1	5650.00	7.35	53.68	61.03	68.20	-7.17	Peak	245	298	P
2	5700.00	7.37	61.25	68.62	105.20	-36.58	Peak	245	298	P
3	5720.00	7.34	67.49	74.83	110.80	-35.97	Peak	245	298	P
4	5725.00	7.33	69.59	76.92	122.20	-45.28	Peak	245	298	P
5	5785.00	7.37	102.89	110.26	200.00	-89.74	Average	245	298	P
6	5785.00	7.37	115.74	123.11	200.00	-76.89	Peak	245	298	P
7	5850.00	7.43	68.89	76.32	122.20	-45.88	Peak	245	298	P
8	5855.00	7.45	67.08	74.53	110.80	-36.27	Peak	245	298	P
9	5875.00	7.54	60.67	68.21	105.20	-36.99	Peak	245	298	P
10	5925.00	7.66	54.45	62.11	68.20	-6.09	Peak	245	298	P
11	11570.00	16.28	32.05	48.33	54.00	-5.67	Average	100	224	P
12	11570.00	16.28	42.62	58.90	74.00	-15.10	Peak	100	224	P
13	17355.00	22.87	41.74	64.61	68.20	-3.59	Peak	100	360	P

Note: Level=Reading+Factor  
 Margin=Level-Limit  
 Factor=Antenna Factor + cable loss - Amplifier Factor





Power	: AC 120V / 60Hz from Adapter	Pol/Phase	: VERTICAL
Test Mode	: Mode 6, Band 4, CH165		

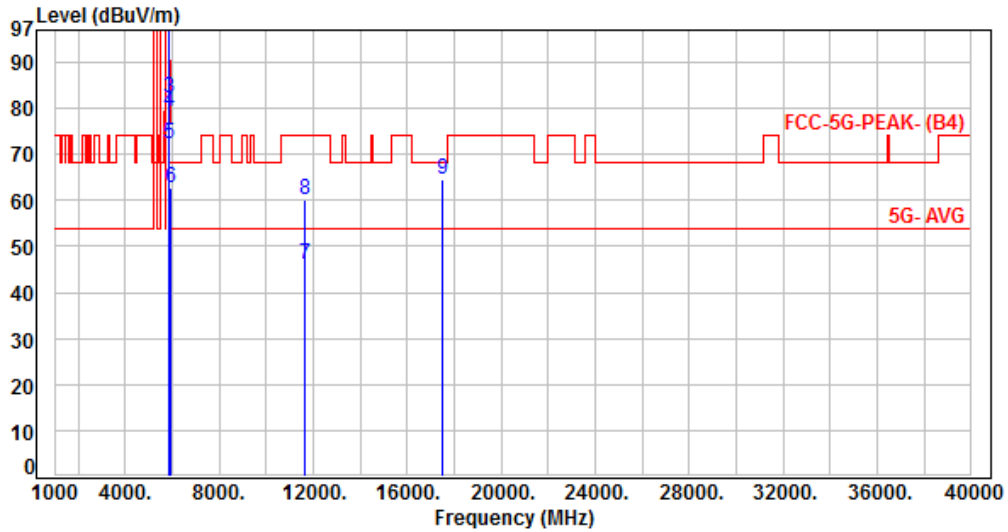

No.	Frequency (MHz)	Factor (dB)	Reading (dBuV)	Level (dBuV/m)	Limit (dBuV/m)	Margin (dB)	Detector	Height (cm)	Azimuth (deg)	P/F
1	5825.00	7.42	96.77	104.19	200.00	-95.81	Average	100	322	P
2	5825.00	7.42	109.30	116.72	200.00	-83.28	Peak	100	322	P
3	5850.00	7.43	74.88	82.31	122.20	-39.89	Peak	100	322	P
4	5855.00	7.45	71.93	79.38	110.80	-31.42	Peak	100	322	P
5	5875.00	7.54	64.82	72.36	105.20	-32.84	Peak	100	322	P
6	5925.00	7.66	54.96	62.62	68.20	-5.58	Peak	100	322	P
7	11650.00	16.44	29.78	46.22	54.00	-7.78	Average	100	264	P
8	11650.00	16.44	43.82	60.26	74.00	-13.74	Peak	100	264	P
9	17475.00	23.45	41.01	64.46	68.20	-3.74	Peak	100	144	P

Note: Level=Reading+Factor  
 Margin=Level-Limit  
 Factor=Antenna Factor + cable loss - Amplifier Factor



Power	: AC 120V / 60Hz from Adapter	Pol/Phase	: HORIZONTAL
Test Mode	: Mode 6, Band 4, CH165		:

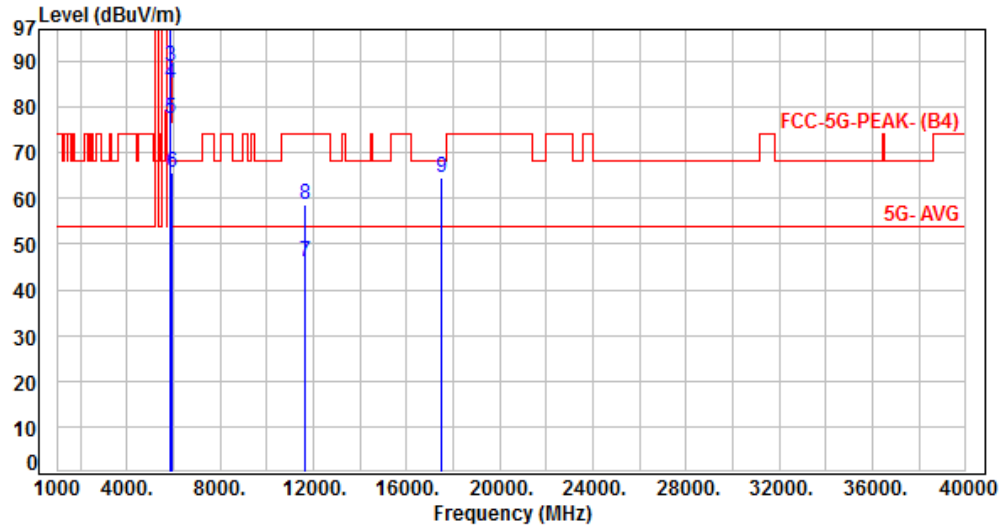

No.	Frequency (MHz)	Factor (dB)	Reading (dBuV)	Level (dBuV/m)	Limit (dBuV/m)	Margin (dB)	Detector	Height (cm)	Azimuth (deg)	P/F
1	5825.00	7.42	102.64	110.06	200.00	-89.94	Average	253	299	P
2	5825.00	7.42	116.06	123.48	200.00	-76.52	Peak	253	299	P
3	5850.00	7.43	81.33	88.76	122.20	-33.44	Peak	253	299	P
4	5855.00	7.45	77.78	85.23	110.80	-25.57	Peak	253	299	P
5	5875.00	7.54	69.83	77.37	105.20	-27.83	Peak	253	299	P
6	5925.00	7.66	58.11	65.77	68.20	-2.43	Peak	253	299	P
7	11650.00	16.44	29.50	45.94	54.00	-8.06	Average	100	117	P
8	11650.00	16.44	42.29	58.73	74.00	-15.27	Peak	100	117	P
9	17475.00	23.45	41.02	64.47	68.20	-3.73	Peak	100	259	P

Note: Level=Reading+Factor  
 Margin=Level-Limit  
 Factor=Antenna Factor + cable loss - Amplifier Factor



Power	: AC 120V / 60Hz from Adapter	Pol/Phase	: VERTICAL
Test Mode	: Mode 7, Band 4, CH151		

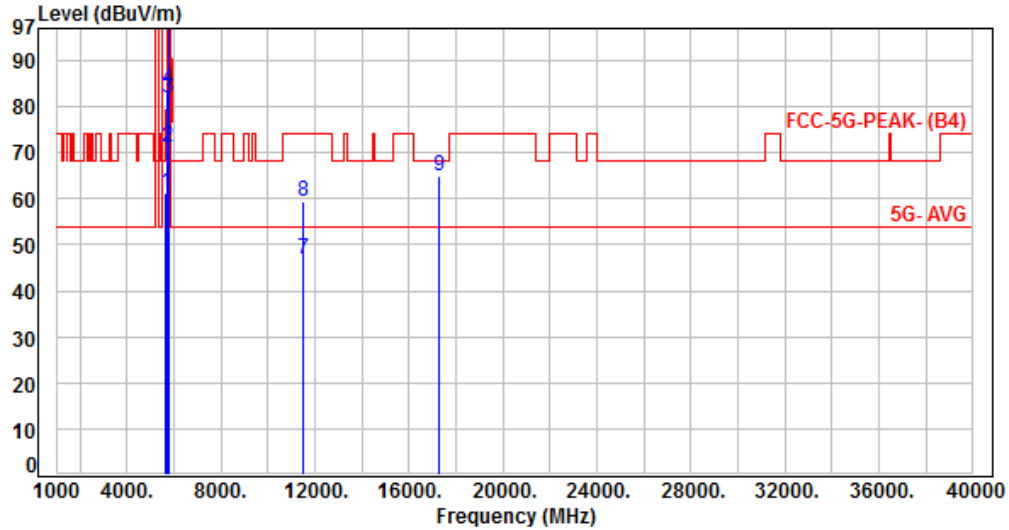

No.	Frequency (MHz)	Factor (dB)	Reading (dBuV)	Level (dBuV/m)	Limit (dBuV/m)	Margin (dB)	Detector	Height (cm)	Azimuth (deg)	P/F
1	5650.00	7.35	53.97	61.32	68.20	-6.88	Peak	100	325	P
2	5700.00	7.37	63.82	71.19	105.20	-34.01	Peak	100	325	P
3	5720.00	7.34	74.41	81.75	110.80	-29.05	Peak	100	325	P
4	5725.00	7.33	76.23	83.56	122.20	-38.64	Peak	100	325	P
5	5755.00	7.30	93.86	101.16	200.00	-98.84	Average	100	325	P
6	5755.00	7.30	106.21	113.51	200.00	-86.49	Peak	100	325	P
7	11510.00	16.15	30.75	46.90	54.00	-7.10	Average	100	126	P
8	11510.00	16.15	43.08	59.23	74.00	-14.77	Peak	100	126	P
9	17265.00	22.22	42.70	64.92	68.20	-3.28	Peak	100	211	P

Note: Level=Reading+Factor  
 Margin=Level-Limit  
 Factor=Antenna Factor + cable loss - Amplifier Factor



Power	: AC 120V / 60Hz from Adapter	Pol/Phase	: HORIZONTAL
Test Mode	: Mode 7, Band 4, CH151		

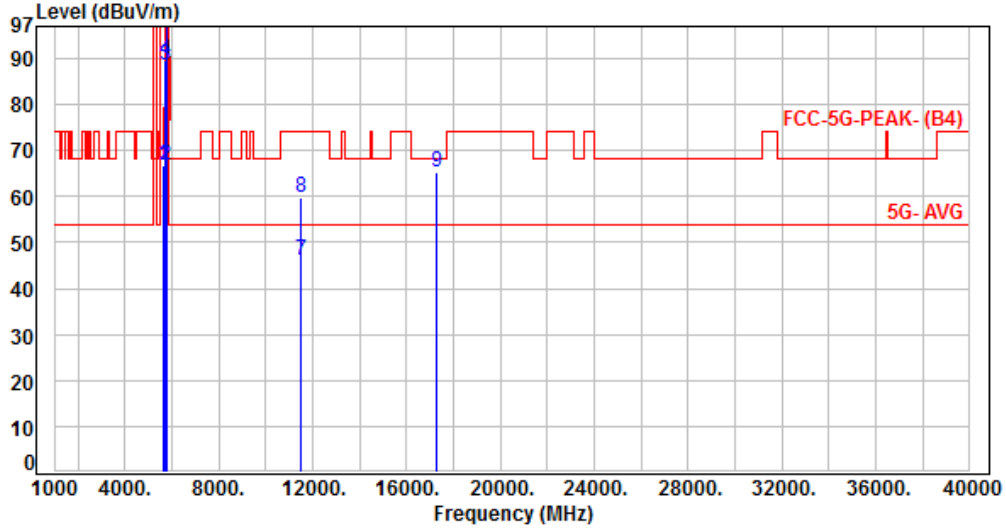

No.	Frequency (MHz)	Factor (dB)	Reading (dBuV)	Level (dBuV/m)	Limit (dBuV/m)	Margin (dB)	Detector	Height (cm)	Azimuth (deg)	P/F
1	5650.00	7.35	59.42	66.77	68.20	-1.43	Peak	261	296	P
2	5700.00	7.37	59.42	66.79	105.20	-38.41	Peak	261	296	P
3	5720.00	7.34	81.07	88.41	110.80	-22.39	Peak	261	296	P
4	5725.00	7.33	82.23	89.56	122.20	-32.64	Peak	261	296	P
5	5755.00	7.30	95.85	103.15	200.00	-96.85	Average	261	296	P
6	5755.00	7.30	109.50	116.80	200.00	-83.20	Peak	261	296	P
7	11510.00	16.15	29.77	45.92	54.00	-8.08	Average	100	185	P
8	11510.00	16.15	43.49	59.64	74.00	-14.36	Peak	100	185	P
9	17265.00	22.22	42.97	65.19	68.20	-3.01	Peak	100	150	P

Note: Level=Reading+Factor  
 Margin=Level-Limit  
 Factor=Antenna Factor + cable loss - Amplifier Factor



Power	: AC 120V / 60Hz from Adapter	Pol/Phase	: VERTICAL
Test Mode	: Mode 8, Band 4, CH159		

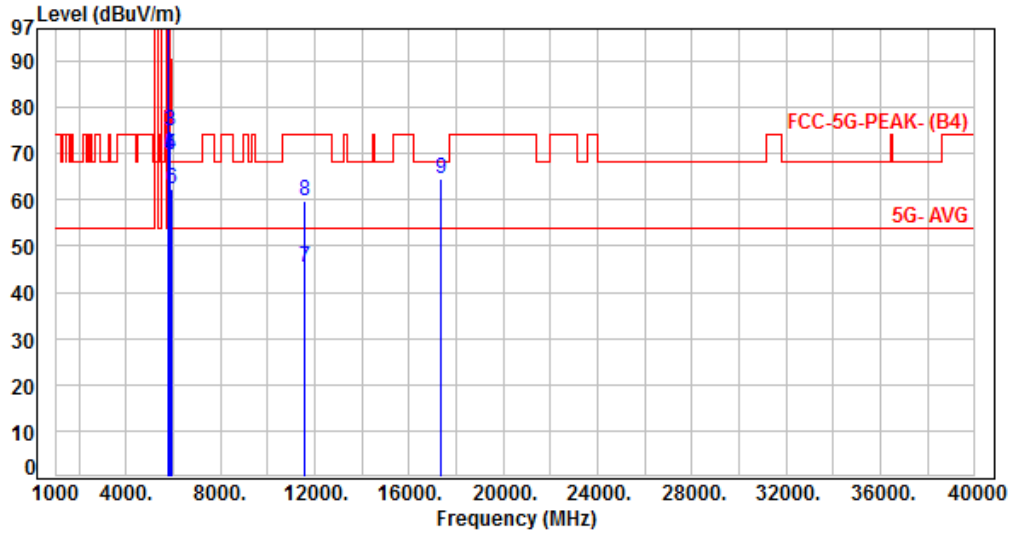

No.	Frequency (MHz)	Factor (dB)	Reading (dBuV)	Level (dBuV/m)	Limit (dBuV/m)	Margin (dB)	Detector	Height (cm)	Azimuth (deg)	P/F
1	5795.00	7.39	93.20	100.59	200.00	-99.41	Average	100	323	P
2	5795.00	7.39	106.61	114.00	200.00	-86.00	Peak	100	323	P
3	5850.00	7.43	67.60	75.03	122.20	-47.17	Peak	100	323	P
4	5875.00	7.54	62.04	69.58	105.20	-35.62	Peak	100	323	P
5	5875.00	7.54	62.04	69.58	105.20	-35.62	Peak	100	323	P
6	5925.00	7.66	54.55	62.21	68.20	-5.99	Peak	100	323	P
7	11590.00	16.31	29.01	45.32	54.00	-8.68	Average	100	117	P
8	11590.00	16.31	43.60	59.91	74.00	-14.09	Peak	100	117	P
9	17385.00	22.94	41.48	64.42	68.20	-3.78	Peak	100	252	P

Note: Level=Reading+Factor  
Margin=Level-Limit  
Factor=Antenna Factor + cable loss - Amplifier Factor



Power	: AC 120V / 60Hz from Adapter	Pol/Phase	: HORIZONTAL
Test Mode	: Mode 8, Band 4, CH159		

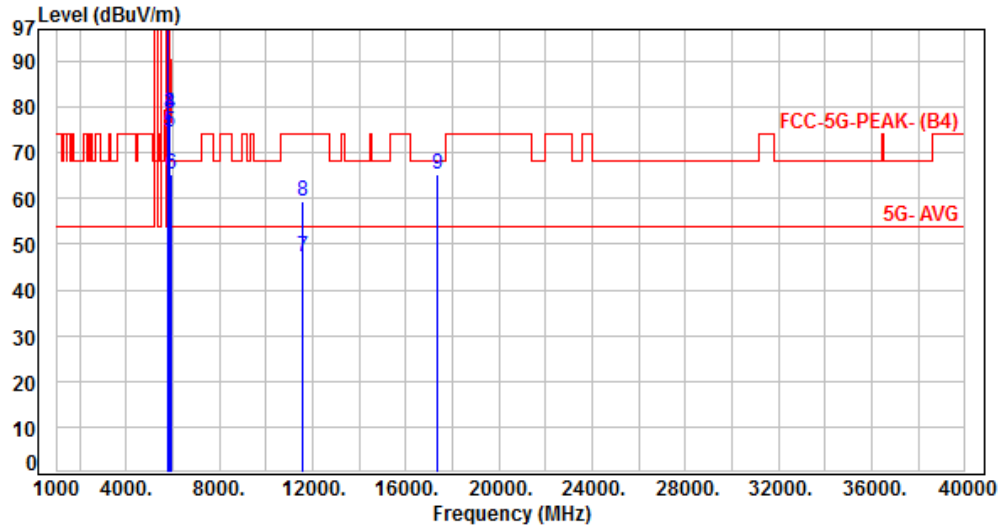

No.	Frequency (MHz)	Factor (dB)	Reading (dBuV)	Level (dBuV/m)	Limit (dBuV/m)	Margin (dB)	Detector	Height (cm)	Azimuth (deg)	P/F
1	5795.00	7.39	98.70	106.09	200.00	-93.91	Average	312	297	P
2	5795.00	7.39	111.78	119.17	200.00	-80.83	Peak	312	297	P
3	5850.00	7.43	71.24	78.67	122.20	-43.53	Peak	312	297	P
4	5855.00	7.45	71.24	78.69	110.80	-32.11	Peak	312	297	P
5	5875.00	7.54	66.84	74.38	105.20	-30.82	Peak	312	297	P
6	5925.00	7.66	57.77	65.43	68.20	-2.77	Peak	312	297	P
7	11590.00	16.31	31.02	47.33	54.00	-6.67	Average	100	38	P
8	11590.00	16.31	43.00	59.31	74.00	-14.69	Peak	100	38	P
9	17385.00	22.94	42.16	65.10	68.20	-3.10	Peak	100	123	P

Note: Level=Reading+Factor  
 Margin=Level-Limit  
 Factor=Antenna Factor + cable loss - Amplifier Factor



Power	: AC 120V / 60Hz from Adapter	Pol/Phase	: VERTICAL
Test Mode	: Mode 8, Band 4, CH155		

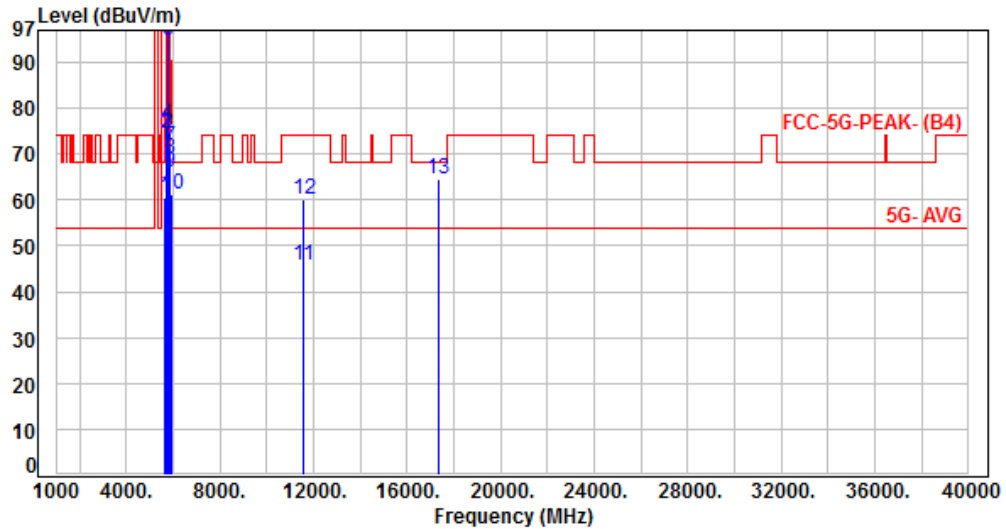

No.	Frequency (MHz)	Factor (dB)	Reading (dBuV)	Level (dBuV/m)	Limit (dBuV/m)	Margin (dB)	Detector	Height (cm)	Azimuth (deg)	P/F
1	5650.00	7.35	53.10	60.45	68.20	-7.75	Peak	100	354	P
2	5700.00	7.37	67.09	74.46	105.20	-30.74	Peak	100	354	P
3	5720.00	7.34	67.00	74.34	110.80	-36.46	Peak	100	354	P
4	5725.00	7.33	69.17	76.50	122.20	-45.70	Peak	100	354	P
5	5775.00	7.35	87.52	94.87	200.00	-105.13	Average	100	354	P
6	5775.00	7.35	100.49	107.84	200.00	-92.16	Peak	100	354	P
7	5850.00	7.43	64.30	71.73	122.20	-50.47	Peak	100	354	P
8	5855.00	7.45	61.64	69.09	110.80	-41.71	Peak	100	354	P
9	5875.00	7.54	58.41	65.95	105.20	-39.25	Peak	100	354	P
10	5925.00	7.66	53.38	61.04	68.20	-7.16	Peak	100	354	P
11	11550.00	16.24	29.53	45.77	54.00	-8.23	Average	100	114	P
12	11550.00	16.24	43.75	59.99	74.00	-14.01	Peak	100	114	P
13	17325.00	22.65	41.95	64.60	68.20	-3.60	Peak	100	214	P

Note: Level=Reading+Factor  
 Margin=Level-Limit  
 Factor=Antenna Factor + cable loss - Amplifier Factor



Power	: AC 120V / 60Hz from Adapter	Pol/Phase	: HORIZONTAL
Test Mode	: Mode 8, Band 4, CH155		

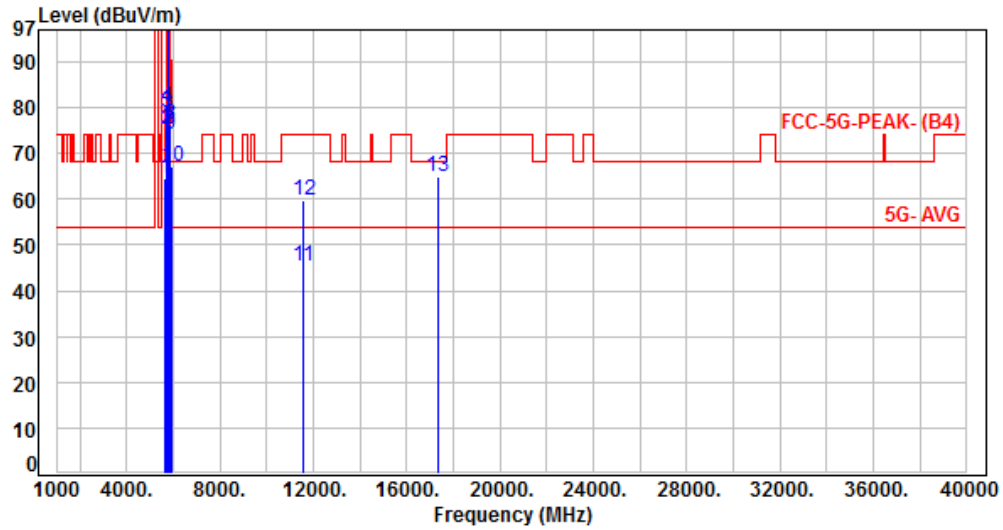

No.	Frequency (MHz)	Factor (dB)	Reading (dBuV)	Level (dBuV/m)	Limit (dBuV/m)	Margin (dB)	Detector	Height (cm)	Azimuth (deg)	P/F
1	5650.00	7.35	57.34	64.69	68.20	-3.51	Peak	271	295	P
2	5700.00	7.37	67.79	75.16	105.20	-30.04	Peak	271	295	P
3	5720.00	7.34	71.69	79.03	110.80	-31.77	Peak	271	295	P
4	5725.00	7.33	72.73	80.06	122.20	-42.14	Peak	271	295	P
5	5775.00	7.35	93.96	101.31	200.00	-98.69	Average	271	295	P
6	5775.00	7.35	105.27	112.62	200.00	-87.38	Peak	271	295	P
7	5850.00	7.43	68.10	75.53	122.20	-46.67	Peak	271	295	P
8	5855.00	7.45	68.88	76.33	110.80	-34.47	Peak	271	295	P
9	5875.00	7.54	66.50	74.04	105.20	-31.16	Peak	271	295	P
10	5925.00	7.66	59.49	67.15	68.20	-1.05	Peak	271	295	P
11	11550.00	16.24	29.23	45.47	54.00	-8.53	Average	100	113	P
12	11550.00	16.24	43.52	59.76	74.00	-14.24	Peak	100	113	P
13	17325.00	22.65	42.41	65.06	68.20	-3.14	Peak	100	261	P

Note: Level=Reading+Factor  
 Margin=Level-Limit  
 Factor=Antenna Factor + cable loss - Amplifier Factor





### 6.7. Restricted Bands of Operation

Only spurious emissions are permitted in any of the frequency bands listed below:

MHz	MHz	MHz	GHz
0.09000 – 0.11000	16.42000 – 16.42300	399.9 – 410.0	4.500 – 5.150
0.49500 – 0.505**	16.69475 – 16.69525	608.0 – 614.0	5.350 – 5.460
2.17350 – 2.19050	16.80425 – 16.80475	960.0 – 1240.0	7.250 – 7.750
4.12500 – 4.12800	25.50000 – 25.67000	1300.0 – 1427.0	8.025 – 8.500
4.17725 – 4.17775	37.50000 – 38.25000	1435.0 – 1626.5	9.000 – 9.200
4.20725 – 4.20775	73.00000 – 74.60000	1645.5 – 1646.5	9.300 – 9.500
6.21500 – 6.21800	74.80000 – 75.20000	1660.0 – 1710.0	10.600 – 12.700
6.26775 – 6.26825	108.00000 – 121.94000	1718.8 – 1722.2	13.250 – 13.400
6.31175 – 6.31225	123.00000 – 138.00000	2200.0 – 2300.0	14.470 – 14.500
8.29100 – 8.29400	149.90000 – 150.05000	2310.0 – 2390.0	15.350 – 16.200
8.36200 – 8.36600	156.52475 – 156.52525	2483.5 – 2500.0	17.700 – 21.400
8.37625 – 8.38675	156.70000 – 156.90000	2655.0 – 2900.0	22.010 – 23.120
8.41425 – 8.41475	162.01250 – 167.17000	3260.0 – 3267.0	23.600 – 24.000
12.29000 – 12.29300	167.72000 – 173.20000	3332.0 – 3339.0	31.200 – 31.800
12.51975 – 12.52025	240.00000 – 285.00000	3345.8 – 3358.0	36.430 – 36.500
12.57675 – 12.57725	322.00000 – 335.40000	3600.0 – 4400.0	Above 38.6
13.36000 – 13.41000			

\*\* : Until February 1, 1999, this restricted band shall be 0.490-0.510 MHz