

FCC Test Report

Report No.: RF181009C23-1

FCC ID: KA2AP3666A1

Test Model: DAP-3666

Received Date: Feb. 22, 2019

Test Date: Mar. 28 ~ Apr. 12 and Jul. 11, 2019

Issued Date: Jul. 15, 2019

Applicant: D-Link Corporation

Address: 17595 Mt. Herrmann, Fountain Valley, California, United States, 92708

Issued By: Bureau Veritas Consumer Products Services (H.K.) Ltd., Taoyuan Branch

Lab Address: No. 47-2, 14th Ling, Chia Pau Vil., Lin Kou Dist., New Taipei City, Taiwan (R.O.C.)

Test Location: No. 19, Hwa Ya 2nd Rd., Wen Hwa Vil., Kwei Shan Dist., Taoyuan City 33383, TAIWAN (R.O.C.)

**FCC Registration /
Designation Number:** 788550 / TW0003



This report is for your exclusive use. Any copying or replication of this report to or for any other person or entity, or use of our name or trademark, is permitted only with our prior written permission. This report sets forth our findings solely with respect to the test samples identified herein. The results set forth in this report are not indicative or representative of the quality or characteristics of the lot from which a test sample was taken or any similar or identical product specifically and expressly noted. Our report includes all of the tests requested by you and the results thereof based upon the information that you provided to us. You have 60 days from date of issuance of this report to notify us of any material error or omission caused by our negligence, provided, however, that such notice shall be in writing and shall specifically address the issue you wish to raise. A failure to raise such issue within the prescribed time shall constitute your unqualified acceptance of the completeness of this report, the tests conducted and the correctness of the report contents. Unless specific mention, the uncertainty of measurement has been explicitly taken into account to declare the compliance or non-compliance to the specification. The report must not be used by the client to claim product certification, approval, or endorsement by TAF or any government agencies.

Table of Contents

Release Control Record	4
1 Certificate of Conformity	5
2 Summary of Test Results	6
2.1 Measurement Uncertainty.....	6
2.2 Modification Record.....	6
3 General Information	7
3.1 General Description of EUT.....	7
3.2 Description of Test Modes.....	9
3.2.1 Test Mode Applicability and Tested Channel Detail.....	10
3.3 Duty Cycle of Test Signal.....	12
3.4 Description of Support Units.....	13
3.4.1 Configuration of System under Test.....	13
3.5 General Description of Applied Standards.....	13
4 Test Types and Results	14
4.1 Radiated Emission and Bandedge Measurement.....	14
4.1.1 Limits of Radiated Emission and Bandedge Measurement.....	14
4.1.2 Test Instruments.....	15
4.1.3 Test Procedures.....	16
4.1.4 Deviation from Test Standard.....	16
4.1.5 Test Setup.....	17
4.1.6 EUT Operating Conditions.....	18
4.1.7 Test Results.....	19
4.2 Conducted Emission Measurement.....	39
4.2.1 Limits of Conducted Emission Measurement.....	39
4.2.2 Test Instruments.....	39
4.2.3 Test Procedures.....	40
4.2.4 Deviation from Test Standard.....	40
4.2.5 Test Setup.....	40
4.2.6 EUT Operating Conditions.....	40
4.2.7 Test Results.....	41
4.3 Transmit Power Measurement.....	43
4.3.1 Limits of Transmit Power Measurement.....	43
4.3.2 Test Setup.....	43
4.3.3 Test Instruments.....	43
4.3.4 Test Procedure.....	43
4.3.5 Deviation from Test Standard.....	43
4.3.6 EUT Operating Conditions.....	43
4.3.7 Test Result.....	44
4.4 Occupied Bandwidth Measurement.....	47
4.4.1 Test Setup.....	47
4.4.2 Test Instruments.....	47
4.4.3 Test Procedure.....	47
4.4.4 Test Result.....	48
4.5 Peak Power Spectral Density Measurement.....	50
4.5.1 Limits of Peak Power Spectral Density Measurement.....	50
4.5.2 Test Setup.....	50
4.5.3 Test Instruments.....	50
4.5.4 Test Procedures.....	50
4.5.5 Deviation from Test Standard.....	51
4.5.6 EUT Operating Conditions.....	51
4.5.7 Test Results.....	52
4.6 Frequency Stability.....	57
4.6.1 Limits of Frequency Stability Measurement.....	57

4.6.2	Test Setup.....	57
4.6.3	Test Instruments	57
4.6.4	Test Procedure	57
4.6.5	Deviation from Test Standard	58
4.6.6	EUT Operating Condition	58
4.6.7	Test Results	58
4.7	6dB Bandwidth Measurement.....	59
4.7.1	Limits of 6dB Bandwidth Measurement.....	59
4.7.2	Test Setup.....	59
4.7.3	Test Instruments	59
4.7.4	Test Procedure	59
4.7.5	Deviation from Test Standard	59
4.7.6	EUT Operating Condition	59
4.7.7	Test Results	60
5	Pictures of Test Arrangements.....	62
	Annex A- Radiated Out of Band Emission (OOBE) Measurement (For U-NII-3 band).....	63
	Appendix – Information of the Testing Laboratories	66

Release Control Record

Issue No.	Description	Date Issued
RF181009C23-1	Original release	Jul. 15, 2019

1 Certificate of Conformity

Product: Nuclias Connect AC1200 Wave 2 Outdoor Access Point

Brand: D-Link

Test Model: DAP-3666

Sample Status: Engineering sample

Applicant: D-Link Corporation

Test Date: Mar. 28 ~ Apr. 12 and Jul. 11, 2019

Standards: 47 CFR FCC Part 15, Subpart E (Section 15.407)
ANSI C63.10:2013

The above equipment has been tested by **Bureau Veritas Consumer Products Services (H.K.) Ltd., Taoyuan Branch**, and found compliance with the requirement of the above standards. The test record, data evaluation & Equipment Under Test (EUT) configurations represented herein are true and accurate accounts of the measurements of the sample's RF characteristics under the conditions specified in this report.

Prepared by : Celine Chou , **Date:** Jul. 15, 2019
Celine Chou / Senior Specialist

Approved by : Bruce Chen , **Date:** Jul. 15, 2019
Bruce Chen / Project Engineer

2 Summary of Test Results

47 CFR FCC Part 15, Subpart E (Section 15.407)			
FCC Clause	Test Item	Result	Remarks
15.407(b)(6)	AC Power Conducted Emissions	Pass	Meet the requirement of limit. Minimum passing margin is -1.51dB at 0.41197MHz.
15.407(b)(1/2/3/4(i/ii)/6)	Radiated Emissions & Band Edge Measurement	Pass	Meet the requirement of limit. Minimum passing margin is -1.3dB at 11570.00MHz and 11650.00MHz.
15.407(a)(1/2/3)	Max Average Transmit Power	Pass	Meet the requirement of limit.
---	Occupied Bandwidth Measurement	-	Reference only.
15.407(a)(1/2/3)	Peak Power Spectral Density	Pass	Meet the requirement of limit.
15.407(e)	6dB bandwidth	Pass	Meet the requirement of limit. (U-NII-3 Band only)
15.407(g)	Frequency Stability	Pass	Meet the requirement of limit.
15.203	Antenna Requirement	Pass	Antenna connector is i-pex(MHF) not a standard connector.

Note:

- Determining compliance based on the results of the compliance measurement, not taking into account measurement instrumentation uncertainty.
- For U-NII-3 band compliance with rule part 15.407(b)(4)(i), the OOB test plots were recorded in Annex A.

2.1 Measurement Uncertainty

Where relevant, the following measurement uncertainty levels have been estimated for tests performed on the EUT as specified in CISPR 16-4-2:

Measurement	Frequency	Expanded Uncertainty (k=2) (±)
Conducted Emissions at mains ports	150kHz ~ 30MHz	2.94 dB
Radiated Emissions up to 1 GHz	9kHz ~ 30MHz	3.04 dB
	30MHz ~ 200MHz	3.86 dB
	200MHz ~ 1000MHz	3.87 dB
Radiated Emissions above 1 GHz	1GHz ~ 18GHz	2.29 dB
	18GHz ~ 40GHz	2.29 dB

2.2 Modification Record

There were no modifications required for compliance.

3 General Information

3.1 General Description of EUT

Product	Nuclias Connect AC1200 Wave 2 Outdoor Access Point
Brand	D-Link
Test Model	DAP-3666
Sample Status	Engineering sample
Power Supply Rating	56Vdc (POE)
Modulation Type	256QAM, 64QAM, 16QAM, QPSK, BPSK
Modulation Technology	OFDM
Transfer Rate	802.11a: 54/48/36/24/18/12/9/6Mbps 802.11n: up to 300Mbps 802.11ac: up to 867Mbps
Operating Frequency	5180 ~ 5240MHz, 5745 ~ 5825MHz
Number of Channel	5180 ~ 5240MHz: 802.11a, 802.11n (HT20), 802.11ac (VHT20): 4 802.11n (HT40), 802.11ac (VHT40): 2 802.11ac (VHT80): 1 5745 ~ 5825MHz: 802.11a, 802.11n (HT20), 802.11ac (VHT20): 5 802.11n (HT40), 802.11ac (VHT40): 2 802.11ac (VHT80): 1
Output Power	5180 ~ 5240MHz: 101.184mW 5745 ~ 5825MHz: 296.457mW
Antenna Type	Ant. 1: PCB antenna with 7.4dBi gain Ant. 2: PCB antenna with 5.8dBi gain
Antenna Connector	i-pex(MHF)
Accessory Device	Refer to Note as below
Cable Supplied	Refer to Note as below

Note:

1. The EUT incorporates a MIMO function. Physically, the EUT provides 2 completed transmitters and 2 receivers.

Modulation Mode	TX Function
802.11a	2TX
802.11n (HT20)	2TX
802.11n (HT40)	2TX
802.11ac (VHT20)	2TX
802.11ac (VHT40)	2TX
802.11ac (VHT80)	2TX

* The bandwidth and modulation are similar for HT20/HT40 on 802.11n mode and VHT20/VHT40 on 802.11ac mode, therefore investigated worst case to representative mode in test report. (Final test mode refer section 3.2.1)

2. The EUT contains following accessory devices.

Product	Brand	Model	Description
POE	D-Link	DPE-311GI	I/P: 100-240 Vac, 50/60 Hz, 0.75 mA O/P: 56 Vdc, 540 mA
Ground Cable	Superior	WIRE-0771-A-TP	0.21 m non-shielded cable w/o core

3. The EUT will install at outdoor area, the highest antenna gain from the horizon above 30 degrees as below, for more detail information please refer to antenna specification and user manual

Antenna No.	Antenna gain	Antenna install degree
1, 2	0.89 dBi	

Thus consider to above 30 degrees from the horizon the highest antenna gain are chosen from antenna specification exhibits from 0 to 360 degrees for U-NII-1 band.

4. 2.4GHz & 5GHz technology can transmit at same time.

5. Spurious emission of the simultaneous operation (2.4GHz & 5GHz) has been evaluated and no non-compliance was found.

3.2 Description of Test Modes

For 5180 ~ 5240MHz:

4 channels are provided for 802.11a, 802.11n (HT20), 802.11ac (VHT20):

Channel	Frequency	Channel	Frequency
36	5180 MHz	44	5220 MHz
40	5200 MHz	48	5240 MHz

2 channels are provided for 802.11n (HT40), 802.11ac (VHT40):

Channel	Frequency	Channel	Frequency
38	5190 MHz	46	5230 MHz

1 channel is provided for 802.11ac (VHT80):

Channel	Frequency
42	5210MHz

For 5745 ~ 5825MHz:

5 channels are provided for 802.11a, 802.11n (HT20), 802.11ac (VHT20):

Channel	Frequency	Channel	Frequency
149	5745MHz	161	5805MHz
153	5765MHz	165	5825MHz
157	5785MHz		

2 channels are provided for 802.11n (HT40), 802.11ac (VHT40):

Channel	Frequency	Channel	Frequency
151	5755MHz	159	5795MHz

1 channel is provided for 802.11ac (VHT80):

Channel	Frequency
155	5775MHz

3.2.1 Test Mode Applicability and Tested Channel Detail

EUT Configure Mode	Applicable to				Description
	RE \geq 1G	RE<1G	PLC	APCM	
-	√	√	√	√	-

Where RE \geq 1G: Radiated Emission above 1GHz & Bandedge Measurement
 RE<1G: Radiated Emission below 1GHz
 PLC: Power Line Conducted Emission
 APCM: Antenna Port Conducted Measurement

Radiated Emission Test (Above 1GHz):

- Pre-Scan has been conducted to determine the worst-case mode from all possible combinations between available modulations, data rates and antenna ports (if EUT with antenna diversity architecture).
- Following channel(s) was (were) selected for the final test as listed below.

EUT Configure Mode	Mode	Frequency Band (MHz)	Available Channel	Tested Channel	Modulation Technology	Data Rate (Mbps)
-	802.11a	5180-5240	36 to 48	36, 40, 48	OFDM	6.0
	802.11n (HT20)		36 to 48	36, 40, 48	OFDM	6.5
	802.11n (HT40)		38 to 46	38, 46	OFDM	13.5
	802.11ac (VHT80)		42	42	OFDM	29.3
-	802.11a	5745-5825	149 to 165	149, 157, 165	OFDM	6.0
	802.11n (HT20)		149 to 165	149, 157, 165	OFDM	6.5
	802.11n (HT40)		151 to 159	151, 159	OFDM	13.5
	802.11ac (VHT80)		155	155	OFDM	29.3

Radiated Emission Test (Below 1GHz):

- Pre-Scan has been conducted to determine the worst-case mode from all possible combinations between available modulations, data rates and antenna ports (if EUT with antenna diversity architecture).
- Following channel(s) was (were) selected for the final test as listed below.

EUT Configure Mode	Mode	Frequency Band (MHz)	Available Channel	Tested Channel	Modulation Technology	Data Rate (Mbps)
-	802.11a	5180-5240	36 to 48	165	OFDM	6.0
	802.11a	5745-5825	149 to 165		OFDM	6.0

Power Line Conducted Emission Test:

- Pre-Scan has been conducted to determine the worst-case mode from all possible combinations between available modulations, data rates and antenna ports (if EUT with antenna diversity architecture).
- Following channel(s) was (were) selected for the final test as listed below.

EUT Configure Mode	Mode	Frequency Band (MHz)	Available Channel	Tested Channel	Modulation Technology	Data Rate (Mbps)
-	802.11a	5180-5240	36 to 48	165	OFDM	6.0
	802.11a	5745-5825	149 to 165		OFDM	6.0

Antenna Port Conducted Measurement:

- This item includes all test value of each mode, but only includes spectrum plot of worst value of each mode.
- Pre-Scan has been conducted to determine the worst-case mode from all possible combinations between available modulations, data rates and antenna ports (if EUT with antenna diversity architecture).
- Following channel(s) was (were) selected for the final test as listed below.

EUT Configure Mode	Mode	Frequency Band (MHz)	Available Channel	Tested Channel	Modulation Technology	Data Rate (Mbps)
-	802.11a	5180-5240	36 to 48	36, 40, 48	OFDM	6.0
	802.11n (HT20)		36 to 48	36, 40, 48	OFDM	6.5
	802.11n (HT40)		38 to 46	38, 46	OFDM	13.5
	802.11ac (VHT80)		42	42	OFDM	29.3
-	802.11a	5745-5825	149 to 165	149, 157, 165	OFDM	6.0
	802.11n (HT20)		149 to 165	149, 157, 165	OFDM	6.5
	802.11n (HT40)		151 to 159	151, 159	OFDM	13.5
	802.11ac (VHT80)		155	155	OFDM	29.3

Test Condition:

Applicable to	Environmental Conditions	Input Power	Tested by
RE \geq 1G	22 deg. C, 66% RH	53Vdc	Adair Peng
RE<1G	22 deg. C, 66% RH	53Vdc	Adair Peng
	26 deg. C, 70% RH	56Vdc	Willy Cheng
PLC	23 deg. C, 69% RH	53Vdc	Adair Peng
	26 deg. C, 69% RH	56Vdc	Willy Cheng
APCM	25 deg. C, 60% RH	53Vdc	Chris Lin

3.3 Duty Cycle of Test Signal

802.11n (HT20): Duty cycle of test signal is $\geq 98\%$, duty factor is not required.

802.11a, 802.11n (HT40), 802.11ac (VHT80): Duty cycle of test signal is $< 98\%$, duty factor is required.

802.11a: Duty cycle = $2.016/2.090 = 0.965$, Duty factor = $10 * \log(1/0.965) = 0.16$

802.11n (HT20): Duty cycle = $4.944/5.022 = 0.984$

802.11n (HT40): Duty cycle = $2.391/2.482 = 0.963$, Duty factor = $10 * \log(1/0.963) = 0.16$

802.11ac (VHT80): Duty cycle = $1.131/1.205 = 0.939$, Duty factor = $10 * \log(1/0.939) = 0.28$

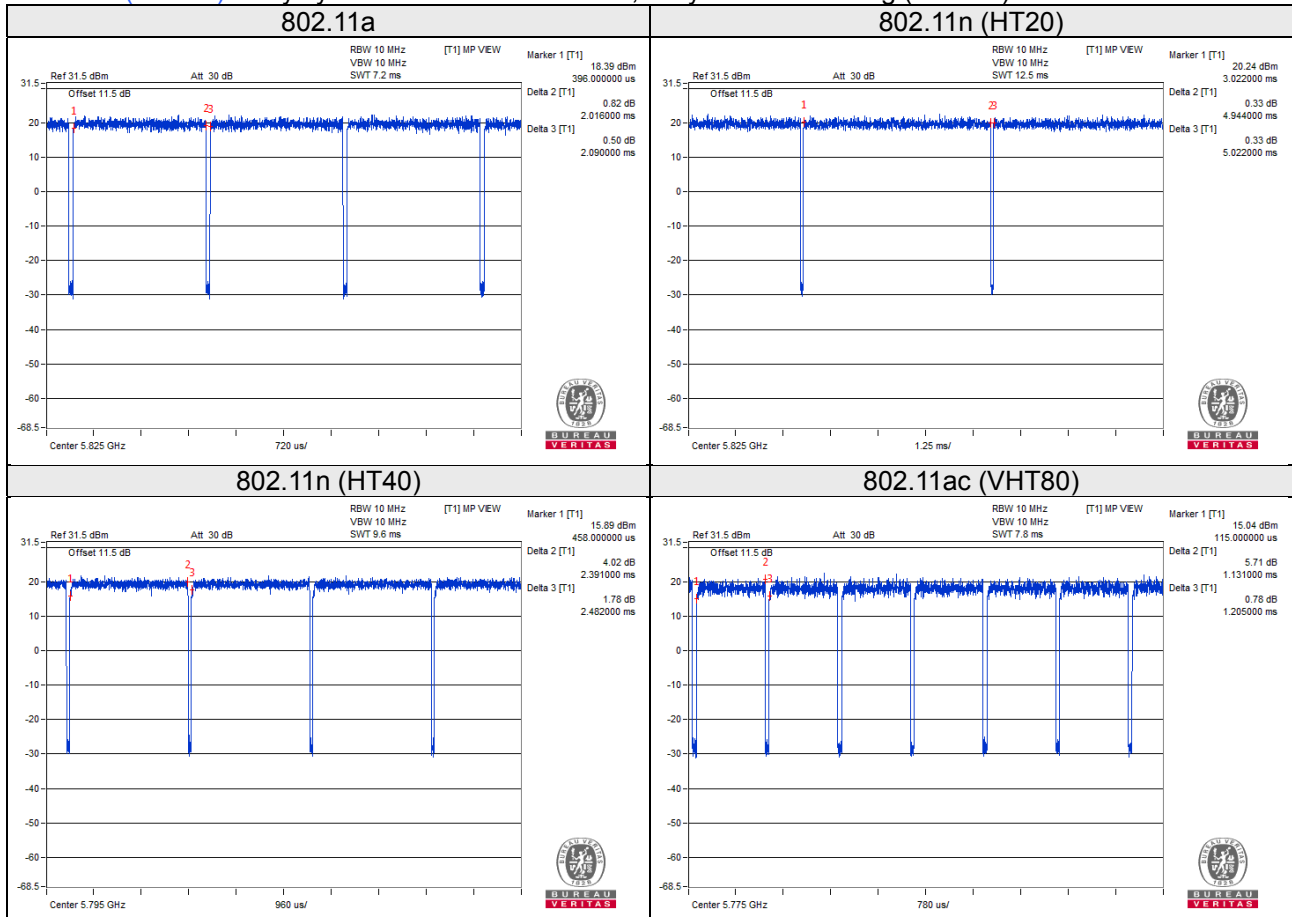

3.4 Description of Support Units

The EUT has been tested as an independent unit together with other necessary accessories or support units. The following support units or accessories were used to form a representative test configuration during the tests.

ID	Product	Brand	Model No.	Serial No.	FCC ID	Remarks
A.	Notebook	DELL	E5410	1HC2XM1	FCC DoC Approved	-
B.	Load	NA	NA	NA	NA	-

Note:

1. All power cords of the above support units are non-shielded (1.8m).
2. Item A acted as a communication partner to transfer data.

ID	Descriptions	Qty.	Length (m)	Shielding (Yes/No)	Cores (Qty.)	Remarks
1.	RJ45 cable	1	6	N	0	Cat5e
2.	RJ45 cable	1	1	N	0	Cat5e
3.	RJ45 cable	1	1.8	N	0	Cat5e

3.4.1 Configuration of System under Test

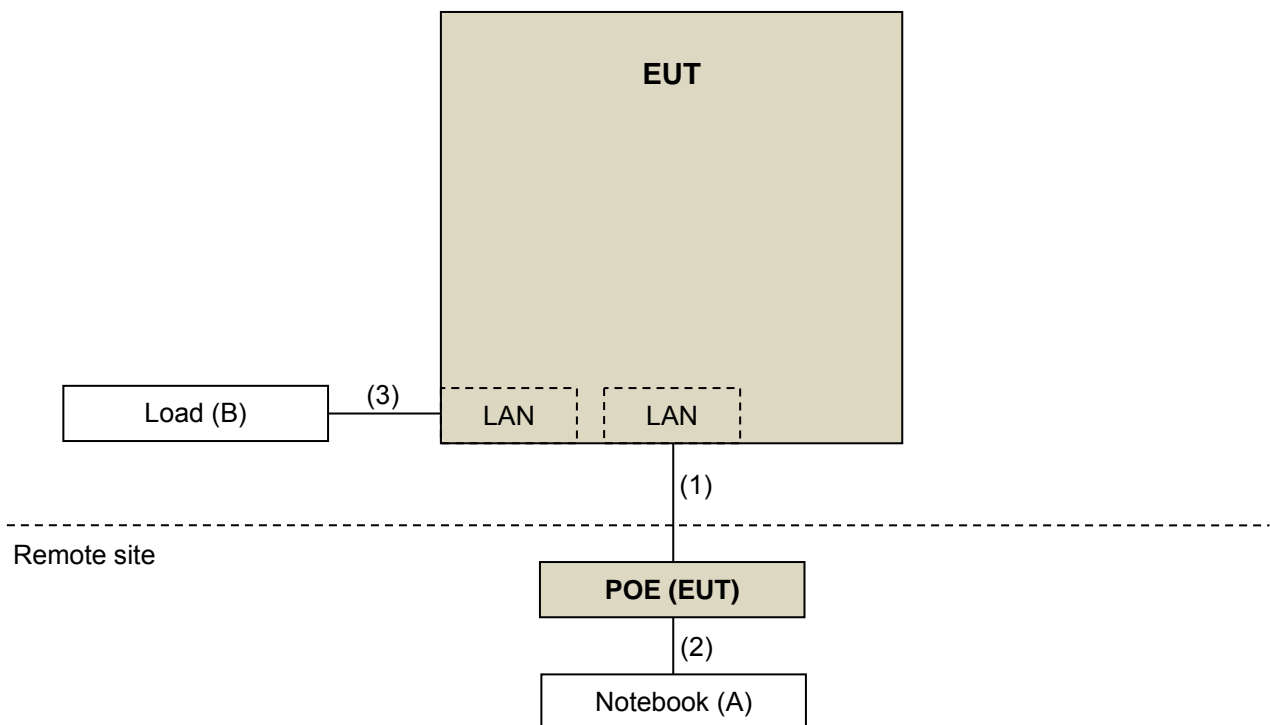

3.5 General Description of Applied Standards

The EUT is a RF Product. According to the specifications of the manufacturer, it must comply with the requirements of the following standards:

FCC Part 15, Subpart E (15.407)

KDB 789033 D02 General UNII Test Procedure New Rules v02r01

KDB 662911 D01 Multiple Transmitter Output v02r01

ANSI C63.10:2013

All test items have been performed and recorded as per the above standards.

4 Test Types and Results

4.1 Radiated Emission and Bandedge Measurement

4.1.1 Limits of Radiated Emission and Bandedge Measurement

Radiated emissions which fall in the restricted bands must comply with the radiated emission limits specified as below table.

Frequencies (MHz)	Field Strength (microvolts/meter)	Measurement Distance (meters)
0.009 ~ 0.490	2400/F(kHz)	300
0.490 ~ 1.705	24000/F(kHz)	30
1.705 ~ 30.0	30	30
30 ~ 88	100	3
88 ~ 216	150	3
216 ~ 960	200	3
Above 960	500	3

Note:

1. The lower limit shall apply at the transition frequencies.
2. Emission level (dBuV/m) = 20 log Emission level (uV/m).
3. For frequencies above 1000MHz, the field strength limits are based on average detector, however, the peak field strength of any emission shall not exceed the maximum permitted average limits, specified above by more than 20dB under any condition of modulation.

Limits of unwanted emission out of the restricted bands

Applicable To		Limit	
789033 D02 General UNII Test Procedure New Rules v02r01		Field Strength at 3m	
		PK: 74 (dBµV/m)	AV: 54 (dBµV/m)
Frequency Band	Applicable To	EIRP Limit	Equivalent Field Strength at 3m
5150~5250 MHz	15.407(b)(1)	PK: -27 (dBm/MHz)	PK: 68.2(dBµV/m)
5250~5350 MHz	15.407(b)(2)		
5470~5725 MHz	15.407(b)(3)		
5725~5850 MHz	<input checked="" type="checkbox"/> 15.407(b)(4)(i)	PK: -27 (dBm/MHz) ^{*1} PK: 10 (dBm/MHz) ^{*2} PK: 15.6 (dBm/MHz) ^{*3} PK: 27 (dBm/MHz) ^{*4}	PK: 68.2(dBµV/m) ^{*1} PK: 105.2 (dBµV/m) ^{*2} PK: 110.8(dBµV/m) ^{*3} PK: 122.2 (dBµV/m) ^{*4}
	<input type="checkbox"/> 15.407(b)(4)(ii)	Emission limits in section 15.247(d)	
^{*1} beyond 75 MHz or more above of the band edge.		^{*2} below the band edge increasing linearly to 10 dBm/MHz at 25 MHz above.	
^{*3} below the band edge increasing linearly to a level of 15.6 dBm/MHz at 5 MHz above.		^{*4} from 5 MHz above or below the band edge increasing linearly to a level of 27 dBm/MHz at the band edge.	

Note: The following formula is used to convert the equipment isotropic radiated power (eirp) to field strength:

$$E = \frac{1000000 \sqrt{30P}}{3} \mu\text{V/m, where P is the eirp (Watts).}$$

4.1.2 Test Instruments

Description & Manufacturer	Model No.	Serial No.	Cal. Date	Cal. Due
Test Receiver ROHDE & SCHWARZ	ESIB7	100187	May 29, 2018	May 28, 2019
			May 30, 2019	May 29, 2020
BILOG Antenna SCHWARZBECK	VULB9168	9168-171	Nov. 22, 2018	Nov. 21, 2019
HORN Antenna SCHWARZBECK	9120D	209	Nov. 25, 2018	Nov. 24, 2019
HORN Antenna SCHWARZBECK	BBHA 9170	BBHA9170241	Nov. 25, 2018	Nov. 24, 2019
Loop Antenna EMCI	EM-6879	269	Sep. 07, 2018	Sep. 06, 2019
Preamplifier Agilent (Below 1GHz)	8447D	2944A10738	Aug. 21, 2018	Aug. 20, 2019
Preamplifier Agilent (Above 1GHz)	8449B	3008A02465	Mar. 27, 2019	Mar. 26, 2020
RF signal cable HUBER+SUHNER	SUCOFLEX 104	Cable-CH3-03 (223653/4)	Aug. 21, 2018	Aug. 20, 2019
RF signal cable HUBER+SUHNER& EMCI	SUCOFLEX 104&EMC104-SM-S M-8000	Cable-CH3-03 (309224+170907)	Aug. 21, 2018	Aug. 20, 2019
Software BV ADT	ADT_Radiated_ V7.6.15.9.5	NA	NA	NA
Antenna Tower inn-co GmbH	MA 4000	013303	NA	NA
Antenna Tower Controller BV ADT	AT100	AT93021702	NA	NA
Turn Table BV ADT	TT100	TT93021702	NA	NA
Turn Table Controller BV ADT	SC100	SC93021702	NA	NA
Boresight Antenna Fixture	FBA-01	FBA-SIP01	NA	NA
Pre-amplifier (18GHz-40GHz) EMC	EMC184045B	980175	Nov. 14, 2018	Nov. 13, 2019
USB Wideband Power Sensor KEYSIGHT	U2021XA	MY55050005/MY5519 0004/MY55190007/MY 55210005	Jul. 17, 2018	Jul. 16, 2019

- Note:
1. The calibration interval of the above test instruments is 12 months and the calibrations are traceable to NML/ROC and NIST/USA.
 2. The test was performed in HwaYa Chamber 3.
 3. The horn antenna and preamplifier (model: 8449B) are used only for the measurement of emission frequency above 1GHz if tested.
 4. The FCC Designation Number is TW0003. The number will be varied with the Lab location and scope as attached.
 5. The IC Site Registration No. is 7450F-3.

4.1.3 Test Procedures

For Radiated emission below 30MHz

- a. The EUT was placed on the top of a rotating table 0.8 meters above the ground at a 3 meter chamber room. The table was rotated 360 degrees to determine the position of the highest radiation.
- b. The EUT was set 3 meters away from the interference-receiving antenna, which was mounted on the top of a variable-height antenna tower.
- c. Parallel, perpendicular, and ground-parallel orientations of the antenna are set to make the measurement.
- d. For each suspected emission, the EUT was arranged to its worst case and the rotatable table was turned from 0 degrees to 360 degrees to find the maximum reading.
- e. The test-receiver system was set to Quasi-Peak Detect Function and Specified Bandwidth with Maximum Hold Mode.

Note:

1. The resolution bandwidth and video bandwidth of test receiver/spectrum analyzer is 9kHz at frequency below 30MHz.

For Radiated emission above 30MHz

- a. The EUT was placed on the top of a rotating table 0.8 meters (for 30MHz ~ 1GHz) / 1.5 meters (for above 1GHz) above the ground at 3 meter chamber room for test. The table was rotated 360 degrees to determine the position of the highest radiation.
- b. The EUT was set 3 meters away from the interference-receiving antenna, which was mounted on the top of a variable-height antenna tower.
- c. The height of antenna is varied from one meter to four meters above the ground to determine the maximum value of the field strength. Both horizontal and vertical polarizations of the antenna are set to make the measurement.
- d. For each suspected emission, the EUT was arranged to its worst case and then the antenna was tuned to heights from 1 meter to 4 meters and the rotatable table was turned from 0 degrees to 360 degrees to find the maximum reading.
- e. The test-receiver system was set to quasi-peak detect function and specified bandwidth with maximum hold mode when the test frequency is below 1 GHz.
- f. The test-receiver system was set to peak and average detect function and specified bandwidth with maximum hold mode when the test frequency is above 1 GHz. If the peak reading value also meets average limit, measurement with the average detector is unnecessary.

Note:

1. The resolution bandwidth and video bandwidth of test receiver/spectrum analyzer is 120kHz for Quasi-peak detection (QP) at frequency below 1GHz.
2. The resolution bandwidth of test receiver/spectrum analyzer is 1 MHz and the video bandwidth is 3 MHz for Peak detection (PK) at frequency above 1GHz.
3. The resolution bandwidth of test receiver/spectrum analyzer is 1MHz and the video bandwidth is $\geq 1/T$ (Duty cycle < 98%) or 10Hz (Duty cycle $\geq 98\%$) for Average detection (AV) at frequency above 1GHz.
4. All modes of operation were investigated and the worst-case emissions are reported.

4.1.4 Deviation from Test Standard

No deviation.

4.1.5 Test Setup

For Radiated emission below 30MHz

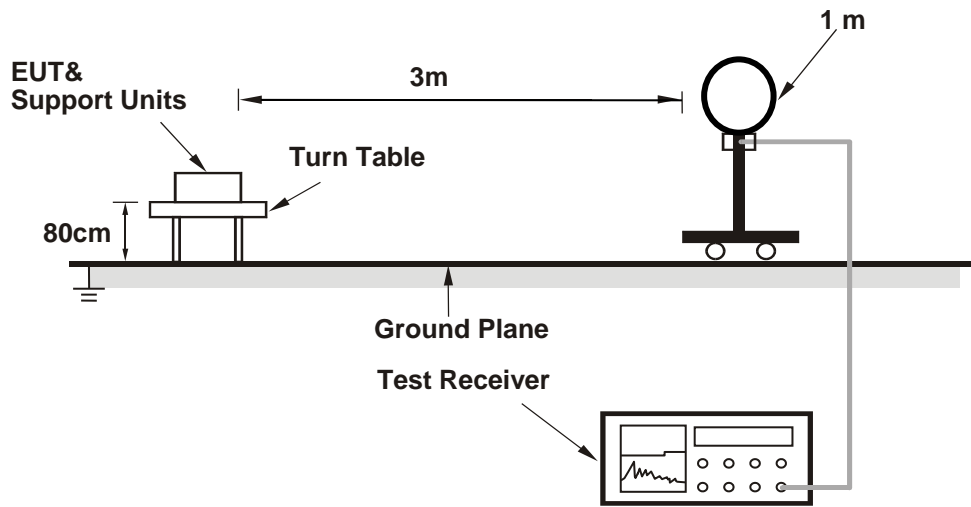

For Radiated emission 30MHz to 1GHz

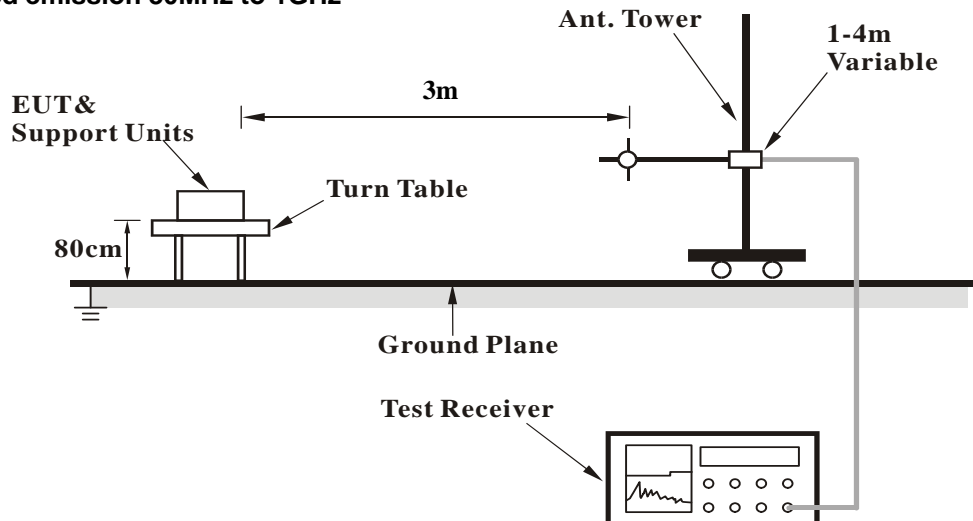

For Radiated emission above 1GHz

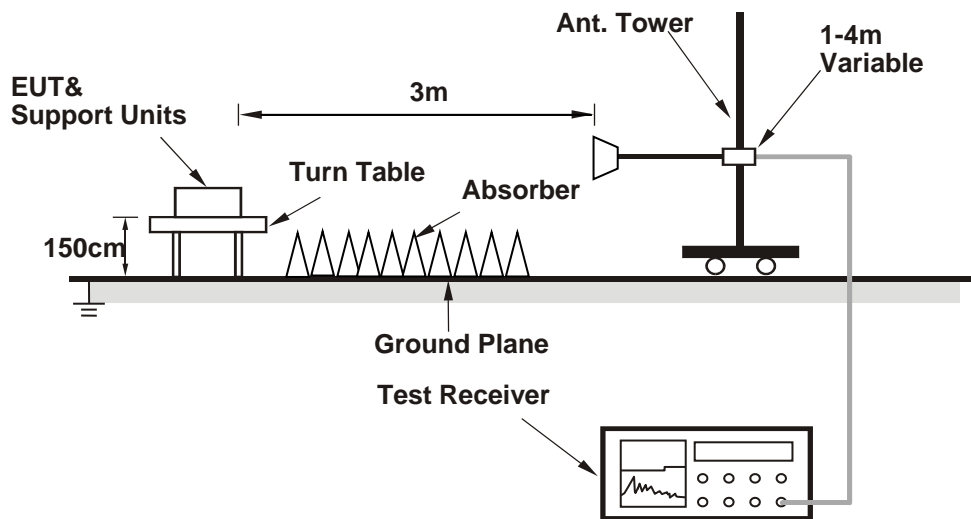

For the actual test configuration, please refer to the attached file (Test Setup Photo).

4.1.6 EUT Operating Conditions

- a. Placed the EUT on the testing table.
- b. Prepared a notebook to act as a communication partner and placed it outside of testing area.
- c. The communication partner connected with EUT via a RJ45 cable and ran a test program (provided by manufacturer) to enable EUT under transmission condition continuously at specific channel frequency.
- d. The communication partner sent data to EUT by command "PING".

4.1.7 Test Results

Above 1GHz data:

802.11a

CHANNEL	TX Channel 36	DETECTOR FUNCTION	Peak (PK) Average (AV)
FREQUENCY RANGE	1GHz ~ 40GHz		

ANTENNA POLARITY & TEST DISTANCE: HORIZONTAL AT 3 M								
NO.	FREQ. (MHz)	EMISSION LEVEL (dBuV/m)	LIMIT (dBuV/m)	MARGIN (dB)	ANTENNA HEIGHT (m)	TABLE ANGLE (Degree)	RAW VALUE (dBuV)	CORRECTION FACTOR (dB/m)
1	5150.00	59.0 PK	74.0	-15.0	1.89 H	279	49.3	9.7
2	5150.00	46.5 AV	54.0	-7.5	1.89 H	279	36.8	9.7
3	*5180.00	113.5 PK			1.72 H	261	74.0	39.5
4	*5180.00	102.1 AV			1.72 H	261	62.6	39.5
5	#10360.00	59.0 PK	68.2	-9.2	1.59 H	266	39.9	19.1
ANTENNA POLARITY & TEST DISTANCE: VERTICAL AT 3 M								
NO.	FREQ. (MHz)	EMISSION LEVEL (dBuV/m)	LIMIT (dBuV/m)	MARGIN (dB)	ANTENNA HEIGHT (m)	TABLE ANGLE (Degree)	RAW VALUE (dBuV)	CORRECTION FACTOR (dB/m)
1	5150.00	59.8 PK	74.0	-14.2	1.35 V	160	50.1	9.7
2	5150.00	46.9 AV	54.0	-7.1	1.35 V	160	37.2	9.7
3	*5180.00	114.8 PK			1.23 V	152	75.3	39.5
4	*5180.00	103.6 AV			1.23 V	152	64.1	39.5
5	#10360.00	59.2 PK	68.2	-9.0	1.75 V	315	40.1	19.1

Remarks:

1. Emission Level(dBuV/m) = Raw Value(dBuV) + Correction Factor(dB/m).
2. Correction Factor(dB/m) = Antenna Factor(dB/m) + Cable Factor(dB) – Pre-Amplifier Factor(dB).
3. Margin value = Emission Level – Limit value.
4. The other emission levels were very low against the limit.
5. " * ": Fundamental frequency.
6. " # ": The radiated frequency is out of the restricted band.

CHANNEL	TX Channel 40	DETECTOR FUNCTION	Peak (PK) Average (AV)
FREQUENCY RANGE	1GHz ~ 40GHz		

ANTENNA POLARITY & TEST DISTANCE: HORIZONTAL AT 3 M

NO.	FREQ. (MHz)	EMISSION LEVEL (dBuV/m)	LIMIT (dBuV/m)	MARGIN (dB)	ANTENNA HEIGHT (m)	TABLE ANGLE (Degree)	RAW VALUE (dBuV)	CORRECTION FACTOR (dB/m)
1	*5200.00	112.8 PK			1.75 H	265	73.3	39.5
2	*5200.00	101.5 AV			1.75 H	265	62.0	39.5
3	#10400.00	59.2 PK	68.2	-9.0	1.63 H	253	40.0	19.2

ANTENNA POLARITY & TEST DISTANCE: VERTICAL AT 3 M

NO.	FREQ. (MHz)	EMISSION LEVEL (dBuV/m)	LIMIT (dBuV/m)	MARGIN (dB)	ANTENNA HEIGHT (m)	TABLE ANGLE (Degree)	RAW VALUE (dBuV)	CORRECTION FACTOR (dB/m)
1	*5200.00	114.1 PK			1.20 V	179	74.6	39.5
2	*5200.00	103.0 AV			1.20 V	179	63.5	39.5
3	#10400.00	59.4 PK	68.2	-8.8	1.71 V	323	40.2	19.2

Remarks:

1. Emission Level(dBuV/m) = Raw Value(dBuV) + Correction Factor(dB/m).
2. Correction Factor(dB/m) = Antenna Factor(dB/m) + Cable Factor(dB) – Pre-Amplifier Factor(dB).
3. Margin value = Emission Level – Limit value.
4. The other emission levels were very low against the limit.
5. " * ": Fundamental frequency.
6. " # ": The radiated frequency is out of the restricted band.

CHANNEL	TX Channel 48	DETECTOR FUNCTION	Peak (PK) Average (AV)
FREQUENCY RANGE	1GHz ~ 40GHz		

ANTENNA POLARITY & TEST DISTANCE: HORIZONTAL AT 3 M

NO.	FREQ. (MHz)	EMISSION LEVEL (dBuV/m)	LIMIT (dBuV/m)	MARGIN (dB)	ANTENNA HEIGHT (m)	TABLE ANGLE (Degree)	RAW VALUE (dBuV)	CORRECTION FACTOR (dB/m)
1	*5240.00	112.6 PK			1.74 H	266	73.3	39.3
2	*5240.00	101.3 AV			1.74 H	266	62.0	39.3
3	5350.00	59.7 PK	74.0	-14.3	1.69 H	288	50.0	9.7
4	5350.00	46.9 AV	54.0	-7.1	1.69 H	288	37.2	9.7
5	#10480.00	61.9 PK	68.2	-6.3	1.70 H	257	42.0	19.9

ANTENNA POLARITY & TEST DISTANCE: VERTICAL AT 3 M

NO.	FREQ. (MHz)	EMISSION LEVEL (dBuV/m)	LIMIT (dBuV/m)	MARGIN (dB)	ANTENNA HEIGHT (m)	TABLE ANGLE (Degree)	RAW VALUE (dBuV)	CORRECTION FACTOR (dB/m)
1	*5240.00	113.8 PK			1.19 V	154	74.5	39.3
2	*5240.00	102.6 AV			1.19 V	154	63.3	39.3
3	5350.00	60.8 PK	74.0	-13.2	1.31 V	163	51.1	9.7
4	5350.00	47.2 AV	54.0	-6.8	1.31 V	163	37.5	9.7
5	#10480.00	62.4 PK	68.2	-5.8	1.77 V	323	42.5	19.9

Remarks:

1. Emission Level(dBuV/m) = Raw Value(dBuV) + Correction Factor(dB/m).
2. Correction Factor(dB/m) = Antenna Factor(dB/m) + Cable Factor(dB) – Pre-Amplifier Factor(dB).
3. Margin value = Emission Level – Limit value.
4. The other emission levels were very low against the limit.
5. " * " : Fundamental frequency.
6. " # " : The radiated frequency is out of the restricted band.

CHANNEL	TX Channel 149	DETECTOR FUNCTION	Peak (PK) Average (AV)
FREQUENCY RANGE	1GHz ~ 40GHz		

ANTENNA POLARITY & TEST DISTANCE: HORIZONTAL AT 3 M

NO.	FREQ. (MHz)	EMISSION LEVEL (dBuV/m)	LIMIT (dBuV/m)	MARGIN (dB)	ANTENNA HEIGHT (m)	TABLE ANGLE (Degree)	RAW VALUE (dBuV)	CORRECTION FACTOR (dB/m)
1	#5624.36	54.1 PK	68.2	-14.1	1.85 H	291	49.9	4.2
2	*5745.00	117.5 PK			1.85 H	291	77.4	40.1
3	*5745.00	105.2 AV			1.85 H	291	65.1	40.1
4	#5998.72	52.9 PK	68.2	-15.3	1.85 H	291	47.8	5.1
5	11490.00	66.8 PK	74.0	-7.2	1.52 H	307	49.2	17.6
6	11490.00	52.4 AV	54.0	-1.6	1.52 H	307	34.8	17.6

ANTENNA POLARITY & TEST DISTANCE: VERTICAL AT 3 M

NO.	FREQ. (MHz)	EMISSION LEVEL (dBuV/m)	LIMIT (dBuV/m)	MARGIN (dB)	ANTENNA HEIGHT (m)	TABLE ANGLE (Degree)	RAW VALUE (dBuV)	CORRECTION FACTOR (dB/m)
1	#5618.59	57.1 PK	68.2	-11.1	1.22 V	170	52.8	4.3
2	*5745.00	116.3 PK			1.22 V	170	76.2	40.1
3	*5745.00	104.6 AV			1.22 V	170	64.5	40.1
4	#5992.95	57.2 PK	68.2	-11.0	1.22 V	170	52.1	5.1
5	11490.00	64.3 PK	74.0	-9.7	1.63 V	43	46.7	17.6
6	11490.00	50.8 AV	54.0	-3.2	1.63 V	43	33.2	17.6

Remarks:

1. Emission Level(dBuV/m) = Raw Value(dBuV) + Correction Factor(dB/m).
2. Correction Factor(dB/m) = Antenna Factor(dB/m) + Cable Factor(dB) – Pre-Amplifier Factor(dB).
3. Margin value = Emission Level – Limit value.
4. The other emission levels were very low against the limit.
5. " * " : Fundamental frequency.
6. " # " : The radiated frequency is out of the restricted band.

CHANNEL	TX Channel 157	DETECTOR FUNCTION	Peak (PK) Average (AV)
FREQUENCY RANGE	1GHz ~ 40GHz		

ANTENNA POLARITY & TEST DISTANCE: HORIZONTAL AT 3 M

NO.	FREQ. (MHz)	EMISSION LEVEL (dBuV/m)	LIMIT (dBuV/m)	MARGIN (dB)	ANTENNA HEIGHT (m)	TABLE ANGLE (Degree)	RAW VALUE (dBuV)	CORRECTION FACTOR (dB/m)
1	#5623.08	54.2 PK	68.2	-14.0	1.81 H	290	50.0	4.2
2	*5785.00	116.8 PK			1.81 H	290	76.5	40.3
3	*5785.00	105.5 AV			1.81 H	290	65.2	40.3
4	#5925.00	52.7 PK	68.2	-15.5	1.81 H	290	47.8	4.9
5	11570.00	67.9 PK	74.0	-6.1	1.74 H	314	50.4	17.5
6	11570.00	52.7 AV	54.0	-1.3	1.74 H	314	35.2	17.5

ANTENNA POLARITY & TEST DISTANCE: VERTICAL AT 3 M

NO.	FREQ. (MHz)	EMISSION LEVEL (dBuV/m)	LIMIT (dBuV/m)	MARGIN (dB)	ANTENNA HEIGHT (m)	TABLE ANGLE (Degree)	RAW VALUE (dBuV)	CORRECTION FACTOR (dB/m)
1	#5601.92	57.4 PK	68.2	-10.8	1.22 V	172	53.1	4.3
2	*5785.00	116.6 PK			1.22 V	172	76.3	40.3
3	*5785.00	104.6 AV			1.22 V	172	64.3	40.3
4	#5944.23	57.4 PK	68.2	-10.8	1.22 V	172	52.5	4.9
5	11570.00	65.3 PK	74.0	-8.7	1.57 V	37	47.8	17.5
6	11570.00	51.1 AV	54.0	-2.9	1.57 V	37	33.6	17.5

Remarks:

1. Emission Level(dBuV/m) = Raw Value(dBuV) + Correction Factor(dB/m).
2. Correction Factor(dB/m) = Antenna Factor(dB/m) + Cable Factor(dB) – Pre-Amplifier Factor(dB).
3. Margin value = Emission Level – Limit value.
4. The other emission levels were very low against the limit.
5. " * " : Fundamental frequency.
6. " # " : The radiated frequency is out of the restricted band.

CHANNEL	TX Channel 165	DETECTOR FUNCTION	Peak (PK) Average (AV)
FREQUENCY RANGE	1GHz ~ 40GHz		

ANTENNA POLARITY & TEST DISTANCE: HORIZONTAL AT 3 M

NO.	FREQ. (MHz)	EMISSION LEVEL (dBuV/m)	LIMIT (dBuV/m)	MARGIN (dB)	ANTENNA HEIGHT (m)	TABLE ANGLE (Degree)	RAW VALUE (dBuV)	CORRECTION FACTOR (dB/m)
1	#5608.97	54.0 PK	68.2	-14.2	1.78 H	288	49.7	4.3
2	*5825.00	117.6 PK			1.78 H	288	77.2	40.4
3	*5825.00	106.0 AV			1.78 H	288	65.6	40.4
4	#5969.87	52.5 PK	68.2	-15.7	1.78 H	288	47.5	5.0
5	11650.00	67.8 PK	74.0	-6.2	1.95 H	316	50.7	17.1
6	11650.00	52.7 AV	54.0	-1.3	1.95 H	316	35.6	17.1

ANTENNA POLARITY & TEST DISTANCE: VERTICAL AT 3 M

NO.	FREQ. (MHz)	EMISSION LEVEL (dBuV/m)	LIMIT (dBuV/m)	MARGIN (dB)	ANTENNA HEIGHT (m)	TABLE ANGLE (Degree)	RAW VALUE (dBuV)	CORRECTION FACTOR (dB/m)
1	#5629.49	57.1 PK	68.2	-11.1	1.20 V	172	52.9	4.2
2	*5825.00	116.7 PK			1.20 V	172	76.3	40.4
3	*5825.00	104.8 AV			1.20 V	172	64.4	40.4
4	#5968.59	58.0 PK	68.2	-10.2	1.20 V	172	53.0	5.0
5	11650.00	65.0 PK	74.0	-9.0	1.65 V	40	47.9	17.1
6	11650.00	50.9 AV	54.0	-3.1	1.65 V	40	33.8	17.1

Remarks:

1. Emission Level(dBuV/m) = Raw Value(dBuV) + Correction Factor(dB/m).
2. Correction Factor(dB/m) = Antenna Factor(dB/m) + Cable Factor(dB) – Pre-Amplifier Factor(dB).
3. Margin value = Emission Level – Limit value.
4. The other emission levels were very low against the limit.
5. " * " : Fundamental frequency.
6. " # " : The radiated frequency is out of the restricted band.

802.11n (HT20)

CHANNEL	TX Channel 36	DETECTOR FUNCTION	Peak (PK) Average (AV)
FREQUENCY RANGE	1GHz ~ 40GHz		

ANTENNA POLARITY & TEST DISTANCE: HORIZONTAL AT 3 M								
NO.	FREQ. (MHz)	EMISSION LEVEL (dBuV/m)	LIMIT (dBuV/m)	MARGIN (dB)	ANTENNA HEIGHT (m)	TABLE ANGLE (Degree)	RAW VALUE (dBuV)	CORRECTION FACTOR (dB/m)
1	5150.00	59.7 PK	74.0	-14.3	1.69 H	259	50.0	9.7
2	5150.00	46.7 AV	54.0	-7.3	1.69 H	259	37.0	9.7
3	*5180.00	110.8 PK			1.81 H	271	71.3	39.5
4	*5180.00	101.6 AV			1.81 H	271	62.1	39.5
5	#10360.00	59.2 PK	68.2	-9.0	1.69 H	259	40.1	19.1

ANTENNA POLARITY & TEST DISTANCE: VERTICAL AT 3 M								
NO.	FREQ. (MHz)	EMISSION LEVEL (dBuV/m)	LIMIT (dBuV/m)	MARGIN (dB)	ANTENNA HEIGHT (m)	TABLE ANGLE (Degree)	RAW VALUE (dBuV)	CORRECTION FACTOR (dB/m)
1	5150.00	60.8 PK	74.0	-13.2	1.32 V	172	51.1	9.7
2	5150.00	47.2 AV	54.0	-6.8	1.32 V	172	37.5	9.7
3	*5180.00	114.1 PK			1.26 V	151	74.6	39.5
4	*5180.00	103.0 AV			1.26 V	151	63.5	39.5
5	#10360.00	59.4 PK	68.2	-8.8	1.81 V	333	40.3	19.1

Remarks:

1. Emission Level(dBuV/m) = Raw Value(dBuV) + Correction Factor(dB/m).
2. Correction Factor(dB/m) = Antenna Factor(dB/m) + Cable Factor(dB) – Pre-Amplifier Factor(dB).
3. Margin value = Emission Level – Limit value.
4. The other emission levels were very low against the limit.
5. " * ": Fundamental frequency.
6. " # ": The radiated frequency is out of the restricted band.

CHANNEL	TX Channel 40	DETECTOR FUNCTION	Peak (PK) Average (AV)
FREQUENCY RANGE	1GHz ~ 40GHz		

ANTENNA POLARITY & TEST DISTANCE: HORIZONTAL AT 3 M

NO.	FREQ. (MHz)	EMISSION LEVEL (dBuV/m)	LIMIT (dBuV/m)	MARGIN (dB)	ANTENNA HEIGHT (m)	TABLE ANGLE (Degree)	RAW VALUE (dBuV)	CORRECTION FACTOR (dB/m)
1	*5200.00	112.2 PK			1.81 H	259	72.7	39.5
2	*5200.00	101.1 AV			1.81 H	259	61.6	39.5
3	#10400.00	59.2 PK	68.2	-9.0	1.81 H	255	40.0	19.2

ANTENNA POLARITY & TEST DISTANCE: VERTICAL AT 3 M

NO.	FREQ. (MHz)	EMISSION LEVEL (dBuV/m)	LIMIT (dBuV/m)	MARGIN (dB)	ANTENNA HEIGHT (m)	TABLE ANGLE (Degree)	RAW VALUE (dBuV)	CORRECTION FACTOR (dB/m)
1	*5200.00	113.5 PK			1.45 V	167	74.0	39.5
2	*5200.00	102.5 AV			1.45 V	167	63.0	39.5
3	#10400.00	59.1 PK	68.2	-9.1	1.69 V	313	39.9	19.2

Remarks:

1. Emission Level(dBuV/m) = Raw Value(dBuV) + Correction Factor(dB/m).
2. Correction Factor(dB/m) = Antenna Factor(dB/m) + Cable Factor(dB) – Pre-Amplifier Factor(dB).
3. Margin value = Emission Level – Limit value.
4. The other emission levels were very low against the limit.
5. " * ": Fundamental frequency.
6. " # ": The radiated frequency is out of the restricted band.

CHANNEL	TX Channel 48	DETECTOR FUNCTION	Peak (PK) Average (AV)
FREQUENCY RANGE	1GHz ~ 40GHz		

ANTENNA POLARITY & TEST DISTANCE: HORIZONTAL AT 3 M

NO.	FREQ. (MHz)	EMISSION LEVEL (dBuV/m)	LIMIT (dBuV/m)	MARGIN (dB)	ANTENNA HEIGHT (m)	TABLE ANGLE (Degree)	RAW VALUE (dBuV)	CORRECTION FACTOR (dB/m)
1	*5240.00	112.0 PK			1.77 H	268	72.7	39.3
2	*5240.00	100.9 AV			1.77 H	268	61.6	39.3
3	5350.00	59.3 PK	74.0	-14.7	1.82 H	278	49.6	9.7
4	5350.00	46.5 AV	54.0	-7.5	1.82 H	278	36.8	9.7
5	#10480.00	60.2 PK	68.2	-8.0	1.72 H	260	40.3	19.9

ANTENNA POLARITY & TEST DISTANCE: VERTICAL AT 3 M

NO.	FREQ. (MHz)	EMISSION LEVEL (dBuV/m)	LIMIT (dBuV/m)	MARGIN (dB)	ANTENNA HEIGHT (m)	TABLE ANGLE (Degree)	RAW VALUE (dBuV)	CORRECTION FACTOR (dB/m)
1	*5240.00	113.2 PK			1.26 V	168	73.9	39.3
2	*5240.00	102.3 AV			1.26 V	168	63.0	39.3
3	5350.00	60.3 PK	74.0	-13.7	1.41 V	153	50.6	9.7
4	5350.00	46.7 AV	54.0	-7.3	1.41 V	153	37.0	9.7
5	#10480.00	60.4 PK	68.2	-7.8	1.69 V	313	40.5	19.9

Remarks:

1. Emission Level(dBuV/m) = Raw Value(dBuV) + Correction Factor(dB/m).
2. Correction Factor(dB/m) = Antenna Factor(dB/m) + Cable Factor(dB) – Pre-Amplifier Factor(dB).
3. Margin value = Emission Level – Limit value.
4. The other emission levels were very low against the limit.
5. " * " : Fundamental frequency.
6. " # " : The radiated frequency is out of the restricted band.

CHANNEL	TX Channel 149	DETECTOR FUNCTION	Peak (PK) Average (AV)
FREQUENCY RANGE	1GHz ~ 40GHz		

ANTENNA POLARITY & TEST DISTANCE: HORIZONTAL AT 3 M

NO.	FREQ. (MHz)	EMISSION LEVEL (dBuV/m)	LIMIT (dBuV/m)	MARGIN (dB)	ANTENNA HEIGHT (m)	TABLE ANGLE (Degree)	RAW VALUE (dBuV)	CORRECTION FACTOR (dB/m)
1	#5619.23	52.0 PK	68.2	-16.2	1.82 H	291	47.7	4.3
2	*5745.00	116.0 PK			1.82 H	291	75.9	40.1
3	*5745.00	104.1 AV			1.82 H	291	64.0	40.1
4	#5961.54	52.4 PK	68.2	-15.8	1.82 H	291	47.5	4.9
5	11490.00	67.1 PK	74.0	-6.9	1.64 H	309	49.5	17.6
6	11490.00	52.3 AV	54.0	-1.7	1.64 H	309	34.7	17.6

ANTENNA POLARITY & TEST DISTANCE: VERTICAL AT 3 M

NO.	FREQ. (MHz)	EMISSION LEVEL (dBuV/m)	LIMIT (dBuV/m)	MARGIN (dB)	ANTENNA HEIGHT (m)	TABLE ANGLE (Degree)	RAW VALUE (dBuV)	CORRECTION FACTOR (dB/m)
1	#5621.79	57.1 PK	68.2	-11.1	1.03 V	170	52.9	4.2
2	*5745.00	115.3 PK			1.03 V	170	75.2	40.1
3	*5745.00	103.6 AV			1.03 V	170	63.5	40.1
4	#5941.67	57.3 PK	68.2	-10.9	1.03 V	170	52.4	4.9
5	11490.00	64.8 PK	74.0	-9.2	1.65 V	42	47.2	17.6
6	11490.00	50.8 AV	54.0	-3.2	1.65 V	42	33.2	17.6

Remarks:

1. Emission Level(dBuV/m) = Raw Value(dBuV) + Correction Factor(dB/m).
2. Correction Factor(dB/m) = Antenna Factor(dB/m) + Cable Factor(dB) – Pre-Amplifier Factor(dB).
3. Margin value = Emission Level – Limit value.
4. The other emission levels were very low against the limit.
5. " * " : Fundamental frequency.
6. " # " : The radiated frequency is out of the restricted band.

CHANNEL	TX Channel 157	DETECTOR FUNCTION	Peak (PK) Average (AV)
FREQUENCY RANGE	1GHz ~ 40GHz		

ANTENNA POLARITY & TEST DISTANCE: HORIZONTAL AT 3 M

NO.	FREQ. (MHz)	EMISSION LEVEL (dBuV/m)	LIMIT (dBuV/m)	MARGIN (dB)	ANTENNA HEIGHT (m)	TABLE ANGLE (Degree)	RAW VALUE (dBuV)	CORRECTION FACTOR (dB/m)
1	#5605.13	53.6 PK	68.2	-14.6	1.72 H	289	49.3	4.3
2	*5785.00	116.8 PK			1.72 H	289	76.5	40.3
3	*5785.00	104.5 AV			1.72 H	289	64.2	40.3
4	#5971.79	52.4 PK	68.2	-15.8	1.72 H	289	47.3	5.1
5	11570.00	67.6 PK	74.0	-6.4	1.70 H	315	50.1	17.5
6	11570.00	52.4 AV	54.0	-1.6	1.70 H	315	34.9	17.5

ANTENNA POLARITY & TEST DISTANCE: VERTICAL AT 3 M

NO.	FREQ. (MHz)	EMISSION LEVEL (dBuV/m)	LIMIT (dBuV/m)	MARGIN (dB)	ANTENNA HEIGHT (m)	TABLE ANGLE (Degree)	RAW VALUE (dBuV)	CORRECTION FACTOR (dB/m)
1	#5609.62	58.3 PK	68.2	-9.9	1.22 V	172	54.0	4.3
2	*5785.00	115.8 PK			1.22 V	172	75.5	40.3
3	*5785.00	104.4 AV			1.22 V	172	64.1	40.3
4	#5993.59	57.4 PK	68.2	-10.8	1.22 V	172	52.3	5.1
5	11570.00	65.1 PK	74.0	-8.9	1.53 V	38	47.6	17.5
6	11570.00	51.1 AV	54.0	-2.9	1.53 V	38	33.6	17.5

Remarks:

1. Emission Level(dBuV/m) = Raw Value(dBuV) + Correction Factor(dB/m).
2. Correction Factor(dB/m) = Antenna Factor(dB/m) + Cable Factor(dB) – Pre-Amplifier Factor(dB).
3. Margin value = Emission Level – Limit value.
4. The other emission levels were very low against the limit.
5. " * " : Fundamental frequency.
6. " # " : The radiated frequency is out of the restricted band.

CHANNEL	TX Channel 165	DETECTOR FUNCTION	Peak (PK) Average (AV)
FREQUENCY RANGE	1GHz ~ 40GHz		

ANTENNA POLARITY & TEST DISTANCE: HORIZONTAL AT 3 M

NO.	FREQ. (MHz)	EMISSION LEVEL (dBuV/m)	LIMIT (dBuV/m)	MARGIN (dB)	ANTENNA HEIGHT (m)	TABLE ANGLE (Degree)	RAW VALUE (dBuV)	CORRECTION FACTOR (dB/m)
1	#5606.41	53.5 PK	68.2	-14.7	1.67 H	293	49.2	4.3
2	*5825.00	117.8 PK			1.67 H	293	77.4	40.4
3	*5825.00	105.9 AV			1.67 H	293	65.5	40.4
4	#5986.54	53.0 PK	68.2	-15.2	1.67 H	293	47.9	5.1
5	11650.00	67.2 PK	74.0	-6.8	1.73 H	313	50.1	17.1
6	11650.00	52.5 AV	54.0	-1.5	1.73 H	313	35.4	17.1

ANTENNA POLARITY & TEST DISTANCE: VERTICAL AT 3 M

NO.	FREQ. (MHz)	EMISSION LEVEL (dBuV/m)	LIMIT (dBuV/m)	MARGIN (dB)	ANTENNA HEIGHT (m)	TABLE ANGLE (Degree)	RAW VALUE (dBuV)	CORRECTION FACTOR (dB/m)
1	#5616.03	57.7 PK	68.2	-10.5	1.21 V	171	53.4	4.3
2	*5825.00	116.8 PK			1.21 V	171	76.4	40.4
3	*5825.00	104.7 AV			1.21 V	171	64.3	40.4
4	#5990.38	57.1 PK	68.2	-11.1	1.21 V	171	52.0	5.1
5	11650.00	65.1 PK	74.0	-8.9	1.66 V	45	48.0	17.1
6	11650.00	50.6 AV	54.0	-3.4	1.66 V	45	33.5	17.1

Remarks:

1. Emission Level(dBuV/m) = Raw Value(dBuV) + Correction Factor(dB/m).
2. Correction Factor(dB/m) = Antenna Factor(dB/m) + Cable Factor(dB) – Pre-Amplifier Factor(dB).
3. Margin value = Emission Level – Limit value.
4. The other emission levels were very low against the limit.
5. " * " : Fundamental frequency.
6. " # " : The radiated frequency is out of the restricted band.

802.11n (HT40)

CHANNEL	TX Channel 38	DETECTOR FUNCTION	Peak (PK) Average (AV)
FREQUENCY RANGE	1GHz ~ 40GHz		

ANTENNA POLARITY & TEST DISTANCE: HORIZONTAL AT 3 M								
NO.	FREQ. (MHz)	EMISSION LEVEL (dBuV/m)	LIMIT (dBuV/m)	MARGIN (dB)	ANTENNA HEIGHT (m)	TABLE ANGLE (Degree)	RAW VALUE (dBuV)	CORRECTION FACTOR (dB/m)
1	5150.00	62.4 PK	74.0	-11.6	1.67 H	261	58.5	3.9
2	5150.00	48.8 AV	54.0	-5.2	1.67 H	261	44.9	3.9
3	*5190.00	110.6 PK			1.76 H	269	71.1	39.5
4	*5190.00	99.7 AV			1.76 H	269	60.2	39.5
5	#10380.00	58.0 PK	68.2	-10.2	1.66 H	257	42.1	15.9

ANTENNA POLARITY & TEST DISTANCE: VERTICAL AT 3 M								
NO.	FREQ. (MHz)	EMISSION LEVEL (dBuV/m)	LIMIT (dBuV/m)	MARGIN (dB)	ANTENNA HEIGHT (m)	TABLE ANGLE (Degree)	RAW VALUE (dBuV)	CORRECTION FACTOR (dB/m)
1	5150.00	64.7 PK	74.0	-9.3	1.21 V	169	60.8	3.9
2	5150.00	50.9 AV	54.0	-3.1	1.21 V	169	47.0	3.9
3	*5190.00	111.1 PK			1.60 V	168	71.6	39.5
4	*5190.00	101.2 AV			1.60 V	168	61.7	39.5
5	#10380.00	58.3 PK	68.2	-9.9	1.85 V	303	42.4	15.9

Remarks:

1. Emission Level(dBuV/m) = Raw Value(dBuV) + Correction Factor(dB/m).
2. Correction Factor(dB/m) = Antenna Factor(dB/m) + Cable Factor(dB) – Pre-Amplifier Factor(dB).
3. Margin value = Emission Level – Limit value.
4. The other emission levels were very low against the limit.
5. " * ": Fundamental frequency.
6. " # ": The radiated frequency is out of the restricted band.

CHANNEL	TX Channel 46	DETECTOR FUNCTION	Peak (PK) Average (AV)
FREQUENCY RANGE	1GHz ~ 40GHz		

ANTENNA POLARITY & TEST DISTANCE: HORIZONTAL AT 3 M

NO.	FREQ. (MHz)	EMISSION LEVEL (dBuV/m)	LIMIT (dBuV/m)	MARGIN (dB)	ANTENNA HEIGHT (m)	TABLE ANGLE (Degree)	RAW VALUE (dBuV)	CORRECTION FACTOR (dB/m)
1	*5230.00	109.5 PK			1.64 H	269	70.2	39.3
2	*5230.00	98.8 AV			1.64 H	269	59.5	39.3
3	5350.00	58.6 PK	74.0	-15.4	1.53 H	277	54.7	3.9
4	5350.00	44.9 AV	54.0	-9.1	1.53 H	277	41.0	3.9
5	#10460.00	58.8 PK	68.2	-9.4	1.59 H	261	42.2	16.6

ANTENNA POLARITY & TEST DISTANCE: VERTICAL AT 3 M

NO.	FREQ. (MHz)	EMISSION LEVEL (dBuV/m)	LIMIT (dBuV/m)	MARGIN (dB)	ANTENNA HEIGHT (m)	TABLE ANGLE (Degree)	RAW VALUE (dBuV)	CORRECTION FACTOR (dB/m)
1	*5230.00	110.6 PK			1.22 V	160	71.3	39.3
2	*5230.00	100.3 AV			1.22 V	160	61.0	39.3
3	5350.00	59.1 PK	74.0	-14.9	1.45 V	155	55.2	3.9
4	5350.00	46.4 AV	54.0	-7.6	1.45 V	155	42.5	3.9
5	#10460.00	59.2 PK	68.2	-9.0	1.90 V	310	42.6	16.6

Remarks:

1. Emission Level(dBuV/m) = Raw Value(dBuV) + Correction Factor(dB/m).
2. Correction Factor(dB/m) = Antenna Factor(dB/m) + Cable Factor(dB) – Pre-Amplifier Factor(dB).
3. Margin value = Emission Level – Limit value.
4. The other emission levels were very low against the limit.
5. " * " : Fundamental frequency.
6. " # " : The radiated frequency is out of the restricted band.

CHANNEL	TX Channel 151	DETECTOR FUNCTION	Peak (PK) Average (AV)
FREQUENCY RANGE	1GHz ~ 40GHz		

ANTENNA POLARITY & TEST DISTANCE: HORIZONTAL AT 3 M

NO.	FREQ. (MHz)	EMISSION LEVEL (dBuV/m)	LIMIT (dBuV/m)	MARGIN (dB)	ANTENNA HEIGHT (m)	TABLE ANGLE (Degree)	RAW VALUE (dBuV)	CORRECTION FACTOR (dB/m)
1	#5603.21	54.5 PK	68.2	-13.7	1.80 H	292	50.2	4.3
2	*5755.00	115.9 PK			1.80 H	292	75.8	40.1
3	*5755.00	104.5 AV			1.80 H	292	64.4	40.1
4	#5941.67	53.3 PK	68.2	-14.9	1.80 H	292	48.4	4.9
5	11510.00	66.0 PK	74.0	-8.0	1.64 H	312	48.3	17.7
6	11510.00	52.4 AV	54.0	-1.6	1.64 H	312	34.7	17.7

ANTENNA POLARITY & TEST DISTANCE: VERTICAL AT 3 M

NO.	FREQ. (MHz)	EMISSION LEVEL (dBuV/m)	LIMIT (dBuV/m)	MARGIN (dB)	ANTENNA HEIGHT (m)	TABLE ANGLE (Degree)	RAW VALUE (dBuV)	CORRECTION FACTOR (dB/m)
1	#5608.33	57.1 PK	68.2	-11.1	1.25 V	178	52.8	4.3
2	*5755.00	114.9 PK			1.25 V	178	74.8	40.1
3	*5755.00	102.9 AV			1.25 V	178	62.8	40.1
4	#5957.69	57.0 PK	68.2	-11.2	1.25 V	178	52.1	4.9
5	11510.00	63.4 PK	74.0	-10.6	1.59 V	42	45.7	17.7
6	11510.00	50.7 AV	54.0	-3.3	1.59 V	42	33.0	17.7

Remarks:

1. Emission Level(dBuV/m) = Raw Value(dBuV) + Correction Factor(dB/m).
2. Correction Factor(dB/m) = Antenna Factor(dB/m) + Cable Factor(dB) – Pre-Amplifier Factor(dB).
3. Margin value = Emission Level – Limit value.
4. The other emission levels were very low against the limit.
5. " * " : Fundamental frequency.
6. " # " : The radiated frequency is out of the restricted band.

CHANNEL	TX Channel 159	DETECTOR FUNCTION	Peak (PK) Average (AV)
FREQUENCY RANGE	1GHz ~ 40GHz		

ANTENNA POLARITY & TEST DISTANCE: HORIZONTAL AT 3 M

NO.	FREQ. (MHz)	EMISSION LEVEL (dBuV/m)	LIMIT (dBuV/m)	MARGIN (dB)	ANTENNA HEIGHT (m)	TABLE ANGLE (Degree)	RAW VALUE (dBuV)	CORRECTION FACTOR (dB/m)
1	#5610.26	55.2 PK	68.2	-13.0	1.75 H	291	50.9	4.3
2	*5795.00	115.9 PK			1.75 H	291	75.5	40.4
3	*5795.00	104.6 AV			1.75 H	291	64.2	40.4
4	#5983.33	53.0 PK	68.2	-15.2	1.75 H	291	47.9	5.1
5	11590.00	65.9 PK	74.0	-8.1	1.78 H	314	48.4	17.5
6	11590.00	52.5 AV	54.0	-1.5	1.78 H	314	35.0	17.5

ANTENNA POLARITY & TEST DISTANCE: VERTICAL AT 3 M

NO.	FREQ. (MHz)	EMISSION LEVEL (dBuV/m)	LIMIT (dBuV/m)	MARGIN (dB)	ANTENNA HEIGHT (m)	TABLE ANGLE (Degree)	RAW VALUE (dBuV)	CORRECTION FACTOR (dB/m)
1	#5619.23	57.6 PK	68.2	-10.6	1.22 V	173	53.3	4.3
2	*5795.00	115.2 PK			1.22 V	173	74.8	40.4
3	*5795.00	103.9 AV			1.22 V	173	63.5	40.4
4	#5998.72	57.9 PK	68.2	-10.3	1.22 V	173	52.8	5.1
5	11590.00	63.5 PK	74.0	-10.5	1.65 V	39	46.0	17.5
6	11590.00	51.1 AV	54.0	-2.9	1.65 V	39	33.6	17.5

Remarks:

1. Emission Level(dBuV/m) = Raw Value(dBuV) + Correction Factor(dB/m).
2. Correction Factor(dB/m) = Antenna Factor(dB/m) + Cable Factor(dB) – Pre-Amplifier Factor(dB).
3. Margin value = Emission Level – Limit value.
4. The other emission levels were very low against the limit.
5. " * " : Fundamental frequency.
6. " # " : The radiated frequency is out of the restricted band.

802.11ac (VHT80)

CHANNEL	TX Channel 42	DETECTOR FUNCTION	Peak (PK) Average (AV)
FREQUENCY RANGE	1GHz ~ 40GHz		

ANTENNA POLARITY & TEST DISTANCE: HORIZONTAL AT 3 M

NO.	FREQ. (MHz)	EMISSION LEVEL (dBuV/m)	LIMIT (dBuV/m)	MARGIN (dB)	ANTENNA HEIGHT (m)	TABLE ANGLE (Degree)	RAW VALUE (dBuV)	CORRECTION FACTOR (dB/m)
1	5150.00	63.4 PK	74.0	-10.6	1.60 H	271	59.5	3.9
2	5150.00	49.4 AV	54.0	-4.6	1.60 H	271	45.5	3.9
3	*5210.00	106.4 PK			1.69 H	266	67.0	39.4
4	*5210.00	96.2 AV			1.69 H	266	56.8	39.4
5	5350.00	57.2 PK	74.0	-16.8	1.57 H	263	53.3	3.9
6	5350.00	44.7 AV	54.0	-9.3	1.57 H	263	40.8	3.9
7	#10420.00	58.3 PK	68.2	-9.9	1.60 H	263	42.1	16.2

ANTENNA POLARITY & TEST DISTANCE: VERTICAL AT 3 M

NO.	FREQ. (MHz)	EMISSION LEVEL (dBuV/m)	LIMIT (dBuV/m)	MARGIN (dB)	ANTENNA HEIGHT (m)	TABLE ANGLE (Degree)	RAW VALUE (dBuV)	CORRECTION FACTOR (dB/m)
1	5150.00	65.9 PK	74.0	-8.1	1.58 V	167	62.0	3.9
2	5150.00	51.6 AV	54.0	-2.4	1.58 V	167	47.7	3.9
3	*5210.00	107.7 PK			1.24 V	164	68.3	39.4
4	*5210.00	97.6 AV			1.24 V	164	58.2	39.4
5	5350.00	59.5 PK	74.0	-14.5	4.00 V	166	55.6	3.9
6	5350.00	46.5 AV	54.0	-7.5	4.00 V	166	42.6	3.9
7	#10420.00	58.7 PK	68.2	-9.5	1.79 V	299	42.5	16.2

Remarks:

1. Emission Level(dBuV/m) = Raw Value(dBuV) + Correction Factor(dB/m).
2. Correction Factor(dB/m) = Antenna Factor(dB/m) + Cable Factor(dB) – Pre-Amplifier Factor(dB).
3. Margin value = Emission Level – Limit value.
4. The other emission levels were very low against the limit.
5. " * ": Fundamental frequency.
6. " # ": The radiated frequency is out of the restricted band.

CHANNEL	TX Channel 155	DETECTOR FUNCTION	Peak (PK) Average (AV)
FREQUENCY RANGE	1GHz ~ 40GHz		

ANTENNA POLARITY & TEST DISTANCE: HORIZONTAL AT 3 M

NO.	FREQ. (MHz)	EMISSION LEVEL (dBuV/m)	LIMIT (dBuV/m)	MARGIN (dB)	ANTENNA HEIGHT (m)	TABLE ANGLE (Degree)	RAW VALUE (dBuV)	CORRECTION FACTOR (dB/m)
1	#5648.72	59.7 PK	68.2	-8.5	1.80 H	293	55.5	4.2
2	#5650.00	66.5 PK	68.2	-1.7	1.88 H	287	62.3	4.2
3	*5775.00	115.2 PK			1.80 H	293	74.9	40.3
4	*5775.00	103.8 AV			1.80 H	293	63.5	40.3
5	#5925.00	61.0 PK	68.2	-7.2	1.82 H	293	56.1	4.9
6	#5946.79	53.8 PK	68.2	-14.4	1.80 H	293	48.9	4.9
7	11550.00	66.7 PK	74.0	-7.3	1.40 H	316	49.1	17.6
8	11550.00	52.2 AV	54.0	-1.8	1.40 H	316	34.6	17.6

ANTENNA POLARITY & TEST DISTANCE: VERTICAL AT 3 M

NO.	FREQ. (MHz)	EMISSION LEVEL (dBuV/m)	LIMIT (dBuV/m)	MARGIN (dB)	ANTENNA HEIGHT (m)	TABLE ANGLE (Degree)	RAW VALUE (dBuV)	CORRECTION FACTOR (dB/m)
1	#5643.59	60.6 PK	68.2	-7.6	1.12 V	181	56.4	4.2
2	#5650.00	64.3 PK	68.2	-3.9	1.23 V	175	60.1	4.2
3	*5775.00	112.8 PK			1.12 V	181	72.5	40.3
4	*5775.00	102.0 AV			1.12 V	181	61.7	40.3
5	#5925.00	62.1 PK	68.2	-6.1	1.19 V	180	57.2	4.9
6	#5959.62	58.1 PK	68.2	-10.1	1.12 V	181	53.2	4.9
7	11550.00	64.2 PK	74.0	-9.8	1.56 V	42	46.6	17.6
8	11550.00	50.7 AV	54.0	-3.3	1.56 V	42	33.1	17.6

Remarks:

1. Emission Level(dBuV/m) = Raw Value(dBuV) + Correction Factor(dB/m).
2. Correction Factor(dB/m) = Antenna Factor(dB/m) + Cable Factor(dB) – Pre-Amplifier Factor(dB).
3. Margin value = Emission Level – Limit value.
4. The other emission levels were very low against the limit.
5. " * ": Fundamental frequency.
6. " # ": The radiated frequency is out of the restricted band.

Below 1GHz Worst-Case Data:

802.11a

CHANNEL	TX Channel 165	DETECTOR FUNCTION	Quasi-Peak (QP)
FREQUENCY RANGE	9kHz ~ 1GHz		

ANTENNA POLARITY & TEST DISTANCE: HORIZONTAL AT 3 M								
NO.	FREQ. (MHz)	EMISSION LEVEL (dBuV/m)	LIMIT (dBuV/m)	MARGIN (dB)	ANTENNA HEIGHT (m)	TABLE ANGLE (Degree)	RAW VALUE (dBuV)	CORRECTION FACTOR (dB/m)
1	57.12	27.0 QP	40.0	-13.0	2.00 H	341	37.1	-10.1
2	201.00	37.2 QP	43.5	-6.3	1.00 H	181	48.3	-11.1
3	212.66	33.3 QP	43.5	-10.2	1.00 H	174	44.2	-10.9
4	325.43	31.0 QP	46.0	-15.0	1.00 H	327	37.8	-6.8
5	650.13	40.4 QP	46.0	-5.6	1.00 H	94	40.9	-0.5
6	951.49	37.6 QP	46.0	-8.4	1.00 H	183	32.6	5.0

Remarks:

1. Emission Level(dBuV/m) = Raw Value(dBuV) + Correction Factor(dB/m).
2. Correction Factor(dB/m) = Antenna Factor(dB/m) + Cable Factor(dB) – Pre-Amplifier Factor(dB).
3. The other emission levels were very low against the limit of frequency range 30MHz ~ 1000MHz.
4. Margin value = Emission Level – Limit value.
5. The emission levels were very low against the limit of frequency range 9kHz ~ 30MHz: the amplitude of spurious emissions attenuated more than 20 dB below the permissible value to be report.

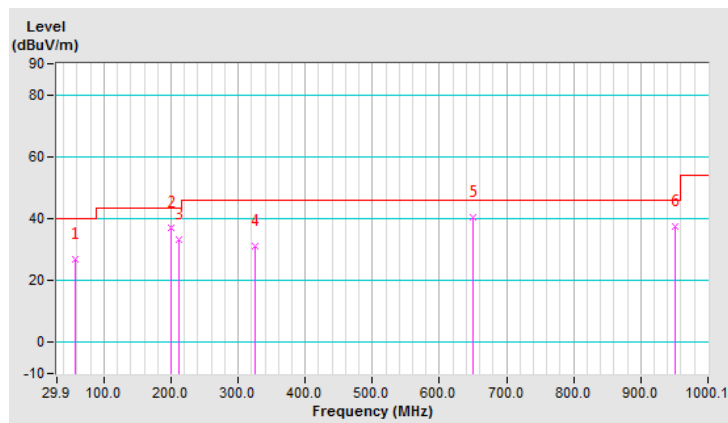

CHANNEL	TX Channel 165	DETECTOR FUNCTION	Quasi-Peak (QP)
FREQUENCY RANGE	9kHz ~ 1GHz		

ANTENNA POLARITY & TEST DISTANCE: VERTICAL AT 3 M								
NO.	FREQ. (MHz)	EMISSION LEVEL (dBuV/m)	LIMIT (dBuV/m)	MARGIN (dB)	ANTENNA HEIGHT (m)	TABLE ANGLE (Degree)	RAW VALUE (dBuV)	CORRECTION FACTOR (dB/m)
1	39.62	35.7 QP	40.0	-4.3	1.51 V	9	46.1	-10.4
2	51.29	33.0 QP	40.0	-7.0	1.01 V	274	42.7	-9.7
3	201.00	31.2 QP	43.5	-12.3	1.51 V	96	42.3	-11.1
4	212.66	27.7 QP	43.5	-15.8	1.51 V	181	38.6	-10.9
5	650.13	38.7 QP	46.0	-7.3	1.01 V	153	39.2	-0.5
6	687.07	34.9 QP	46.0	-11.1	1.01 V	142	34.8	0.1

Remarks:

1. Emission Level(dBuV/m) = Raw Value(dBuV) + Correction Factor(dB/m).
2. Correction Factor(dB/m) = Antenna Factor(dB/m) + Cable Factor(dB) – Pre-Amplifier Factor(dB).
3. The other emission levels were very low against the limit of frequency range 30MHz ~ 1000MHz.
4. Margin value = Emission Level – Limit value.
5. The emission levels were very low against the limit of frequency range 9kHz ~ 30MHz: the amplitude of spurious emissions attenuated more than 20 dB below the permissible value to be report.

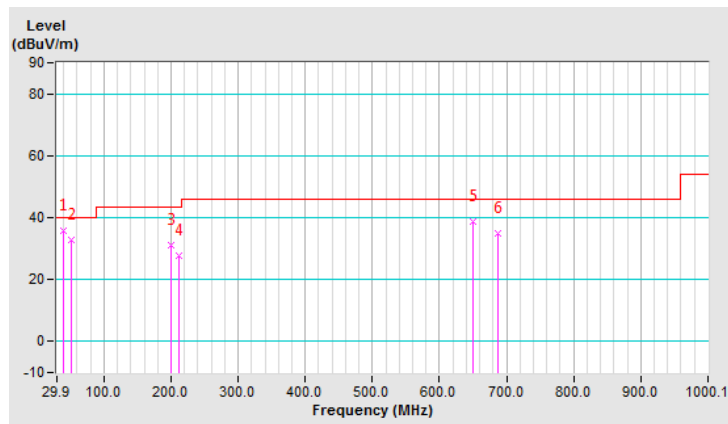

4.2 Conducted Emission Measurement

4.2.1 Limits of Conducted Emission Measurement

Frequency (MHz)	Conducted Limit (dBuV)	
	Quasi-peak	Average
0.15 - 0.5	66 - 56	56 - 46
0.50 - 5.0	56	46
5.0 - 30.0	60	50

Note: 1. The lower limit shall apply at the transition frequencies.

2. The limit decreases in line with the logarithm of the frequency in the range of 0.15 to 0.50MHz.

4.2.2 Test Instruments

Description & Manufacturer	Model No.	Serial No.	Cal. Date	Cal. Due
Test Receiver ROHDE & SCHWARZ	ESCI	100613	Dec. 10, 2018	Dec. 09, 2019
RF signal cable Woken	5D-FB	Cable-cond1-01	Sep. 05, 2018	Sep. 04, 2019
LISN ROHDE & SCHWARZ (EUT)	ENV216	101826	Feb. 21, 2019	Feb. 20, 2020
LISN ROHDE & SCHWARZ (Peripheral)	ESH3-Z5	100311	Aug. 19, 2018	Aug. 18, 2019
Software ADT	BV ADT_Cond_ V7.3.7.4	NA	NA	NA

Note: 1. The calibration interval of the above test instruments is 12 months and the calibrations are traceable to NML/ROC and NIST/USA.

2. The test was performed in HwaYa Shielded Room 1.

3. The VCCI Site Registration No. is C-12040.

4.2.3 Test Procedures

- The EUT was placed 0.4 meters from the conducting wall of the shielded room with EUT being connected to the power mains through a line impedance stabilization network (LISN). Other support units were connected to the power mains through another LISN. The two LISNs provide 50 ohm/ 50uH of coupling impedance for the measuring instrument.
- Both lines of the power mains connected to the EUT were checked for maximum conducted interference.
- The frequency range from 150kHz to 30MHz was searched. Emission levels under (Limit - 20dB) was not recorded.

Note: The resolution bandwidth and video bandwidth of test receiver is 9kHz for quasi-peak detection (QP) and average detection (AV) at frequency 0.15MHz-30MHz.

4.2.4 Deviation from Test Standard

No deviation.

4.2.5 Test Setup

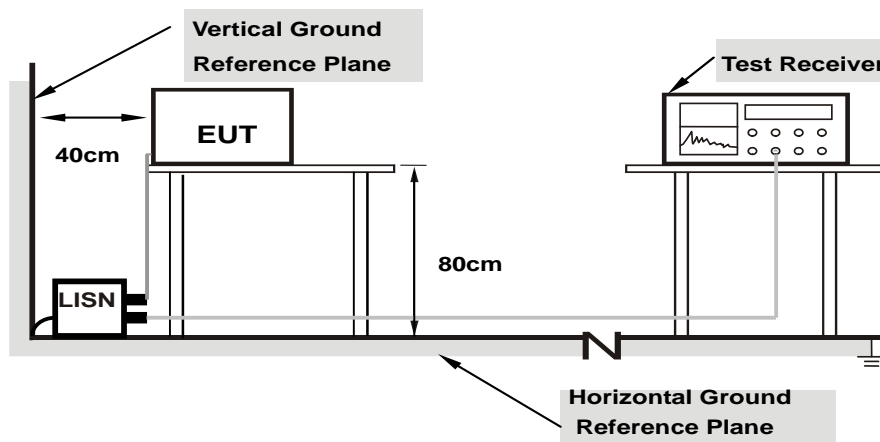

Note: 1.Support units were connected to second LISN.

For the actual test configuration, please refer to the attached file (Test Setup Photo).

4.2.6 EUT Operating Conditions

Same as 4.1.6.

4.2.7 Test Results

Worst-case data:

802.11a

Phase	Line (L)	Detector Function	Quasi-Peak (QP) / Average (AV)
-------	----------	-------------------	--------------------------------

No	Freq. [MHz]	Corr. Factor (dB)	Reading Value		Emission Level		Limit		Margin	
			[dB (uV)]		[dB (uV)]		[dB (uV)]		(dB)	
			Q.P.	AV.	Q.P.	AV.	Q.P.	AV.	Q.P.	AV.
1	0.15391	9.69	38.08	29.66	47.77	39.35	65.79	55.79	-18.02	-16.44
2	0.34926	9.68	33.81	27.78	43.49	37.46	58.98	48.98	-15.49	-11.52
3	0.39242	9.68	39.64	36.62	49.32	46.30	58.01	48.01	-8.69	-1.71
4	0.41979	9.68	38.80	34.33	48.48	44.01	57.45	47.45	-8.97	-3.44
5	0.45575	9.68	32.73	25.46	42.41	35.14	56.77	46.77	-14.36	-11.63
6	0.78733	9.67	27.82	22.60	37.49	32.27	56.00	46.00	-18.51	-13.73

Remarks:

1. Q.P. and AV. are abbreviations of quasi-peak and average individually.
2. The emission levels of other frequencies were very low against the limit.
3. Margin value = Emission level - Limit value
4. Correction factor = Insertion loss + Cable loss
5. Emission Level = Correction Factor + Reading Value.

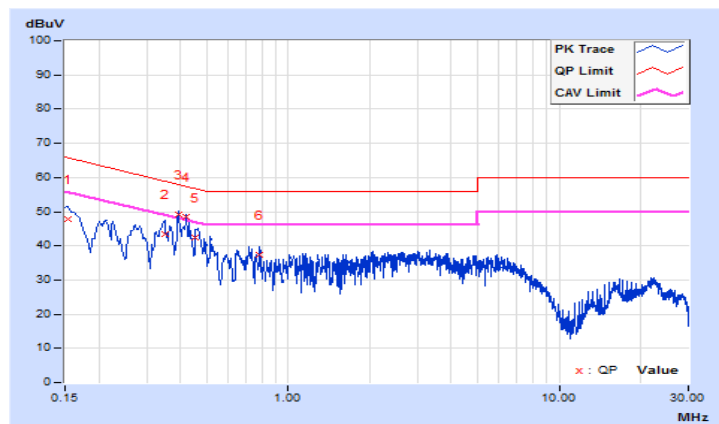

Phase	Neutral (N)	Detector Function	Quasi-Peak (QP) / Average (AV)
-------	-------------	-------------------	--------------------------------

No	Freq. [MHz]	Corr. Factor (dB)	Reading Value [dB (uV)]		Emission Level [dB (uV)]		Limit [dB (uV)]		Margin (dB)	
			Q.P.	AV.	Q.P.	AV.	Q.P.	AV.	Q.P.	AV.
			1	0.16096	9.66	38.58	30.80	48.24	40.46	65.41
2	0.19692	9.66	36.50	27.33	46.16	36.99	63.74	53.74	-17.58	-16.75
3	0.39116	9.65	39.20	36.79	48.85	46.44	58.04	48.04	-9.19	-1.60
4	0.41197	9.65	40.84	36.45	50.49	46.10	57.61	47.61	-7.12	-1.51
5	0.50581	9.65	26.70	18.45	36.35	28.10	56.00	46.00	-19.65	-17.90
6	4.02090	9.72	26.95	18.00	36.67	27.72	56.00	46.00	-19.33	-18.28

Remarks:

1. Q.P. and AV. are abbreviations of quasi-peak and average individually.
2. The emission levels of other frequencies were very low against the limit.
3. Margin value = Emission level - Limit value
4. Correction factor = Insertion loss + Cable loss
5. Emission Level = Correction Factor + Reading Value.

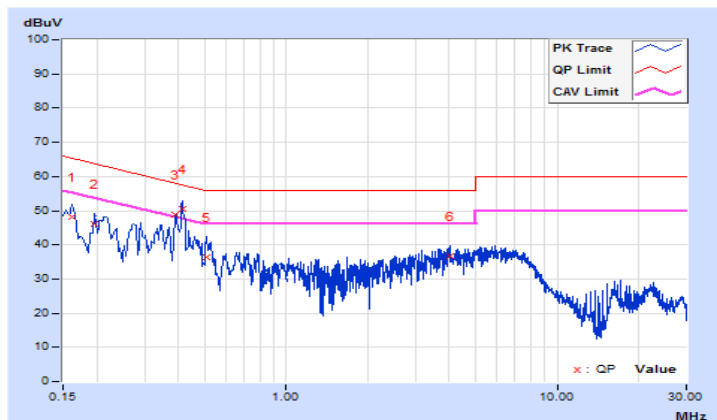

4.3 Transmit Power Measurement

4.3.1 Limits of Transmit Power Measurement

Operation Band	EUT Category		Limit
U-NII-1	√	Outdoor Access Point	1 Watt (30 dBm) (Max. e.i.r.p ≤ 125mW(21 dBm) at any elevation angle above 30 degrees as measured from the horizon)
		Fixed point-to-point Access Point	1 Watt (30 dBm)
	√	Indoor Access Point	1 Watt (30 dBm)
		Mobile and Portable client device	250mW (24 dBm)
U-NII-2A			250mW (24 dBm) or 11 dBm+10 log B*
U-NII-2C			250mW (24 dBm) or 11 dBm+10 log B*
U-NII-3	√		1 Watt (30 dBm)

*B is the 26 dB emission bandwidth in megahertz

Per KDB 662911 Method of conducted output power measurement on IEEE 802.11 devices,

Array Gain = 0 dB (i.e., no array gain) for $N_{ANT} \leq 4$;

Array Gain = 0 dB (i.e., no array gain) for channel widths ≥ 40 MHz for any N_{ANT} ;

Array Gain = $5 \log(N_{ANT}/N_{SS})$ dB or 3 dB, whichever is less for 20-MHz channel widths with $N_{ANT} \geq 5$.

For power measurements on all other devices: Array Gain = $10 \log(N_{ANT}/N_{SS})$ dB.

4.3.2 Test Setup

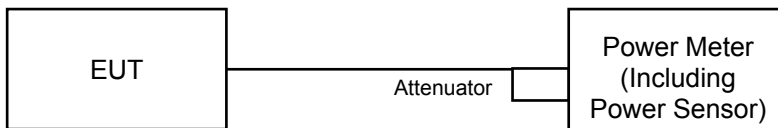

4.3.3 Test Instruments

Refer to section 4.1.2 to get information of above instrument.

4.3.4 Test Procedure

Method PM is used to perform output power measurement, trigger and gating function of wide band power meter is enabled to measure max output power of TX on burst and set the detector to average. Duty factor is not added to measured value.

4.3.5 Deviation from Test Standard

No deviation.

4.3.6 EUT Operating Conditions

The software provided by client to enable the EUT under transmission condition continuously at lowest, middle and highest channel frequencies individually.

4.3.7 Test Result

For U-NII-1 band (Outdoor Access Point):

802.11a

Chan.	Freq. (MHz)	Conducted Power (dBm)		Total Power (mW)	Total Power (dBm)	Power Limit (dBm)	Ant. Gain (dBi)	EIRP (dBm)	EIRP limit (dBm)	Pass / Fail
		Chain 0	Chain 1							
36	5180	16.48	16.77	91.997	19.64	28.60	0.89	20.53	21.00	Pass
40	5200	16.42	16.85	92.270	19.65	28.60	0.89	20.54	21.00	Pass
48	5240	16.44	16.93	93.372	19.70	28.60	0.89	20.59	21.00	Pass

Note:

1. Antenna gain = 7.4dBi > 6dBi, so the power limit shall be reduced to $30 - (7.4 - 6) = 28.60$ dBm.
2. Antenna gain = 0.89dBi (above 30 degrees from the horizon).
3. EIRP = conducted power + (0.89dBi) + array gain = (0 dB (i.e., no array gain) for $N_{ANT} \leq 4$).

802.11n (HT20)

Chan.	Freq. (MHz)	Conducted Power (dBm)		Total Power (mW)	Total Power (dBm)	Power Limit (dBm)	Ant. Gain (dBi)	EIRP (dBm)	EIRP limit (dBm)	Pass / Fail
		Chain 0	Chain 1							
36	5180	16.42	16.92	93.057	19.69	28.60	0.89	20.58	21.00	Pass
40	5200	16.41	17.01	93.986	19.73	28.60	0.89	20.62	21.00	Pass
48	5240	16.49	16.82	92.650	19.67	28.60	0.89	20.56	21.00	Pass

Note:

1. Antenna gain = 7.4dBi > 6dBi, so the power limit shall be reduced to $30 - (7.4 - 6) = 28.60$ dBm.
2. Antenna gain = 0.89dBi (above 30 degrees from the horizon).
3. EIRP = conducted power + (0.89dBi) + array gain = (0 dB (i.e., no array gain) for $N_{ANT} \leq 4$).

802.11n (HT40)

Chan.	Freq. (MHz)	Conducted Power (dBm)		Total Power (mW)	Total Power (dBm)	Power Limit (dBm)	Ant. Gain (dBi)	EIRP (dBm)	EIRP limit (dBm)	Pass / Fail
		Chain 0	Chain 1							
38	5190	16.82	17.23	100.929	20.04	28.60	0.89	20.93	21.00	Pass
46	5230	16.38	16.79	91.204	19.60	28.60	0.89	20.49	21.00	Pass

Note:

1. Antenna gain = 7.4dBi > 6dBi, so the power limit shall be reduced to $30 - (7.4 - 6) = 28.60$ dBm.
2. Antenna gain = 0.89dBi (above 30 degrees from the horizon).
3. EIRP = conducted power + (0.89dBi) + array gain = (0 dB (i.e., no array gain) for $N_{ANT} \leq 4$).

802.11ac (VHT80)

Chan.	Freq. (MHz)	Conducted Power (dBm)		Total Power (mW)	Total Power (dBm)	Power Limit (dBm)	Ant. Gain (dBi)	EIRP (dBm)	EIRP limit (dBm)	Pass / Fail
		Chain 0	Chain 1							
42	5210	16.81	17.26	101.184	20.05	28.60	0.89	20.94	21.00	Pass

Note:

1. Antenna gain = 7.4dBi > 6dBi, so the power limit shall be reduced to $30 - (7.4 - 6) = 28.60$ dBm.
2. Antenna gain = 0.89dBi (above 30 degrees from the horizon).
3. EIRP = conducted power + (0.89dBi) + array gain = (0 dB (i.e., no array gain) for $N_{ANT} \leq 4$).

For U-NII-1 band (Indoor Access Point):

802.11a

Chan.	Freq. (MHz)	Maximum Conducted Power (dBm)		Total Power (mW)	Total Power (dBm)	Power Limit (dBm)	Pass / Fail
		Chain 0	Chain 1				
36	5180	16.48	16.77	91.997	19.64	28.60	Pass
40	5200	16.42	16.85	92.270	19.65	28.60	Pass
48	5240	16.44	16.93	93.372	19.70	28.60	Pass

Note: Antenna gain = 7.4dBi > 6dBi, so the power limit shall be reduced to $30-(7.4-6) = 28.60$ dBm.

802.11n (HT20)

Chan.	Freq. (MHz)	Maximum Conducted Power (dBm)		Total Power (mW)	Total Power (dBm)	Power Limit (dBm)	Pass / Fail
		Chain 0	Chain 1				
36	5180	16.42	16.92	93.057	19.69	28.60	Pass
40	5200	16.41	17.01	93.986	19.73	28.60	Pass
48	5240	16.49	16.82	92.650	19.67	28.60	Pass

Note: Antenna gain = 7.4dBi > 6dBi, so the power limit shall be reduced to $30-(7.4-6) = 28.60$ dBm.

802.11n (HT40)

Chan.	Freq. (MHz)	Maximum Conducted Power (dBm)		Total Power (mW)	Total Power (dBm)	Power Limit (dBm)	Pass / Fail
		Chain 0	Chain 1				
38	5190	16.82	17.23	100.929	20.04	28.60	Pass
46	5230	16.38	16.79	91.204	19.60	28.60	Pass

Note: Antenna gain = 7.4dBi > 6dBi, so the power limit shall be reduced to $30-(7.4-6) = 28.60$ dBm.

802.11ac (VHT80)

Chan.	Freq. (MHz)	Maximum Conducted Power (dBm)		Total Power (mW)	Total Power (dBm)	Power Limit (dBm)	Pass / Fail
		Chain 0	Chain 1				
42	5210	16.81	17.26	101.184	20.05	28.60	Pass

Note: Antenna gain = 7.4dBi > 6dBi, so the power limit shall be reduced to $30-(7.4-6) = 28.60$ dBm.

For U-NII-3 band:

802.11a

Chan.	Freq. (MHz)	Maximum Conducted Power (dBm)		Total Power (mW)	Total Power (dBm)	Power Limit (dBm)	Pass / Fail
		Chain 0	Chain 1				
149	5745	17.07	18.01	114.174	20.58	28.60	Pass
157	5785	17.30	18.47	124.010	20.93	28.60	Pass
165	5825	17.41	18.47	125.388	20.98	28.60	Pass

Note: Antenna gain = 7.4dBi > 6dBi, so the power limit shall be reduced to $30-(7.4-6) = 28.60$ dBm.

802.11n (HT20)

Chan.	Freq. (MHz)	Maximum Conducted Power (dBm)		Total Power (mW)	Total Power (dBm)	Power Limit (dBm)	Pass / Fail
		Chain 0	Chain 1				
149	5745	16.84	17.61	105.983	20.25	28.60	Pass
157	5785	17.03	17.92	112.410	20.51	28.60	Pass
165	5825	17.17	18.09	116.536	20.66	28.60	Pass

Note: Antenna gain = 7.4dBi > 6dBi, so the power limit shall be reduced to $30-(7.4-6) = 28.60$ dBm.

802.11n (HT40)

Chan.	Freq. (MHz)	Maximum Conducted Power (dBm)		Total Power (mW)	Total Power (dBm)	Power Limit (dBm)	Pass / Fail
		Chain 0	Chain 1				
151	5755	19.35	20.09	188.193	22.75	28.60	Pass
159	5795	19.39	20.32	194.543	22.89	28.60	Pass

Note: Antenna gain = 7.4dBi > 6dBi, so the power limit shall be reduced to $30-(7.4-6) = 28.60$ dBm.

802.11ac (VHT80)

Chan.	Freq. (MHz)	Maximum Conducted Power (dBm)		Total Power (mW)	Total Power (dBm)	Power Limit (dBm)	Pass / Fail
		Chain 0	Chain 1				
155	5775	21.28	22.10	296.457	24.72	28.60	Pass

Note: Antenna gain = 7.4dBi > 6dBi, so the power limit shall be reduced to $30-(7.4-6) = 28.60$ dBm.

4.4 Occupied Bandwidth Measurement

4.4.1 Test Setup

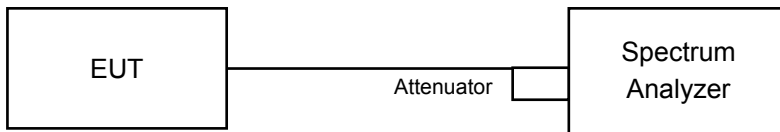

4.4.2 Test Instruments

Refer to section 4.1.2 to get information of above instrument.

4.4.3 Test Procedure

The transmitter output was connected to the spectrum analyzer through an attenuator. The bandwidth of the fundamental frequency was measured by spectrum analyzer with resolution bandwidth in the range of 1% to 5% of the anticipated emission bandwidth, and a video bandwidth at least 3x the resolution bandwidth and set the detector to sampling. The width of a frequency band such that, below the lower and above the upper frequency limits, the mean powers emitted are each equal to a specified percentage 0.5 %of the total mean power of a given emission.

4.4.4 Test Result

802.11a

Chan.	Freq. (MHz)	Occupied Bandwidth (MHz)	
		Chain 0	Chain 1
36	5180	16.56	16.56
40	5200	16.44	16.44
48	5240	16.44	16.56
149	5745	16.44	16.44
157	5785	16.44	16.44
165	5825	16.44	16.44

802.11n (HT20)

Chan.	Freq. (MHz)	Occupied Bandwidth (MHz)	
		Chain 0	Chain 1
36	5180	17.64	17.76
40	5200	17.64	17.64
48	5240	17.64	17.64
149	5745	17.64	17.64
157	5785	17.64	17.64
165	5825	17.64	17.64

802.11n (HT40)

Chan.	Freq. (MHz)	Occupied Bandwidth (MHz)	
		Chain 0	Chain 1
38	5190	36.24	36.24
46	5230	36.12	36.24
151	5755	36.12	36.12
159	5795	36.36	36.12

802.11ac (VHT80)

Chan.	Freq. (MHz)	Occupied Bandwidth (MHz)	
		Chain 0	Chain 1
42	5210	75.84	75.84
155	5775	76.08	75.84

Spectrum Plot of Worst Value

802.11a

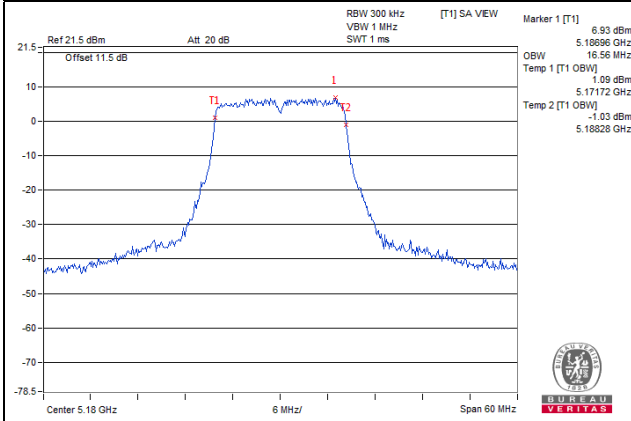

802.11n (HT20)

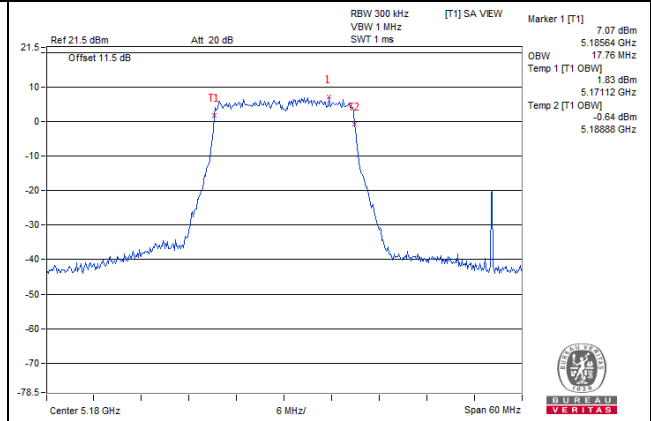

802.11n (HT40)

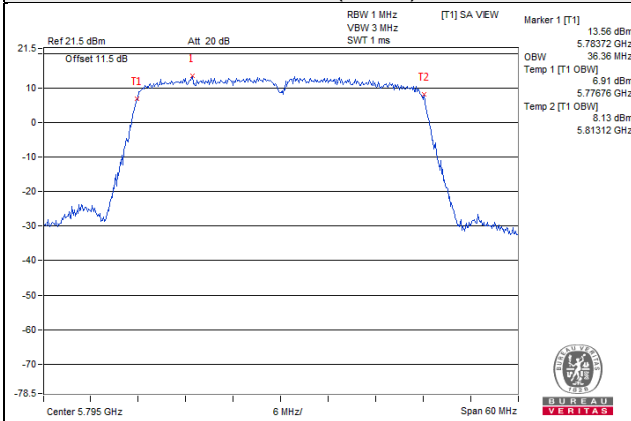

802.11ac (VHT80)

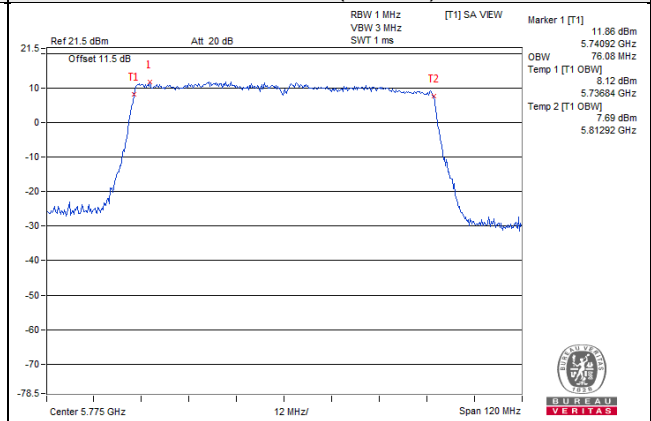

4.5 Peak Power Spectral Density Measurement

4.5.1 Limits of Peak Power Spectral Density Measurement

Operation Band	EUT Category		Limit
U-NII-1	√	Outdoor Access Point	17dBm/ MHz
		Fixed point-to-point Access Point	
	√	Indoor Access Point	
		Mobile and Portable client device	11dBm/ MHz
U-NII-2A			11dBm/ MHz
U-NII-2C			11dBm/ MHz
U-NII-3	√		30dBm/ 500kHz

4.5.2 Test Setup

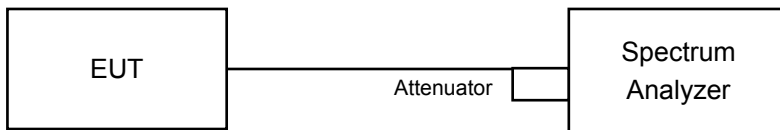

4.5.3 Test Instruments

Refer to section 4.1.2 to get information of above instrument.

4.5.4 Test Procedures

For U-NII-1 band:

Duty cycle of test signal is > 98%

Using method SA-1

- Set span to encompass the entire emission bandwidth (EBW) of the signal.
- Set RBW = 1 MHz, Set VBW ≥ 3 MHz, Detector = RMS
- Sweep time = auto, trigger set to “free run”.
- Trace average at least 100 traces in power averaging mode.
- Record the max value

Duty cycle of test signal is < 98%

Using method SA-2

- Set span to encompass the entire emission bandwidth (EBW) of the signal.
- Set RBW = 1MHz, Set VBW ≥ 3 MHz, Detector = RMS
- Set Channel power measure = 1MHz
- Sweep time = auto, trigger set to “free run”.
- Trace average at least 100 traces in power averaging mode.
- Record the max value and add 10 log (1/duty cycle)

For U-NII-3 band:

Duty cycle of test signal is > 98%

- a. Set span to encompass the entire emission bandwidth (EBW) of the signal.
- b. Set RBW = 300 kHz, Set VBW \geq 1 MHz, Detector = RMS
- c. Use the peak marker function to determine the maximum power level in any 300 kHz band segment within the fundamental EBW.
- d. Scale the observed power level to an equivalent value in 500 kHz by adjusting (reducing) the measured power by a bandwidth correction factor (BWCF) where $BWCF = 10\log(500 \text{ kHz}/300\text{kHz})$
- e. Sweep time = auto, trigger set to "free run".
- f. Trace average at least 100 traces in power averaging mode.
- g. Record the max value

Duty cycle of test signal is < 98%

- a. Set span to encompass the entire emission bandwidth (EBW) of the signal.
- b. Set RBW = 300 kHz, Set VBW \geq 1 MHz, Detector = RMS
- c. Use the peak marker function to determine the maximum power level in any 300 kHz band segment within the fundamental EBW.
- d. Scale the observed power level to an equivalent value in 500 kHz by adjusting (reducing) the measured power by a bandwidth correction factor (BWCF) where $BWCF = 10\log(500 \text{ kHz} / 300 \text{ kHz})$
- e. Sweep time = auto, trigger set to "free run".
- f. Trace average at least 100 traces in power averaging mode.
- g. Record the max value and add $10 \log (1/\text{duty cycle})$

4.5.5 Deviation from Test Standard

No deviation.

4.5.6 EUT Operating Conditions

Same as 4.3.6.

4.5.7 Test Results

For U-NII-1 band:

802.11a

Chan.	Freq. (MHz)	PSD w/o Duty Factor (dBm/MHz)		Duty Factor (dB)	Total PSD with Duty Factor (dBm/MHz)	Max. Limit (dBm/MHz)	Pass / Fail
		Chain 0	Chain 1				
36	5180	2.51	3.14	0.16	6.01	13.35	Pass
40	5200	2.56	3.28	0.16	6.11	13.35	Pass
48	5240	2.60	3.25	0.16	6.11	13.35	Pass

Note:

- Method E) 2) a) of power density measurement of KDB 662911 is using for calculating total power density. Total power density is summing entire spectra across corresponding frequency bins on the various outputs by computer.
- Directional gain = $10 \log[(10^{G1/20} + 10^{G2/20} + \dots + 10^{GN/20})^2/2] = 9.65\text{dBi} > 6\text{dBi}$ so the power density limit shall be reduced to $17-(9.65-6) = 13.35\text{dBi}$.
- Refer to section 3.3 for duty cycle spectrum plot.

802.11n (HT20)

Chan.	Freq. (MHz)	PSD (dBm/MHz)		Total PSD (dBm/MHz)	Max. Limit (dBm/MHz)	Pass / Fail
		Chain 0	Chain 1			
36	5180	1.98	2.53	5.27	13.35	Pass
40	5200	2.02	2.75	5.41	13.35	Pass
48	5240	1.91	2.67	5.32	13.35	Pass

Note:

- Method E) 2) a) of power density measurement of KDB 662911 is using for calculating total power density. Total power density is summing entire spectra across corresponding frequency bins on the various outputs by computer.
- Directional gain = $10 \log[(10^{G1/20} + 10^{G2/20} + \dots + 10^{GN/20})^2/2] = 9.65\text{dBi} > 6\text{dBi}$ so the power density limit shall be reduced to $17-(9.65-6) = 13.35\text{dBi}$.
- Refer to section 3.3 for duty cycle spectrum plot.

802.11n (HT40)

Chan.	Freq. (MHz)	PSD w/o Duty Factor (dBm/MHz)		Duty Factor (dB)	Total PSD with Duty Factor (dBm/MHz)	Max. Limit (dBm/MHz)	Pass / Fail
		Chain 0	Chain 1				
38	5190	0.00	0.83	0.16	3.61	13.35	Pass
46	5230	-0.56	0.35	0.16	3.09	13.35	Pass

Note:

- Method E) 2) a) of power density measurement of KDB 662911 is using for calculating total power density. Total power density is summing entire spectra across corresponding frequency bins on the various outputs by computer.
- Directional gain = $10 \log[(10^{G1/20} + 10^{G2/20} + \dots + 10^{GN/20})^2/2] = 9.65\text{dBi} > 6\text{dBi}$ so the power density limit shall be reduced to $17-(9.65-6) = 13.35\text{dBi}$.
- Refer to section 3.3 for duty cycle spectrum plot.

802.11ac (VHT80)

Chan.	Freq. (MHz)	PSD w/o Duty Factor (dBm/MHz)		Duty Factor (dB)	Total PSD with Duty Factor (dBm/MHz)	Max. Limit (dBm/MHz)	Pass / Fail
		Chain 0	Chain 1				
42	5210	-3.68	-3.03	0.28	-0.05	13.35	Pass

Note:

- Method E) 2) a) of power density measurement of KDB 662911 is using for calculating total power density. Total power density is summing entire spectra across corresponding frequency bins on the various outputs by computer.
- Directional gain = $10 \log[(10^{G1/20} + 10^{G2/20} + \dots + 10^{GN/20})^2/2] = 9.65\text{dBi} > 6\text{dBi}$ so the power density limit shall be reduced to $17-(9.65-6) = 13.35\text{dBm}$.
- Refer to section 3.3 for duty cycle spectrum plot.

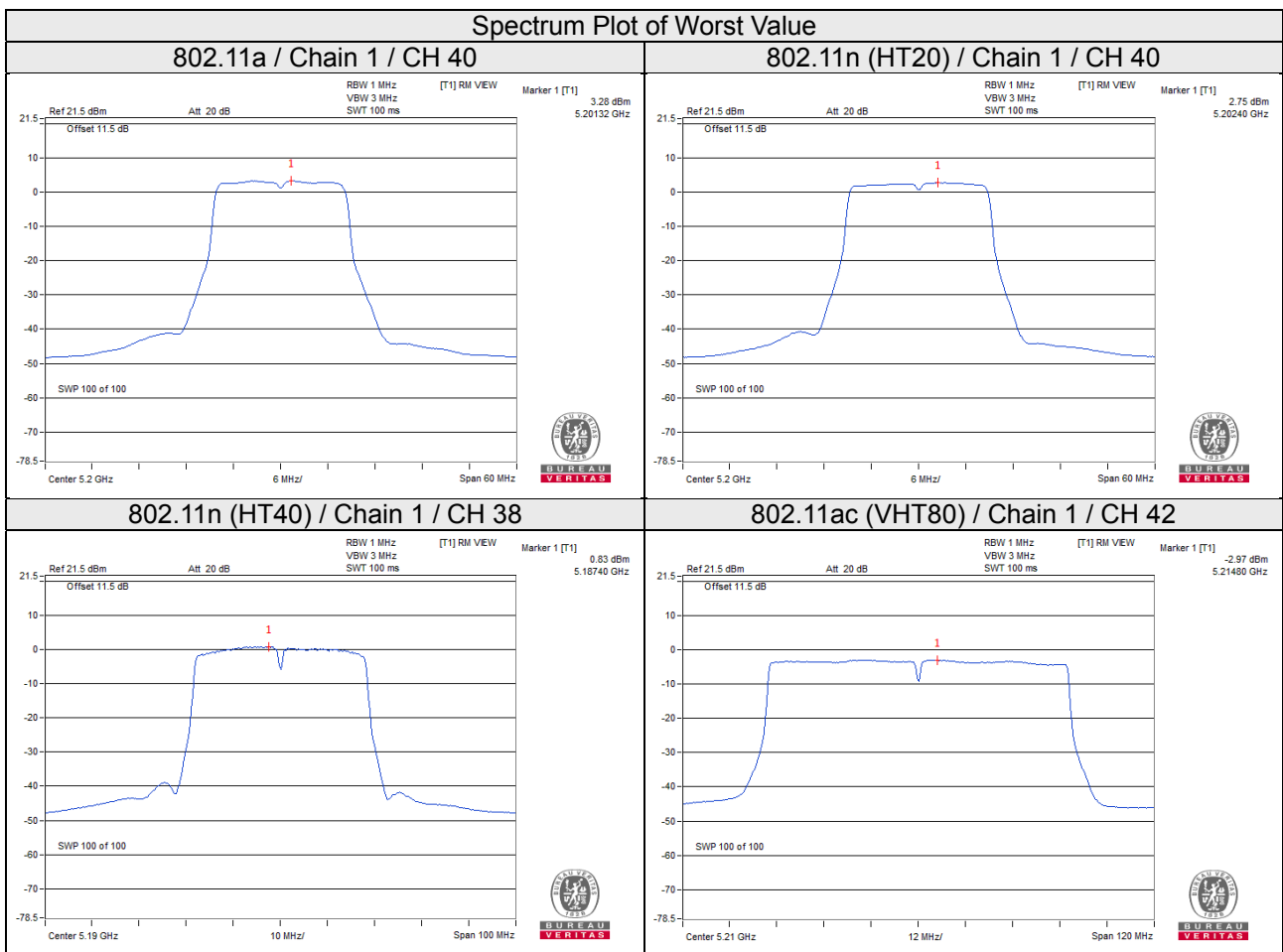

For U-NII-3 band:

802.11a

TX chain	Chan.	Freq. (MHz)	PSD w/o Duty Factor		10 log (N=2) dB	Duty Factor (dB)	Total PSD with Duty Factor (dBm/500kHz)	Limit (dBm/500 kHz)	Pass / Fail
			(dBm/300kHz)	(dBm/500kHz)					
0	149	5745	-4.48	-2.26	3.01	0.16	0.91	26.35	Pass
	157	5785	-4.40	-2.18	3.01	0.16	0.99	26.35	Pass
	165	5825	-4.33	-2.11	3.01	0.16	1.06	26.35	Pass
1	149	5745	-4.01	-1.79	3.01	0.16	1.38	26.35	Pass
	157	5785	-3.61	-1.39	3.01	0.16	1.78	26.35	Pass
	165	5825	-3.63	-1.41	3.01	0.16	1.76	26.35	Pass

Note:

- Method E) 2) c) of power density measurement of KDB 662911 is using for calculating total power density, Measure and add 10 log (N_{ANT}) dB.
- Directional gain = $10 \log[(10^{G1/20} + 10^{G2/20} + \dots + 10^{GN/20})^2/2] = 9.65\text{dBi} > 6\text{dBi}$ so the power density limit shall be reduced to $30-(9.65-6) = 26.35\text{dBi}$.
- Refer to section 3.3 for duty cycle spectrum plot.

802.11n (HT20)

TX chain	Chan.	Freq. (MHz)	PSD (dBm/300 kHz)	PSD (dBm/500 kHz)	10 log (N=2) dB	Total PSD (dBm/500 kHz)	Limit (dBm/500 kHz)	Pass / Fail
0	149	5745	-4.97	-2.75	3.01	0.26	26.35	Pass
	157	5785	-5.18	-2.96	3.01	0.05	26.35	Pass
	165	5825	-4.94	-2.72	3.01	0.29	26.35	Pass
1	149	5745	-4.37	-2.15	3.01	0.86	26.35	Pass
	157	5785	-4.05	-1.83	3.01	1.18	26.35	Pass
	165	5825	-3.92	-1.70	3.01	1.31	26.35	Pass

Note:

- Method E) 2) c) of power density measurement of KDB 662911 is using for calculating total power density, Measure and add 10 log (N_{ANT}) dB.
- Directional gain = $10 \log[(10^{G1/20} + 10^{G2/20} + \dots + 10^{GN/20})^2/2] = 9.65\text{dBi} > 6\text{dBi}$ so the power density limit shall be reduced to $30-(9.65-6) = 26.35\text{dBi}$.

802.11n (HT40)

TX chain	Chan.	Freq. (MHz)	PSD W/O Duty Factor		10 log (N=2) dB	Duty Factor (dB)	Total PSD With Duty Factor (dBm/500kHz)	Limit (dBm/500kHz)	Pass / Fail
			(dBm/300kHz)	(dBm/500kHz)					
0	151	5755	-5.56	-3.34	3.01	0.16	-0.17	26.35	Pass
	159	5795	-5.68	-3.46	3.01	0.16	-0.29	26.35	Pass
1	151	5755	-5.19	-2.97	3.01	0.16	0.20	26.35	Pass
	159	5795	-4.86	-2.64	3.01	0.16	0.53	26.35	Pass

Note:

- Method E) 2) c) of power density measurement of KDB 662911 is using for calculating total power density, Measure and add 10 log (N_{ANT}) dB.
- Directional gain = $10 \log[(10^{G1/20} + 10^{G2/20} + \dots + 10^{GN/20})^2/2] = 9.65\text{dBi} > 6\text{dBi}$ so the power density limit shall be reduced to $30 - (9.65 - 6) = 26.35\text{dBi}$.
- Refer to section 3.3 for duty cycle spectrum plot.

802.11ac (VHT80)

TX chain	Chan.	Freq. (MHz)	PSD W/O Duty Factor		10 log (N=2) dB	Duty Factor (dB)	Total PSD With Duty Factor (dBm/500kHz)	Limit (dBm/500kHz)	Pass / Fail
			(dBm/300kHz)	(dBm/500kHz)					
0	155	5775	-7.21	-4.99	3.01	0.28	-1.70	26.35	Pass
1	155	5775	-6.55	-4.33	3.01	0.28	-1.04	26.35	Pass

Note:

- Method E) 2) c) of power density measurement of KDB 662911 is using for calculating total power density, Measure and add 10 log (N_{ANT}) dB.
- Directional gain = $10 \log[(10^{G1/20} + 10^{G2/20} + \dots + 10^{GN/20})^2/2] = 9.65\text{dBi} > 6\text{dBi}$ so the power density limit shall be reduced to $30 - (9.65 - 6) = 26.35\text{dBi}$.
- Refer to section 3.3 for duty cycle spectrum plot.

Spectrum Plot of Worst Value

802.11a

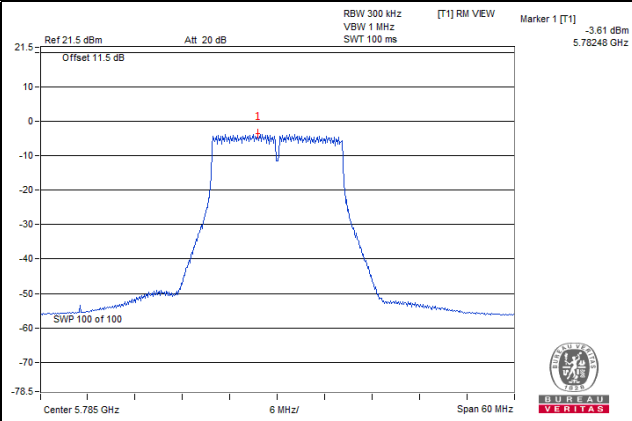

802.11n (HT20)

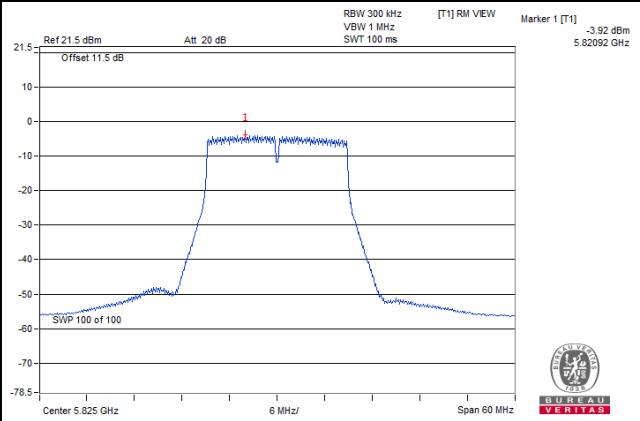

802.11n (HT40)

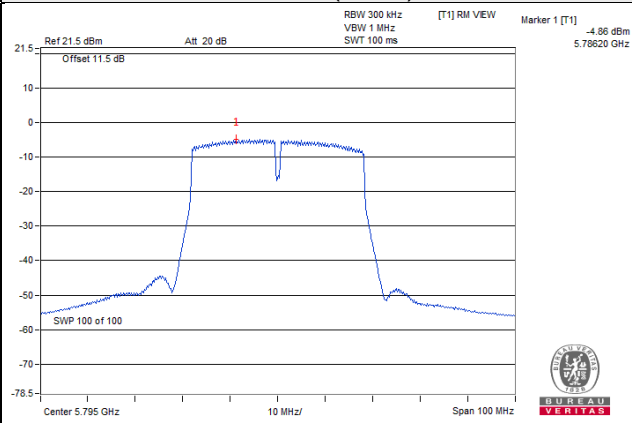

802.11ac (VHT80)

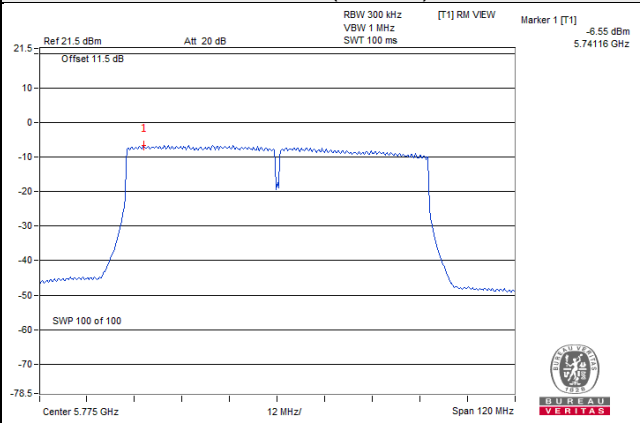

4.6 Frequency Stability

4.6.1 Limits of Frequency Stability Measurement

The frequency of the carrier signal shall be maintained within band of operation

4.6.2 Test Setup

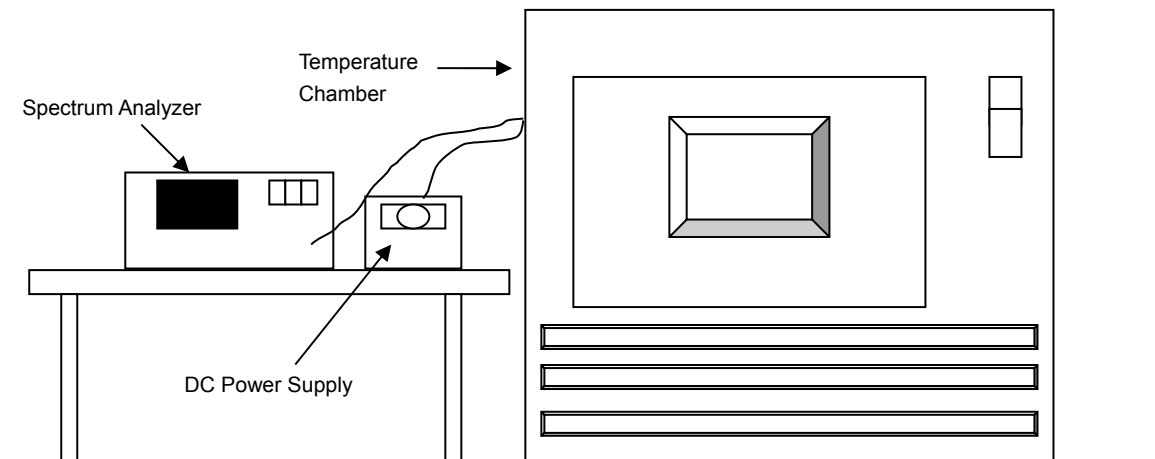

4.6.3 Test Instruments

Description & Manufacturer	Model No.	Serial No.	Cal. Date	Cal. Due
Spectrum Analyzer ROHDE & SCHWARZ	FSP40	100039	Jun. 11, 2018	Jun. 10, 2019
WIT Standard Temperature And Humidity Chamber	TH-4S-C	W981030	Jun. 04, 2018	Jun. 03, 2019
Digital Multimeter Fluke	87-III	70360742	Jun. 29, 2018	Jun. 28, 2019
DC Power Supply Topward	6603D	700637	NA	NA

Note: 1. The calibration interval of the above test instruments is 12 months and the calibrations are traceable to NML/ROC and NIST/USA.

4.6.4 Test Procedure

- The EUT was placed inside the environmental test chamber and powered by nominal DC voltage.
- Turn the EUT on and couple its output to a spectrum analyzer.
- Turn the EUT off and set the chamber to the highest temperature specified.
- Allow sufficient time (approximately 30 min) for the temperature of the chamber to stabilize, turn the EUT on and measure the operating frequency after 2, 5, and 10 minutes.
- Repeat step (d) with the temperature chamber set to the next desired temperature until measurements down to the lowest specified temperature have been completed.
- The test chamber was allowed to stabilize at +20 degree C for a minimum of 30 minutes. The supply voltage was then adjusted on the EUT from 85% to 115% and the frequency record.

4.6.5 Deviation from Test Standard

No deviation.

4.6.6 EUT Operating Condition

Set the EUT transmit at un-modulation mode to test frequency stability.

4.6.7 Test Results

Frequency Stability Versus Temp.									
Operating Frequency: 5180MHz									
Temp. (°C)	Power Supply (Vdc)	0 Minute		2 Minute		5 Minute		10 Minute	
		Measured Frequency (MHz)	Result	Measured Frequency (MHz)	Result	Measured Frequency (MHz)	Result	Measured Frequency (MHz)	Result
60	53	5180.0028	Pass	5180.0034	Pass	5180.0015	Pass	5180.0061	Pass
50	53	5180.018	Pass	5180.0218	Pass	5180.0203	Pass	5180.0203	Pass
40	53	5179.9898	Pass	5179.987	Pass	5179.9871	Pass	5179.9867	Pass
30	53	5180.0203	Pass	5180.0212	Pass	5180.0241	Pass	5180.0217	Pass
20	53	5180.0212	Pass	5180.0215	Pass	5180.0233	Pass	5180.0237	Pass
10	53	5179.9883	Pass	5179.9866	Pass	5179.9881	Pass	5179.9887	Pass
0	53	5180.0116	Pass	5180.0113	Pass	5180.0114	Pass	5180.0098	Pass
-10	53	5180.0044	Pass	5180.0035	Pass	5180.0049	Pass	5180.007	Pass
-20	53	5180.007	Pass	5180.0028	Pass	5180.0076	Pass	5180.0045	Pass
-30	53	5180	Pass	5180.0021	Pass	5180.0018	Pass	5179.9993	Pass

Frequency Stability Versus Voltage									
Operating Frequency: 5180MHz									
Temp. (°C)	Power Supply (Vdc)	0 Minute		2 Minute		5 Minute		10 Minute	
		Measured Frequency (MHz)	Result	Measured Frequency (MHz)	Result	Measured Frequency (MHz)	Result	Measured Frequency (MHz)	Result
20	60.95	5180.0219	Pass	5180.0214	Pass	5180.0226	Pass	5180.023	Pass
	53	5180.0212	Pass	5180.0215	Pass	5180.0233	Pass	5180.0237	Pass
	45.05	5180.022	Pass	5180.0213	Pass	5180.0233	Pass	5180.0243	Pass

4.7 6dB Bandwidth Measurement

4.7.1 Limits of 6dB Bandwidth Measurement

The minimum of 6dB Bandwidth Measurement is 0.5MHz.

4.7.2 Test Setup

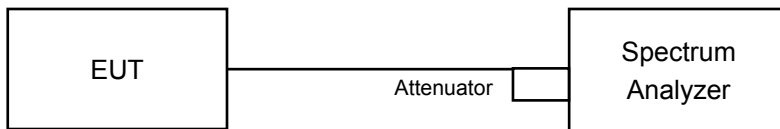

4.7.3 Test Instruments

Refer to section 4.1.2 to get information of above instrument.

4.7.4 Test Procedure

- Set resolution bandwidth (RBW) = 100kHz
- Set the video bandwidth (VBW) $\geq 3 \times$ RBW, Detector = Peak.
- Trace mode = max hold.
- Sweep = auto couple.
- Measure the maximum width of the emission that is constrained by the frequencies associated with the two amplitude points (upper and lower) that are attenuated by 6 dB relative to the maximum level measured in the fundamental emission

4.7.5 Deviation from Test Standard

No deviation.

4.7.6 EUT Operating Condition

The software provided by client to enable the EUT under transmission condition continuously at lowest, middle and highest channel frequencies individually.

4.7.7 Test Results

802.11a

Channel	Frequency (MHz)	6dB Bandwidth (MHz)		Minimum Limit (MHz)	Pass / Fail
		Chain 0	Chain 1		
149	5745	16.40	16.38	0.5	Pass
157	5785	16.36	16.39	0.5	Pass
165	5825	16.38	16.39	0.5	Pass

802.11n (HT20)

Channel	Frequency (MHz)	6dB Bandwidth (MHz)		Minimum Limit (MHz)	Pass / Fail
		Chain 0	Chain 1		
149	5745	16.84	17.22	0.5	Pass
157	5785	17.59	17.59	0.5	Pass
165	5825	17.32	17.57	0.5	Pass

802.11n (HT40)

Channel	Frequency (MHz)	6dB Bandwidth (MHz)		Minimum Limit (MHz)	Pass / Fail
		Chain 0	Chain 1		
151	5755	35.20	35.19	0.5	Pass
159	5795	35.17	35.15	0.5	Pass

802.11ac (VHT80)

Channel	Frequency (MHz)	6dB Bandwidth (MHz)		Minimum Limit (MHz)	Pass / Fail
		Chain 0	Chain 1		
155	5775	76.04	76.02	0.5	Pass

Spectrum Plot of Worst Value

802.11a

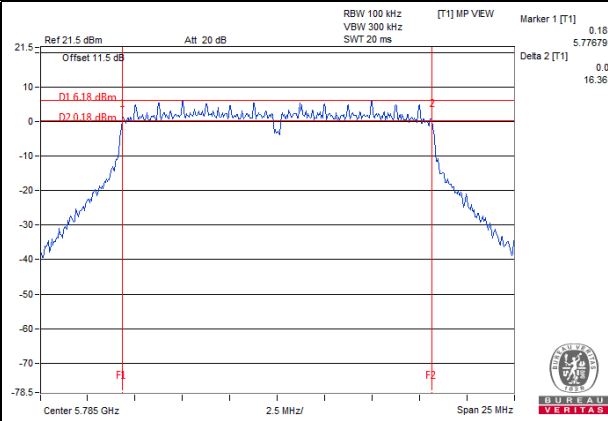

802.11n (HT20)

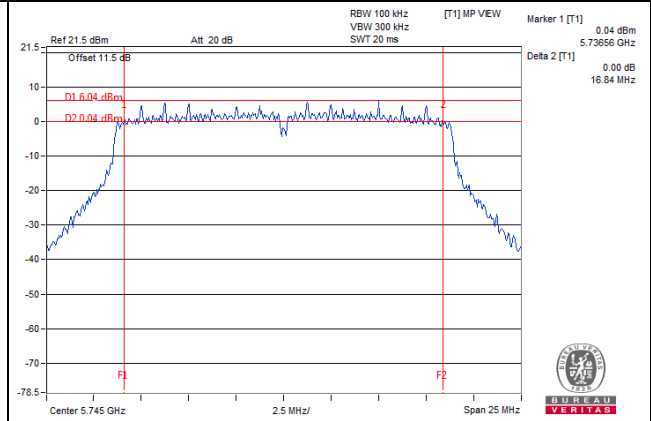

802.11n (HT40)

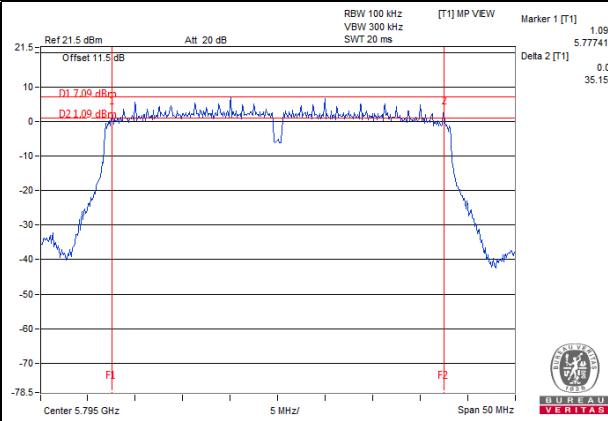

802.11ac (VHT80)

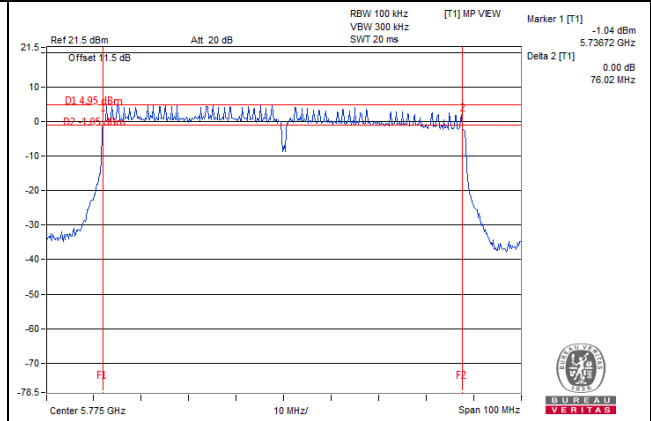

5 Pictures of Test Arrangements

Please refer to the attached file (Test Setup Photo).

Annex A- Radiated Out of Band Emission (OOBE) Measurement (For U-NII-3 band)

802.11a

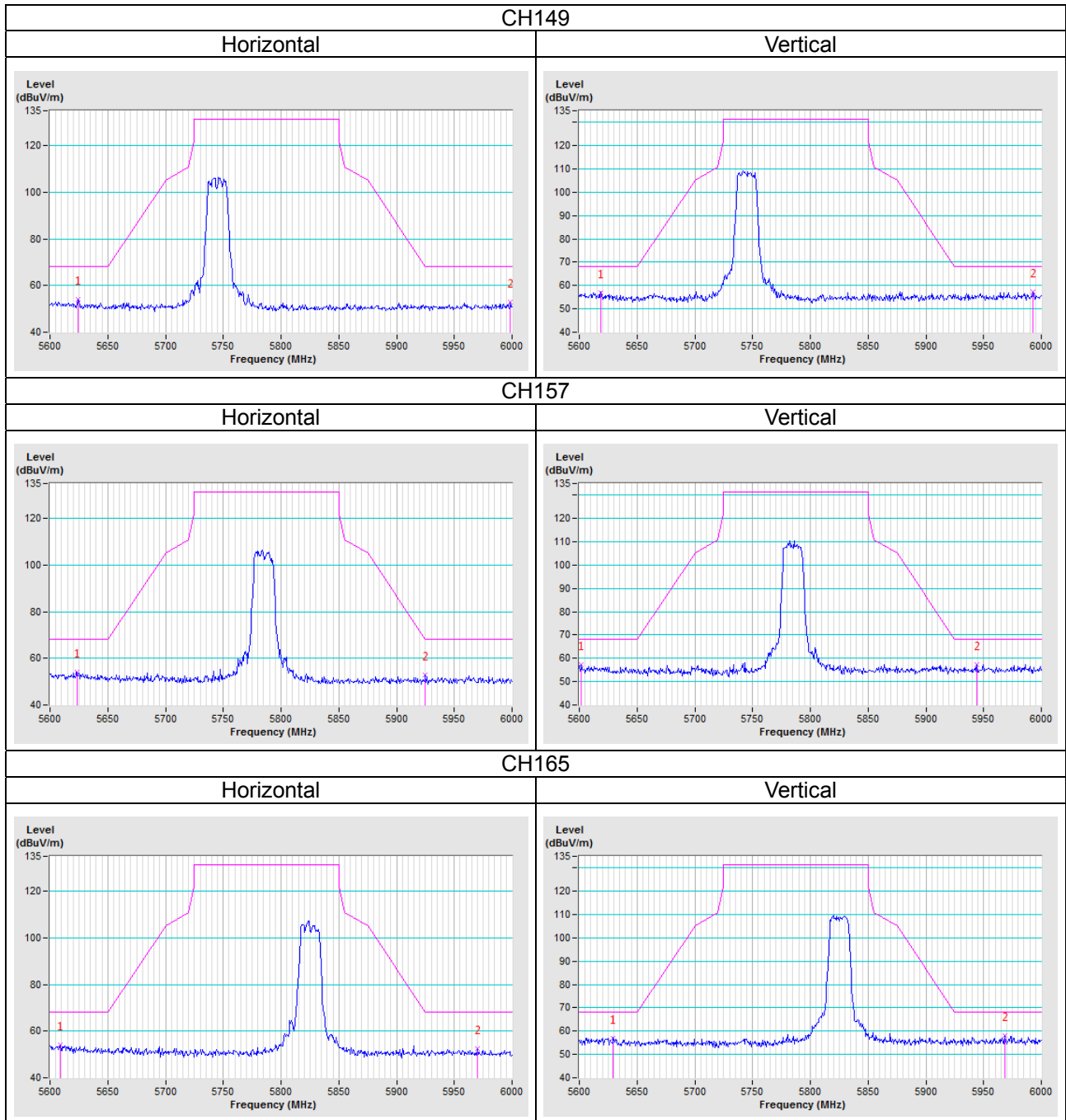

802.11n (HT20)

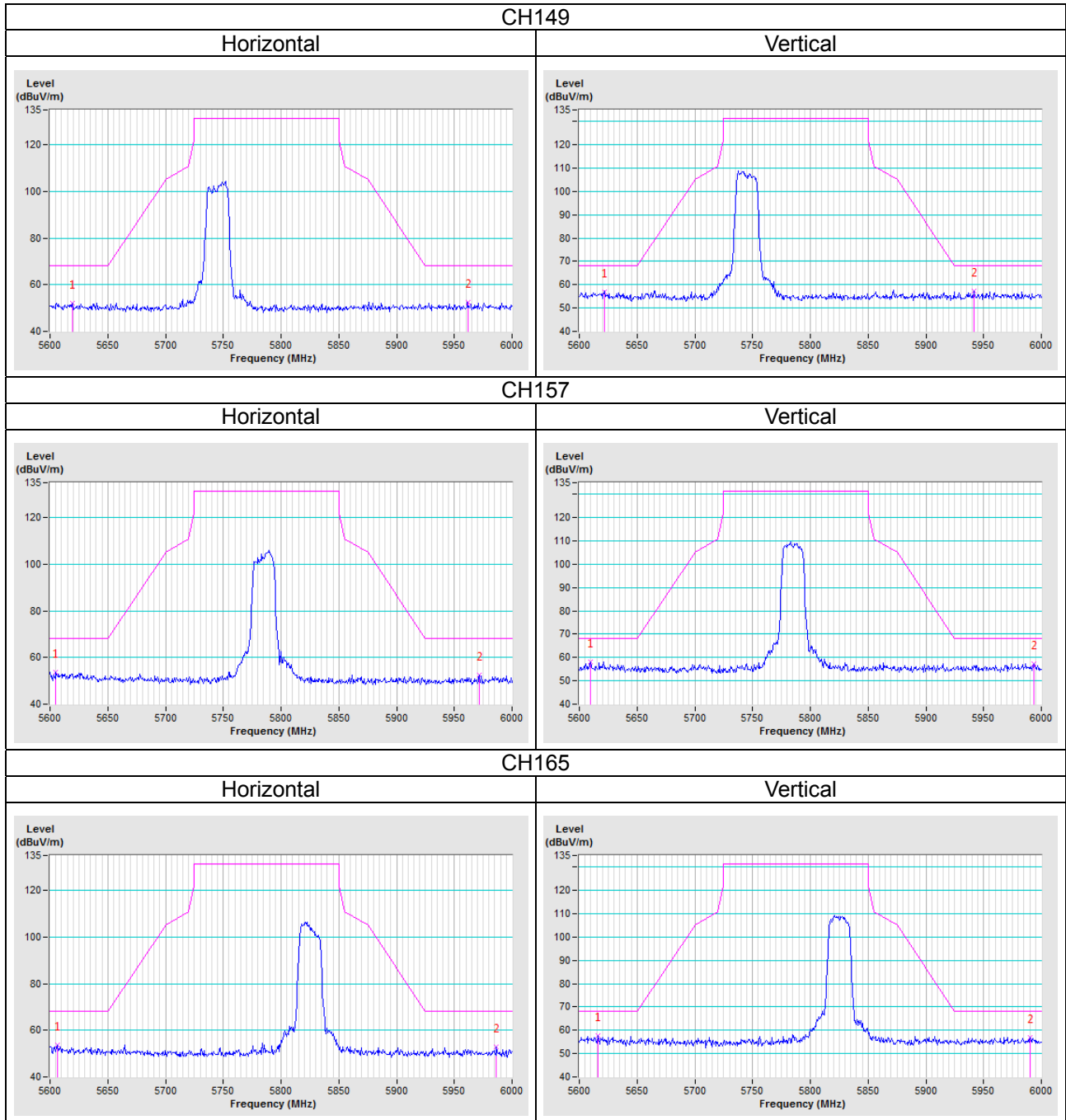

802.11n (HT40)

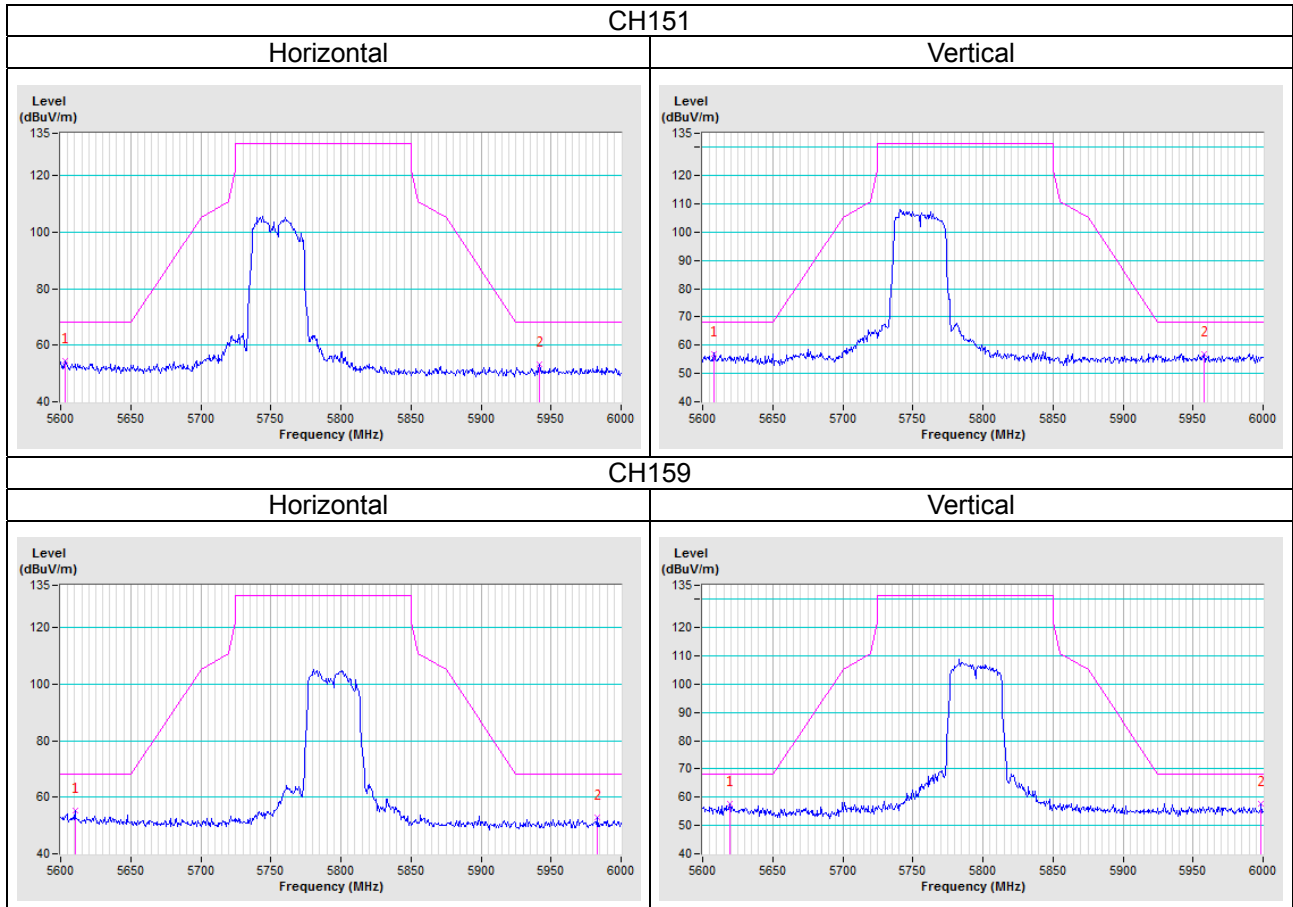

802.11ac (VHT80)

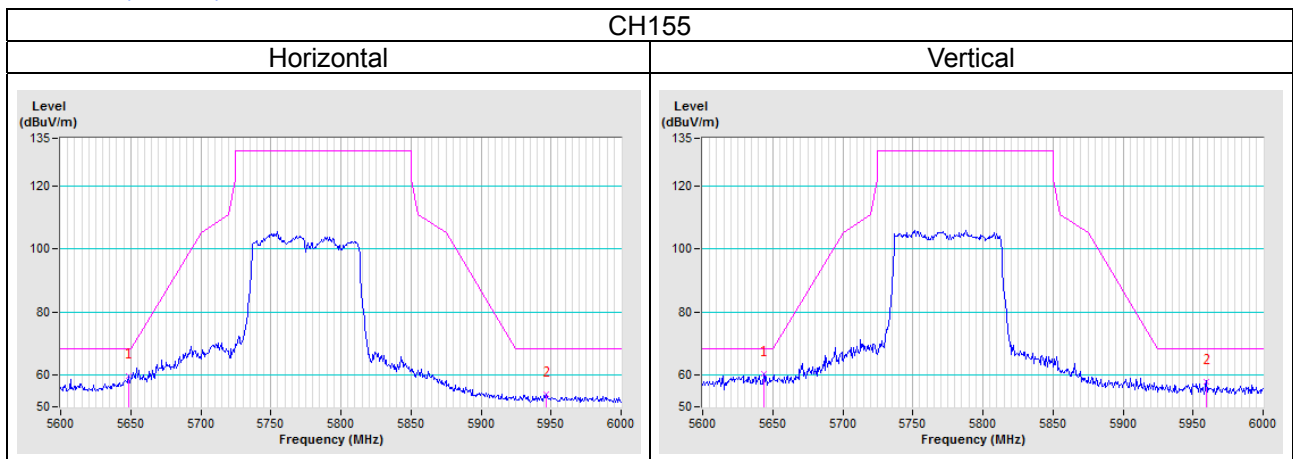

Appendix – Information of the Testing Laboratories

We, Bureau Veritas Consumer Products Services (H.K.) Ltd., Taoyuan Branch, were founded in 1988 to provide our best service in EMC, Radio, Telecom and Safety consultation. Our laboratories are FCC recognized accredited test firms and accredited and approved according to ISO/IEC 17025.

If you have any comments, please feel free to contact us at the following:

Lin Kou EMC/RF Lab

Tel: 886-2-26052180

Fax: 886-2-26051924

Hsin Chu EMC/RF/Telecom Lab

Tel: 886-3-6668565

Fax: 886-3-6668323

Hwa Ya EMC/RF/Safety

Tel: 886-3-3183232

Fax: 886-3-3270892

Email: service.adt@tw.bureauveritas.com

Web Site: www.bureauveritas-adt.com

The address and road map of all our labs can be found in our web site also.

--- END ---