

FCCRadio Test Report

FCC ID:KA2AP1665B1

This report concerns (check one): Original Grant Class I Change Class II Change

Project No. : 1608C193
Equipment : Wireless AC1200 Dual Band Access Point
Model Name : DAP-1665
Applicant : D-Link Corporation
Address : No.289, Sinhu 3rd Rd., Neihu District, Taipei City
114, Taiwan, R.O.C.

Date of Receipt : Aug. 18, 2016
Date of Test : Aug. 18, 2016 ~ Oct. 10, 2016
Issued Date : Oct. 11, 2016
Tested by : BTL Inc.

Testing Engineer : Shawn Xiao
(Shawn Xiao)

Technical Manager : David Mao
(David Mao)

Authorized Signatory : Steven Lu
(Steven Lu)

B T L I N C .

No.3, Jinshagang 1st Road, Shixia, Dalang Town, Dongguan,
Guangdong, China.

TEL: +86-769-8318-3000 FAX: +86-769-8319-6000

Declaration

BTL represents to the client that testing is done in accordance with standard procedures as applicable and that test instruments used has been calibrated with standards traceable to international standard(s) and/or national standard(s).

BTL's reports apply only to the specific samples tested under conditions. It is manufacture's responsibility to ensure that additional production units of this model are manufactured with the identical electrical and mechanical components. **BTL** shall have no liability for any declarations, inferences or generalizations drawn by the client or others from **BTL** issued reports.

BTL's report must not be used by the client to claim product certification, approval, or endorsement by NVLAP, NIST, or any agency of the Federal Government.

This report is the confidential property of the client. As a mutual protection to the clients, the public and **BTL-self**, extracts from the test report shall not be reproduced except in full with **BTL's** authorized written approval.

BTL's laboratory quality assurance procedures are in compliance with the **ISO Guide17025** requirements, and accredited by the conformity assessment authorities listed in this test report.

Limitation

For the use of the authority's logo is limited unless the Test Standard(s)/Scope(s)/Item(s) mentioned in this test report is (are) included in the conformity assessment authorities acceptance respective.

Table of Contents	Page
1 . CERTIFICATION	6
2 . SUMMARY OF TEST RESULTS	7
2.1 TEST FACILITY	8
2.2 MEASUREMENT UNCERTAINTY	8
3 . GENERAL INFORMATION	9
3.1 GENERAL DESCRIPTION OF EUT	9
3.2 DESCRIPTION OF TEST MODES	12
3.3 TABLE OF PARAMETERS OF TEST SOFTWARE SETTING	14
3.4 BLOCK DIAGRAM SHOWING THE CONFIGURATION OF SYSTEM TESTED	16
3.5 DESCRIPTION OF SUPPORT UNITS	16
4 . EMC EMISSION TEST	17
4.1 CONDUCTED EMISSION MEASUREMENT	17
4.1.1 POWER LINE CONDUCTED EMISSION	17
4.1.2 TEST PROCEDURE	17
4.1.3 DEVIATION FROM TEST STANDARD	17
4.1.4 TEST SETUP	18
4.1.5 EUT OPERATING CONDITIONS	18
4.1.6 EUT TEST CONDITIONS	18
4.1.7 TEST RESULTS	18
4.2 RADIATED EMISSION MEASUREMENT	19
4.2.1 RADIATED EMISSION LIMITS	19
4.2.2 TEST PROCEDURE	20
4.2.3 DEVIATION FROM TEST STANDARD	20
4.2.4 TEST SETUP	20
4.2.5 EUT OPERATING CONDITIONS	21
4.2.6 EUT TEST CONDITIONS	21
4.2.7 TEST RESULTS (9K TO 30MHz)	22
4.2.8 TEST RESULTS (BETWEEN 30 TO 1000 MHz)	22
4.2.9 TEST RESULTS (ABOVE 1000 MHz)	22
5 . 26dB SPECTRUM BANDWIDTH	23
5.1 APPLIED PROCEDURES / LIMIT	23
5.1.1 TEST PROCEDURE	23
5.1.2 DEVIATION FROM STANDARD	23
5.1.3 TEST SETUP	23
5.1.4 EUT OPERATION CONDITIONS	23
5.1.5 EUT TEST CONDITIONS	23
5.1.6 TEST RESULTS	23
6 . MAXIMUM CONDUCTED OUTPUT POWER	24

Table of Contents	Page
6.1 APPLIED PROCEDURES / LIMIT	24
6.1.1 TEST PROCEDURE	24
6.1.2 DEVIATION FROM STANDARD	25
6.1.3 TEST SETUP	25
6.1.4 EUT OPERATION CONDITIONS	25
6.1.5 EUT TEST CONDITIONS	25
6.1.6 TEST RESULTS	25
7 . POWER SPECTRAL DENSITY TEST	26
7.1 APPLIED PROCEDURES / LIMIT	26
8.1.1 TEST PROCEDURE	26
7.1.1 DEVIATION FROM STANDARD	27
7.1.2 TEST SETUP	27
7.1.3 EUT OPERATION CONDITIONS	27
7.1.4 EUT TEST CONDITIONS	27
7.1.5 TEST RESULTS	27
8 . FREQUENCY STABILITY MEASUREMENT	28
8.1 APPLIED PROCEDURES / LIMIT	28
8.1.1 TEST PROCEDURE	28
8.1.2 DEVIATION FROM STANDARD	28
8.1.3 TEST SETUP	29
8.1.4 EUT OPERATION CONDITIONS	29
8.1.5 EUT TEST CONDITIONS	29
8.1.6 TEST RESULTS	29
9 . MEASUREMENT INSTRUMENTS LIST	30
10. EUT TEST PHOTOS	32
ATTACHMENT A -CONDUCTED EMISSION	37
ATTACHMENT B -RADIATED EMISSION (9KHZ TO 30MHZ)	42
ATTACHMENT D -RADIATED EMISSION (ABOVE 1000MHZ)	76
ATTACHMENT E -BANDWIDTH	195
ATTACHMENT F - MAXIMUM OUTPUT POWER	218
ATTACHMENT H - POWER SPECTRAL DENSITY	231
ATTACHMENT H -FREQUENCY STABILITY	288
10 . EUT PHOTOS	291

REPORT ISSUED HISTORY

Issued No.	Description	Issued Date
BTL-FCCP-1-1608C193	Original Issue.	Oct. 11, 2016

1. CERTIFICATION

Equipment : Wireless AC1200 Dual Band Access Point
Brand Name : D-Link
Model Name : DAP-1665
Applicant : D-Link Corporation
Date of Test : Aug. 18, 2016 ~ Oct. 10, 2016
Test Sample : Engineering Sample
Standard(s) : FCC Part15, Subpart E(15.407) / ANSI C63.10-2013

The above equipment has been tested and found compliance with the requirement of the relative standards by BTL Inc.

The test data, data evaluation, and equipment configuration contained in our test report (Ref No. BTL-FCCP-1-1608C193) were obtained utilizing the test procedures, test instruments, test sites that has been accredited by the Authority of TAF according to the ISO-17025 quality assessment standard and technical standard(s).

Test results included in this report is only for the 5G WIFI part.

2. SUMMARY OF TEST RESULTS

Test procedures according to the technical standard(s):

FCC Part15, Subpart E			
Standard(s) Section	Test Item	Judgment	Remark
15.207	AC Power Line Conducted Emissions	PASS	
15.407(a)	26dB Spectrum Bandwidth	PASS	
15.407(a)	Maximum Conducted Output Power	PASS	
15.407(a)	Power Spectral Density	PASS	
15.407(a)	Radiated Emissions	PASS	
15.407(b)	Band Edge Emissions	PASS	
15.407(g)	Frequency Stability	PASS	
15.203	Antenna Requirements	PASS	

NOTE:

(1) "N/A" denotes test is not applicable in this test report.

2.1 TEST FACILITY

The test facilities used to collect the test data in this report is at the location of No.3,Jinshagang 1st Road, Shixia, Dalang Town, Dongguan, Guangdong, China.

BTL's test firm number for FCC: 319330

2.2 MEASUREMENT UNCERTAINTY

Where relevant, the following measurement uncertainty levels have been estimated for tests performed on the EUT as specified in CISPR 16-4-2. The BTL measurement uncertainty is less than the CISPR 16-4-2 U_{CISPR} requirement.

The reported uncertainty of measurement $y \pm U$, where expanded uncertainty U is based on a standard uncertainty multiplied by a coverage factor of $k=2$, providing a level of confidence of approximately 95%.

A. Conducted Measurement:

Test Site	Method	Measurement Frequency Range	U, (dB)
DG-C02	CISPR	150 KHz~30MHz	1.94

B. Radiated Measurement:

Test Site	Method	Measurement Frequency Range	Ant. H / V	U, (dB)
DG-CB03	CISPR	9kHz~30MHz	V	3.79
		9kHz~30MHz	H	3.57
		30MHz~200MHz	V	3.82
		30MHz~200MHz	H	3.60
		200MHz~ 1,000MHz	V	3.86
		200MHz~ 1,000MHz	H	3.94
		1GHz~18GHz	V	3.12
		1GHz~18GHz	H	3.68
		18GHz~40GHz	V	4.15
		18GHz~40GHz	H	4.14

Note: Unless specifically mentioned, the uncertainty of measurement has not been taken into account to declare the compliance or non-compliance to the specification.

3. GENERAL INFORMATION

3.1 GENERAL DESCRIPTION OF EUT

Equipment	Wireless AC1200 Dual Band Access Point	
Brand Name	D-Link	
Model Name	DAP-1665	
Mode Different	N/A	
Product Description	Operation Frequency	UNII-1: 5150-5250MHz UNII-3: 5725-5850MHz
	Modulation Type	OFDM
	Bit Rate of Transmitter	867Mbps
Output Power	Output Power (Max.)for for UNII-1 (2TX with Beamforming)	802.11a:26.60dBm 802.11n (20M): 26.39dBm 802.11n (40M): 24.75dBm 802.11ac (20M): 26.25dBm 802.11ac (40M): 24.54dBm 802.11ac (80M): 17.97dBm
	Output Power (Max.)for UNII-3 (2TX with Beamforming)	802.11a:26.14dBm 802.11n (20M): 26.20dBm 802.11n (40M): 26.68dBm 802.11ac (20M): 26.25dBm 802.11ac (40M): 26.68dBm 802.11ac (80M): 23.77dBm
Power Source	DC voltage supplied from AC/DC adapter. #1 Brand / Model:D-Link/2AAJ012F US #2 Brand / Model:D-Link /MU12AR120100-A1	
Power Rating	#1 I/P 100-240V~ 50-60Hz, 0.35A O/P: 12.0V---1.0A #2 I/P 100-240V~ 50-60Hz, 0.3A O/P: 12V---1A	

Note:

1. For a more detailed features description, please refer to the manufacturer's specifications or the User's Manual.
2. Channel List:

UNII-1		UNII-1		UNII-1	
Channel	Frequency (MHz)	Channel	Frequency (MHz)	Channel	Frequency (MHz)
36	5180	38	5190	42	5210
40	5200	46	5230		
44	5220				
48	5240				

UNII-3		UNII-3		UNII-3	
Channel	Frequency (MHz)	Channel	Frequency (MHz)	Channel	Frequency (MHz)
149	5745	151	5755	155	5775
153	5765	159	5795		
157	5785				
161	5805				
165	5825				

3. Antenna Specification:

Group 1

Ant.	Brand	Model Name	Antenna Type	Connector	Gain (dBi)
1	RenFeng	RF21S00240A	Dipole	SMA	5.10
2	RenFeng	RF21S00240A	Dipole	SMA	5.10

Group 2

Ant.	Brand	Model Name	Antenna Type	Connector	Gain (dBi)
1	WHAYU	C037-511429-A	Dipole	SMA	4.50
2	WHAYU	C037-511429-A	Dipole	SMA	4.50

Note:

The EUT incorporates a MIMO function. Physically, the EUT provides two completed transmitters and receivers (2T2R). All transmit signals are completely correlated, then, Direction gain = 5.10.

Remark:

For 2TX with beamforming

The EUT with beamforming function, then, Direction gain = $G_{ANT} + 10 \log(N_{ANT}/N_{SS})$, where N_{SS} = the number of independent spatial streams of data.

Directional gain = $5.10 + 10 \log(2/2) = 5.10 + 0 = 5.10$ dBi.

The beamforming ANT gain is 3dBi.

The UNII-1 EIRP Output Power limit is $30 - (5.10 + 3) + 6 = 27.90$ dBm

The UNII-3 Output Power limit is $30 - (5.10 + 3) + 6 = 27.90$ dBm

The UNII-1 PSD limit is $17 - (5.10 + 3) + 6 = 14.90$ dBm/MHz

The UNII-3 PSD limit is $30 - (5.10 + 3) + 6 = 27.90$ dBm/500kHz.

4.

Operating Mode	2TX
TX Mode	
802.11a	V (ANT 1+ANT 2)
802.11n(20MHz)	V (ANT 1+ANT 2)
802.11n(40MHz)	V (ANT 1+ANT 2)
802.11ac (20MHz)	V (ANT 1+ANT 2)
802.11ac (40MHz)	V (ANT 1+ANT 2)
802.11ac (80MHz)	V (ANT 1+ANT 2)

3.2 DESCRIPTION OF TEST MODES

To investigate the maximum EMI emission characteristics generates from EUT, the test system was pre-scanning tested base on the consideration of following EUT operation mode or test configuration mode which possible have effect on EMI emission level. Each of these EUT operation mode(s) or test configuration mode(s) mentioned above was evaluated respectively.

Pretest Mode	Description
Mode 1	TX A Mode/ CH36, CH40, CH48 (UNII-1)
Mode 2	TX N20 Mode/ CH36, CH40, CH48 (UNII-1)
Mode 3	TX N40 Mode/ CH38, CH46 (UNII-1)
Mode 4	TX AC20 Mode/ CH36, CH40, CH48 (UNII-1)
Mode 5	TX AC40 Mode/ CH38, CH46 (UNII-1)
Mode 6	TX AC80 Mode / CH42 (UNII-1)
Mode 7	TX A Mode / CH149,CH157,CH165 (UNII-3)
Mode 8	TX N20 Mode / CH149,CH157,CH165 (UNII-3)
Mode 9	TX N40 Mode / CH151,CH159 (UNII-3)
Mode 10	TX AC20 Mode / CH149,CH157,CH165 (UNII-3)
Mode 11	TX AC40 Mode / CH151,CH159 (UNII-3)
Mode 12	TX AC80 Mode / CH155 (UNII-3)
Mode 13	TX Mode

The EUT system operated these modes were found to be the worst case during the pre-scanning test as following:

For Conducted Test	
Final Test Mode	Description
Mode 13	TX Mode

For Radiated Test	
Final Test Mode	Description
Mode 1	TX A Mode/ CH36, CH40, CH48 (UNII-1)
Mode 2	TX N20 Mode/ CH36, CH40, CH48 (UNII-1)
Mode 3	TX N40 Mode/ CH38, CH46 (UNII-1)
Mode 4	TX AC20 Mode/ CH36, CH40, CH48 (UNII-1)
Mode 5	TX AC40 Mode/ CH38, CH46 (UNII-1)
Mode 6	TX AC80 Mode / CH42 (UNII-1)
Mode 7	TX A Mode / CH149,CH157,CH165 (UNII-3)
Mode 8	TX N20 Mode / CH149,CH157,CH165 (UNII-3)
Mode 9	TX N40 Mode / CH151,CH159 (UNII-3)
Mode 10	TX AC20 Mode / CH149,CH157,CH165 (UNII-3)
Mode 11	TX AC40 Mode / CH151,CH159 (UNII-3)
Mode 12	TX AC80 Mode / CH155 (UNII-3)

Note:

(1) For radiated below 1GHz test, the 802.11a mode is found to be the worst case and recorded.

3.3 TABLE OF PARAMETERS OF TEST SOFTWARE SETTING

During testing channel & power controlling software provided by the customer was used to control the operating channel as well as the output power level. The RF output power selection is for the setting of RF output power expected by the customer and is going to be fixed on the firmware of the final end product

UNII-1 - 2TX			
Test Software Version	MP_TEST		
Frequency (MHz)	5180	5200	5240
A Mode	36/36	49/49	63/63
Frequency (MHz)	5180	5200	5240
N20 Mode	40/40	52/52	63/63
Frequency (MHz)	5190	5230	
N40 Mode	34/34	46/46	

UNII-3 - 2TX			
Test Software Version	MP_TEST		
Frequency (MHz)	5745	5785	5825
A Mode	63/63	61/61	54/54
Frequency (MHz)	5745	5785	5825
N20 Mode	63/63	63/63	63/63
Frequency (MHz)	5755	5795	
N40 Mode	63/63	51/51	

UNII-1 - 2TX			
Test Software Version	MP_TEST		
Frequency (MHz)	5180	5200	5240
AC20 Mode	39/39	52/52	63/63
Frequency (MHz)	5190	5230	
AC40 Mode	34/34	45/45	
Frequency (MHz)	5210		
AC80 Mode	33/33		

UNII-3 - 2TX			
Test Software Version	MP_TEST		
Frequency (MHz)	5745	5785	5825
AC20 Mode	63/63	63/63	63/63
Frequency (MHz)	5755	5795	
AC40 Mode	62/62	53/53	
Frequency (MHz)	5775		
AC80 Mode	44/44		

3.4 BLOCK DIAGRAM SHOWING THE CONFIGURATION OF SYSTEM TESTED

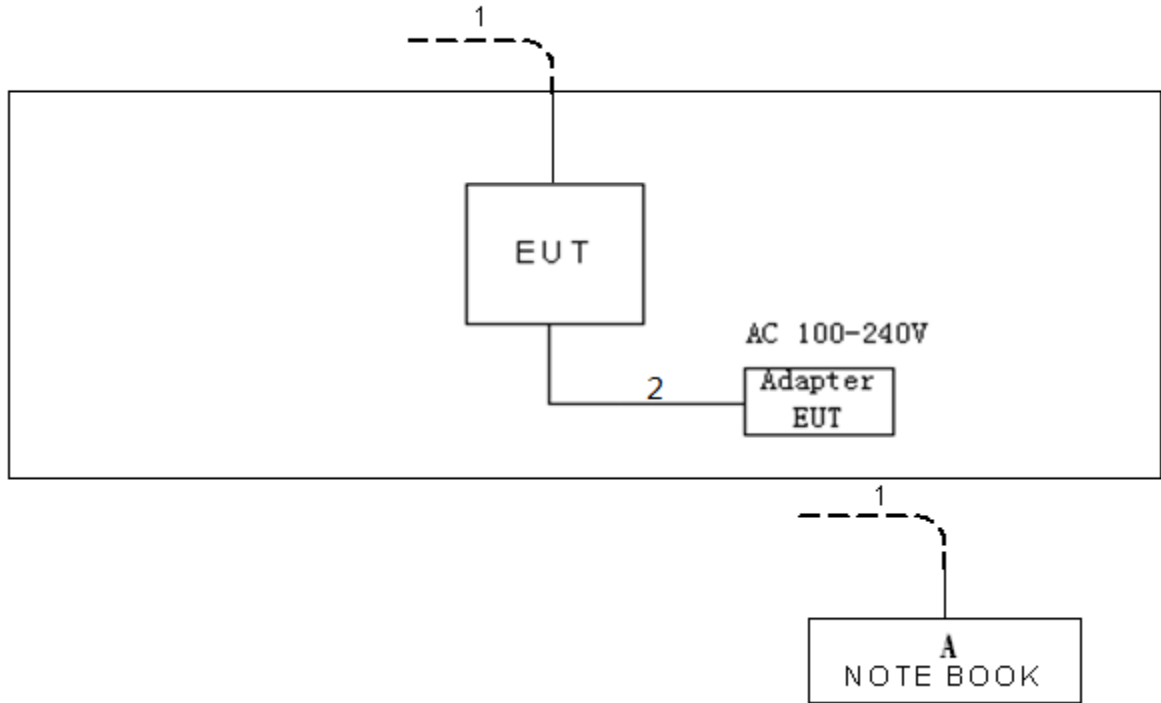

3.5 DESCRIPTION OF SUPPORT UNITS

The EUT has been tested as an independent unit together with other necessary accessories or support units. The following support units or accessories were used to form a representative test configuration during the tests.

Item	Equipment	Mfr/Brand	Model/Type No.	FCC ID	Series No.
A	NOTEBOOK	Dell 745	DCSM	DOC	G7K832X

Item	Shielded Type	Ferrite Core	Length	Note
1	NO	NO	10M	RJ-45 Cable
2	NO	NO	1.5M	AC Cable

4. EMC EMISSION TEST

4.1 CONDUCTED EMISSION MEASUREMENT

4.1.1 POWER LINE CONDUCTED EMISSION (Frequency Range 150kHz-30MHz)

FREQUENCY (MHz)	Class A (dBuV)		Class B (dBuV)	
	Quasi-peak	Average	Quasi-peak	Average
0.15 -0.5	79.00	66.00	66 - 56 *	56 - 46 *
0.50 -5.0	73.00	60.00	56.00	46.00
5.0 -30.0	73.00	60.00	60.00	50.00

Note:

- (1) The tighter limit applies at the band edges.
- (2) The limit of " * " marked band means the limitation decreases linearly with the logarithm of the frequency in the range.

4.1.2 TEST PROCEDURE

- a. The EUT was placed 0.8 meters from the horizontal ground plane with EUT being connected to the power mains through a line impedance stabilization network (LISN). All other support equipments powered from additional LISN(s). The LISN provide 50 Ohm/ 50uH of coupling impedance for the measuring instrument.
- b. Interconnecting cables that hang closer than 40 cm to the groundplane shall be folded back and forth in the center forming a bundle 30 to 40 cm long.
- c. I/O cables that are not connected to a peripheral shall be bundled in the center. The end of the cable may be terminated, if required, using the correct terminating impedance. The overall length shall not exceed 1 m.
- d. LISN at least 80 cm from nearest part of EUT chassis.
- e. For the actual test configuration, please refer to the related Item –EUT Test Photos.

4.1.3 DEVIATION FROM TEST STANDARD

No deviation

4.1.4 TESTSETUP

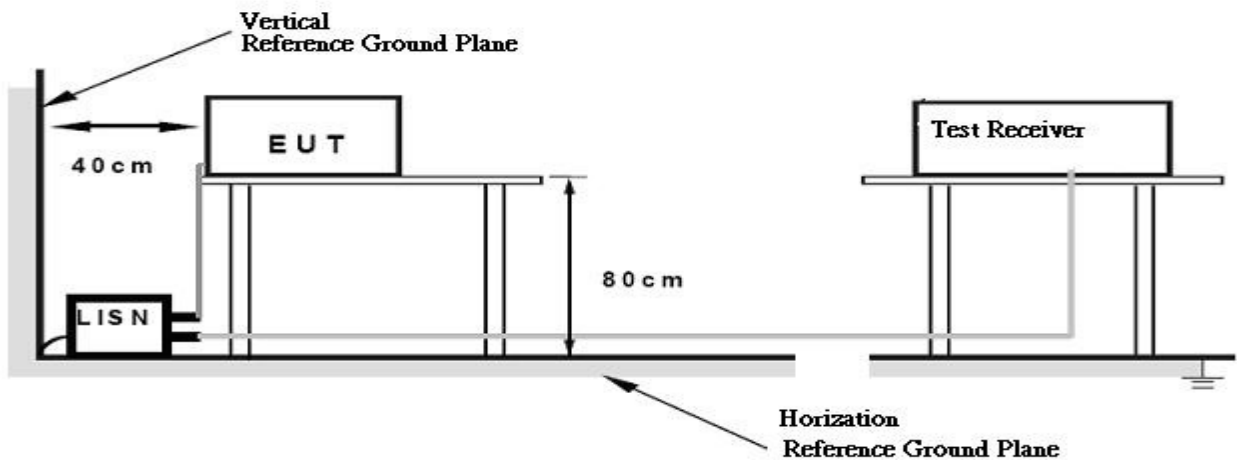

4.1.5 EUT OPERATING CONDITIONS

The EUT was configured for testing in a typical fashion (as a customer would normally use it). The EUT has been programmed to continuously transmit during test. This operating condition was tested and used to collect the included data.

The EUT was programmed to be in continuously transmitting/TX Mode mode.

4.1.6 EUT TEST CONDITIONS

Temperature: 25°C Relative Humidity: 53% Test Voltage: AC 120V/60Hz

4.1.7 TEST RESULTS

Please refer to the Attachment A.

Remark:

- (1) All readings are QP Mode value unless otherwise stated AVG in column of 『Note』. If the QP Mode Measured value compliance with the QP Limits and lower than AVG Limits, the EUT shall be deemed to meet both QP & AVG Limits and then only QP Mode was measured, but AVG Mode didn't perform. In this case, a "*" marked in AVG Mode column of Interference Voltage Measured.
- (2) Measuring frequency range from 150kHz to 30MHz.

4.2 RADIATED EMISSION MEASUREMENT

4.2.1 RADIATED EMISSION LIMITS

20dBc in any 100 kHz bandwidth outside the operating frequency band. In case the emission fall within the restricted band specified on 15.205(a), then the 15.209(a) limit in the table below has to be followed.

Frequencies (MHz)	Field Strength (microrvolts/meter)	Measurement Distance (meters)
0.009~0.490	2400/F(kHz)	300
0.490~1.705	24000/F(kHz)	30
1.705~30.0	30	30
30~88	100	3
88~216	150	3
216~960	200	3
Above 960	500	3

Frequencies (MHz)	EIRP Limit (dBm)	Equivalent Field Strength at 3m (dBμV/m)
5150-5250	-27	68.3
5250-5350	-27	68.3
5470-5725	-27	68.3
5725-5850	-27(Note 2)	68.3
	10(Note 2)	105.3
	15.6(Note 2)	110.9
	27(Note 2)	122.3

Note:

1. The following formula is used to convert the equipment isotropic radiated power (eirp) to

field strength: $E = \frac{1000000\sqrt{30P}}{3} \mu\text{V/m}$, where P is the eirp (Watts)

2. According to FCC 16-24, All emissions shall be limited to a level of -27 dBm/MHz at 75 MHz or more above or below the band edge increasing linearly to 10 dBm/MHz at 25 MHz above or below the band edge, and from 25MHz above or below the band edge increasing linearly to a level of 15.6 dBm/MHz at 5 MHz above or below the band edge, and from 5 MHz above or below the band edge increasing linearly to a level of 27dBm/MHz at the band edge.

4.2.2 TEST PROCEDURE

- a. The measuring distance of 3 m shall be used for measurements. The EUT was placed on the top of a rotating table 0.8 meter above the ground at a 3 meter semi-anechoic chamber. The table was rotated 360 degrees to determine the position of the highest radiation.(below 1GHz)
- b. The measuring distance of 3 m shall be used for measurements. The EUT was placed on the top of a rotating table 1.5 meter above the ground at a 3 meter semi-anechoic chamber. The table was rotated 360 degrees to determine the position of the highest radiation.(above 1GHz)
- c. The height of the equipment or of the substitution antenna shall be 0.8m or 1.5m; the height of the test antenna shall vary between 1 m to 4 m. Both horizontal and vertical polarizations of the antenna are set to make the measurement.
- d. For each suspected emission, the EUT was arranged to its worst case and then the antenna was tuned to heights find the maximum reading (used Bore sight function).
- e. The receiver system was set to peak and average detect function and specified bandwidth with maximum hold mode when the test frequency is above 1GHz.
- f. The initial step in collecting radiated emission data is a receiver peak detector mode pre-scanning the measurement frequency range. Significant peaks are then marked and then Quasi Peak detector mode re-measured.
- g. All readings are Peak unless otherwise stated QP in column of Note. Peak denotes that the Peak reading compliance with the QP Limits and then QP Mode measurement didn't perform. (below 1GHz)
- h. All readings are Peak Mode value unless otherwise stated AVG in column of Note. If the Peak Mode Measured value compliance with the Peak Limits and lower than AVG Limits, the EUT shall be deemed to meet both Peak & AVG Limits and then only Peak Mode was measured, but AVG Mode didn't perform. (above 1GHz)
- i. For the actual test configuration, please refer to the related Item –EUT Test Photos.

4.2.3 DEVIATION FROM TEST STANDARD

No deviation

4.2.4 TEST SETUP

(A) Radiated Emission Test Set-Up Frequency Below 1GHz

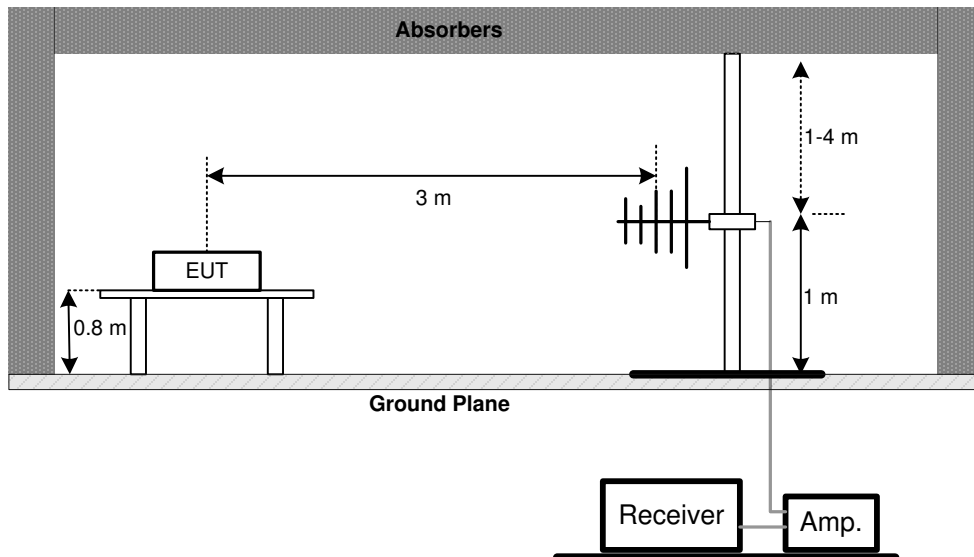

(B) Radiated Emission Test Set-Up Frequency Above 1 GHz

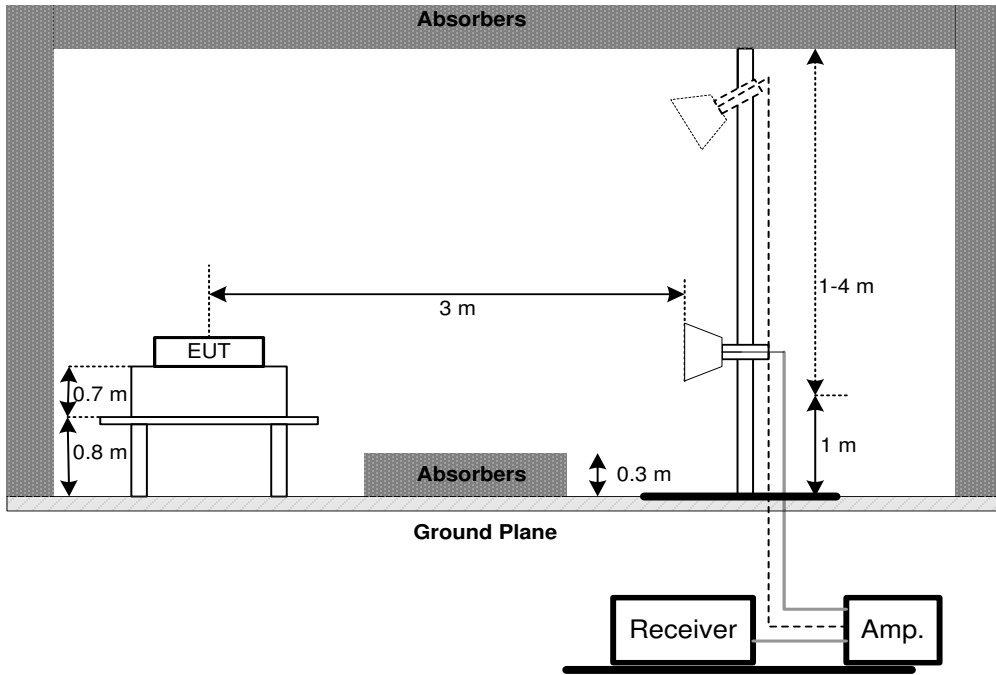

(C) Radiated emissions below 30MHz

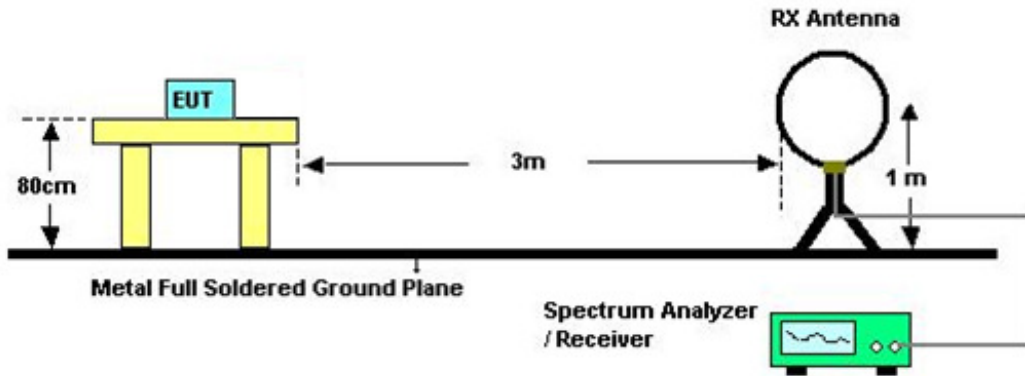

4.2.5 EUT OPERATING CONDITIONS

The EUT tested system was configured as the statements of 4.1.5 unless otherwise a special operating condition is specified in the follows during the testing.

4.2.6 EUT TEST CONDITIONS

Temperature: 25°C Relative Humidity: 60% Test Voltage: AC 120V/60Hz

4.2.7 TEST RESULTS (9K TO 30MHz)

Please refer to the Attachment B

Remark:

- (1) The amplitude of spurious emissions which are attenuated by more than 20 dB below the permissible value has no need to be reported.
- (2) Distance extrapolation factor = $40 \log (\text{specific distance} / \text{test distance})$ (dB);
- (3) Limit line = specific limits (dBuV) + distance extrapolation factor.

4.2.8 TEST RESULTS(BETWEEN30 TO 1000 MHz)

Please refer to the Attachment C.

4.2.9 TEST RESULTS (ABOVE1000 MHz)

Please refer to the Attachment D.

Remark:

- (1) No limit: This is fundamental signal, the judgment is not applicable.
For fundamental signal judgment was referred to Peak output test.

5.26dB SPECTRUM BANDWIDTH

5.1 APPLIED PROCEDURES / LIMIT

FCC Part15, Subpart E			
Test Item	Limit	Frequency Range (MHz)	Result
Bandwidth	26 dB Bandwidth	5150-5250	PASS
	Minimum 500kHz 6dB Bandwidth	5725-5850	PASS

5.1.1 TEST PROCEDURE

a. The EUT was directly connected to the spectrum analyzer and antenna output port as show in the block diagram below,

b.

Spectrum Parameters	Setting
Attenuation	Auto
Span Frequency	> 26dB Bandwidth
RBW	300 kHz
VBW	1000 kHz
Detector	Peak
Trace	Max Hold
Sweep Time	Auto

c. Measured the spectrum width with power higher than 26dB below carrier

5.1.2 DEVIATION FROM STANDARD

No deviation.

5.1.3 TEST SETUP



5.1.4 EUT OPERATION CONDITIONS

The EUT tested system was configured as the statements of 4.1.5 unless otherwise a special operating condition is specified in the follows during the testing.

5.1.5 EUT TEST CONDITIONS

Temperature: 25°C Relative Humidity: 60% Test Voltage: AC 120V/60Hz

5.1.6 TEST RESULTS

Please refer to the Attachment E.

6. MAXIMUM CONDUCTED OUTPUT POWER

6.1 APPLIED PROCEDURES / LIMIT

FCC Part15, Subpart E			
Test Item	Limit	Frequency Range (MHz)	Result
Conducted Output Power	Fixed:1 Watt (30dBm) Mobile and portable: 250mW (24dBm)	5150-5250	PASS
	1 Watt (30dBm)	5725-5850	PASS
Note: The maximum e.i.r.p at anyelevation angle above 30 degrees as measured from the horizon must not exceed 125mW(21dBm)			

6.1.1 TEST PROCEDURE

- a. The EUT was directly connected to the power meter and antenna output port as show in the block diagram below,

b.

Spectrum Parameter	Setting
Attenuation	Auto
Span Frequency	Encompass the entire emissions bandwidth (EBW) of the signal
RBW	= 1MHz.
VBW	≥ 3MHz.
Detector	RMS
Trace	Max Hold
Sweep Time	auto

- c. Test was performed in accordance with method of KDB 789033 D02.

6.1.2 DEVIATION FROM STANDARD

No deviation.

6.1.3 TEST SETUP



6.1.4 EUT OPERATION CONDITIONS

The EUT tested system was configured as the statements of 4.1.5 unless otherwise a special operating condition is specified in the follows during the testing.

6.1.5 EUT TEST CONDITIONS

Temperature: 25°C Relative Humidity: 60% Test Voltage: AC 120V/60Hz

6.1.6 TEST RESULTS

Please refer to the Attachment F.

7. POWER SPECTRAL DENSITY TEST

7.1 APPLIED PROCEDURES / LIMIT

FCC Part15, Subpart E			
Test Item	Limit	Frequency Range (MHz)	Result
Power Spectral Density	Other then Mobile and portable:17dBm/MHz Mobile and portable:11dBm/MHz	5150-5250	PASS
	30dBm/500kHz	5725-5850	PASS

8.1.1 TEST PROCEDURE

a. The EUT was directly connected to the spectrum analyzer and antenna output port as show in the block diagram below,

b.

Spectrum Parameter	Setting
Attenuation	Auto
Span Frequency	Encompass the entire emissions bandwidth (EBW) of the signal
RBW	= 1MHz.
VBW	≥ 3MHz.
Detector	RMS
Trace average	100 trace
Sweep Time	Auto

Note:

1. For UNII-3, according to KDB publication 789033 D02 General UNII Test Procedures New Rules v01r02, section II.F.5., it is acceptable to set RBW at 1MHz and VBW at 3MHz if the spectrum analyzer does not have 500kHz RBW.
2. The value measured with RBW=1MHz is to be added with $10\log(500\text{kHz}/1\text{MHz})$ which is -3dB. For example, if the measured value is +10dBm using RBW=1MHz (that is +10dBm/MHz), then the converted value will be +7dBm/500kHz.

7.1.1 DEVIATION FROM STANDARD

No deviation.

7.1.2 TEST SETUP



7.1.3 EUT OPERATION CONDITIONS

The EUT tested system was configured as the statements of 4.1.5 unless otherwise a special operating condition is specified in the follows during the testing.

7.1.4 EUT TEST CONDITIONS

Temperature: 25°C Relative Humidity: 60% Test Voltage: AC 120V/60Hz

7.1.5 TEST RESULTS

Please refer to the Attachment H.

8.FREQUENCY STABILITY MEASUREMENT

8.1 APPLIED PROCEDURES / LIMIT

FCC Part15, Subpart E			
Test Item	Limit	Frequency Range (MHz)	Result
FSpecified in the user's manual Specified in the user's manual frequency Stability	Specified in the user's manual	5150-5250	PASS
		5725-5850	PASS

8.1.1 TEST PROCEDURE

a. The EUT was directly connected to the spectrum analyzer and antenna output port as show in the block diagram below,

b.

Spectrum Parameter	Setting
Attenuation	Auto
Span Frequency	Entire absence of modulation emissionsbandwidth
RBW	10 kHz
VBW	10kHz
Sweep Time	Auto

c. The test extreme voltage is to change the primary supply voltage from 85 to 115 percent of the nominal value.

d. User manual temperature is 0°C~40°C.

8.1.2 DEVIATION FROM STANDARD

No deviation.

8.1.3 TEST SETUP

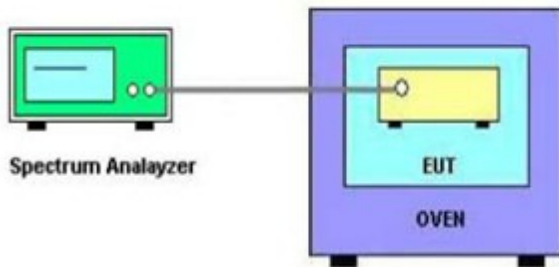

8.1.4 EUT OPERATION CONDITIONS

The EUT tested system was configured as the statements of 4.1.5 unless otherwise a special operating condition is specified in the follows during the testing.

8.1.5 EUT TEST CONDITIONS

Temperature: 25°C Relative Humidity: 55% Test Voltage: AC 120V/60Hz

8.1.6 TEST RESULTS

Please refer to the Attachment I.

9. MEASUREMENT INSTRUMENTS LIST

Conducted Emission Measurement					
Item	Kind of Equipment	Manufacturer	Type No.	Serial No.	Calibrated until
1	LISN	EMCO	3816/2	0052765	Mar. 27, 2017
2	LISN	R&S	ENV216	101447	Mar. 27, 2017
3	Test Cable	emci	RG223(9KHz-30 MHz)	C_17	Mar. 10, 2017
4	EMI Test Receiver	R&S	ESCI	100382	Mar. 27, 2017
5	50Ω Terminator	SHX	TF2-3G-A	08122901	Mar. 27, 2017
6	Measurement Software	Farad	EZ-EMC Ver.NB-03A1-01	N/A	N/A

Radiated Emission Measurement					
Item	Kind of Equipment	Manufacturer	Type No.	Serial No.	Calibrated until
1	Antenna	Schwarzbeck	VULB9160	9160-3232	Mar. 27, 2017
2	Amplifier	HP	8447D	2944A09673	Nov. 09, 2016
3	Receiver	AGILENT	N9038A	MY52130039	Oct. 10, 2017
4	Test Cable	emci	LMR-400(30MHz-1GHz)	C-01	Jun. 26, 2017
5	Control	CT	SC100	N/A	N/A
6	Position Control	MF	MF-7802	MF780208416	N/A
7	Antenna	ETS	3115	00075789	Mar. 27, 2017
8	Amplifier	Agilent	8449B	3008A02274	Nov. 01, 2016
9	Receiver	AGILENT	N9038A	MY52130039	Oct. 10, 2017
10	Test Cable	emci	EMC104-SM-S M-10000(1GHz-26.5GHz)	C-68	Jun. 26, 2017
11	Controller	CT	SC100	N/A	N/A
12	Broad-Band Horn Antenna	Schwarzbeck	BBHA 9170	9170319	Apr. 23, 2017
13	Microwave Pre-amplifier With Adaptor	EMC INSTRUMENT	EMC2654045	980039 & HA01	Mar. 27, 2017
14	Active Loop Antenna	R&S	HFH2-Z2	830749/020	Sep. 06, 2017
15	Measurement Software	Farad	EZ-EMC Ver.NB-03A1-01	N/A	N/A

Spectrum Bandwidth Measurement					
Item	Kind of Equipment	Manufacturer	Type No.	Serial No.	Calibrated until
1	Spectrum Analyzer	R&S	FSP 40	100185	Oct. 10, 2017

Maximum Conducted Output Power Measurement					
Item	Kind of Equipment	Manufacturer	Type No.	Serial No.	Calibrated until
1	P-series Power meter	Agilent	N1911A	MY45100473	Oct. 10, 2017
2	Wireband Power sensor	Agilent	N1921A	MY51100041	Oct. 10, 2017

Power Spectral Density Measurement					
Item	Kind of Equipment	Manufacturer	Type No.	Serial No.	Calibrated until
1	Spectrum Analyzer	R&S	FSP 40	100185	Oct. 10, 2017

Frequency Stability Measurement					
Item	Kind of Equipment	Manufacturer	Type No.	Serial No.	Calibrated until
1	Spectrum Analyzer	R&S	FSP 40	100185	Oct. 10, 2017
2	Precision Oven Tester	HOLINK	H-T-1F-D	BA03101701	May 22, 2017

Remark: "N/A" denotes no model name, serial no. or calibration specified.
 All calibration period of equipment list is one year.

10.EUT TEST PHOTOS**Conducted Measurement Photos**

Radiated Measurement Photos

9KHz to 30MHz



Radiated Measurement Photos

30MHz to 1000MHz

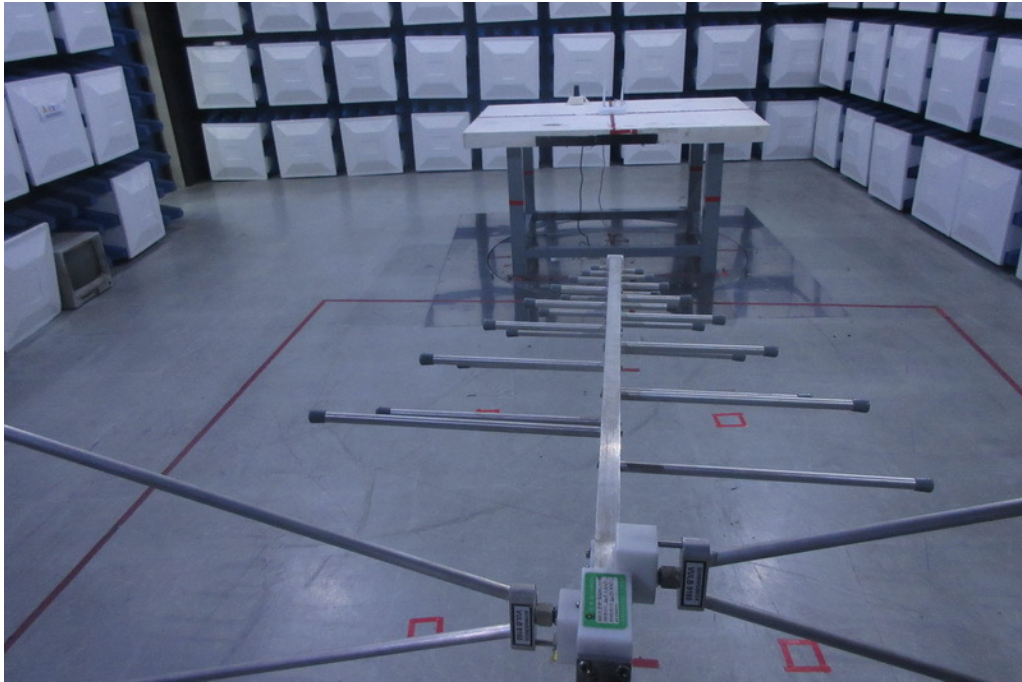

Radiated Measurement Photos

Above 1000MHz

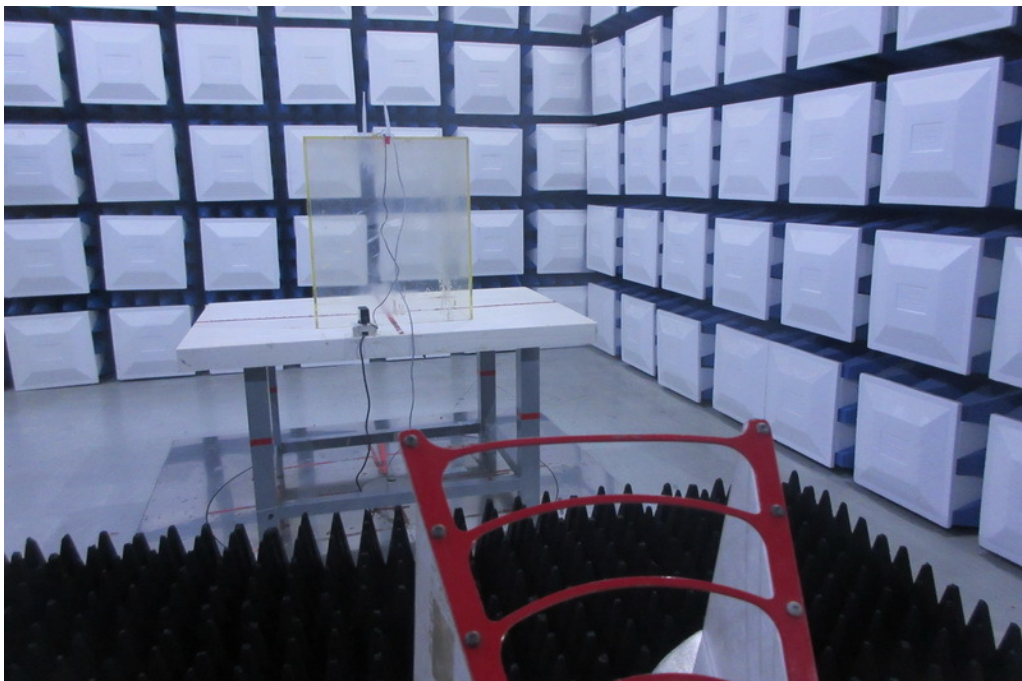
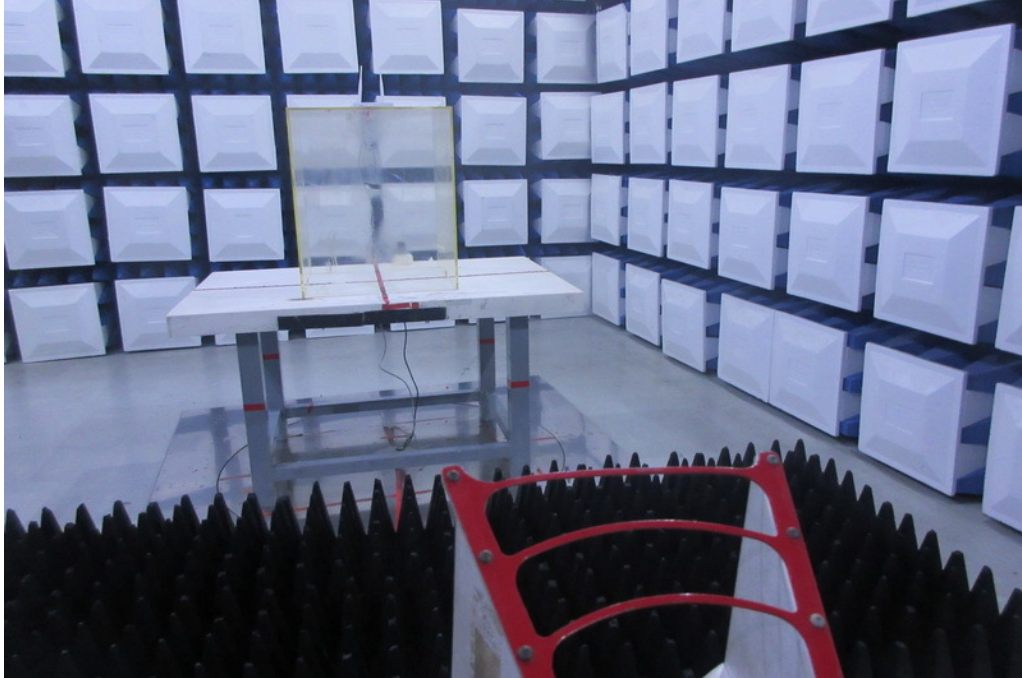

Conducted Measurement Photos

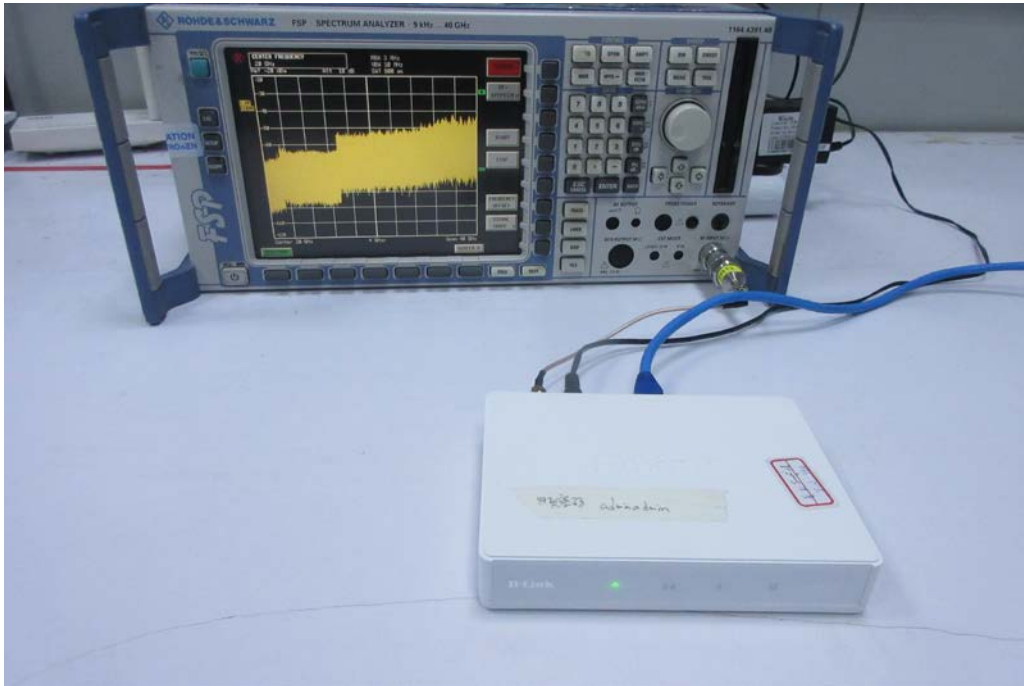

ATTACHMENTA -CONDUCTED EMISSION

Test Mode: TX MODE_Adapter: 2AAJ012F US

Line

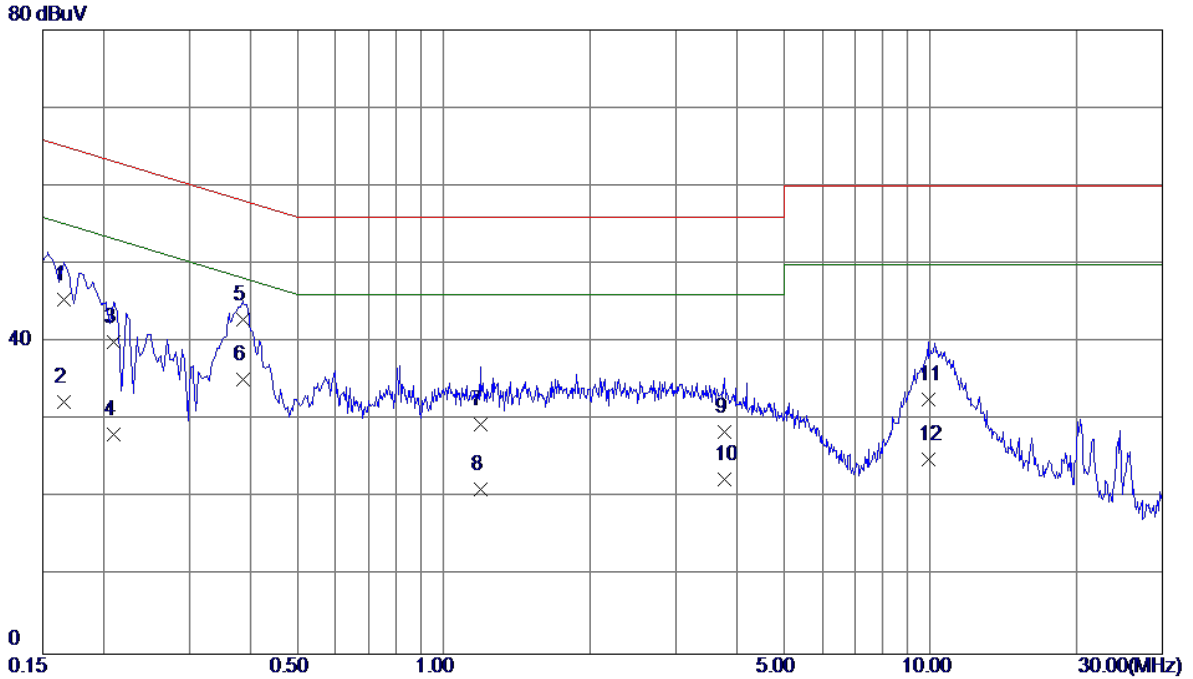

No.	Freq. MHz	Reading Level dBuV	Correct Factor dB	Measure ment dBuV	Limit dBuV	Margin dB	Detector	Comment
1	0.1660	35.90	9.52	45.42	65.16	-19.74	QP	
2	0.1660	22.80	9.52	32.32	55.16	-22.84	AVG	
3	0.2100	30.40	9.53	39.93	63.21	-23.28	QP	
4	0.2100	18.60	9.53	28.13	53.21	-25.08	AVG	
5	0.3860	33.30	9.54	42.84	58.15	-15.31	QP	
6 *	0.3860	25.60	9.54	35.14	48.15	-13.01	AVG	
7	1.1900	19.70	9.77	29.47	56.00	-26.53	QP	
8	1.1900	11.40	9.77	21.17	46.00	-24.83	AVG	
9	3.7780	18.30	10.17	28.47	56.00	-27.53	QP	
10	3.7780	12.30	10.17	22.47	46.00	-23.53	AVG	
11	9.9100	22.50	10.21	32.71	60.00	-27.29	QP	
12	9.9100	14.70	10.21	24.91	50.00	-25.09	AVG	

Note : The test result has included the cable loss.

Test Mode: TX MODE_Adapter: 2AAJ012F US

Neutral

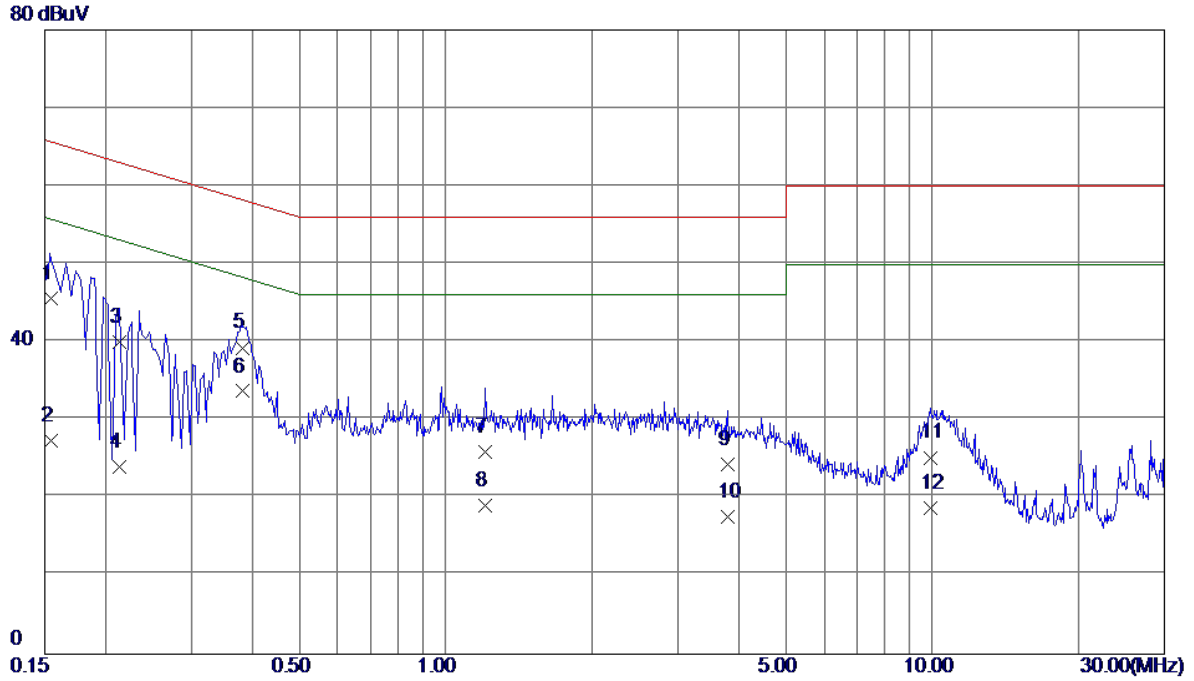

No.	Freq. MHz	Reading Level dBuV	Correct Factor dB	Measure ment dBuV	Limit dBuV	Margin dB	Detector	Comment
1	0.1548	36.10	9.50	45.60	65.74	-20.14	QP	
2	0.1548	17.90	9.50	27.40	55.74	-28.34	AVG	
3	0.2140	30.40	9.53	39.93	63.05	-23.12	QP	
4	0.2140	14.50	9.53	24.03	53.05	-29.02	AVG	
5	0.3820	29.81	9.47	39.28	58.24	-18.96	QP	
6 *	0.3820	24.21	9.47	33.68	48.24	-14.56	AVG	
7	1.2059	16.30	9.67	25.97	56.00	-30.03	QP	
8	1.2059	9.40	9.67	19.07	46.00	-26.93	AVG	
9	3.7900	14.50	9.87	24.37	56.00	-31.63	QP	
10	3.7900	7.80	9.87	17.67	46.00	-28.33	AVG	
11	9.9100	14.90	10.30	25.20	60.00	-34.80	QP	
12	9.9100	8.40	10.30	18.70	50.00	-31.30	AVG	

Note : The test result has included the cable loss.

Test Mode: TX MODE _ Adapter:MU12AR120100-A1

Line

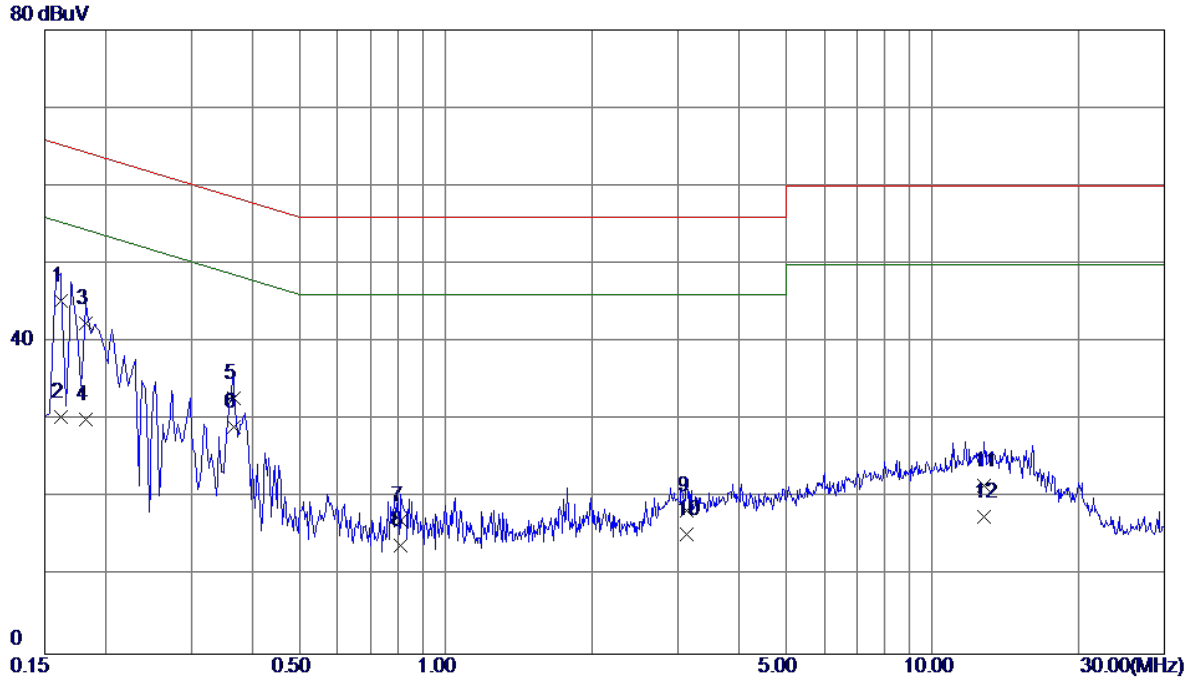

No.	Freq. MHz	Reading Level dBuV	Correct Factor dB	Measure ment dBuV	Limit dBuV	Margin dB	Detector	Comment
1	0.1620	35.70	9.52	45.22	65.36	-20.14	QP	
2	0.1620	20.90	9.52	30.42	55.36	-24.94	AVG	
3	0.1819	32.90	9.53	42.43	64.40	-21.97	QP	
4	0.1819	20.60	9.53	30.13	54.40	-24.27	AVG	
5	0.3660	23.30	9.54	32.84	58.59	-25.75	QP	
6 *	0.3660	19.60	9.54	29.14	48.59	-19.45	AVG	
7	0.8100	7.36	9.75	17.11	56.00	-38.89	QP	
8	0.8100	4.23	9.75	13.98	46.00	-32.02	AVG	
9	3.1340	8.25	10.10	18.35	56.00	-37.65	QP	
10	3.1340	5.23	10.10	15.33	46.00	-30.67	AVG	
11	12.7580	11.26	10.29	21.55	60.00	-38.45	QP	
12	12.7580	7.37	10.29	17.66	50.00	-32.34	AVG	

Note : The test result has included the cable loss.

Test Mode: TX MODE _ Adapter:MU12AR120100-A1

Neutral

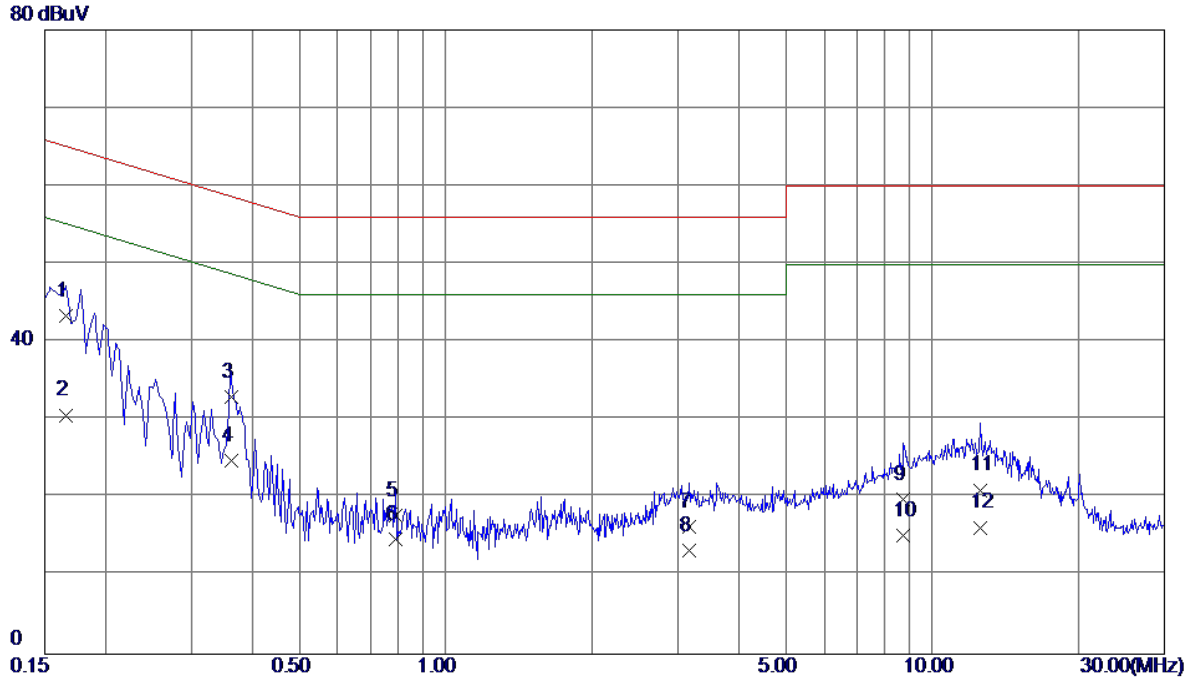

No.	Freq. MHz	Reading Level dBuV	Correct Factor dB	Measure ment dBuV	Limit dBuV	Margin dB	Detector	Comment
1 *	0.1660	33.90	9.44	43.34	65.16	-21.82	QP	
2	0.1660	21.20	9.44	30.64	55.16	-24.52	AVG	
3	0.3620	23.51	9.51	33.02	58.68	-25.66	QP	
4	0.3620	15.31	9.51	24.82	48.68	-23.86	AVG	
5	0.7900	8.25	9.54	17.79	56.00	-38.21	QP	
6	0.7900	5.23	9.54	14.77	46.00	-31.23	AVG	
7	3.1619	6.50	9.81	16.31	56.00	-39.69	QP	
8	3.1619	3.50	9.81	13.31	46.00	-32.69	AVG	
9	8.7299	9.70	10.16	19.86	60.00	-40.14	QP	
10	8.7299	5.00	10.16	15.16	50.00	-34.84	AVG	
11	12.5420	10.70	10.34	21.04	60.00	-38.96	QP	
12	12.5420	5.90	10.34	16.24	50.00	-33.76	AVG	

Note : The test result has included the cable loss.

ATTACHMENTB -RADIATED EMISSION (9KHZ TO 30MHZ)

Test Mode: TX MODE CHANNEL 01_Adapter: 2AAJ012F US

Ant 0°

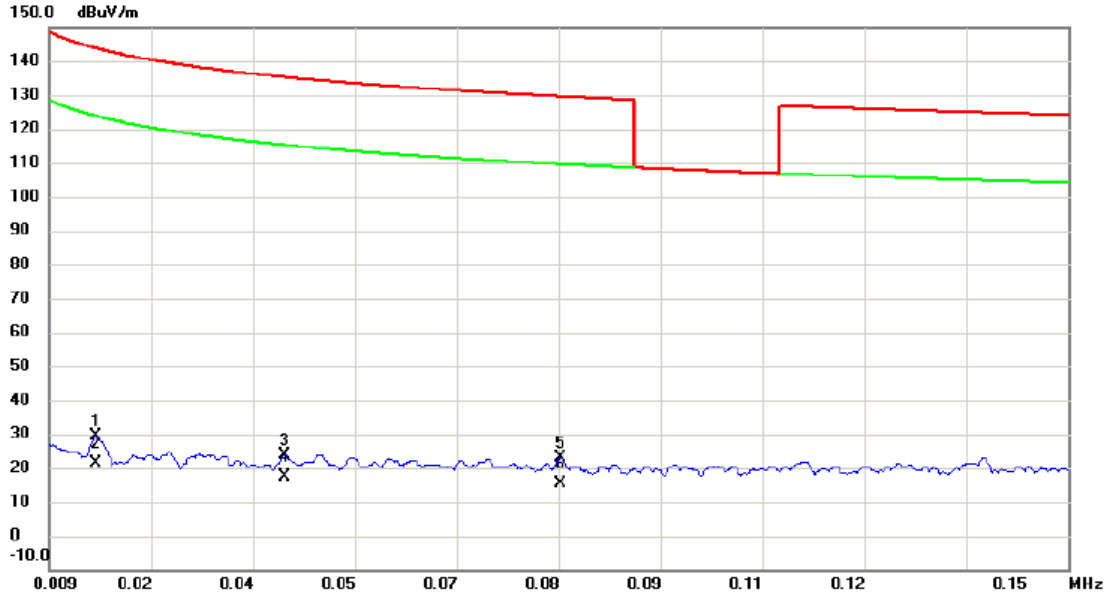

No.	Mk.	Freq. MHz	Reading Level dBuV	Correct Factor dB	Measure- ment dBuV/m	Limit dBuV/m	Margin dB	Detector	Comment
1		0.0155	5.54	23.79	29.33	143.80	-114.47	peak	
2		0.0155	-2.49	23.79	21.30	123.80	-102.50	AVG	
3		0.0417	3.00	20.84	23.84	135.20	-111.36	peak	
4		0.0417	-3.42	20.84	17.42	115.20	-97.78	AVG	
5		0.0798	3.77	19.32	23.09	129.56	-106.47	peak	
6	*	0.0798	-3.72	19.32	15.60	109.56	-93.96	AVG	

Test Mode: TX MODE CHANNEL 01_Adapter: 2AAJ012F US

Ant 0°



No.	Mk.	Freq. MHz	Reading Level dBuV	Correct Factor dB	Measure- ment dBuV/m	Limit dBuV/m	Margin dB	Detector	Comment
1		0.4485	29.48	18.43	47.91	114.57	-66.66	peak	
2		0.4485	15.65	18.43	34.08	94.57	-60.49	AVG	
3	*	2.1500	37.16	17.72	54.88	69.54	-14.66	QP	
4		3.2544	36.93	17.17	54.10	69.54	-15.44	QP	

Test Mode: TX MODE CHANNEL 01_Adapter: 2AAJ012F US

Ant 90°

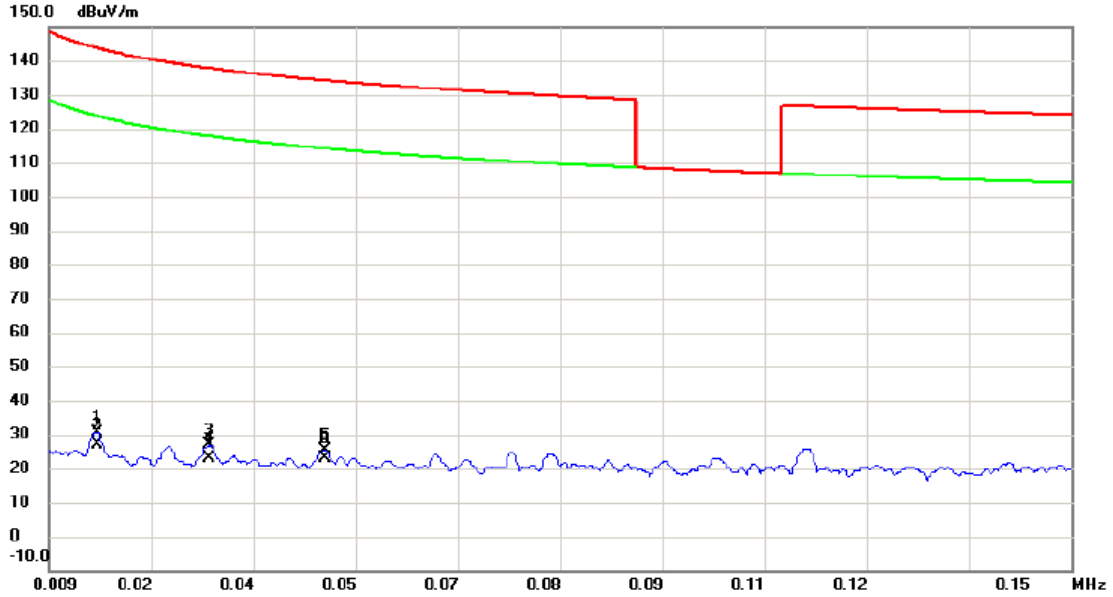

No.	Mk.	Freq. MHz	Reading Level dBuV	Correct Factor dB	Measure- ment dBuV/m	Limit dBuV/m	Margin dB	Detector	Comment
1		0.0156	6.96	23.78	30.74	143.74	-113.00	peak	
2		0.0156	3.25	23.78	27.03	123.74	-96.71	AVG	
3		0.0310	4.69	22.16	26.85	137.78	-110.93	peak	
4		0.0310	0.77	22.16	22.93	117.78	-94.85	AVG	
5		0.0471	5.41	20.18	25.59	134.14	-108.55	peak	
6	*	0.0471	2.72	20.18	22.90	114.14	-91.24	AVG	

Test Mode: TX MODE CHANNEL 01_Adapter: 2AAJ012F US

Ant 90°

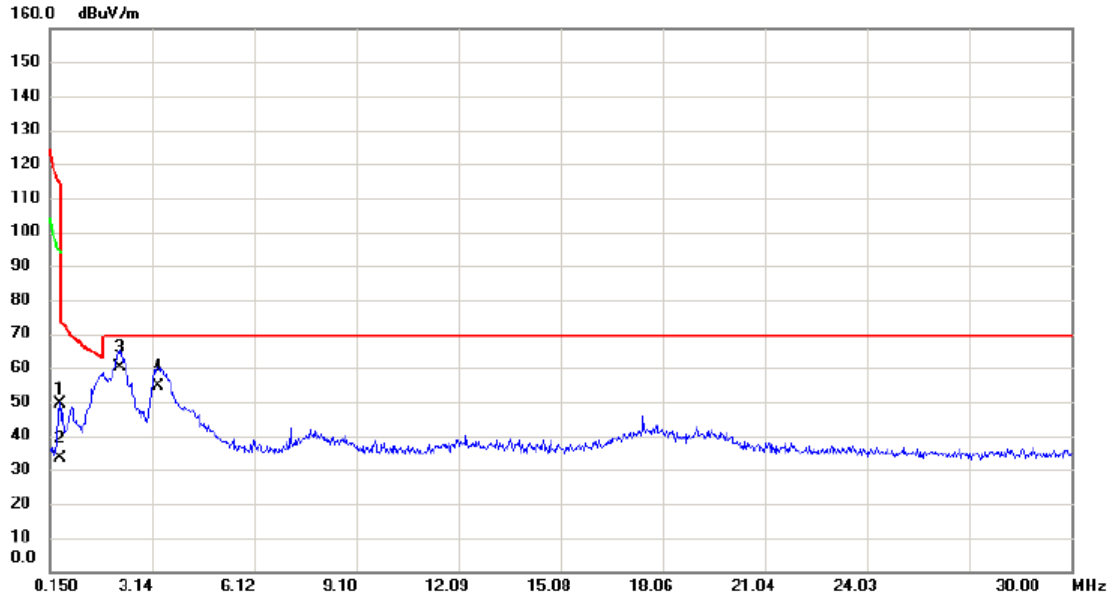

No.	Mk.	Freq. MHz	Reading Level dBuV	Correct Factor dB	Measure- ment dBuV/m	Limit dBuV/m	Margin dB	Detector	Comment
1		0.4485	31.17	18.43	49.60	114.57	-64.97	peak	
2		0.4485	14.95	18.43	33.38	94.57	-61.19	AVG	
3	*	2.1798	42.42	17.68	60.10	69.54	-9.44	QP	
4		3.3141	37.15	17.30	54.45	69.54	-15.09	QP	

Test Mode: TX MODE CHANNEL 01_ Adapter:MU12AR120100-A1

Ant 0°

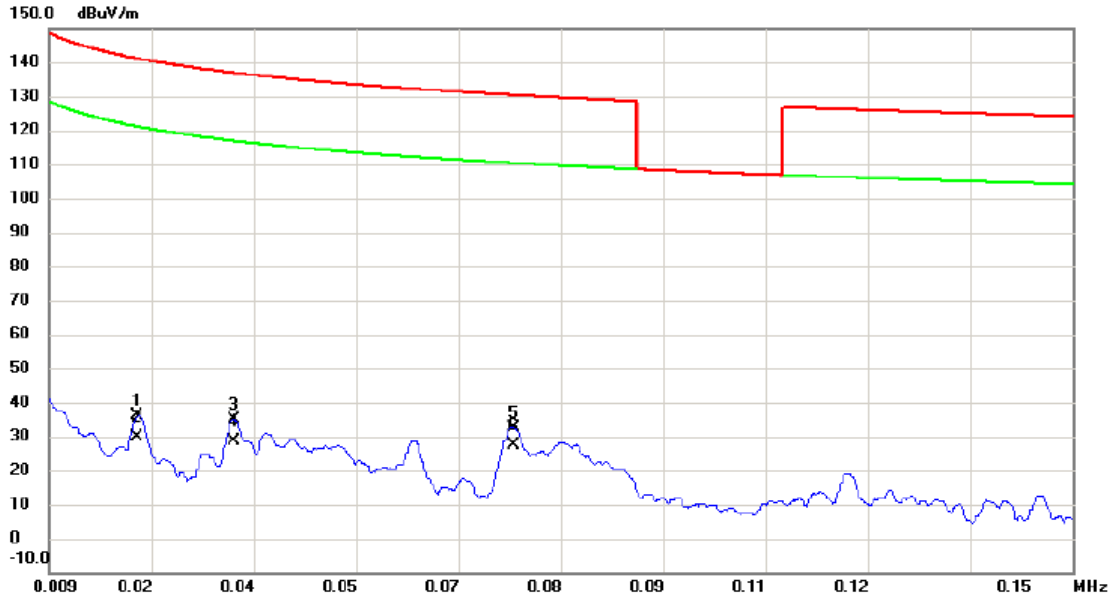

No.	Mk.	Freq. MHz	Reading Level dBuV	Correct Factor dB	Measure- ment dBuV/m	Limit dBuV/m	Margin dB	Detector	Comment
1		0.0212	12.73	23.37	36.10	141.08	-104.98	peak	
2		0.0212	6.43	23.37	29.80	121.08	-91.28	AVG	
3		0.0345	13.43	21.73	35.16	136.85	-101.69	peak	
4		0.0345	6.73	21.73	28.46	116.85	-88.39	AVG	
5		0.0730	12.97	19.55	32.52	130.34	-97.82	peak	
6	*	0.0730	7.79	19.55	27.34	110.34	-83.00	AVG	

Test Mode: TX MODE CHANNEL 01_ Adapter:MU12AR120100-A1

Ant 0°

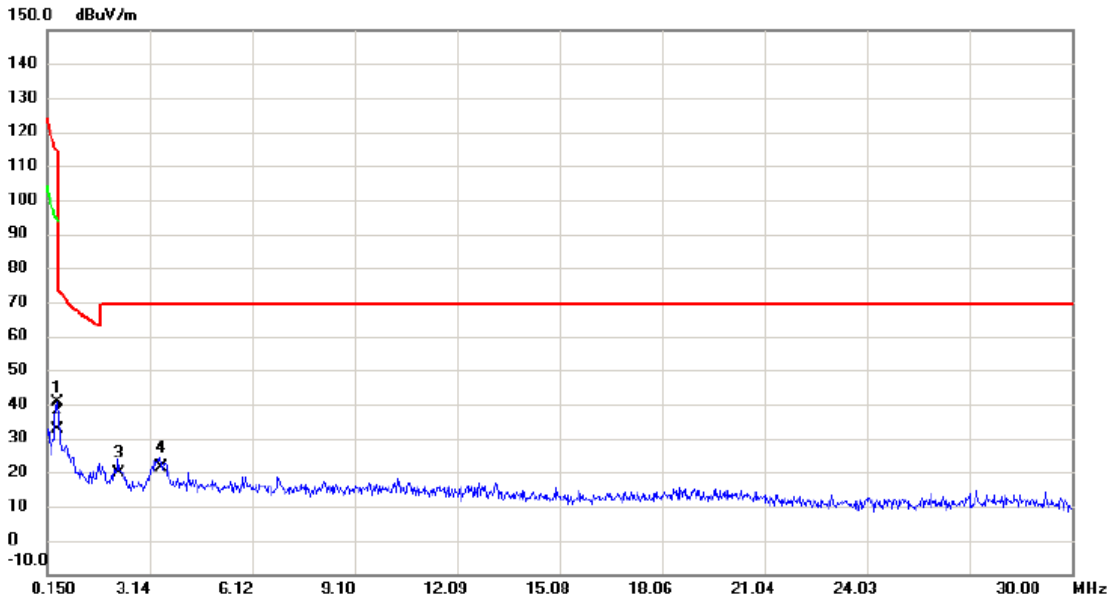

No.	Mk.	Freq. MHz	Reading Level dBuV	Correct Factor dB	Measure- ment dBuV/m	Limit dBuV/m	Margin dB	Detector	Comment
1		0.4633	22.35	18.41	40.76	114.29	-73.53	peak	
2		0.4633	14.36	18.41	32.77	94.29	-61.52	AVG	
3		2.2244	2.23	17.62	19.85	69.54	-49.69	QP	
4	*	3.4632	3.78	17.61	21.39	69.54	-48.15	QP	

Test Mode: TX MODE CHANNEL 01_ Adapter:MU12AR120100-A1

Ant 90°

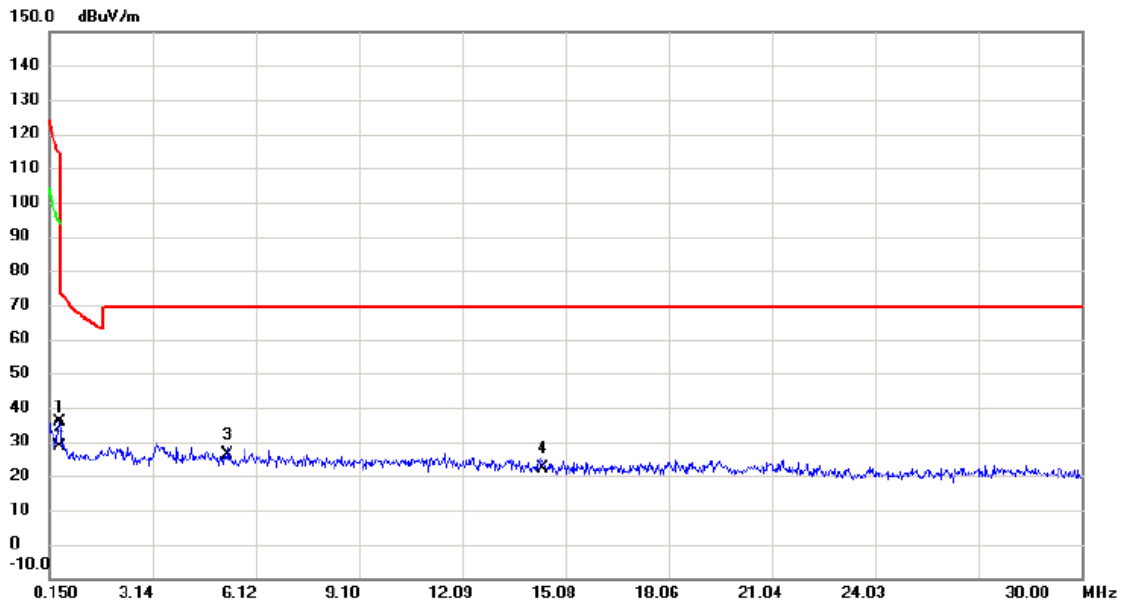

No.	Mk.	Freq. MHz	Reading Level dBuV	Correct Factor dB	Measure- ment dBuV/m	Limit dBuV/m	Margin dB	Detector	Comment
1		0.4634	17.25	18.41	35.66	114.28	-78.62	peak	
2		0.4634	10.09	18.41	28.50	94.28	-65.78	AVG	
3	*	5.3140	9.49	16.62	26.11	69.54	-43.43	QP	
4		14.4034	6.55	15.71	22.26	69.54	-47.28	QP	

Test Mode: TX MODE CHANNEL 01 _ Adapter:MU12AR120100-A1

Ant 90°

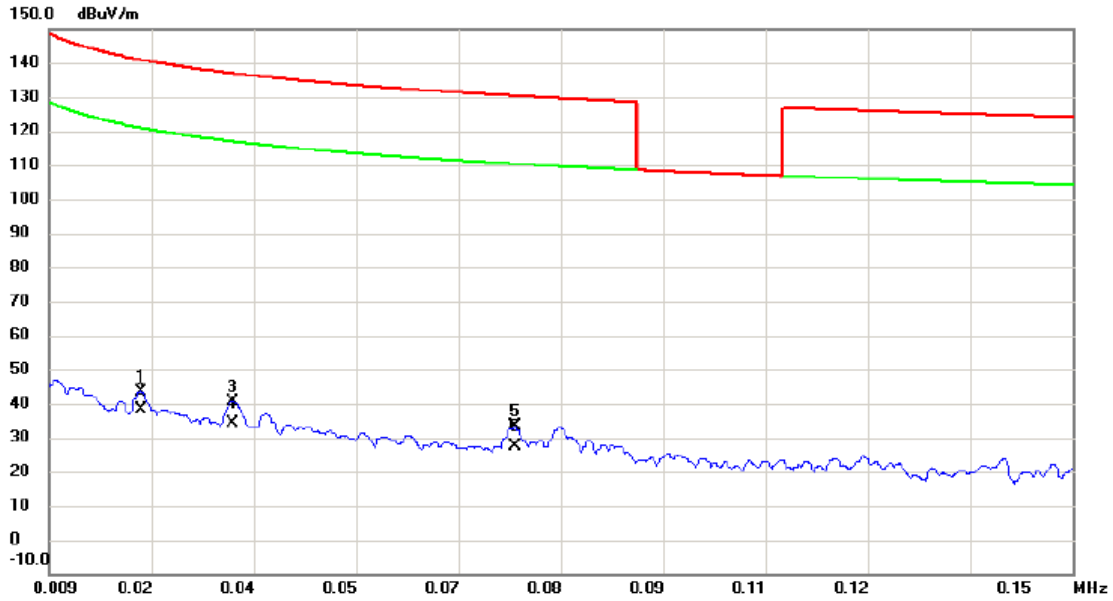

No.	Mk.	Freq. MHz	Reading Level dBuV	Correct Factor dB	Measure- ment dBuV/m	Limit dBuV/m	Margin dB	Detector	Comment
1		0.0217	20.29	23.31	43.60	140.88	-97.28	peak	
2	*	0.0217	14.83	23.31	38.14	120.88	-82.74	AVG	
3		0.0343	18.72	21.76	40.48	136.90	-96.42	peak	
4		0.0343	12.40	21.76	34.16	116.90	-82.74	AVG	
5		0.0732	13.67	19.55	33.22	130.31	-97.09	peak	
6		0.0732	7.71	19.55	27.26	110.31	-83.05	AVG	

ATTACHMENTC -RADIATED EMISSION (30MHZ TO 1000MHZ)

Test Mode: UNII-1/TX A Mode 5180MHz_Adapter: 2AAJ012F US

Vertical

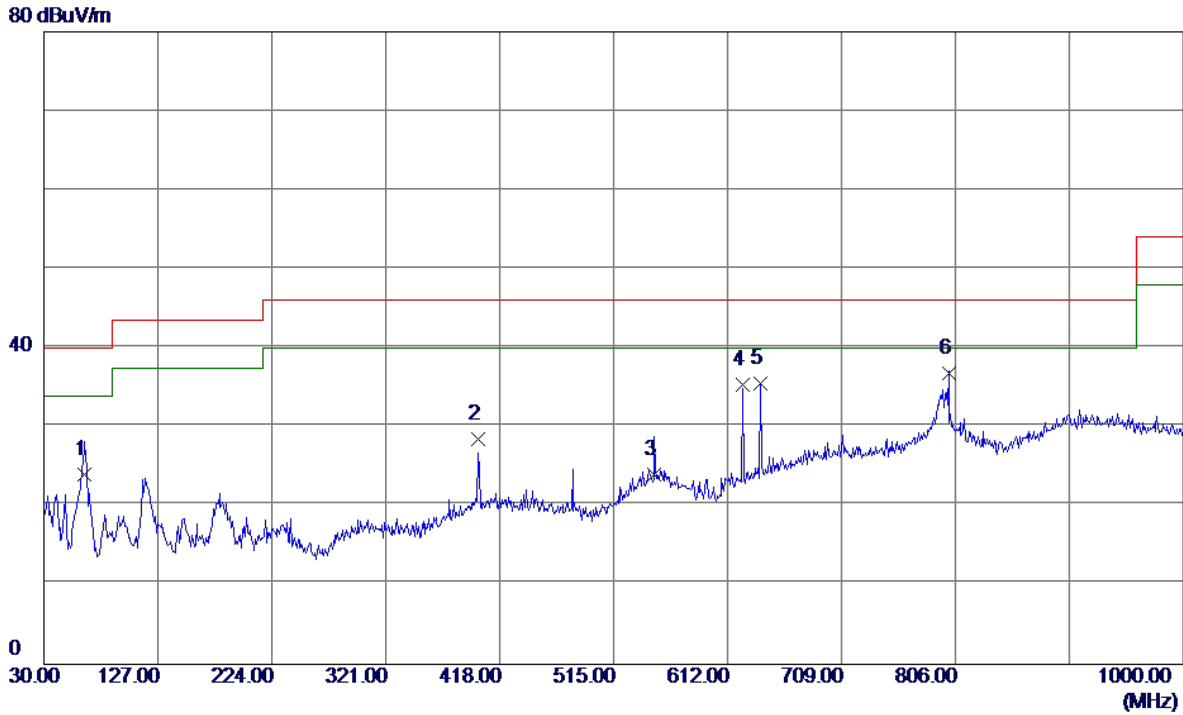

No.	Freq. MHz	Reading Level dBuV/m	Correct Factor dB	Measure ment dBuV/m	Limit dBuV/m	Margin dB	Detector	Comment
1	64.9200	39.15	-15.15	24.00	40.00	-16.00	QP	
2	399.5700	36.24	-7.81	28.43	46.00	-17.57	QP	
3	549.9200	28.54	-4.55	23.99	46.00	-22.01	QP	
4	624.6100	40.97	-5.64	35.33	46.00	-10.67	QP	
5	640.1300	40.24	-4.75	35.49	46.00	-10.51	QP	
6 *	800.1800	36.54	0.25	36.79	46.00	-9.21	QP	

Test Mode: UNII-1/TX A Mode 5180MHz_Adapter: 2AAJ012F US

Horizontal

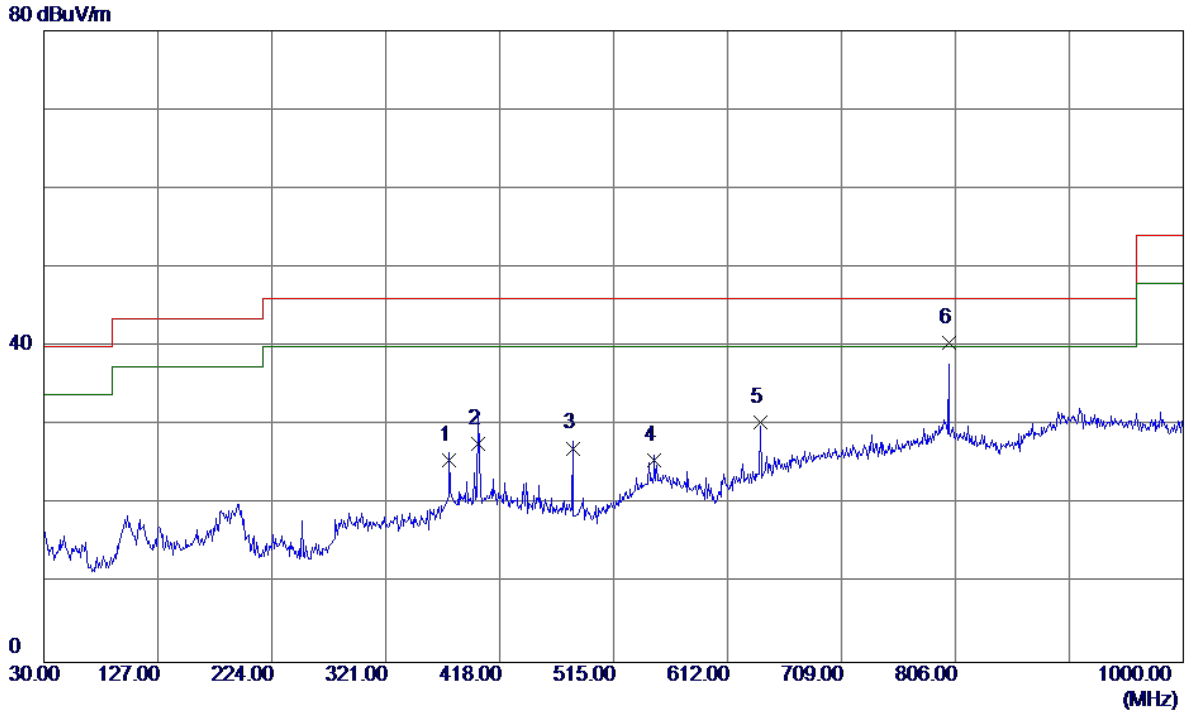

No.	Freq. MHz	Reading Level dBuV/m	Correct Factor dB	Measure ment dBuV/m	Limit dBuV/m	Margin dB	Detector	Comment
1	375.3200	35.14	-9.48	25.66	46.00	-20.34	QP	
2	399.5700	35.49	-7.81	27.68	46.00	-18.32	QP	
3	480.0800	36.15	-9.03	27.12	46.00	-18.88	QP	
4	549.9200	30.21	-4.55	25.66	46.00	-20.34	QP	
5	640.1300	35.15	-4.75	30.40	46.00	-15.60	QP	
6 *	800.1800	40.16	0.25	40.41	46.00	-5.59	QP	

Test Mode: UNII-1/TX A Mode 5200MHz_Adapter: 2AAJ012F US

Vertical

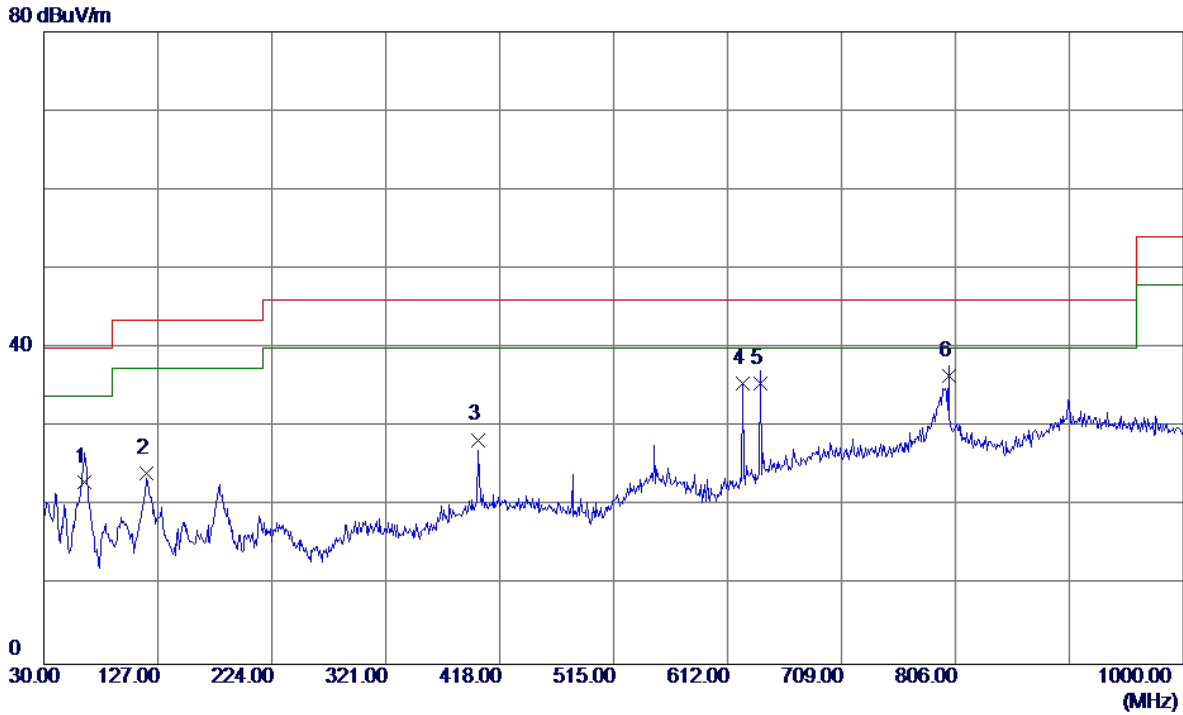

No.	Freq. MHz	Reading Level dBuV/m	Correct Factor dB	Measure ment dBuV/m	Limit dBuV/m	Margin dB	Detector	Comment
1	64.9200	38.23	-15.15	23.08	40.00	-16.92	QP	
2	117.3000	37.89	-13.78	24.11	43.50	-19.39	QP	
3	399.5700	36.21	-7.81	28.40	46.00	-17.60	QP	
4	624.6100	41.11	-5.64	35.47	46.00	-10.53	QP	
5	640.1300	40.27	-4.75	35.52	46.00	-10.48	QP	
6 *	800.1800	36.25	0.25	36.50	46.00	-9.50	QP	

Test Mode: UNII-1/TX A Mode 5200MHz_Adapter: 2AAJ012F US

Horizontal

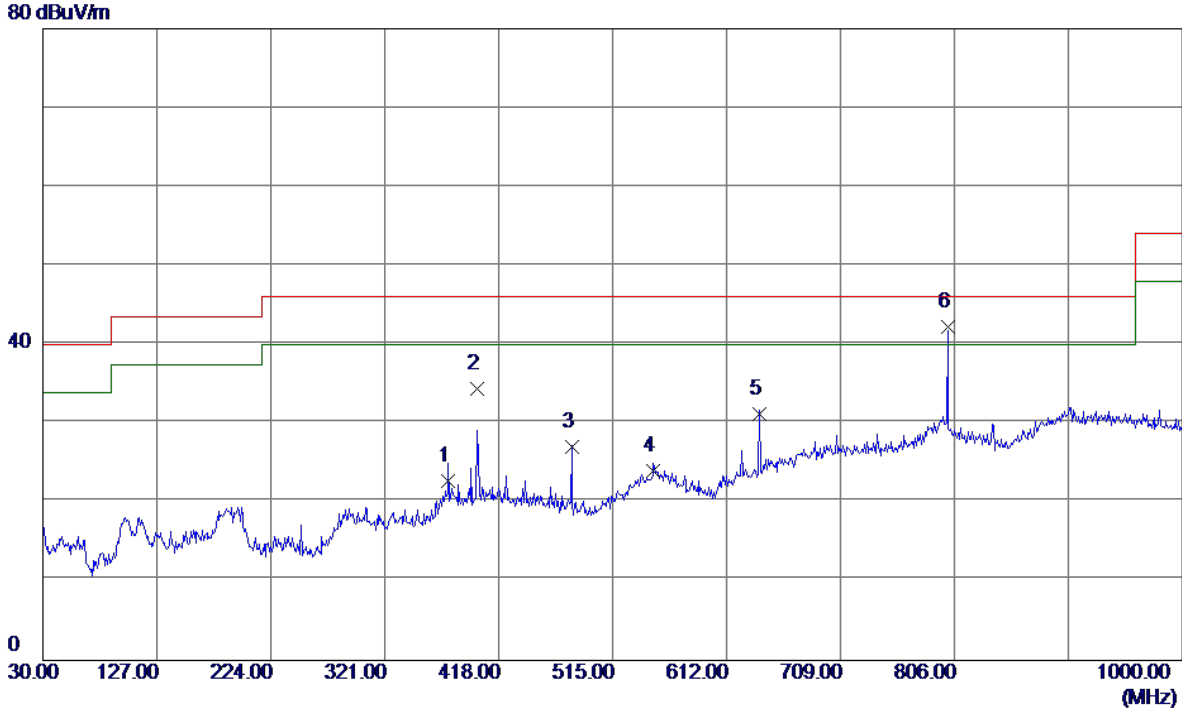

No.	Freq. MHz	Reading Level dBuV/m	Correct Factor dB	Measure ment dBuV/m	Limit dBuV/m	Margin dB	Detector	Comment
1	375.3200	32.19	-9.48	22.71	46.00	-23.29	QP	
2	399.5700	42.15	-7.81	34.34	46.00	-11.66	QP	
3	480.0800	36.03	-9.03	27.00	46.00	-19.00	QP	
4	549.9200	28.57	-4.55	24.02	46.00	-21.98	QP	
5	640.1300	35.88	-4.75	31.13	46.00	-14.87	QP	
6 *	800.1800	41.95	0.25	42.20	46.00	-3.80	QP	

Test Mode: UNII-1/TX A Mode 5240MHz_Adapter: 2AAJ012F US

Vertical

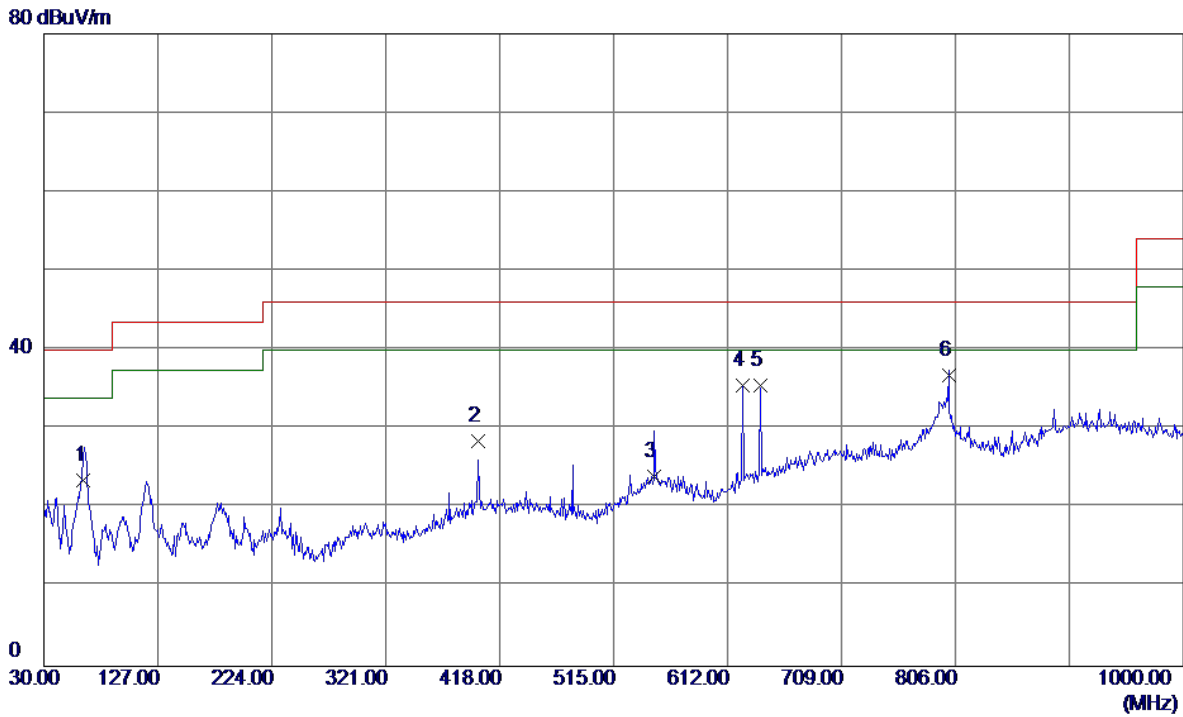

No.	Freq. MHz	Reading Level dBuV/m	Correct Factor dB	Measure ment dBuV/m	Limit dBuV/m	Margin dB	Detector	Comment
1	63.9500	38.36	-14.87	23.49	40.00	-16.51	QP	
2	399.5700	36.28	-7.81	28.47	46.00	-17.53	QP	
3	549.9200	28.57	-4.55	24.02	46.00	-21.98	QP	
4	624.6100	41.17	-5.64	35.53	46.00	-10.47	QP	
5	640.1300	40.27	-4.75	35.52	46.00	-10.48	QP	
6 *	800.1800	36.51	0.25	36.76	46.00	-9.24	QP	

Test Mode: UNII-1/TX A Mode 5240MHz_Adapter: 2AAJ012F US

Horizontal

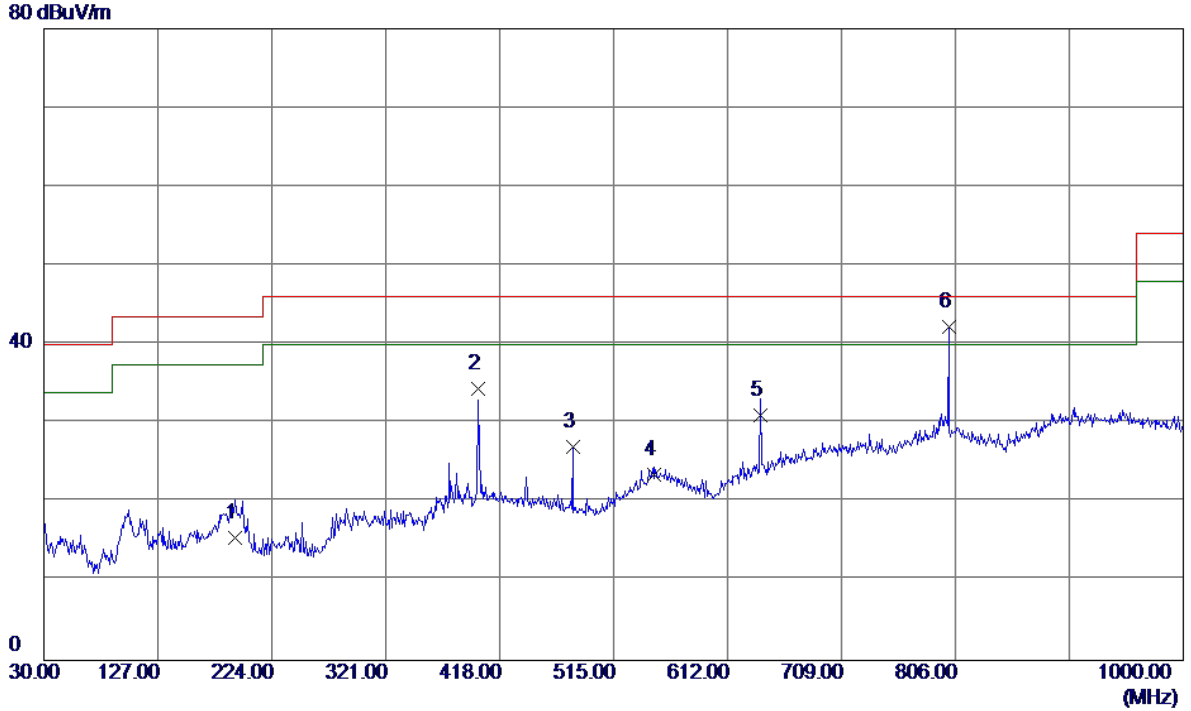

No.	Freq. MHz	Reading Level dBuV/m	Correct Factor dB	Measure ment dBuV/m	Limit dBuV/m	Margin dB	Detector	Comment
1	192.9600	29.57	-14.08	15.49	43.50	-28.01	QP	
2	399.5700	42.18	-7.81	34.37	46.00	-11.63	QP	
3	480.0800	36.08	-9.03	27.05	46.00	-18.95	QP	
4	549.9200	28.14	-4.55	23.59	46.00	-22.41	QP	
5	640.1300	35.85	-4.75	31.10	46.00	-14.90	QP	
6 *	800.1800	41.95	0.25	42.20	46.00	-3.80	QP	

Test Mode: UNII-3/TX A Mode 5745MHz_Adapter: 2AAJ012F US

Vertical

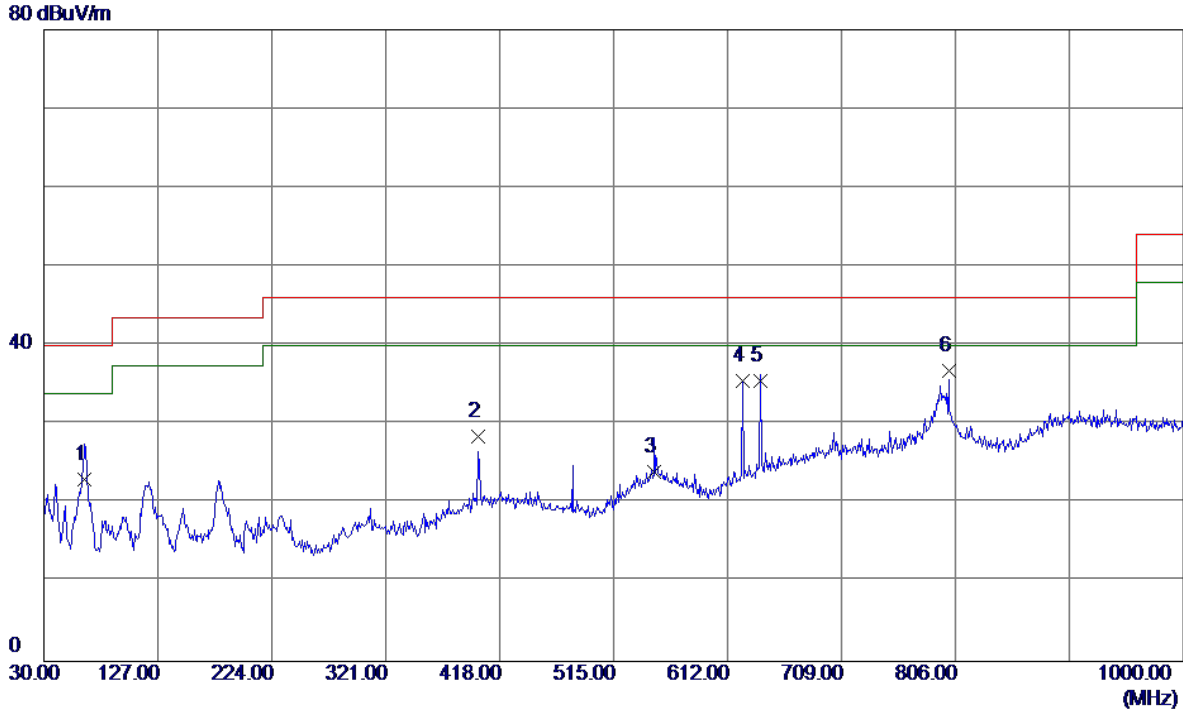

No.	Freq. MHz	Reading Level dBuV/m	Correct Factor dB	Measure ment dBuV/m	Limit dBuV/m	Margin dB	Detector	Comment
1	64.9200	38.24	-15.15	23.09	40.00	-16.91	QP	
2	399.5700	36.27	-7.81	28.46	46.00	-17.54	QP	
3	549.9200	28.49	-4.55	23.94	46.00	-22.06	QP	
4	624.6100	41.18	-5.64	35.54	46.00	-10.46	QP	
5	640.1300	40.27	-4.75	35.52	46.00	-10.48	QP	
6 *	800.1800	36.54	0.25	36.79	46.00	-9.21	QP	

Test Mode: UNII-3/TX A Mode 5745MHz_Adapter: 2AAJ012F US

Horizontal

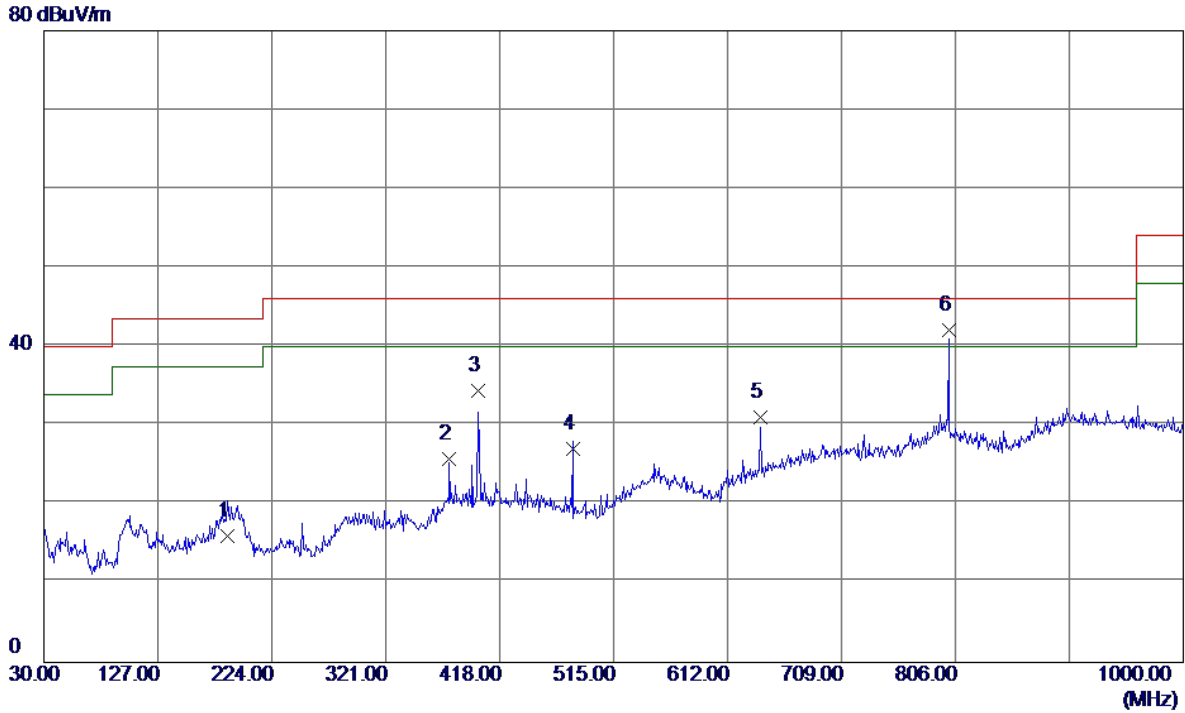

No.	Freq. MHz	Reading Level dBuV/m	Correct Factor dB	Measure ment dBuV/m	Limit dBuV/m	Margin dB	Detector	Comment
1	186.1700	29.47	-13.51	15.96	43.50	-27.54	QP	
2	375.3200	35.19	-9.48	25.71	46.00	-20.29	QP	
3	399.5700	42.19	-7.81	34.38	46.00	-11.62	QP	
4	480.0800	36.05	-9.03	27.02	46.00	-18.98	QP	
5	640.1300	35.85	-4.75	31.10	46.00	-14.90	QP	
6 *	800.1800	41.87	0.25	42.12	46.00	-3.88	QP	

Test Mode: UNII-3/TX A Mode 5785MHz_Adapter: 2AAJ012F US

Vertical

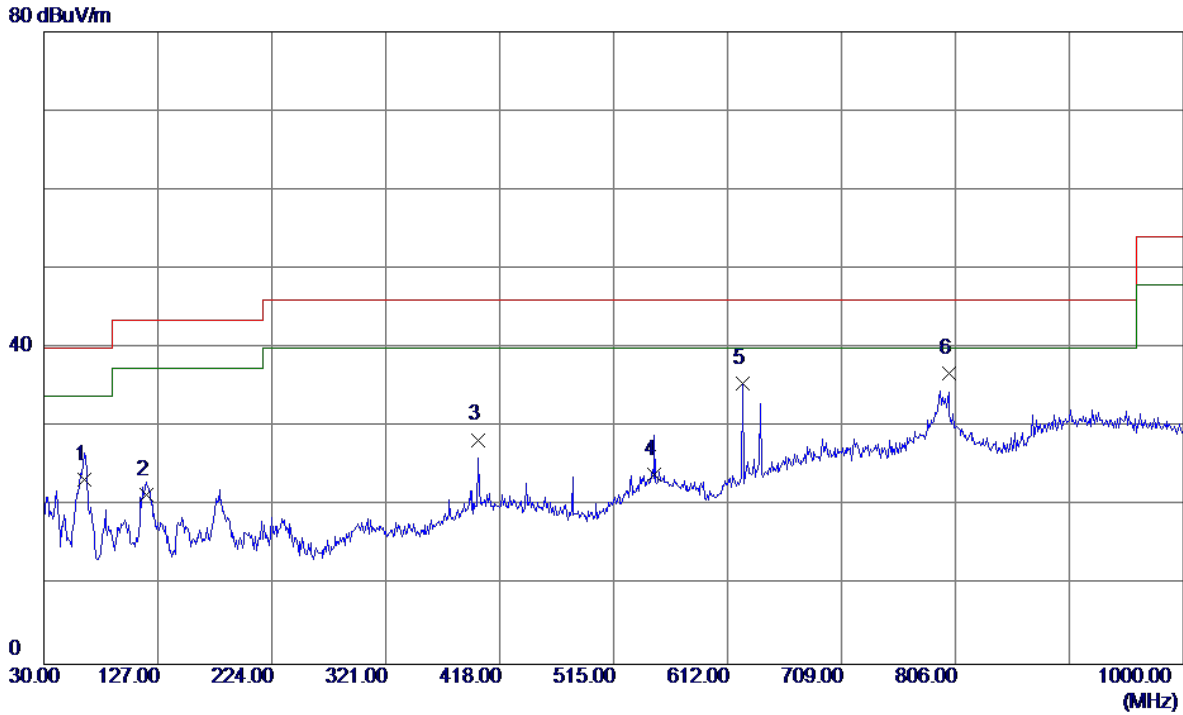

No.	Freq. MHz	Reading Level dBuV/m	Correct Factor dB	Measure ment dBuV/m	Limit dBuV/m	Margin dB	Detector	Comment
1	64.9200	38.50	-15.15	23.35	40.00	-16.65	QP	
2	117.3000	35.19	-13.78	21.41	43.50	-22.09	QP	
3	399.5700	36.21	-7.81	28.40	46.00	-17.60	QP	
4	549.9200	28.54	-4.55	23.99	46.00	-22.01	QP	
5	624.6100	41.14	-5.64	35.50	46.00	-10.50	QP	
6 *	800.1800	36.54	0.25	36.79	46.00	-9.21	QP	

Test Mode: UNII-3/TX A Mode 5785MHz_Adapter: 2AAJ012F US

Horizontal

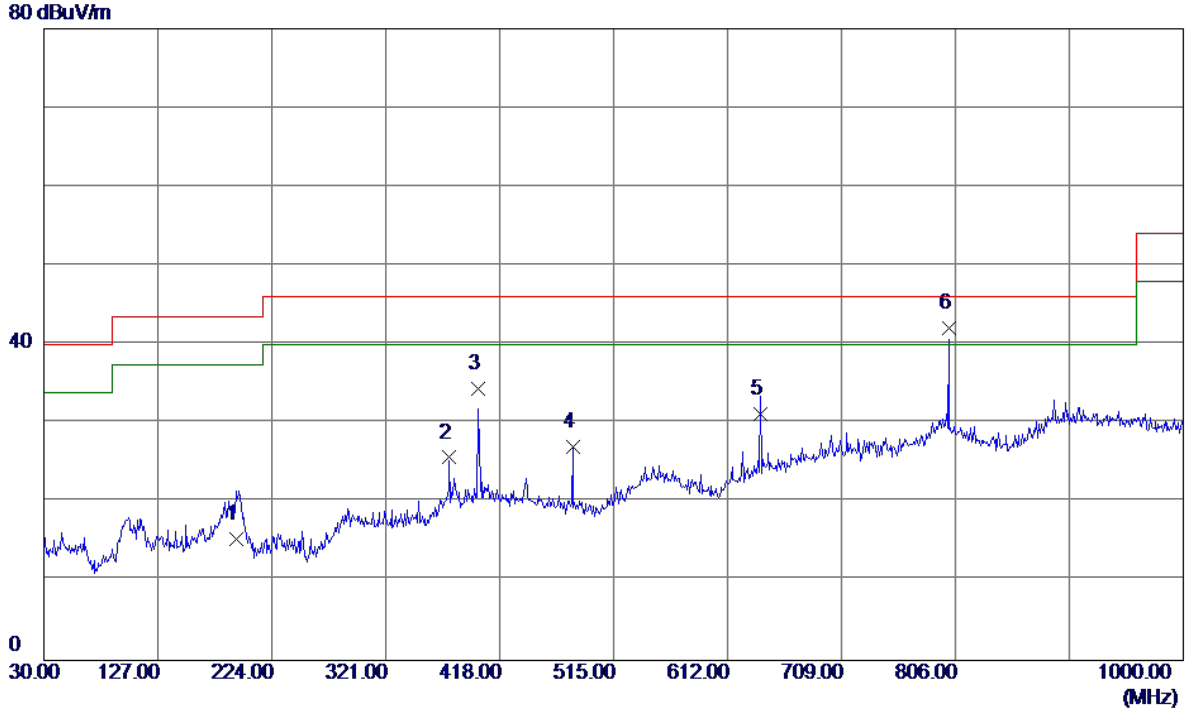

No.	Freq. MHz	Reading Level dBuV/m	Correct Factor dB	Measure ment dBuV/m	Limit dBuV/m	Margin dB	Detector	Comment
1	193.9299	29.49	-14.13	15.36	43.50	-28.14	QP	
2	375.3200	35.16	-9.48	25.68	46.00	-20.32	QP	
3	399.5700	42.18	-7.81	34.37	46.00	-11.63	QP	
4	480.0800	36.05	-9.03	27.02	46.00	-18.98	QP	
5	640.1300	35.88	-4.75	31.13	46.00	-14.87	QP	
6 *	800.1800	41.84	0.25	42.09	46.00	-3.91	QP	

Test Mode: UNII-3/TX A Mode 5825MHz_Adapter: 2AAJ012F US

Vertical

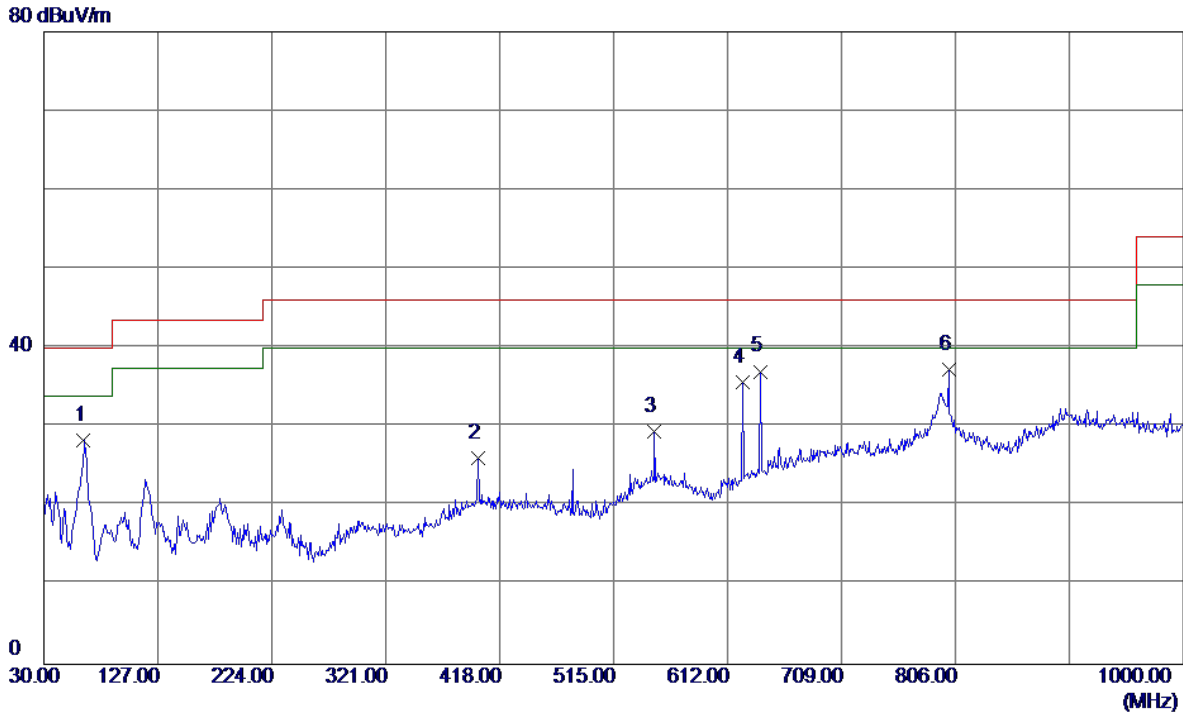

No.	Freq. MHz	Reading Level dBuV/m	Correct Factor dB	Measure ment dBuV/m	Limit dBuV/m	Margin dB	Detector	Comment
1	63.9500	43.16	-14.87	28.29	40.00	-11.71	QP	
2	399.5700	33.96	-7.81	26.15	46.00	-19.85	QP	
3	549.9200	33.92	-4.55	29.37	46.00	-16.63	QP	
4	624.6100	41.29	-5.64	35.65	46.00	-10.35	QP	
5	640.1300	41.79	-4.75	37.04	46.00	-8.96	QP	
6 *	800.1800	37.03	0.25	37.28	46.00	-8.72	QP	

Test Mode: UNII-3/TX A Mode 5825MHz_Adapter: 2AAJ012F US

Horizontal

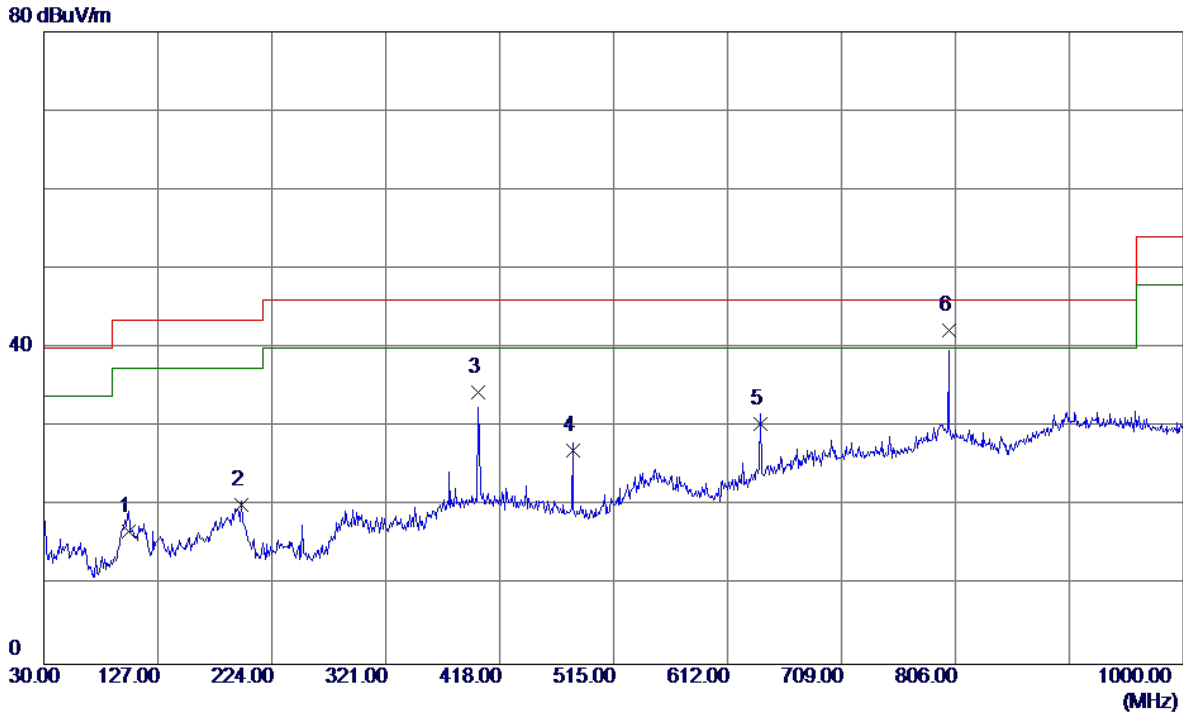

No.	Freq. MHz	Reading Level dBuV/m	Correct Factor dB	Measure ment dBuV/m	Limit dBuV/m	Margin dB	Detector	Comment
1	101.7800	32.19	-15.32	16.87	43.50	-26.63	QP	
2	197.8100	34.52	-14.32	20.20	43.50	-23.30	QP	
3	399.5700	42.15	-7.81	34.34	46.00	-11.66	QP	
4	480.0800	36.10	-9.03	27.07	46.00	-18.93	QP	
5	640.1300	35.20	-4.75	30.45	46.00	-15.55	QP	
6 *	800.1800	41.96	0.25	42.21	46.00	-3.79	QP	

Test Mode: UNII-1/TX A Mode 5180MHz_ Adapter:MU12AR120100-A1

Vertical

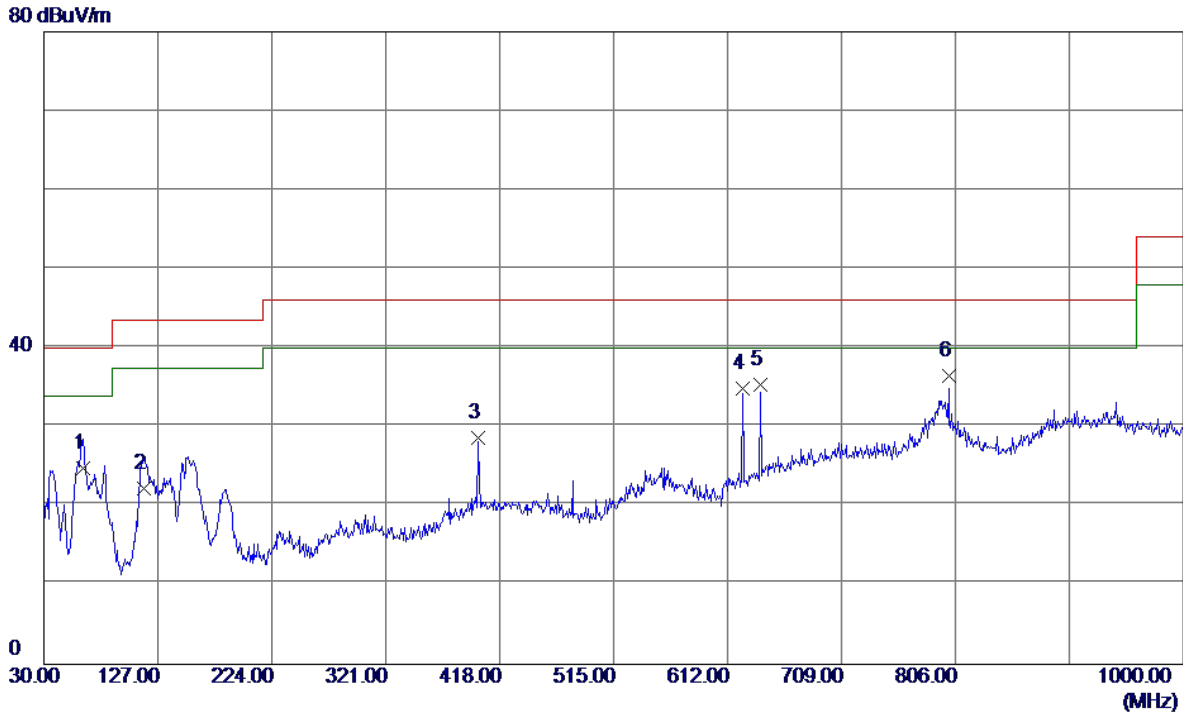

No.	Freq. MHz	Reading Level dBuV/m	Correct Factor dB	Measure ment dBuV/m	Limit dBuV/m	Margin dB	Detector	Comment
1	62.9800	39.32	-14.58	24.74	40.00	-15.26	QP	
2	115.3600	36.25	-14.01	22.24	43.50	-21.26	QP	
3	399.5700	36.45	-7.81	28.64	46.00	-17.36	QP	
4	624.6100	40.58	-5.64	34.94	46.00	-11.06	QP	
5	640.1300	40.06	-4.75	35.31	46.00	-10.69	QP	
6 *	800.1800	36.25	0.25	36.50	46.00	-9.50	QP	

Test Mode: UNII-1/TX A Mode 5180MHz_ Adapter:MU12AR120100-A1

Horizontal

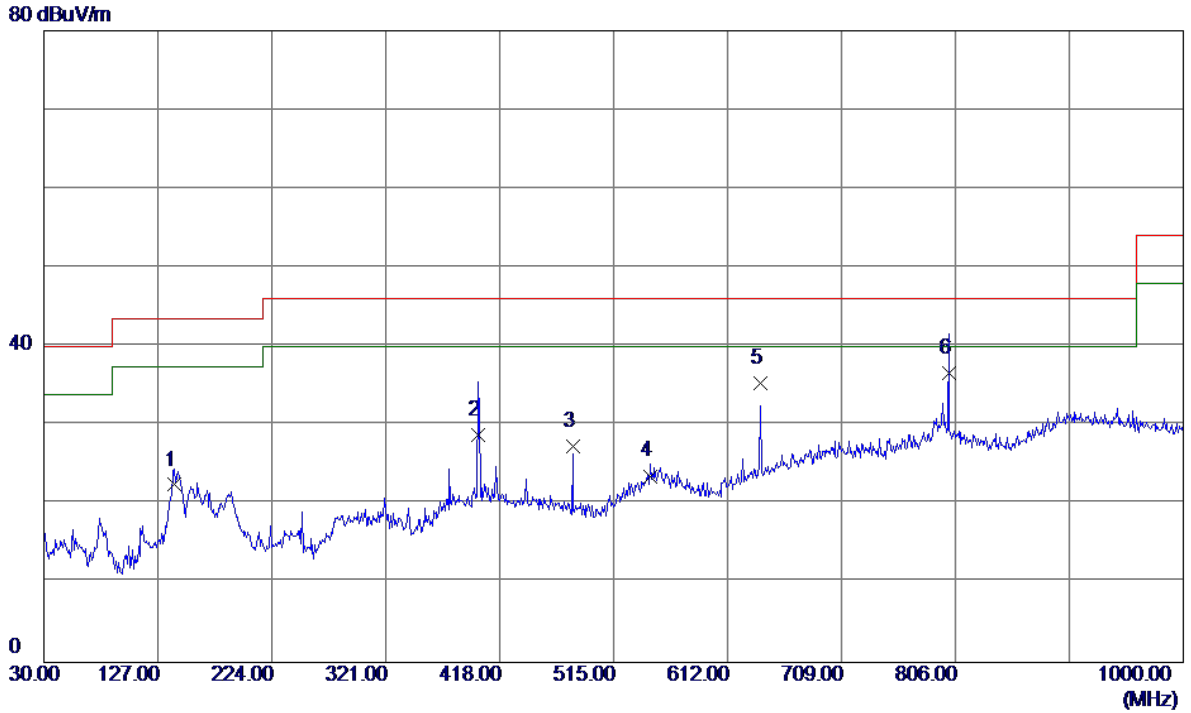

No.	Freq. MHz	Reading Level dBuV/m	Correct Factor dB	Measure ment dBuV/m	Limit dBuV/m	Margin dB	Detector	Comment
1	140.5800	36.19	-13.71	22.48	43.50	-21.02	QP	
2	399.5700	36.58	-7.81	28.77	46.00	-17.23	QP	
3	480.0800	36.43	-9.03	27.40	46.00	-18.60	QP	
4	546.0400	28.55	-4.95	23.60	46.00	-22.40	QP	
5	640.1300	40.06	-4.75	35.31	46.00	-10.69	QP	
6 *	800.1800	36.43	0.25	36.68	46.00	-9.32	QP	

Test Mode: UNII-1/TX A Mode 5200MHz_ Adapter:MU12AR120100-A1

Vertical

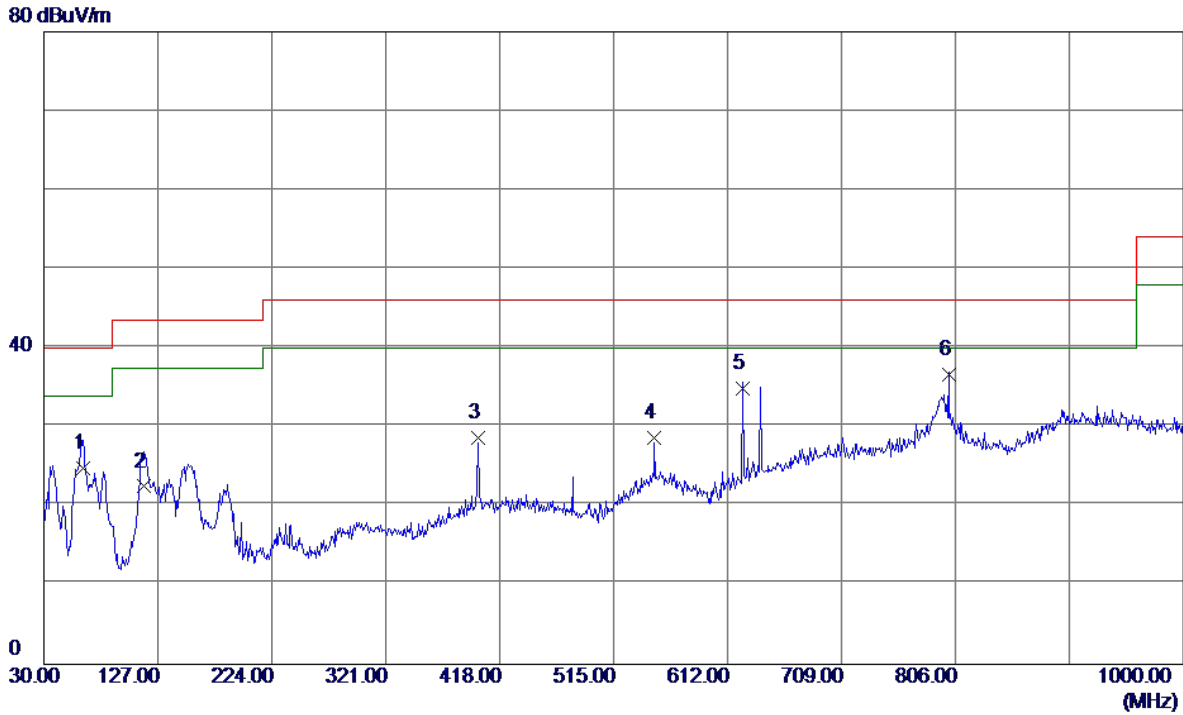

No.	Freq. MHz	Reading Level dBuV/m	Correct Factor dB	Measure ment dBuV/m	Limit dBuV/m	Margin dB	Detector	Comment
1	62.9800	39.35	-14.58	24.77	40.00	-15.23	QP	
2	115.3600	36.49	-14.01	22.48	43.50	-21.02	QP	
3	399.5700	36.47	-7.81	28.66	46.00	-17.34	QP	
4	549.9200	33.16	-4.55	28.61	46.00	-17.39	QP	
5	624.6100	40.58	-5.64	34.94	46.00	-11.06	QP	
6 *	800.1800	36.45	0.25	36.70	46.00	-9.30	QP	

Test Mode: UNII-1/TX A Mode 5200MHz_ Adapter:MU12AR120100-A1

Horizontal

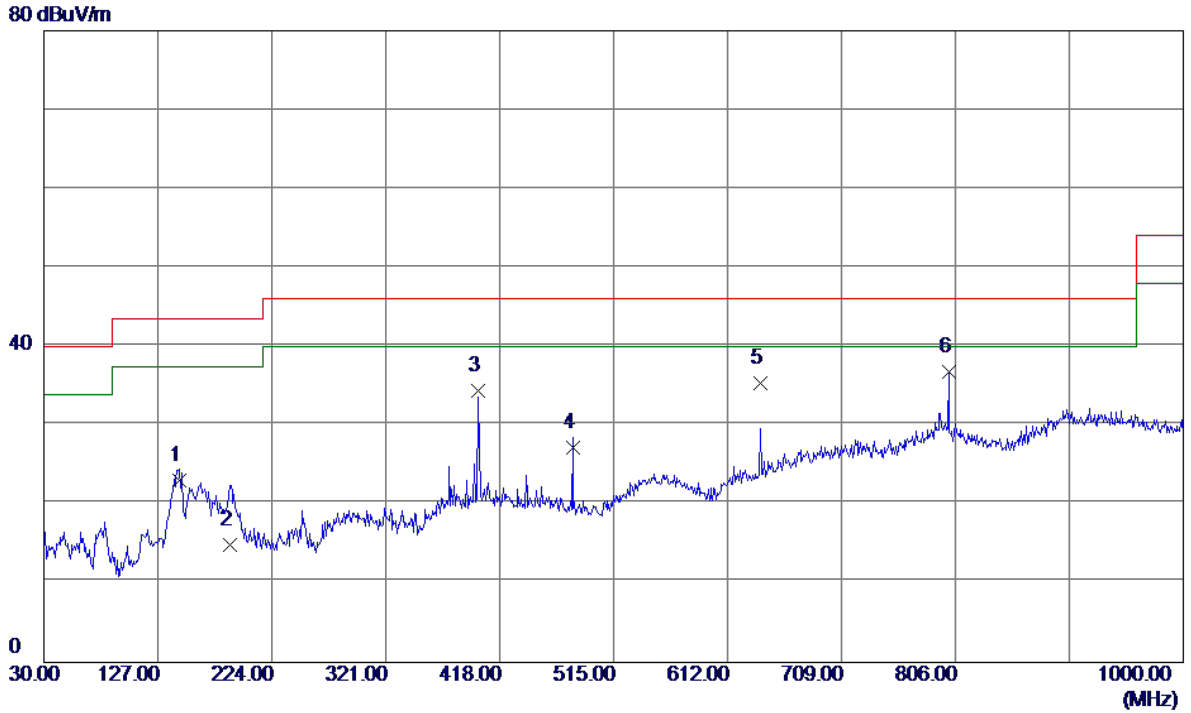

No.	Freq. MHz	Reading Level dBuV/m	Correct Factor dB	Measure ment dBuV/m	Limit dBuV/m	Margin dB	Detector	Comment
1	145.4299	36.41	-13.32	23.09	43.50	-20.41	QP	
2	188.1100	28.65	-13.73	14.92	43.50	-28.58	QP	
3	399.5700	42.16	-7.81	34.35	46.00	-11.65	QP	
4	480.0800	36.19	-9.03	27.16	46.00	-18.84	QP	
5	640.1300	40.07	-4.75	35.32	46.00	-10.68	QP	
6 *	800.1800	36.54	0.25	36.79	46.00	-9.21	QP	

Test Mode: UNII-1/TX A Mode 5240MHz_ Adapter:MU12AR120100-A1

Vertical

80 dBuV/m

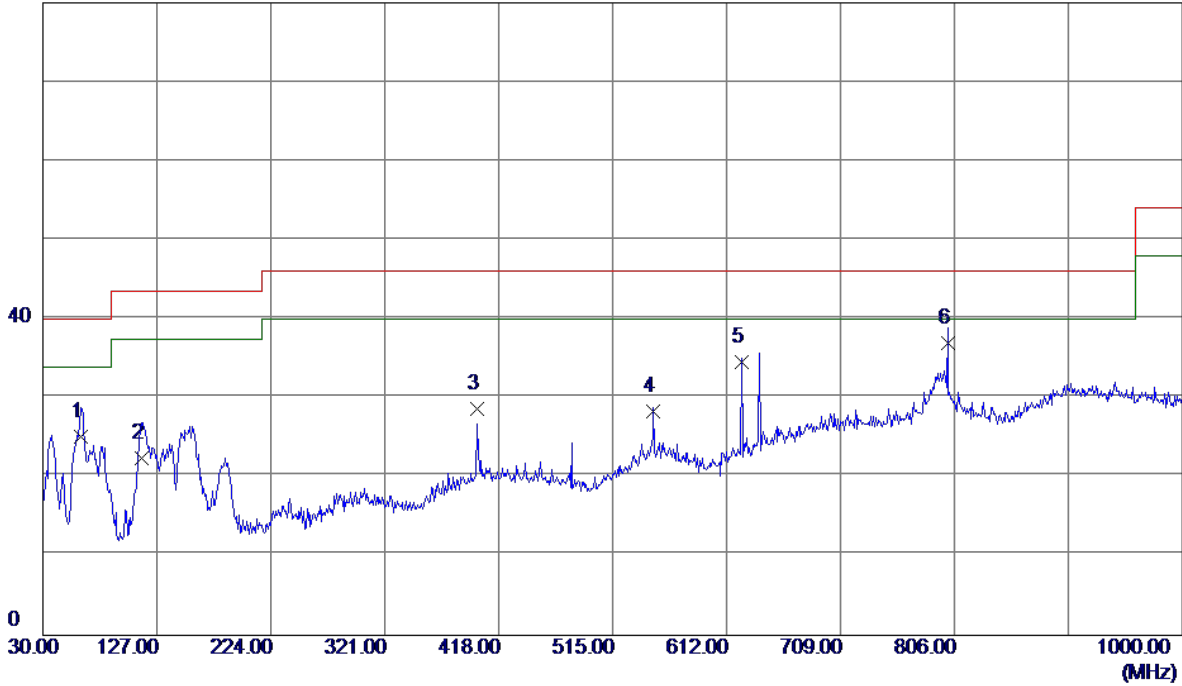

No.	Freq. MHz	Reading Level dBuV/m	Correct Factor dB	Measure ment dBuV/m	Limit dBuV/m	Margin dB	Detector	Comment
1	62.0100	39.48	-14.30	25.18	40.00	-14.82	QP	
2	114.3900	36.51	-14.13	22.38	43.50	-21.12	QP	
3	399.5700	36.49	-7.81	28.68	46.00	-17.32	QP	
4	549.9200	32.89	-4.55	28.34	46.00	-17.66	QP	
5	624.6100	40.18	-5.64	34.54	46.00	-11.46	QP	
6 *	800.1800	36.74	0.25	36.99	46.00	-9.01	QP	

Test Mode: UNII-1/TX A Mode 5240MHz_ Adapter:MU12AR120100-A1

Horizontal

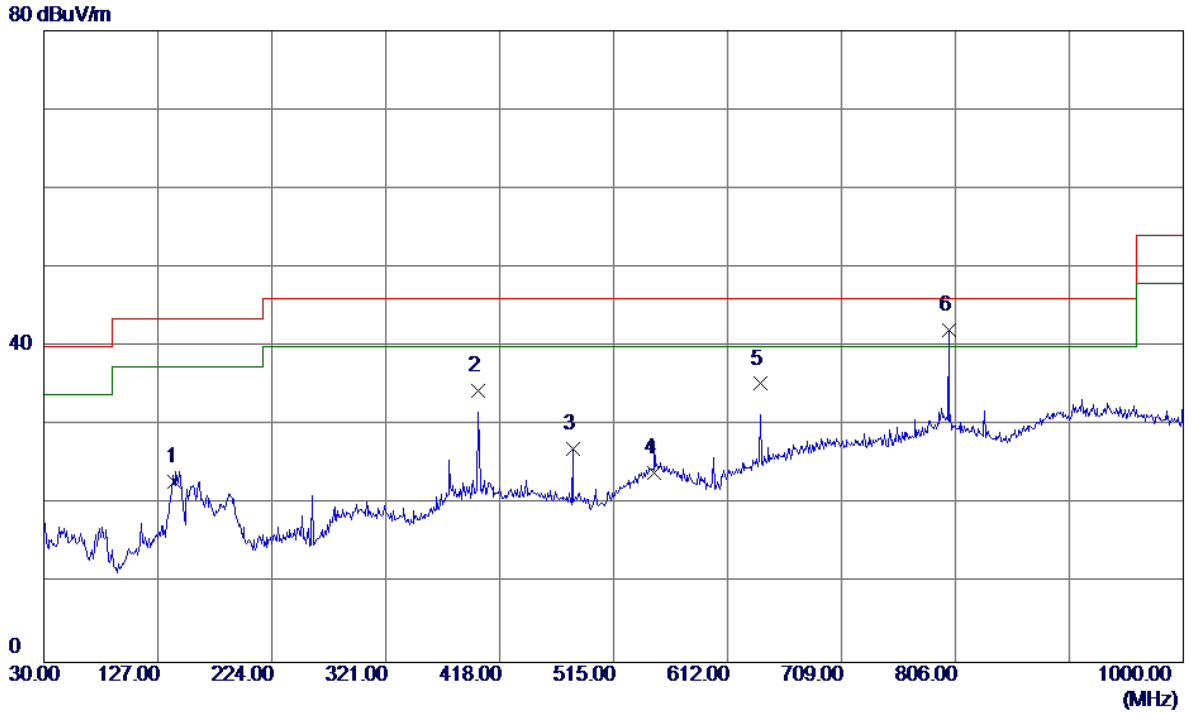

No.	Freq. MHz	Reading Level dBuV/m	Correct Factor dB	Measure ment dBuV/m	Limit dBuV/m	Margin dB	Detector	Comment
1	141.5500	36.49	-13.63	22.86	43.50	-20.64	QP	
2	399.5700	42.19	-7.81	34.38	46.00	-11.62	QP	
3	480.0800	36.05	-9.03	27.02	46.00	-18.98	QP	
4	549.9200	28.49	-4.55	23.94	46.00	-22.06	QP	
5	640.1300	40.03	-4.75	35.28	46.00	-10.72	QP	
6 *	800.1800	41.82	0.25	42.07	46.00	-3.93	QP	

Test Mode: UNII-3/TX A Mode 5745MHz_ Adapter:MU12AR120100-A1

Vertical

80 dBuV/m

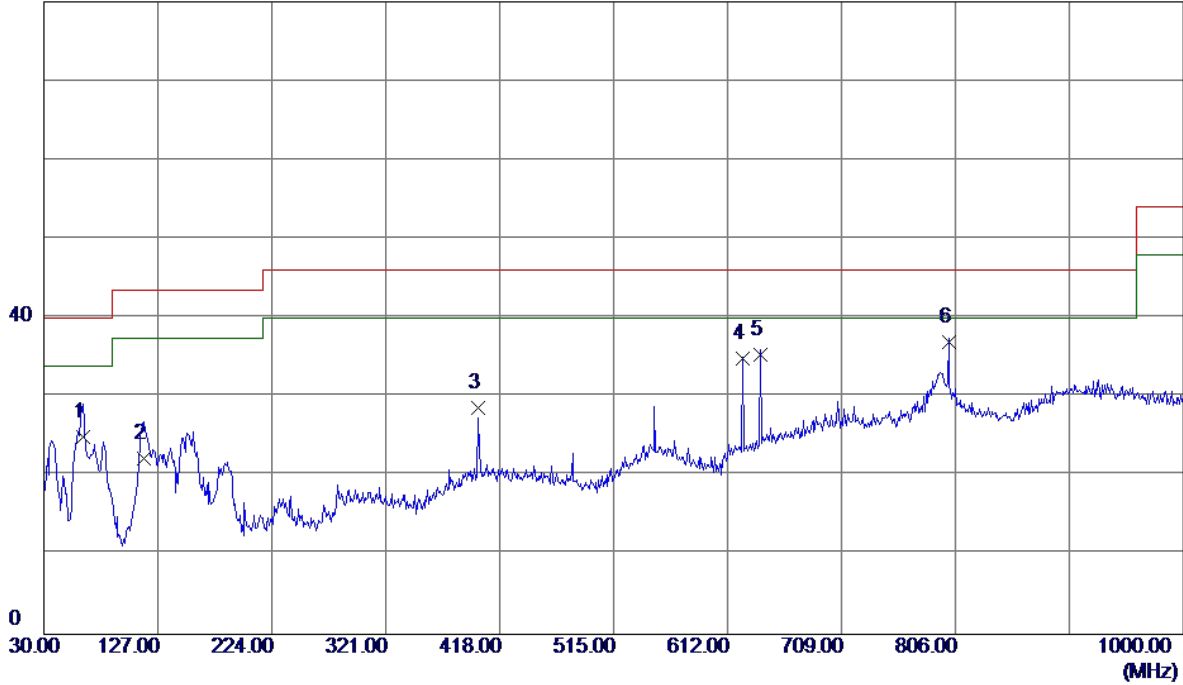

No.	Freq. MHz	Reading Level dBuV/m	Correct Factor dB	Measure ment dBuV/m	Limit dBuV/m	Margin dB	Detector	Comment
1	62.9800	39.48	-14.58	24.90	40.00	-15.10	QP	
2	115.3600	36.25	-14.01	22.24	43.50	-21.26	QP	
3	399.5700	36.49	-7.81	28.68	46.00	-17.32	QP	
4	624.6100	40.56	-5.64	34.92	46.00	-11.08	QP	
5	640.1300	40.16	-4.75	35.41	46.00	-10.59	QP	
6 *	800.1800	36.74	0.25	36.99	46.00	-9.01	QP	

Test Mode: UNII-3/TX A Mode 5745MHz_ Adapter:MU12AR120100-A1

Horizontal

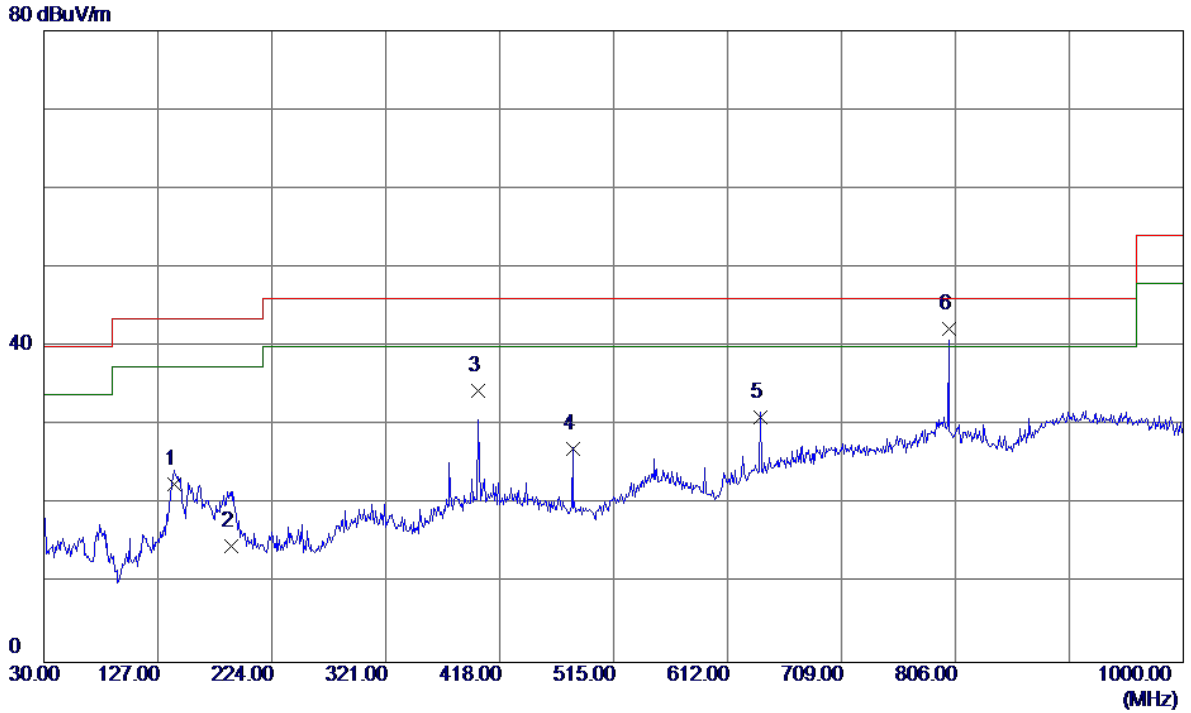

No.	Freq. MHz	Reading Level dBuV/m	Correct Factor dB	Measure ment dBuV/m	Limit dBuV/m	Margin dB	Detector	Comment
1	140.5800	36.25	-13.71	22.54	43.50	-20.96	QP	
2	189.0800	28.61	-13.83	14.78	43.50	-28.72	QP	
3	399.5700	42.16	-7.81	34.35	46.00	-11.65	QP	
4	480.0800	36.04	-9.03	27.01	46.00	-18.99	QP	
5	640.1300	35.85	-4.75	31.10	46.00	-14.90	QP	
6 *	800.1800	41.92	0.25	42.17	46.00	-3.83	QP	

Test Mode: UNII-3/TX A Mode 5785MHz_ Adapter:MU12AR120100-A1

Vertical

80 dBuV/m

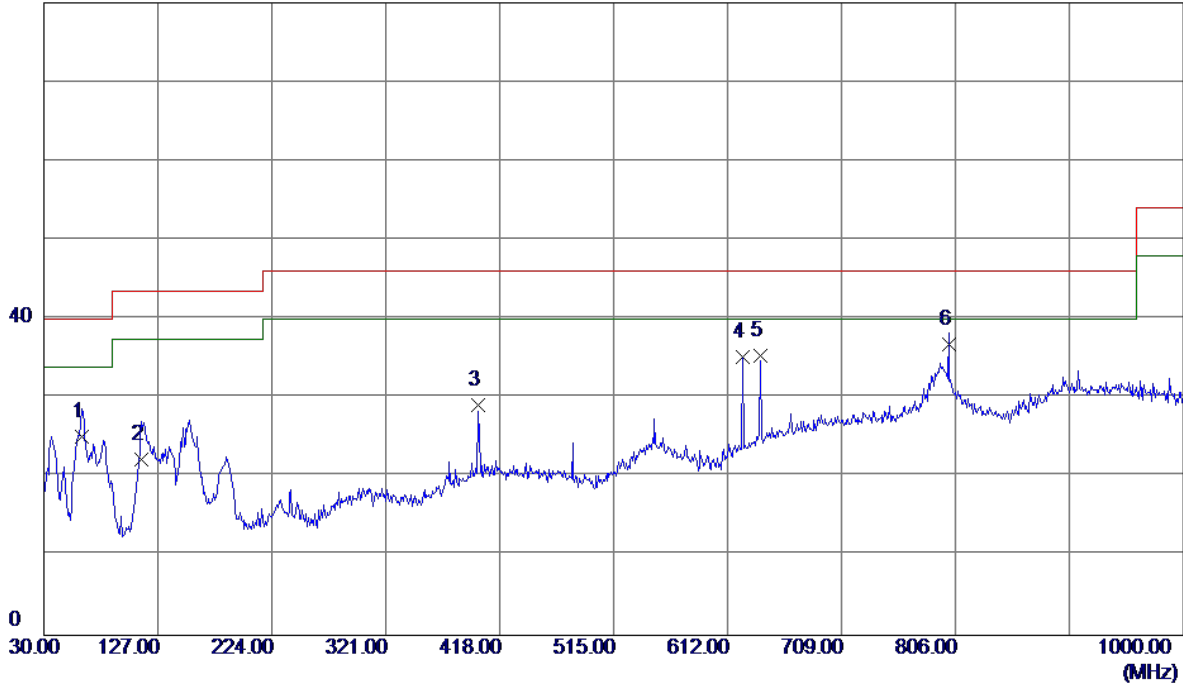

No.	Freq. MHz	Reading Level dBuV/m	Correct Factor dB	Measure ment dBuV/m	Limit dBuV/m	Margin dB	Detector	Comment
1	62.0100	39.42	-14.30	25.12	40.00	-14.88	QP	
2	113.4200	36.48	-14.25	22.23	43.50	-21.27	QP	
3	399.5700	36.87	-7.81	29.06	46.00	-16.94	QP	
4	624.6100	40.83	-5.64	35.19	46.00	-10.81	QP	
5	640.1300	40.10	-4.75	35.35	46.00	-10.65	QP	
6 *	800.1800	36.54	0.25	36.79	46.00	-9.21	QP	

Test Mode: UNII-3/TX A Mode 5785MHz_ Adapter:MU12AR120100-A1

Horizontal

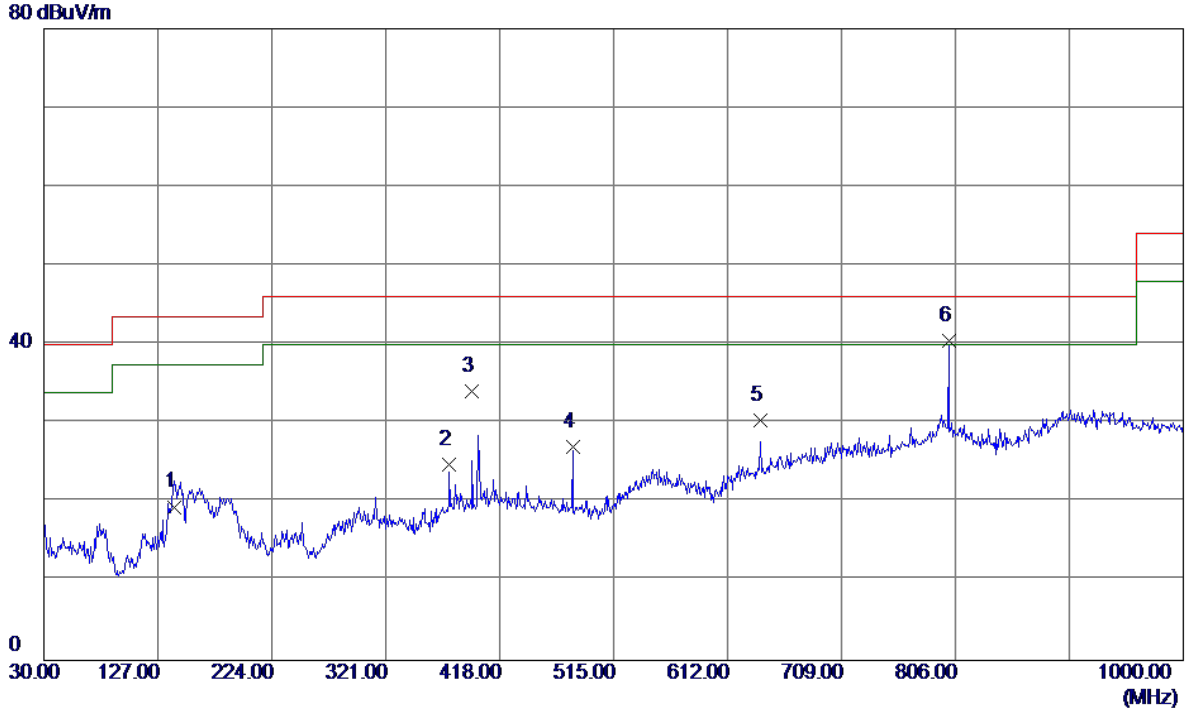

No.	Freq. MHz	Reading Level dBuV/m	Correct Factor dB	Measure ment dBuV/m	Limit dBuV/m	Margin dB	Detector	Comment
1	140.5800	33.15	-13.71	19.44	43.50	-24.06	QP	
2	375.3200	34.27	-9.48	24.79	46.00	-21.21	QP	
3	394.7200	42.16	-8.14	34.02	46.00	-11.98	QP	
4	480.0800	36.14	-9.03	27.11	46.00	-18.89	QP	
5	640.1300	35.20	-4.75	30.45	46.00	-15.55	QP	
6 *	800.1800	40.26	0.25	40.51	46.00	-5.49	QP	

Test Mode: UNII-3/TX A Mode 5825MHz_ Adapter:MU12AR120100-A1

Vertical

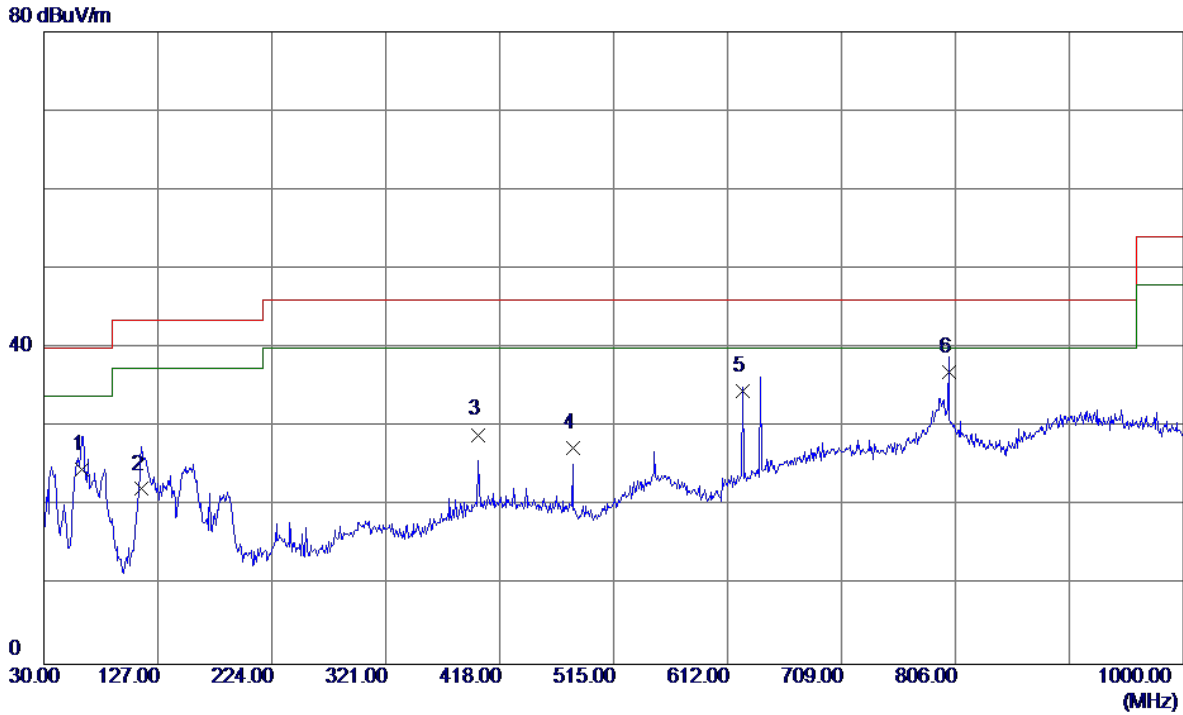

No.	Freq. MHz	Reading Level dBuV/m	Correct Factor dB	Measure ment dBuV/m	Limit dBuV/m	Margin dB	Detector	Comment
1	62.0100	38.89	-14.30	24.59	40.00	-15.41	QP	
2	113.4200	36.41	-14.25	22.16	43.50	-21.34	QP	
3	399.5700	36.85	-7.81	29.04	46.00	-16.96	QP	
4	480.0800	36.42	-9.03	27.39	46.00	-18.61	QP	
5	624.6100	40.14	-5.64	34.50	46.00	-11.50	QP	
6 *	800.1800	36.74	0.25	36.99	46.00	-9.01	QP	

Test Mode: UNII-3/TX A Mode 5825MHz_ Adapter:MU12AR120100-A1

Horizontal

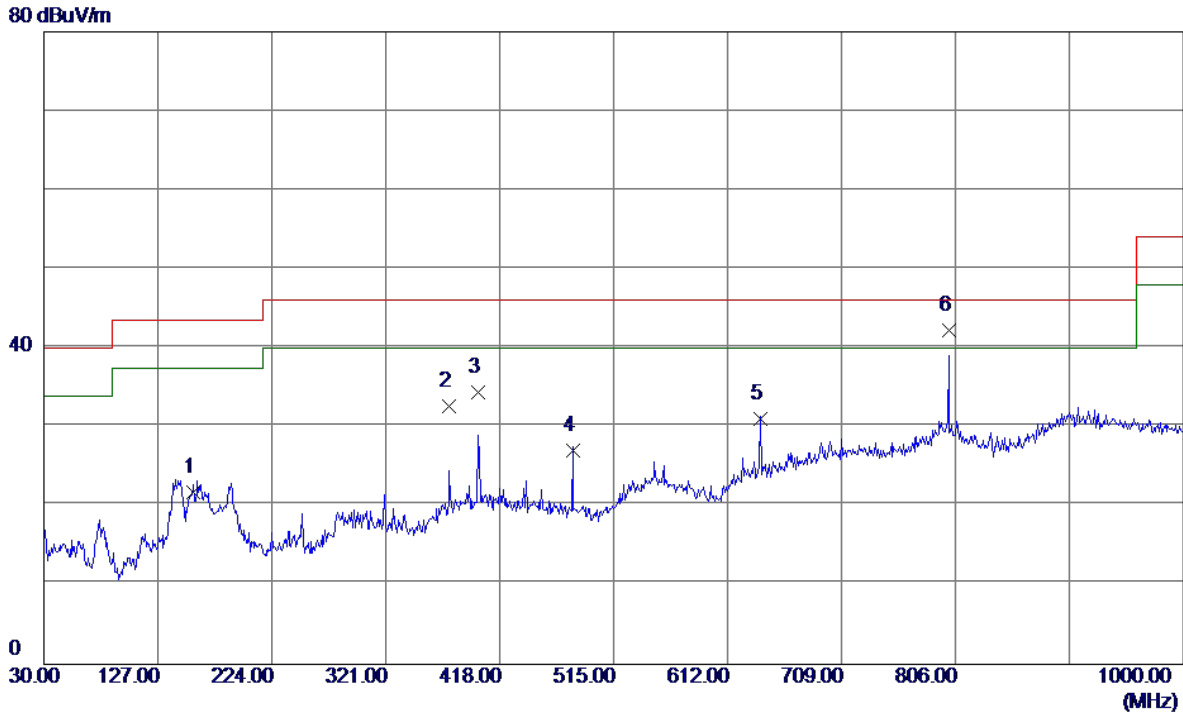

No.	Freq. MHz	Reading Level dBuV/m	Correct Factor dB	Measure ment dBuV/m	Limit dBuV/m	Margin dB	Detector	Comment
1	157.0700	34.16	-12.38	21.78	43.50	-21.72	QP	
2	375.3200	42.15	-9.48	32.67	46.00	-13.33	QP	
3	399.5700	42.25	-7.81	34.44	46.00	-11.56	QP	
4	480.0800	36.05	-9.03	27.02	46.00	-18.98	QP	
5	640.1300	35.85	-4.75	31.10	46.00	-14.90	QP	
6 *	800.1800	41.95	0.25	42.20	46.00	-3.80	QP	

ATTACHMENTD -RADIATED EMISSION (ABOVE 1000MHZ)

Orthogonal Axis:	X
Test Mode:	UNII-1/ TX A Mode 5180MHz

Vertical

115 dBuV/m

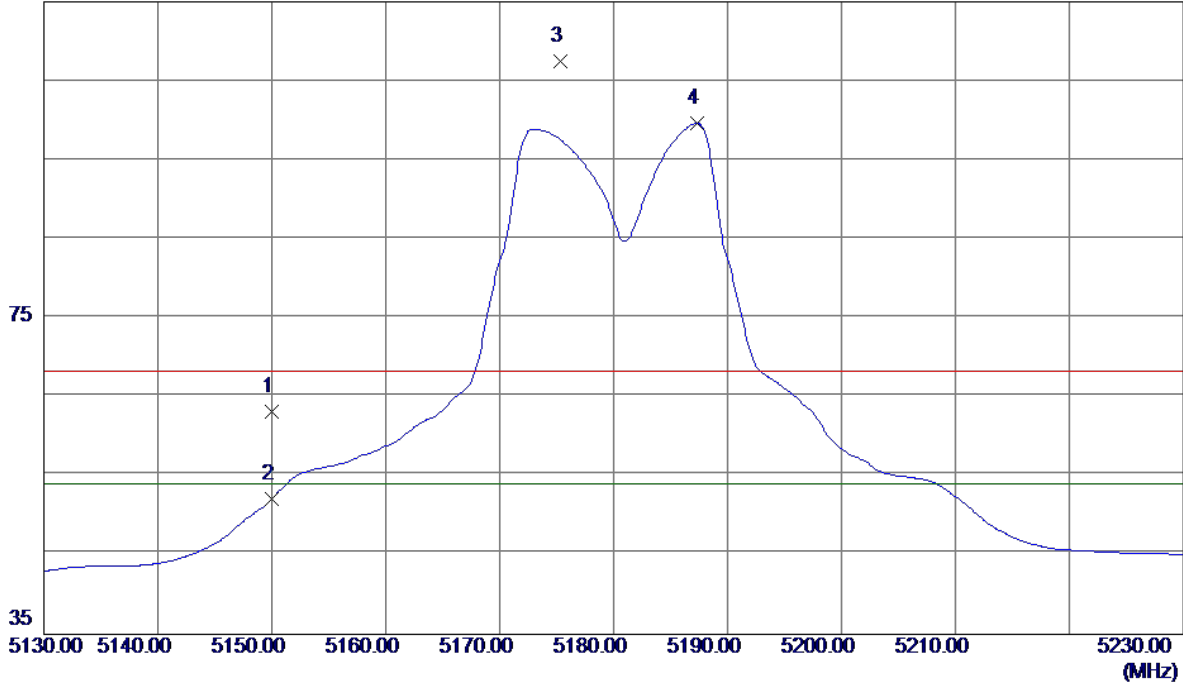

No.	Freq. MHz	Reading Level dBuV/m	Correct Factor dB	Measure ment dBuV/m	Limit dBuV/m	Margin dB	Detector	Comment
1	5150.0000	22.53	40.62	63.15	68.30	-5.15	Peak	
2	5150.0000	11.49	40.62	52.11	54.00	-1.89	AVG	
3	5175.3000	66.74	40.71	107.45	68.30	39.15	Peak	No Limit
4 *	5187.3000	58.91	40.75	99.66	54.00	45.66	AVG	No Limit

Orthogonal Axis:	X
Test Mode:	UNII-1/ TX A Mode 5180MHz

Vertical

80 dBuV/m

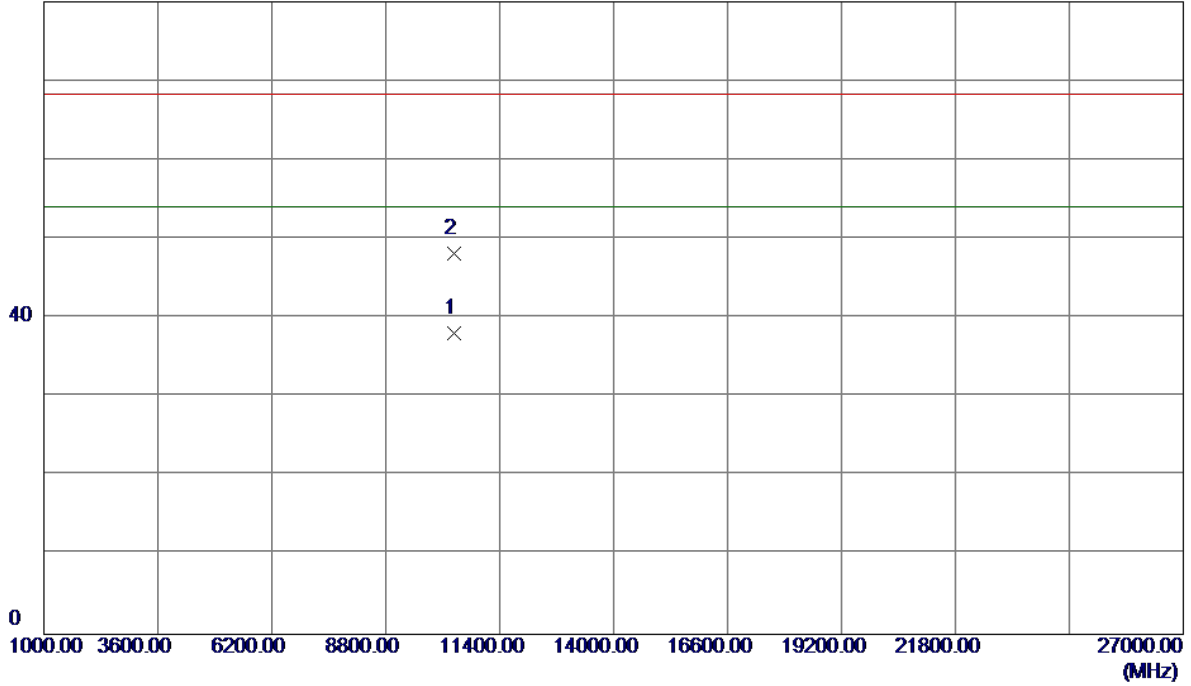

No.	Freq. MHz	Reading Level dBuV/m	Correct Factor dB	Measure ment dBuV/m	Limit dBuV/m	Margin dB	Detector	Comment
1 *	10360.4000	23.17	14.96	38.13	54.00	-15.87	AVG	
2	10361.1000	33.18	14.96	48.14	68.30	-20.16	Peak	

Orthogonal Axis:	X
Test Mode:	UNII-1/ TX A Mode 5180MHz

Horizontal

115 dBuV/m

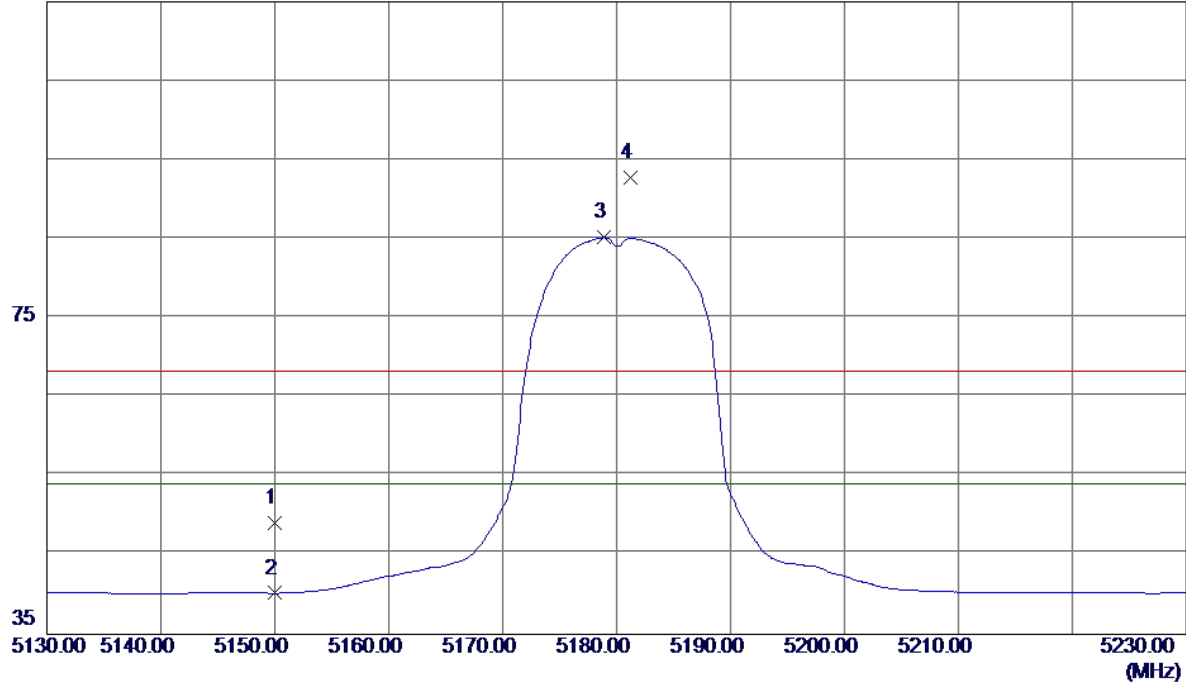

No.	Freq. MHz	Reading Level dBuV/m	Correct Factor dB	Measure ment dBuV/m	Limit dBuV/m	Margin dB	Detector	Comment
1	5150.0000	8.50	40.62	49.12	68.30	-19.18	Peak	
2	5150.0000	-0.42	40.62	40.20	54.00	-13.80	AVG	
3 *	5178.9000	44.45	40.72	85.17	54.00	31.17	AVG	No Limit
4	5181.2000	52.01	40.73	92.74	68.30	24.44	Peak	No Limit

Orthogonal Axis:	X
Test Mode:	UNII-1/ TX A Mode 5180MHz

Horizontal

80 dBuV/m

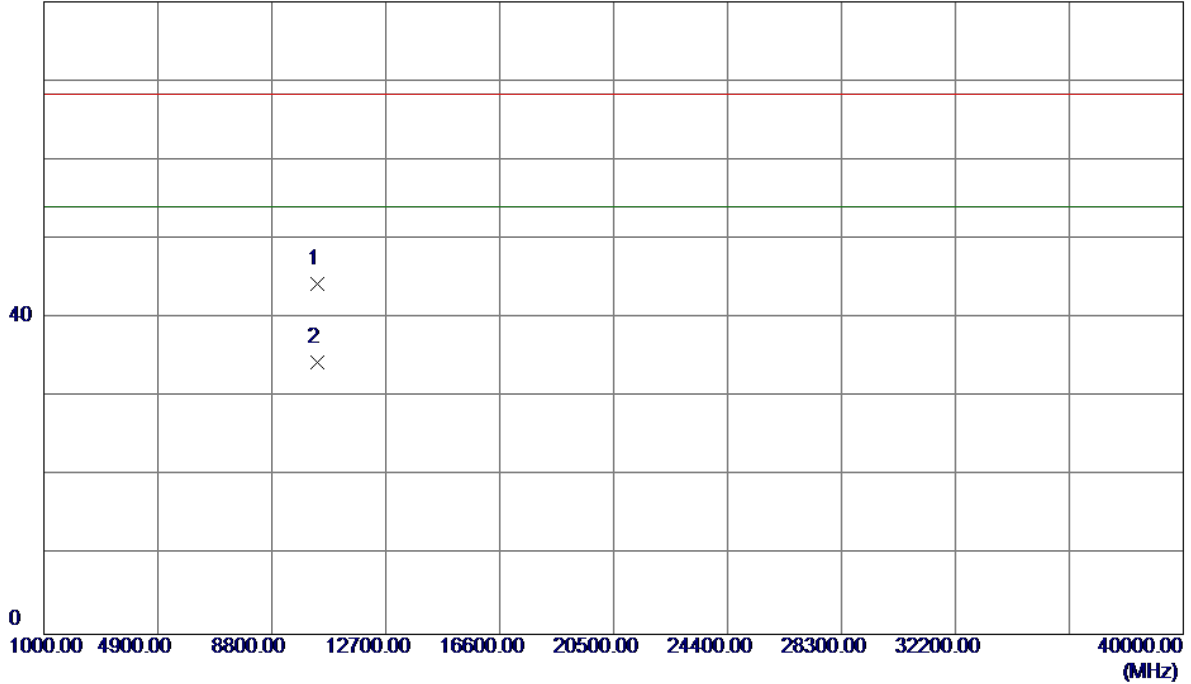

No.	Freq. MHz	Reading Level dBuV/m	Correct Factor dB	Measure ment dBuV/m	Limit dBuV/m	Margin dB	Detector	Comment
1	10359.5000	29.40	14.96	44.36	68.30	-23.94	Peak	
2 *	10360.6000	19.46	14.96	34.42	54.00	-19.58	AVG	

Orthogonal Axis:	X
Test Mode:	UNII-1/ TX A Mode 5200MHz

Vertical

115 dBuV/m

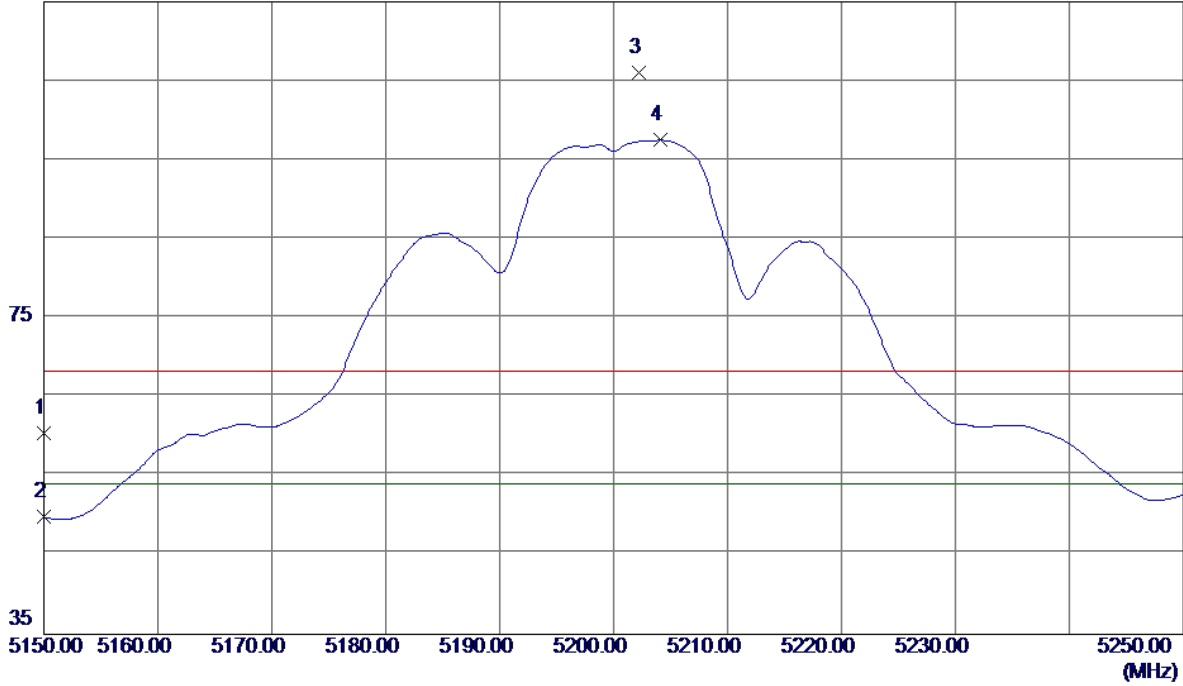

No.	Freq. MHz	Reading Level dBuV/m	Correct Factor dB	Measure ment dBuV/m	Limit dBuV/m	Margin dB	Detector	Comment
1	5150.0000	19.85	40.62	60.47	68.30	-7.83	Peak	
2	5150.0000	9.21	40.62	49.83	54.00	-4.17	AVG	
3	5202.2000	65.25	40.80	106.05	68.30	37.75	Peak	No Limit
4 *	5204.1000	56.69	40.80	97.49	54.00	43.49	AVG	No Limit

Orthogonal Axis:	X
Test Mode:	UNII-1/ TX A Mode 5200MHz

Vertical

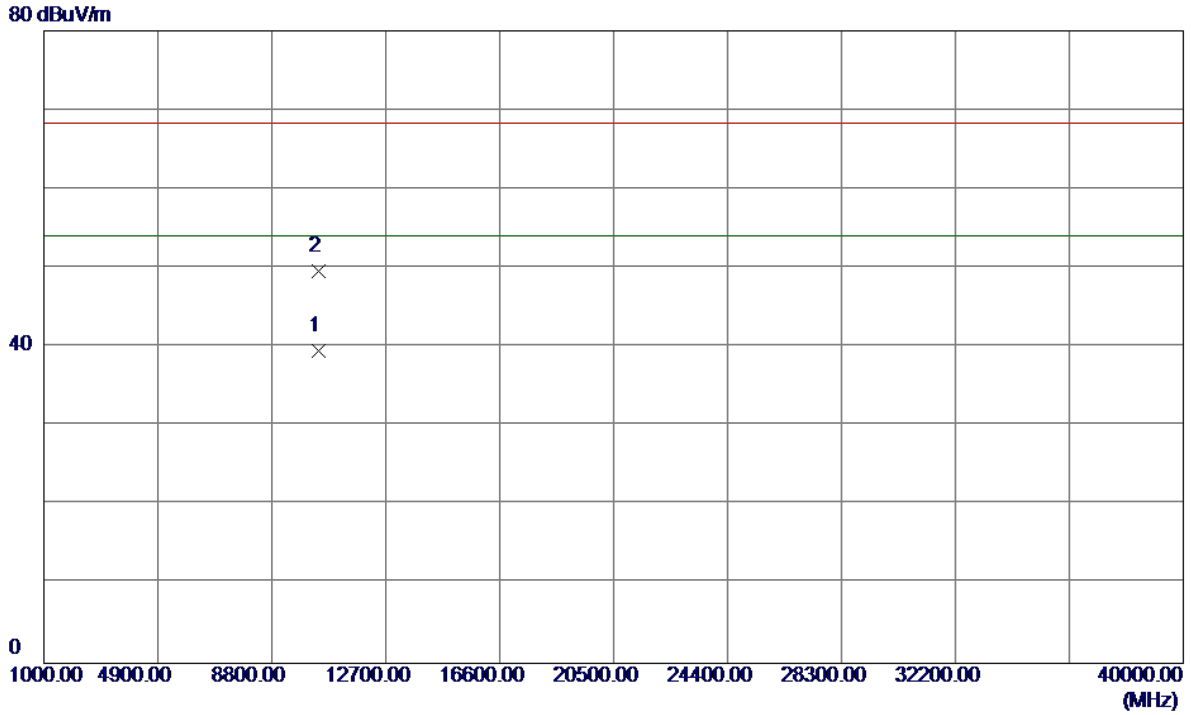

No.	Freq. MHz	Reading Level dBuV/m	Correct Factor dB	Measurement dBuV/m	Limit dBuV/m	Margin dB	Detector	Comment
1 *	10400.3000	24.51	15.06	39.57	54.00	-14.43	AVG	
2	10400.4000	34.47	15.06	49.53	68.30	-18.77	Peak	

Orthogonal Axis:	X
Test Mode:	UNII-1/ TX A Mode 5200MHz

Horizontal

115 dBuV/m

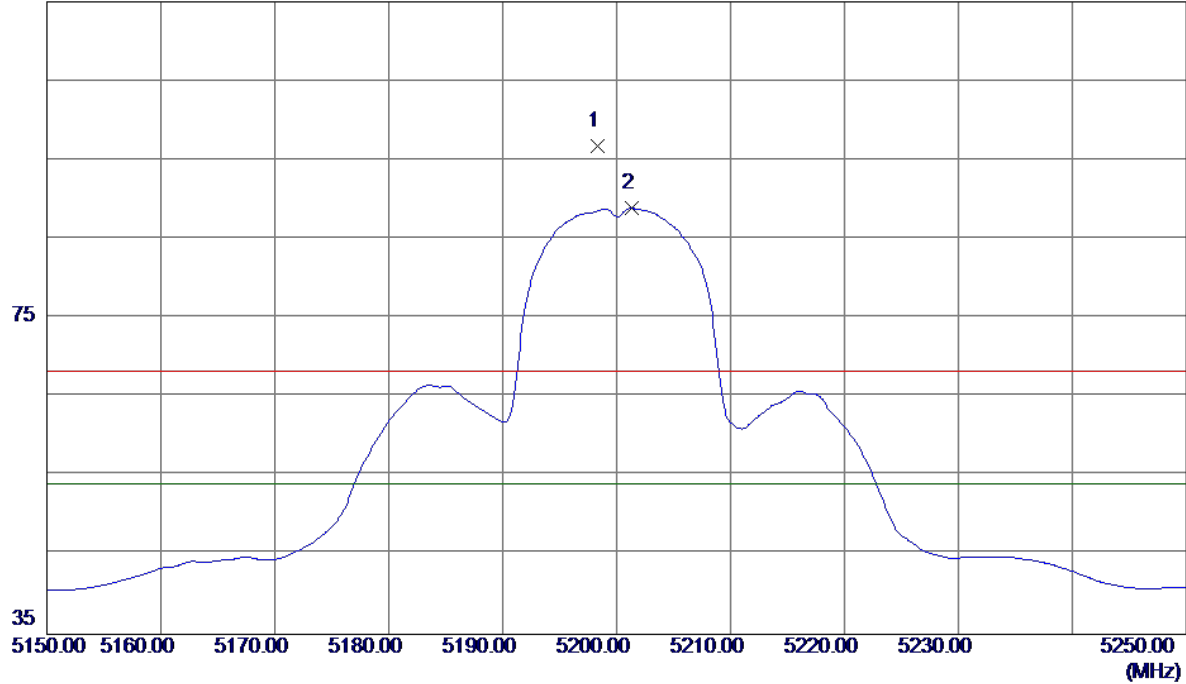

No.	Freq. MHz	Reading Level dBuV/m	Correct Factor dB	Measure ment dBuV/m	Limit dBuV/m	Margin dB	Detector	Comment
1	5198.3000	56.01	40.78	96.79	68.30	28.49	Peak	No Limit
2 *	5201.3000	48.08	40.79	88.87	54.00	34.87	AVG	No Limit

Orthogonal Axis:	X
Test Mode:	UNII-1/ TX A Mode 5200MHz

Horizontal

80 dBuV/m

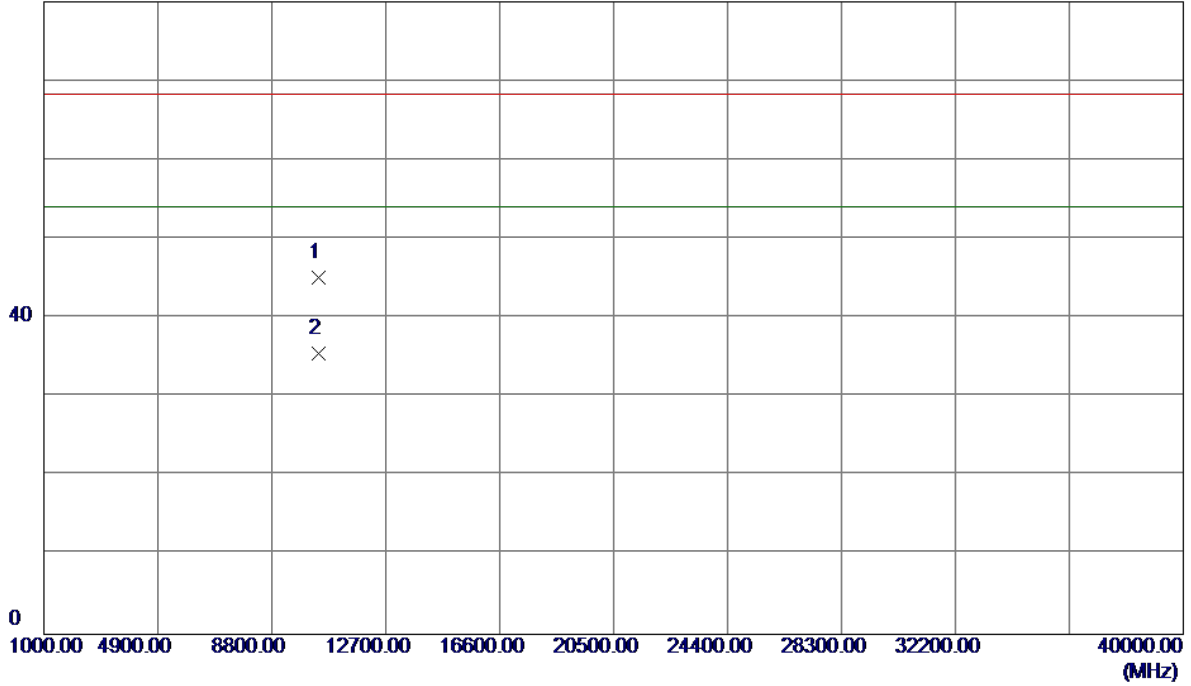

No.	Freq. MHz	Reading Level dBuV/m	Correct Factor dB	Measure ment dBuV/m	Limit dBuV/m	Margin dB	Detector	Comment
1	10400.1000	30.02	15.06	45.08	68.30	-23.22	Peak	
2 *	10400.2000	20.41	15.06	35.47	54.00	-18.53	AVG	

Orthogonal Axis:	X
Test Mode:	UNII-1/ TX A Mode 5240MHz

Vertical

115 dBuV/m

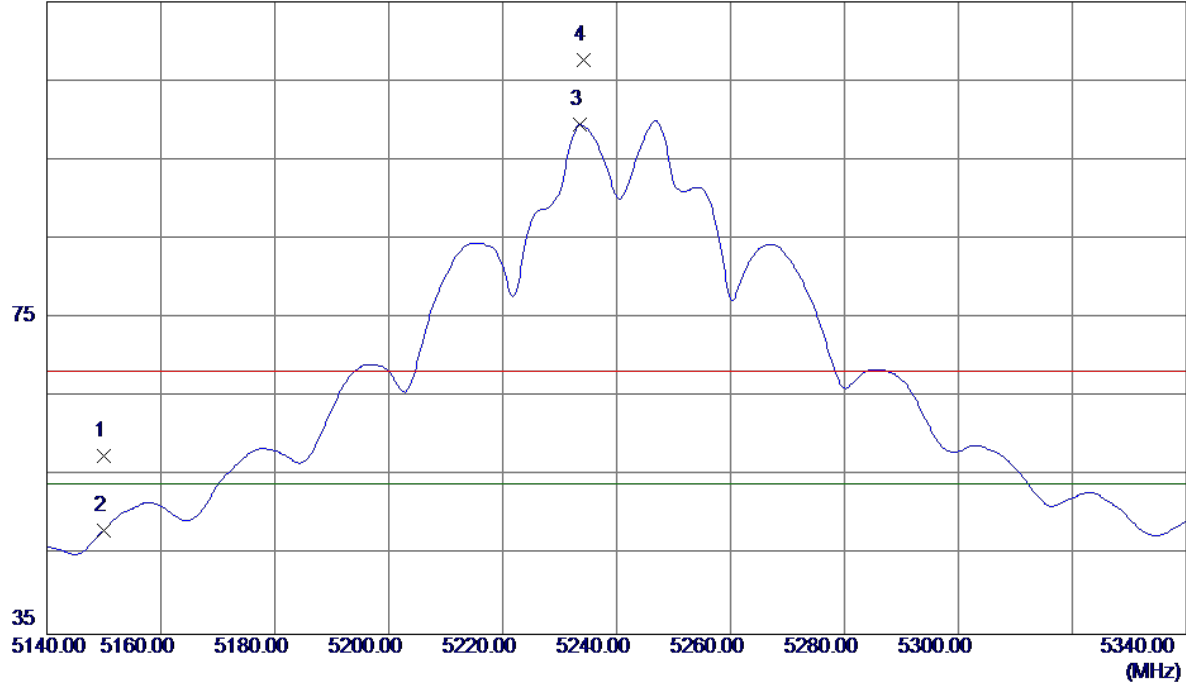

No.	Freq. MHz	Reading Level dBuV/m	Correct Factor dB	Measure ment dBuV/m	Limit dBuV/m	Margin dB	Detector	Comment
1	5150.0000	16.95	40.62	57.57	68.30	-10.73	Peak	
2	5150.0000	7.55	40.62	48.17	54.00	-5.83	AVG	
3 *	5233.6000	58.53	40.90	99.43	54.00	45.43	AVG	No Limit
4	5234.2000	66.79	40.90	107.69	68.30	39.39	Peak	No Limit

Orthogonal Axis:	X
Test Mode:	UNII-1/ TX A Mode 5240MHz

Vertical

80 dBuV/m

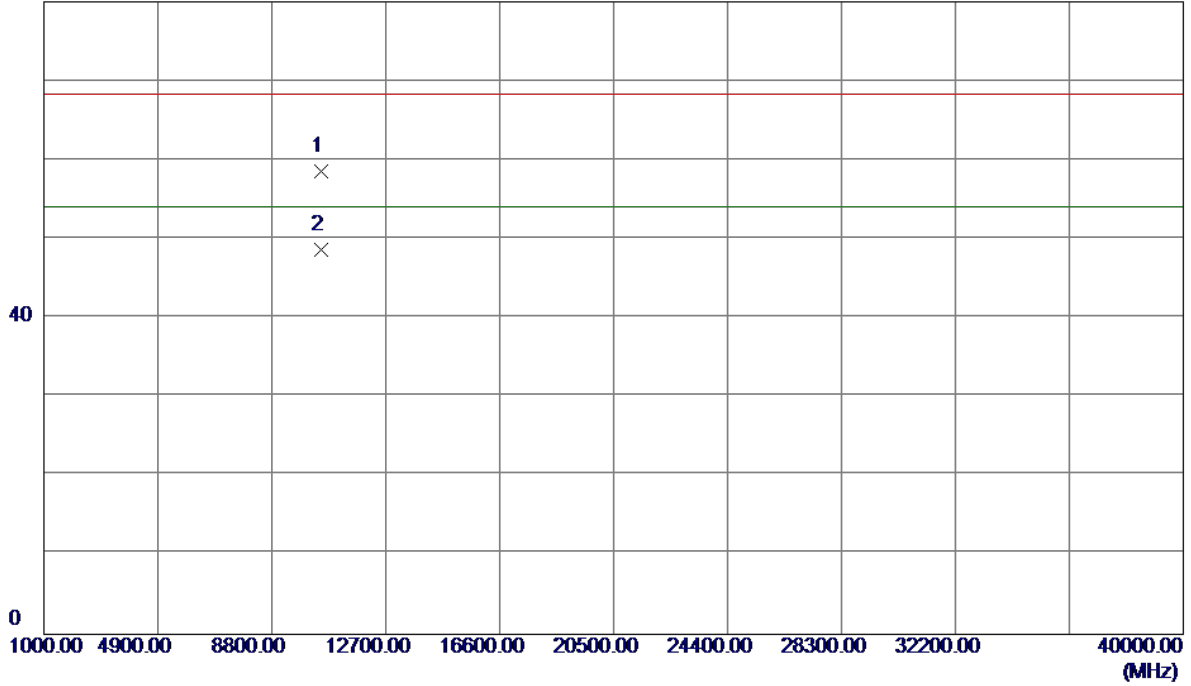

No.	Freq. MHz	Reading Level dBuV/m	Correct Factor dB	Measure ment dBuV/m	Limit dBuV/m	Margin dB	Detector	Comment
1	10480.1000	43.30	15.24	58.54	68.30	-9.76	Peak	
2 *	10480.2000	33.42	15.24	48.66	54.00	-5.34	AVG	

Orthogonal Axis:	X
Test Mode:	UNII-1/ TX A Mode 5240MHz

Horizontal

115 dBuV/m

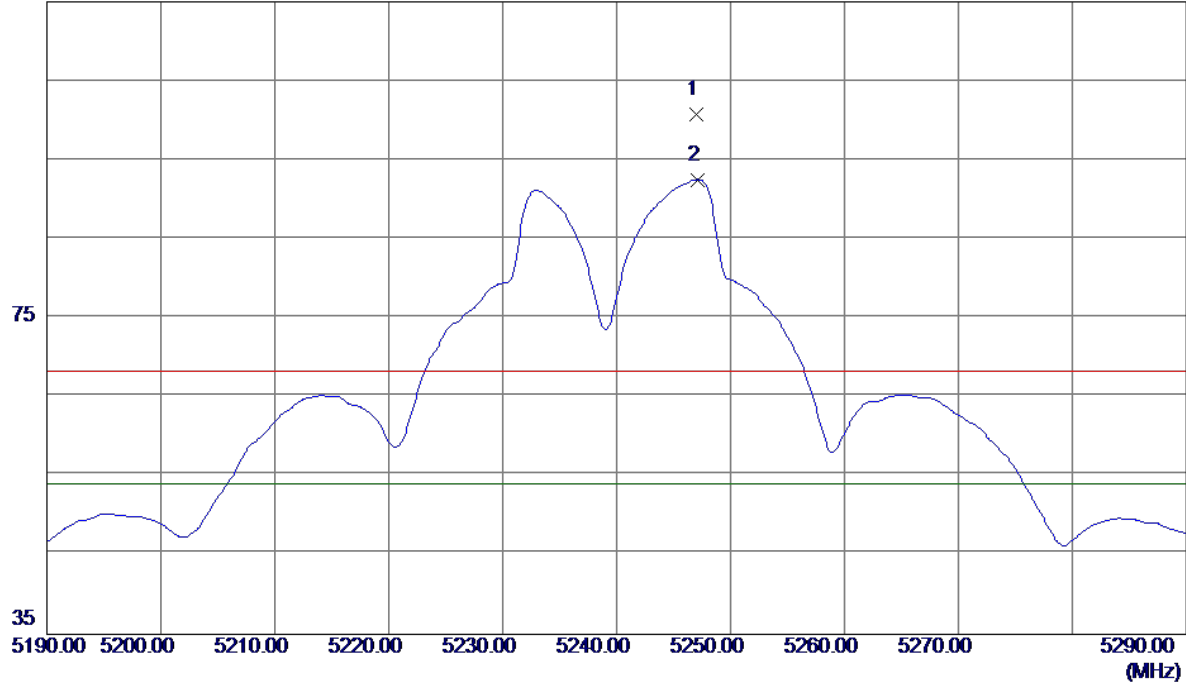

No.	Freq. MHz	Reading Level dBuV/m	Correct Factor dB	Measure ment dBuV/m	Limit dBuV/m	Margin dB	Detector	Comment
1	5247.0000	59.90	40.94	100.84	68.30	32.54	Peak	No Limit
2 *	5247.1000	51.57	40.95	92.52	54.00	38.52	AVG	No Limit

Orthogonal Axis:	X
Test Mode:	UNII-1/ TX A Mode 5240MHz

Horizontal

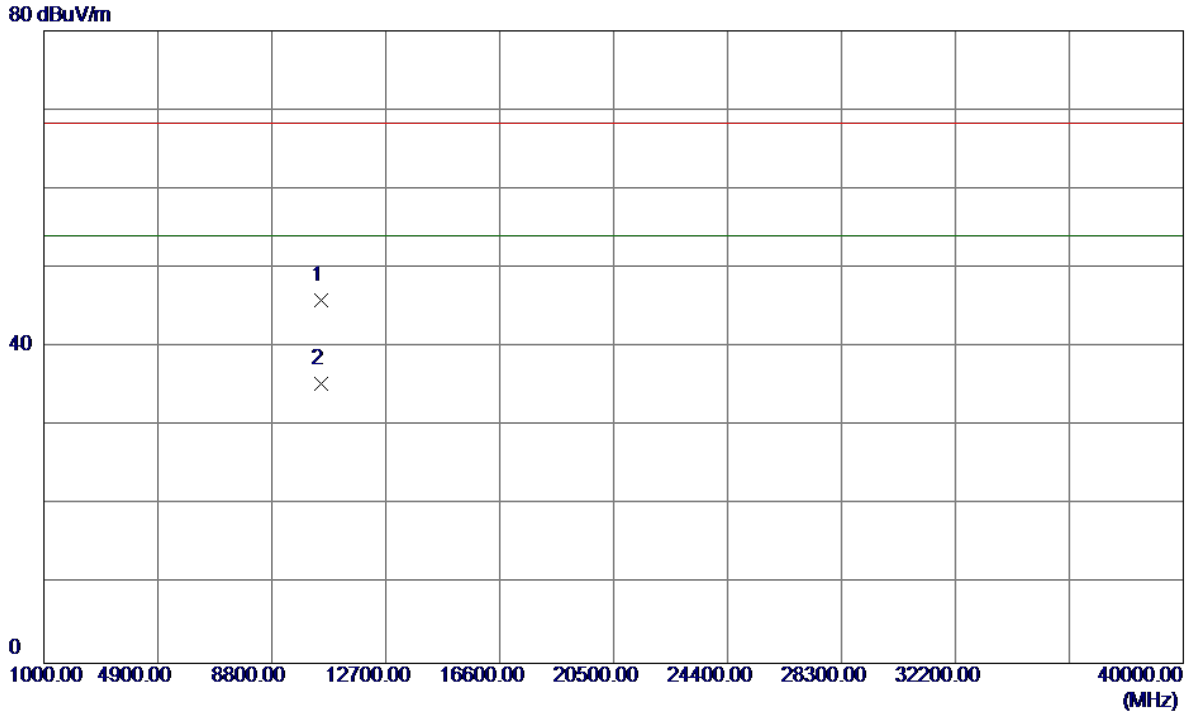

No.	Freq. MHz	Reading Level dBuV/m	Correct Factor dB	Measure ment dBuV/m	Limit dBuV/m	Margin dB	Detector	Comment
1	10478.8000	30.66	15.24	45.90	68.30	-22.40	Peak	
2 *	10480.3000	20.13	15.24	35.37	54.00	-18.63	AVG	

Orthogonal Axis:	X
Test Mode:	UNII-1/ TX N20 Mode 5180MHz

Vertical

120 dBuV/m

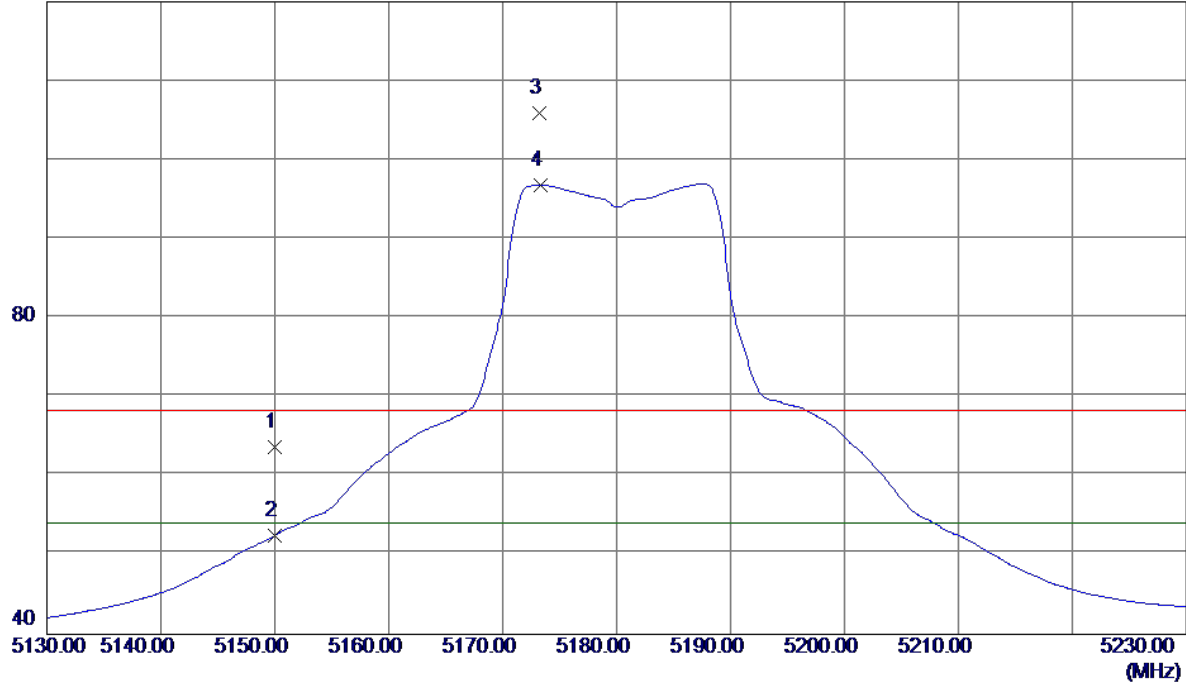

No.	Freq. MHz	Reading Level dBuV/m	Correct Factor dB	Measure ment dBuV/m	Limit dBuV/m	Margin dB	Detector	Comment
1	5150.0000	23.11	40.62	63.73	68.30	-4.57	Peak	
2	5150.0000	11.87	40.62	52.49	54.00	-1.51	AVG	
3	5173.2000	65.14	40.70	105.84	68.30	37.54	Peak	No Limit
4 *	5173.3000	56.08	40.70	96.78	54.00	42.78	AVG	No Limit

Orthogonal Axis:	X
Test Mode:	UNII-1/ TX N20 Mode 5180MHz

Vertical

80 dBuV/m

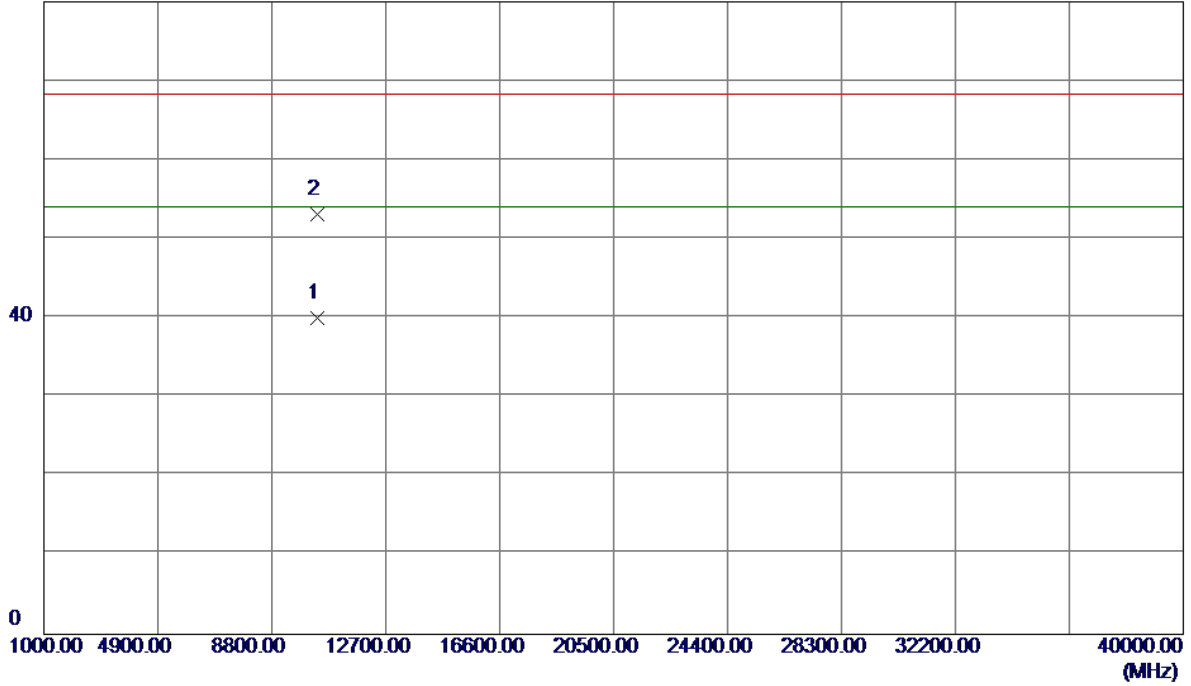

No.	Freq. MHz	Reading Level dBuV/m	Correct Factor dB	Measure ment dBuV/m	Limit dBuV/m	Margin dB	Detector	Comment
1 *	10359.7800	25.07	14.96	40.03	54.00	-13.97	AVG	
2	10360.7200	38.13	14.96	53.09	68.30	-15.21	Peak	

Orthogonal Axis:	X
Test Mode:	UNII-1/ TX N20 Mode 5180MHz

Horizontal

115 dBuV/m

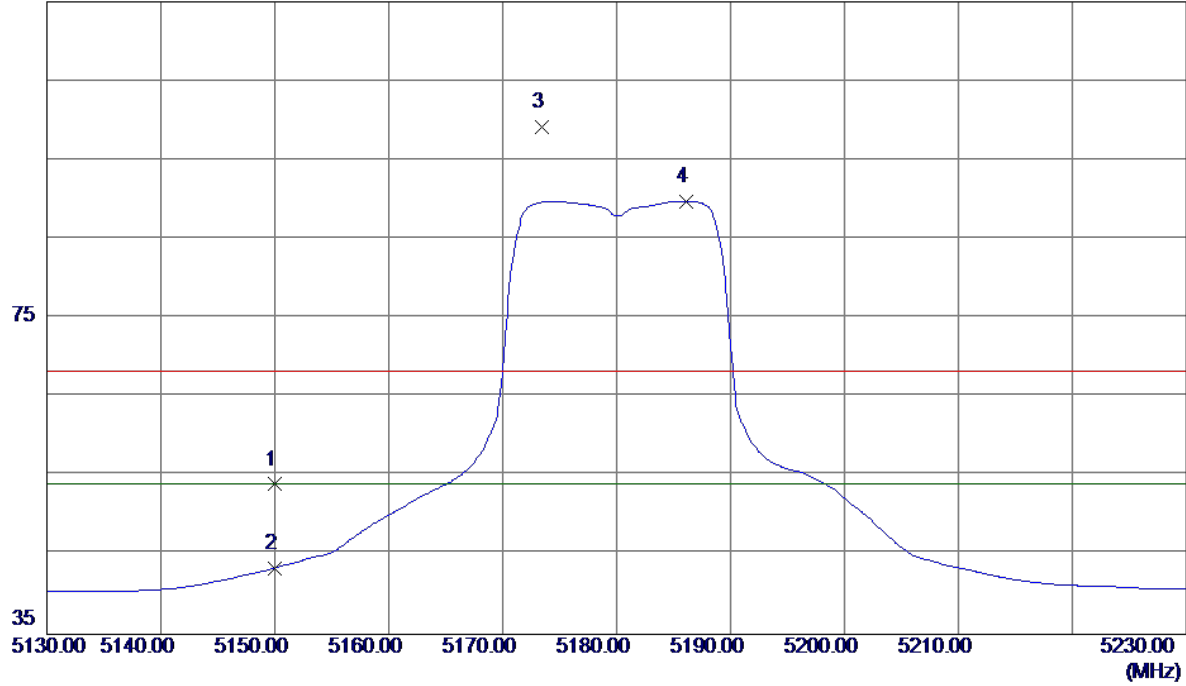

No.	Freq. MHz	Reading Level dBuV/m	Correct Factor dB	Measure ment dBuV/m	Limit dBuV/m	Margin dB	Detector	Comment
1	5150.0000	13.34	40.62	53.96	68.30	-14.34	Peak	
2	5150.0000	2.76	40.62	43.38	54.00	-10.62	AVG	
3	5173.4000	58.52	40.70	99.22	68.30	30.92	Peak	No Limit
4 *	5186.1000	49.02	40.74	89.76	54.00	35.76	AVG	No Limit

Orthogonal Axis:	X
Test Mode:	UNII-1/ TX N20 Mode 5180MHz

Horizontal

80 dBuV/m

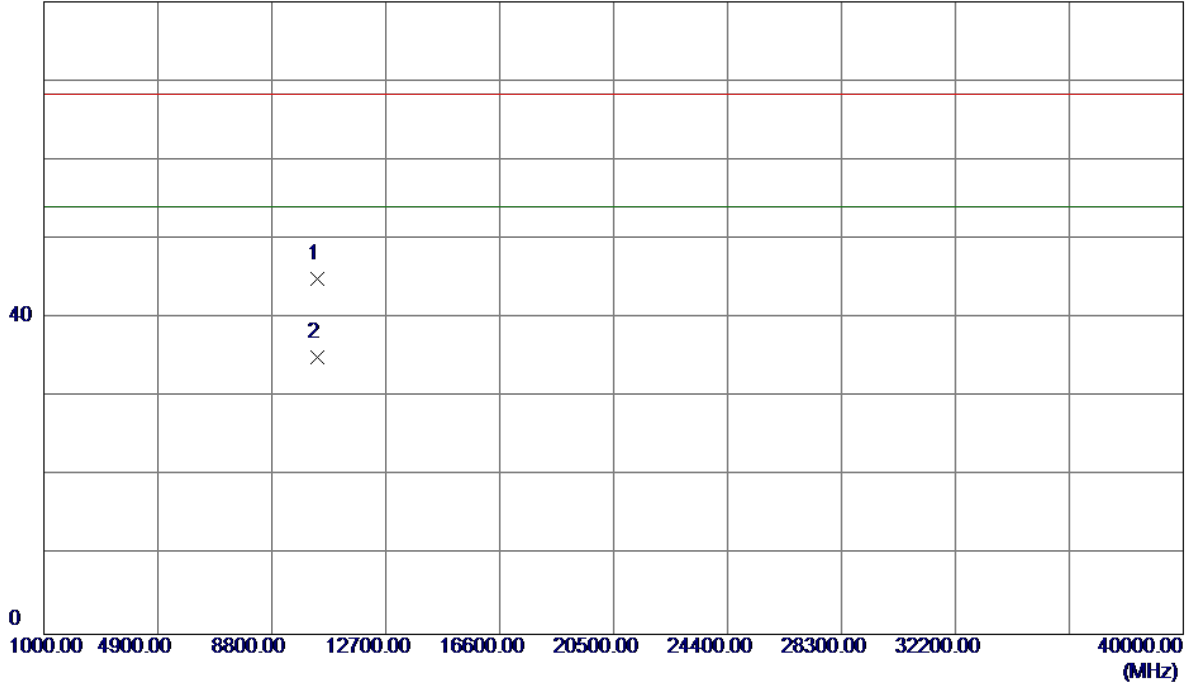

No.	Freq. MHz	Reading Level dBuV/m	Correct Factor dB	Measure ment dBuV/m	Limit dBuV/m	Margin dB	Detector	Comment
1	10360.0000	29.95	14.96	44.91	68.30	-23.39	Peak	
2 *	10360.6000	20.02	14.96	34.98	54.00	-19.02	AVG	

Orthogonal Axis:	X
Test Mode:	UNII-1/ TX N20 Mode 5200MHz

Vertical

120 dBuV/m

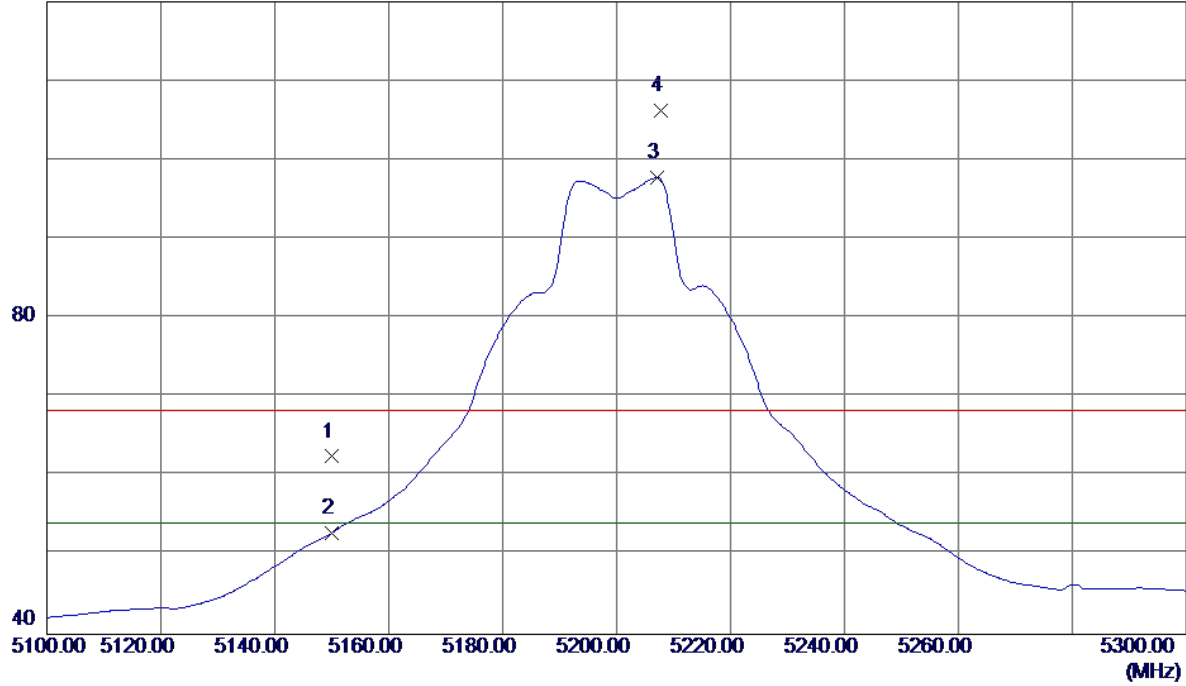

No.	Freq. MHz	Reading Level dBuV/m	Correct Factor dB	Measure ment dBuV/m	Limit dBuV/m	Margin dB	Detector	Comment
1	5150.0000	21.86	40.62	62.48	68.30	-5.82	Peak	
2	5150.0000	12.20	40.62	52.82	54.00	-1.18	AVG	
3 *	5207.2000	56.99	40.81	97.80	54.00	43.80	AVG	No Limit
4	5207.8000	65.50	40.82	106.32	68.30	38.02	Peak	No Limit

Orthogonal Axis:	X
Test Mode:	UNII-1/ TX N20 Mode 5200MHz

Vertical

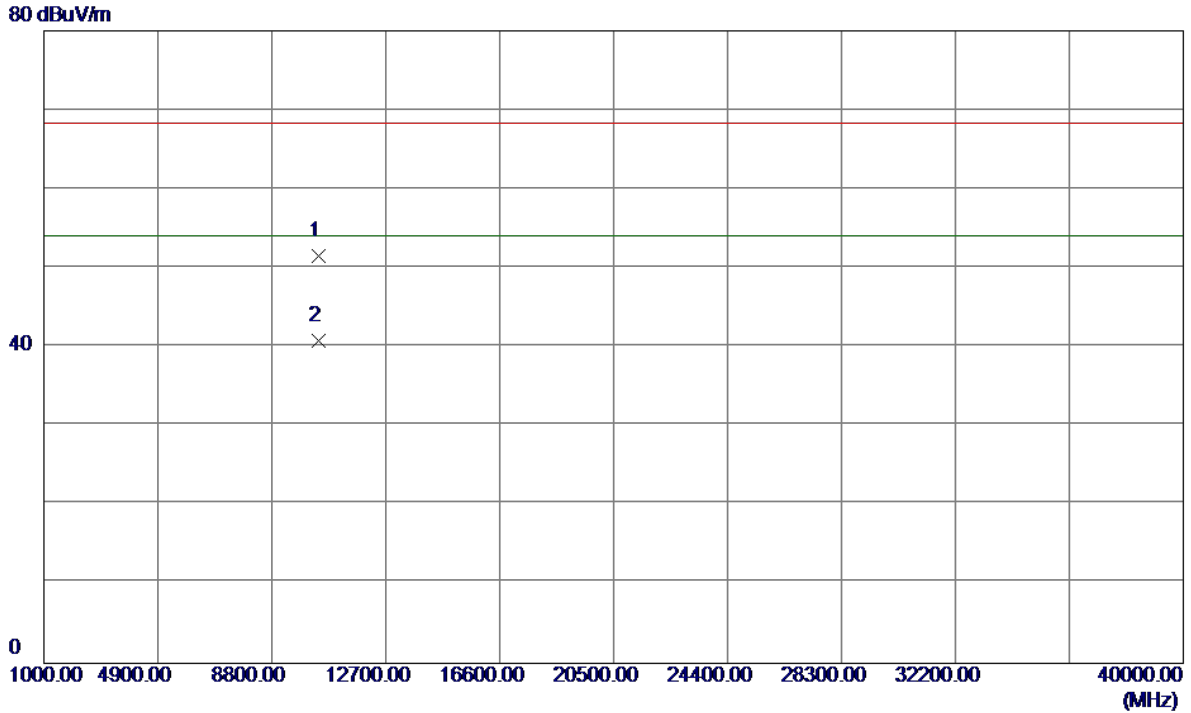

No.	Freq. MHz	Reading Level dBuV/m	Correct Factor dB	Measure ment dBuV/m	Limit dBuV/m	Margin dB	Detector	Comment
1	10400.6000	36.50	15.06	51.56	68.30	-16.74	Peak	
2 *	10401.0000	25.68	15.06	40.74	54.00	-13.26	AVG	

Orthogonal Axis:	X
Test Mode:	UNII-1/ TX N20 Mode 5200MHz

Horizontal

115 dBuV/m

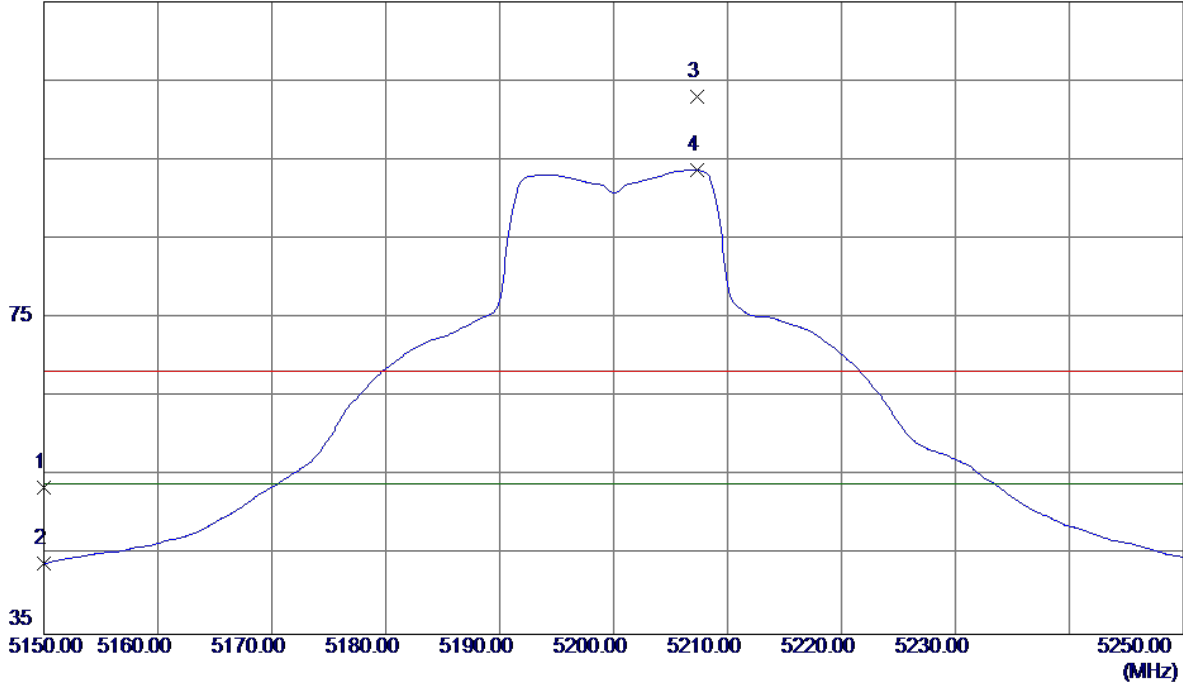

No.	Freq. MHz	Reading Level dBuV/m	Correct Factor dB	Measure ment dBuV/m	Limit dBuV/m	Margin dB	Detector	Comment
1	5150.0000	12.97	40.62	53.59	68.30	-14.71	Peak	
2	5150.0000	3.29	40.62	43.91	54.00	-10.09	AVG	
3	5207.3000	62.11	40.81	102.92	68.30	34.62	Peak	No Limit
4 *	5207.3000	52.86	40.81	93.67	54.00	39.67	AVG	No Limit

Orthogonal Axis:	X
Test Mode:	UNII-1/ TX N20 Mode 5200MHz

Horizontal

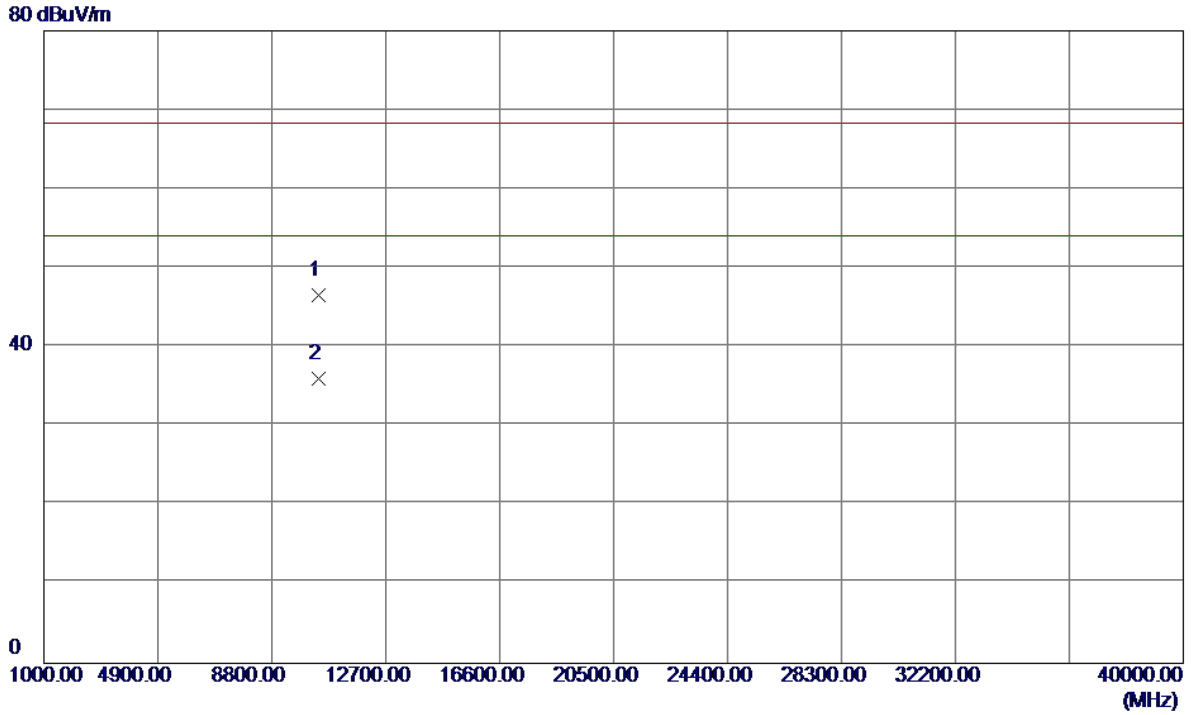

No.	Freq. MHz	Reading Level dBuV/m	Correct Factor dB	Measure ment dBuV/m	Limit dBuV/m	Margin dB	Detector	Comment
1	10399.6000	31.46	15.06	46.52	68.30	-21.78	Peak	
2 *	10400.9000	20.87	15.06	35.93	54.00	-18.07	AVG	

Orthogonal Axis:	X
Test Mode:	UNII-1/ TX N20 Mode 5240MHz

Vertical

120 dBuV/m

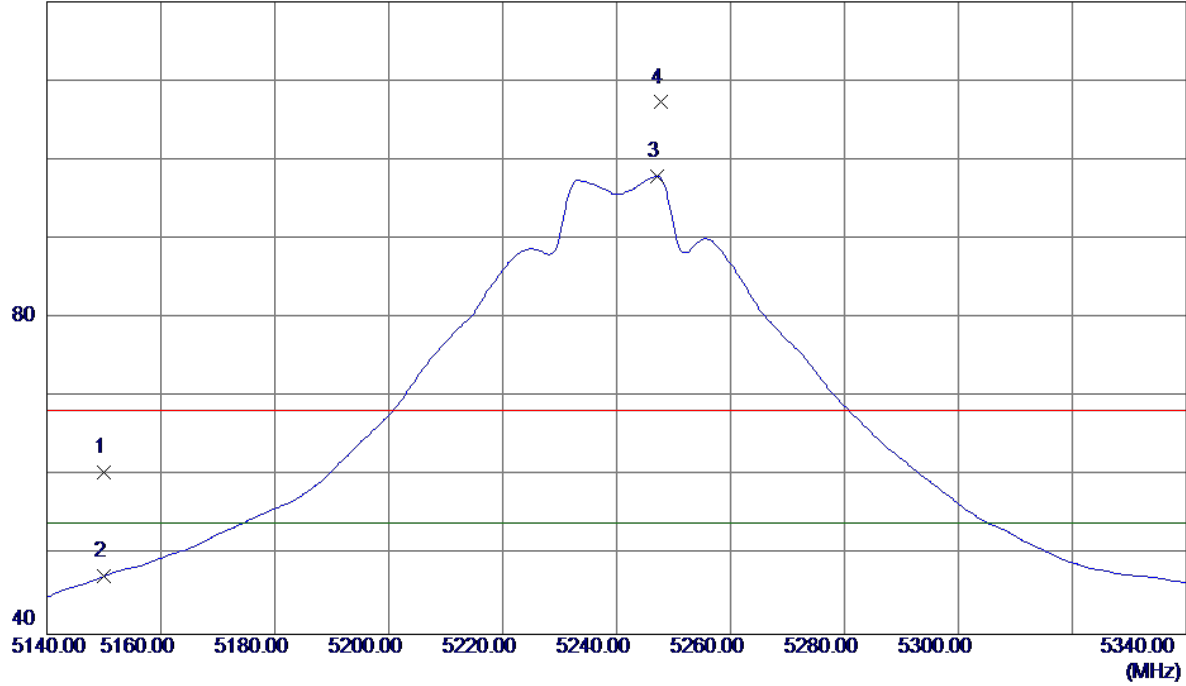

No.	Freq. MHz	Reading Level dBuV/m	Correct Factor dB	Measure ment dBuV/m	Limit dBuV/m	Margin dB	Detector	Comment
1	5150.0000	19.90	40.62	60.52	68.30	-7.78	Peak	
2	5150.0000	6.73	40.62	47.35	54.00	-6.65	AVG	
3 *	5247.2000	57.01	40.95	97.96	54.00	43.96	AVG	No Limit
4	5247.8000	66.33	40.95	107.28	68.30	38.98	Peak	No Limit

Orthogonal Axis:	X
Test Mode:	UNII-1/ TX N20 Mode 5240MHz

Vertical

80 dBuV/m

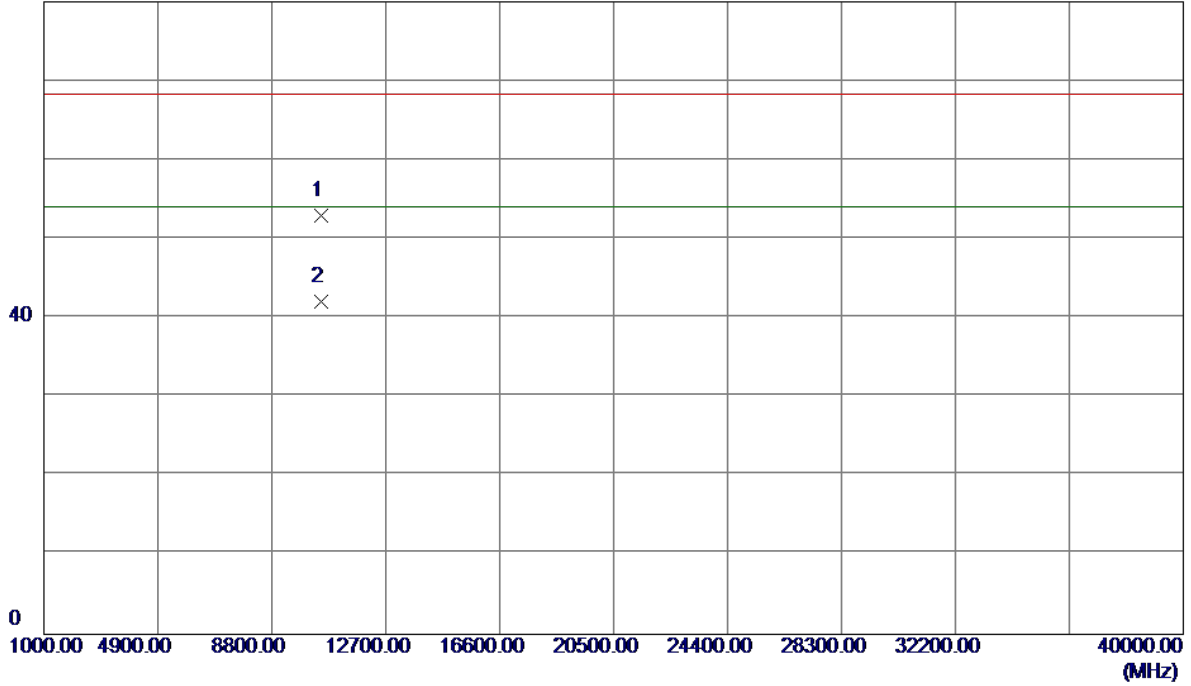

No.	Freq. MHz	Reading Level dBuV/m	Correct Factor dB	Measure ment dBuV/m	Limit dBuV/m	Margin dB	Detector	Comment
1	10480.7000	37.71	15.24	52.95	68.30	-15.35	Peak	
2 *	10481.2000	26.82	15.25	42.07	54.00	-11.93	AVG	

Orthogonal Axis:	X
Test Mode:	UNII-1/ TX N20 Mode 5240MHz

Horizontal

115 dBuV/m

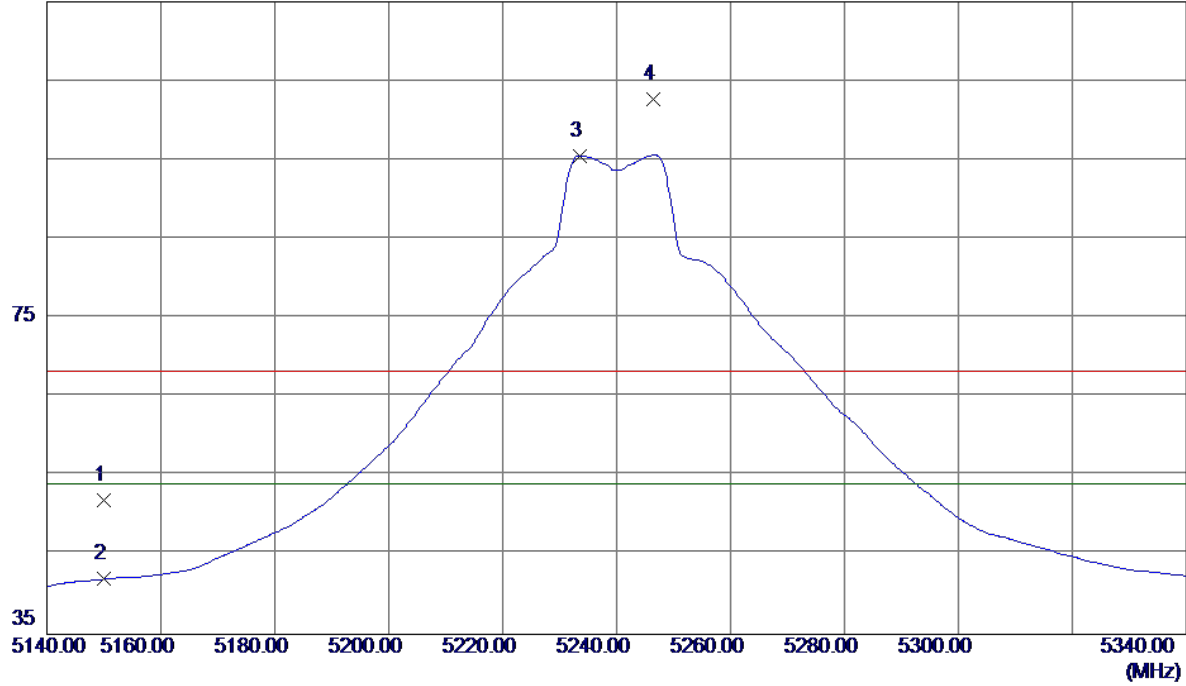

No.	Freq. MHz	Reading Level dBuV/m	Correct Factor dB	Measure ment dBuV/m	Limit dBuV/m	Margin dB	Detector	Comment
1	5150.0000	11.31	40.62	51.93	68.30	-16.37	Peak	
2	5150.0000	1.35	40.62	41.97	54.00	-12.03	AVG	
3 *	5233.6000	54.61	40.90	95.51	54.00	41.51	AVG	No Limit
4	5246.4000	61.76	40.94	102.70	68.30	34.40	Peak	No Limit

Orthogonal Axis:	X
Test Mode:	UNII-1/ TX N20 Mode 5240MHz

Horizontal

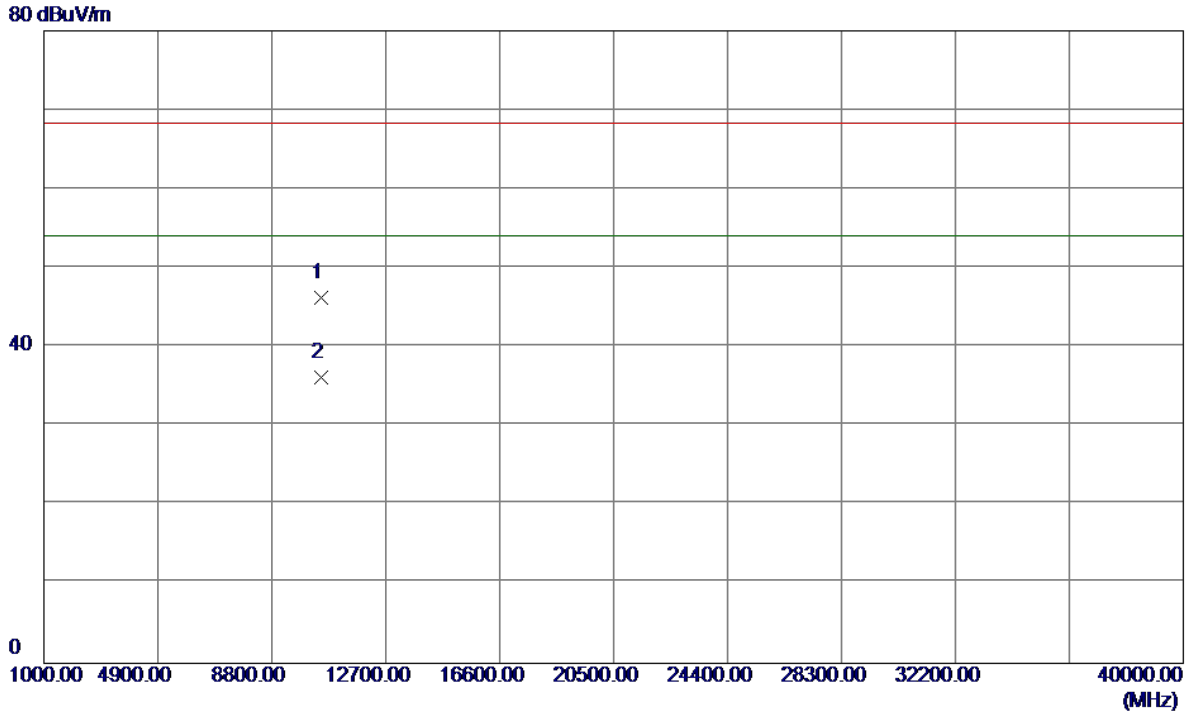

No.	Freq. MHz	Reading Level dBuV/m	Correct Factor dB	Measure ment dBuV/m	Limit dBuV/m	Margin dB	Detector	Comment
1	10479.5000	30.96	15.24	46.20	68.30	-22.10	Peak	
2 *	10481.1000	20.85	15.25	36.10	54.00	-17.90	AVG	

Orthogonal Axis:	X
Test Mode:	UNII-1/ TX N40 Mode 5190MHz

Vertical

120 dBuV/m

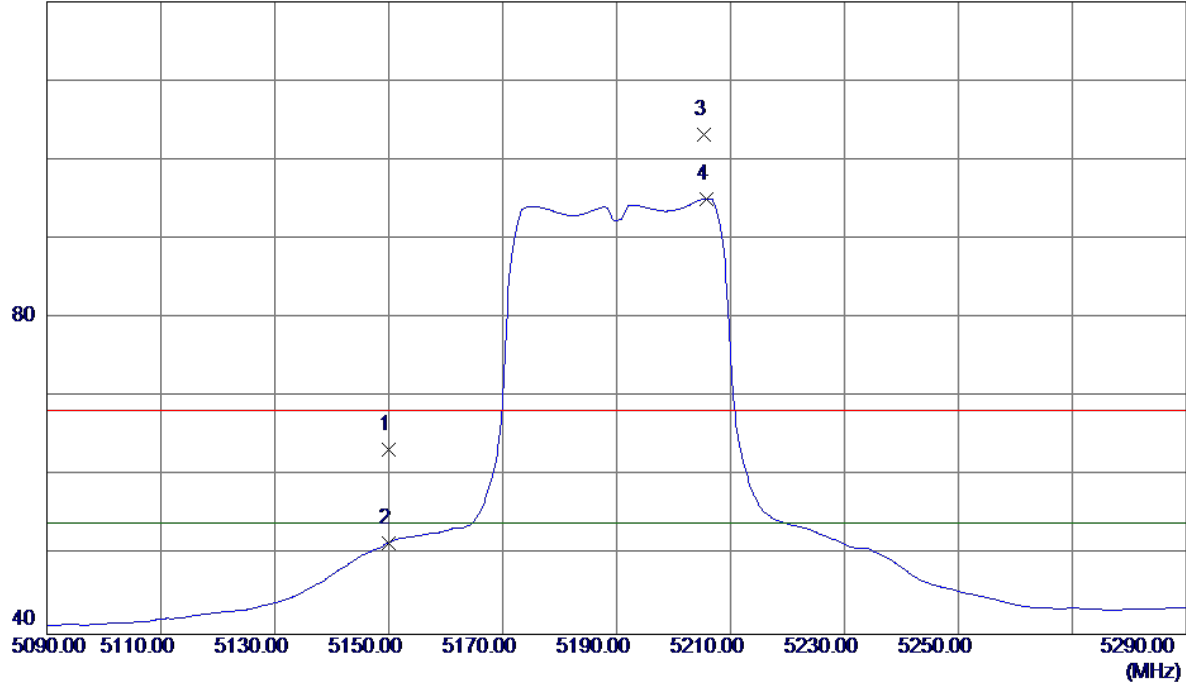

No.	Freq. MHz	Reading Level dBuV/m	Correct Factor dB	Measure ment dBuV/m	Limit dBuV/m	Margin dB	Detector	Comment
1	5150.0000	22.73	40.62	63.35	68.30	-4.95	Peak	
2	5150.0000	10.97	40.62	51.59	54.00	-2.41	AVG	
3	5205.4000	62.38	40.81	103.19	68.30	34.89	Peak	No Limit
4 *	5205.8000	54.29	40.81	95.10	54.00	41.10	AVG	No Limit

Orthogonal Axis:	X
Test Mode:	UNII-1/ TX N40 Mode 5190MHz

Vertical

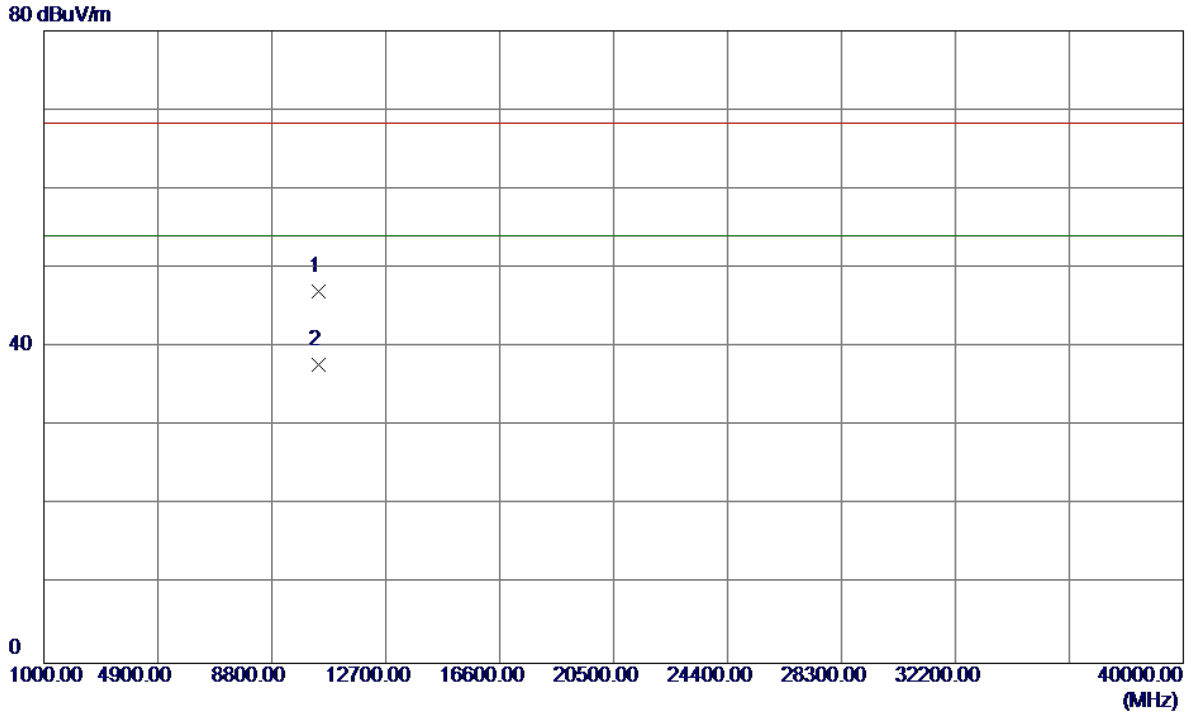

No.	Freq. MHz	Reading Level dBuV/m	Correct Factor dB	Measure ment dBuV/m	Limit dBuV/m	Margin dB	Detector	Comment
1	10386.0000	31.98	15.02	47.00	68.30	-21.30	Peak	
2 *	10386.0000	22.79	15.02	37.81	54.00	-16.19	AVG	

Orthogonal Axis:	X
Test Mode:	UNII-1/ TX N40 Mode 5190MHz

Horizontal

115 dBuV/m

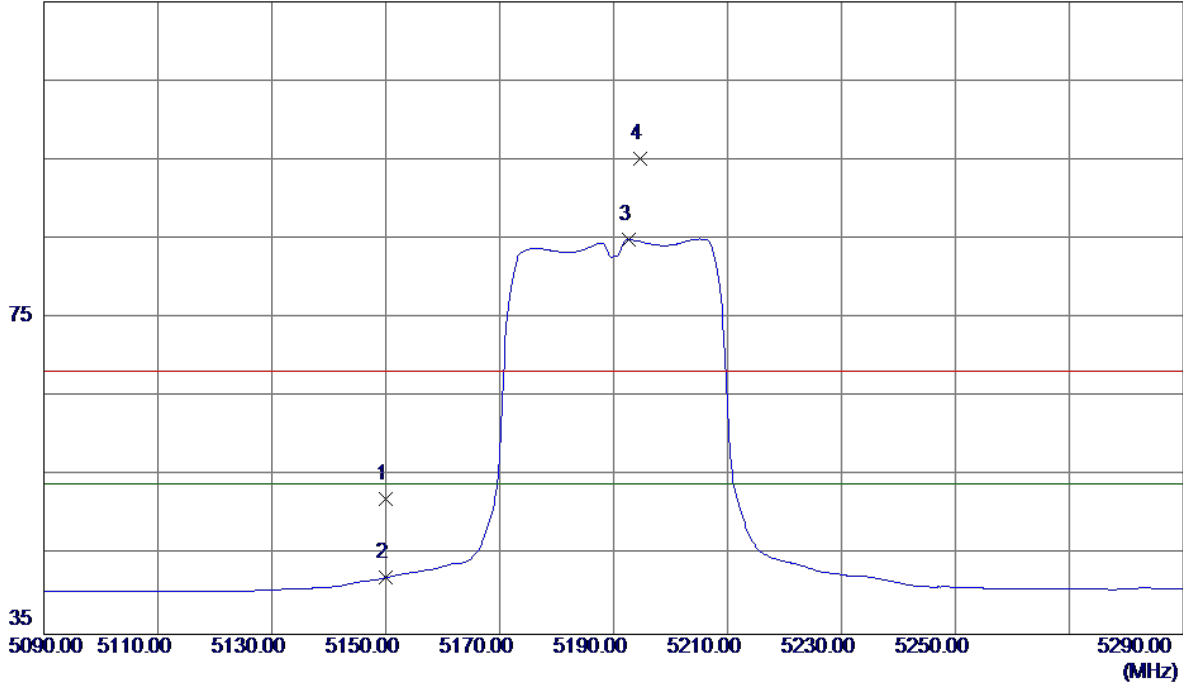

No.	Freq. MHz	Reading Level dBuV/m	Correct Factor dB	Measure ment dBuV/m	Limit dBuV/m	Margin dB	Detector	Comment
1	5150.0000	11.51	40.62	52.13	68.30	-16.17	Peak	
2	5150.0000	1.56	40.62	42.18	54.00	-11.82	AVG	
3 *	5192.6000	44.15	40.77	84.92	54.00	30.92	AVG	No Limit
4	5194.6000	54.39	40.77	95.16	68.30	26.86	Peak	No Limit

Orthogonal Axis:	X
Test Mode:	UNII-1/ TX N40 Mode 5190MHz

Horizontal

80 dBuV/m

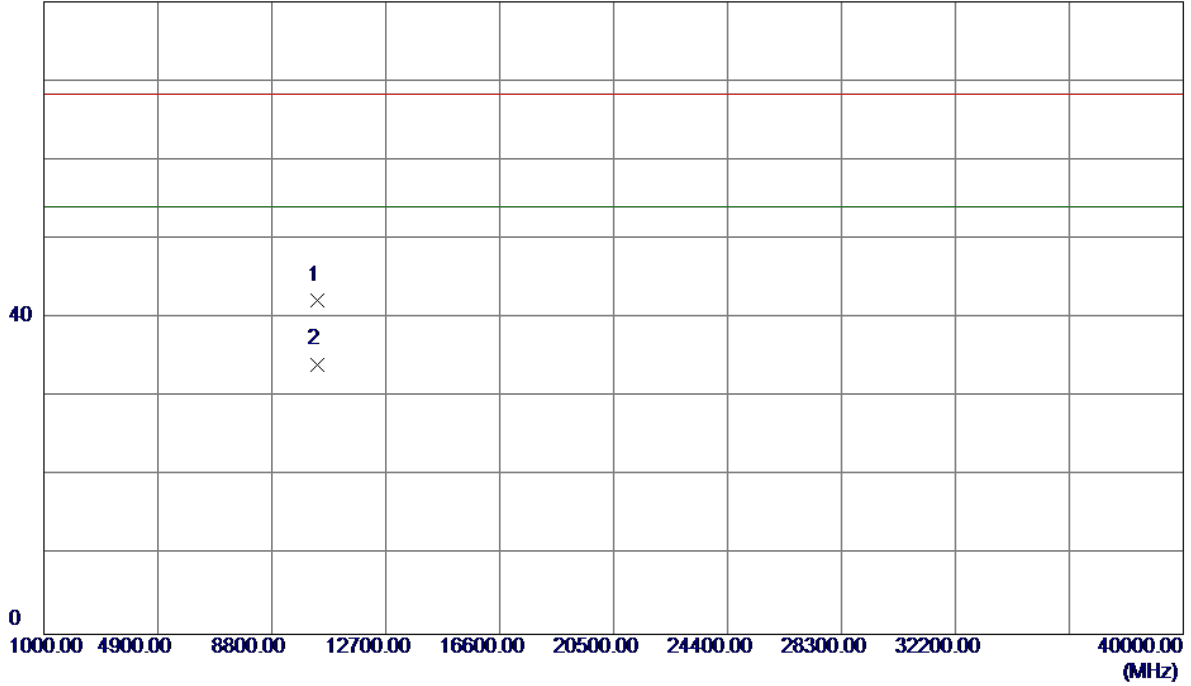

No.	Freq. MHz	Reading Level dBuV/m	Correct Factor dB	Measure ment dBuV/m	Limit dBuV/m	Margin dB	Detector	Comment
1	10379.2000	27.30	15.01	42.31	68.30	-25.99	Peak	
2 *	10381.4000	19.15	15.01	34.16	54.00	-19.84	AVG	

Orthogonal Axis:	X
Test Mode:	UNII-1/ TX N40 Mode 5230MHz

Vertical

120 dBuV/m

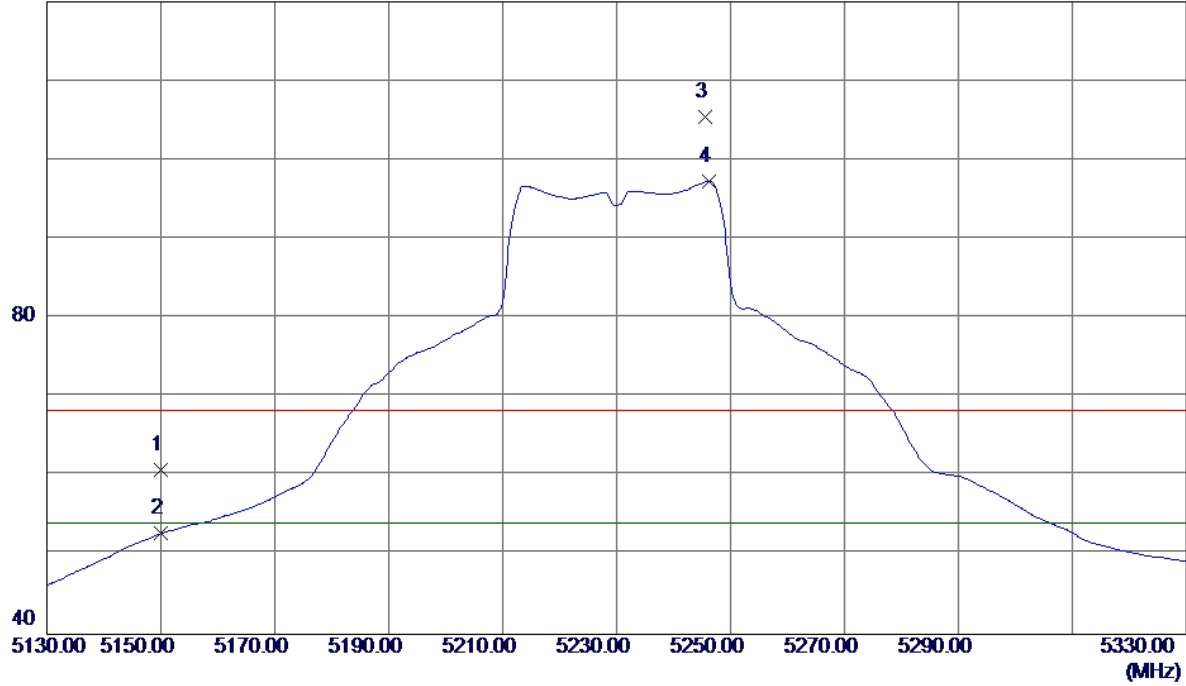

No.	Freq. MHz	Reading Level dBuV/m	Correct Factor dB	Measure ment dBuV/m	Limit dBuV/m	Margin dB	Detector	Comment
1	5150.0000	20.16	40.62	60.78	68.30	-7.52	Peak	
2	5150.0000	12.12	40.62	52.74	54.00	-1.26	AVG	
3	5245.6000	64.47	40.94	105.41	68.30	37.11	Peak	No Limit
4 *	5246.2000	56.31	40.94	97.25	54.00	43.25	AVG	No Limit

Orthogonal Axis:	X
Test Mode:	UNII-1/ TX N40 Mode 5230MHz

Vertical

80 dBuV/m

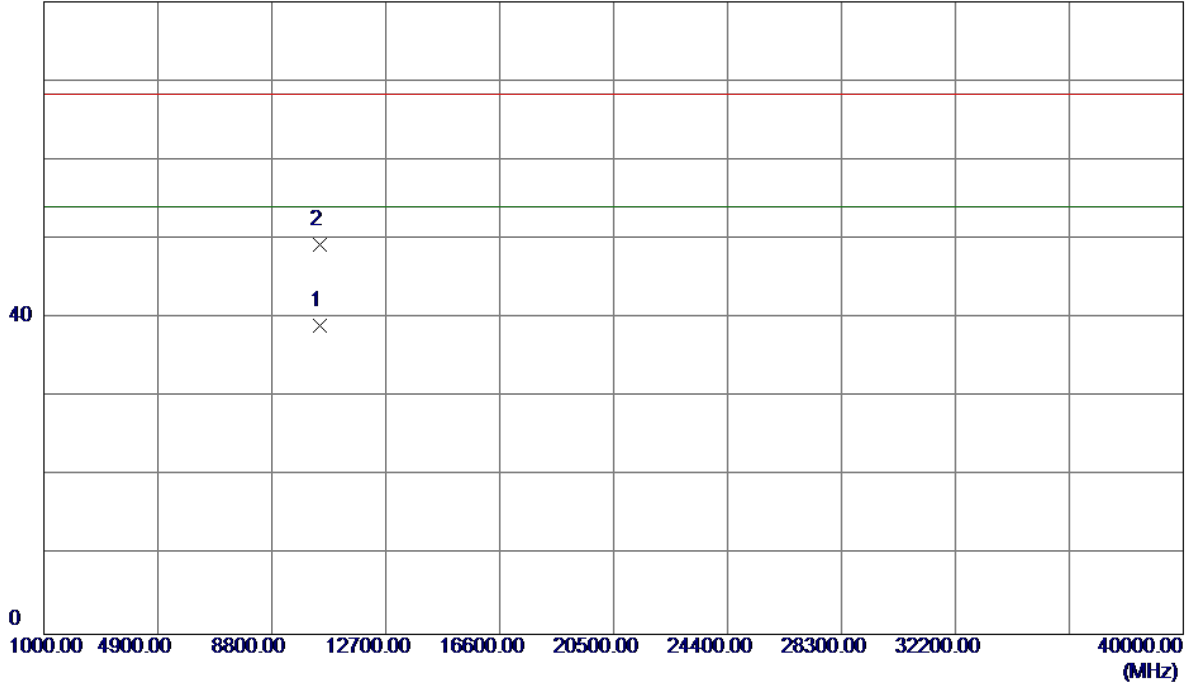

No.	Freq. MHz	Reading Level dBuV/m	Correct Factor dB	Measurement dBuV/m	Limit dBuV/m	Margin dB	Detector	Comment
1 *	10463.5100	23.90	15.20	39.10	54.00	-14.90	AVG	
2	10464.4100	34.03	15.21	49.24	68.30	-19.06	Peak	

Orthogonal Axis:	X
Test Mode:	UNII-1/ TX N40 Mode 5230MHz

Horizontal

115 dBuV/m

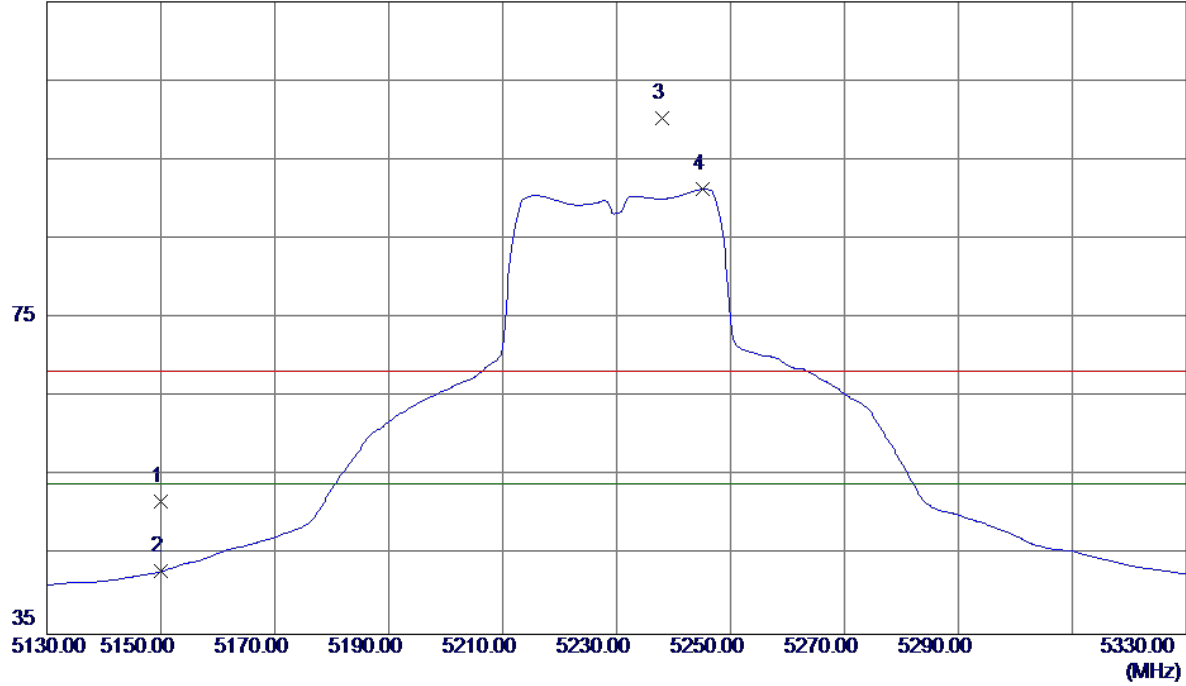

No.	Freq. MHz	Reading Level dBuV/m	Correct Factor dB	Measure ment dBuV/m	Limit dBuV/m	Margin dB	Detector	Comment
1	5150.0000	11.25	40.62	51.87	68.30	-16.43	Peak	
2	5150.0000	2.34	40.62	42.96	54.00	-11.04	AVG	
3	5238.0000	59.37	40.92	100.29	68.30	31.99	Peak	No Limit
4 *	5245.2000	50.33	40.94	91.27	54.00	37.27	AVG	No Limit

Orthogonal Axis:	X
Test Mode:	UNII-1/ TX N40 Mode 5230MHz

Horizontal

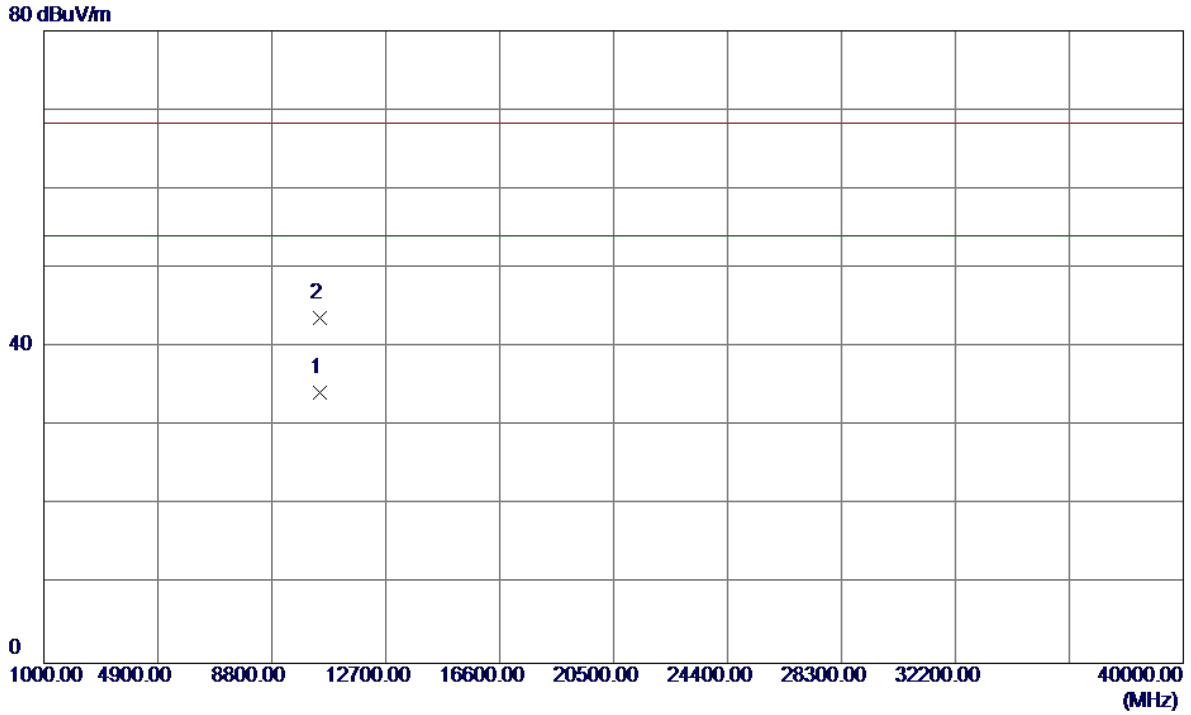

No.	Freq. MHz	Reading Level dBuV/m	Correct Factor dB	Measure ment dBuV/m	Limit dBuV/m	Margin dB	Detector	Comment
1 *	10458.2000	19.11	15.19	34.30	54.00	-19.70	AVG	
2	10460.6000	28.45	15.20	43.65	68.30	-24.65	Peak	

Orthogonal Axis:	X
Test Mode:	UNII-3/TX A Mode 5745MHz

Vertical

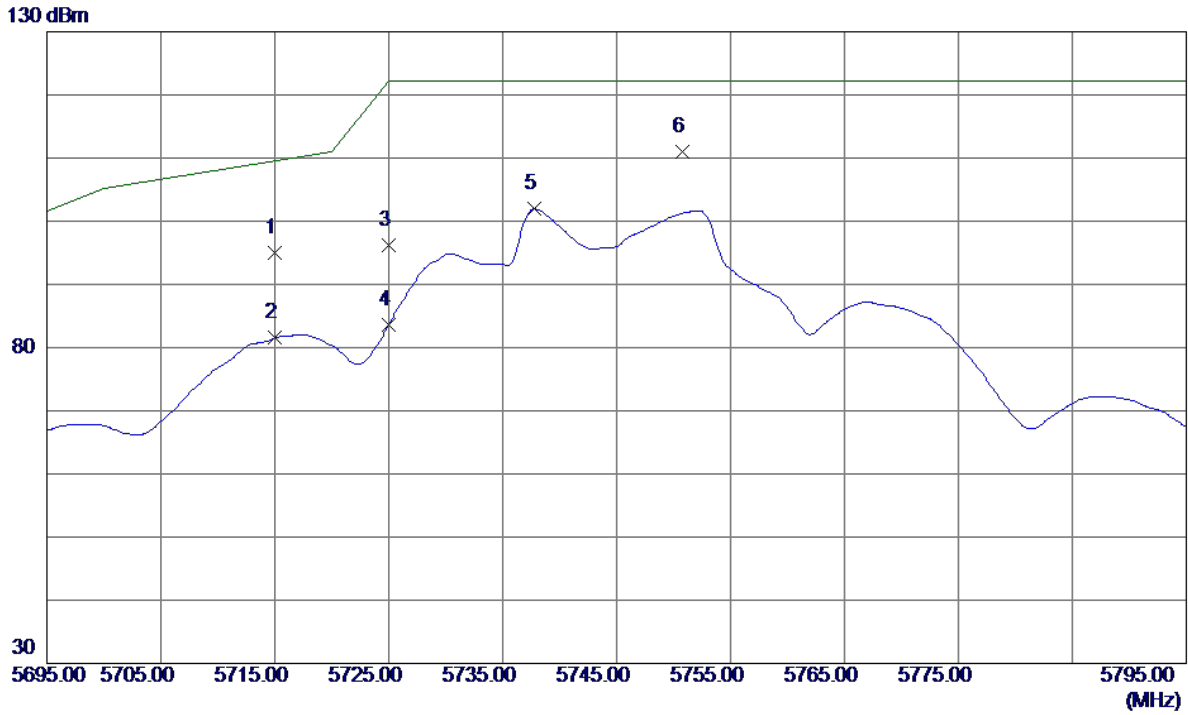

No.	Freq. MHz	Reading Level dBm	Correct Factor dB	Measure ment dBm	Limit dBm	Margin dB	Detector	Comment
1	5715.0000	52.41	42.55	94.96	109.50	-14.54	Peak	
2	5715.0000	38.96	42.55	81.51	109.50	-27.99	AVG	
3	5725.0000	53.63	42.58	96.21	122.30	-26.09	Peak	
4	5725.0000	41.08	42.58	83.66	122.30	-38.64	AVG	
5	5737.8000	59.29	42.63	101.92	122.30	-20.38	AVG	
6 *	5750.8000	68.43	42.67	111.10	122.30	-11.20	Peak	

Orthogonal Axis:	X
Test Mode:	UNII-3/TX A Mode 5745MHz

Vertical

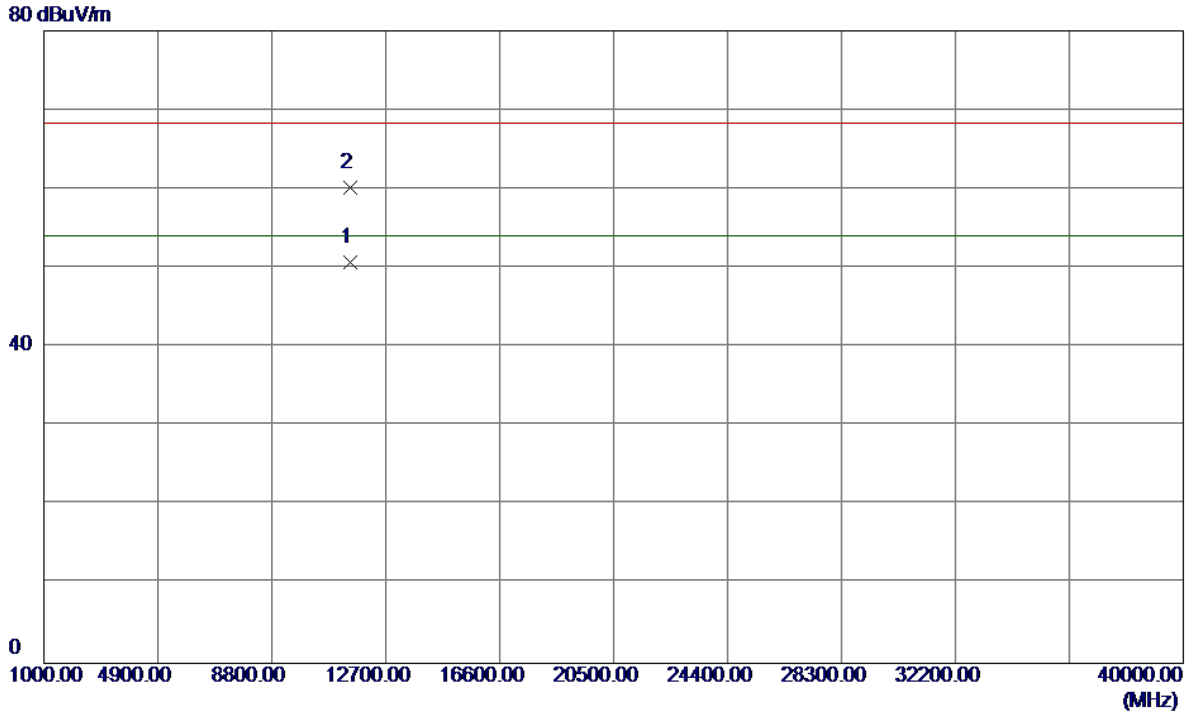

No.	Freq. MHz	Reading Level dBuV/m	Correct Factor dB	Measure ment dBuV/m	Limit dBuV/m	Margin dB	Detector	Comment
1 *	11486.9000	35.16	15.49	50.65	54.00	-3.35	AVG	
2	11487.7000	44.62	15.49	60.11	68.30	-8.19	Peak	

Orthogonal Axis:	X
Test Mode:	UNII-3/TX A Mode 5745MHz

Horizontal

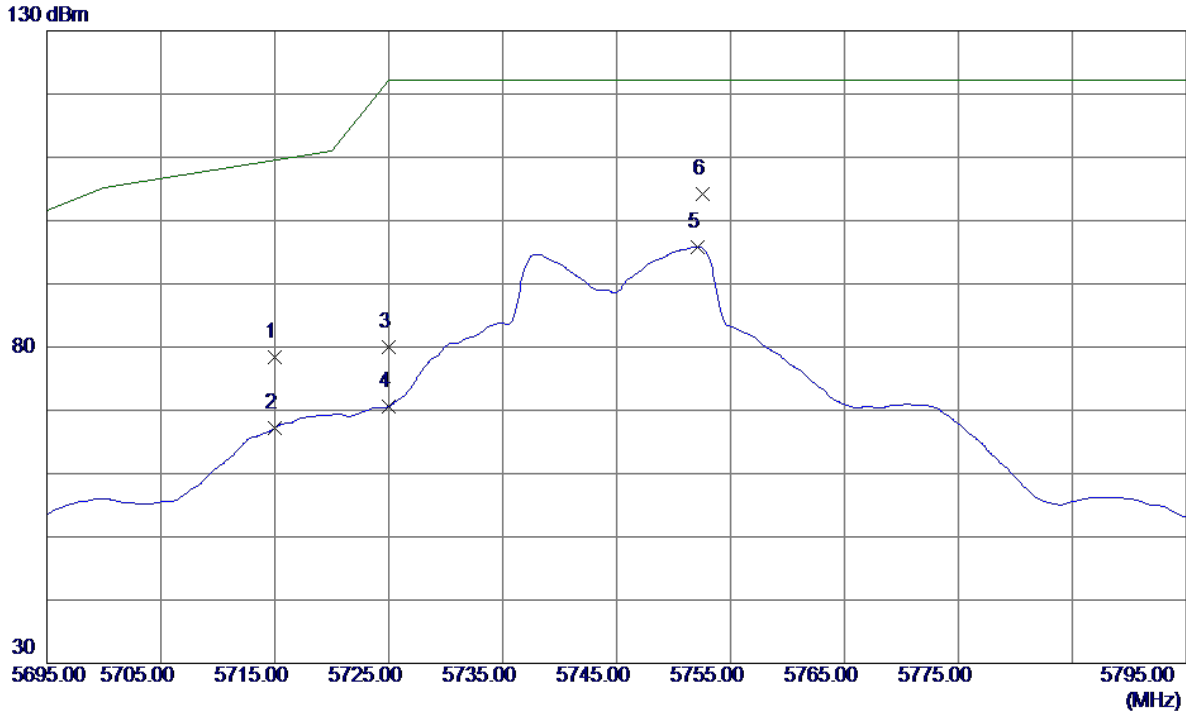

No.	Freq. MHz	Reading Level dBm	Correct Factor dB	Measure ment dBm	Limit dBm	Margin dB	Detector	Comment
1	5715.0000	35.90	42.55	78.45	109.50	-31.05	Peak	
2	5715.0000	24.67	42.55	67.22	109.50	-42.28	AVG	
3	5725.0000	37.40	42.58	79.98	122.30	-42.32	Peak	
4	5725.0000	28.02	42.58	70.60	122.30	-51.70	AVG	
5	5752.1000	53.15	42.68	95.83	122.30	-26.47	AVG	
6 *	5752.6000	61.52	42.68	104.20	122.30	-18.10	Peak	

Orthogonal Axis:	X
Test Mode:	UNII-3/TX A Mode 5745MHz

Horizontal

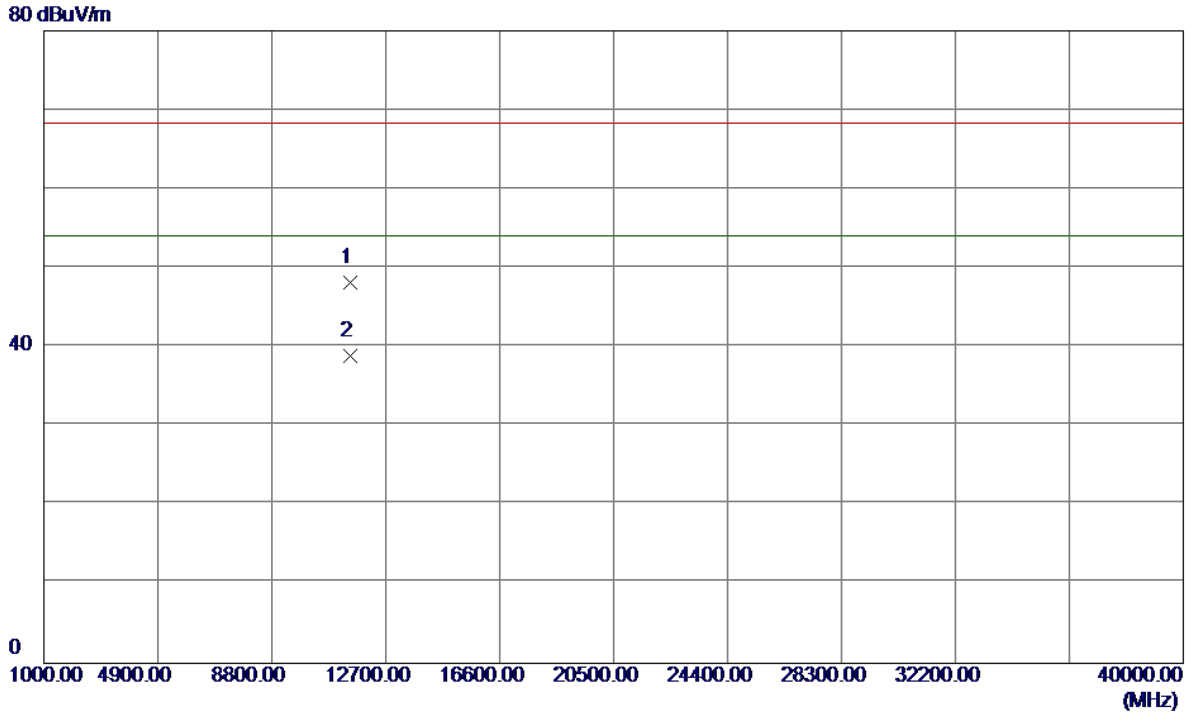

No.	Freq. MHz	Reading Level dBuV/m	Correct Factor dB	Measure ment dBuV/m	Limit dBuV/m	Margin dB	Detector	Comment
1	11488.8000	32.67	15.49	48.16	68.30	-20.14	Peak	
2 *	11489.0000	23.37	15.49	38.86	54.00	-15.14	AVG	

Orthogonal Axis:	X
Test Mode:	UNII-3/TX A Mode 5785MHz

Vertical

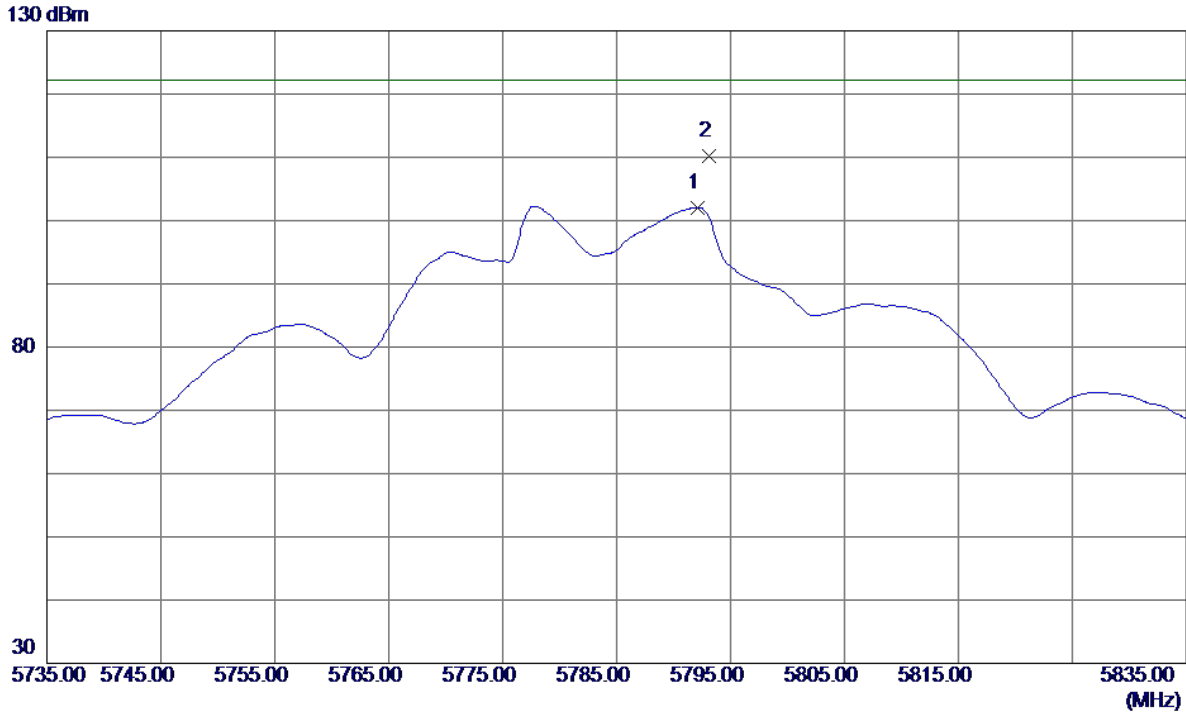

No.	Freq. MHz	Reading Level dBm	Correct Factor dB	Measure ment dBm	Limit dBm	Margin dB	Detector	Comment
1	5792.1000	59.25	42.82	102.07	122.30	-20.23	AVG	
2 *	5793.1000	67.34	42.82	110.16	122.30	-12.14	Peak	

Orthogonal Axis:	X
Test Mode:	UNII-3/TX A Mode 5785MHz

Vertical

80 dBuV/m

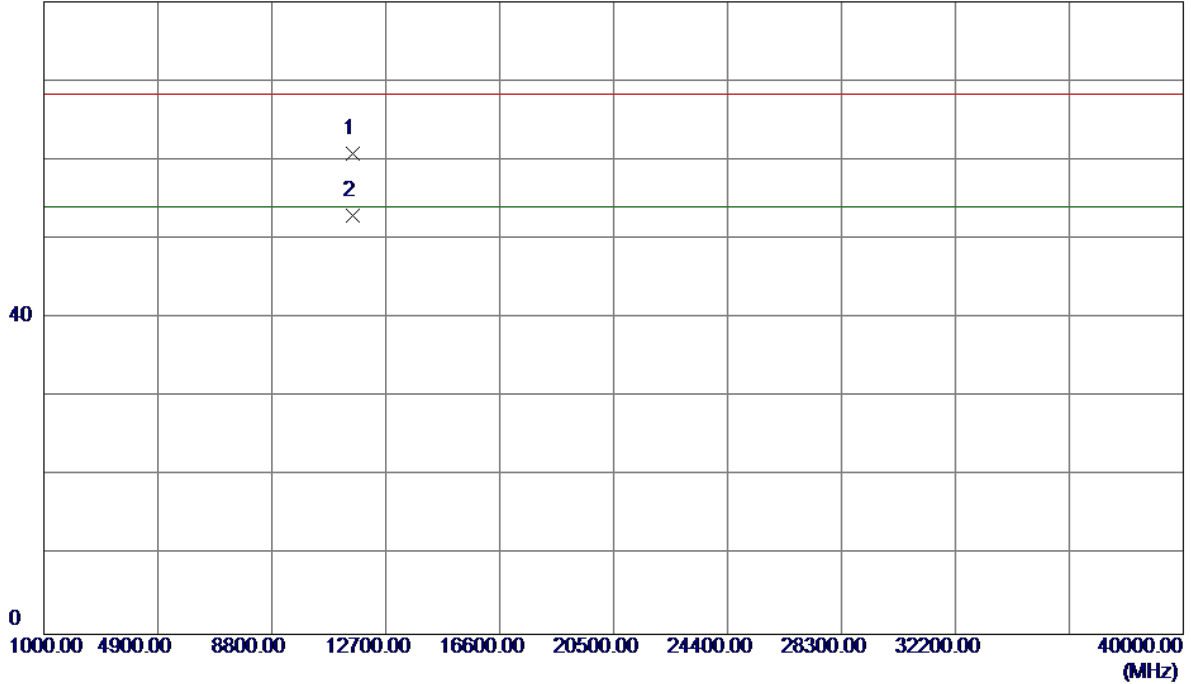

No.	Freq. MHz	Reading Level dBuV/m	Correct Factor dB	Measure ment dBuV/m	Limit dBuV/m	Margin dB	Detector	Comment
1	11570.4000	45.37	15.48	60.85	68.30	-7.45	Peak	
2 *	11572.0000	37.50	15.48	52.98	54.00	-1.02	AVG	

Orthogonal Axis:	X
Test Mode:	UNII-3/TX A Mode 5785MHz

Horizontal

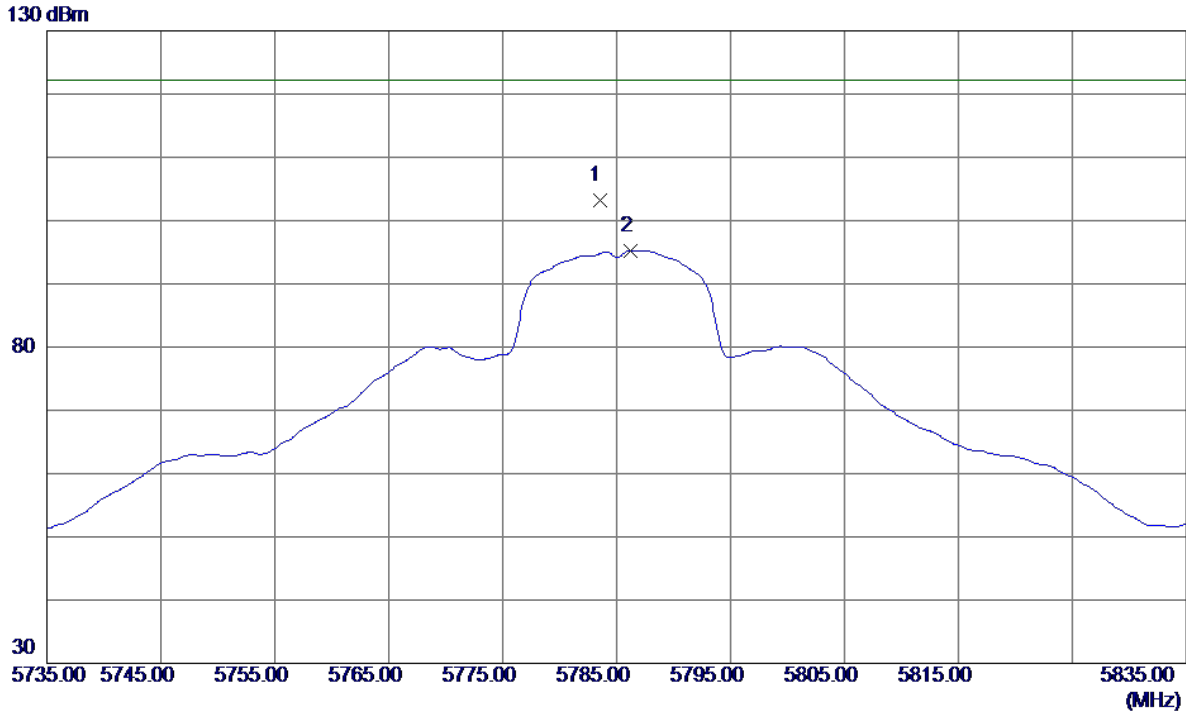

No.	Freq. MHz	Reading Level dBm	Correct Factor dB	Measure ment dBm	Limit dBm	Margin dB	Detector	Comment
1 *	5783.5000	60.48	42.79	103.27	122.30	-19.03	Peak	
2	5786.2000	52.46	42.80	95.26	122.30	-27.04	AVG	

Orthogonal Axis:	X
Test Mode:	UNII-3/TX A Mode 5785MHz

Horizontal

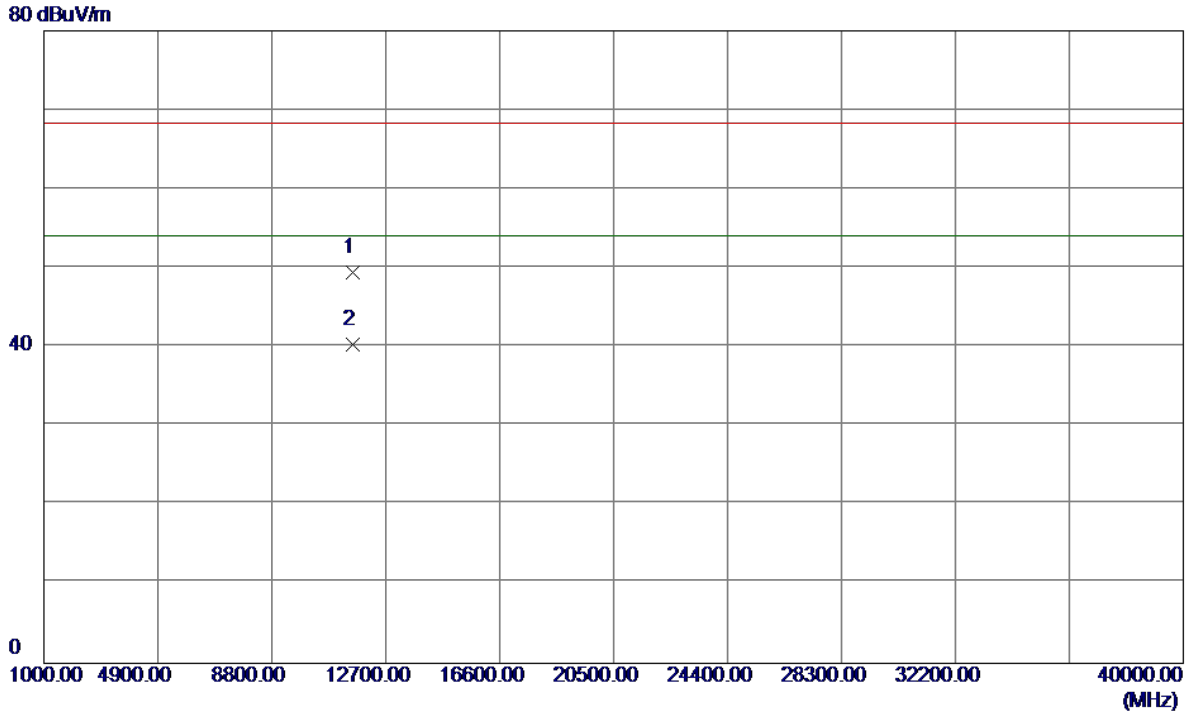

No.	Freq. MHz	Reading Level dBuV/m	Correct Factor dB	Measure ment dBuV/m	Limit dBuV/m	Margin dB	Detector	Comment
1	11567.8000	34.03	15.48	49.51	68.30	-18.79	Peak	
2 *	11571.2000	24.78	15.48	40.26	54.00	-13.74	AVG	

Orthogonal Axis:	X
Test Mode:	UNII-3/TX A Mode 5825MHz

Vertical

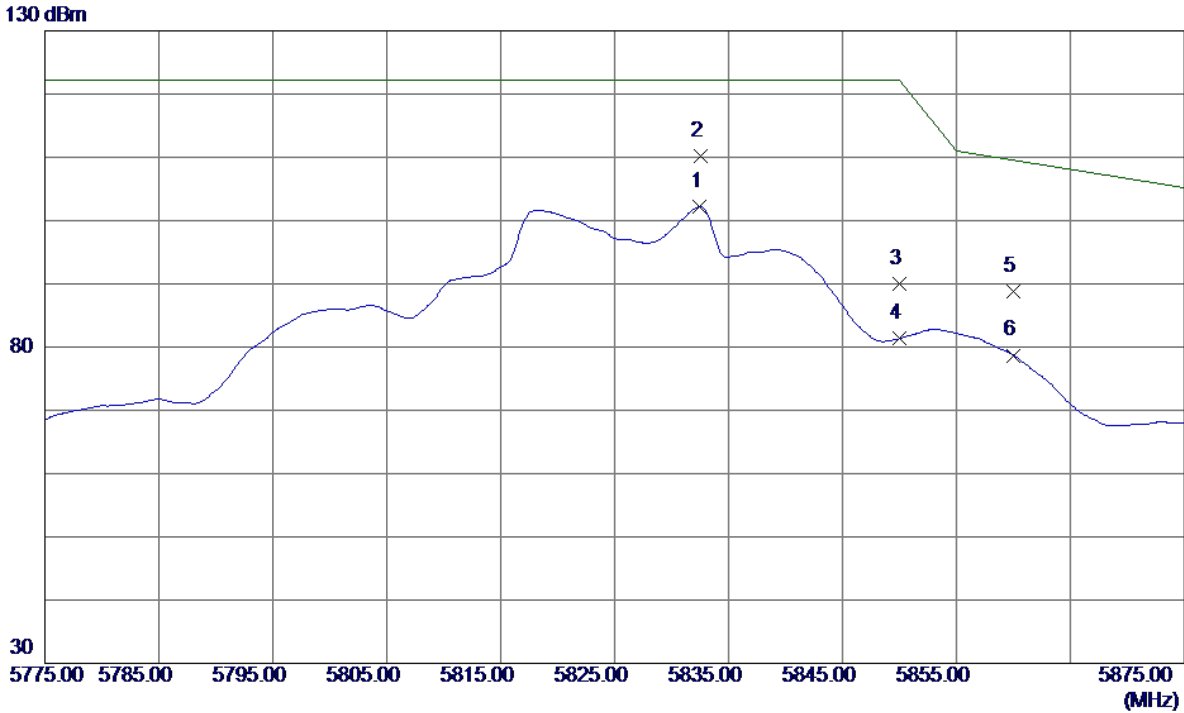

No.	Freq. MHz	Reading Level dBm	Correct Factor dB	Measure ment dBm	Limit dBm	Margin dB	Detector	Comment
1	5832.5000	59.26	42.96	102.22	122.30	-20.08	AVG	
2 *	5832.6000	67.29	42.96	110.25	122.30	-12.05	Peak	
3	5850.0000	47.00	43.03	90.03	122.30	-32.27	Peak	
4	5850.0000	38.30	43.03	81.33	122.30	-40.97	AVG	
5	5860.0000	45.71	43.06	88.77	109.50	-20.73	Peak	
6	5860.0000	35.64	43.06	78.70	109.50	-30.80	AVG	

Orthogonal Axis:	X
Test Mode:	UNII-3/TX A Mode 5825MHz

Vertical

80 dBuV/m

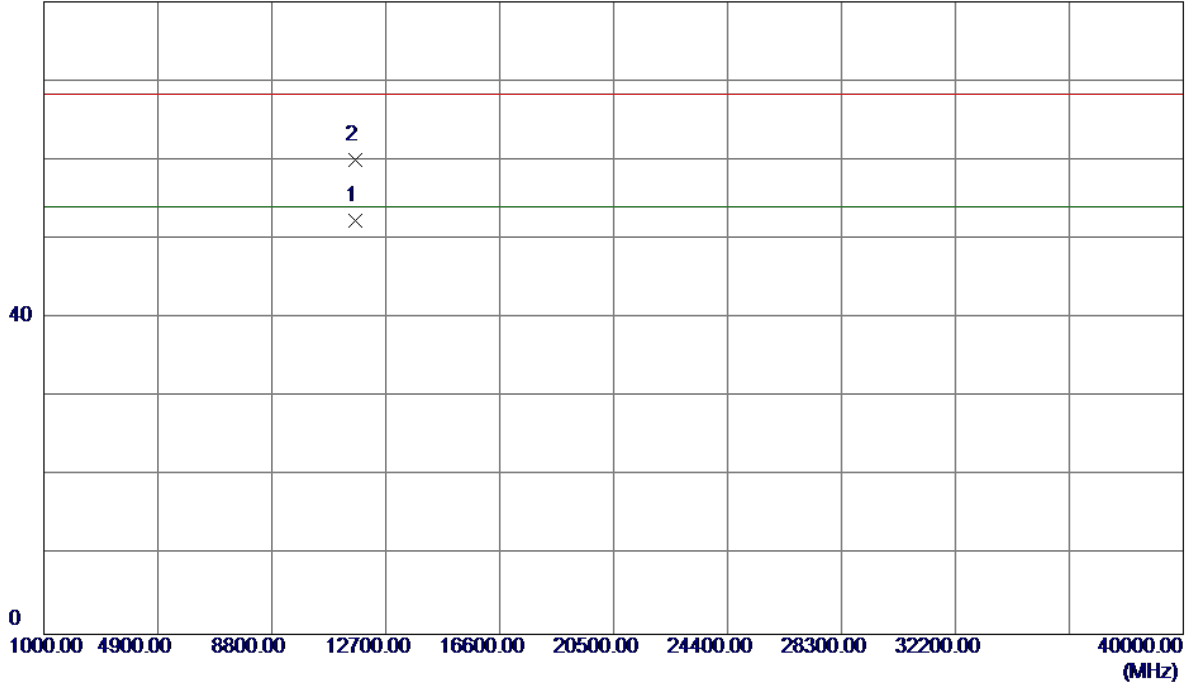

No.	Freq. MHz	Reading Level dBuV/m	Correct Factor dB	Measure ment dBuV/m	Limit dBuV/m	Margin dB	Detector	Comment
1 *	11652.2000	36.81	15.48	52.29	54.00	-1.71	AVG	
2	11654.8000	44.47	15.48	59.95	68.30	-8.35	Peak	

Orthogonal Axis:	X
Test Mode:	UNII-3/TX A Mode 5825MHz

Horizontal

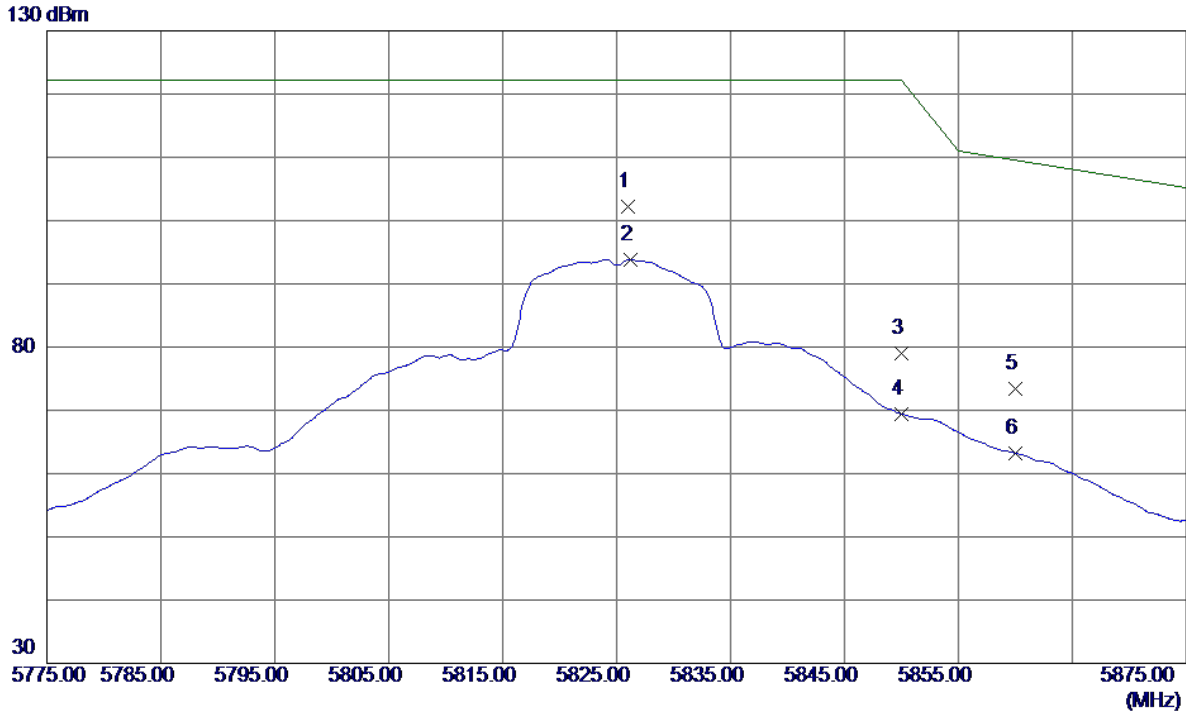

No.	Freq. MHz	Reading Level dBm	Correct Factor dB	Measure ment dBm	Limit dBm	Margin dB	Detector	Comment
1 *	5826.0000	59.22	42.94	102.16	122.30	-20.14	Peak	
2	5826.2000	50.90	42.94	93.84	122.30	-28.46	AVG	
3	5850.0000	35.91	43.03	78.94	122.30	-43.36	Peak	
4	5850.0000	26.36	43.03	69.39	122.30	-52.91	AVG	
5	5860.0000	30.34	43.06	73.40	109.50	-36.10	Peak	
6	5860.0000	20.17	43.06	63.23	109.50	-46.27	AVG	

Orthogonal Axis:	X
Test Mode:	UNII-3/TX A Mode 5825MHz

Horizontal

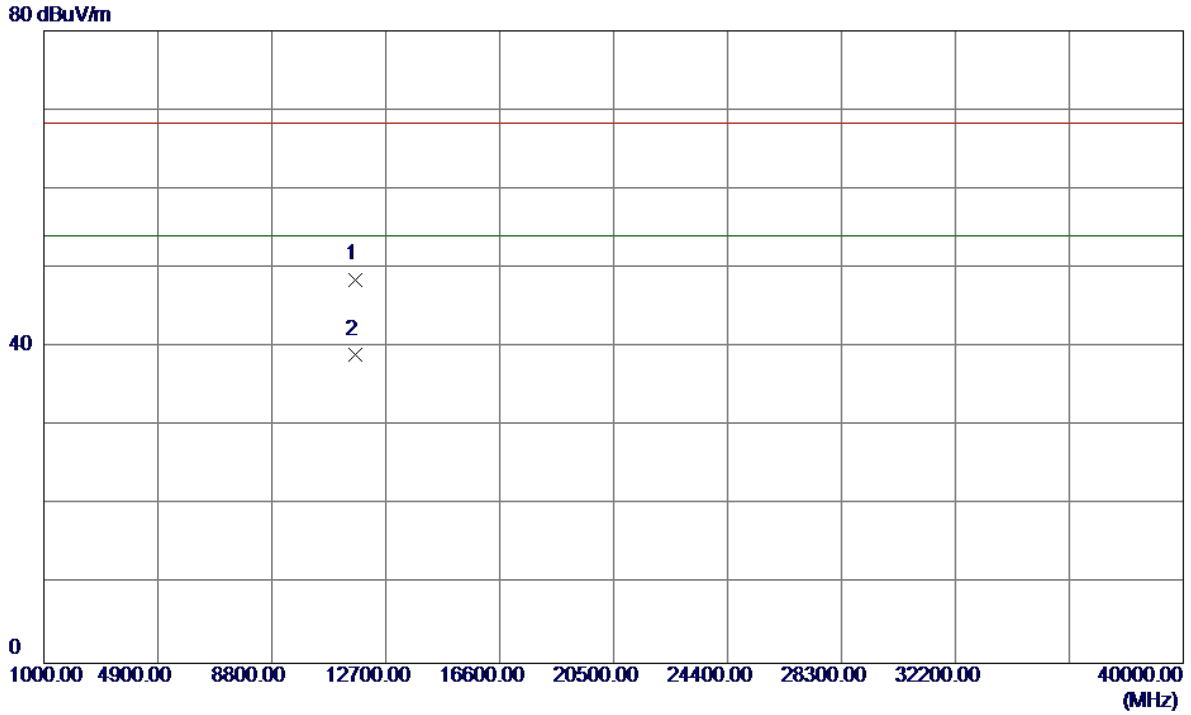

No.	Freq. MHz	Reading Level dBuV/m	Correct Factor dB	Measure ment dBuV/m	Limit dBuV/m	Margin dB	Detector	Comment
1	11647.4000	33.08	15.48	48.56	68.30	-19.74	Peak	
2 *	11649.4000	23.51	15.48	38.99	54.00	-15.01	AVG	

Orthogonal Axis:	X
Test Mode:	UNII-3/TX N20 Mode 5745MHz

Vertical

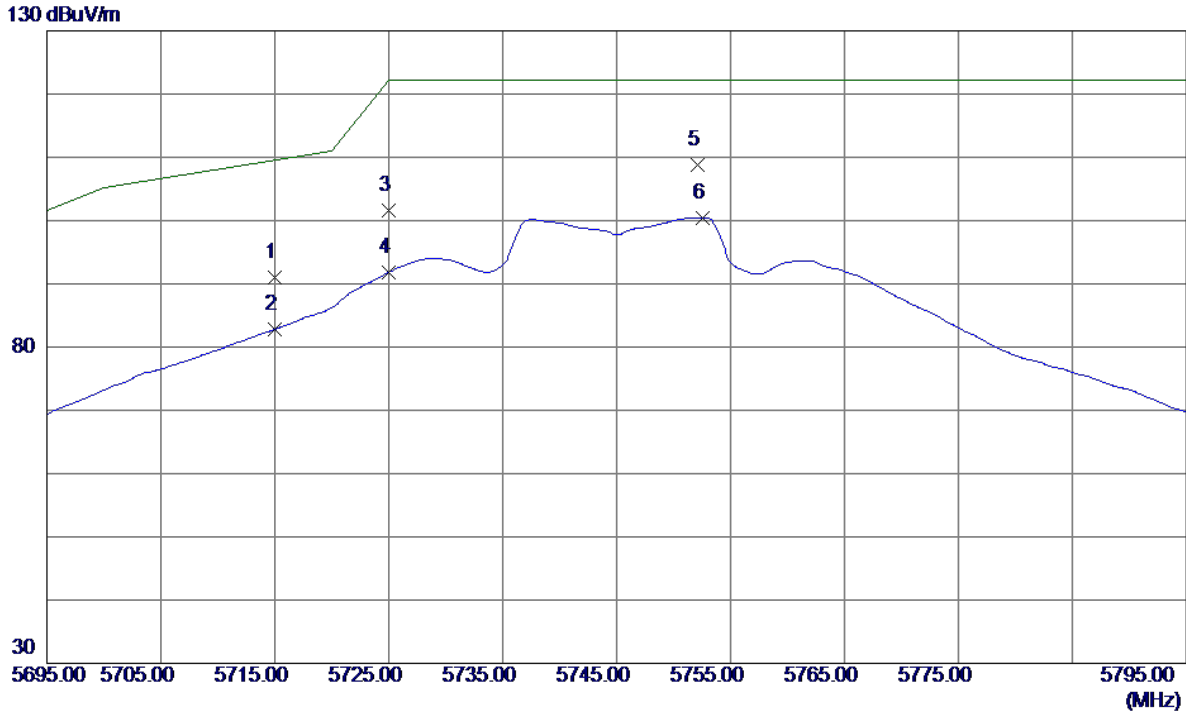

No.	Freq. MHz	Reading Level dBuV/m	Correct Factor dB	Measure ment dBuV/m	Limit dBuV/m	Margin dB	Detector	Comment
1	5715.0000	48.39	42.55	90.94	109.50	-18.56	Peak	
2	5715.0000	40.24	42.55	82.79	109.50	-26.71	AVG	
3	5725.0000	59.02	42.58	101.60	122.30	-20.70	Peak	
4	5725.0000	49.24	42.58	91.82	122.30	-30.48	AVG	
5 *	5752.1000	66.17	42.68	108.85	122.30	-13.45	Peak	
6	5752.6000	57.81	42.68	100.49	122.30	-21.81	AVG	

Orthogonal Axis:	X
Test Mode:	UNII-3/TX N20 Mode 5745MHz

Vertical

80 dBuV/m

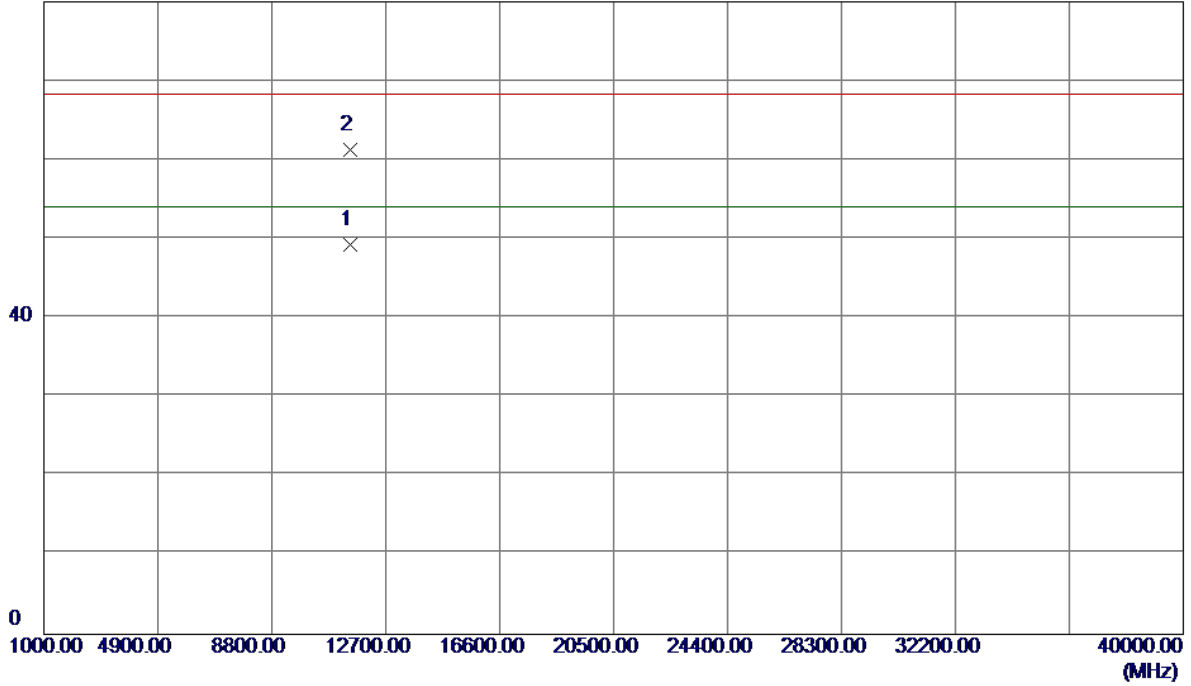

No.	Freq. MHz	Reading Level dBuV/m	Correct Factor dB	Measure ment dBuV/m	Limit dBuV/m	Margin dB	Detector	Comment
1 *	11489.1000	33.84	15.49	49.33	54.00	-4.67	AVG	
2	11490.9000	45.76	15.49	61.25	68.30	-7.05	Peak	

Orthogonal Axis:	X
Test Mode:	UNII-3/TX N20 Mode 5745MHz

Horizontal

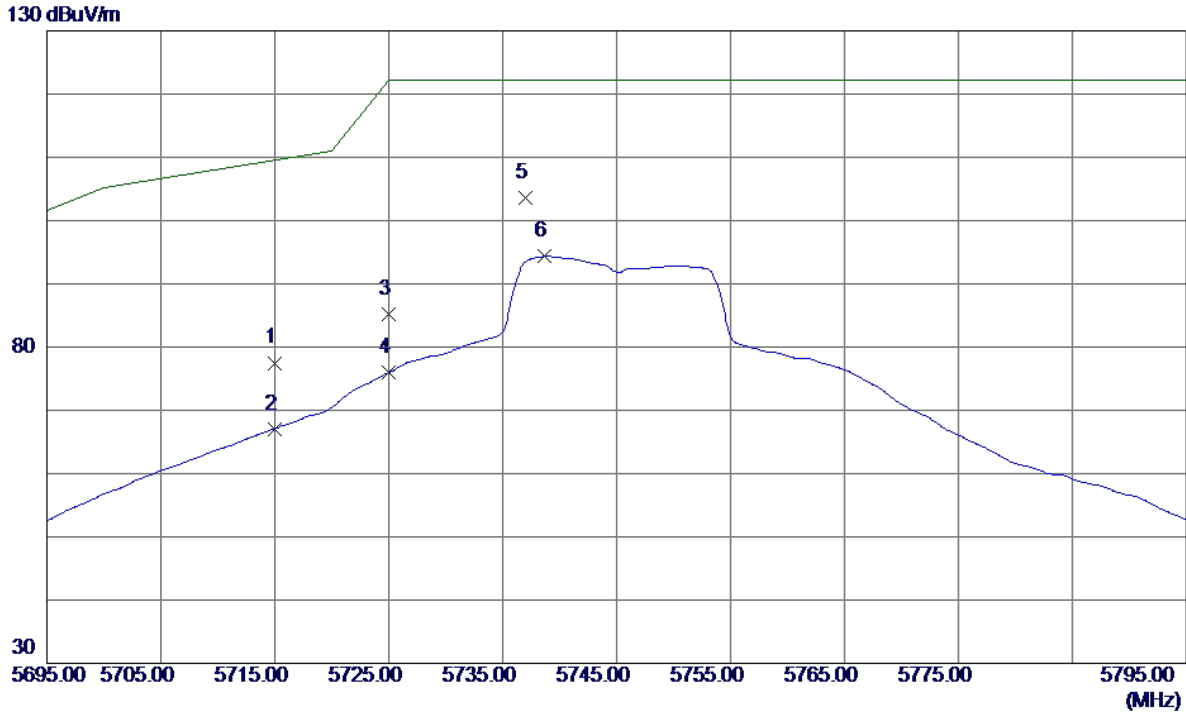

No.	Freq. MHz	Reading Level dBuV/m	Correct Factor dB	Measure ment dBuV/m	Limit dBuV/m	Margin dB	Detector	Comment
1	5715.0000	34.95	42.55	77.50	109.50	-32.00	Peak	
2	5715.0000	24.53	42.55	67.08	109.50	-42.42	AVG	
3	5725.0000	42.71	42.58	85.29	122.30	-37.01	Peak	
4	5725.0000	33.37	42.58	75.95	122.30	-46.35	AVG	
5 *	5737.0000	61.07	42.62	103.69	122.30	-18.61	Peak	
6	5738.7000	51.70	42.63	94.33	122.30	-27.97	AVG	

Orthogonal Axis:	X
Test Mode:	UNII-3/TX N20 Mode 5745MHz

Horizontal

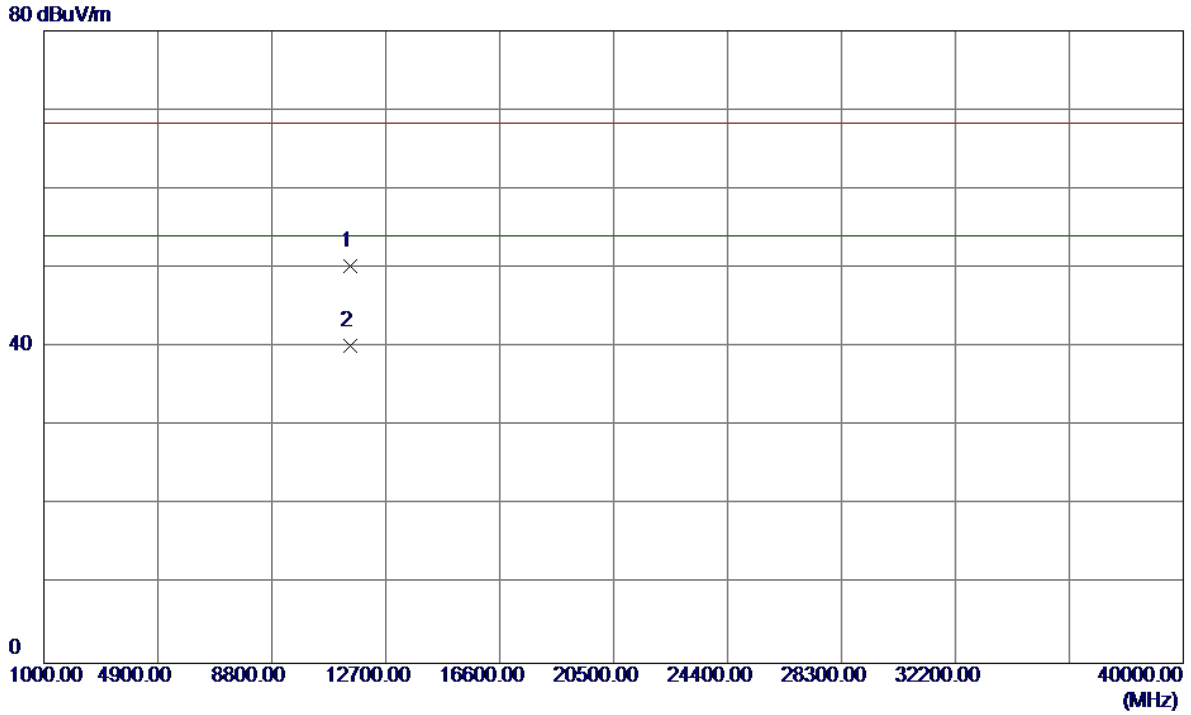

No.	Freq. MHz	Reading Level dBuV/m	Correct Factor dB	Measure ment dBuV/m	Limit dBuV/m	Margin dB	Detector	Comment
1	11486.8000	34.81	15.49	50.30	68.30	-18.00	Peak	
2 *	11488.4000	24.70	15.49	40.19	54.00	-13.81	AVG	

Orthogonal Axis:	X
Test Mode:	UNII-3/TX N20 Mode 5785MHz

Vertical

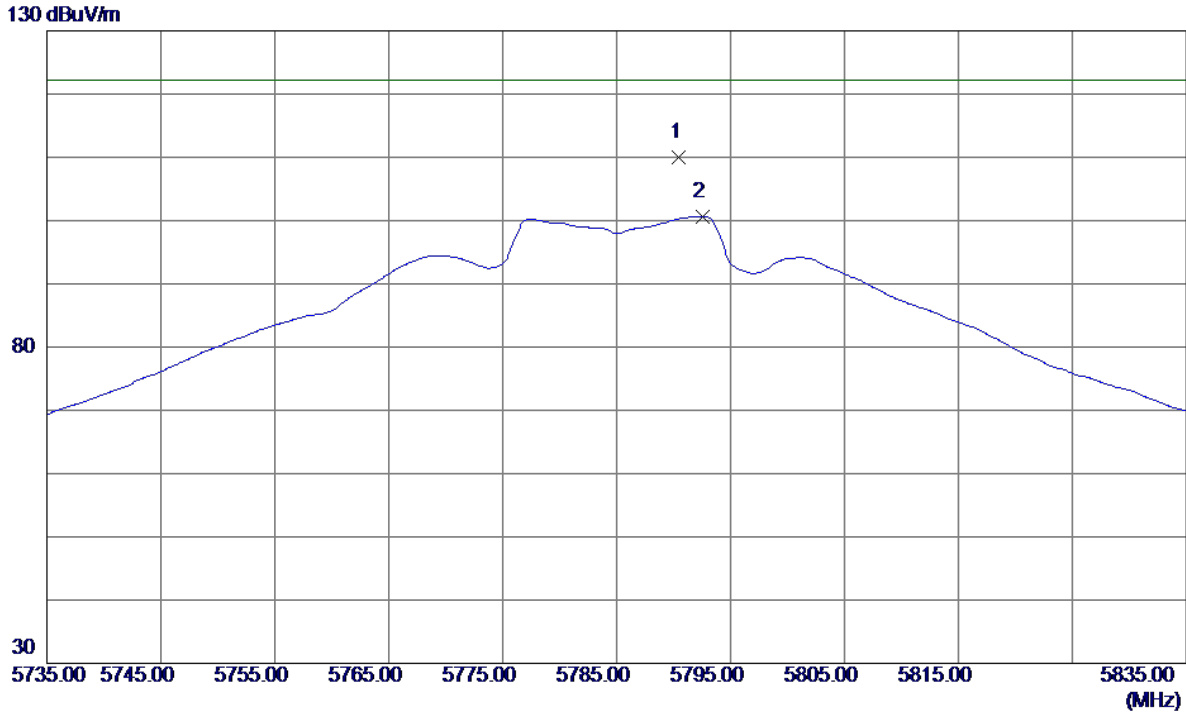

No.	Freq. MHz	Reading Level dBuV/m	Correct Factor dB	Measure ment dBuV/m	Limit dBuV/m	Margin dB	Detector	Comment
1 *	5790.5000	67.25	42.81	110.06	122.30	-12.24	Peak	
2	5792.6000	57.81	42.82	100.63	122.30	-21.67	AVG	

Orthogonal Axis:	X
Test Mode:	UNII-3/TX N20 Mode 5785MHz

Vertical

80 dBuV/m

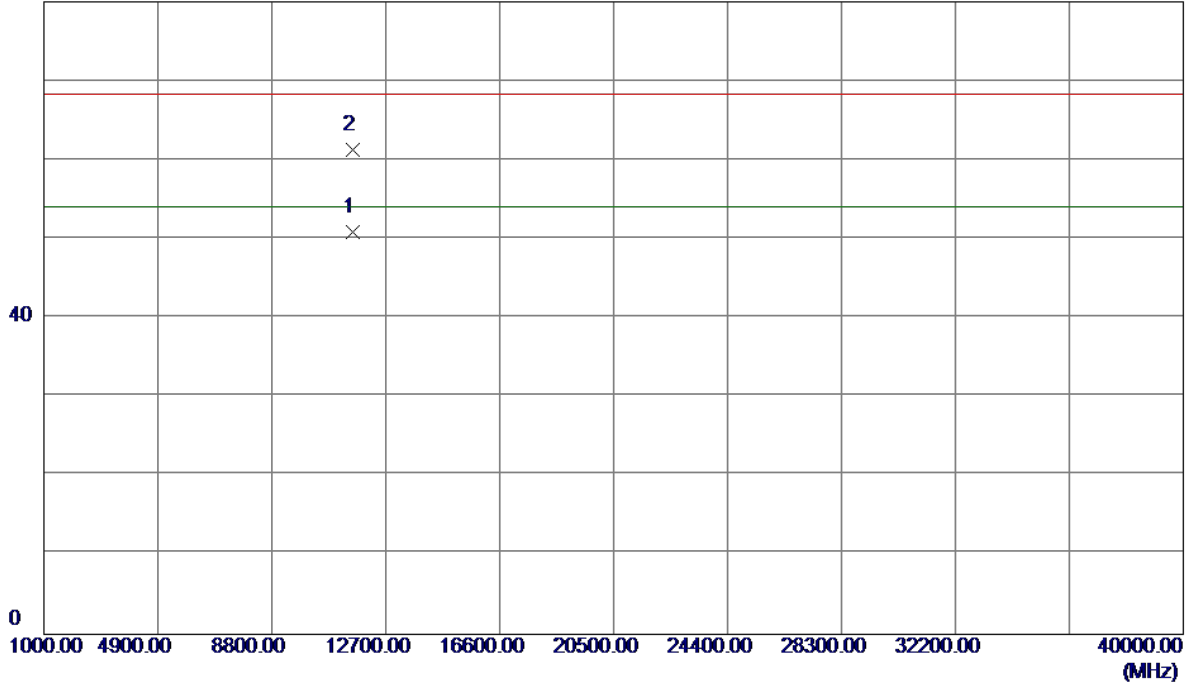

No.	Freq. MHz	Reading Level dBuV/m	Correct Factor dB	Measure ment dBuV/m	Limit dBuV/m	Margin dB	Detector	Comment
1 *	11569.4000	35.43	15.48	50.91	54.00	-3.09	AVG	
2	11571.1000	45.75	15.48	61.23	68.30	-7.07	Peak	

Orthogonal Axis:	X
Test Mode:	UNII-3/TX N20 Mode 5785MHz

Horizontal

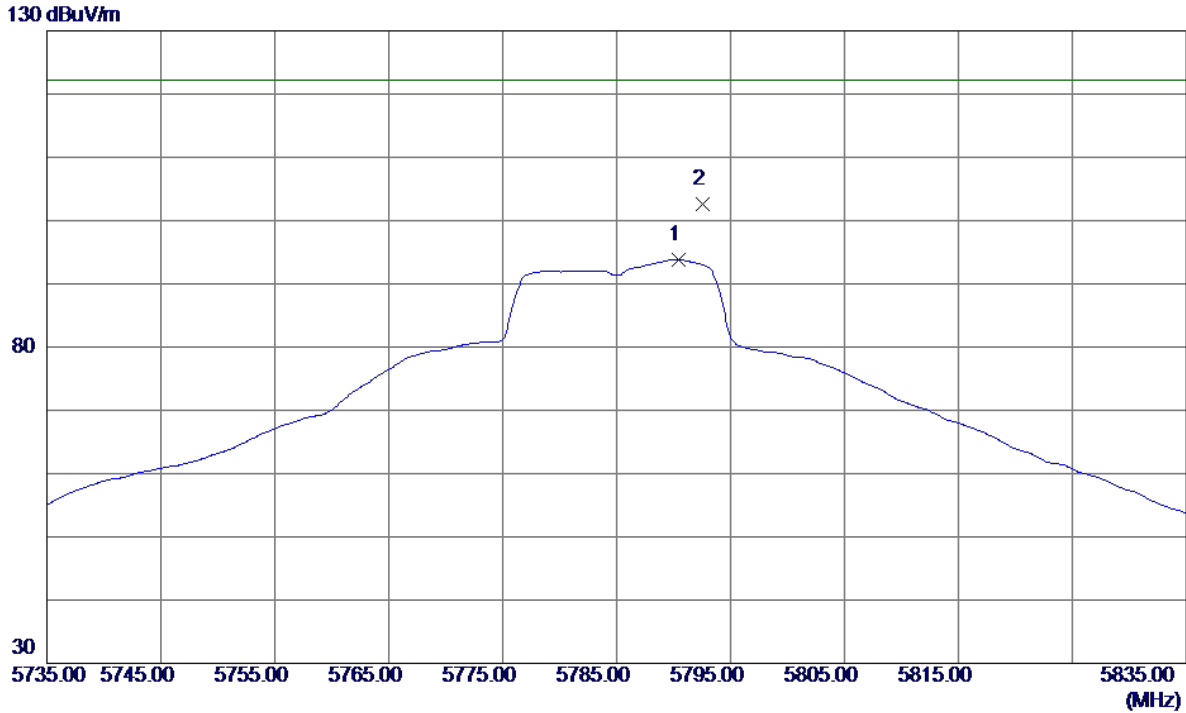

No.	Freq. MHz	Reading Level dBuV/m	Correct Factor dB	Measure ment dBuV/m	Limit dBuV/m	Margin dB	Detector	Comment
1	5790.4000	50.96	42.81	93.77	122.30	-28.53	AVG	
2 *	5792.6000	59.71	42.82	102.53	122.30	-19.77	Peak	

Orthogonal Axis:	X
Test Mode:	UNII-3/TX N20 Mode 5785MHz

Horizontal

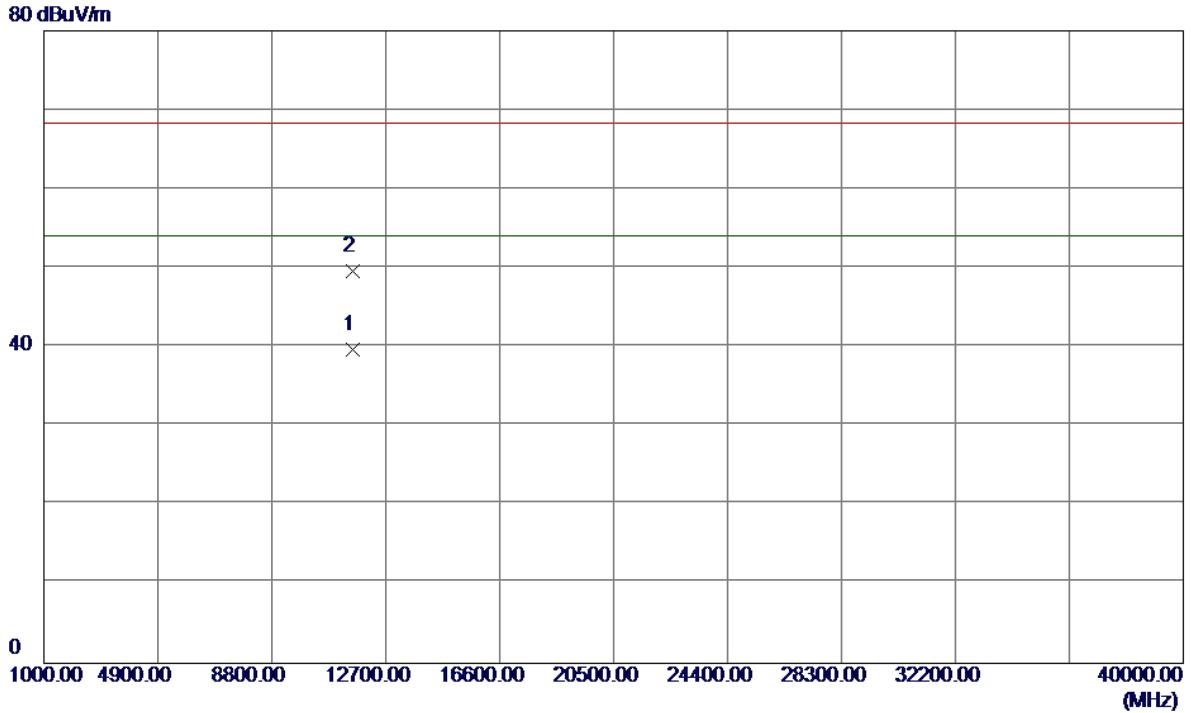

No.	Freq. MHz	Reading Level dBuV/m	Correct Factor dB	Measure ment dBuV/m	Limit dBuV/m	Margin dB	Detector	Comment
1 *	11570.4000	24.20	15.48	39.68	54.00	-14.32	AVG	
2	11570.6000	34.14	15.48	49.62	68.30	-18.68	Peak	

Orthogonal Axis:	X
Test Mode:	UNII-3/TX N20 Mode 5825MHz

Vertical

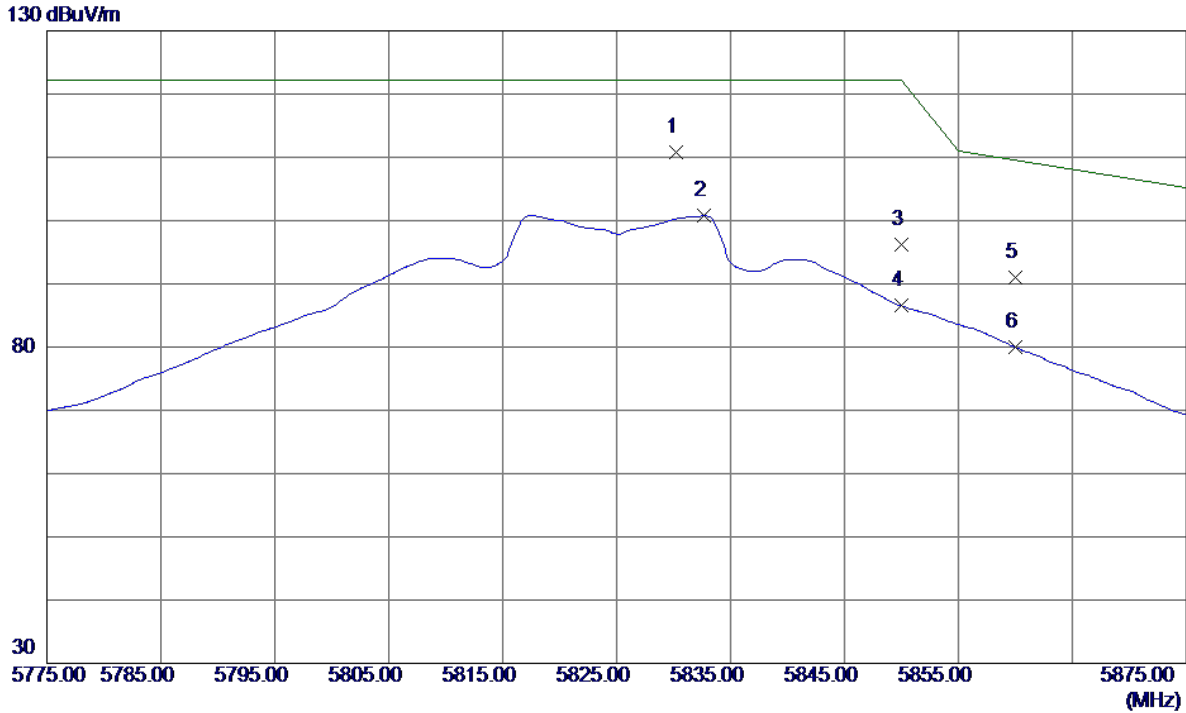

No.	Freq. MHz	Reading Level dBuV/m	Correct Factor dB	Measure ment dBuV/m	Limit dBuV/m	Margin dB	Detector	Comment
1 *	5830.2000	67.87	42.96	110.83	122.30	-11.47	Peak	
2	5832.7000	57.79	42.96	100.75	122.30	-21.55	AVG	
3	5850.0000	53.12	43.03	96.15	122.30	-26.15	Peak	
4	5850.0000	43.51	43.03	86.54	122.30	-35.76	AVG	
5	5860.0000	47.92	43.06	90.98	109.50	-18.52	Peak	
6	5860.0000	36.89	43.06	79.95	109.50	-29.55	AVG	

Orthogonal Axis:	X
Test Mode:	UNII-3/TX N20 Mode 5825MHz

Vertical

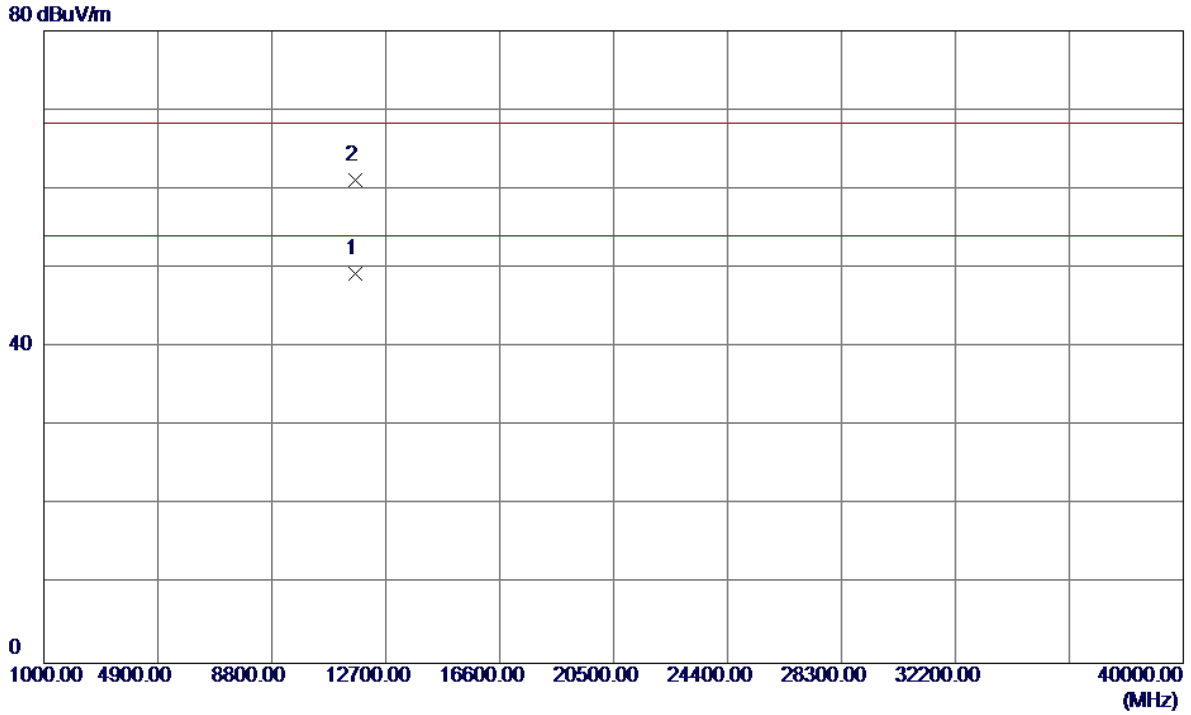

No.	Freq. MHz	Reading Level dBuV/m	Correct Factor dB	Measure ment dBuV/m	Limit dBuV/m	Margin dB	Detector	Comment
1 *	11649.4000	33.72	15.48	49.20	54.00	-4.80	AVG	
2	11650.8000	45.61	15.48	61.09	68.30	-7.21	Peak	

Orthogonal Axis:	X
Test Mode:	UNII-3/TX N20 Mode 5825MHz

Horizontal

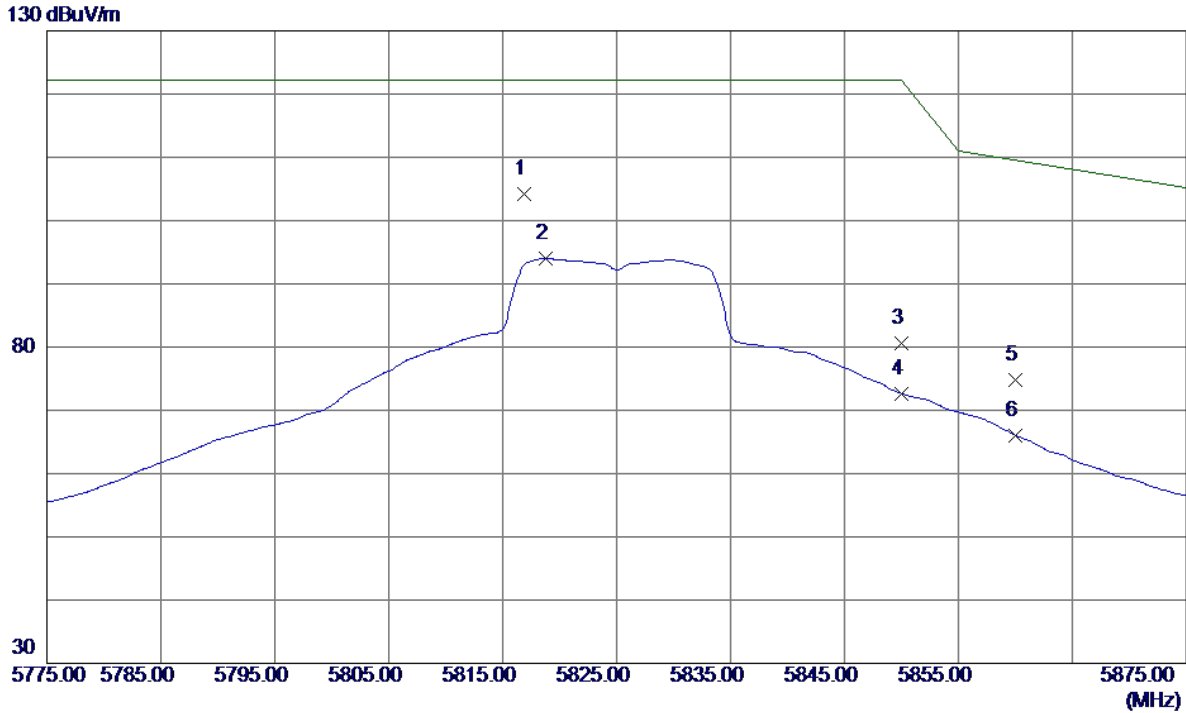

No.	Freq. MHz	Reading Level dBuV/m	Correct Factor dB	Measure ment dBuV/m	Limit dBuV/m	Margin dB	Detector	Comment
1 *	5816.9000	61.25	42.91	104.16	122.30	-18.14	Peak	
2	5818.8000	51.10	42.91	94.01	122.30	-28.29	AVG	
3	5850.0000	37.56	43.03	80.59	122.30	-41.71	Peak	
4	5850.0000	29.64	43.03	72.67	122.30	-49.63	AVG	
5	5860.0000	31.68	43.06	74.74	109.50	-34.76	Peak	
6	5860.0000	22.96	43.06	66.02	109.50	-43.48	AVG	

Orthogonal Axis:	X
Test Mode:	UNII-3/TX N20 Mode 5825MHz

Horizontal

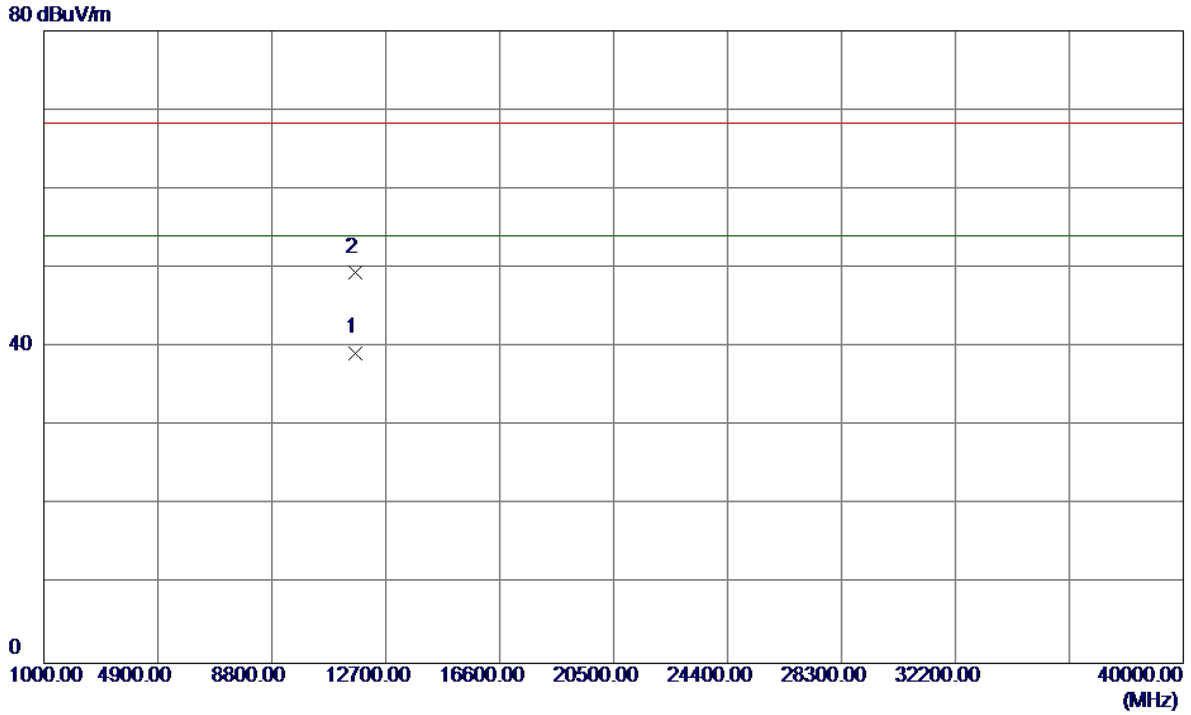

No.	Freq. MHz	Reading Level dBuV/m	Correct Factor dB	Measure ment dBuV/m	Limit dBuV/m	Margin dB	Detector	Comment
1 *	11649.8000	23.80	15.48	39.28	54.00	-14.72	AVG	
2	11648.2000	33.97	15.48	49.45	68.30	-18.85	Peak	

Orthogonal Axis:	X
Test Mode:	UNII-3/TX N40 Mode 5755MHz

Vertical

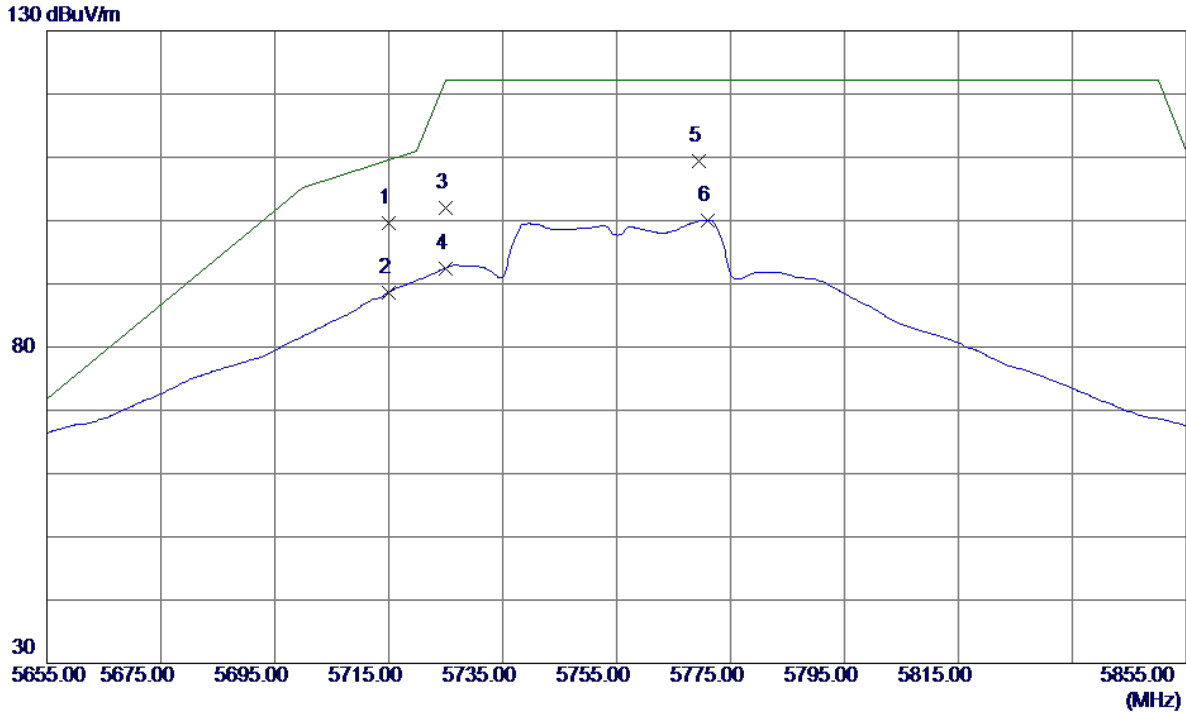

No.	Freq. MHz	Reading Level dBuV/m	Correct Factor dB	Measurement dBuV/m	Limit dBuV/m	Margin dB	Detector	Comment
1 *	5715.0000	57.12	42.55	99.67	109.50	-9.83	Peak	
2	5715.0000	46.09	42.55	88.64	109.50	-20.86	AVG	
3	5725.0000	59.49	42.58	102.07	122.30	-20.23	Peak	
4	5725.0000	49.89	42.58	92.47	122.30	-29.83	AVG	
5	5769.4000	66.62	42.74	109.36	122.30	-12.94	Peak	
6	5771.0000	57.33	42.74	100.07	122.30	-22.23	AVG	

Orthogonal Axis:	X
Test Mode:	UNII-3/TX N40 Mode 5755MHz

Vertical

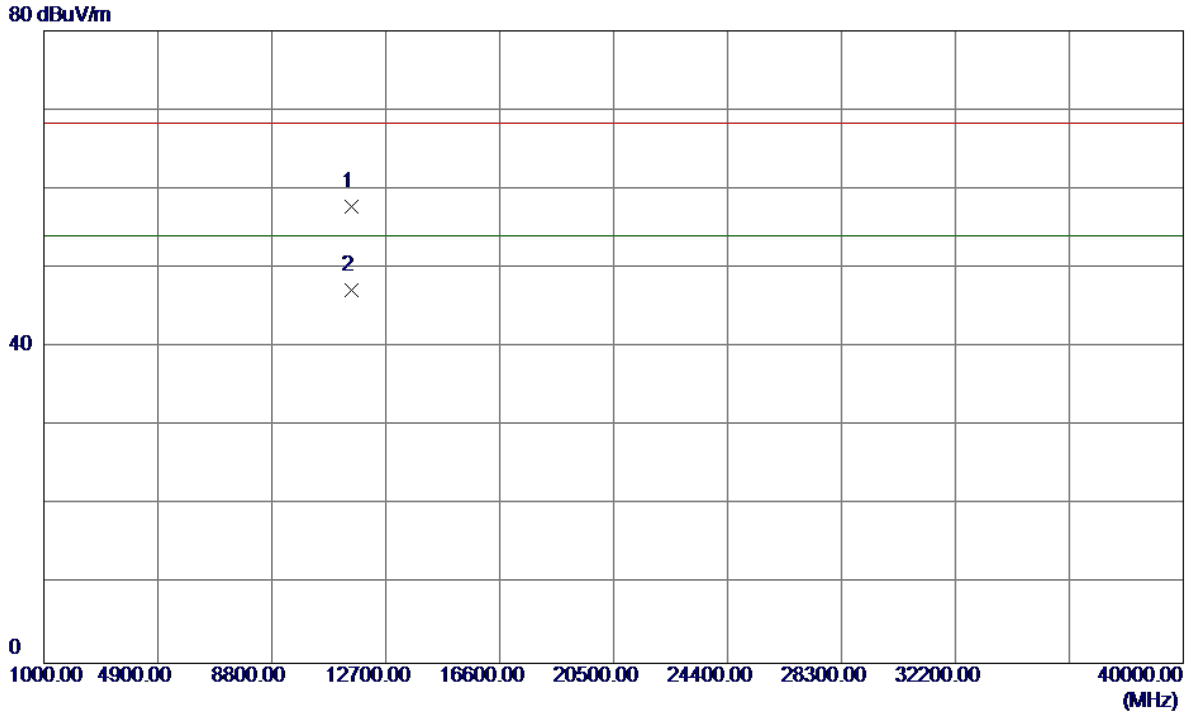

No.	Freq. MHz	Reading Level dBuV/m	Correct Factor dB	Measure ment dBuV/m	Limit dBuV/m	Margin dB	Detector	Comment
1	11513.2000	42.33	15.48	57.81	68.30	-10.49	Peak	
2 *	11515.6000	31.75	15.48	47.23	54.00	-6.77	AVG	

Orthogonal Axis:	X
Test Mode:	UNII-3/TX N40 Mode 5755MHz

Horizontal

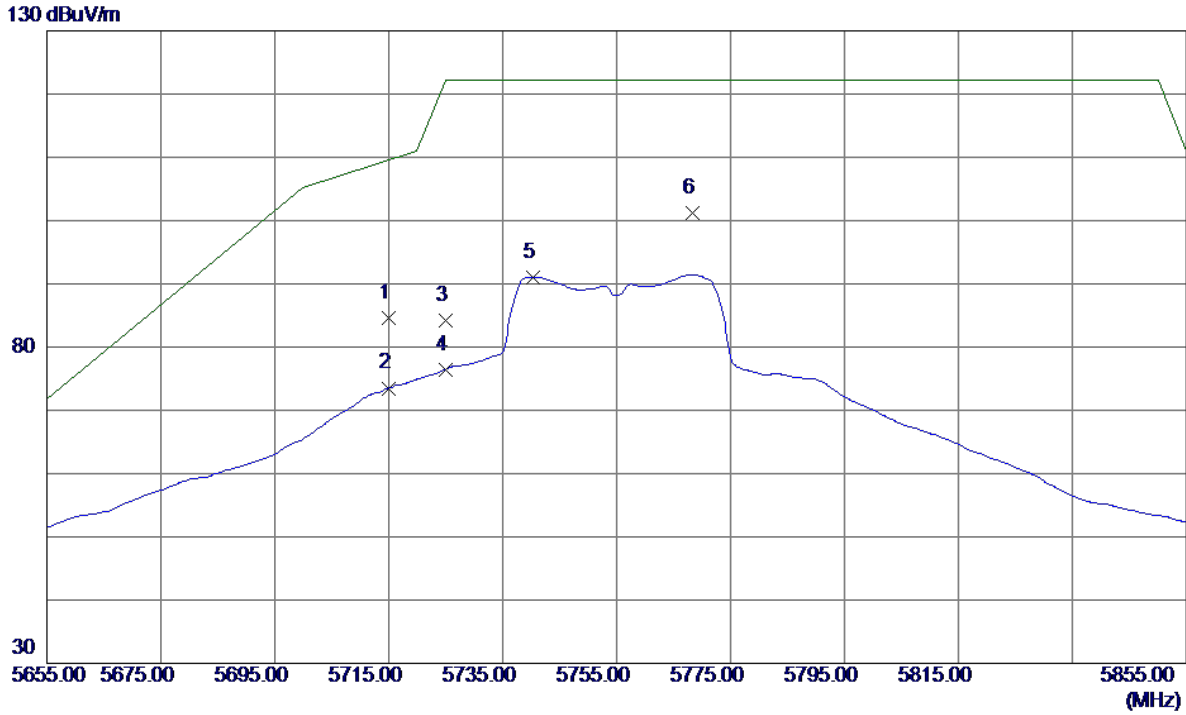

No.	Freq. MHz	Reading Level dBuV/m	Correct Factor dB	Measure ment dBuV/m	Limit dBuV/m	Margin dB	Detector	Comment
1	5715.0000	42.03	42.55	84.58	109.50	-24.92	Peak	
2	5715.0000	30.95	42.55	73.50	109.50	-36.00	AVG	
3	5725.0000	41.63	42.58	84.21	122.30	-38.09	Peak	
4	5725.0000	33.85	42.58	76.43	122.30	-45.87	AVG	
5	5740.4000	48.45	42.64	91.09	122.30	-31.21	AVG	
6 *	5768.4000	58.52	42.74	101.26	122.30	-21.04	Peak	

Orthogonal Axis:	X
Test Mode:	UNII-3/TX N40 Mode 5755MHz

Horizontal

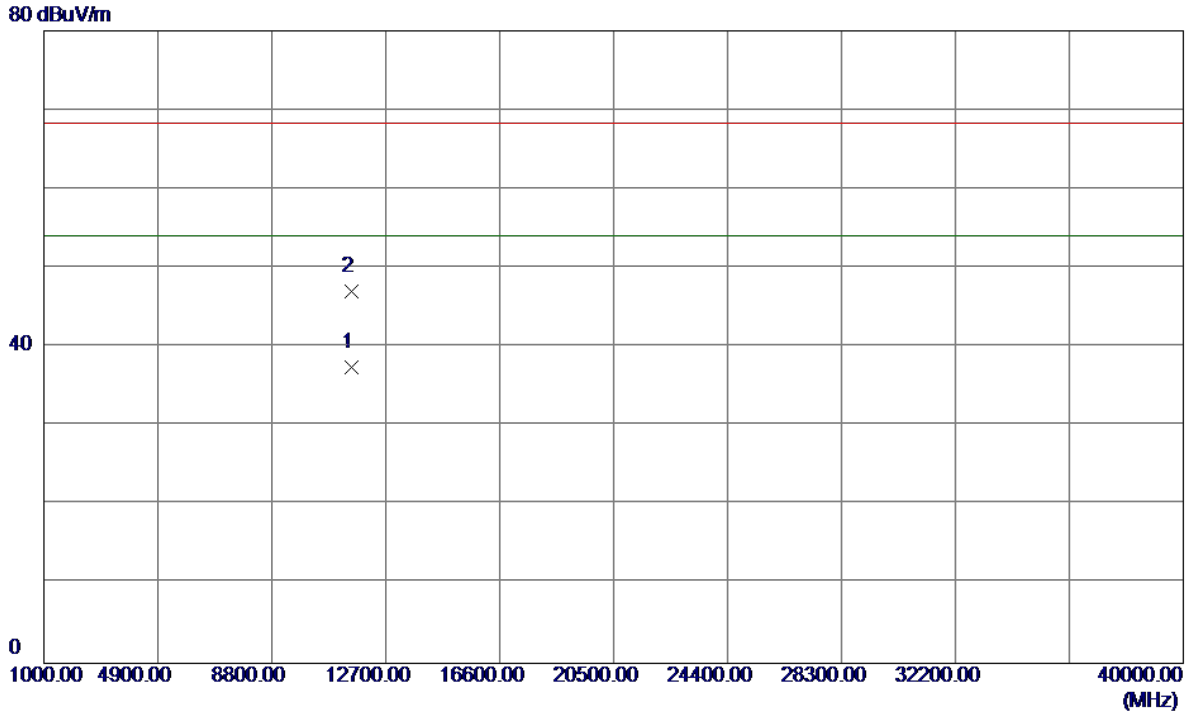

No.	Freq. MHz	Reading Level dBuV/m	Correct Factor dB	Measure ment dBuV/m	Limit dBuV/m	Margin dB	Detector	Comment
1 *	11509.2000	21.96	15.48	37.44	54.00	-16.56	AVG	
2	11510.8000	31.61	15.48	47.09	68.30	-21.21	Peak	

Orthogonal Axis:	X
Test Mode:	UNII-3/TX N40 Mode 5795MHz

Vertical

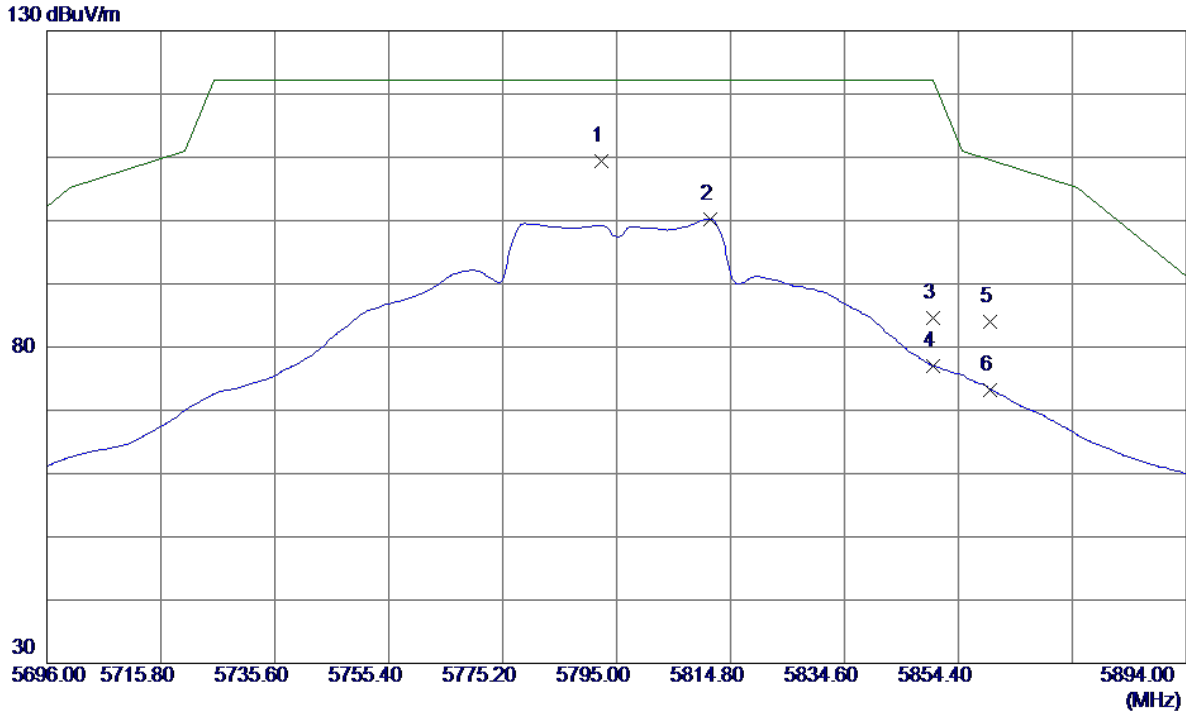

No.	Freq. MHz	Reading Level dBuV/m	Correct Factor dB	Measure ment dBuV/m	Limit dBuV/m	Margin dB	Detector	Comment
1 *	5792.4260	66.61	42.82	109.43	122.30	-12.87	Peak	
2	5811.2360	57.34	42.89	100.23	122.30	-22.07	AVG	
3	5850.0000	41.65	43.03	84.68	122.30	-37.62	Peak	
4	5850.0000	33.97	43.03	77.00	122.30	-45.30	AVG	
5	5860.0000	40.85	43.06	83.91	109.50	-25.59	Peak	
6	5860.0000	30.21	43.06	73.27	109.50	-36.23	AVG	

Orthogonal Axis:	X
Test Mode:	UNII-3/TX N40 Mode 5795MHz

Vertical

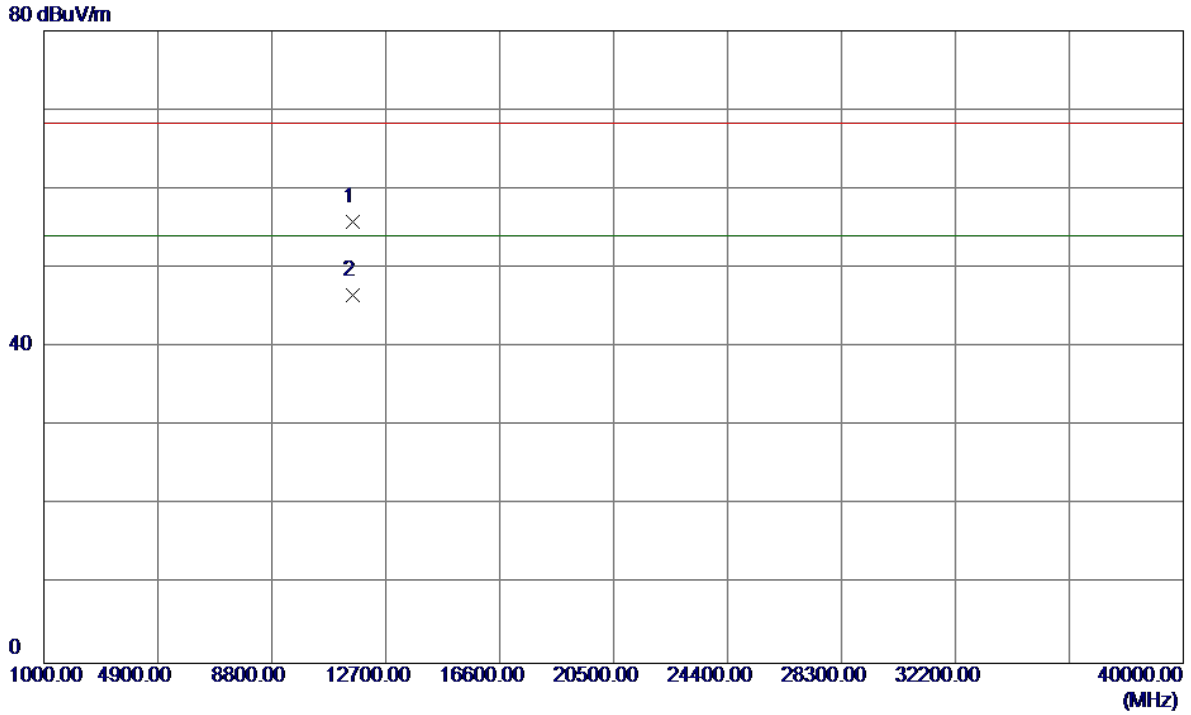

No.	Freq. MHz	Reading Level dBuV/m	Correct Factor dB	Measure ment dBuV/m	Limit dBuV/m	Margin dB	Detector	Comment
1	11589.6000	40.36	15.48	55.84	68.30	-12.46	Peak	
2 *	11589.8000	31.05	15.48	46.53	54.00	-7.47	AVG	

Orthogonal Axis:	X
Test Mode:	UNII-3/TX N40 Mode 5795MHz

Horizontal

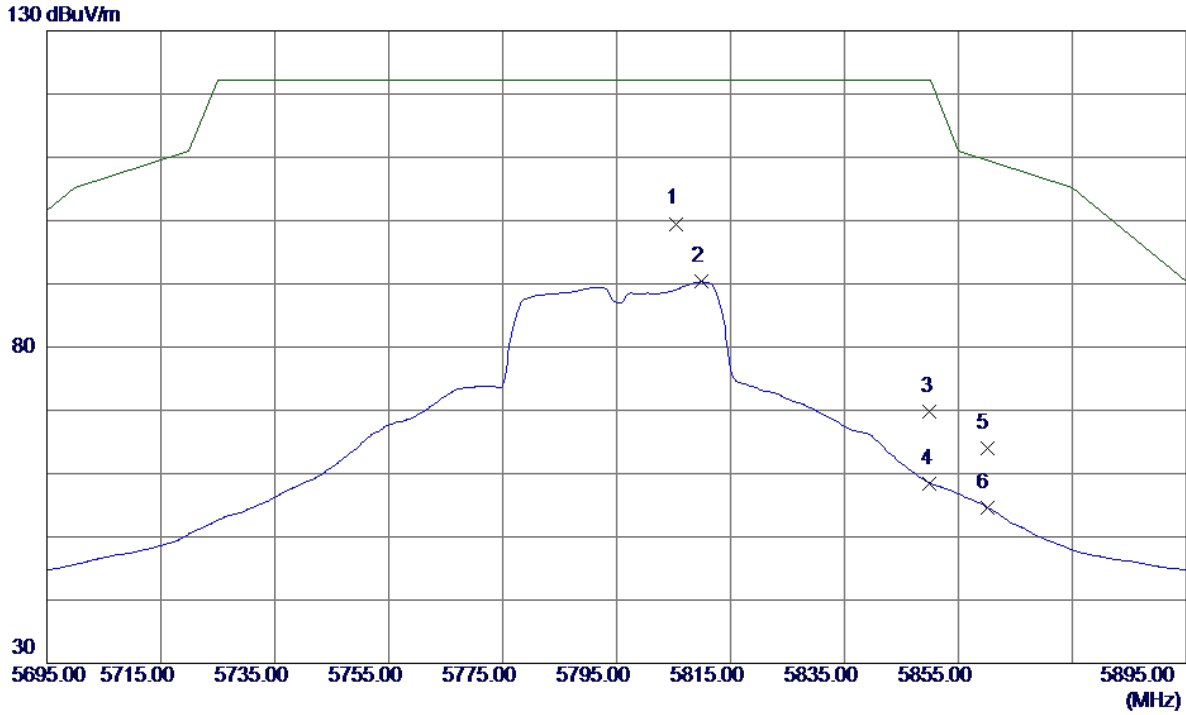

No.	Freq. MHz	Reading Level dBuV/m	Correct Factor dB	Measure ment dBuV/m	Limit dBuV/m	Margin dB	Detector	Comment
1 *	5805.4000	56.63	42.87	99.50	122.30	-22.80	Peak	
2	5809.8000	47.44	42.88	90.32	122.30	-31.98	AVG	
3	5850.0000	26.82	43.03	69.85	122.30	-52.45	Peak	
4	5850.0000	15.45	43.03	58.48	122.30	-63.82	AVG	
5	5860.0000	20.86	43.06	63.92	109.50	-45.58	Peak	
6	5860.0000	11.60	43.06	54.66	109.50	-54.84	AVG	

Orthogonal Axis:	X
Test Mode:	UNII-3/TX N40 Mode 5795MHz

Horizontal

80 dBuV/m

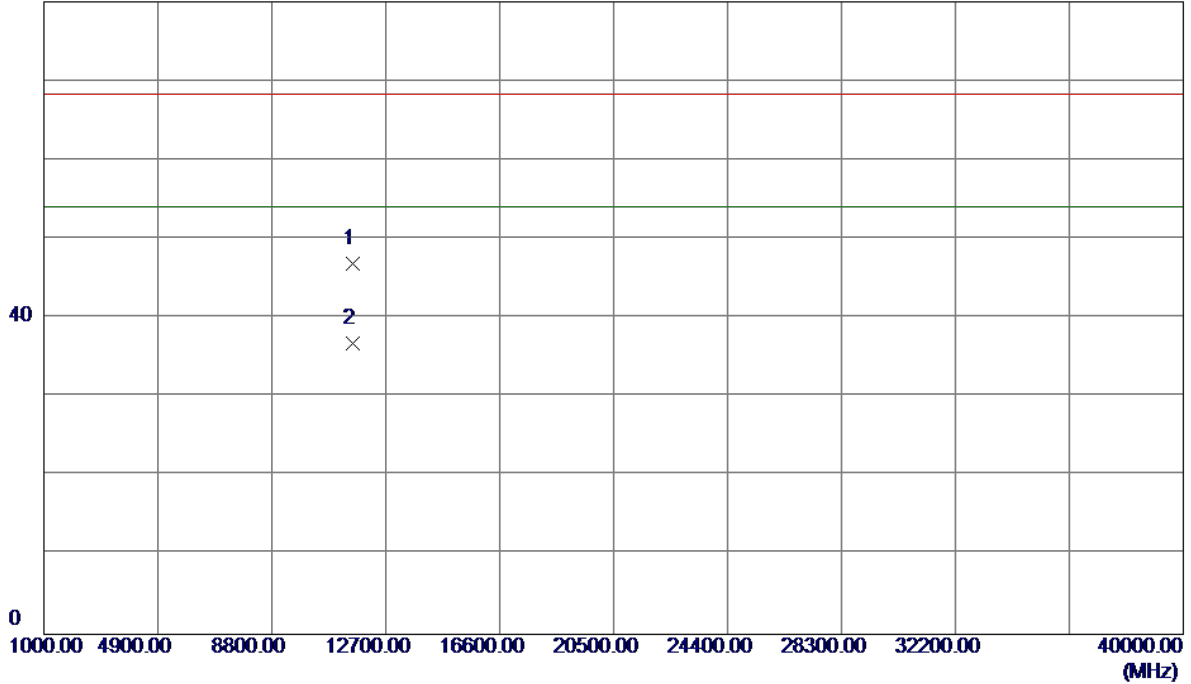

No.	Freq. MHz	Reading Level dBuV/m	Correct Factor dB	Measure ment dBuV/m	Limit dBuV/m	Margin dB	Detector	Comment
1	11588.0000	31.36	15.48	46.84	68.30	-21.46	Peak	
2 *	11592.0000	21.27	15.48	36.75	54.00	-17.25	AVG	

Orthogonal Axis:	X
Test Mode:	UNII-1/ TX AC20 Mode 5180MHz

Vertical

120 dBuV/m

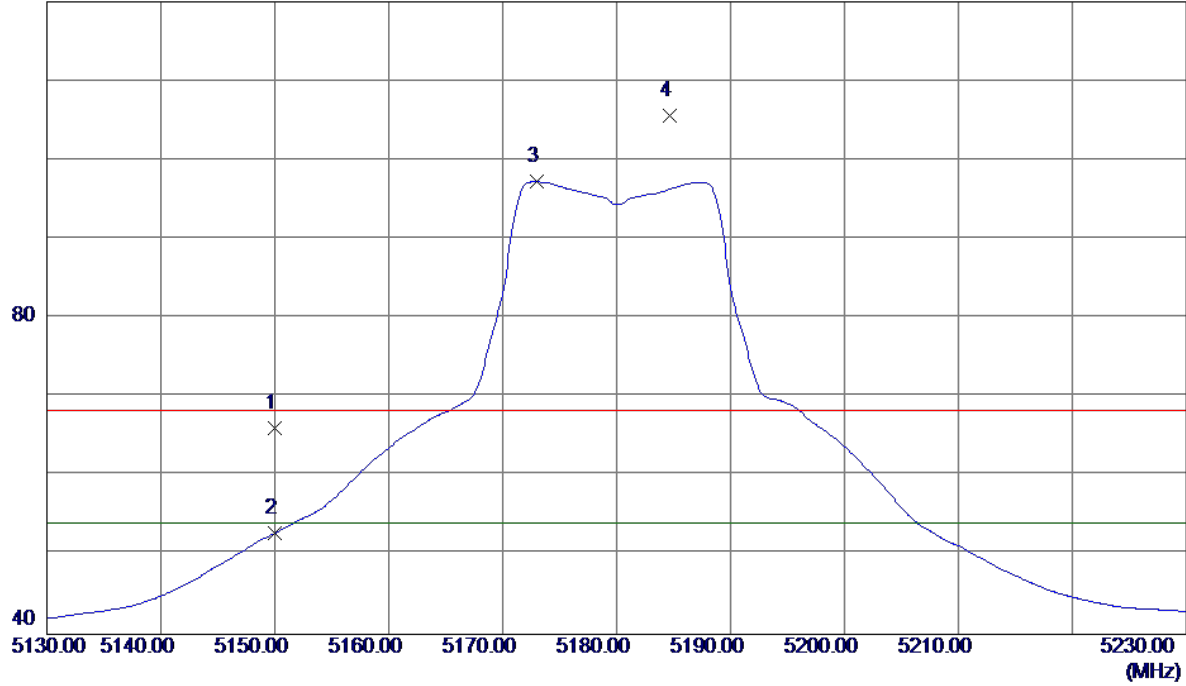

No.	Freq. MHz	Reading Level dBuV/m	Correct Factor dB	Measure ment dBuV/m	Limit dBuV/m	Margin dB	Detector	Comment
1	5150.0000	25.39	40.62	66.01	68.30	-2.29	Peak	
2	5150.0000	12.15	40.62	52.77	54.00	-1.23	AVG	
3 *	5173.0000	56.52	40.70	97.22	54.00	43.22	AVG	No Limit
4	5184.7000	64.80	40.74	105.54	68.30	37.24	Peak	No Limit

Orthogonal Axis:	X
Test Mode:	UNII-1/ TX AC20 Mode 5180MHz

Vertical

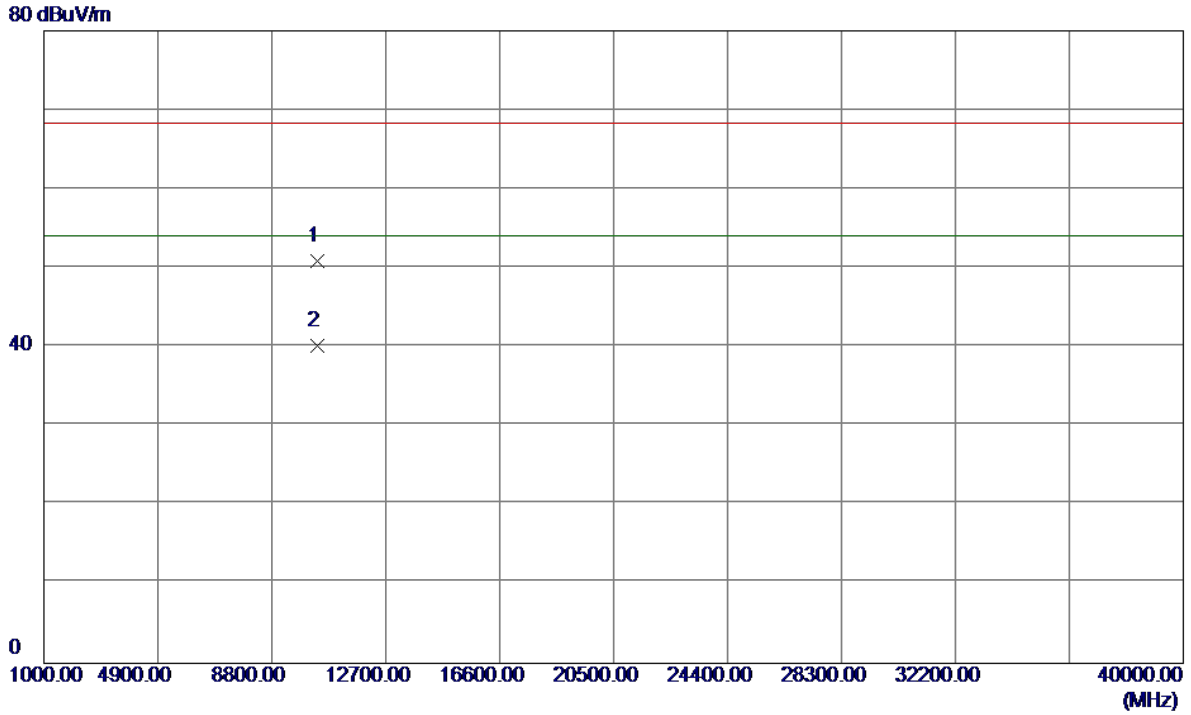

No.	Freq. MHz	Reading Level dBuV/m	Correct Factor dB	Measure ment dBuV/m	Limit dBuV/m	Margin dB	Detector	Comment
1	10360.3400	35.92	14.96	50.88	68.30	-17.42	Peak	
2 *	10360.5400	25.20	14.96	40.16	54.00	-13.84	AVG	

Orthogonal Axis:	X
Test Mode:	UNII-1/ TX AC20 Mode 5180MHz

Horizontal

115 dBuV/m

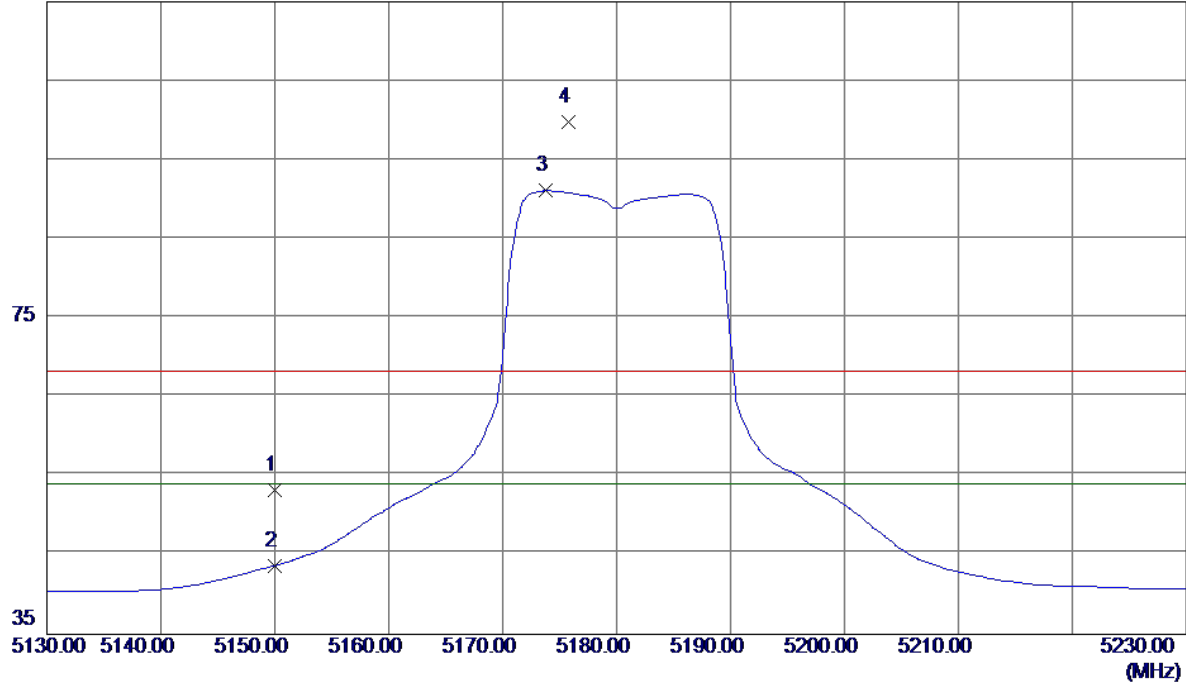

No.	Freq. MHz	Reading Level dBuV/m	Correct Factor dB	Measure ment dBuV/m	Limit dBuV/m	Margin dB	Detector	Comment
1	5150.0000	12.61	40.62	53.23	68.30	-15.07	Peak	
2	5150.0000	3.07	40.62	43.69	54.00	-10.31	AVG	
3 *	5173.8000	50.40	40.70	91.10	54.00	37.10	AVG	No Limit
4	5175.8000	59.07	40.71	99.78	68.30	31.48	Peak	No Limit

Orthogonal Axis:	X
Test Mode:	UNII-1/ TX AC20 Mode 5180MHz

Horizontal

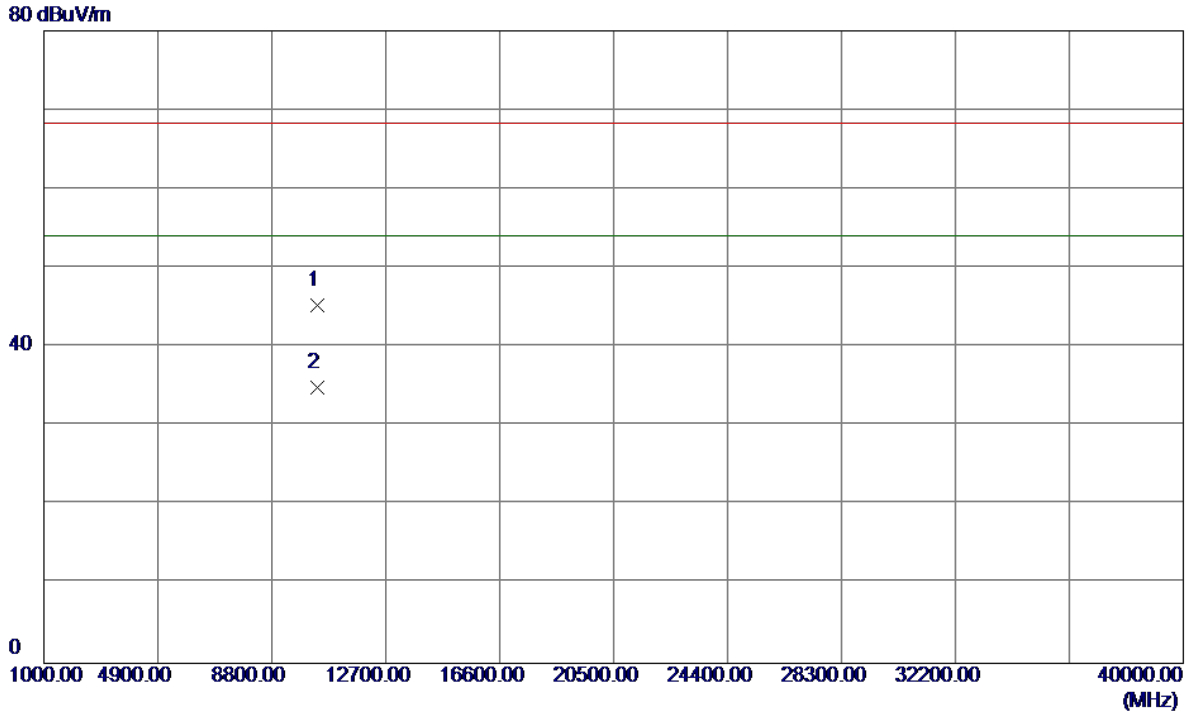

No.	Freq. MHz	Reading Level dBuV/m	Correct Factor dB	Measure ment dBuV/m	Limit dBuV/m	Margin dB	Detector	Comment
1	10360.0000	30.29	14.96	45.25	68.30	-23.05	Peak	
2 *	10361.3000	19.92	14.97	34.89	54.00	-19.11	AVG	

Orthogonal Axis:	X
Test Mode:	UNII-1/ TX AC20 Mode 5200MHz

Vertical

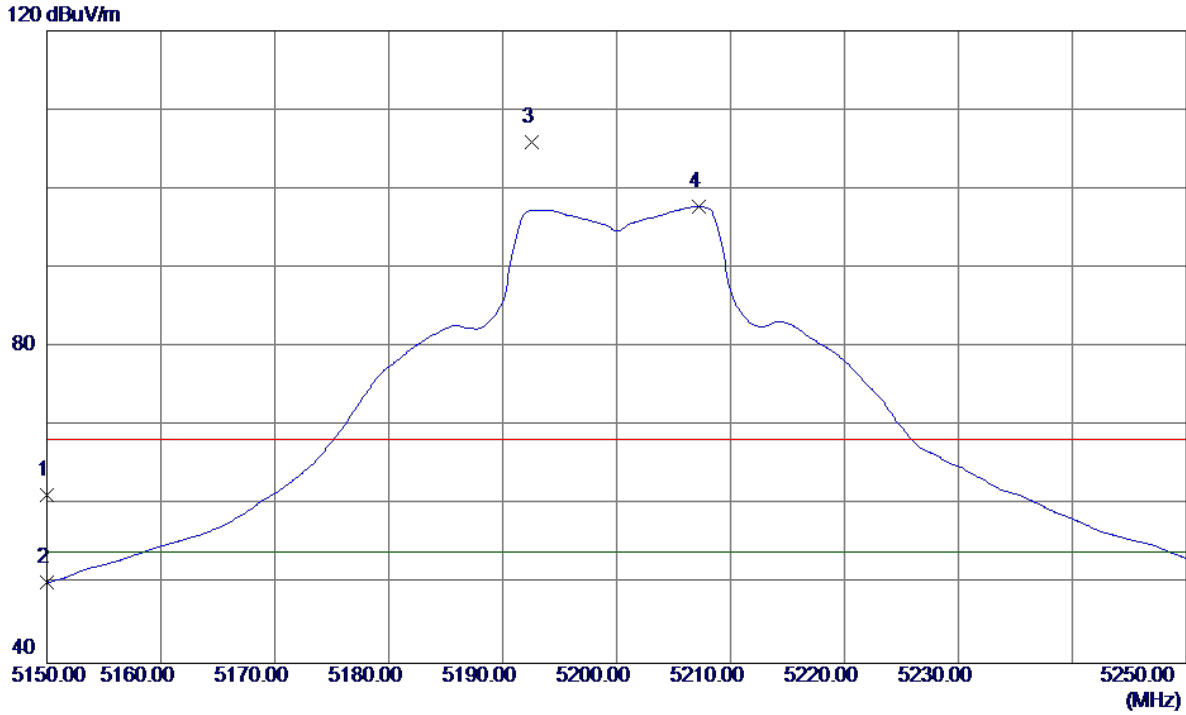

No.	Freq. MHz	Reading Level dBuV/m	Correct Factor dB	Measure ment dBuV/m	Limit dBuV/m	Margin dB	Detector	Comment
1	5150.0000	20.64	40.62	61.26	68.30	-7.04	Peak	
2	5150.0000	9.57	40.62	50.19	54.00	-3.81	AVG	
3	5192.6000	65.12	40.77	105.89	68.30	37.59	Peak	No Limit
4 *	5207.2000	56.89	40.81	97.70	54.00	43.70	AVG	No Limit

Orthogonal Axis:	X
Test Mode:	UNII-1/ TX AC20 Mode 5200MHz

Vertical

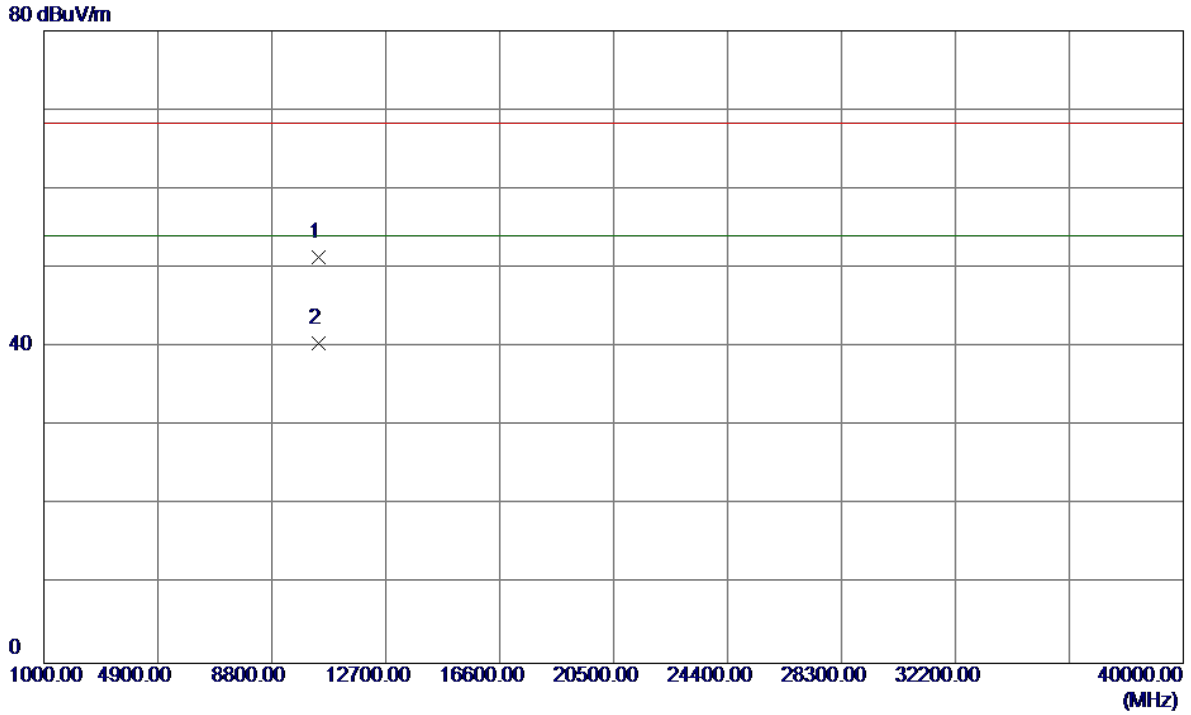

No.	Freq. MHz	Reading Level dBuV/m	Correct Factor dB	Measure ment dBuV/m	Limit dBuV/m	Margin dB	Detector	Comment
1	10399.1000	36.30	15.05	51.35	68.30	-16.95	Peak	
2 *	10400.6000	25.46	15.06	40.52	54.00	-13.48	AVG	