



A D T

FCC TEST REPORT (15.407)

REPORT NO.: RF110208C10-1

MODEL NO.: DAP-1513

FCC ID: KA2AP1513A1

RECEIVED: Feb. 08, 2011

TESTED: Feb. 08 ~ Feb. 14, 2011

ISSUED: Feb. 16, 2011

APPLICANT: D-Link Corporation

ADDRESS: 17595 Mt. Herrmann, Fountain Valley, CA
92708, U.S.A.

ISSUED BY: Bureau Veritas Consumer Products Services
(H.K.) Ltd., Taoyuan Branch

LAB ADDRESS: No. 47, 14th Ling, Chia Pau Tsuen, Lin Kou
Hsiang, Taipei Hsien 244, Taiwan, R.O.C.

TEST LOCATION: No. 19, Hwa Ya 2nd Rd, Wen Hwa Tsuen, Kwei
Shan Hsiang, Taoyuan Hsien 333, Taiwan,
R.O.C.

This test report consists of 93 pages. It may be duplicated completely for legal use with the approval of the applicant. It should not be reproduced except in full, without the written approval of our laboratory. The client should not use it to claim product, certification, approval or endorsement by TAF or any government agency. The test results in the report only apply to the tested sample.





TABLE OF CONTENTS

RELEASE CONTROL RECORD.....	4
1. CERTIFICATION.....	5
2. SUMMARY OF TEST RESULTS	6
2.1 MEASUREMENT UNCERTAINTY.....	6
3. GENERAL INFORMATION.....	7
3.1 GENERAL DESCRIPTION OF EUT	7
3.2 DESCRIPTION OF TEST MODES	9
3.2.1 CONFIGURATION OF SYSTEM UNDER TEST	9
3.2.2 TEST MODE APPLICABILITY AND TESTED CHANNEL DETAIL	10
3.3 GENERAL DESCRIPTION OF APPLIED STANDARDS	12
3.4 DESCRIPTION OF SUPPORT UNITS	12
4. TEST TYPES AND RESULTS	13
4.1 RADIATED EMISSION MEASUREMENT	13
4.1.1 LIMITS OF RADIATED EMISSION MEASUREMENT.....	13
4.1.2 LIMITS OF UNWANTED EMISSION OUT OF THE RESTRICTED BANDS	13
4.1.3 TEST INSTRUMENTS.....	14
4.1.4 TEST PROCEDURES	15
4.1.5 DEVIATION FROM TEST STANDARD.....	15
4.1.6 TEST SETUP.....	16
4.1.7 EUT OPERATING CONDITION.....	16
4.1.8 TEST RESULTS	17
4.2 CONDUCTED EMISSION MEASUREMENT	32
4.2.1 LIMITS OF CONDUCTED EMISSION MEASUREMENT	32
4.2.2 TEST INSTRUMENTS.....	32
4.2.3 TEST PROCEDURES	33
4.2.4 DEVIATION FROM TEST STANDARD.....	33
4.2.5 TEST SETUP.....	34
4.2.6 EUT OPERATING CONDITIONS	34
4.2.7 TEST RESULTS	35
4.3 MAXIMUM CONDUCTED OUTPUT POWER MEASUREMENT	39
4.3.1 LIMITS OF MAXIMUM CONDUCTED OUTPUT POWER MEASUREMENT.....	39
4.3.2 TEST INSTRUMENTS.....	39
4.3.3 TEST PROCEDURE.....	40
4.3.4 DEVIATION FROM TEST STANDARD.....	40
4.3.5 TEST SETUP.....	40
4.3.6 EUT OPERATING CONDITIONS	40
4.3.7 TEST RESULTS	41
4.4 PEAK POWER EXCURSION MEASUREMENT	47
4.4.1 LIMITS OF PEAK POWER EXCURSION MEASUREMENT.....	47
4.4.2 TEST INSTRUMENTS.....	47
4.4.3 TEST PROCEDURE.....	47
4.4.4 DEVIATION FROM TEST STANDARD.....	48
4.4.5 TEST SETUP.....	48
4.4.6 EUT OPERATING CONDITIONS	48
4.4.7 TEST RESULTS	49
4.5 PEAK POWER SPECTRAL DENSITY MEASUREMENT	59
4.5.1 LIMITS OF PEAK POWER SPECTRAL DENSITY MEASUREMENT.....	59
4.5.2 TEST INSTRUMENTS.....	59



A D T

4.5.3	TEST PROCEDURES	59
4.5.4	DEVIATION FROM TEST STANDARD.....	60
4.5.5	TEST SETUP.....	60
4.5.6	EUT OPERATING CONDITIONS	60
4.5.7	TEST RESULTS	61
4.6	FREQUENCY STABILITY.....	66
4.6.1	LIMITS OF FREQUENCY STABILITY MEASUREMENT	66
4.6.2	TEST INSTRUMENTS.....	66
4.6.3	TEST PROCEDURE.....	66
4.6.4	DEVIATION FROM TEST STANDARD.....	67
4.6.5	TEST SETUP.....	67
4.6.6	EUT OPERATING CONDITION.....	67
4.6.7	TEST RESULTS	68
4.7	BAND EDGES MEASUREMENT	69
4.7.1	TEST INSTRUMENTS.....	69
4.7.2	TEST PROCEDURE.....	70
4.7.3	EUT OPERATING CONDITION.....	70
4.7.4	TEST RESULTS	71
5.	PHOTOGRAPHS OF THE TEST CONFIGURATION.....	91
6.	INFORMATION ON THE TESTING LABORATORIES	92
7.	APPENDIX A - MODIFICATIONS RECORDERS FOR ENGINEERING CHANGES TO THE EUT BY THE LAB.....	93



A D T

RELEASE CONTROL RECORD

ISSUE NO.	REASON FOR CHANGE	DATE ISSUED
Original release	N/A	Feb. 16, 2011



A D T

1. CERTIFICATION

PRODUCT: Wireless N Dual Band MediaBridge®

MODEL NO.: DAP-1513

BRAND: D-Link

APPLICANT: D-Link Corporation

TEST SAMPLE: ENGINEERING SAMPLE

TESTED: Feb. 08 ~ Feb. 14, 2011

STANDARDS: FCC Part 15, Subpart E (Section 15.407)

ANSI C63.4-2003

ANSI C63.10-2009

The above equipment (Model: DAP-1513) has been tested by **Bureau Veritas Consumer Products Services (H.K.) Ltd., Taoyuan Branch**, and found compliance with the requirement of the above standards. The test record, data evaluation & Equipment Under Test (EUT) configurations represented herein are true and accurate accounts of the measurements of the sample's EMC characteristics under the conditions specified in this report.

PREPARED BY : Andrea Hsia , DATE: Feb. 16, 2011
Andrea Hsia / Specialist

APPROVED BY : Gary Chang , DATE: Feb. 16, 2011
Gary Chang / Assistant Manager

2. SUMMARY OF TEST RESULTS

The EUT has been tested according to the following specifications:

APPLIED STANDARD: FCC PART 15, SUBPART E (SECTION 15.407)			
STANDARD SECTION	TEST TYPE AND LIMIT	RESULT	REMARK
15.407(b)(5)	AC Power Conducted Emission	PASS	Meet the requirement of limit. Minimum passing margin is -17.07dB at 2.898MHz.
15.407(b/1/2/3) (b)(5)	Electric Field Strength Spurious Emissions, 30MHz ~ 40000MHz	PASS	Meet the requirement of limit. Minimum passing margin is -1.2dB at 5150.00MHz.
15.407(a/1/2/3)	Peak Transmit Power	PASS	Meet the requirement of limit.
15.407(a)(6)	Peak Power Excursion	PASS	Meet the requirement of limit.
15.407(a/1/2/3)	Peak Power Spectral Density	PASS	Meet the requirement of limit.
15.407(g)	Frequency Stability	PASS	Meet the requirement of limit.
15.203	Antenna Requirement	PASS	No antenna connector is used.

2.1 MEASUREMENT UNCERTAINTY

Where relevant, the following measurement uncertainty levels have been estimated for tests performed on the EUT as specified in CISPR 16-4-2:

MEASUREMENT	FREQUENCY	UNCERTAINTY
Conducted emissions	9kHz~30MHz	2.44 dB
Radiated emissions	30MHz ~ 200MHz	2.93 dB
	200MHz ~1000MHz	2.95 dB
	1GHz ~ 18GHz	2.26 dB
	18GHz ~ 40GHz	1.94 dB

This uncertainty represents an expanded uncertainty expressed at approximately the 95% confidence level using a coverage factor of $k = 2$.



3. GENERAL INFORMATION

3.1 GENERAL DESCRIPTION OF EUT

PRODUCT	Wireless N Dual Band MediaBridge®
MODEL NO.	DAP-1513
FCC ID	KA2AP1513A1
NOMINAL VOLTAGE	5Vdc
MODULATION TYPE	64QAM, 16QAM, QPSK, BPSK
MODULATION TECHNOLOGY	OFDM
TRANSFER RATE	802.11a: 54.0/ 48.0/ 36.0/ 24.0/ 18.0/ 12.0/ 9.0/ 6.0Mbps 802.11n: up to 300.0Mbps
OPERATING FREQUENCY	5180.0 ~ 5240.0MHz
NUMBER OF CHANNEL	4 for 802.11a, 802.11n (20MHz) 2 for 802.11n (40MHz)
OUTPUT POWER	47.9mW
ANTENNA TYPE	Refer to Note as below
DATA CABLE	NA
DATA CABLE	NA
I/O PORTS	RJ45
ACCESSORY DEVICES	Adapter

NOTE:

- The EUT is a Wireless N Dual Band MediaBridge®. The test data are separated into following test reports.

	TEST STANDARD	REFERENCE REPORT
WLAN 802.11b/g, 802.11n	FCC Part 15, Subpart C (Section 15.247)	RF110208C10
WLAN 802.11a, 802.11n (5745~5825 MHz)		
WLAN 802.11a, 802.11n (5180~ 5240MHz)	FCC Part 15, Subpart E (Section 15.407)	RF110208C10-1

- The frequency bands used in this EUT are listed as follows:

Frequency Band (MHz)	2412~2462	5180~5240	5745~5825
802.11b	√		
802.11g	√		
802.11a		√	√
802.11n (20MHz)	√	√	√
802.11n (40MHz)	√	√	√

- The EUT incorporates a MIMO function. Physically, the EUT provides two completed transmitters and two receivers.

MODULATION MODE	TX FUNCTION
802.11b	1TX
802.11g	1TX
802.11a	1TX
802.11n (20MHz)	1TX/ 2TX
802.11n (40MHz)	1TX/ 2TX

4. The EUT uses following adapter

ADAPTER 1	
BRAND	D-Link
MODEL	CF0605-B IW
INPUT POWER	100-240Vac, 50-60Hz, 0.18A
OUTPUT POWER	5Vdc, 1.2A
POEWR LINE	1.8 m non-shielded cable without core

ADAPTER 2	
BRAND	D-Link
MODEL	AMS1-0501200FU
INPUT POWER	100-240Vac, 50-60Hz, 0.2A, 15VA
OUTPUT POWER	5Vdc, 1.2A
POEWR LINE	1.8 m non-shielded cable without core

5. The antenna used in this EUT is listed as below table:

FREQUENCY (GHz)	TYPE	ANTENNA CONNECTOR	GAIN (dBi)	
			Peak Gain	Average Gain
2.45 GHz	Printed Monopole	NA	ANT1: 1.17	ANT1: -3.04
			ANT2: 2.02	ANT2: -2.83
5.00 GHz	Printed Monopole	NA	ANT1: 3.02	ANT1: -2.36
			ANT2: 3.42	ANT2: -2.07

6. The above EUT information was declared by manufacturer and for more detailed features description, please refer to the manufacturer's specifications or user's manual.

3.2 DESCRIPTION OF TEST MODES

4 channels are provided for 802.11a and 802.11n (20MHz):

CHANNEL	FREQUENCY	CHANNEL	FREQUENCY
36	5180MHz	44	5220MHz
40	5200MHz	48	5240MHz

2 channels are provided for 802.11n (40MHz):

CHANNEL	FREQUENCY	CHANNEL	FREQUENCY
38	5190MHz	46	5230MHz

3.2.1 CONFIGURATION OF SYSTEM UNDER TEST

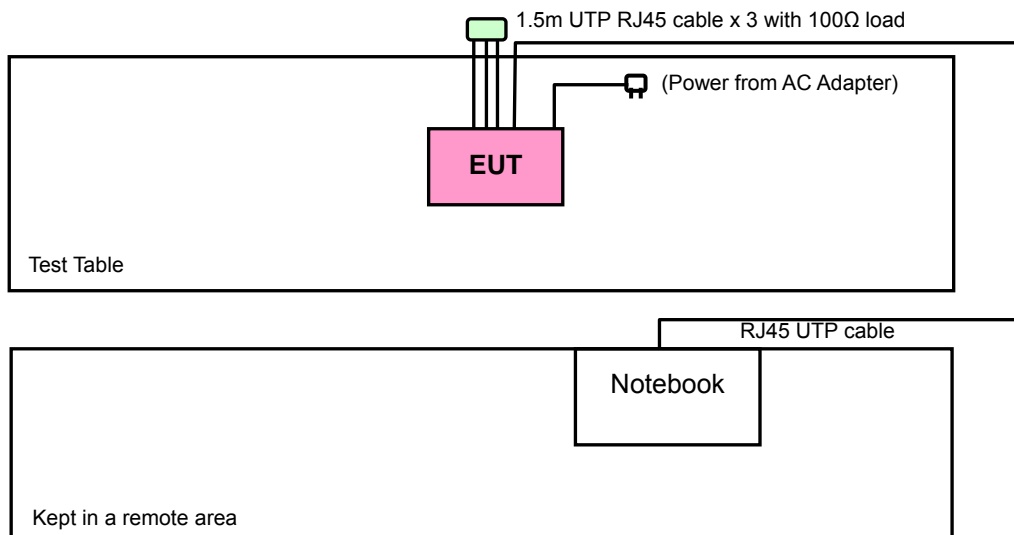



A D T

3.2.2 TEST MODE APPLICABILITY AND TESTED CHANNEL DETAIL

EUT CONFIGURE MODE	APPLICABLE TO				DESCRIPTION
	RE≥1G	RE<1G	PLC	APCM	
A	√	√	√	√	Power from adapter 1
B	-	√	√	-	Power from adapter 2

Where **RE≥1G**: Radiated Emission above 1GHz

RE<1G: Radiated Emission below 1GHz

PLC: Power Line Conducted Emission

APCM: Antenna Port Conducted Measurement

NOTE: "-" means no effect.

RADIATED EMISSION TEST (ABOVE 1GHz):

- Pre-Scan has been conducted to determine the worst-case mode from all possible combinations between available modulations, data rates, XYZ axis and antenna ports (if EUT with antenna diversity architecture).
- Following channel(s) was (were) selected for the final test as listed below.

EUT CONFIGURE MODE	MODE	AVAILABLE CHANNEL	TESTED CHANNEL	MODULATION TECHNOLOGY	MODULATION TYPE	DATA RATE (Mbps)	TX FUNCTION	AXIS
A	802.11a	36 to 48	36, 40, 48	OFDM	BPSK	6.0	1TX	Z
	802.11n (20MHz)	36 to 48	36, 40, 48	OFDM	BPSK	7.2	1TX	Z
	802.11n (20MHz)	36 to 48	36, 40, 48	OFDM	BPSK	14.4	2TX	Z
	802.11n (40MHz)	38 to 46	38, 46	OFDM	BPSK	15.0	1TX	Z
	802.11n (40MHz)	38 to 46	38, 46	OFDM	BPSK	30.0	2TX	Z

RADIATED EMISSION TEST (BELOW 1GHz):

- Pre-Scan has been conducted to determine the worst-case mode from all possible combinations between available modulations, data rates, XYZ axis and antenna ports (if EUT with antenna diversity architecture).
- Following channel(s) was (were) selected for the final test as listed below.

EUT CONFIGURE MODE	MODE	AVAILABLE CHANNEL	TESTED CHANNEL	MODULATION TECHNOLOGY	MODULATION TYPE	DATA RATE (Mbps)	TX FUNCTION	AXIS
A & B	802.11n (40MHz)	38 to 46	46	OFDM	BPSK	15.0	1TX	Z

POWER LINE CONDUCTED EMISSION TEST:

- Pre-Scan has been conducted to determine the worst-case mode from all possible combinations between available modulations, data rates and antenna ports (if EUT with antenna diversity architecture).
- Following channel(s) was (were) selected for the final test as listed below.

EUT CONFIGURE MODE	MODE	AVAILABLE CHANNEL	TESTED CHANNEL	MODULATION TECHNOLOGY	MODULATION TYPE	DATA RATE (Mbps)	TX FUNCTION
A & B	802.11n (40MHz)	38 to 46	46	OFDM	BPSK	15.0	1TX



A D T

BANDEDGE MEASUREMENT:

- Pre-Scan has been conducted to determine the worst-case mode from all possible combinations between available modulations, data rates and antenna ports (if EUT with antenna diversity architecture).
- Following channel(s) was (were) selected for the final test as listed below.

EUT CONFIGURE MODE	MODE	AVAILABLE CHANNEL	TESTED CHANNEL	MODULATION TECHNOLOGY	MODULATION TYPE	DATA RATE (Mbps)	TX FUNCTION
A	802.11a	36 to 48	36, 48	OFDM	BPSK	6.0	1TX
	802.11n (20MHz)	36 to 48	36, 48	OFDM	BPSK	7.2	1TX
	802.11n (20MHz)	36 to 48	36, 48	OFDM	BPSK	14.4	2TX
	802.11n (40MHz)	38 to 46	38, 46	OFDM	BPSK	15.0	1TX
	802.11n (40MHz)	38 to 46	38, 46	OFDM	BPSK	30.0	2TX

ANTENNA PORT CONDUCTED MEASUREMENT:

- This item includes all test value of each mode, but only includes spectrum plot of worst value of each mode.
- Pre-Scan has been conducted to determine the worst-case mode from all possible combinations between available modulations, data rates and antenna ports (if EUT with antenna diversity architecture).
- Following channel(s) was (were) selected for the final test as listed below.

EUT CONFIGURE MODE	MODE	AVAILABLE CHANNEL	TESTED CHANNEL	MODULATION TECHNOLOGY	MODULATION TYPE	DATA RATE (Mbps)	TX FUNCTION
A	802.11a	36 to 48	36, 40, 48	OFDM	BPSK	6.0	1TX
	802.11n (20MHz)	36 to 48	36, 40, 48	OFDM	BPSK	7.2	1TX
	802.11n (20MHz)	36 to 48	36, 40, 48	OFDM	BPSK	14.4	2TX
	802.11n (40MHz)	38 to 46	38, 46	OFDM	BPSK	15.0	1TX
	802.11n (40MHz)	38 to 46	38, 46	OFDM	BPSK	30.0	2TX

TEST CONDITION:

APPLICABLE TO	ENVIRONMENTAL CONDITIONS	INPUT POWER	TESTED BY
RE \geq 1G	23deg. C, 66%RH, 1020 hPa	120Vac, 60Hz	Frank Wang
RE $<$ 1G	23deg. C, 66%RH, 1020 hPa	120Vac, 60Hz	Mark Liao
PLC	25deg. C, 68%RH, 1020 hPa	120Vac, 60Hz	Sun Lin
APCM	23deg. C, 66%RH, 1020 hPa	120Vac, 60Hz	Mark Liao



3.3 GENERAL DESCRIPTION OF APPLIED STANDARDS

The EUT is a RF Product. According to the specifications of the manufacturer, it must comply with the requirements of the following standards:

FCC Part 15, Subpart E (15.407)

ANSI C63.4-2003

ANSI C63.10-2009

All test items have been performed and recorded as per the above standards.

NOTE: The EUT is also considered as a kind of computer peripheral, because the connection to computer is necessary for typical use. It has been verified to comply with the requirements of FCC Part 15, Subpart B, Class B (DoC). The test report has been issued separately.

3.4 DESCRIPTION OF SUPPORT UNITS

The EUT has been tested as an independent unit together with other necessary accessories or support units. The following support units or accessories were used to form a representative test configuration during the tests.

NO.	PRODUCT	BRAND	MODEL NO.	SERIAL NO.	FCC ID
1	NOTEBOOK	DELL	D600	CN-0D2125-48643-4CC-5381	QDS-BRCM1005-D

NO.	SIGNAL CABLE DESCRIPTION OF THE ABOVE SUPPORT UNITS
1	10 m RJ45 UTP cable

NOTE: 1. All power cords of the above support units are non shielded (1.8m).
2. Item 1 acts as a communication partner to transfer data.



4. TEST TYPES AND RESULTS

4.1 RADIATED EMISSION MEASUREMENT

4.1.1 LIMITS OF RADIATED EMISSION MEASUREMENT

Emissions radiated outside of the specified bands, shall be according to the general radiated limits in 15.209 as following:

FREQUENCIES (MHz)	FIELD STRENGTH (microvolts/meter)	MEASUREMENT DISTANCE (meters)
0.009 ~ 0.490	2400/F(kHz)	300
0.490 ~ 1.705	24000/F(kHz)	30
1.705 ~ 30.0	30	30
30 ~ 88	100	3
88 ~ 216	150	3
216 ~ 960	200	3
Above 960	500	3

NOTE:

1. The lower limit shall apply at the transition frequencies.
2. Emission level (dBuV/m) = 20 log Emission level (uV/m).
3. As shown in 15.35(b), for frequencies above 1000MHz, the field strength limits are based on average detector, however, the peak field strength of any emission shall not exceed the maximum permitted average limits, specified above by more than 20dB under any condition of modulation.

4.1.2 LIMITS OF UNWANTED EMISSION OUT OF THE RESTRICTED BANDS

FREQUENCIES (MHz)	EIRP LIMIT (dBm)	EQUIVALENT FIELD STRENGTH AT 3m (dBµV/m) *NOTE 3
	PK	PK
5150 ~ 5250	-27	68.3

NOTE: The following formula is used to convert the equipment isotropic radiated power (eirp) to field strength:

$$E = \frac{1000000\sqrt{30P}}{3} \mu\text{V/m, where P is the eirp (Watts).}$$



A D T

4.1.3 TEST INSTRUMENTS

DESCRIPTION & MANUFACTURER	MODEL NO.	SERIAL NO.	DATE OF CALIBRATION	DUE DATE OF CALIBRATION
Test Receiver ROHDE & SCHWARZ	ESCI	100424	Aug. 04, 2010	Aug. 03, 2011
Spectrum Analyzer ROHDE & SCHWARZ	FSP40	100041	Jul. 09, 2010	Jul. 08, 2011
BILOG Antenna SCHWARZBECK	VULB9168	9168-156	Apr. 30, 2010	Apr. 29, 2011
HORN Antenna SCHWARZBECK	BBHA 9120 D	9120D-209	Aug. 02, 2010	Aug. 01, 2011
HORN Antenna SCHWARZBECK	BBHA 9170	BBHA9170243	Dec. 27, 2010	Dec. 26, 2011
Preamplifier Agilent	8449B	3008A01910	Sep. 09, 2010	Sep. 08, 2011
Preamplifier Agilent	8447D	2944A10638	Nov. 03, 2010	Nov. 02, 2011
RF signal cable HUBER+SUHNNER	SUCOFLEX 104	218190/4 231241/4	May 14, 2010	May 13, 2011
RF signal cable Worken	8D-FB	Cable-HYCH9-01	Aug. 20, 2010	Aug. 19, 2011
Software	ADT_Radiated_ V7.6.15.9.2	NA	NA	NA
Antenna Tower EMCO	2070/2080	512.835.4684	NA	NA
Turn Table EMCO	2087-2.03	NA	NA	NA
Antenna Tower & Turn Table Controller EMCO	2090	NA	NA	NA
26GHz ~ 40GHz Amplifier	EM26400	07026401	Aug. 25, 2010	Aug. 24, 2011

- NOTE:**
1. The calibration interval of the above test instruments is 12 months and the calibrations are traceable to NML/ROC and NIST/USA.
 2. The test was performed in HwaYa Chamber 9.
 3. The horn antenna and HP preamplifier (model: 8449B) are used only for the measurement of emission frequency above 1GHz if tested.
 4. The FCC Site Registration No. is 460141.
 5. The IC Site Registration No. is IC 7450F-4.



4.1.4 TEST PROCEDURES

- a. The EUT was placed on the top of a rotating table 0.8 meters above the ground at a 3 meter semi-anechoic chamber. The table was rotated 360 degrees to determine the position of the highest radiation.
- b. The EUT was set 3 meters away from the interference-receiving antenna, which was mounted on the top of a variable-height antenna tower.
- c. The antenna is a broadband antenna, and its height is varied from one meter to four meters above the ground to determine the maximum value of the field strength. Both horizontal and vertical polarizations of the antenna are set to make the measurement.
- d. For each suspected emission, the EUT was arranged to its worst case and then the antenna was tuned to heights from 1 meter to 4 meters and the rotatable table was turned from 0 degrees to 360 degrees to find the maximum reading.
- e. The test-receiver system was set to Peak Detect Function and Specified Bandwidth with Maximum Hold Mode.
- f. If the emission level of the EUT in peak mode was 10dB lower than the limit specified, then testing could be stopped and the peak values of the EUT would be reported. Otherwise the emissions that did not have 10dB margin would be re-tested one by one using peak, quasi-peak or average method as specified and then reported in a data sheet.

NOTE:

1. The resolution bandwidth and video bandwidth of test receiver/spectrum analyzer is 120kHz for Peak detection (PK) and Quasi-peak detection (QP) at frequency below 1GHz.
2. The resolution bandwidth of test receiver/spectrum analyzer is 1MHz and video bandwidth is 3MHz for Peak detection at frequency above 1GHz.
3. The resolution bandwidth of test receiver/spectrum analyzer is 1MHz and the video bandwidth is 10Hz for Average detection (AV) at frequency above 1GHz.
4. All modes of operation were investigated and the worst-case emissions are reported.

4.1.5 DEVIATION FROM TEST STANDARD

No deviation

4.1.6 TEST SETUP

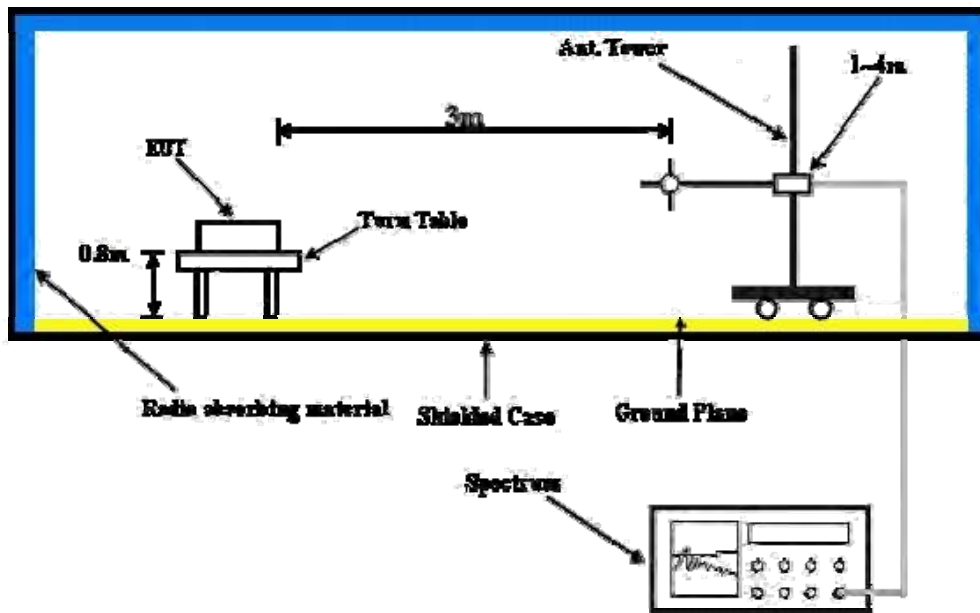

For the actual test configuration, please refer to the attached file (Test Setup Photo).

4.1.7 EUT OPERATING CONDITION

- Placed the EUT on the testing table.
- Prepared notebook systems to act as communication partners and placed them outside of testing area.
- The communication partners connected with EUT via a RJ45 cable and run a test program (provided by manufacturer) to enable EUT under transmission condition continuously at specific channel frequency.
- The necessary accessories enable the EUT in full functions.



A D T

4.1.8 TEST RESULTS

802.11a: 1TX

EUT TEST CONDITION		MEASUREMENT DETAIL	
CHANNEL	Channel 36	FREQUENCY RANGE	1 ~ 40GHz
INPUT POWER (SYSTEM)	120Vac, 60 Hz	DETECTOR FUNCTION	Peak (PK) Average (AV)
ENVIRONMENTAL CONDITIONS	23deg. C, 66%RH 1020 hPa	TESTED BY	Frank Wang

ANTENNA POLARITY & TEST DISTANCE: HORIZONTAL AT 3 M								
NO.	FREQ. (MHz)	EMISSION LEVEL (dBuV/m)	LIMIT (dBuV/m)	MARGIN (dB)	ANTENNA HEIGHT (m)	TABLE ANGLE (Degree)	RAW VALUE (dBuV)	CORRECTION FACTOR (dB/m)
1	5150.00	63.2 PK	74.0	-10.8	1.16 H	322	26.00	37.20
2	5150.00	46.0 AV	54.0	-8.0	1.16 H	322	8.80	37.20
3	*5180.00	105.0 PK			1.03 H	325	67.70	37.30
4	*5180.00	95.3 AV			1.03 H	325	58.00	37.30
5	#10360.00	57.6 PK	68.3	-10.7	1.02 H	140	9.40	48.20
ANTENNA POLARITY & TEST DISTANCE: VERTICAL AT 3 M								
NO.	FREQ. (MHz)	EMISSION LEVEL (dBuV/m)	LIMIT (dBuV/m)	MARGIN (dB)	ANTENNA HEIGHT (m)	TABLE ANGLE (Degree)	RAW VALUE (dBuV)	CORRECTION FACTOR (dB/m)
1	5150.00	65.6 PK	74.0	-8.4	1.02 V	17	28.40	37.20
2	5150.00	48.4 AV	54.0	-5.6	1.02 V	17	11.20	37.20
3	*5180.00	105.5 PK			1.02 V	17	68.20	37.30
4	*5180.00	95.6 AV			1.02 V	17	58.30	37.30
5	#10360.00	58.7 PK	68.3	-9.6	1.02 V	154	10.50	48.20

- REMARKS:**
1. Emission level (dBuV/m) = Raw Value (dBuV) + Correction Factor (dB/m).
 2. Correction Factor (dB/m) = Antenna Factor (dB/m) + Cable Factor (dB).
 3. The other emission levels were very low against the limit.
 4. Margin value = Emission level – Limit value.
 5. “ * “: Fundamental frequency.
 6. “#”:The radiated frequency is out the restricted band.



A D T

EUT TEST CONDITION		MEASUREMENT DETAIL	
CHANNEL	Channel 40	FREQUENCY RANGE	1 ~ 40GHz
INPUT POWER (SYSTEM)	120Vac, 60 Hz	DETECTOR FUNCTION	Peak (PK) Average (AV)
ENVIRONMENTAL CONDITIONS	23deg. C, 66%RH 1020 hPa	TESTED BY	Frank Wang

ANTENNA POLARITY & TEST DISTANCE: HORIZONTAL AT 3 M								
NO.	FREQ. (MHz)	EMISSION LEVEL (dBuV/m)	LIMIT (dBuV/m)	MARGIN (dB)	ANTENNA HEIGHT (m)	TABLE ANGLE (Degree)	RAW VALUE (dBuV)	CORRECTION FACTOR (dB/m)
1	#3467.00	41.3 PK	68.3	-27.0	1.09 H	217	8.20	33.10
2	*5200.00	105.4 PK			1.17 H	325	68.10	37.30
3	*5200.00	95.5 AV			1.17 H	325	58.20	37.30
4	#10400.00	58.1 PK	68.3	-10.2	1.02 H	144	9.90	48.20
ANTENNA POLARITY & TEST DISTANCE: VERTICAL AT 3 M								
NO.	FREQ. (MHz)	EMISSION LEVEL (dBuV/m)	LIMIT (dBuV/m)	MARGIN (dB)	ANTENNA HEIGHT (m)	TABLE ANGLE (Degree)	RAW VALUE (dBuV)	CORRECTION FACTOR (dB/m)
1	#3467.00	42.9 PK	68.3	-25.4	1.18 V	292	9.80	33.10
2	*5200.00	105.8 PK			1.00 V	30	68.50	37.30
3	*5200.00	95.9 AV			1.00 V	30	58.60	37.30
4	#10400.00	59.9 PK	68.3	-8.4	1.15 V	129	11.70	48.20

- REMARKS:**
1. Emission level (dBuV/m) = Raw Value (dBuV) + Correction Factor (dB/m).
 2. Correction Factor (dB/m) = Antenna Factor (dB/m) + Cable Factor (dB).
 3. The other emission levels were very low against the limit.
 4. Margin value = Emission level – Limit value.
 5. “ * “: Fundamental frequency.
 6. “#”:The radiated frequency is out the restricted band.



A D T

EUT TEST CONDITION		MEASUREMENT DETAIL	
CHANNEL	Channel 48	FREQUENCY RANGE	1 ~ 40GHz
INPUT POWER (SYSTEM)	120Vac, 60 Hz	DETECTOR FUNCTION	Peak (PK) Average (AV)
ENVIRONMENTAL CONDITIONS	23deg. C, 66%RH 1020 hPa	TESTED BY	Frank Wang

ANTENNA POLARITY & TEST DISTANCE: HORIZONTAL AT 3 M								
NO.	FREQ. (MHz)	EMISSION LEVEL (dBuV/m)	LIMIT (dBuV/m)	MARGIN (dB)	ANTENNA HEIGHT (m)	TABLE ANGLE (Degree)	RAW VALUE (dBuV)	CORRECTION FACTOR (dB/m)
1	*5240.00	105.7 PK			1.15 H	268	68.30	37.40
2	*5240.00	95.9 AV			1.15 H	268	58.50	37.40
3	5350.00	57.2 PK	74.0	-16.8	1.15 H	268	19.70	37.50
4	5350.00	45.8 AV	54.0	-8.2	1.15 H	268	8.30	37.50
5	#10480.00	57.7 PK	68.3	-10.6	1.02 H	153	9.30	48.40
ANTENNA POLARITY & TEST DISTANCE: VERTICAL AT 3 M								
NO.	FREQ. (MHz)	EMISSION LEVEL (dBuV/m)	LIMIT (dBuV/m)	MARGIN (dB)	ANTENNA HEIGHT (m)	TABLE ANGLE (Degree)	RAW VALUE (dBuV)	CORRECTION FACTOR (dB/m)
1	*5240.00	106.1 PK			1.00 V	12	68.70	37.40
2	*5240.00	96.2 AV			1.00 V	12	58.80	37.40
3	5350.00	58.6 PK	74.0	-15.4	1.00 V	12	21.10	37.50
4	5350.00	46.8 AV	54.0	-7.2	1.00 V	12	9.30	37.50
5	#10480.00	58.2 PK	68.3	-10.1	1.00 V	153	9.80	48.40

- REMARKS:**
1. Emission level (dBuV/m) = Raw Value (dBuV) + Correction Factor (dB/m).
 2. Correction Factor (dB/m) = Antenna Factor (dB/m) + Cable Factor (dB).
 3. The other emission levels were very low against the limit.
 4. Margin value = Emission level – Limit value.
 5. “ * “: Fundamental frequency.
 6. “#”:The radiated frequency is out the restricted band.



A D T

802.11n (20MHz): 1TX

EUT TEST CONDITION		MEASUREMENT DETAIL	
CHANNEL	Channel 36	FREQUENCY RANGE	1 ~ 40GHz
INPUT POWER (SYSTEM)	120Vac, 60 Hz	DETECTOR FUNCTION	Peak (PK) Average (AV)
ENVIRONMENTAL CONDITIONS	23deg. C, 66%RH 1020 hPa	TESTED BY	Frank Wang

ANTENNA POLARITY & TEST DISTANCE: HORIZONTAL AT 3 M								
NO.	FREQ. (MHz)	EMISSION LEVEL (dBuV/m)	LIMIT (dBuV/m)	MARGIN (dB)	ANTENNA HEIGHT (m)	TABLE ANGLE (Degree)	RAW VALUE (dBuV)	CORRECTION FACTOR (dB/m)
1	5150.00	63.5 PK	74.0	-10.5	1.04 H	324	26.30	37.20
2	5150.00	46.3 AV	54.0	-7.7	1.04 H	324	9.10	37.20
3	*5180.00	105.8 PK			1.04 H	324	68.50	37.30
4	*5180.00	95.8 AV			1.04 H	324	58.50	37.30
5	#10360.00	58.0 PK	68.3	-10.3	1.03 H	158	9.80	48.20

ANTENNA POLARITY & TEST DISTANCE: VERTICAL AT 3 M								
NO.	FREQ. (MHz)	EMISSION LEVEL (dBuV/m)	LIMIT (dBuV/m)	MARGIN (dB)	ANTENNA HEIGHT (m)	TABLE ANGLE (Degree)	RAW VALUE (dBuV)	CORRECTION FACTOR (dB/m)
1	5150.00	65.9 PK	74.0	-8.1	1.00 V	190	28.70	37.20
2	5150.00	48.2 AV	54.0	-5.8	1.00 V	190	11.00	37.20
3	*5180.00	106.4 PK			1.00 V	190	69.10	37.30
4	*5180.00	96.5 AV			1.00 V	190	59.20	37.30
5	#10360.00	59.6 PK	68.3	-8.7	1.62 V	133	11.40	48.20

- REMARKS:**
1. Emission level (dBuV/m) = Raw Value (dBuV) + Correction Factor (dB/m).
 2. Correction Factor (dB/m) = Antenna Factor (dB/m) + Cable Factor (dB).
 3. The other emission levels were very low against the limit.
 4. Margin value = Emission level – Limit value.
 5. “ * “: Fundamental frequency.
 6. “#”:The radiated frequency is out the restricted band.



A D T

EUT TEST CONDITION		MEASUREMENT DETAIL	
CHANNEL	Channel 40	FREQUENCY RANGE	1 ~ 40GHz
INPUT POWER (SYSTEM)	120Vac, 60 Hz	DETECTOR FUNCTION	Peak (PK) Average (AV)
ENVIRONMENTAL CONDITIONS	23deg. C, 66%RH 1020 hPa	TESTED BY	Frank Wang

ANTENNA POLARITY & TEST DISTANCE: HORIZONTAL AT 3 M								
NO.	FREQ. (MHz)	EMISSION LEVEL (dBuV/m)	LIMIT (dBuV/m)	MARGIN (dB)	ANTENNA HEIGHT (m)	TABLE ANGLE (Degree)	RAW VALUE (dBuV)	CORRECTION FACTOR (dB/m)
1	#3467.00	40.8 PK	68.3	-27.5	1.12 H	234	7.70	33.10
2	*5200.00	106.1 PK			1.13 H	315	68.80	37.30
3	*5200.00	96.0 AV			1.13 H	315	58.70	37.30
4	#10400.00	58.8 PK	68.3	-9.5	1.31 H	127	10.60	48.20
ANTENNA POLARITY & TEST DISTANCE: VERTICAL AT 3 M								
NO.	FREQ. (MHz)	EMISSION LEVEL (dBuV/m)	LIMIT (dBuV/m)	MARGIN (dB)	ANTENNA HEIGHT (m)	TABLE ANGLE (Degree)	RAW VALUE (dBuV)	CORRECTION FACTOR (dB/m)
1	#3467.00	42.3 PK	68.3	-26.0	1.13 V	300	9.20	33.10
2	*5200.00	106.7 PK			1.02 V	187	69.40	37.30
3	*5200.00	96.7 AV			1.02 V	187	59.40	37.30
4	#10400.00	59.5 PK	68.3	-8.8	1.18 V	135	11.30	48.20

- REMARKS:**
1. Emission level (dBuV/m) = Raw Value (dBuV) + Correction Factor (dB/m).
 2. Correction Factor (dB/m) = Antenna Factor (dB/m) + Cable Factor (dB).
 3. The other emission levels were very low against the limit.
 4. Margin value = Emission level – Limit value.
 5. “ * “: Fundamental frequency.
 6. “#”:The radiated frequency is out the restricted band.



A D T

EUT TEST CONDITION		MEASUREMENT DETAIL	
CHANNEL	Channel 48	FREQUENCY RANGE	1 ~ 40GHz
INPUT POWER (SYSTEM)	120Vac, 60 Hz	DETECTOR FUNCTION	Peak (PK) Average (AV)
ENVIRONMENTAL CONDITIONS	23deg. C, 66%RH 1020 hPa	TESTED BY	Frank Wang

ANTENNA POLARITY & TEST DISTANCE: HORIZONTAL AT 3 M								
NO.	FREQ. (MHz)	EMISSION LEVEL (dBuV/m)	LIMIT (dBuV/m)	MARGIN (dB)	ANTENNA HEIGHT (m)	TABLE ANGLE (Degree)	RAW VALUE (dBuV)	CORRECTION FACTOR (dB/m)
1	*5240.00	106.5 PK			1.17 H	299	69.10	37.40
2	*5240.00	96.6 AV			1.17 H	299	59.20	37.40
3	5350.00	56.9 PK	74.0	-17.1	1.17 H	302	19.40	37.50
4	5350.00	45.7 AV	54.0	-8.3	1.17 H	302	8.20	37.50
5	#10480.00	60.3 PK	68.3	-8.0	1.08 H	165	11.90	48.40
ANTENNA POLARITY & TEST DISTANCE: VERTICAL AT 3 M								
NO.	FREQ. (MHz)	EMISSION LEVEL (dBuV/m)	LIMIT (dBuV/m)	MARGIN (dB)	ANTENNA HEIGHT (m)	TABLE ANGLE (Degree)	RAW VALUE (dBuV)	CORRECTION FACTOR (dB/m)
1	*5240.00	106.9 PK			1.48 V	28	69.50	37.40
2	*5240.00	97.0 AV			1.48 V	28	59.60	37.40
3	5350.00	57.7 PK	74.0	-16.3	1.48 V	28	20.20	37.50
4	5350.00	45.7 AV	54.0	-8.3	1.48 V	28	8.20	37.50
5	#10480.00	61.3 PK	68.3	-7.0	1.70 V	118	12.90	48.40

- REMARKS:**
1. Emission level (dBuV/m) = Raw Value (dBuV) + Correction Factor (dB/m).
 2. Correction Factor (dB/m) = Antenna Factor (dB/m) + Cable Factor (dB).
 3. The other emission levels were very low against the limit.
 4. Margin value = Emission level – Limit value.
 5. “ * “: Fundamental frequency.
 6. “#”:The radiated frequency is out the restricted band.



A D T

802.11n (20MHz): 2TX

EUT TEST CONDITION		MEASUREMENT DETAIL	
CHANNEL	Channel 36	FREQUENCY RANGE	1 ~ 40GHz
INPUT POWER (SYSTEM)	120Vac, 60 Hz	DETECTOR FUNCTION	Peak (PK) Average (AV)
ENVIRONMENTAL CONDITIONS	23deg. C, 66%RH 1020 hPa	TESTED BY	Frank Wang

ANTENNA POLARITY & TEST DISTANCE: HORIZONTAL AT 3 M								
NO.	FREQ. (MHz)	EMISSION LEVEL (dBuV/m)	LIMIT (dBuV/m)	MARGIN (dB)	ANTENNA HEIGHT (m)	TABLE ANGLE (Degree)	RAW VALUE (dBuV)	CORRECTION FACTOR (dB/m)
1	5150.00	58.0 PK	74.0	-16.0	1.03 H	324	20.80	37.20
2	5150.00	42.5 AV	54.0	-11.5	1.03 H	324	5.30	37.20
3	*5180.00	105.3 PK			1.03 H	324	68.00	37.30
4	*5180.00	93.8 AV			1.03 H	324	56.50	37.30
5	#10360.00	56.1 PK	68.3	-12.2	1.00 H	140	7.90	48.20

ANTENNA POLARITY & TEST DISTANCE: VERTICAL AT 3 M								
NO.	FREQ. (MHz)	EMISSION LEVEL (dBuV/m)	LIMIT (dBuV/m)	MARGIN (dB)	ANTENNA HEIGHT (m)	TABLE ANGLE (Degree)	RAW VALUE (dBuV)	CORRECTION FACTOR (dB/m)
1	5150.00	60.5 PK	74.0	-13.5	1.00 V	190	23.30	37.20
2	5150.00	44.1 AV	54.0	-9.9	1.00 V	190	6.90	37.20
3	*5180.00	107.6 PK			1.00 V	190	70.30	37.30
4	*5180.00	97.1 AV			1.00 V	190	59.80	37.30
5	#10360.00	61.1 PK	68.3	-7.2	1.72 V	106	12.90	48.20

- REMARKS:**
1. Emission level (dBuV/m) = Raw Value (dBuV) + Correction Factor (dB/m).
 2. Correction Factor (dB/m) = Antenna Factor (dB/m) + Cable Factor (dB).
 3. The other emission levels were very low against the limit.
 4. Margin value = Emission level – Limit value.
 5. “ * “: Fundamental frequency.
 6. “#“: The radiated frequency is out the restricted band.



A D T

EUT TEST CONDITION		MEASUREMENT DETAIL	
CHANNEL	Channel 40	FREQUENCY RANGE	1 ~ 40GHz
INPUT POWER (SYSTEM)	120Vac, 60 Hz	DETECTOR FUNCTION	Peak (PK) Average (AV)
ENVIRONMENTAL CONDITIONS	23deg. C, 66%RH 1020 hPa	TESTED BY	Frank Wang

ANTENNA POLARITY & TEST DISTANCE: HORIZONTAL AT 3 M								
NO.	FREQ. (MHz)	EMISSION LEVEL (dBuV/m)	LIMIT (dBuV/m)	MARGIN (dB)	ANTENNA HEIGHT (m)	TABLE ANGLE (Degree)	RAW VALUE (dBuV)	CORRECTION FACTOR (dB/m)
1	#3467.00	41.0 PK	68.3	-27.3	1.14 H	245	7.90	33.10
2	*5200.00	105.8 PK			1.15 H	318	68.50	37.30
3	*5200.00	94.3 AV			1.15 H	318	57.00	37.30
4	#10400.00	56.8 PK	68.3	-11.5	1.00 H	141	8.60	48.20

ANTENNA POLARITY & TEST DISTANCE: VERTICAL AT 3 M								
NO.	FREQ. (MHz)	EMISSION LEVEL (dBuV/m)	LIMIT (dBuV/m)	MARGIN (dB)	ANTENNA HEIGHT (m)	TABLE ANGLE (Degree)	RAW VALUE (dBuV)	CORRECTION FACTOR (dB/m)
1	#3467.00	42.2 PK	68.3	-26.1	1.04 V	283	9.10	33.10
2	*5200.00	107.8 PK			1.00 V	16	70.50	37.30
3	*5200.00	97.5 AV			1.00 V	16	60.20	37.30
4	#10400.00	59.7 PK	68.3	-8.6	1.09 V	120	11.50	48.20

- REMARKS:**
1. Emission level (dBuV/m) = Raw Value (dBuV) + Correction Factor (dB/m).
 2. Correction Factor (dB/m) = Antenna Factor (dB/m) + Cable Factor (dB).
 3. The other emission levels were very low against the limit.
 4. Margin value = Emission level – Limit value.
 5. “ * “: Fundamental frequency.
 6. “#”: The radiated frequency is out the restricted band.



A D T

EUT TEST CONDITION		MEASUREMENT DETAIL	
CHANNEL	Channel 48	FREQUENCY RANGE	1 ~ 40GHz
INPUT POWER (SYSTEM)	120Vac, 60 Hz	DETECTOR FUNCTION	Peak (PK) Average (AV)
ENVIRONMENTAL CONDITIONS	23deg. C, 66%RH 1020 hPa	TESTED BY	Frank Wang

ANTENNA POLARITY & TEST DISTANCE: HORIZONTAL AT 3 M								
NO.	FREQ. (MHz)	EMISSION LEVEL (dBuV/m)	LIMIT (dBuV/m)	MARGIN (dB)	ANTENNA HEIGHT (m)	TABLE ANGLE (Degree)	RAW VALUE (dBuV)	CORRECTION FACTOR (dB/m)
1	*5240.00	104.8 PK			1.03 H	320	67.40	37.40
2	*5240.00	93.7 AV			1.03 H	320	56.30	37.40
3	5350.00	55.0 PK	74.0	-19.0	1.03 H	320	17.50	37.50
4	5350.00	42.4 AV	54.0	-11.6	1.03 H	320	4.90	37.50
5	#10480.00	54.9 PK	68.3	-13.4	1.08 H	140	6.50	48.40
ANTENNA POLARITY & TEST DISTANCE: VERTICAL AT 3 M								
NO.	FREQ. (MHz)	EMISSION LEVEL (dBuV/m)	LIMIT (dBuV/m)	MARGIN (dB)	ANTENNA HEIGHT (m)	TABLE ANGLE (Degree)	RAW VALUE (dBuV)	CORRECTION FACTOR (dB/m)
1	*5240.00	107.7 PK			1.00 V	188	70.30	37.40
2	*5240.00	97.2 AV			1.00 V	188	59.80	37.40
3	5350.00	55.3 PK	74.0	-18.7	1.00 V	188	17.80	37.50
4	5350.00	43.3 AV	54.0	-10.7	1.00 V	188	5.80	37.50
5	#10480.00	58.9 PK	68.3	-9.4	1.69 V	105	10.50	48.40

- REMARKS:**
1. Emission level (dBuV/m) = Raw Value (dBuV) + Correction Factor (dB/m).
 2. Correction Factor (dB/m) = Antenna Factor (dB/m) + Cable Factor (dB).
 3. The other emission levels were very low against the limit.
 4. Margin value = Emission level – Limit value.
 5. “ * “: Fundamental frequency.
 6. "#":The radiated frequency is out the restricted band.



A D T

802.11n (40MHz): 1TX

EUT TEST CONDITION		MEASUREMENT DETAIL	
CHANNEL	Channel 38	FREQUENCY RANGE	1 ~ 40GHz
INPUT POWER (SYSTEM)	120Vac, 60 Hz	DETECTOR FUNCTION	Peak (PK) Average (AV)
ENVIRONMENTAL CONDITIONS	23deg. C, 66%RH 1020 hPa	TESTED BY	Frank Wang

ANTENNA POLARITY & TEST DISTANCE: HORIZONTAL AT 3 M								
NO.	FREQ. (MHz)	EMISSION LEVEL (dBuV/m)	LIMIT (dBuV/m)	MARGIN (dB)	ANTENNA HEIGHT (m)	TABLE ANGLE (Degree)	RAW VALUE (dBuV)	CORRECTION FACTOR (dB/m)
1	5150.00	67.9 PK	74.0	-6.1	1.17 H	322	30.70	37.20
2	5150.00	51.8 AV	54.0	-2.2	1.17 H	322	14.60	37.20
3	*5190.00	102.7 PK			1.03 H	325	65.40	37.30
4	*5190.00	92.5 AV			1.03 H	325	55.20	37.30
5	#10380.00	58.9 PK	68.3	-9.4	1.07 H	138	10.70	48.20

ANTENNA POLARITY & TEST DISTANCE: VERTICAL AT 3 M								
NO.	FREQ. (MHz)	EMISSION LEVEL (dBuV/m)	LIMIT (dBuV/m)	MARGIN (dB)	ANTENNA HEIGHT (m)	TABLE ANGLE (Degree)	RAW VALUE (dBuV)	CORRECTION FACTOR (dB/m)
1	5150.00	68.1 PK	74.0	-5.9	1.01 V	17	30.90	37.20
2	5150.00	52.8 AV	54.0	-1.2	1.01 V	17	15.60	37.20
3	*5190.00	103.1 PK			1.02 V	17	65.80	37.30
4	*5190.00	92.9 AV			1.02 V	17	55.60	37.30
5	#10380.00	59.7 PK	68.3	-8.6	1.16 V	143	11.50	48.20

- REMARKS:**
1. Emission level (dBuV/m) = Raw Value (dBuV) + Correction Factor (dB/m).
 2. Correction Factor (dB/m) = Antenna Factor (dB/m) + Cable Factor (dB).
 3. The other emission levels were very low against the limit.
 4. Margin value = Emission level – Limit value.
 5. “ * “: Fundamental frequency.
 6. “#”:The radiated frequency is out the restricted band.



A D T

EUT TEST CONDITION		MEASUREMENT DETAIL	
CHANNEL	Channel 46	FREQUENCY RANGE	1 ~ 40GHz
INPUT POWER (SYSTEM)	120Vac, 60 Hz	DETECTOR FUNCTION	Peak (PK) Average (AV)
ENVIRONMENTAL CONDITIONS	23deg. C, 66%RH 1020 hPa	TESTED BY	Frank Wang

ANTENNA POLARITY & TEST DISTANCE: HORIZONTAL AT 3 M								
NO.	FREQ. (MHz)	EMISSION LEVEL (dBuV/m)	LIMIT (dBuV/m)	MARGIN (dB)	ANTENNA HEIGHT (m)	TABLE ANGLE (Degree)	RAW VALUE (dBuV)	CORRECTION FACTOR (dB/m)
1	*5230.00	103.7 PK			1.07 H	269	66.30	37.40
2	*5230.00	92.7 AV			1.07 H	269	55.30	37.40
3	5350.00	56.2 PK	74.0	-17.8	1.08 H	277	18.70	37.50
4	5350.00	44.3 AV	54.0	-9.7	1.08 H	277	6.80	37.50
5	#10460.00	57.1 PK	68.3	-11.2	1.38 H	278	8.70	48.40
ANTENNA POLARITY & TEST DISTANCE: VERTICAL AT 3 M								
NO.	FREQ. (MHz)	EMISSION LEVEL (dBuV/m)	LIMIT (dBuV/m)	MARGIN (dB)	ANTENNA HEIGHT (m)	TABLE ANGLE (Degree)	RAW VALUE (dBuV)	CORRECTION FACTOR (dB/m)
1	*5230.00	103.6 PK			1.02 V	18	66.20	37.40
2	*5230.00	93.0 AV			1.02 V	18	55.60	37.40
3	5350.00	57.6 PK	74.0	-16.4	1.02 V	18	20.10	37.50
4	5350.00	45.7 AV	54.0	-8.3	1.02 V	18	8.20	37.50
5	#10460.00	58.7 PK	68.3	-9.6	1.77 V	108	10.30	48.40

- REMARKS:**
1. Emission level (dBuV/m) = Raw Value (dBuV) + Correction Factor (dB/m).
 2. Correction Factor (dB/m) = Antenna Factor (dB/m) + Cable Factor (dB).
 3. The other emission levels were very low against the limit.
 4. Margin value = Emission level – Limit value.
 5. “ * “: Fundamental frequency.
 6. “#”:The radiated frequency is out the restricted band.



A D T

802.11n (40MHz): 2TX

EUT TEST CONDITION		MEASUREMENT DETAIL	
CHANNEL	Channel 38	FREQUENCY RANGE	1 ~ 40GHz
INPUT POWER (SYSTEM)	120Vac, 60 Hz	DETECTOR FUNCTION	Peak (PK) Average (AV)
ENVIRONMENTAL CONDITIONS	23deg. C, 66%RH 1020 hPa	TESTED BY	Frank Wang

ANTENNA POLARITY & TEST DISTANCE: HORIZONTAL AT 3 M								
NO.	FREQ. (MHz)	EMISSION LEVEL (dBuV/m)	LIMIT (dBuV/m)	MARGIN (dB)	ANTENNA HEIGHT (m)	TABLE ANGLE (Degree)	RAW VALUE (dBuV)	CORRECTION FACTOR (dB/m)
1	5150.00	62.4 PK	74.0	-11.6	1.03 H	324	25.20	37.20
2	5150.00	48.1 AV	54.0	-5.9	1.03 H	324	10.90	37.20
3	*5190.00	102.2 PK			1.04 H	323	64.90	37.30
4	*5190.00	91.8 AV			1.04 H	323	54.50	37.30
5	#10380.00	54.7 PK	68.3	-13.6	1.00 H	138	6.50	48.20
ANTENNA POLARITY & TEST DISTANCE: VERTICAL AT 3 M								
NO.	FREQ. (MHz)	EMISSION LEVEL (dBuV/m)	LIMIT (dBuV/m)	MARGIN (dB)	ANTENNA HEIGHT (m)	TABLE ANGLE (Degree)	RAW VALUE (dBuV)	CORRECTION FACTOR (dB/m)
1	5150.00	63.0 PK	74.0	-11.0	1.00 V	197	25.80	37.20
2	5150.00	50.1 AV	54.0	-3.9	1.00 V	197	12.90	37.20
3	*5190.00	103.5 PK			1.00 V	197	66.20	37.30
4	*5190.00	93.0 AV			1.00 V	197	55.70	37.30
5	#10380.00	58.6 PK	68.3	-9.7	1.72 V	105	10.40	48.20

- REMARKS:**
1. Emission level (dBuV/m) = Raw Value (dBuV) + Correction Factor (dB/m).
 2. Correction Factor (dB/m) = Antenna Factor (dB/m) + Cable Factor (dB).
 3. The other emission levels were very low against the limit.
 4. Margin value = Emission level – Limit value.
 5. “ * ”: Fundamental frequency.
 6. “#”: The radiated frequency is out the restricted band.



A D T

EUT TEST CONDITION		MEASUREMENT DETAIL	
CHANNEL	Channel 46	FREQUENCY RANGE	1 ~ 40GHz
INPUT POWER (SYSTEM)	120Vac, 60 Hz	DETECTOR FUNCTION	Peak (PK) Average (AV)
ENVIRONMENTAL CONDITIONS	23deg. C, 66%RH 1020 hPa	TESTED BY	Frank Wang

ANTENNA POLARITY & TEST DISTANCE: HORIZONTAL AT 3 M								
NO.	FREQ. (MHz)	EMISSION LEVEL (dBuV/m)	LIMIT (dBuV/m)	MARGIN (dB)	ANTENNA HEIGHT (m)	TABLE ANGLE (Degree)	RAW VALUE (dBuV)	CORRECTION FACTOR (dB/m)
1	*5230.00	102.6 PK			1.02 H	325	65.20	37.40
2	*5230.00	91.8 AV			1.02 H	325	54.40	37.40
3	5350.00	56.5 PK	74.0	-17.5	1.02 H	325	19.00	37.50
4	5350.00	45.1 AV	54.0	-8.9	1.02 H	325	7.60	37.50
5	#10460.00	55.1 PK	68.3	-13.2	1.00 H	42	6.70	48.40
ANTENNA POLARITY & TEST DISTANCE: VERTICAL AT 3 M								
NO.	FREQ. (MHz)	EMISSION LEVEL (dBuV/m)	LIMIT (dBuV/m)	MARGIN (dB)	ANTENNA HEIGHT (m)	TABLE ANGLE (Degree)	RAW VALUE (dBuV)	CORRECTION FACTOR (dB/m)
1	*5230.00	104.2 PK			1.09 V	200	66.80	37.40
2	*5230.00	93.5 AV			1.09 V	200	56.10	37.40
3	5350.00	57.8 PK	74.0	-16.2	1.09 V	200	20.30	37.50
4	5350.00	47.1 AV	54.0	-6.9	1.09 V	200	9.60	37.50
5	#10460.00	57.9 PK	68.3	-10.4	1.64 V	106	9.50	48.40

- REMARKS:**
1. Emission level (dBuV/m) = Raw Value (dBuV) + Correction Factor (dB/m).
 2. Correction Factor (dB/m) = Antenna Factor (dB/m) + Cable Factor (dB).
 3. The other emission levels were very low against the limit.
 4. Margin value = Emission level – Limit value.
 5. “ * “: Fundamental frequency.
 6. "#":The radiated frequency is out the restricted band.



A D T

BELOW 1GHz WORST-CASE DATA : 802.11n (40MHz): 1TX

EUT TEST CONDITION		MEASUREMENT DETAIL	
CHANNEL	Channel 46	FREQUENCY RANGE	Below 1000MHz
INPUT POWER (SYSTEM)	120Vac, 60 Hz	DETECTOR FUNCTION	Quasi-Peak
ENVIRONMENTAL CONDITIONS	23deg. C, 66%RH 1020 hPa	TEST MODE	A
TESTED BY	Mark Liao		

ANTENNA POLARITY & TEST DISTANCE: HORIZONTAL AT 3 M								
NO.	FREQ. (MHz)	EMISSION LEVEL (dBuV/m)	LIMIT (dBuV/m)	MARGIN (dB)	ANTENNA HEIGHT (m)	TABLE ANGLE (Degree)	RAW VALUE (dBuV)	CORRECTION FACTOR (dB/m)
1	146.56	38.0 QP	43.5	-5.5	1.75 H	334	24.50	13.50
2	239.88	29.8 QP	46.0	-16.2	1.25 H	109	17.40	12.40
3	469.31	31.9 QP	46.0	-14.1	1.75 H	40	13.50	18.40
4	500.42	38.2 QP	46.0	-7.8	1.75 H	316	18.90	19.30
5	624.85	37.3 QP	46.0	-8.7	2.50 H	19	15.10	22.20
6	751.23	29.2 QP	46.0	-16.8	1.00 H	313	5.20	24.00
ANTENNA POLARITY & TEST DISTANCE: VERTICAL AT 3 M								
NO.	FREQ. (MHz)	EMISSION LEVEL (dBuV/m)	LIMIT (dBuV/m)	MARGIN (dB)	ANTENNA HEIGHT (m)	TABLE ANGLE (Degree)	RAW VALUE (dBuV)	CORRECTION FACTOR (dB/m)
1	55.98	36.3 QP	40.0	-3.7	1.24 V	237	22.70	13.60
2	62.95	34.8 QP	40.0	-5.2	1.00 V	40	21.90	12.90
3	107.67	37.3 QP	43.5	-6.2	1.25 V	286	27.00	10.30
4	469.31	34.2 QP	46.0	-11.8	1.00 V	346	15.80	18.40
5	500.42	35.1 QP	46.0	-10.9	1.25 V	163	15.80	19.30
6	624.85	37.4 QP	46.0	-8.6	1.75 V	7	15.20	22.20

- REMARKS:**
1. Emission level (dBuV/m) = Raw Value (dBuV) + Correction Factor (dB/m).
 2. Correction Factor (dB/m) = Antenna Factor (dB/m) + Cable Factor (dB).
 3. The other emission levels were very low against the limit.
 4. Margin value = Emission level – Limit value.



A D T

EUT TEST CONDITION		MEASUREMENT DETAIL	
CHANNEL	Channel 46	FREQUENCY RANGE	Below 1000MHz
INPUT POWER (SYSTEM)	120Vac, 60 Hz	DETECTOR FUNCTION	Quasi-Peak
ENVIRONMENTAL CONDITIONS	23deg. C, 66%RH 1020 hPa	TEST MODE	B
TESTED BY	Mark Liao		

ANTENNA POLARITY & TEST DISTANCE: HORIZONTAL AT 3 M								
NO.	FREQ. (MHz)	EMISSION LEVEL (dBuV/m)	LIMIT (dBuV/m)	MARGIN (dB)	ANTENNA HEIGHT (m)	TABLE ANGLE (Degree)	RAW VALUE (dBuV)	CORRECTION FACTOR (dB/m)
1	103.78	25.9 QP	43.5	-17.6	1.75 H	121	16.10	9.80
2	214.61	31.3 QP	43.5	-12.2	1.50 H	115	20.00	11.30
3	249.60	26.5 QP	46.0	-19.5	1.25 H	292	13.60	12.90
4	500.42	36.3 QP	46.0	-9.7	1.75 H	316	17.00	19.30
5	599.58	35.0 QP	46.0	-11.0	1.25 H	31	13.00	22.00
6	657.91	29.0 QP	46.0	-17.0	1.25 H	310	6.60	22.40
ANTENNA POLARITY & TEST DISTANCE: VERTICAL AT 3 M								
NO.	FREQ. (MHz)	EMISSION LEVEL (dBuV/m)	LIMIT (dBuV/m)	MARGIN (dB)	ANTENNA HEIGHT (m)	TABLE ANGLE (Degree)	RAW VALUE (dBuV)	CORRECTION FACTOR (dB/m)
1	57.12	33.8 QP	40.0	-6.2	1.00 V	175	20.30	13.50
2	103.78	33.6 QP	43.5	-9.9	1.25 V	127	23.80	9.80
3	218.50	27.1 QP	46.0	-18.9	1.25 V	196	15.60	11.50
4	249.60	27.4 QP	46.0	-18.6	1.00 V	262	14.50	12.90
5	500.42	32.8 QP	46.0	-13.2	1.00 V	10	13.50	19.30
6	599.58	31.6 QP	46.0	-14.4	1.50 V	346	9.60	22.00

- REMARKS:**
1. Emission level (dBuV/m) = Raw Value (dBuV) + Correction Factor (dB/m).
 2. Correction Factor (dB/m) = Antenna Factor (dB/m) + Cable Factor (dB).
 3. The other emission levels were very low against the limit.
 4. Margin value = Emission level – Limit value.



A D T

4.2 CONDUCTED EMISSION MEASUREMENT

4.2.1 LIMITS OF CONDUCTED EMISSION MEASUREMENT

FREQUENCY OF EMISSION (MHz)	CONDUCTED LIMIT (dB μ V)	
	Quasi-peak	Average
0.15 ~ 0.5	66 to 56	56 to 46
0.5 ~ 5	56	46
5 ~ 30	60	50

- NOTE:**
1. The lower limit shall apply at the transition frequencies.
 2. The limit decreases in line with the logarithm of the frequency in the range of 0.15 to 0.50MHz.
 3. All emanations from a class A/B digital device or system, including any network of conductors and apparatus connected thereto, shall not exceed the level of field strengths specified above.

4.2.2 TEST INSTRUMENTS

DESCRIPTION & MANUFACTURER	MODEL NO.	SERIAL NO.	DATE OF CALIBRATION	DUE DATE OF CALIBRATION
Test Receiver ROHDE & SCHWARZ	ESCS30	100289	Nov. 23, 2010	Nov. 22, 2011
RF signal cable Woken	5D-FB	Cable-HYCO2-01	Dec. 30, 2010	Dec. 29, 2011
LISN ROHDE & SCHWARZ	ESH2-Z5	100100	Jan. 06, 2011	Jan. 05, 2012
LISN ROHDE & SCHWARZ	ESH3-Z5	100311	Jul. 08, 2010	Jul. 07, 2011
V-LISN SCHWARZBECK	NNBL 8226-2	8226-142	Jul. 12, 2010	Jul. 11, 2011
LISN ROHDE & SCHWARZ	ENV216	100072	Jun. 11, 2010	Jun. 10, 2011
Software ADT	ADT_Cond_ V7.3.7	NA	NA	NA

- NOTE:**
1. The calibration interval of the above test instruments is 12 months and the calibrations are traceable to NML/ROC and NIST/USA.
 2. The test was performed in HwaYa Shielded Room 2.
 3. The VCCI Site Registration No. is C-2047.



A D T

4.2.3 TEST PROCEDURES

- a. The EUT was placed 0.4 meters from the conducting wall of the shielded room with EUT being connected to the power mains through a line impedance stabilization network (LISN). Other support units were connected to the power mains through another LISN. The two LISNs provide 50 ohm/ 50uH of coupling impedance for the measuring instrument.
- b. Both lines of the power mains connected to the EUT were checked for maximum conducted interference.
- c. The frequency range from 150kHz to 30MHz was searched. Emission levels under (Limit - 20dB) was not recorded.

4.2.4 DEVIATION FROM TEST STANDARD

No deviation

4.2.5 TEST SETUP

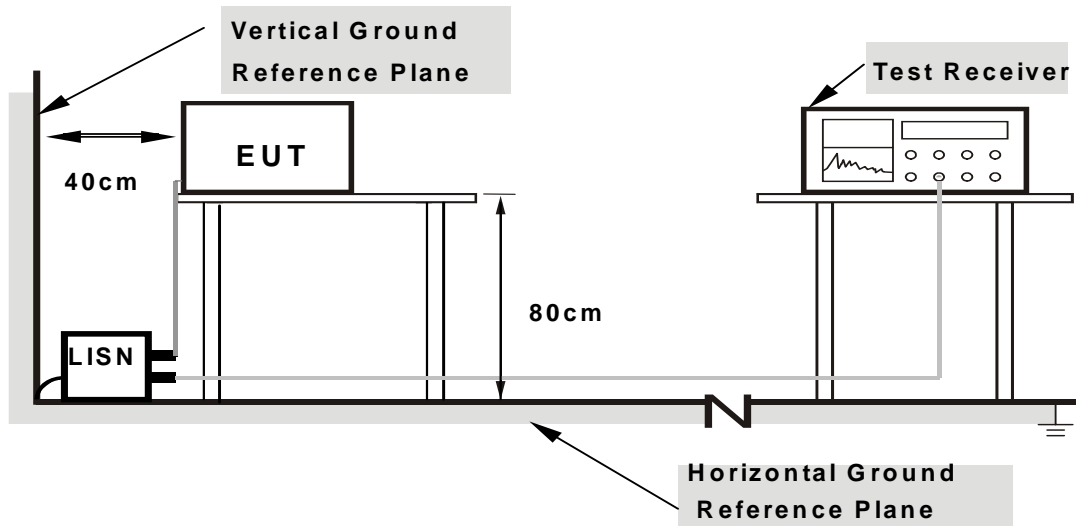

Note: 1. Support units were connected to second LISN.

2. Both of LISNs (AMN) are 80 cm from EUT and at least 80 cm from other units and other metal planes

For the actual test configuration, please refer to the attached file (Test Setup Photo).

4.2.6 EUT OPERATING CONDITIONS

Same as 4.1.6.

4.2.7 TEST RESULTS

CONDUCTED WORST-CASE DATA : 802.11n (40MHz)

PHASE	Line 1	6dB BANDWIDTH	9kHz
TEST MODE	A		

No	Freq. [MHz]	Corr. Factor (dB)	Reading Value [dB (uV)]		Emission Level [dB (uV)]		Limit [dB (uV)]		Margin (dB)	
			Q.P.	AV.	Q.P.	AV.	Q.P.	AV.	Q.P.	AV.
			1	0.150	0.15	32.87	-	33.02	-	66.00
2	0.271	0.16	32.83	-	32.99	-	61.08	51.08	-28.10	-
3	0.330	0.16	26.66	-	26.82	-	59.46	49.46	-32.64	-
4	0.923	0.19	15.96	-	16.15	-	56.00	46.00	-39.85	-
5	18.242	1.05	32.78	-	33.83	-	60.00	50.00	-26.17	-
6	23.129	1.20	37.31	-	38.51	-	60.00	50.00	-21.49	-

- REMARKS:**
1. Q.P. and AV. are abbreviations of quasi-peak and average individually.
 2. "-": The Quasi-peak reading value also meets average limit and measurement with the average detector is unnecessary.
 3. The emission levels of other frequencies were very low against the limit.
 4. Margin value = Emission level - Limit value
 5. Correction factor = Insertion loss + Cable loss
 6. Emission Level = Correction Factor + Reading Value.

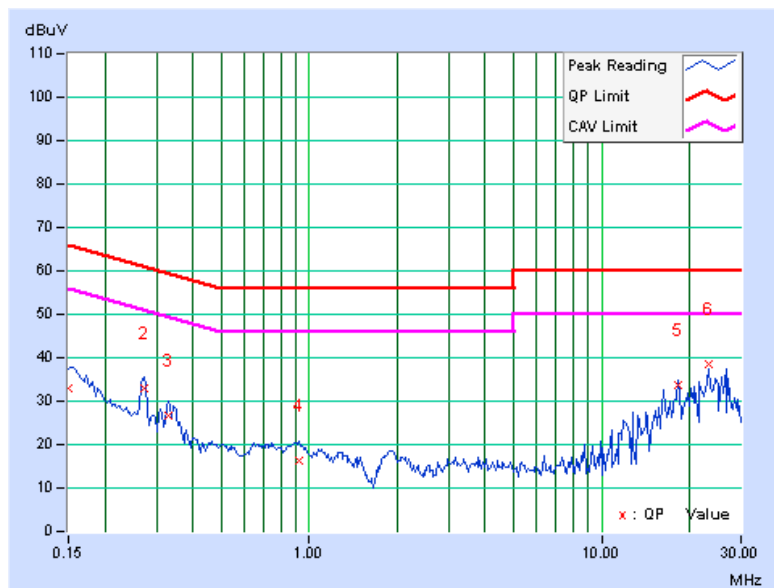



A D T

PHASE	Line 2	6dB BANDWIDTH	9kHz
TEST MODE	A		

No	Freq. [MHz]	Corr. Factor (dB)	Reading Value		Emission Level		Limit		Margin	
			[dB (uV)]		[dB (uV)]		[dB (uV)]		(dB)	
			Q.P.	AV.	Q.P.	AV.	Q.P.	AV.	Q.P.	AV.
1	0.150	0.16	34.08	-	34.24	-	66.00	56.00	-31.76	-
2	0.271	0.18	32.91	-	33.09	-	61.08	51.08	-28.00	-
3	0.334	0.18	27.68	-	27.86	-	59.36	49.36	-31.50	-
4	0.693	0.20	17.03	-	17.23	-	56.00	46.00	-38.77	-
5	19.711	0.91	29.31	-	30.22	-	60.00	50.00	-29.78	-
6	24.352	1.02	30.09	-	31.11	-	60.00	50.00	-28.89	-

- REMARKS:**
1. Q.P. and AV. are abbreviations of quasi-peak and average individually.
 2. "-": The Quasi-peak reading value also meets average limit and measurement with the average detector is unnecessary.
 3. The emission levels of other frequencies were very low against the limit.
 4. Margin value = Emission level - Limit value
 5. Correction factor = Insertion loss + Cable loss
 6. Emission Level = Correction Factor + Reading Value.

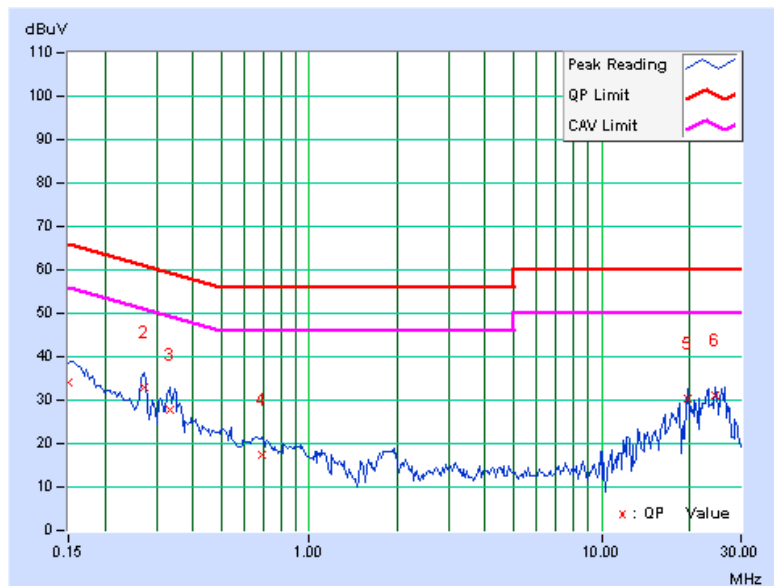



A D T

PHASE	Line 1	6dB BANDWIDTH	9kHz
TEST MODE	B		

No	Freq. [MHz]	Corr. Factor (dB)	Reading Value		Emission Level		Limit		Margin	
			[dB (uV)]		[dB (uV)]		[dB (uV)]		(dB)	
			Q.P.	AV.	Q.P.	AV.	Q.P.	AV.	Q.P.	AV.
1	0.177	0.15	35.44	-	35.59	-	64.61	54.61	-29.02	-
2	0.412	0.17	31.00	-	31.17	-	57.61	47.61	-26.44	-
3	1.770	0.21	30.08	-	30.29	-	56.00	46.00	-25.71	-
4	2.957	0.27	37.22	-	37.49	-	56.00	46.00	-18.51	-
5	7.922	0.48	39.09	-	39.57	-	60.00	50.00	-20.43	-
6	11.707	0.67	42.10	-	42.77	-	60.00	50.00	-17.23	-

- REMARKS:**
1. Q.P. and AV. are abbreviations of quasi-peak and average individually.
 2. "-": The Quasi-peak reading value also meets average limit and measurement with the average detector is unnecessary.
 3. The emission levels of other frequencies were very low against the limit.
 4. Margin value = Emission level - Limit value
 5. Correction factor = Insertion loss + Cable loss
 6. Emission Level = Correction Factor + Reading Value.

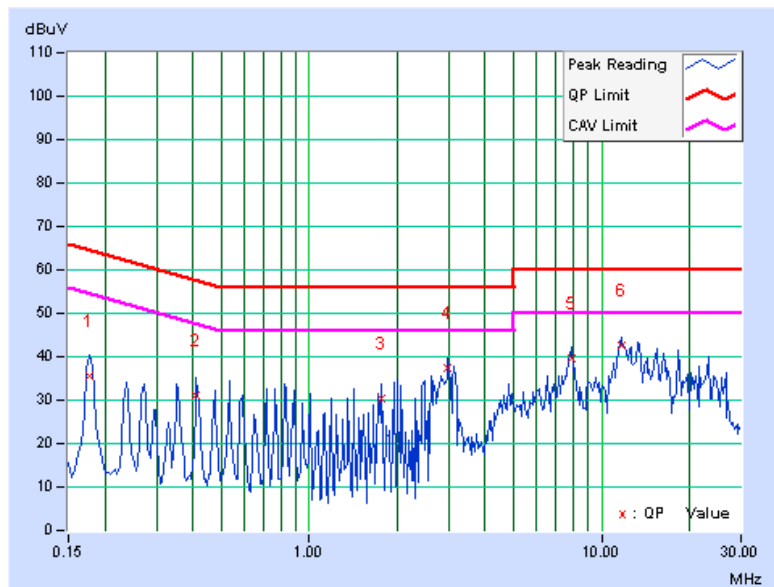



A D T

PHASE	Line 2	6dB BANDWIDTH	9kHz
TEST MODE	B		

No	Freq. [MHz]	Corr. Factor (dB)	Reading Value [dB (uV)]		Emission Level [dB (uV)]		Limit [dB (uV)]		Margin (dB)	
			Q.P.	AV.	Q.P.	AV.	Q.P.	AV.	Q.P.	AV.
1	0.177	0.16	36.82	-	36.98	-	64.61	54.61	-27.63	-
2	0.353	0.19	30.73	-	30.92	-	58.89	48.89	-27.97	-
3	0.533	0.19	32.42	-	32.61	-	56.00	46.00	-23.39	-
4	2.898	0.27	38.66	-	38.93	-	56.00	46.00	-17.07	-
5	8.039	0.44	38.42	-	38.86	-	60.00	50.00	-21.14	-
6	11.938	0.59	38.89	-	39.48	-	60.00	50.00	-20.52	-

- REMARKS:**
1. Q.P. and AV. are abbreviations of quasi-peak and average individually.
 2. "-": The Quasi-peak reading value also meets average limit and measurement with the average detector is unnecessary.
 3. The emission levels of other frequencies were very low against the limit.
 4. Margin value = Emission level - Limit value
 5. Correction factor = Insertion loss + Cable loss
 6. Emission Level = Correction Factor + Reading Value.

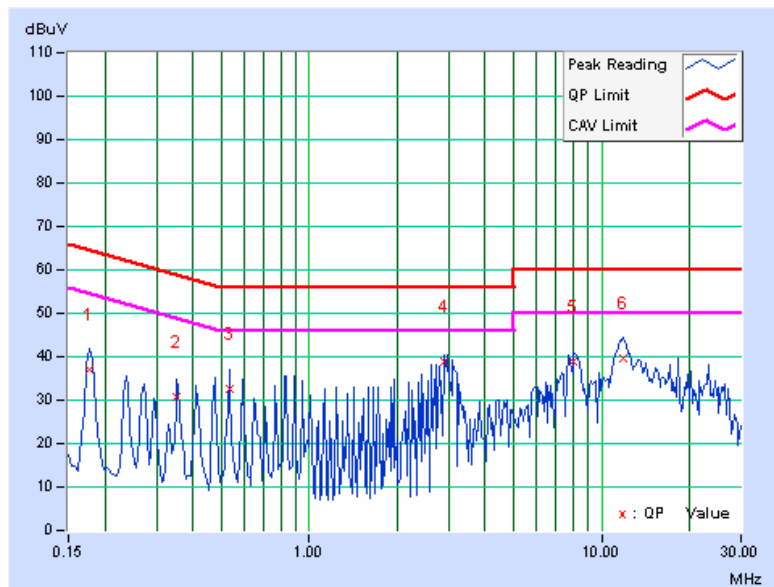



A D T

4.3 MAXIMUM CONDUCTED OUTPUT POWER MEASUREMENT

4.3.1 LIMITS OF MAXIMUM CONDUCTED OUTPUT POWER MEASUREMENT

FREQUENCY BAND	LIMIT
5.15 ~ 5.25GHz	The lesser of 50mW (17dBm) or 4dBm + 10logB

NOTE: Where B is the 26dB emission bandwidth in MHz.

4.3.2 TEST INSTRUMENTS

FOR POWER OUTPUT MEASUREMENT

DESCRIPTION & MANUFACTURER	MODEL NO.	SERIAL NO.	DATE OF CALIBRATION	DUE DATE OF CALIBRATION
High Speed Peak Power Meter	ML2495A	0842014	Apr. 21, 2010	Apr. 20, 2011
Power Sensor	MA2411B	0738404	Apr. 21, 2010	Apr. 20, 2011

NOTE: 1. The calibration interval of the above test instruments is 12 months and the calibrations are traceable to NML/ROC and NIST/USA.
2. Measurement Bandwidth of ML2495A is 65MHz greater than 26dB bandwidth of emission.

FOR 26dB OCCUPIED BANDWIDTH

DESCRIPTION & MANUFACTURER	MODEL NO.	SERIAL NO.	DATE OF CALIBRATION	DUE DATE OF CALIBRATION
SPECTRUM ANALYZER R&S	FSP40	100039	Jul. 09, 2010	Jul. 08, 2011

NOTE: The calibration interval of the above test instruments is 12 months and the calibrations are traceable to NML/ROC and NIST/USA.

4.3.3 TEST PROCEDURE

FOR POWER OUTPUT MEASUREMENT

A power sensor was used on the output port of the EUT. A power meter was used to read the response of the power sensor. Record the power level.

FOR 26dB OCCUPIED BANDWIDTH

The transmitter output was connected to the spectrum analyzer through an attenuator. The bandwidth of the fundamental frequency was measured by spectrum analyzer with 300kHz RBW and 1MHz VBW. The 26dB bandwidth is defined as the total spectrum the power of which is higher than peak power minus 26dB.

4.3.4 DEVIATION FROM TEST STANDARD

No deviation

4.3.5 TEST SETUP

FOR POWER OUTPUT MEASUREMENT

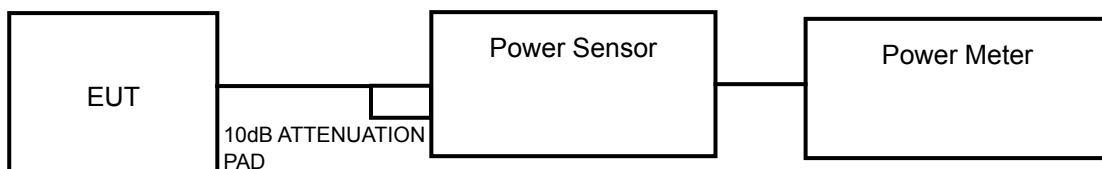

FOR 26dB OCCUPIED BANDWIDTH

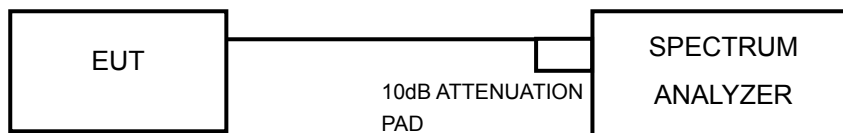

4.3.6 EUT OPERATING CONDITIONS

The software provided by client to enable the EUT under transmission condition continuously at specific channel frequencies individually.



4.3.7 TEST RESULTS

POWER OUTPUT: 802.11a: 1TX

CHANNEL	CHANNEL FREQUENCY (MHz)	PEAK POWER OUTPUT (mW)	PEAK POWER OUTPUT (dBm)	PEAK POWER LIMIT (dBm)	PASS/FAIL
36	5180	35.5	15.5	17	PASS
40	5200	37.2	15.7	17	PASS
48	5240	38.0	15.8	17	PASS

802.11n (20MHz): 1TX

CHANNEL	CHANNEL FREQUENCY (MHz)	PEAK POWER OUTPUT (mW)	PEAK POWER OUTPUT (dBm)	PEAK POWER LIMIT (dBm)	PASS/FAIL
36	5180	43.7	16.4	17	PASS
40	5200	43.7	16.4	17	PASS
48	5240	41.7	16.2	17	PASS

802.11n (20MHz): 2TX

CHAN.	CHAN. FREQ. (MHz)	POWER OUTPUT (dBm)		TOTAL POWER (mW)	TOTAL POWER (dBm)	POWER LIMIT (dBm)	PASS / FAIL
		CHAIN 0	CHAIN 1				
36	5180	13.7	13.1	43.9	16.4	17	PASS
40	5200	13.6	13.7	46.4	16.7	17	PASS
48	5240	13.5	13.6	45.3	16.6	17	PASS

802.11n (40MHz): 1TX

CHANNEL	CHANNEL FREQUENCY (MHz)	PEAK POWER OUTPUT (mW)	PEAK POWER OUTPUT (dBm)	PEAK POWER LIMIT (dBm)	PASS/FAIL
38	5190	38.9	15.9	17	PASS
46	5230	47.9	16.8	17	PASS

802.11n (40MHz): 2TX

CHAN.	CHAN. FREQ. (MHz)	POWER OUTPUT (dBm)		TOTAL POWER (mW)	TOTAL POWER (dBm)	POWER LIMIT (dBm)	PASS / FAIL
		CHAIN 0	CHAIN 1				
38	5190	13.7	13.5	45.8	16.6	17	PASS
46	5230	13.6	13.5	45.3	16.6	17	PASS



A D T

26dB OCCUPIED BANDWIDTH: 802.11a: 1TX

CHANNEL	CHANNEL FREQUENCY (MHz)	26dBc OCCUPIED BANDWIDTH (MHz)	PASS / FAIL
36	5180	23.64	PASS
40	5200	23.62	PASS
48	5240	23.61	PASS

CH 36

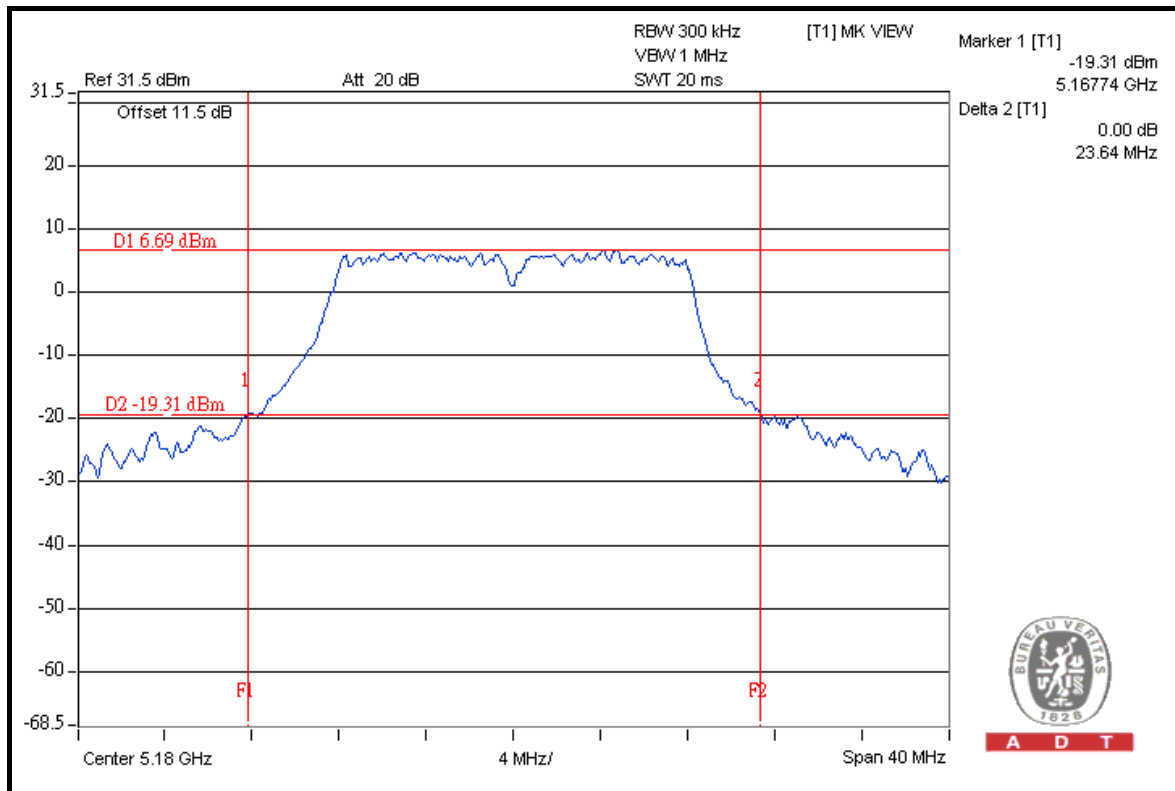



A D T

802.11n (20MHz): 1TX

CHANNEL	CHANNEL FREQUENCY (MHz)	26dBc OCCUPIED BANDWIDTH (MHz)	PASS / FAIL
36	5180	26.78	PASS
40	5200	26.61	PASS
48	5240	30.73	PASS

CH 48

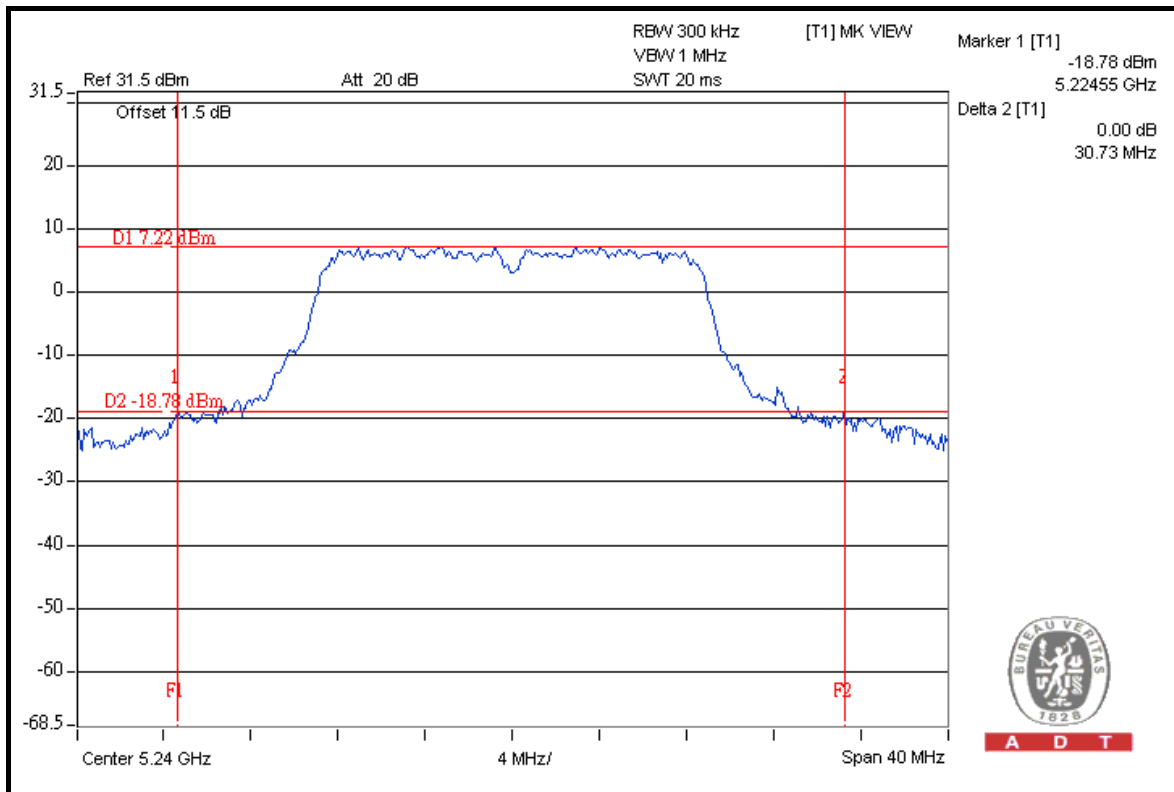



A D T

802.11n (20MHz): 2TX

CHANNEL	CHANNEL FREQUENCY (MHz)	26dBc OCCUPIED BANDWIDTH (MHz)		PASS / FAIL
		CHAIN 0	CHAIN 1	
36	5180	23.57	22.96	PASS
40	5200	23.69	22.65	PASS
48	5240	23.56	22.72	PASS

FOR CHAIN 0: CH 40

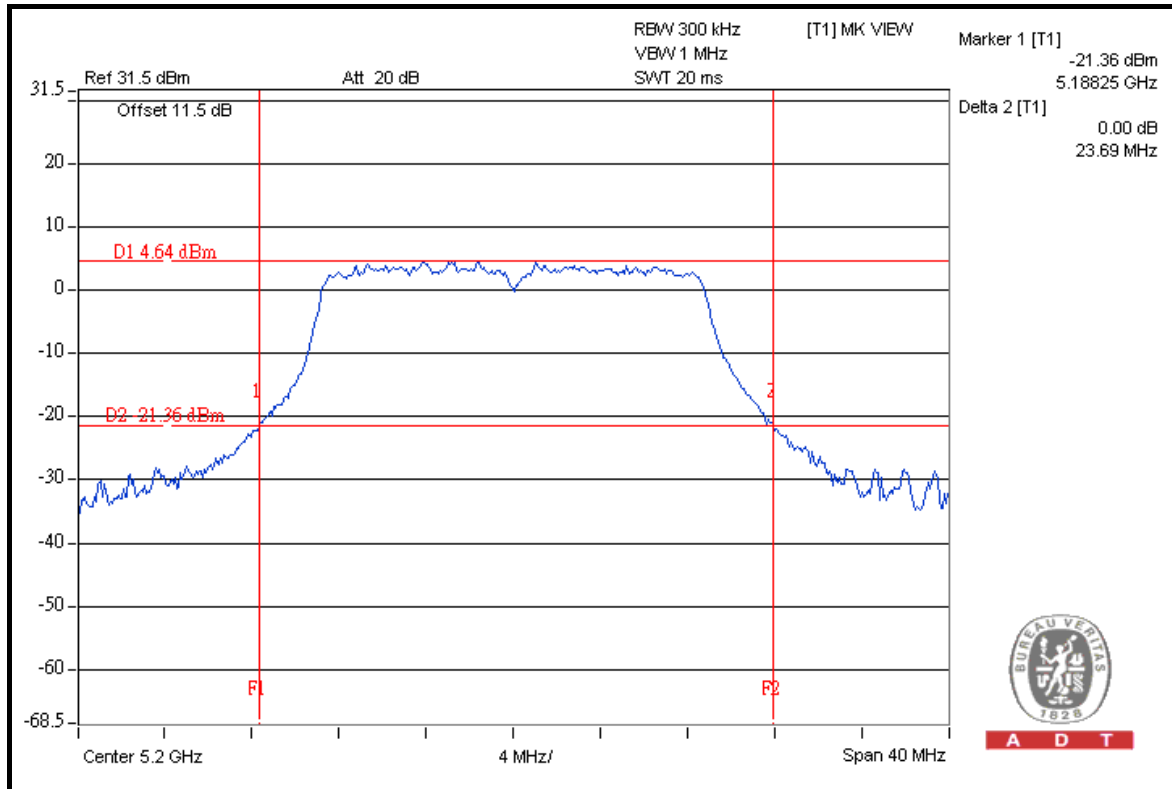



A D T

802.11n (40MHz): 1TX

CHANNEL	CHANNEL FREQUENCY (MHz)	26dBc OCCUPIED BANDWIDTH (MHz)	PASS / FAIL
38	5190	53.44	PASS
46	5230	53.86	PASS

CH 46

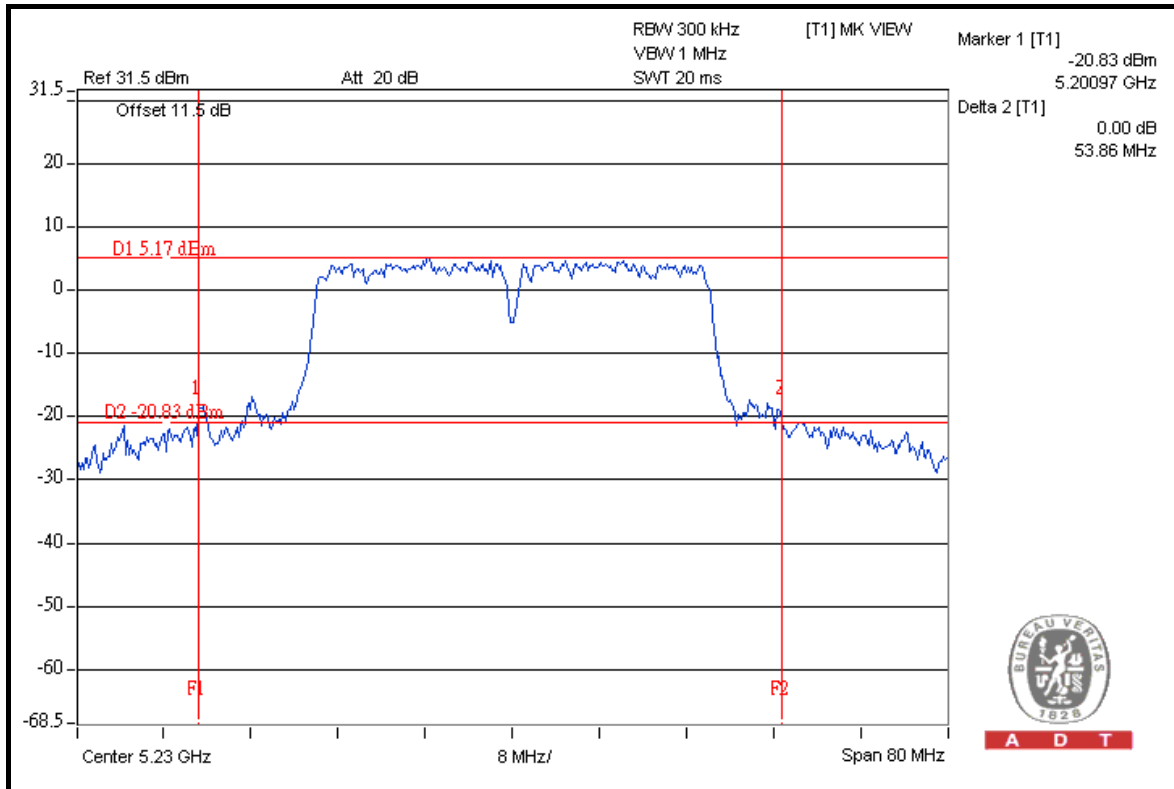



A D T

802.11n (40MHz): 2TX

CHANNEL	CHANNEL FREQUENCY (MHz)	26dBc OCCUPIED BANDWIDTH (MHz)		PASS / FAIL
		CHAIN 0	CHAIN 1	
38	5190	41.16	40.57	PASS
46	5230	40.99	40.49	PASS

FOR CHAIN 0: CH 38

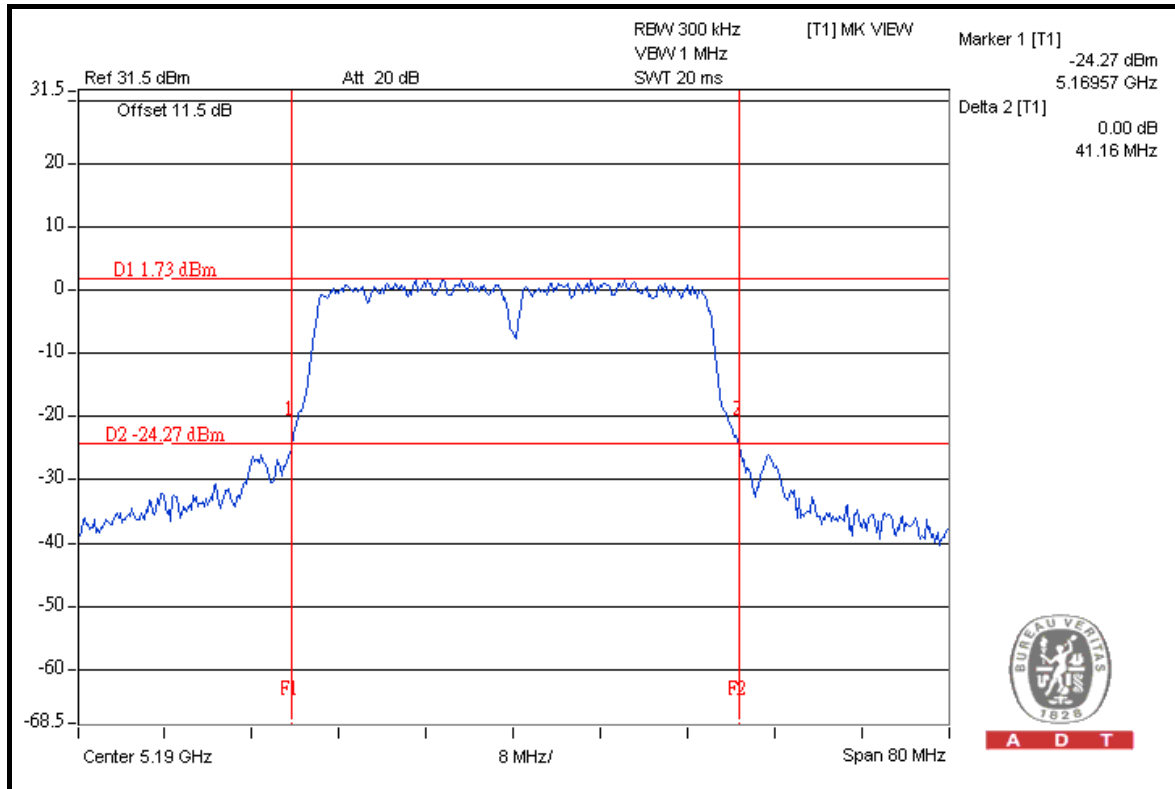

4.4 PEAK POWER EXCURSION MEASUREMENT

4.4.1 LIMITS OF PEAK POWER EXCURSION MEASUREMENT

FREQUENCY BAND	LIMIT
5.15 ~ 5.25GHz	13dB

4.4.2 TEST INSTRUMENTS

DESCRIPTION & MANUFACTURER	MODEL NO.	SERIAL NO.	DATE OF CALIBRATION	DUE DATE OF CALIBRATION
SPECTRUM ANALYZER R&S	FSP40	100039	Jul. 09, 2010	Jul. 08, 2011

NOTE: The calibration interval of the above test instruments is 12 months and the calibrations are traceable to NML/ROC and NIST/USA.

4.4.3 TEST PROCEDURE

- a. The transmitter output was connected to the spectrum analyzer.
- b. Set the spectrum bandwidth span to view the entire spectrum.
- c. Using peak detector and Max-hold function for Trace 1 (RB = 1MHz, VB = 3MHz) and 2 (RB = 1MHz, VB = 300kHz).
- d. The differences between Trace1 and Trace 2 in any 1MHz band at f1 to f2 range were recorded and showed to another trace.

4.4.4 DEVIATION FROM TEST STANDARD

No deviation

4.4.5 TEST SETUP

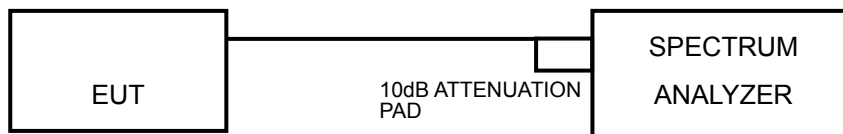

4.4.6 EUT OPERATING CONDITIONS

The software provided by client to enable the EUT under transmission condition continuously at specific channel frequencies individually.



A D T

4.4.7 TEST RESULTS

802.11a: 1TX

CHANNEL	CHANNEL FREQUENCY (MHz)	PEAK POWER EXCURSION (dB)	PEAK to AVERAGE EXCURSION LIMIT (dB)	PASS/FAIL
36	5180	7.74	13	PASS
40	5200	8.00	13	PASS
48	5240	7.53	13	PASS



A D T

CH 48

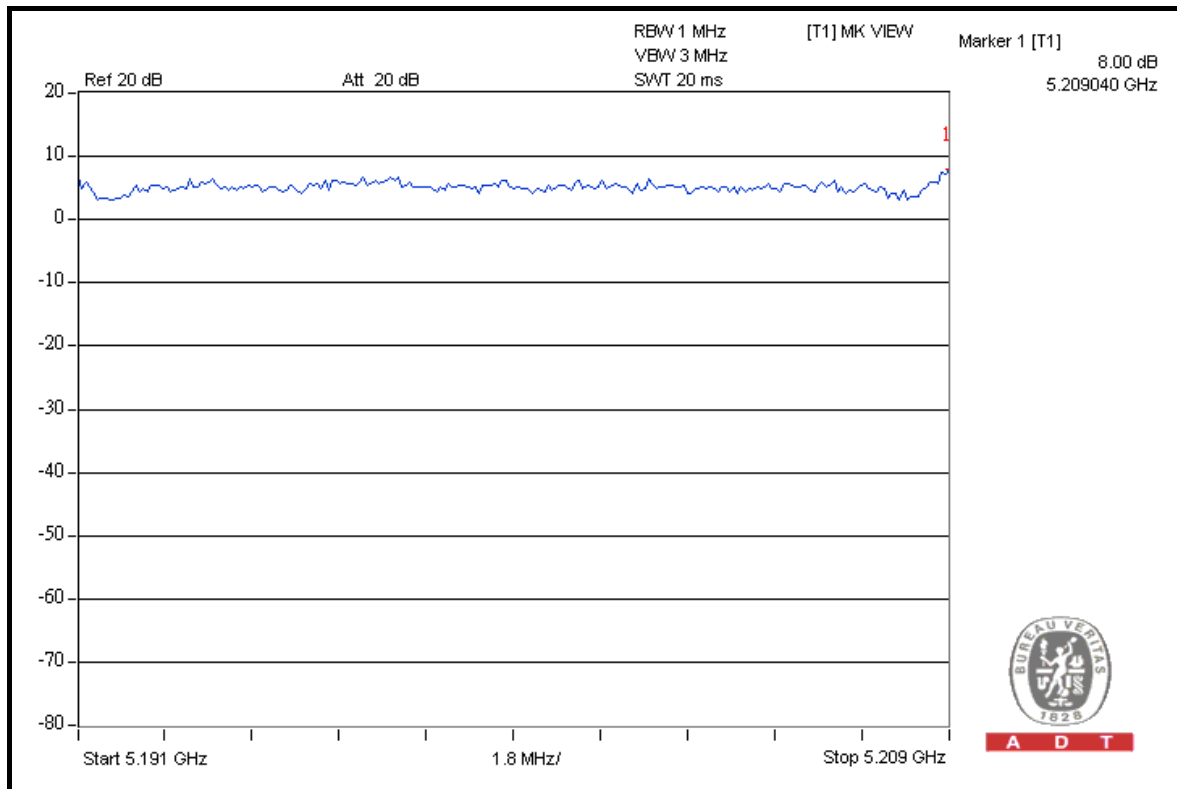
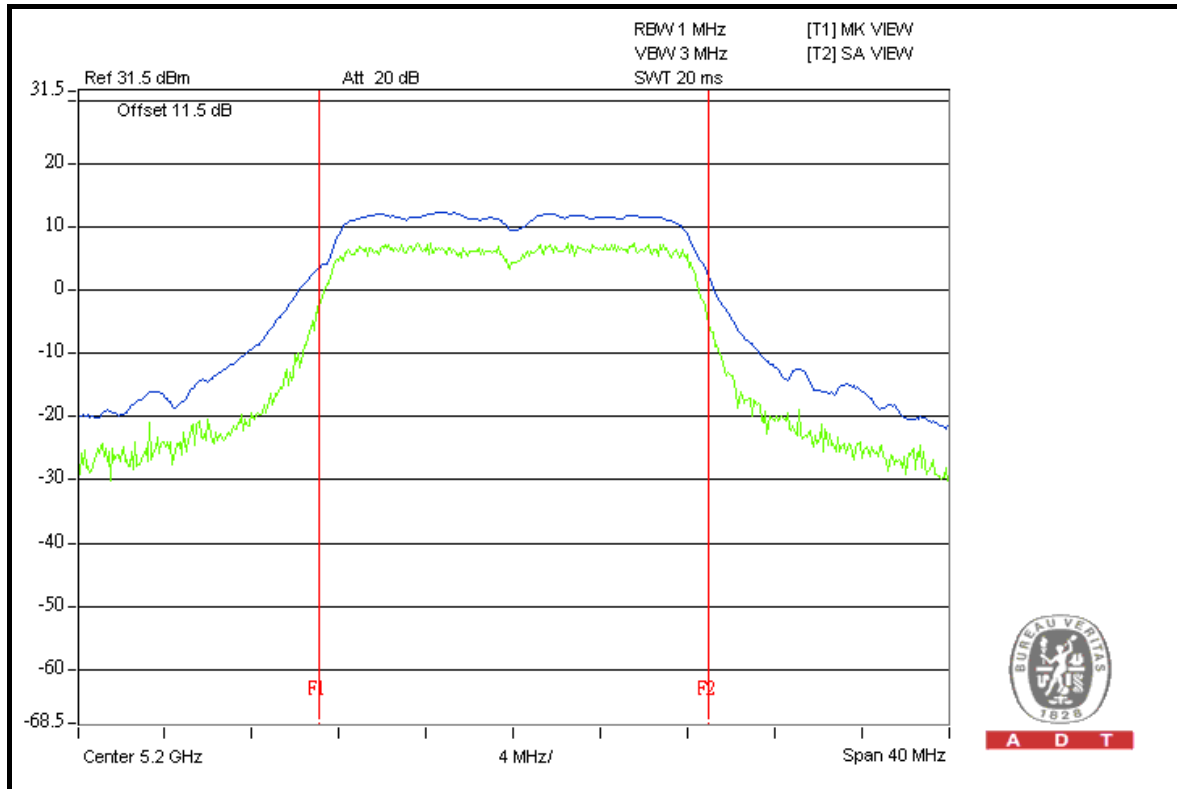



A D T

802.11n (20MHz): 1TX

CHANNEL	CHANNEL FREQUENCY (MHz)	PEAK POWER EXCURSION (dB)	PEAK to AVERAGE EXCURSION LIMIT (dB)	PASS/FAIL
36	5180	6.61	13	PASS
40	5200	6.55	13	PASS
48	5240	6.70	13	PASS



A D T

CH 48

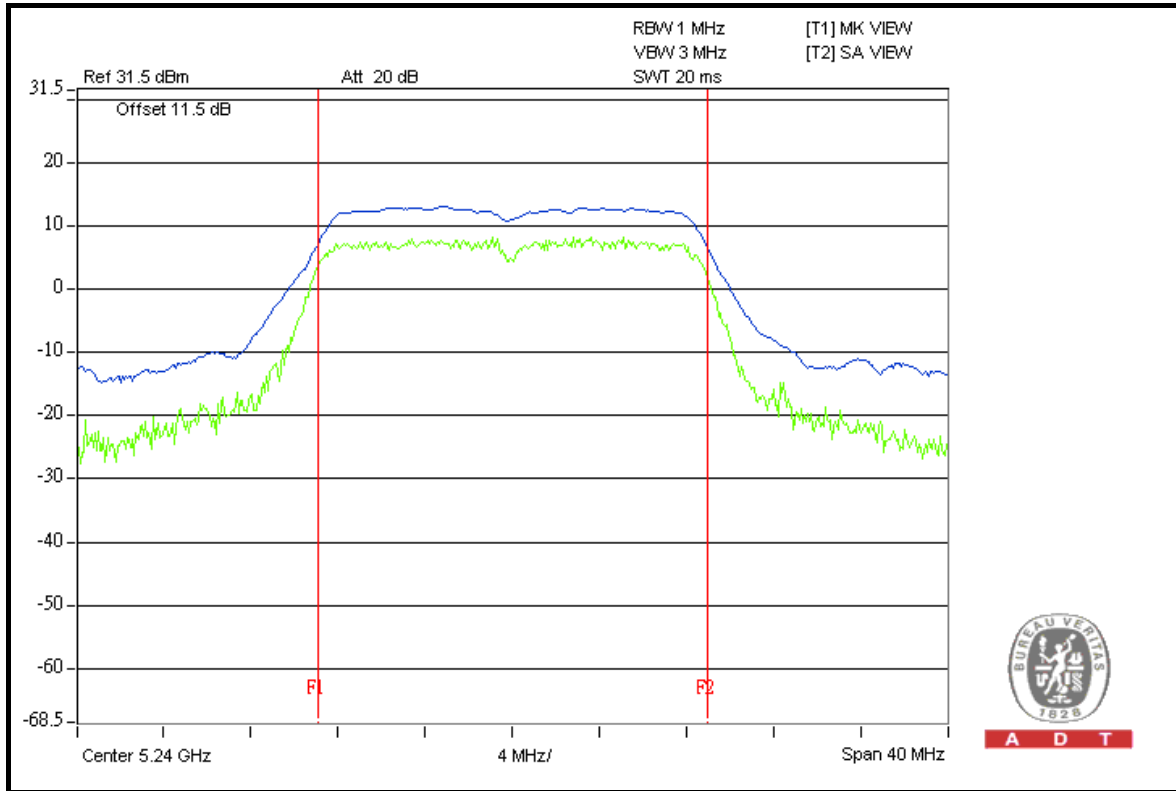

A D T

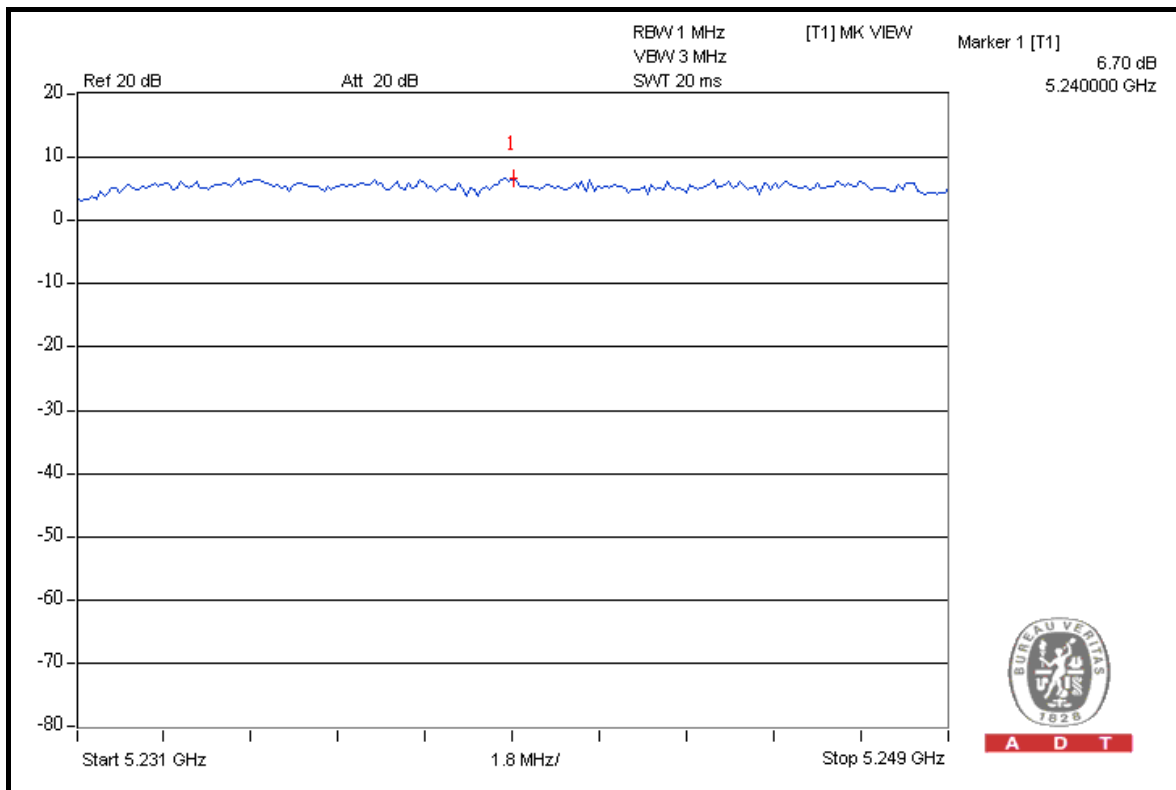

A D T



A D T

802.11n (40MHz): 2TX

CHANNEL	CHANNEL FREQUENCY (MHz)	PEAK POWER EXCURSION (dB)		PEAK to AVERAGE EXCURSION LIMIT (dB)	PASS/FAIL
		CHAIN 0	CHAIN 1		
36	5180	7.30	7.08	13	PASS
40	5200	6.88	7.00	13	PASS
48	5240	7.16	7.16	13	PASS



A D T

FOR CHAIN 0: CH 36

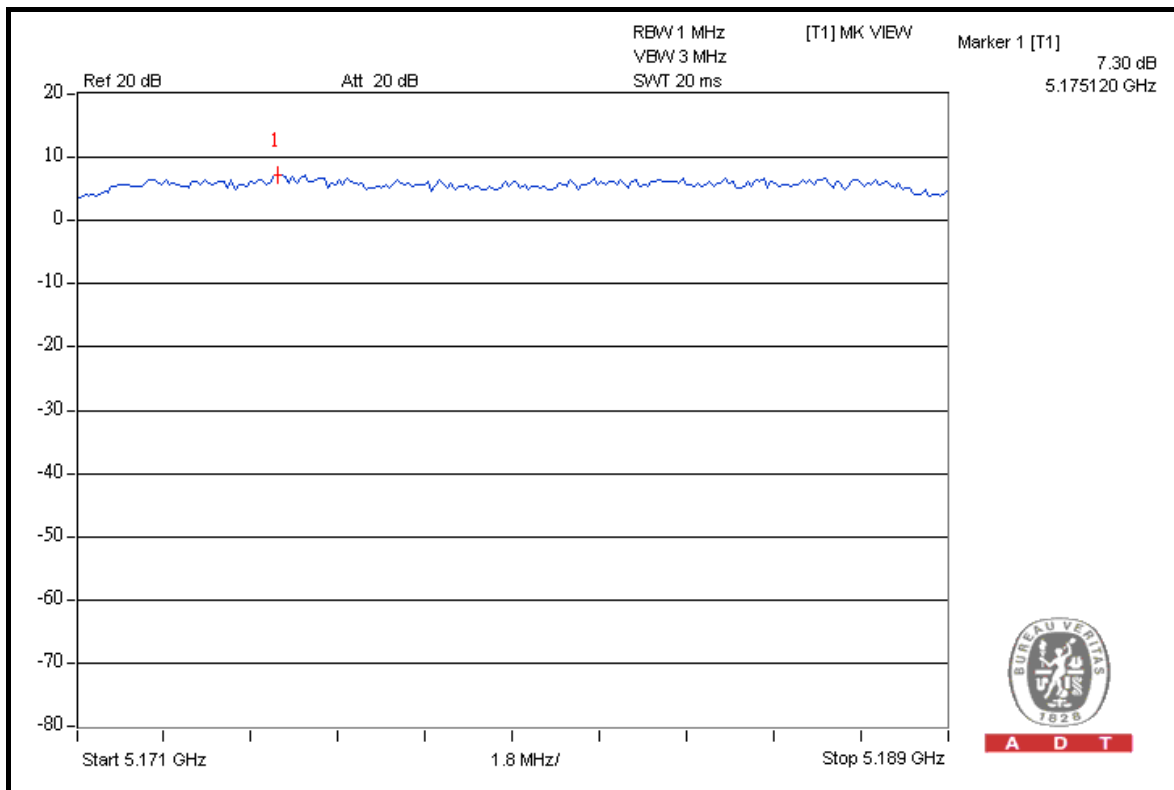
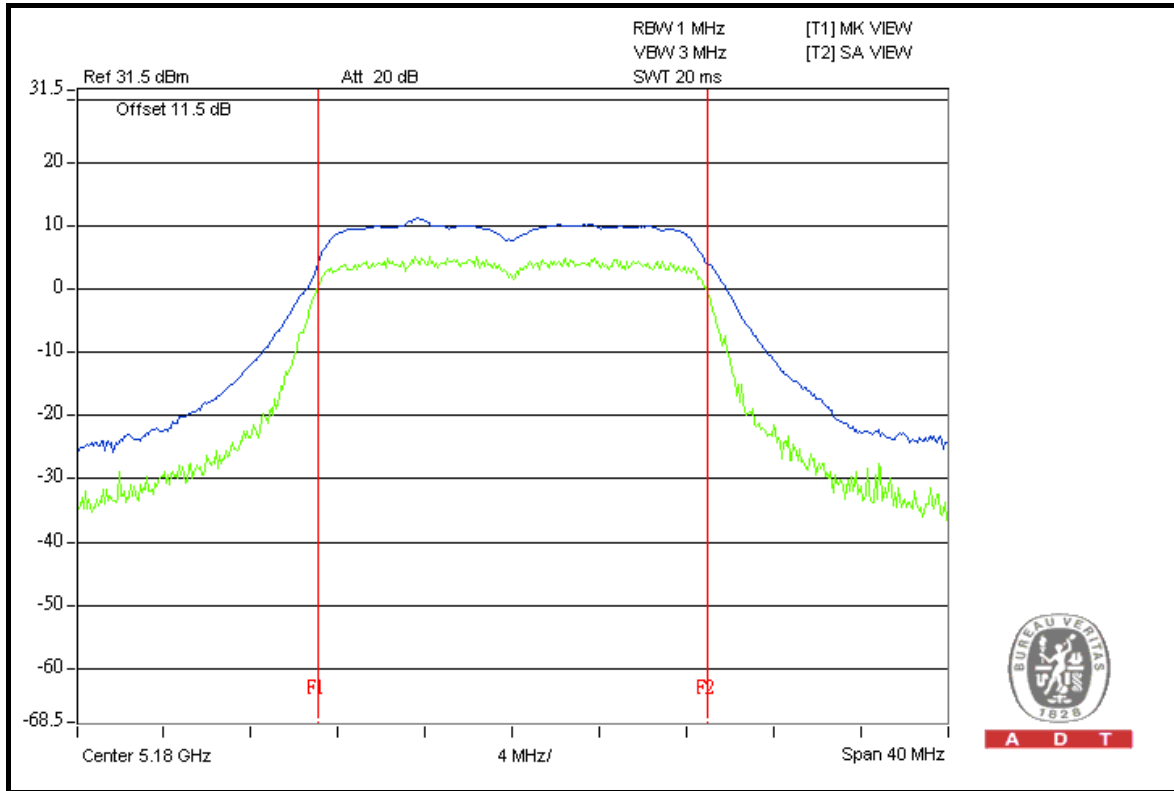



A D T

802.11n (20MHz): 1TX

CHANNEL	CHANNEL FREQUENCY (MHz)	PEAK POWER EXCURSION (dB)	PEAK to AVERAGE EXCURSION LIMIT (dB)	PASS/FAIL
38	5190	7.57	13	PASS
46	5230	7.63	13	PASS



A D T

CH 46

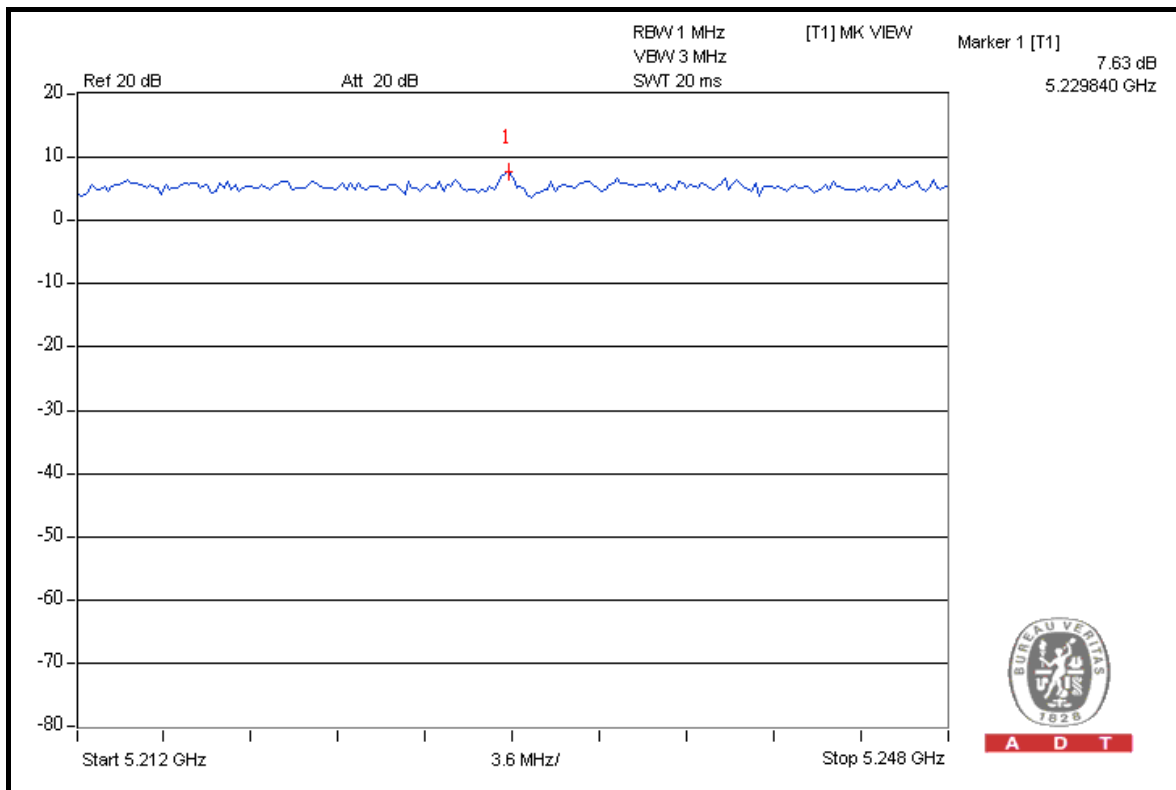
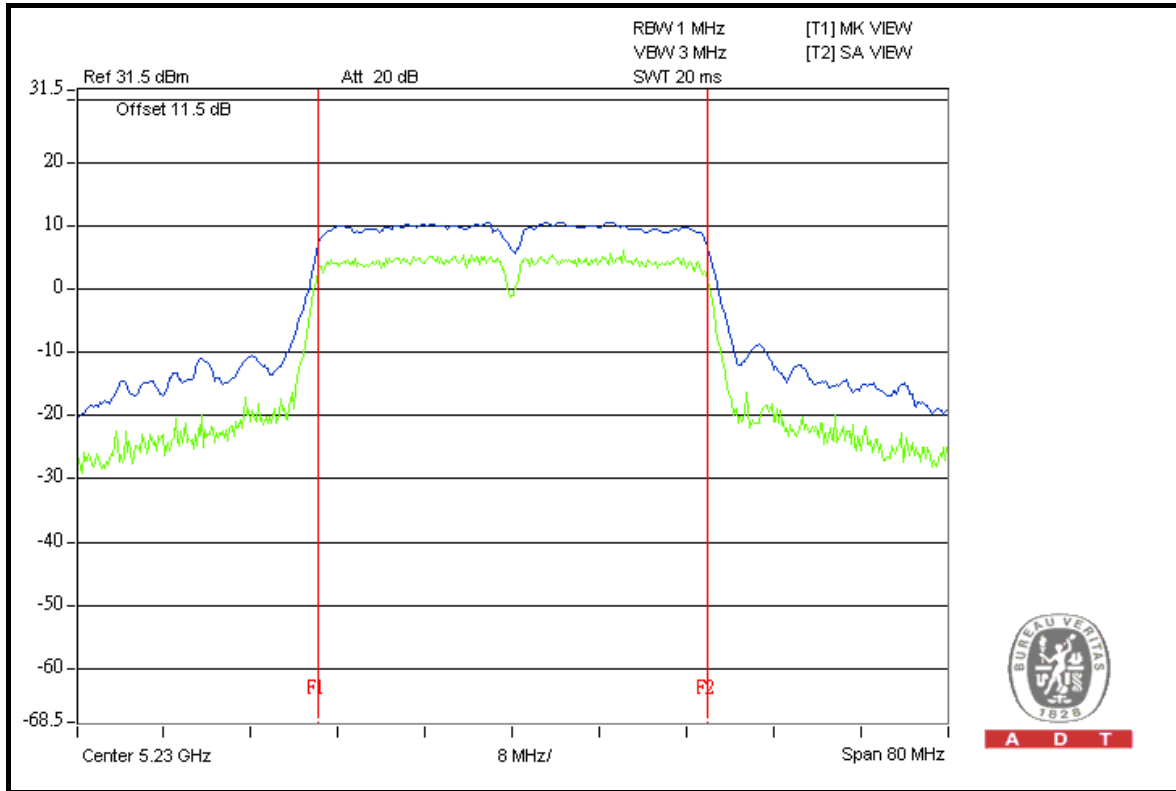



A D T

802.11n (40MHz): 2TX

CHANNEL	CHANNEL FREQUENCY (MHz)	PEAK POWER EXCURSION (dB)		PEAK to AVERAGE EXCURSION LIMIT (dB)	PASS/FAIL
		CHAIN 0	CHAIN 1		
38	5190	7.29	8.43	13	PASS
46	5230	7.46	8.22	13	PASS



A D T

FOR CHAIN 1: CH 38

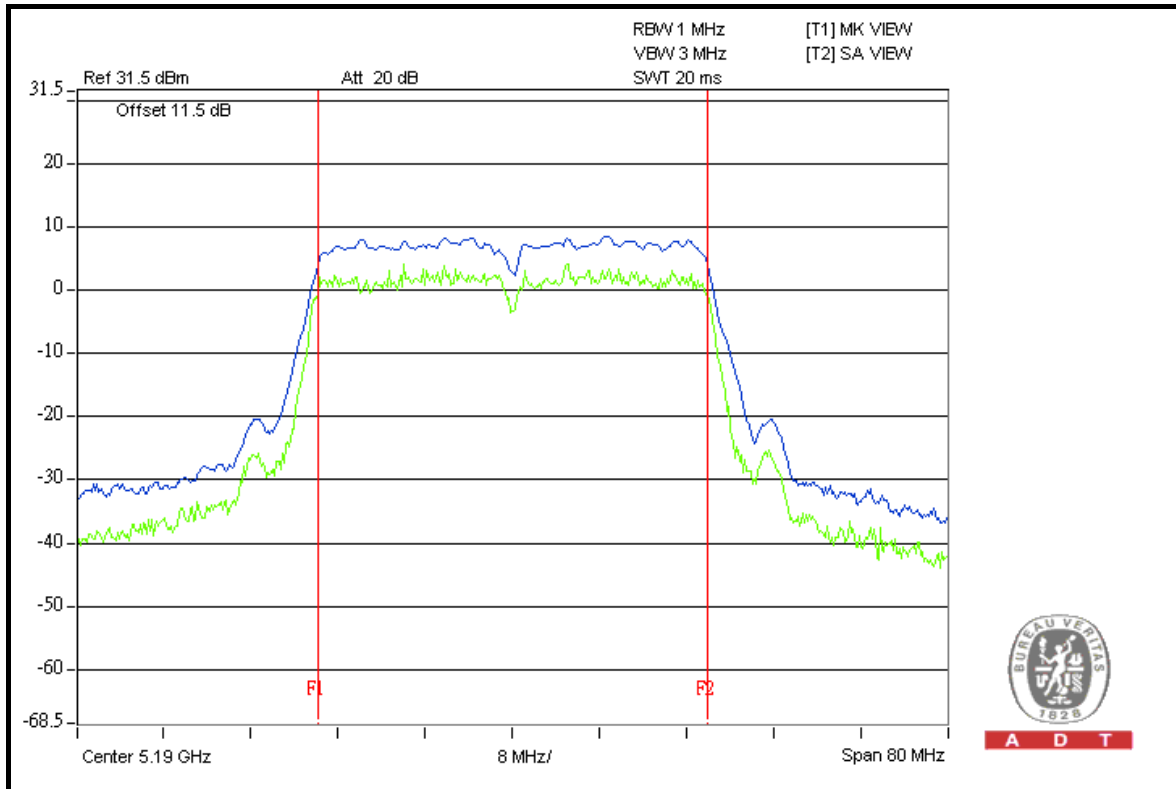

A D T

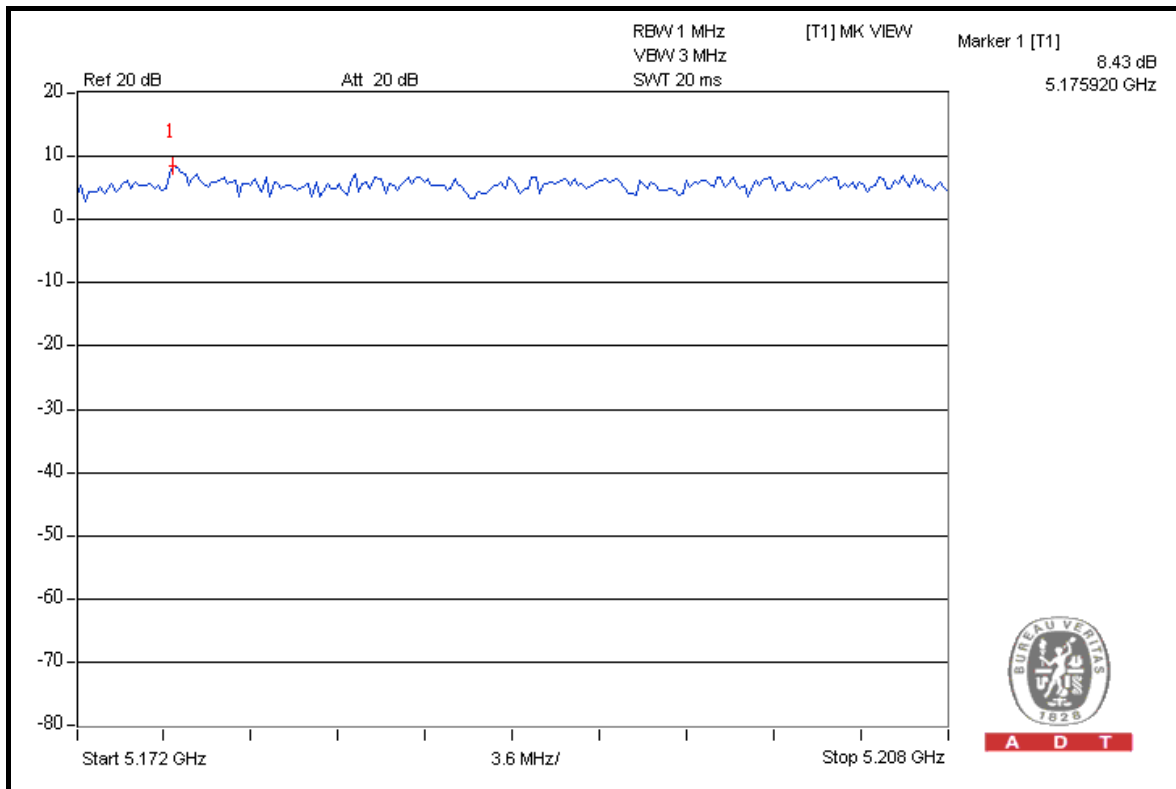

A D T



A D T

4.5 PEAK POWER SPECTRAL DENSITY MEASUREMENT

4.5.1 LIMITS OF PEAK POWER SPECTRAL DENSITY MEASUREMENT

FREQUENCY BAND	LIMIT
5.15 ~ 5.25GHz	4dBm

4.5.2 TEST INSTRUMENTS

DESCRIPTION & MANUFACTURER	MODEL NO.	SERIAL NO.	DATE OF CALIBRATION	DUE DATE OF CALIBRATION
SPECTRUM ANALYZER R&S	FSP40	100039	Jul. 09, 2010	Jul. 08, 2011

NOTE: The calibration interval of the above test instruments is 12 months and the calibrations are traceable to NML/ROC and NIST/USA.

4.5.3 TEST PROCEDURES

- a. The transmitter output was connected to the spectrum analyzer.
- b. Set RBW = 1MHz, VBW = 3MHz. The PPSD is the highest level found across the emission in any 1MHz band.

4.5.4 DEVIATION FROM TEST STANDARD

No deviation

4.5.5 TEST SETUP

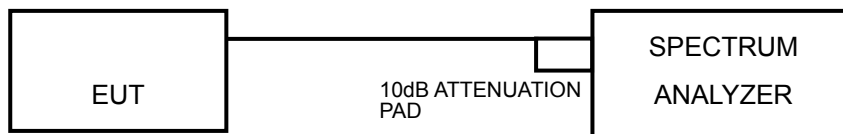

4.5.6 EUT OPERATING CONDITIONS

Same as 5.3.6



A D T

4.5.7 TEST RESULTS

802.11a: 1TX

CHANNEL	CHANNEL FREQUENCY (MHz)	RF POWER LEVEL IN 1kHz BW (dBm)	MAXIMUM LIMIT (dBm)	PASS/FAIL
36	5180	3.9	4	PASS
40	5200	3.6	4	PASS
48	5240	3.8	4	PASS

CH 36

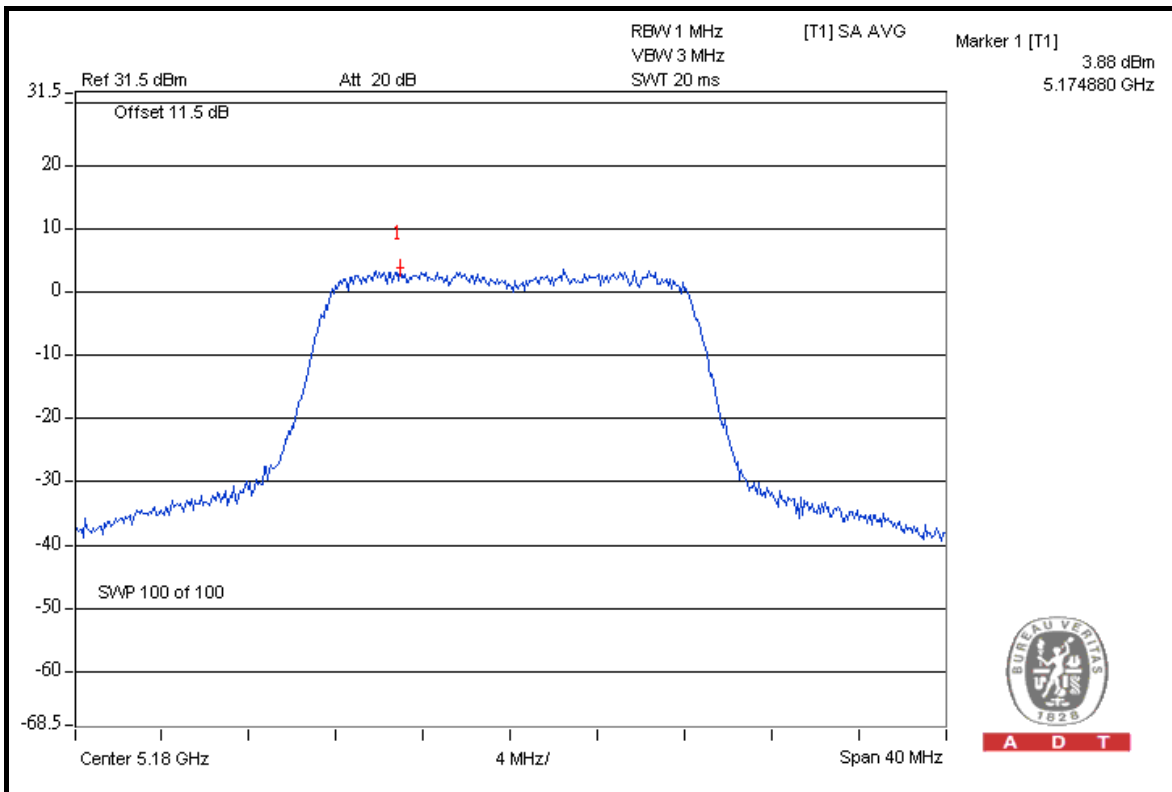



A D T

802.11n (20MHz): 1TX

CHANNEL	CHANNEL FREQUENCY (MHz)	RF POWER LEVEL IN 1kHz BW (dBm)	MAXIMUM LIMIT (dBm)	PASS/FAIL
36	5180	3.9	4	PASS
40	5200	3.7	4	PASS
48	5240	3.7	4	PASS

CH 36

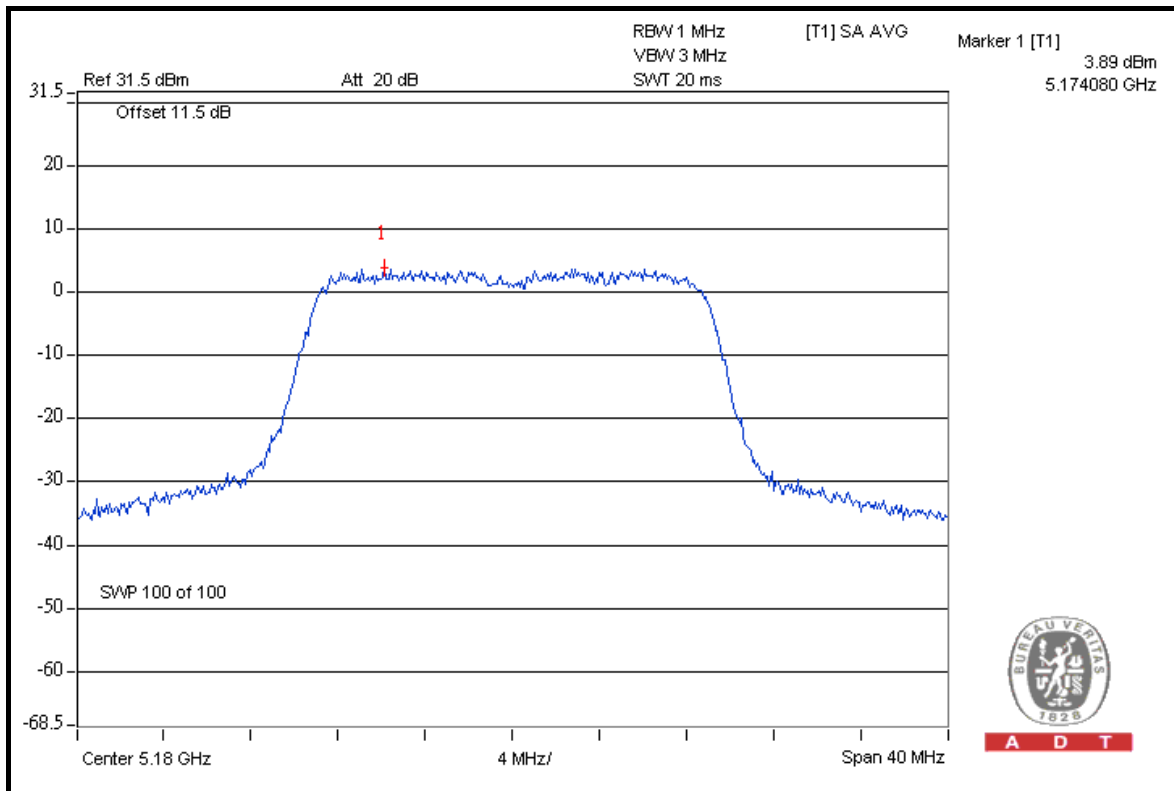

A D T



A D T

802.11n (20MHz): 2TX

CHAN.	CHAN. FREQ. (MHz)	RF POWER LEVEL IN 1kHz BW (dBm)		TOTAL POWER DENSITY (dBm)	MAX. LIMIT (dBm)	PASS / FAIL
		CHAIN 0	CHAIN 1			
36	5180	0.9	0.7	3.8	4	PASS
40	5200	0.8	0.9	3.9	4	PASS
48	5240	0.7	0.8	3.8	4	PASS

FOR CHAIN 0: CH 36

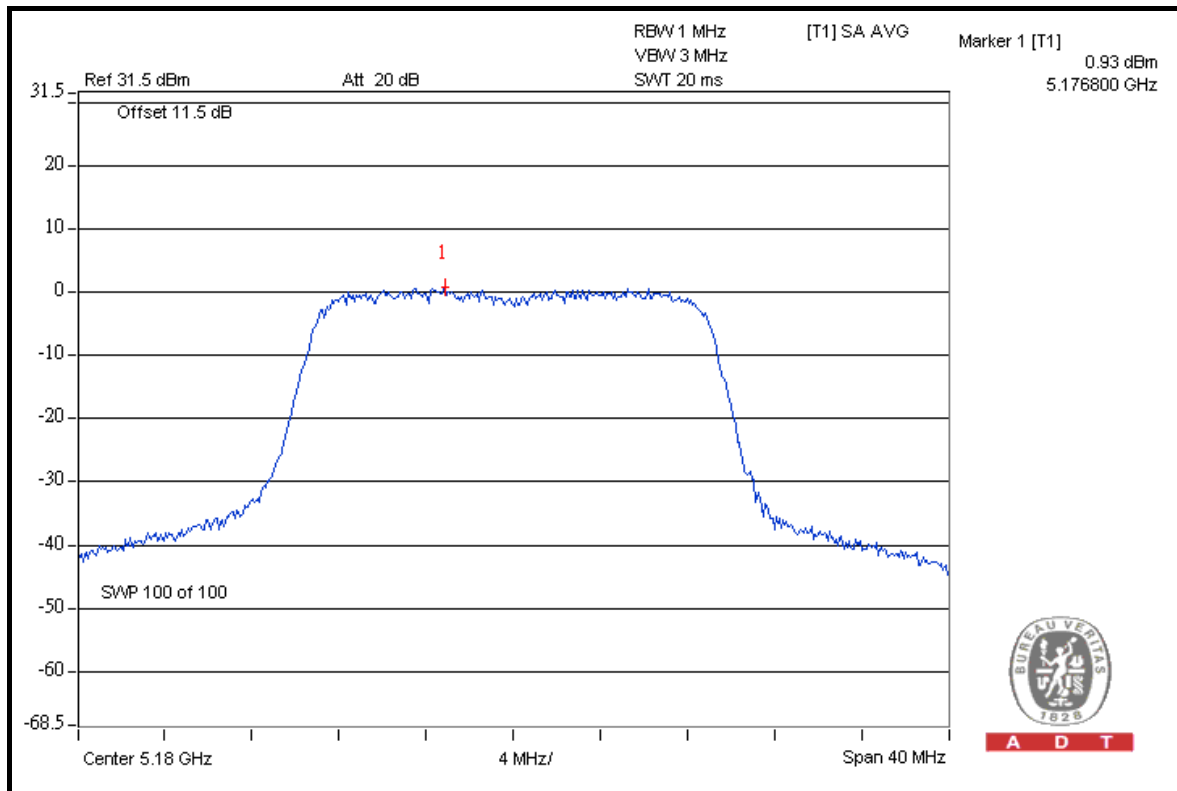

A D T



A D T

802.11n (40MHz): 1TX

CHANNEL	CHANNEL FREQUENCY (MHz)	RF POWER LEVEL IN 1kHz BW (dBm)	MAXIMUM LIMIT (dBm)	PASS/FAIL
38	5190	-0.4	4	PASS
46	5230	0.6	4	PASS

CH 46

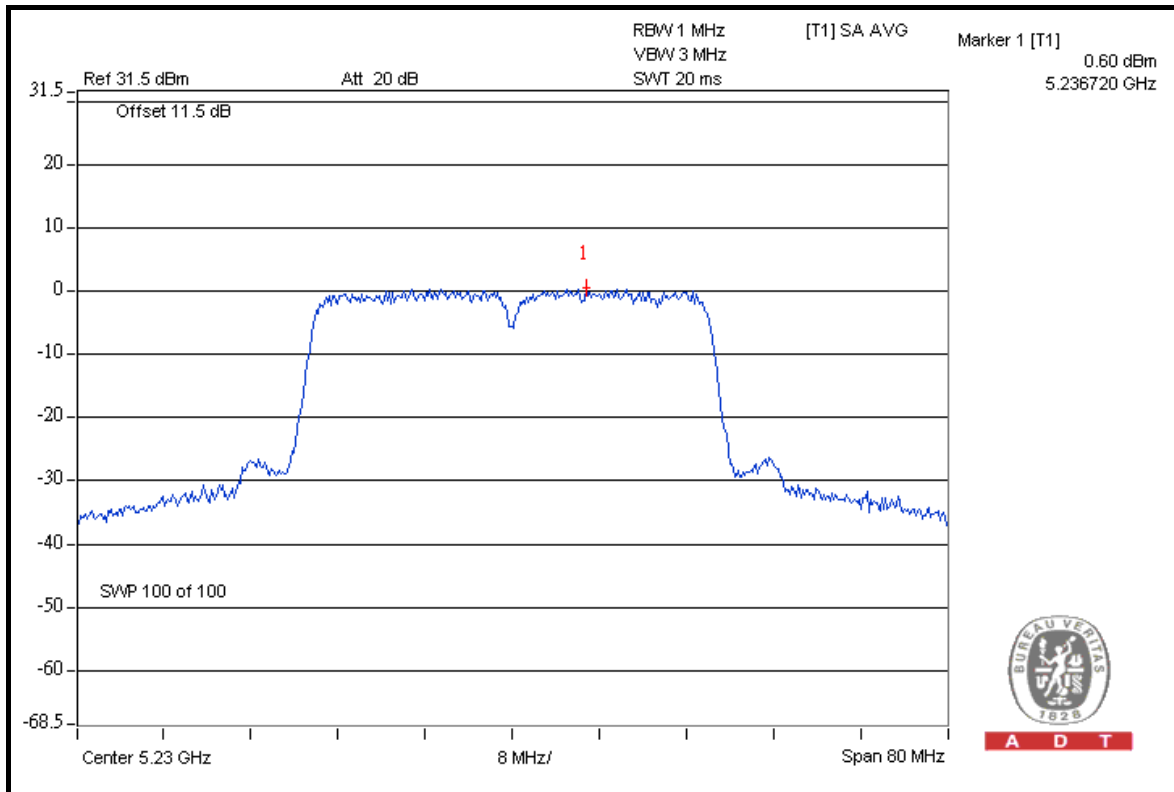

A D T



A D T

802.11n (40MHz): 2TX

CHAN.	CHAN. FREQ. (MHz)	RF POWER LEVEL IN 3kHz BW (dBm)		TOTAL POWER DENSITY (dBm)	MAX. LIMIT (dBm)	PASS / FAIL
		CHAIN 0	CHAIN 1			
38	5190	-2.8	-2.8	0.2	4	PASS
46	5230	-2.8	-2.9	0.2	4	PASS

FOR CHAIN 0: CH 46

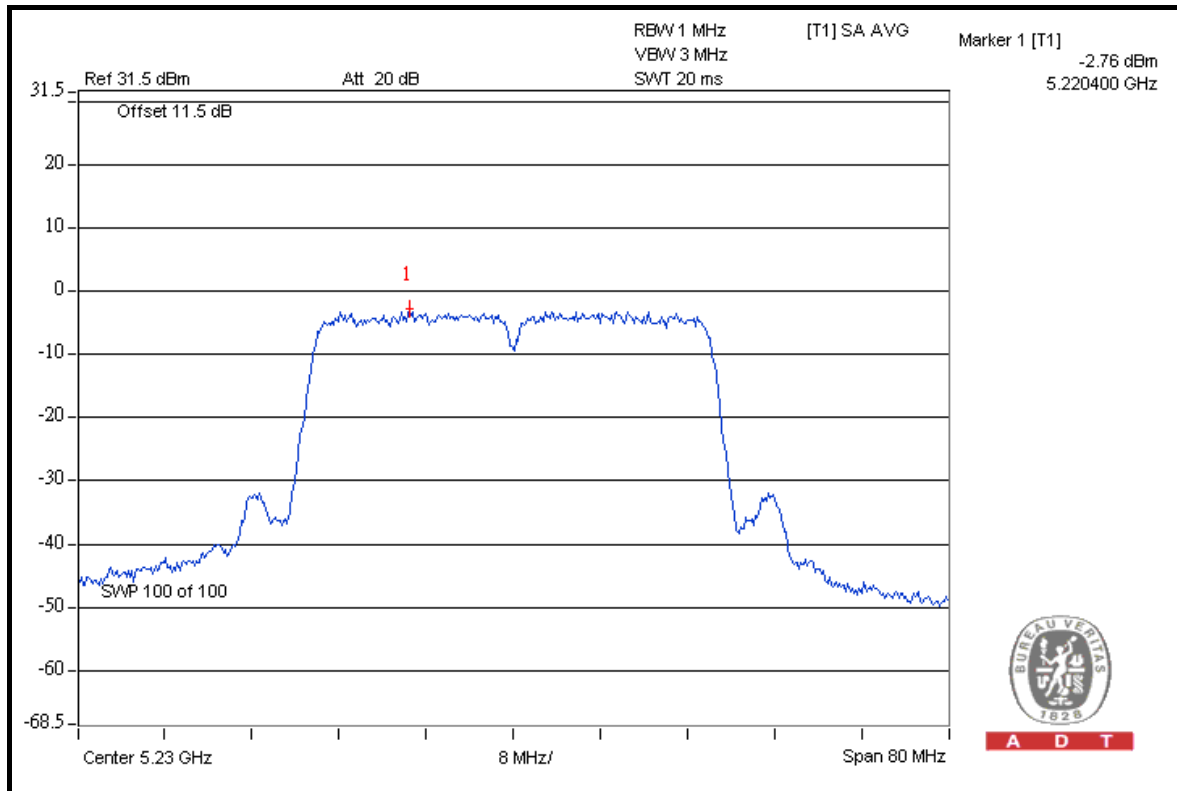



4.6 FREQUENCY STABILITY

4.6.1 LIMITS OF FREQUENCY STABILITY MEASUREMENT

The frequency tolerance of the carrier signal shall be maintained within +/- 0.02% of the operating frequency over a temperature variation of -30 degrees to 50 degrees C at normal supply voltage, and for a variation in the primary supply voltage from 85% to 115% of the rated supply voltage at a temperature of 20 degrees C.

4.6.2 TEST INSTRUMENTS

DESCRIPTION & MANUFACTURER	MODEL NO.	SERIAL NO.	DATE OF CALIBRATION	DUE DATE OF CALIBRATION
R&S SPECTRUM ANALYZER	FSP40	100039	Jul. 09, 2010	Jul. 08, 2011
WIT STANDARD TEMPERATURE AND HUMIDITY CHAMBER	TH-4S-C	W981030	Jun. 28, 2010	Jun. 27, 2011

NOTE: The calibration interval of the above test instruments is 12 months and the calibrations are traceable to NML/ROC and NIST/USA.

4.6.3 TEST PROCEDURE

- a. The EUT was placed inside the environmental test chamber and powered by nominal DC voltage.
- b. Turn the EUT on and couple its output to a spectrum analyzer.
- c. Turn the EUT off and set the chamber to the highest temperature specified.
- d. Allow sufficient time (approximately 30 min) for the temperature of the chamber to stabilize, turn the EUT on and measure the operating frequency after 2, 5, and 10 minutes.
- e. Repeat step 2 and 3 with the temperature chamber set to the lowest temperature.
- f. The test chamber was allowed to stabilize at +20 degree C for a minimum of 30 minutes. The supply voltage was then adjusted on the EUT from 85% to 115% and the frequency record.

4.6.4 DEVIATION FROM TEST STANDARD

No deviation

4.6.5 TEST SETUP

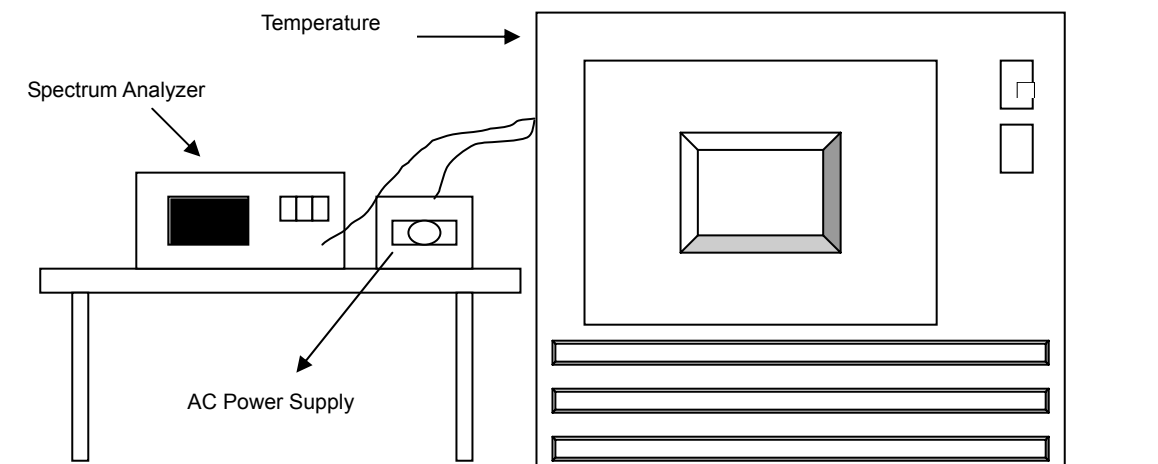

4.6.6 EUT OPERATING CONDITION

Same as Item 4.1.6



A D T

4.6.7 TEST RESULTS

FREQUENCY STABILITY VERSUS TEMP.									
OPERATING FREQUENCY: 5200MHz									
TEMP. (°C)	POWER SUPPLY (Vdc)	0 MINUTE		2 MINUTE		5 MINUTE		10 MINUTE	
		Measured Frequency	Frequency Drift	Measured Frequency	Frequency Drift	Measured Frequency	Frequency Drift	Measured Frequency	Frequency Drift
		(MHz)	ppm	(MHz)	ppm	(MHz)	ppm	(MHz)	ppm
50	110.0	5199.980300	-3.788	5199.980515	-3.747	5199.980507	-3.749	5199.980314	-3.786
40	110.0	5199.988000	-2.308	5199.987808	-2.345	5199.988293	-2.251	5199.988218	-2.266
30	110.0	5199.993900	-1.173	5199.994112	-1.132	5199.993934	-1.167	5199.993944	-1.165
20	110.0	5199.982000	-3.462	5199.981828	-3.495	5199.982361	-3.392	5199.982014	-3.459
10	110.0	5199.980900	-3.673	5199.980958	-3.662	5199.980869	-3.679	5199.981333	-3.590
0	110.0	5199.980700	-3.712	5199.980469	-3.756	5199.980597	-3.731	5199.980696	-3.712
-10	110.0	5199.985600	-2.769	5199.985617	-2.766	5199.985563	-2.776	5199.985565	-2.776
-20	110.0	5200.003700	0.712	5200.003617	0.696	5200.003787	0.728	5200.003601	0.693
-30	110.0	5200.011200	2.154	5200.011432	2.198	5200.011471	2.206	5200.011428	2.198

FREQUENCY STABILITY VERSUS VOLTAGE									
OPERATING FREQUENCY: 5200MHz									
TEMP. (°C)	POWER SUPPLY (Vac)	0 MINUTE		2 MINUTE		5 MINUTE		10 MINUTE	
		Measured Frequency	Frequency Drift	Measured Frequency	Frequency Drift	Measured Frequency	Frequency Drift	Measured Frequency	Frequency Drift
		(MHz)	ppm	(MHz)	ppm	(MHz)	ppm	(MHz)	ppm
20	93.5	5199.994461	-1.065	5199.993977	-1.158	5199.994144	-1.126	5199.993886	-1.176
	110.0	5199.982000	-3.462	5199.981828	-3.495	5199.982361	-3.392	5199.982014	-3.459
	126.5	5199.980694	-3.713	5199.981138	-3.627	5199.981303	-3.596	5199.980972	-3.659



A D T

4.7 BAND EDGES MEASUREMENT

4.7.1 TEST INSTRUMENTS

DESCRIPTION & MANUFACTURER	MODEL NO.	SERIAL NO.	DATE OF CALIBRATION	DUE DATE OF CALIBRATION
FOR CONDUCTED MEASUREMENT				
SPECTRUM ANALYZER R&S	FSP40	100039	Jul. 09, 2010	Jul. 08, 2011
FOR RADIATED MEASUREMENT				
Test Receiver ROHDE & SCHWARZ	ESCI	100424	Aug. 04, 2010	Aug. 03, 2011
Spectrum Analyzer ROHDE & SCHWARZ	FSP40	100041	Jul. 09, 2010	Jul. 08, 2011
BILOG Antenna SCHWARZBECK	VULB9168	9168-156	Apr. 30, 2010	Apr. 29, 2011
HORN Antenna SCHWARZBECK	BBHA 9120 D	9120D-209	Aug. 02, 2010	Aug. 01, 2011
HORN Antenna SCHWARZBECK	BBHA 9170	BBHA9170243	Dec. 27, 2010	Dec. 26, 2011
Preamplifier Agilent	8449B	3008A01910	Sep. 09, 2010	Sep. 08, 2011
Preamplifier Agilent	8447D	2944A10638	Nov. 03, 2010	Nov. 02, 2011
RF signal cable HUBER+SUHNNER	SUCOFLEX 104	218190/4 231241/4	May 14, 2010	May 13, 2011
RF signal cable Worken	8D-FB	Cable-HYCH9-01	Aug. 20, 2010	Aug. 19, 2011
Software	ADT_Radiated_V7.6.15.9.2	NA	NA	NA
Antenna Tower EMCO	2070/2080	512.835.4684	NA	NA
Turn Table EMCO	2087-2.03	NA	NA	NA
Antenna Tower & Turn Table Controller EMCO	2090	NA	NA	NA
26GHz ~ 40GHz Amplifier	EM26400	07026401	Aug. 25, 2010	Aug. 24, 2011

NOTE: The calibration interval of the above test instruments is 12 months and the calibrations are traceable to NML/ROC and NIST/USA.



A D T

4.7.2 TEST PROCEDURE

- a. The EUT was placed on the top of a rotating table 0.8 meters above the ground at a 3 meter semi-anechoic chamber. The table was rotated 360 degrees to determine the position of the highest radiation.
- b. The EUT was set 3 meters away from the interference-receiving antenna, which was mounted on the top of a variable-height antenna tower.
- c. The antenna is a broadband antenna, and its height is varied from one meter to four meters above the ground to determine the maximum value of the field strength. Both horizontal and vertical polarizations of the antenna are set to make the measurement.
- d. For each suspected emission, the EUT was arranged to its worst case and then the antenna was tuned to heights from 1 meter to 4 meters and the rotatable table was turned from 0 degrees to 360 degrees to find the maximum reading.
- e. Set both RBW and VBW of spectrum analyzer to 1MHz and 3MHz with suitable frequency span including 100MHz bandwidth from band edge. The band edges was measured and recorded.

NOTE: The resolution bandwidth of test receiver/spectrum analyzer is 1MHz and the video bandwidth is 10Hz for Average detection (AV) at frequency above 1GHz

4.7.3 EUT OPERATING CONDITION

The software provided by client to enable the EUT under transmission condition continuously at specific channel frequencies individually.



4.7.4 TEST RESULTS

For signals in the restricted bands above and below the 5.15 to 5.25GHz allocated band a measurement was made of the amplitude of the spurious emissions with respect to the intentional signals. The relative amplitude, in dBc, was applied to the average and peak field strength of the intentional signal made on the OATS to calculate the field strength of the unintentional signals.

The spectrum plots (Peak RBW = 1MHz, VBW = 3MHz) are attached on the following pages.

802.11a: 1TX

RESTRICT BAND (4500 ~ 5150 MHz)

FREQUENCY (MHz)	FUNDAMENTAL EMISSION (dBuV/m)	DELTA (dB)	MAXIMUM FIELD STRENGTH IN RESTRICT BAND (dBuV/m)	LIMIT (dBuV/m)
5180.00 (PK)	105.5	41.94	63.56	74.00
5180.00 (AV)	95.6	49.38	46.22	54.00

RESTRICT BAND (5350 ~ 5460 MHz)

FREQUENCY (MHz)	FUNDAMENTAL EMISSION (dBuV/m)	DELTA (dB)	MAXIMUM FIELD STRENGTH IN RESTRICT BAND (dBuV/m)	LIMIT (dBuV/m)
5240.00 (PK)	106.1	49.70	56.40	74.00
5240.00 (AV)	96.2	50.70	45.50	54.00

NOTE:

1. Delta = Amplitude between the peak of the fundamental and the peak of the band edge emission. Please check following 3 pages.
2. Maximum field strength in restrict band = Fundamental emission – Delta.



A D T

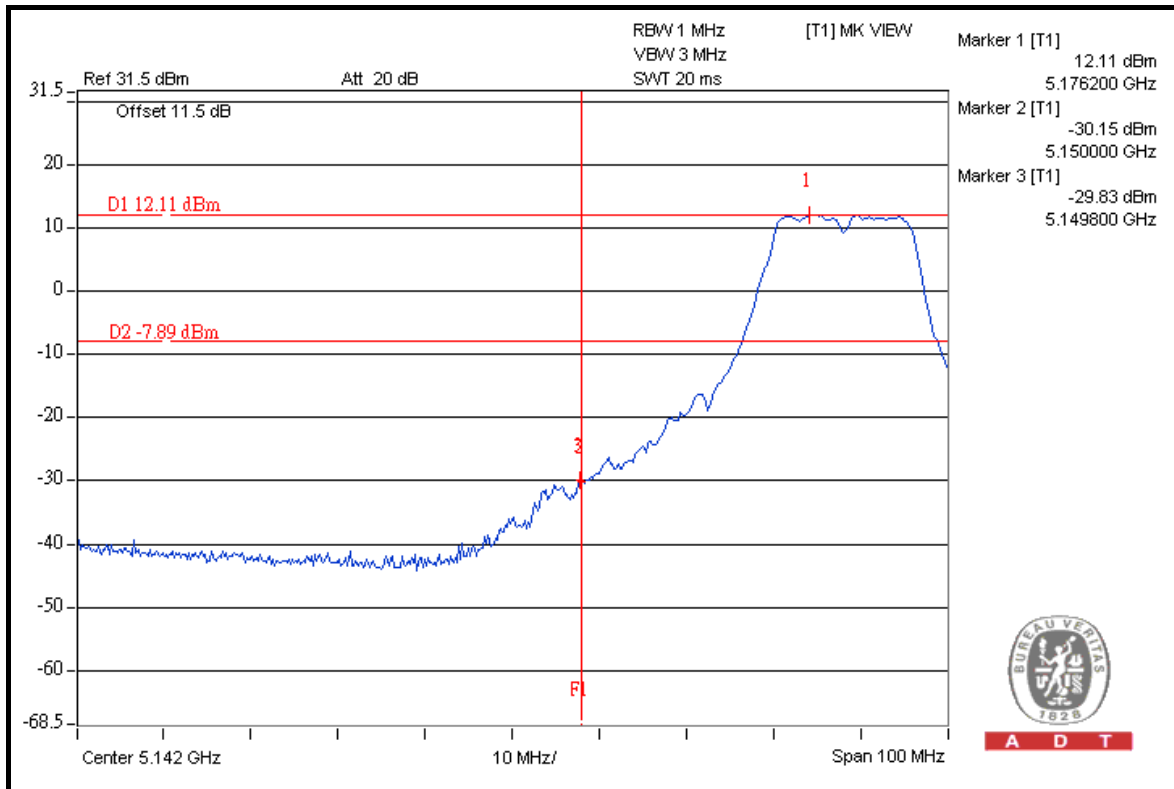

A D T

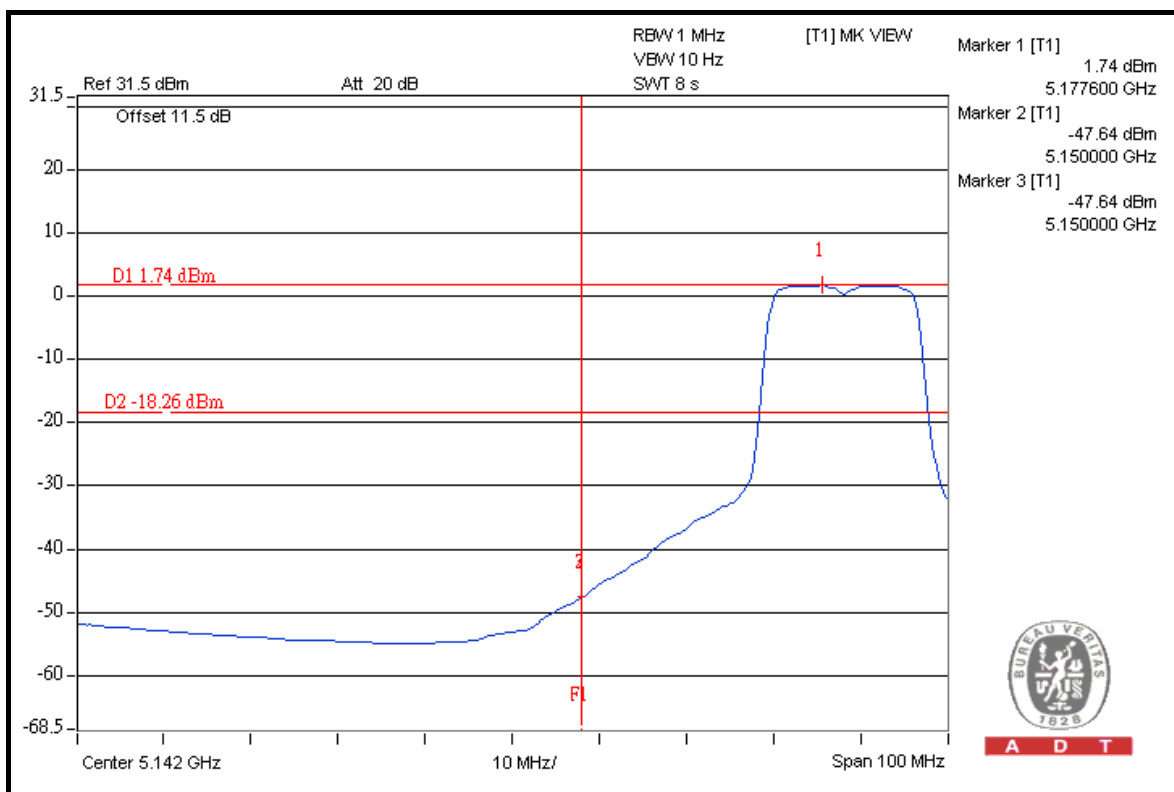

A D T



A D T

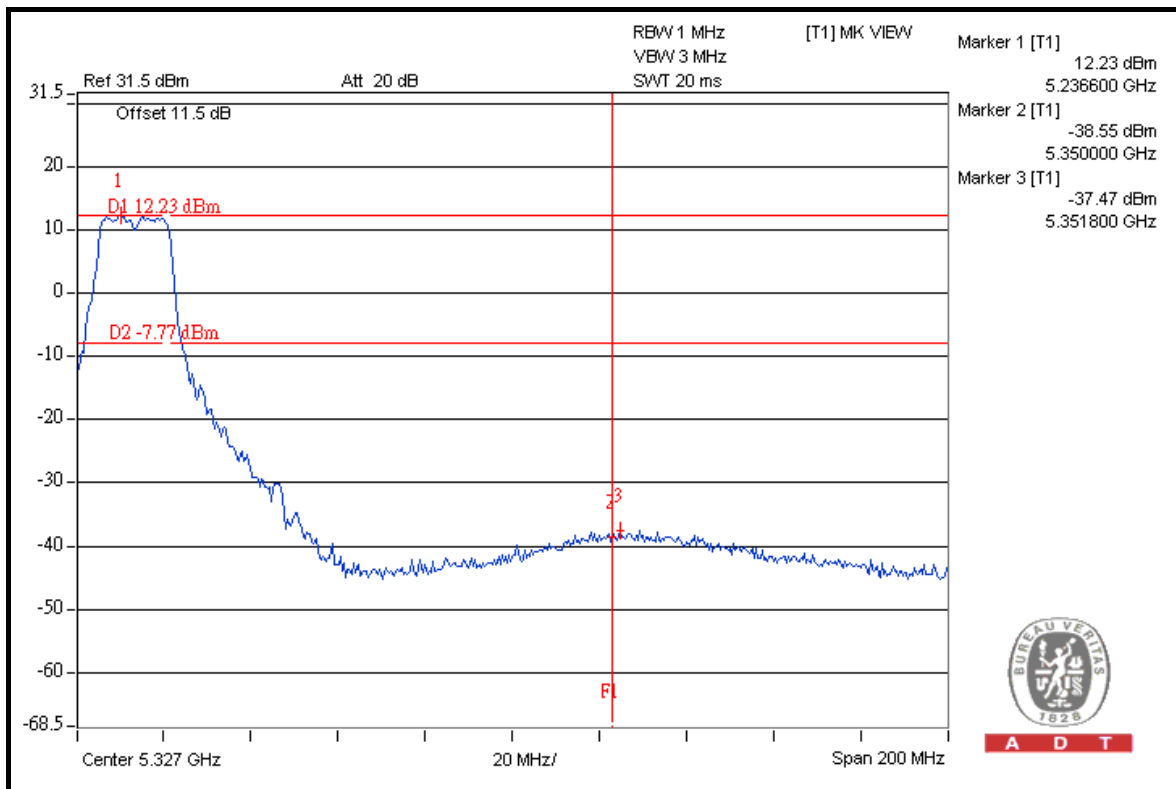
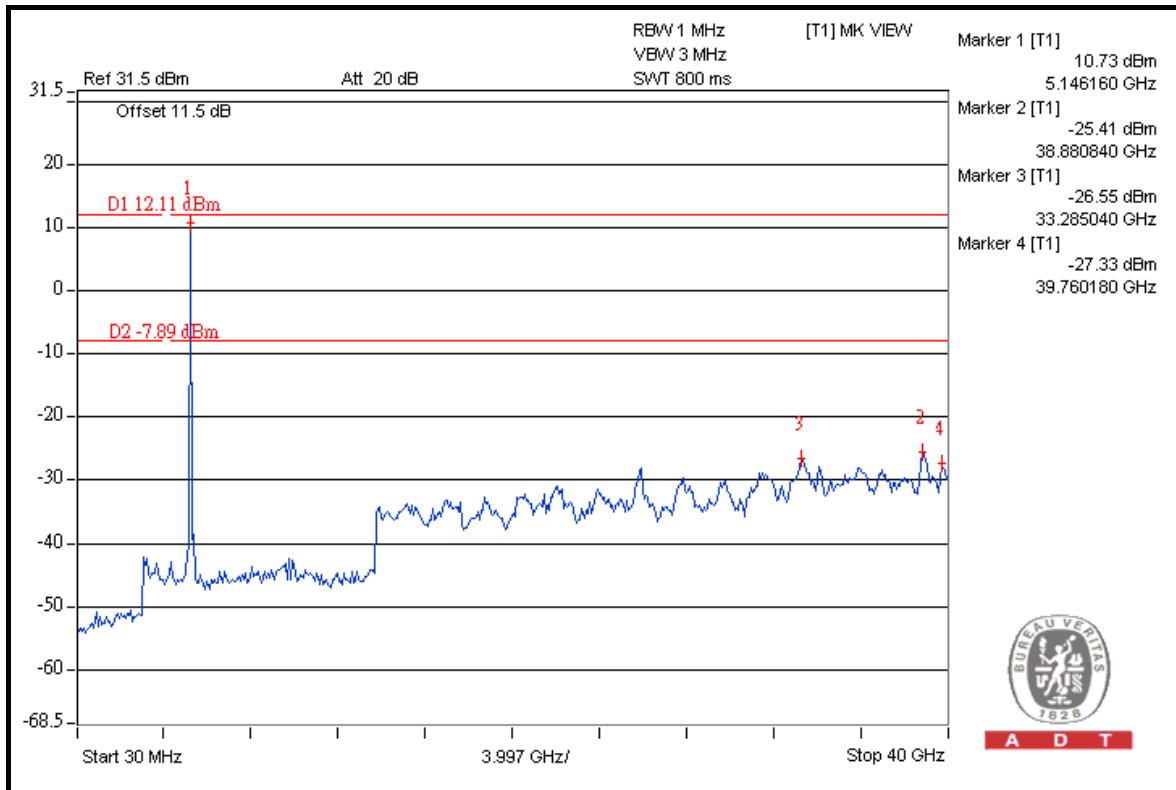



A D T

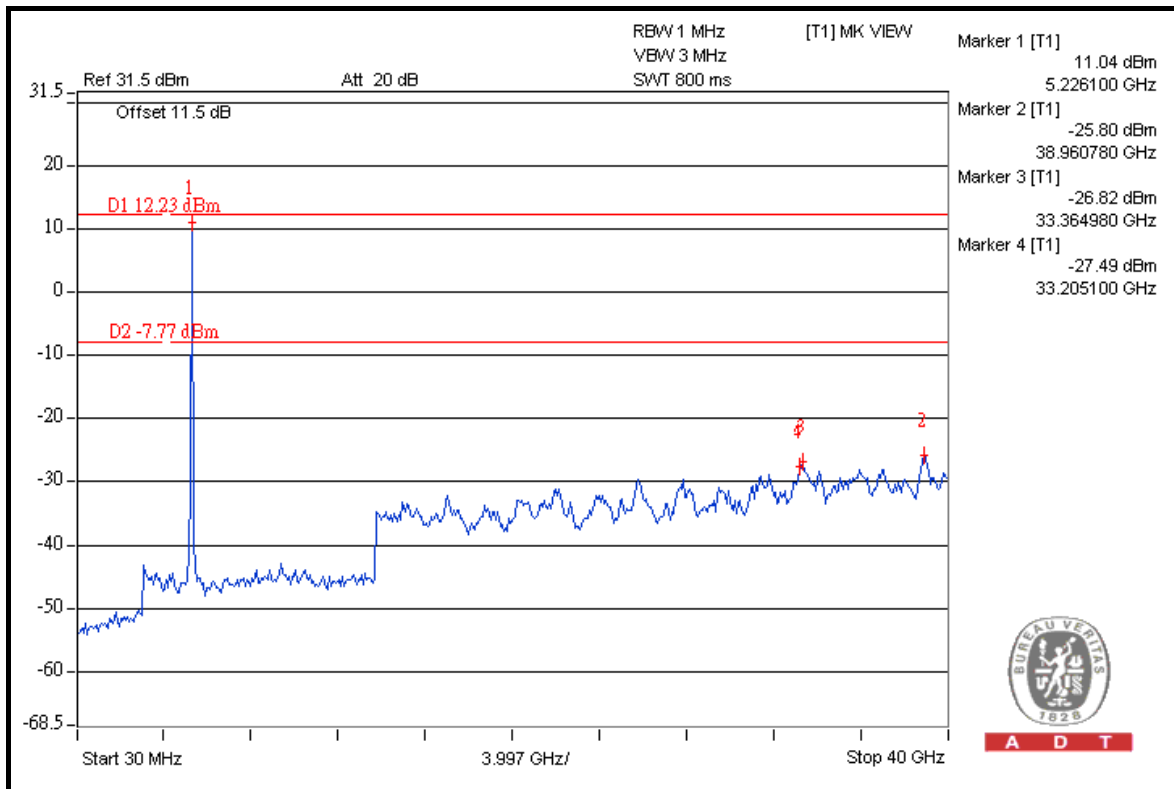
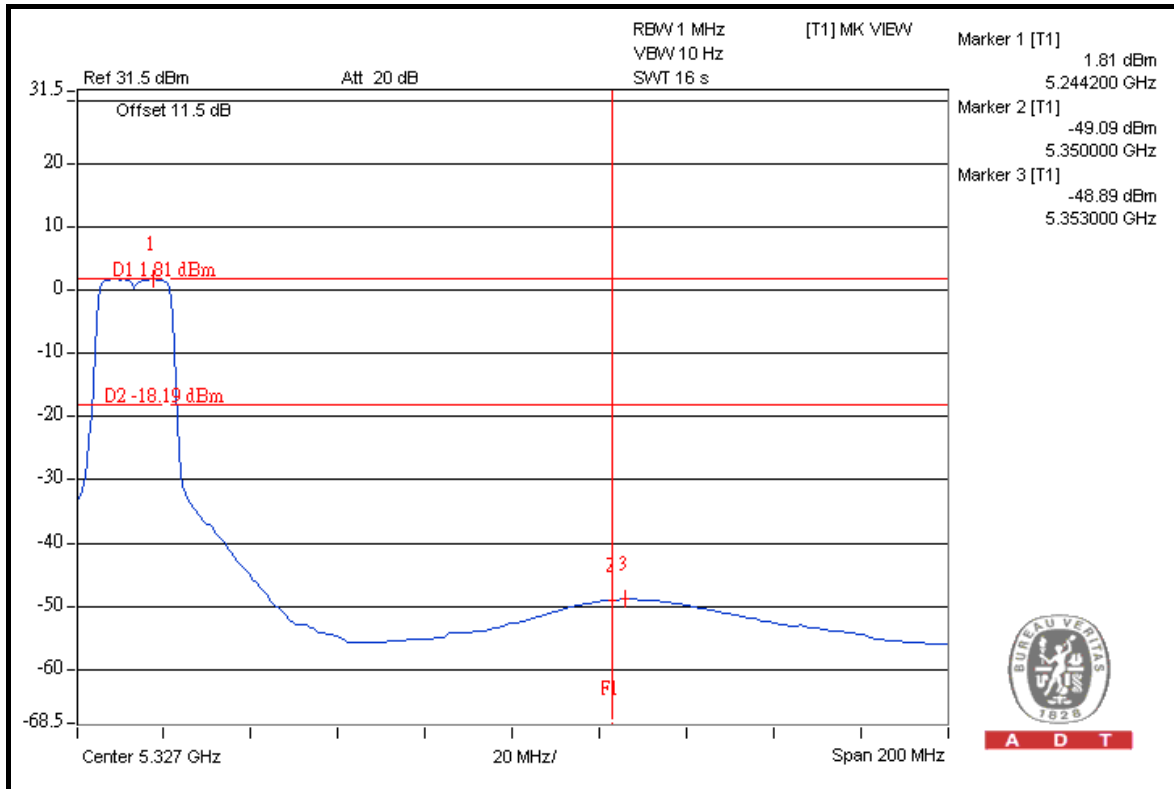



A D T

802.11n (20MHz): 1TX

RESTRICT BAND (4500 ~ 5150 MHz)

FREQUENCY (MHz)	FUNDAMENTAL EMISSION (dBuV/m)	DELTA (dB)	MAXIMUM FIELD STRENGTH IN RESTRICT BAND (dBuV/m)	LIMIT (dBuV/m)
5180.00 (PK)	106.4	38.91	67.49	74.00
5180.00 (AV)	96.5	46.87	49.63	54.00

RESTRICT BAND (5350 ~ 5460 MHz)

FREQUENCY (MHz)	FUNDAMENTAL EMISSION (dBuV/m)	DELTA (dB)	MAXIMUM FIELD STRENGTH IN RESTRICT BAND (dBuV/m)	LIMIT (dBuV/m)
5240.00 (PK)	106.9	50.33	56.57	74.00
5240.00 (AV)	97.0	50.86	46.14	54.00

NOTE:

1. Delta = Amplitude between the peak of the fundamental and the peak of the band edge emission. Please check following 3 pages.
2. Maximum field strength in restrict band = Fundamental emission – Delta.



A D T

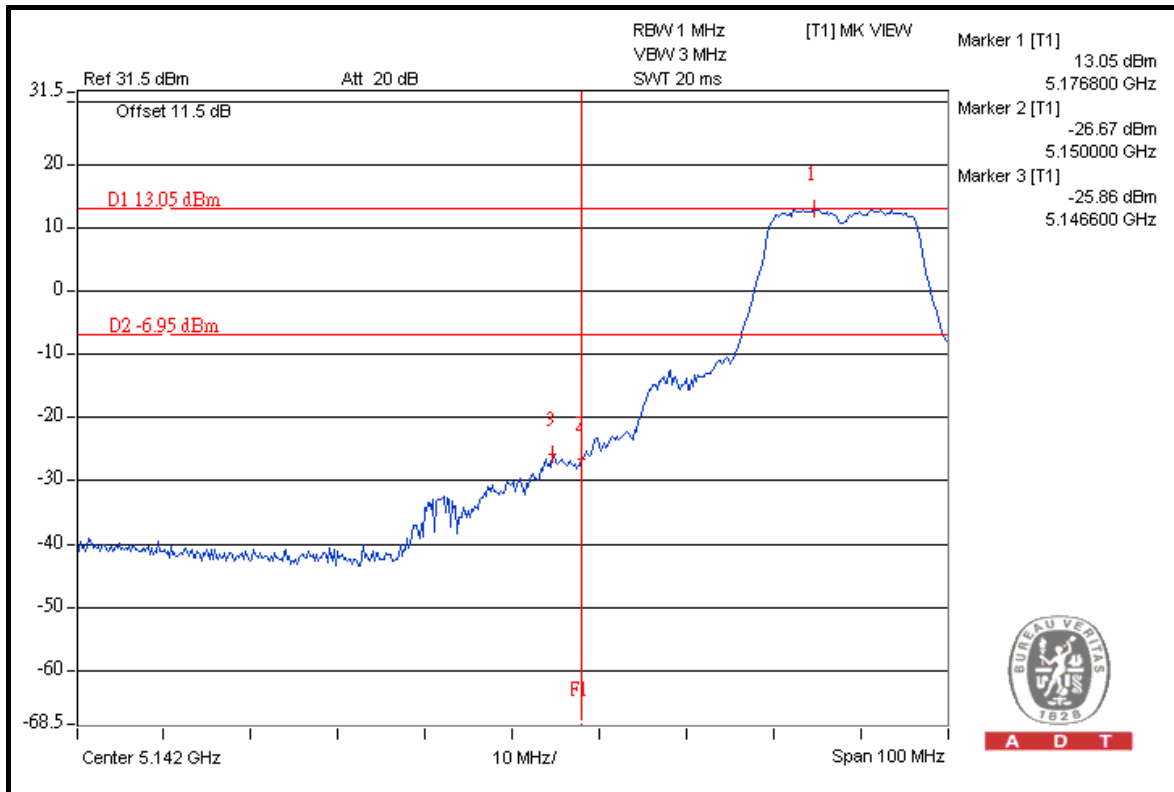

A D T

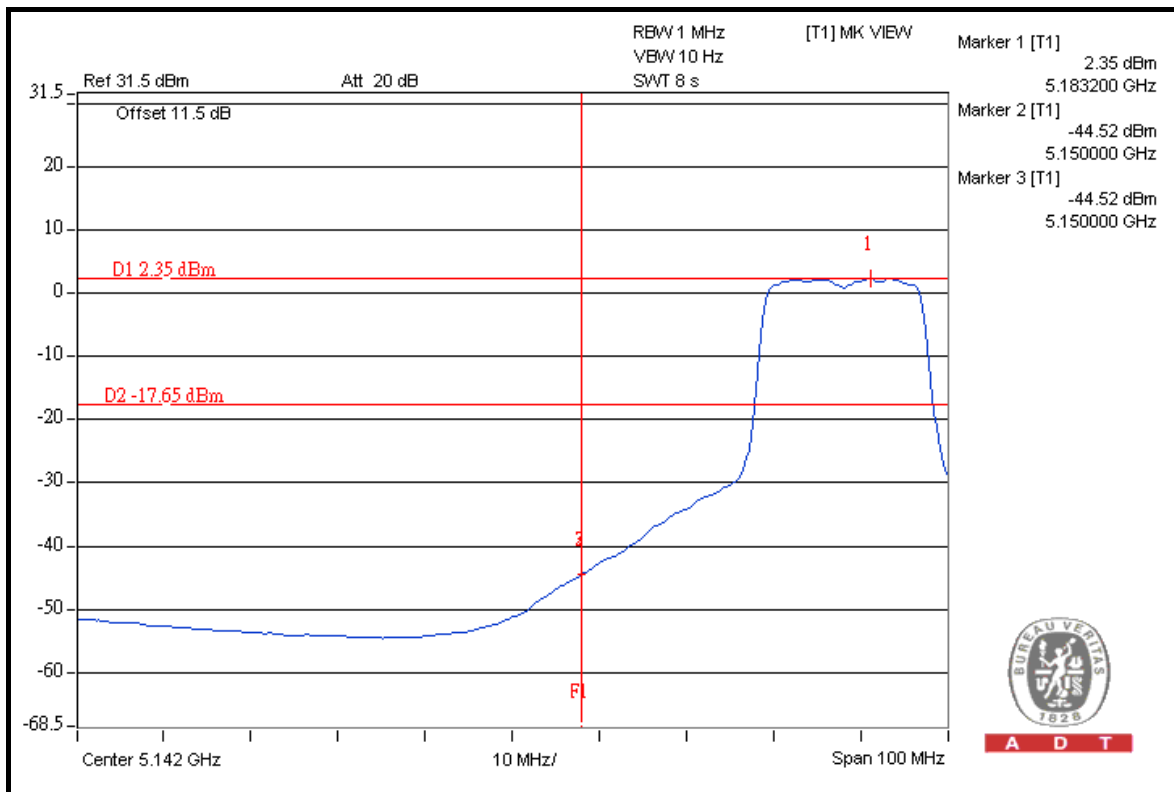

A D T



A D T

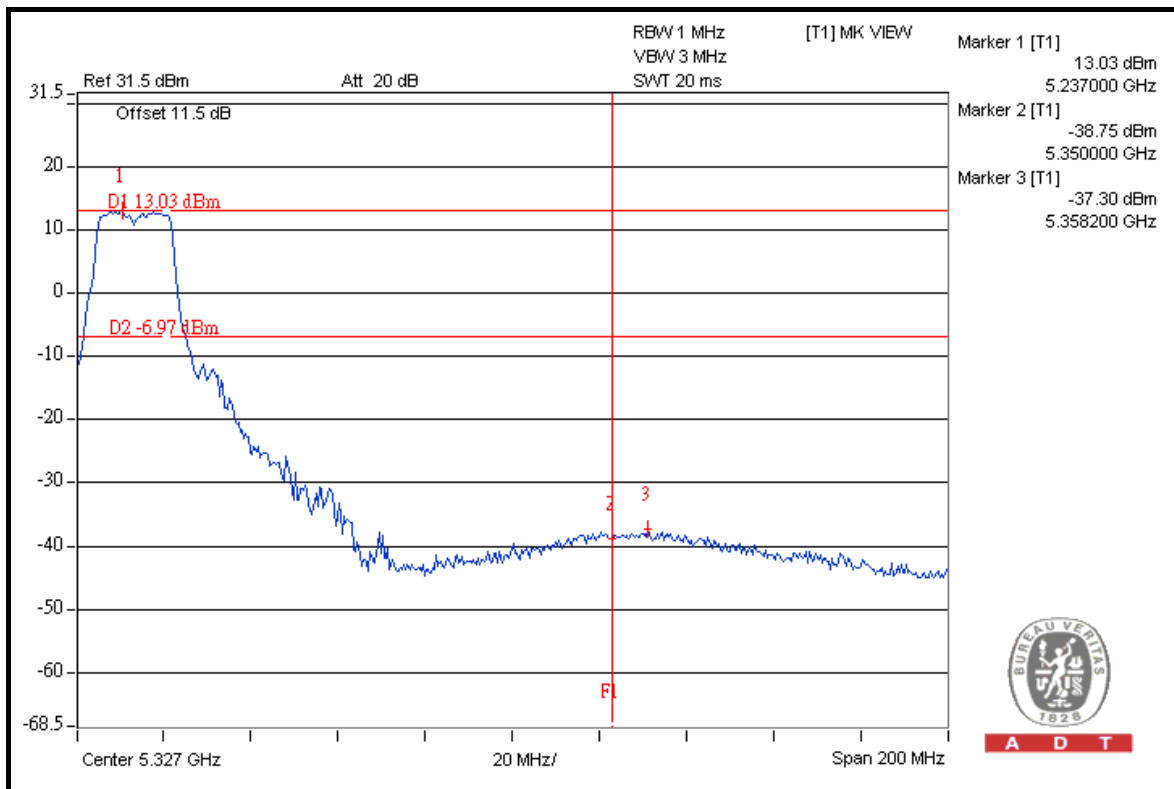
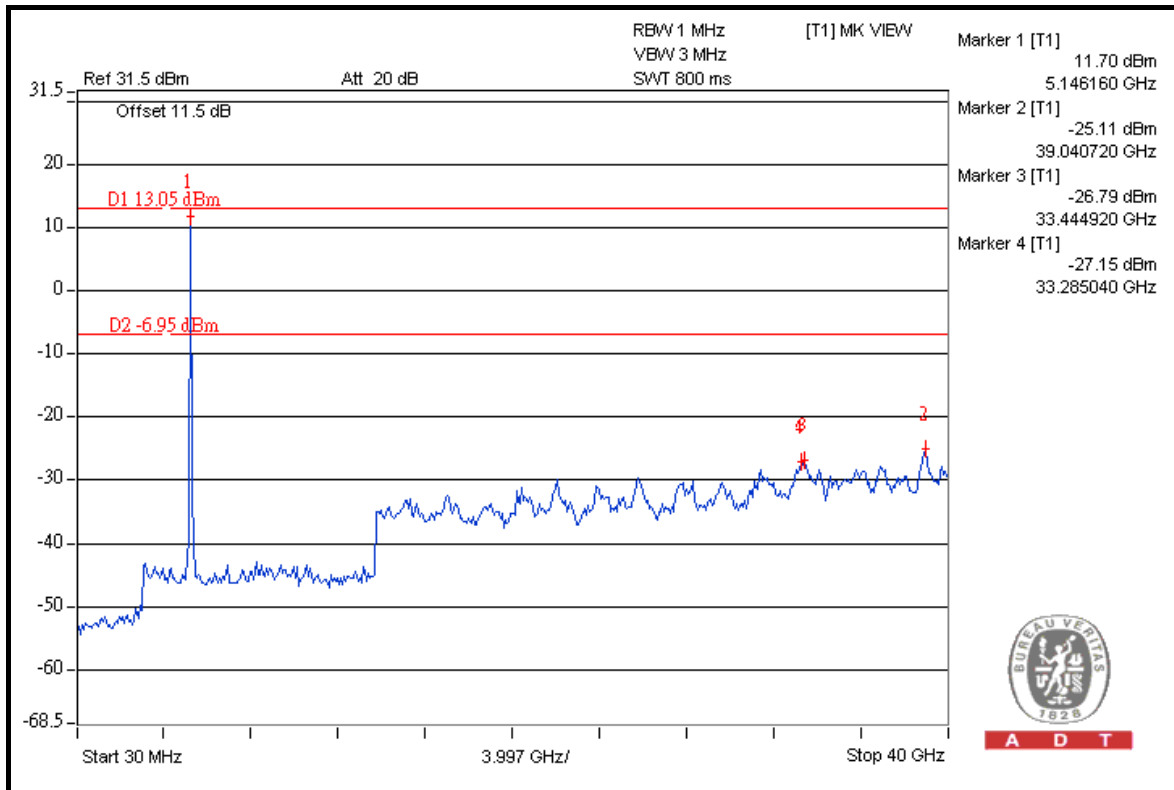



A D T

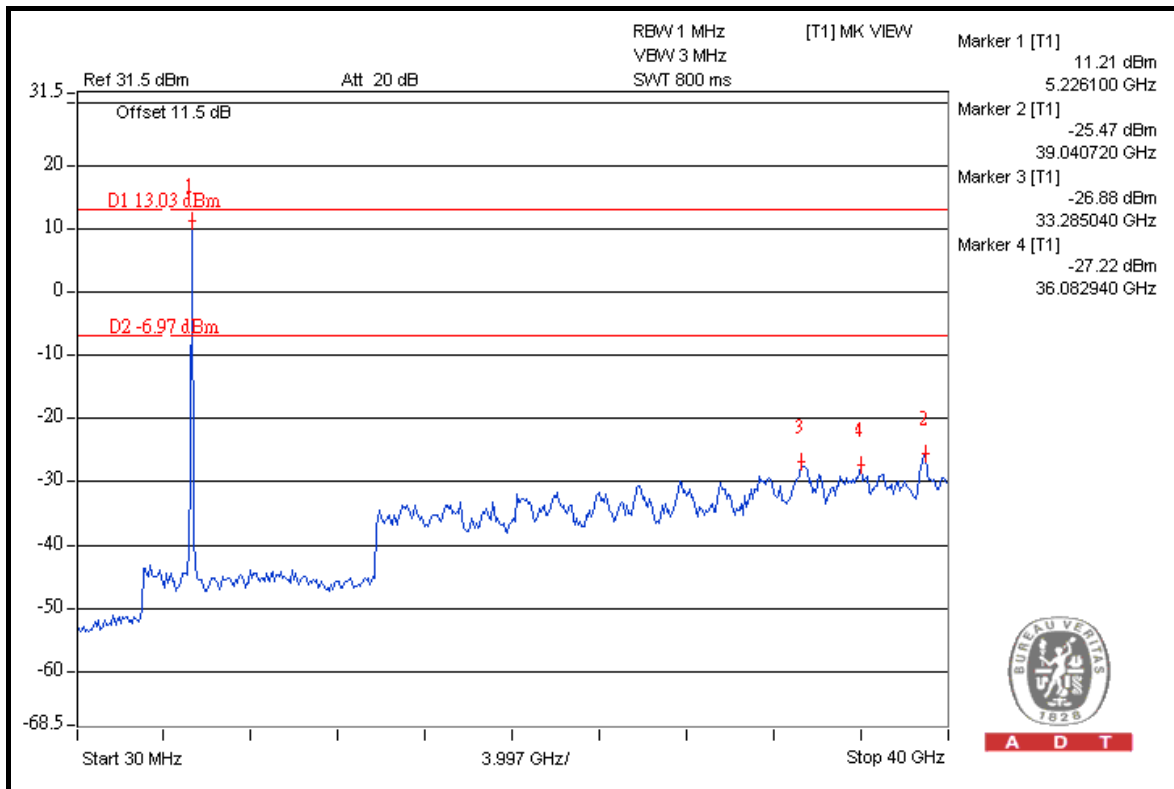
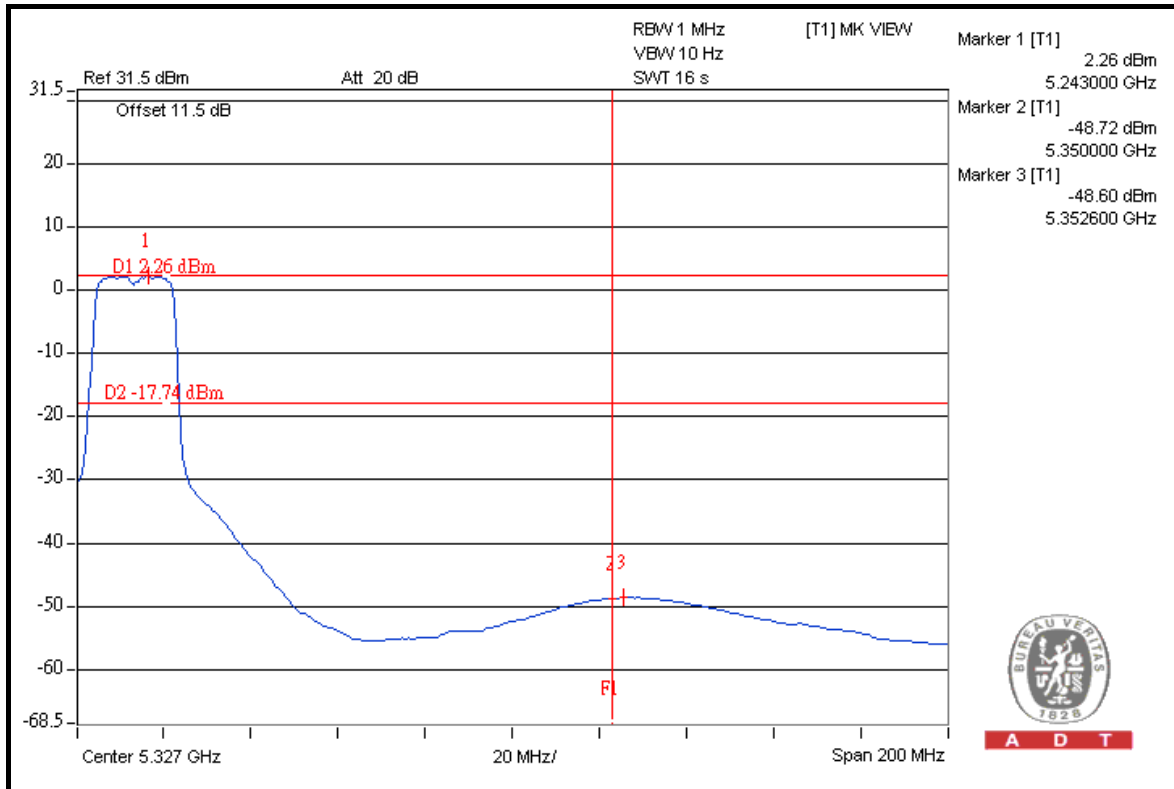



A D T

802.11n (20MHz): 2TX

RESTRICT BAND (4500 ~ 5150 MHz)

FREQUENCY (MHz)	FUNDAMENTAL EMISSION (dBuV/m)	DELTA (dB)	MAXIMUM FIELD STRENGTH IN RESTRICT BAND (dBuV/m)	LIMIT (dBuV/m)
5180.00 (PK)	107.6	47.53	60.07	74.00
5180.00 (AV)	97.1	50.57	46.53	54.00

RESTRICT BAND (5350 ~ 5460 MHz)

FREQUENCY (MHz)	FUNDAMENTAL EMISSION (dBuV/m)	DELTA (dB)	MAXIMUM FIELD STRENGTH IN RESTRICT BAND (dBuV/m)	LIMIT (dBuV/m)
5240.00 (PK)	107.7	46.42	61.28	74.00
5240.00 (AV)	97.2	46.76	50.44	54.00

NOTE:

1. Delta = Amplitude between the peak of the fundamental and the peak of the band edge emission. Please check following 3 pages.
2. Maximum field strength in restrict band = Fundamental emission – Delta.



A D T

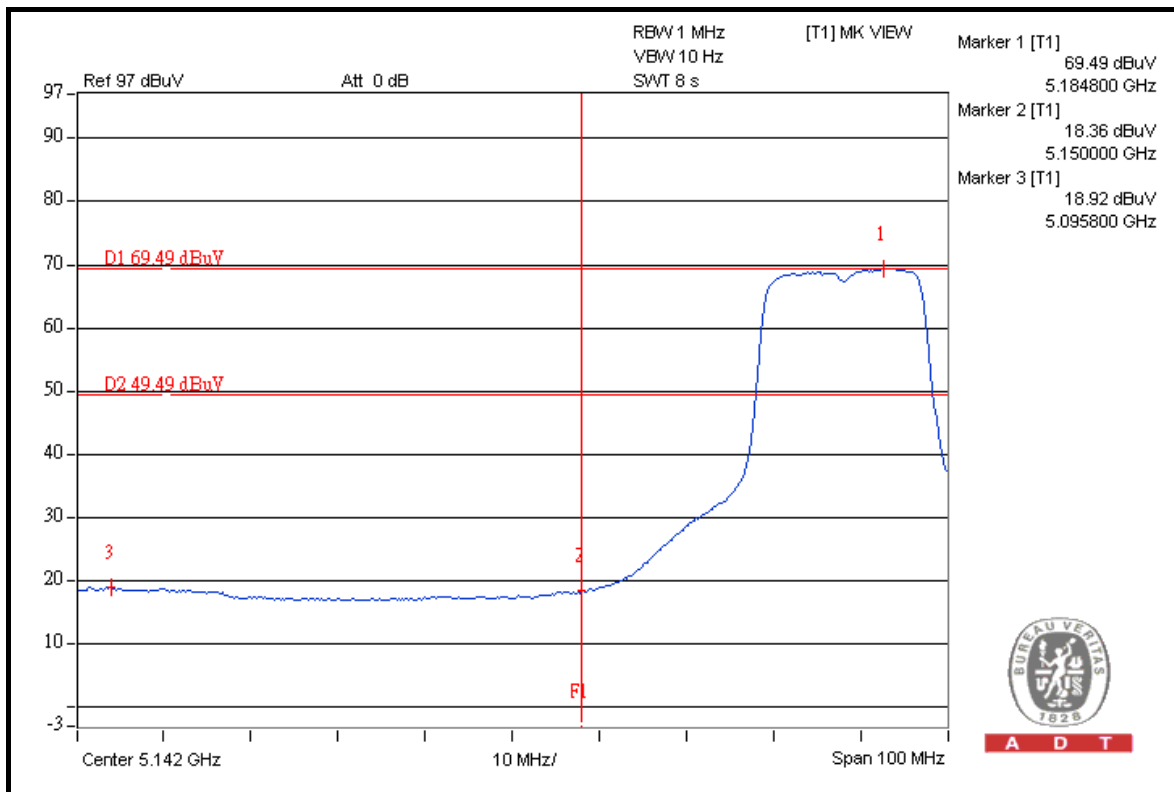
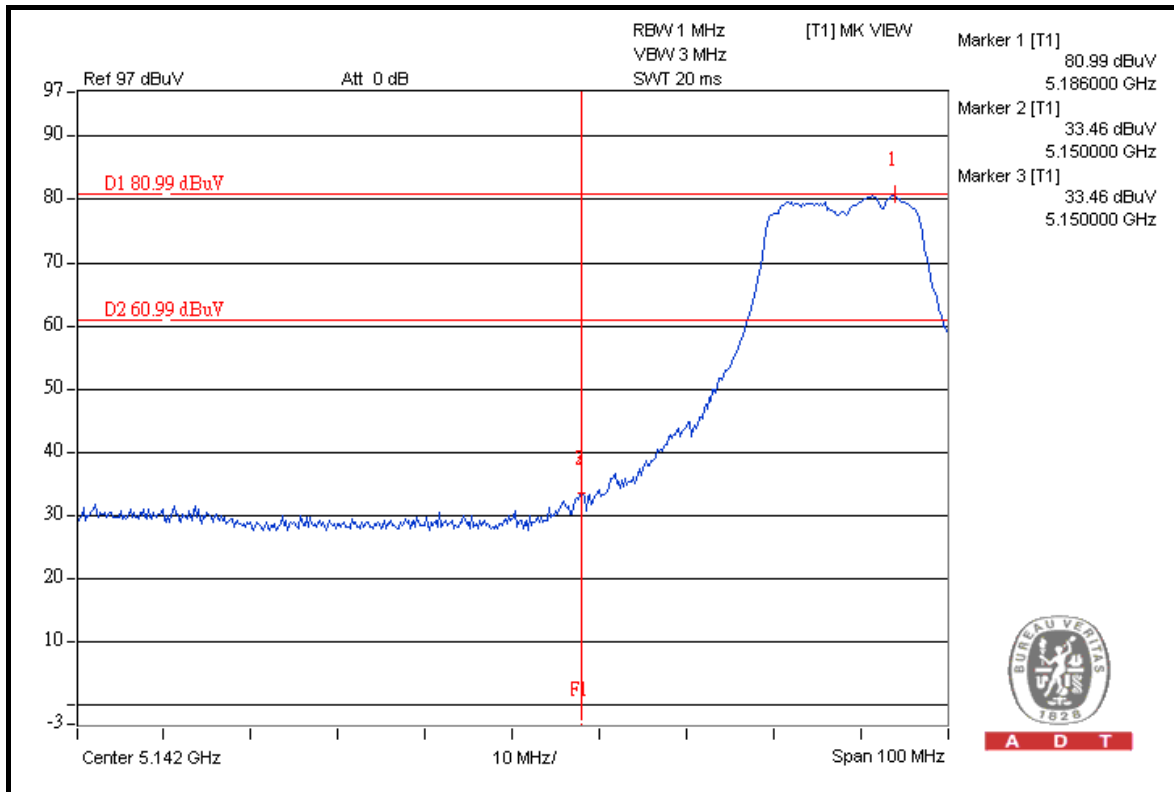



A D T

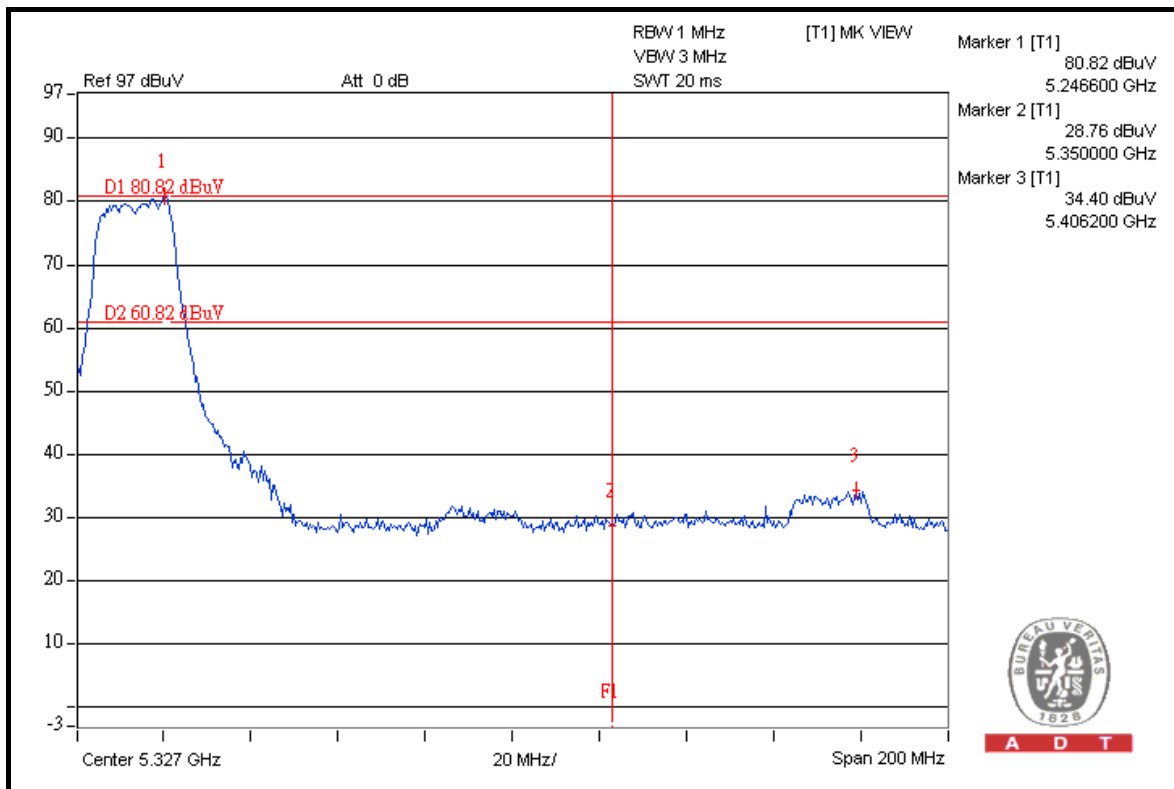
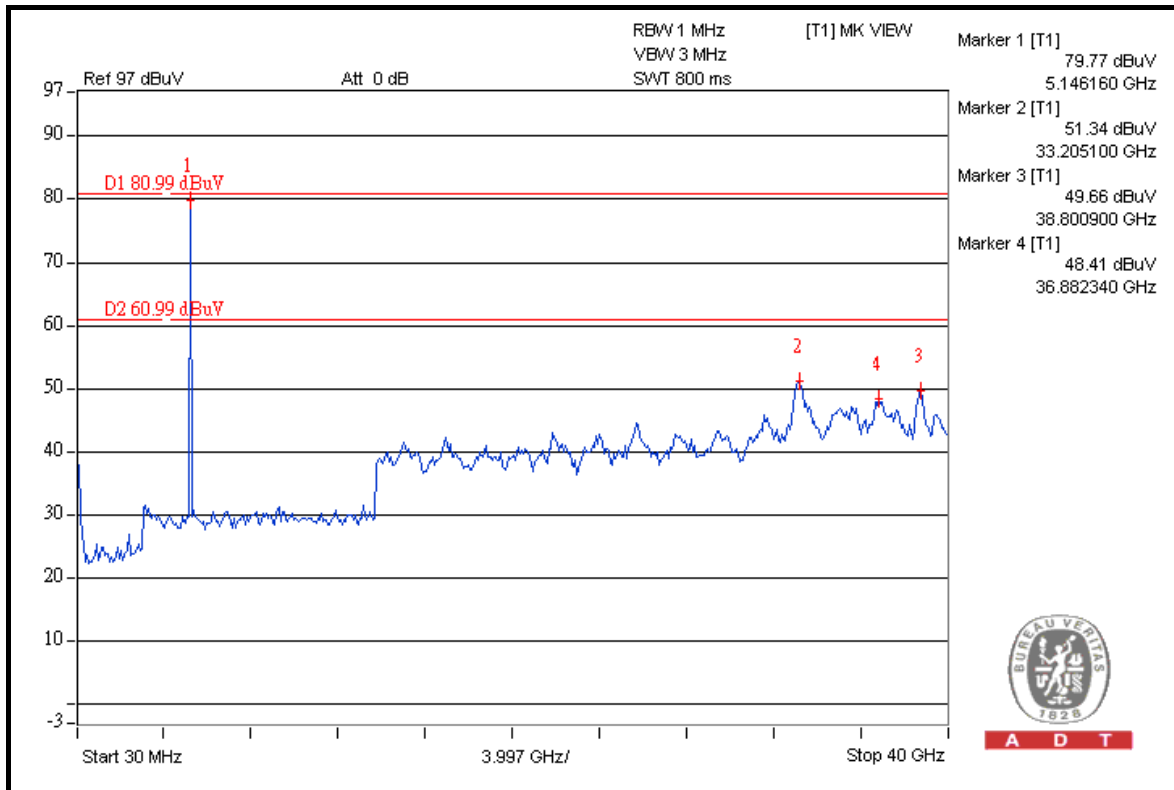



A D T

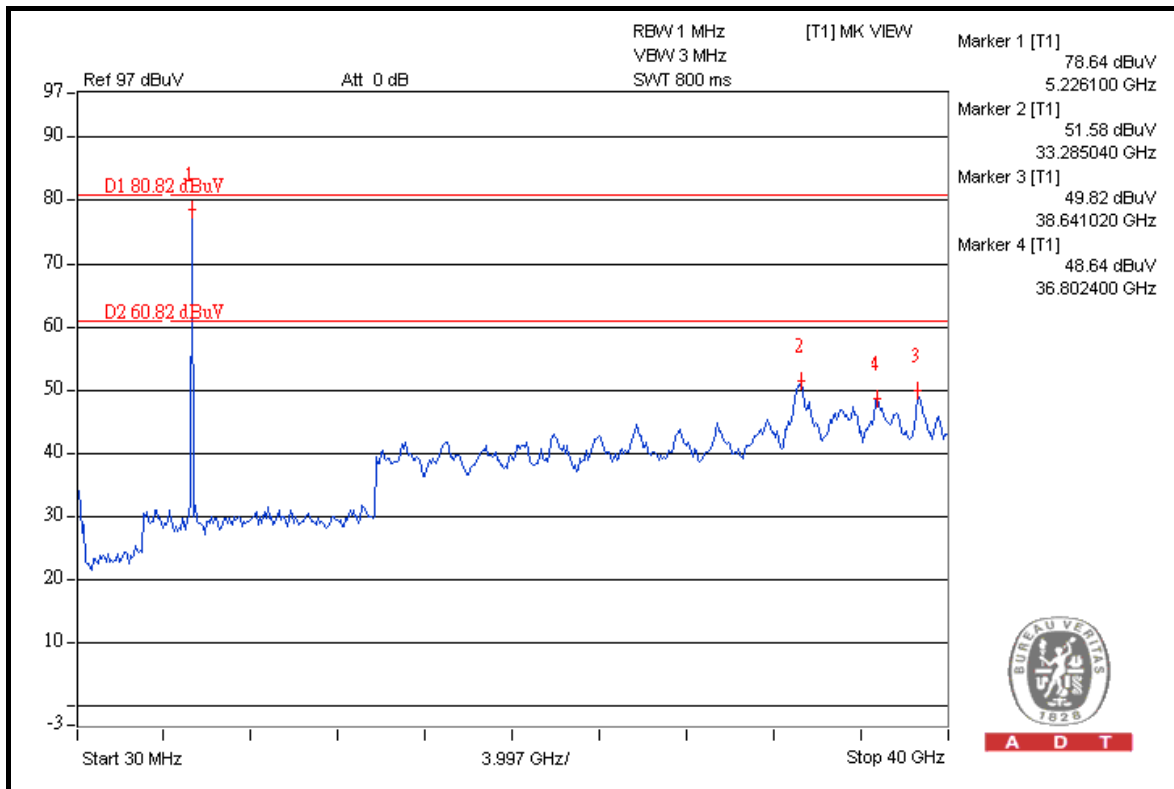
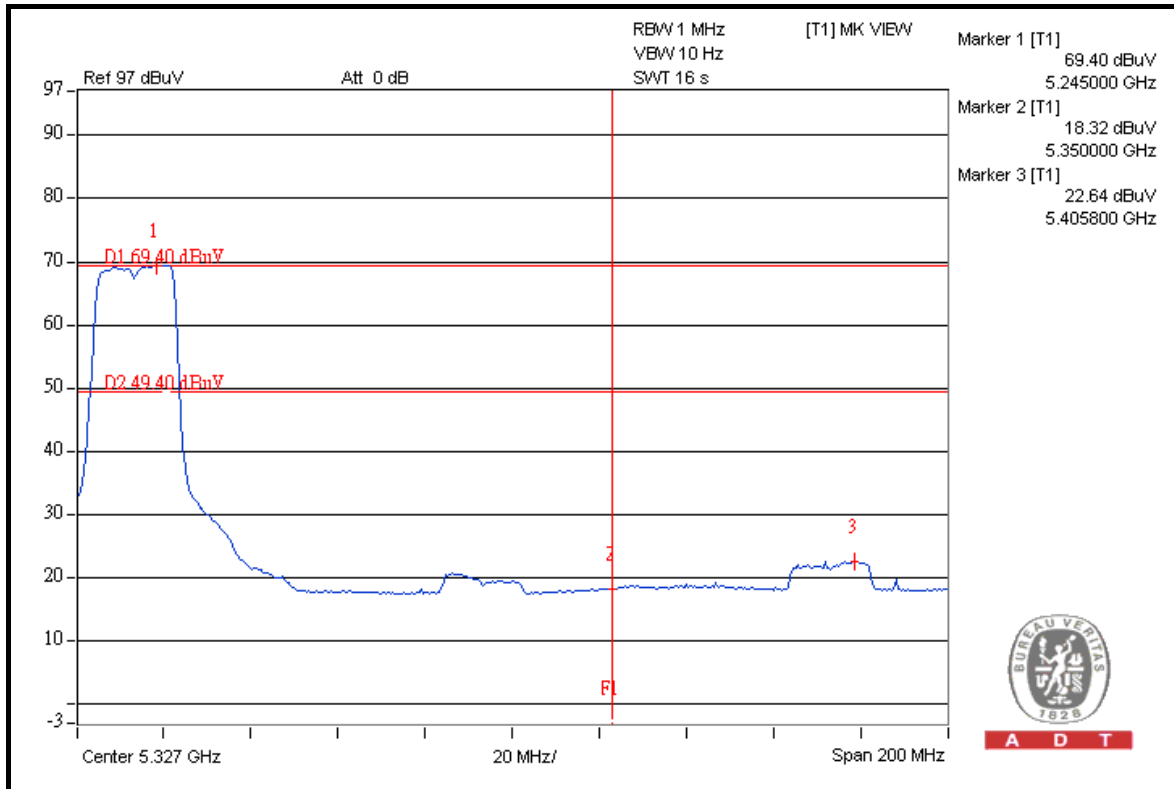



A D T

802.11n (40MHz): 1TX

RESTRICT BAND (4500 ~ 5150 MHz)

FREQUENCY (MHz)	FUNDAMENTAL EMISSION (dBuV/m)	DELTA (dB)	MAXIMUM FIELD STRENGTH IN RESTRICT BAND (dBuV/m)	LIMIT (dBuV/m)
5190.00 (PK)	103.1	32.32	70.78	74.00
5190.00 (AV)	92.9	40.21	52.69	54.00

RESTRICT BAND (5350 ~ 5460 MHz)

FREQUENCY (MHz)	FUNDAMENTAL EMISSION (dBuV/m)	DELTA (dB)	MAXIMUM FIELD STRENGTH IN RESTRICT BAND (dBuV/m)	LIMIT (dBuV/m)
5230.00 (PK)	103.6	48.14	55.46	74.00
5230.00 (AV)	93.0	48.96	44.04	54.00

NOTE:

1. Delta = Amplitude between the peak of the fundamental and the peak of the band edge emission. Please check following 3 pages.
2. Maximum field strength in restrict band = Fundamental emission – Delta.



A D T

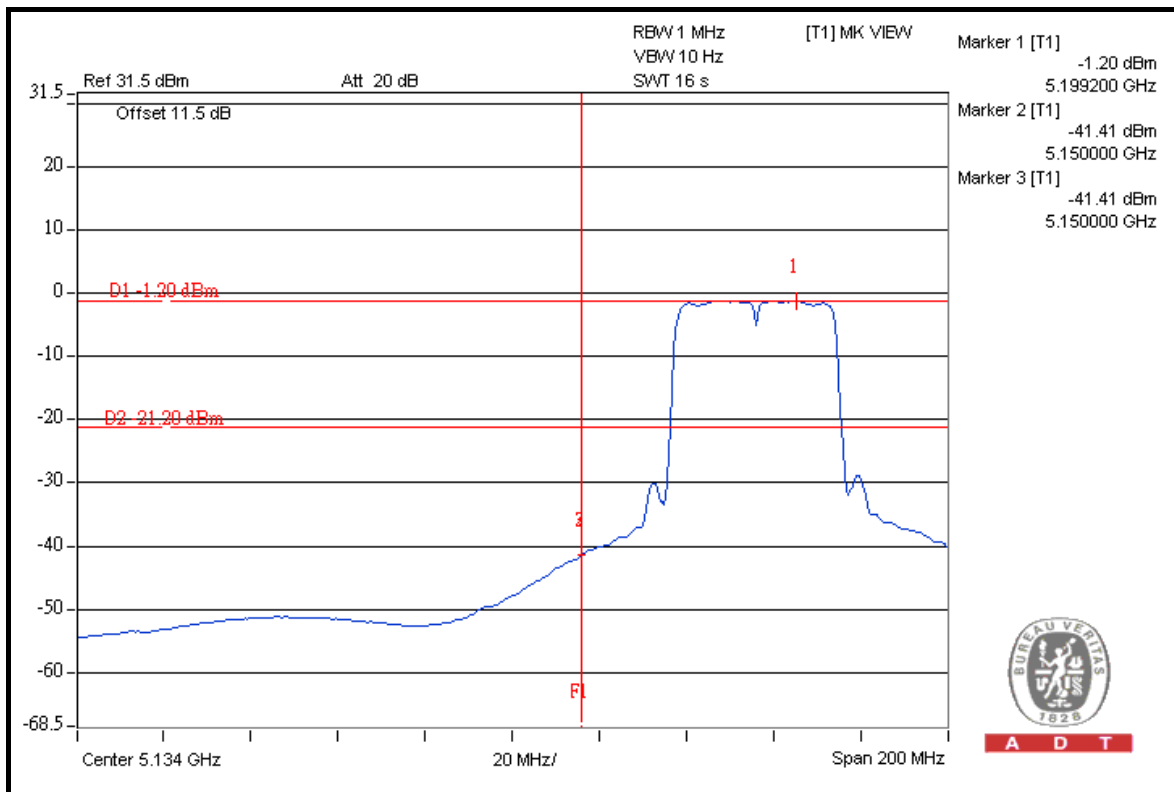
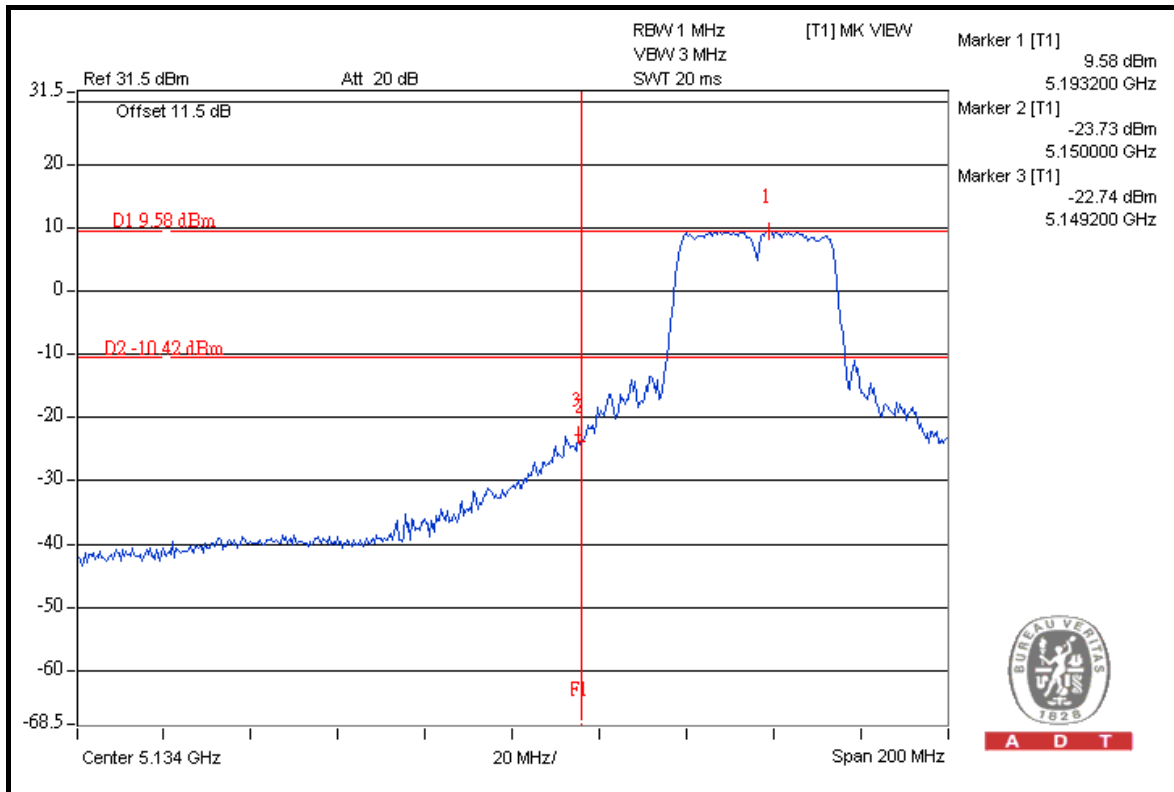



A D T

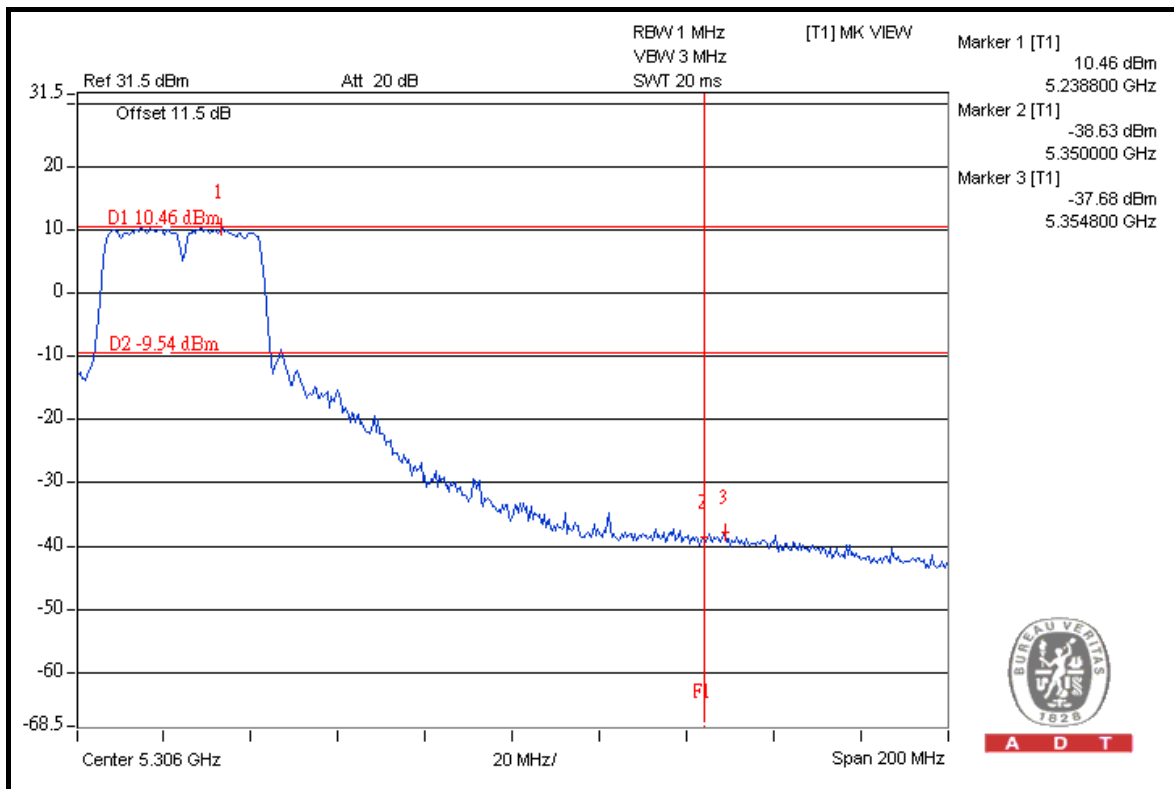
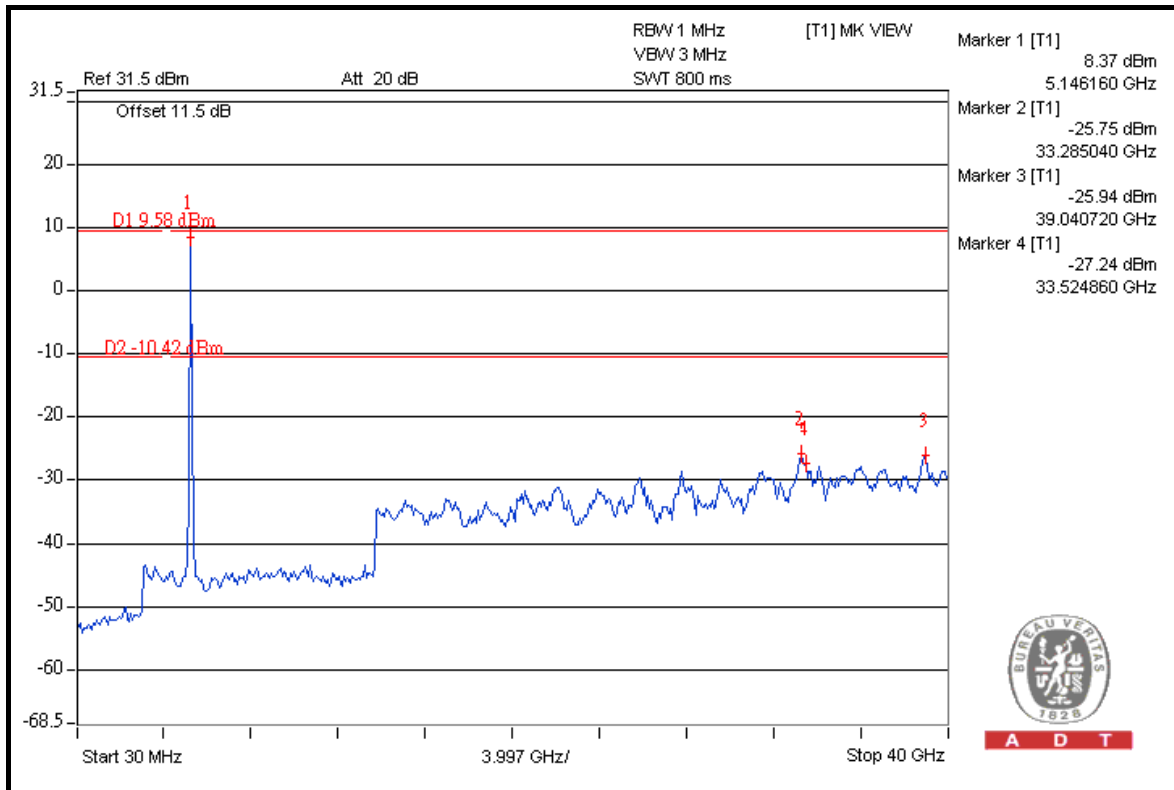



A D T

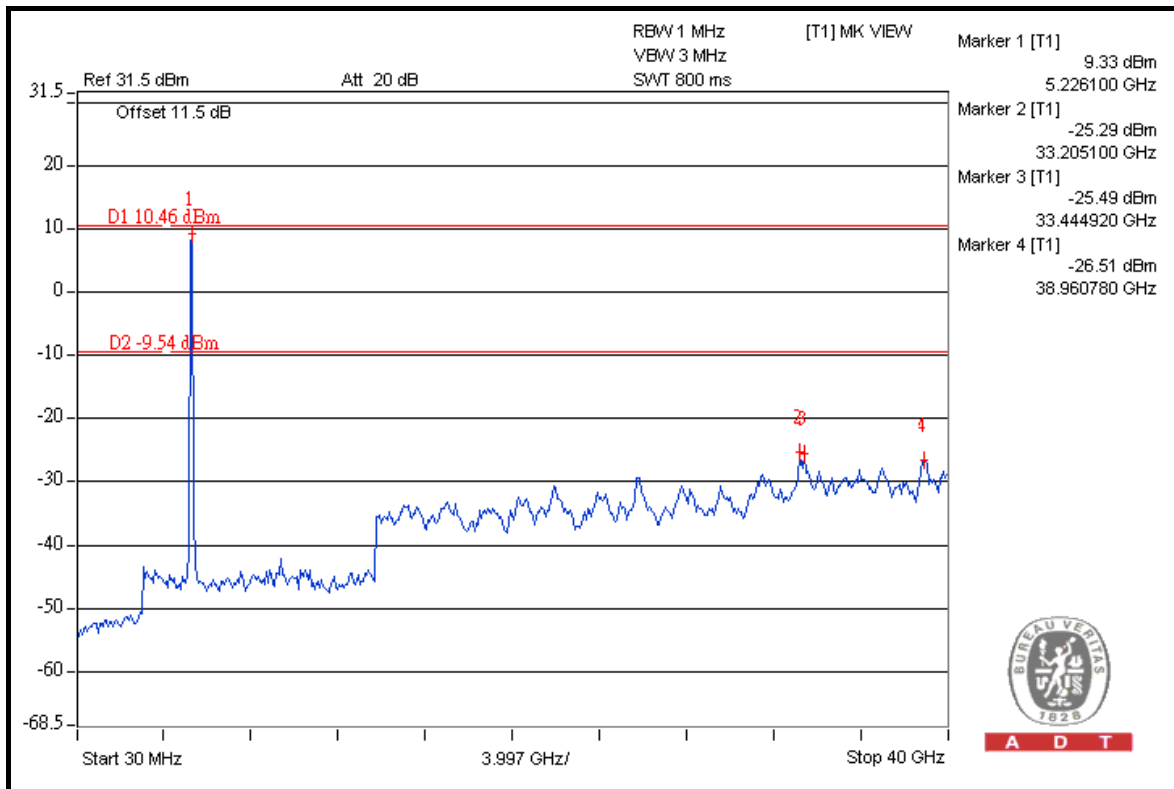
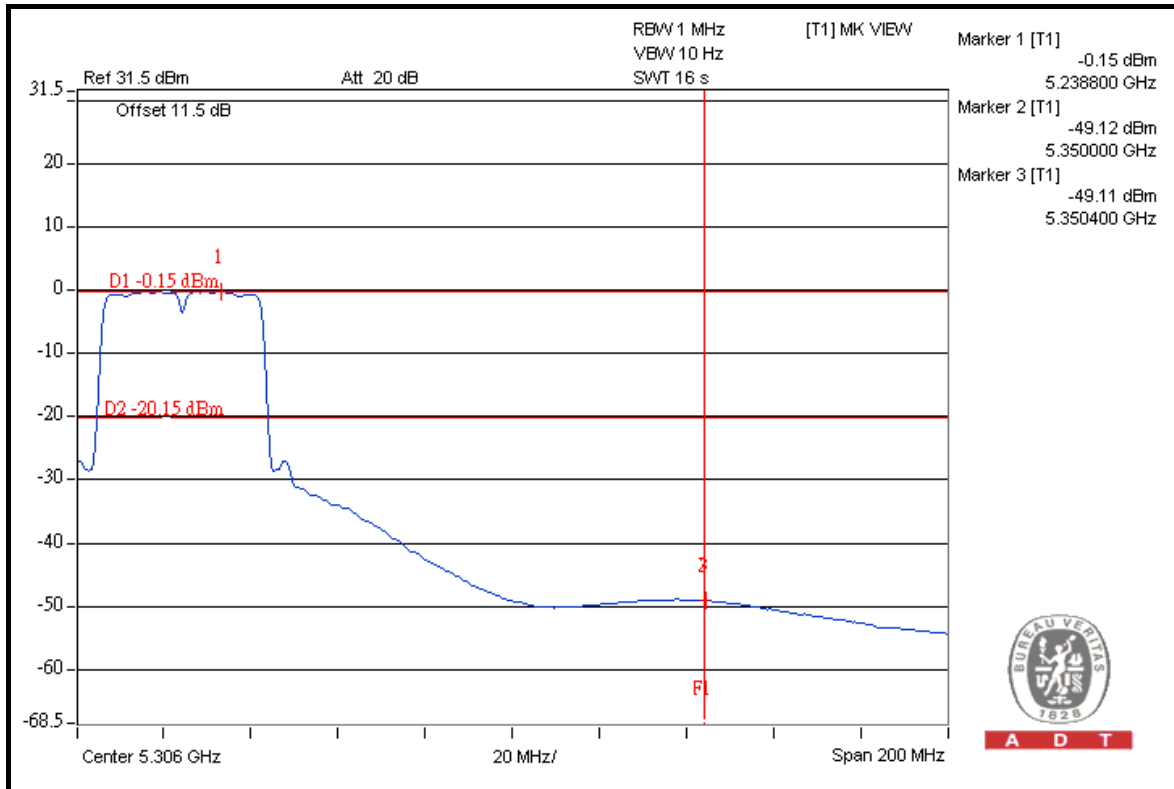



A D T

802.11n (40MHz): 2TX

RESTRICT BAND (4500 ~ 5150 MHz)

FREQUENCY (MHz)	FUNDAMENTAL EMISSION (dBuV/m)	DELTA (dB)	MAXIMUM FIELD STRENGTH IN RESTRICT BAND (dBuV/m)	LIMIT (dBuV/m)
5190.00 (PK)	103.5	43.59	59.91	74.00
5190.00 (AV)	93.0	45.00	48.00	54.00

RESTRICT BAND (5350 ~ 5460 MHz)

FREQUENCY (MHz)	FUNDAMENTAL EMISSION (dBuV/m)	DELTA (dB)	MAXIMUM FIELD STRENGTH IN RESTRICT BAND (dBuV/m)	LIMIT (dBuV/m)
5230.00 (PK)	104.2	41.08	63.12	74.00
5230.00 (AV)	93.5	41.63	51.87	54.00

NOTE:

1. Delta = Amplitude between the peak of the fundamental and the peak of the band edge emission. Please check following 3 pages.
2. Maximum field strength in restrict band = Fundamental emission – Delta.



A D T

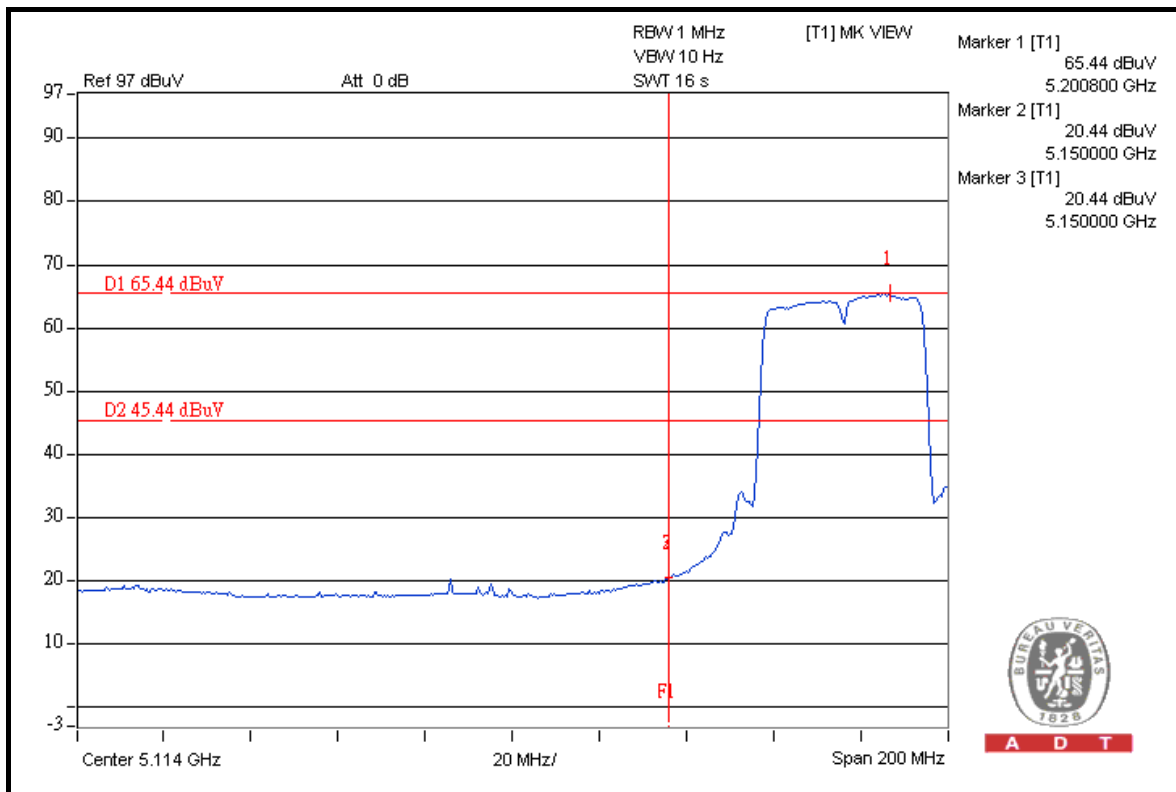
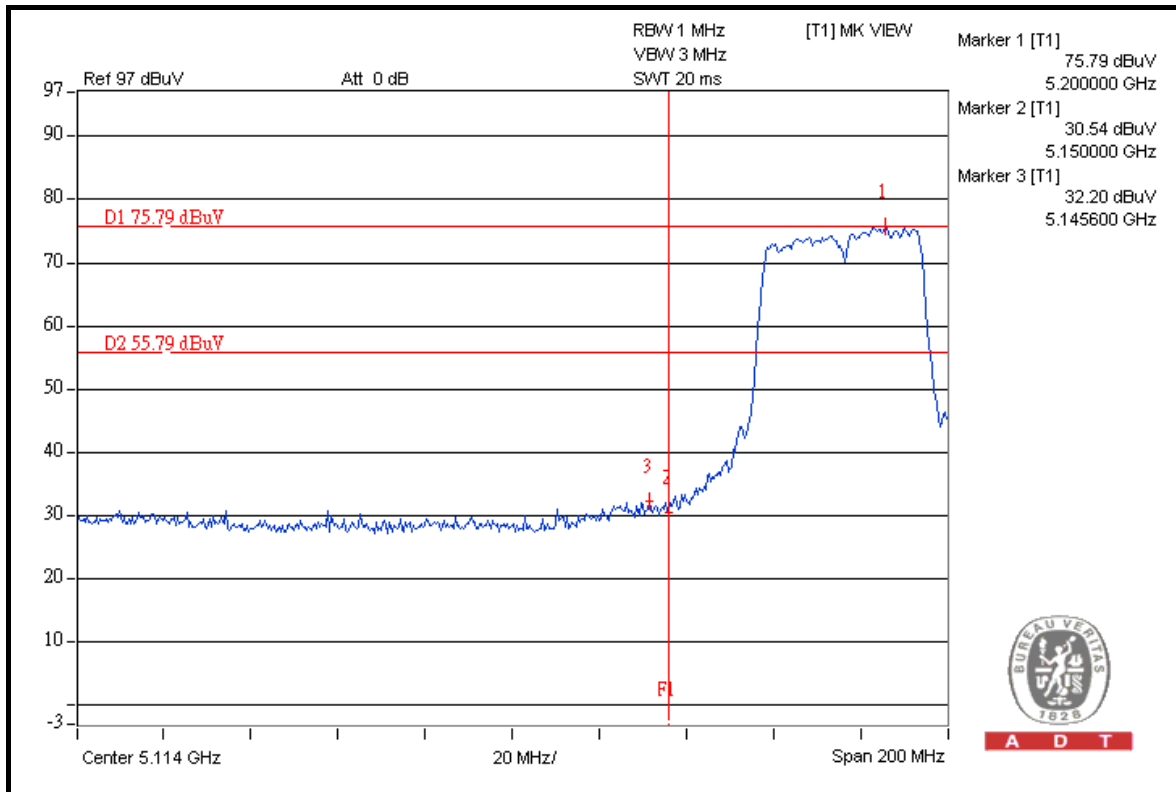



A D T

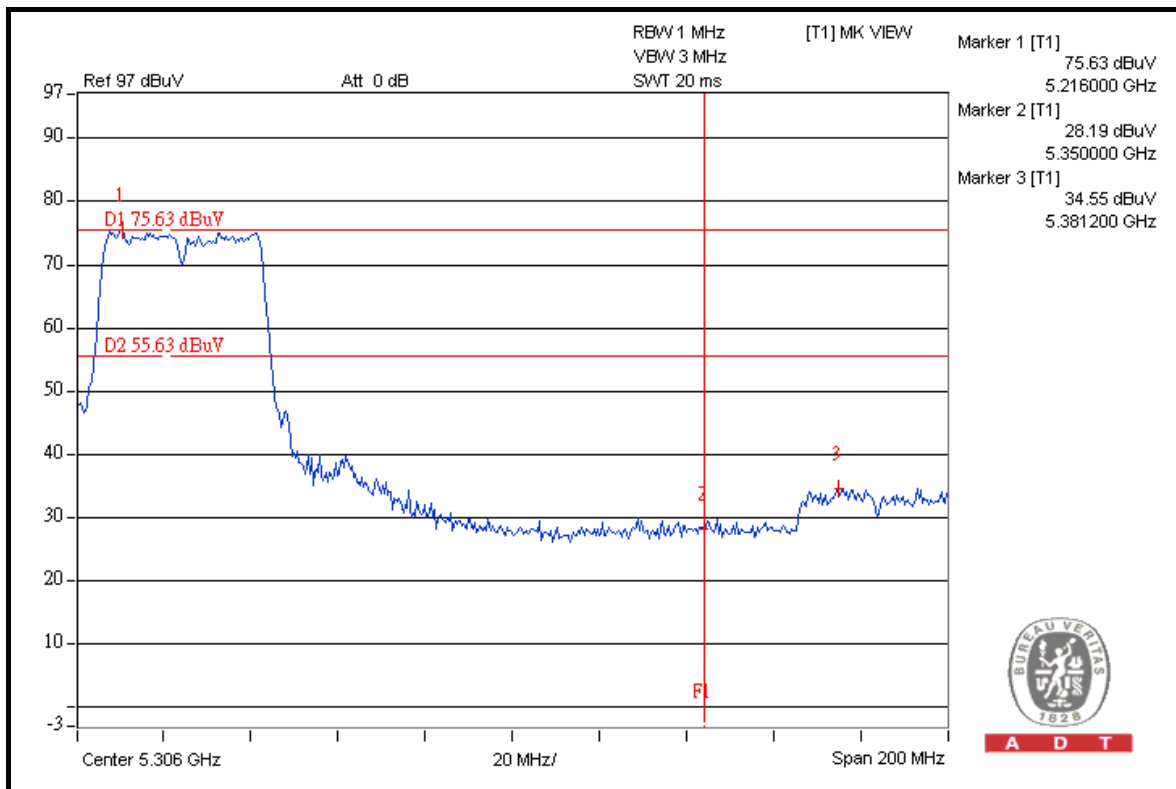
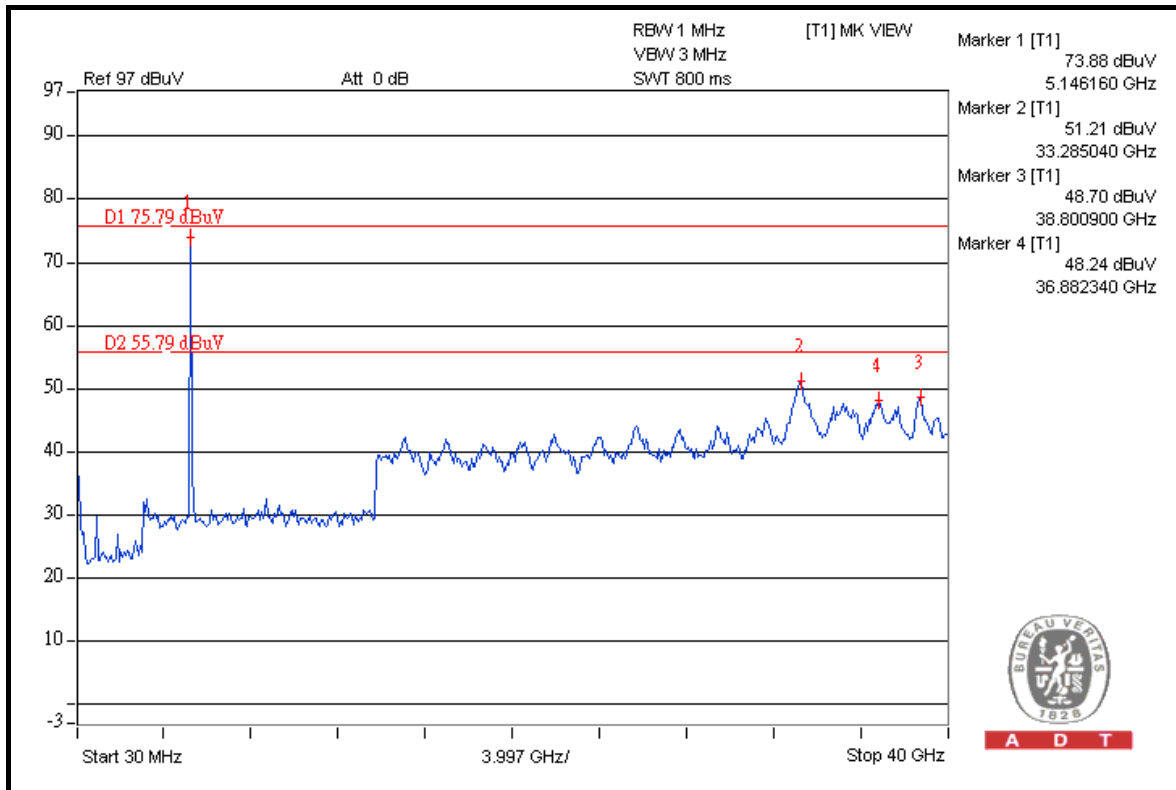



A D T

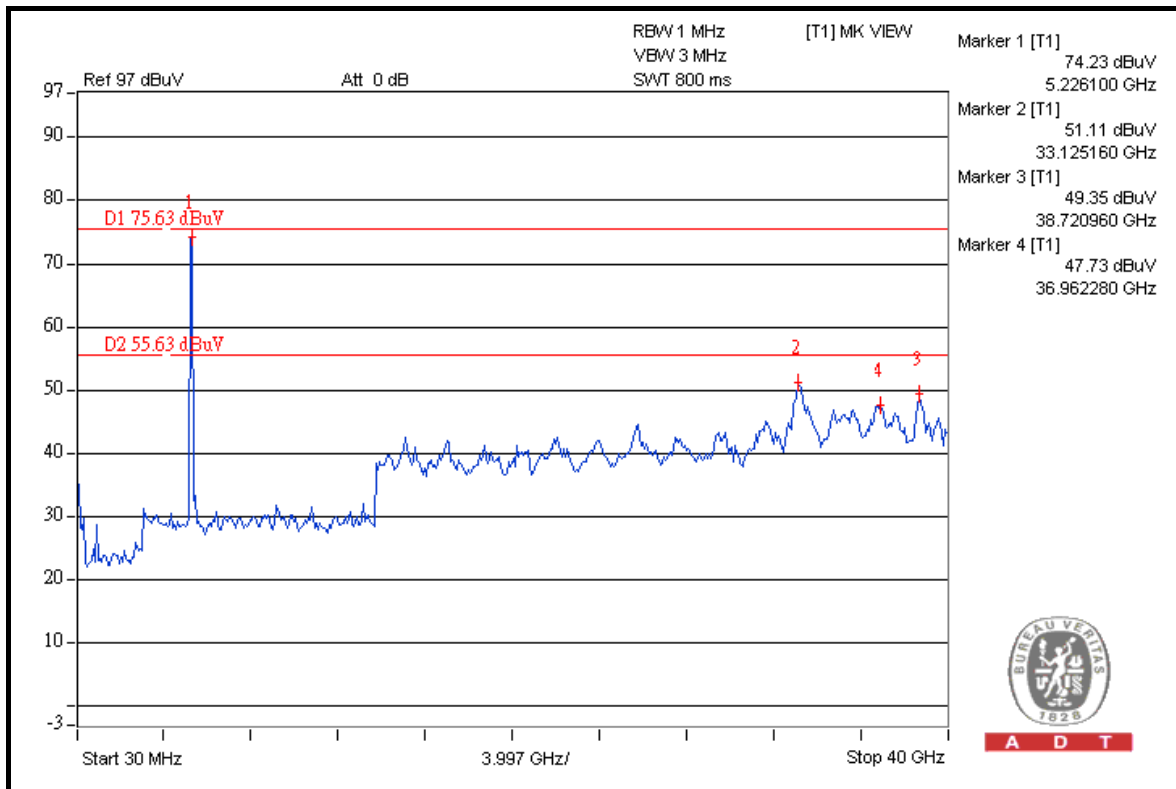
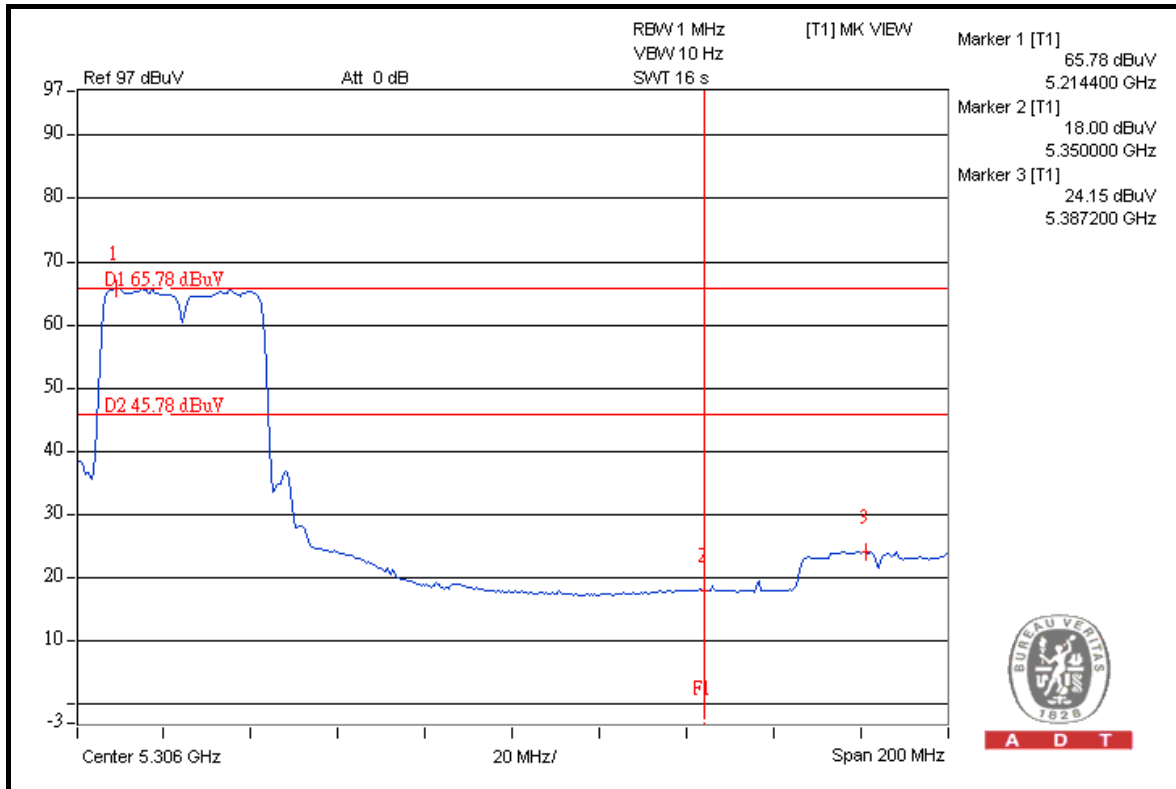



A D T

5. PHOTOGRAPHS OF THE TEST CONFIGURATION

Please refer to the attached file (Test Setup Photo).



6. INFORMATION ON THE TESTING LABORATORIES

We, Bureau Veritas Consumer Products Services (H.K.) Ltd., Taoyuan Branch, were founded in 1988 to provide our best service in EMC, Radio, Telecom and Safety consultation. Our laboratories are accredited and approved according to ISO/IEC 17025.

Copies of accreditation certificates of our laboratories obtained from approval agencies can be downloaded from our web site:

www.adt.com.tw/index.5.phtml. If you have any comments, please feel free to contact us at the following:

Linko EMC/RF Lab:

Tel: 886-2-26052180

Fax: 886-2-26051924

Hsin Chu EMC/RF Lab:

Tel: 886-3-5935343

Fax: 886-3-5935342

Hwa Ya EMC/RF/Safety Telecom Lab:

Tel: 886-3-3183232

Fax: 886-3-3185050

Web Site: www.adt.com.tw

The address and road map of all our labs can be found in our web site also.



A D T

7. APPENDIX A - MODIFICATIONS RECORDERS FOR ENGINEERING CHANGES TO THE EUT BY THE LAB

No any modifications are made to the EUT by the lab during the test.

---END---