



明泰科技

零組件承認/申請報告書

編號：E13921B 2006/3/9

Alpha P/N : 505924900017G		申請者：張佑誠	主管：楊威
零組件品名：ANTENNA 3dBi C037-510694-A			
原製造廠商：譚裕(500770)		原廠編號：C037-510694-A	
代理商：譚裕		聯絡人：李春華	電話：03-5714225 #1517
應用機種：			
COMMENTS：			
測試結果	UPDATE：增加 D-Link logo		
<p>檢驗重點:</p> <ol style="list-style-type: none"> 1. 外觀 2. 尺寸 3. 型號 			
主管：王椅楠		承辦者：周禎義	
		測試人：	日期：2006/3/7
機構	R&D		PM
生技	資材		品管
結果	合格	否決	其它
	審核		王椅楠

REFERENCE ONLY

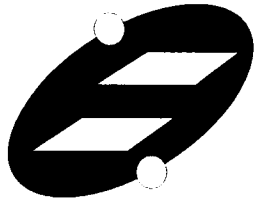

WHA YU INDUSTRIAL CO., LTD. (HEAD OFFICE)
 TAI HWA ELECTRONIC CO., LTD.(CHINA)
 SHANGHAI HUA YU ELECTRONIC CO., LTD.(CHINA)
 AEON TECH CO., LTD. (CHINA)

SPECIFICATION FOR APPROVAL

CUSTOMER: 明泰科技股份有限公司

PART NAME: RF Antenna Assembly

PART NO.:

REVISION:

W. Y. P/NO.: C037-510694-A

REV.: X2

	MANUFACTURER SIGNATURE	CUSTOMER SIGNATURE
APPROVED BY :		
DATE :		

WHA YU GROUP

WHA YU INDUSTRIAL CO., LTD.(HEAD OFFICE)

譚裕實業股份有限公司

Address: No.326, Sec 2, Kung Tao 5 Road, Hsin Chu City, Taiwan, R.O.C.

Tel:+886-3-5714225(REP.)

Fax:+ 886-3-5713853 · + 886-3-5723600

TAI HWA ELECTRONIC CO., LTD. (CHINA)

台樺電業製品廠

Address: Pak Ho District, Hiu Street Town, Dong Guan City, Guangdong, China

Tel: + 86-769-5599375 · + 86-769-5912375

Fax: + 86-769-5599376

HUA HONG INTERNATIONAL LTD.

華弘國際有限公司

Rm.1103A,President Commercial Centre,608 Nathan Road,Mong Kok,Kowloon,Hong Kong

Tel: + 86-852-27712210

Fax: + 86-852-23843747

SHANGHAI HUA YU ELECTRONIC CO., LTD. (CHINA)

上海譚裕電子有限公司

Address:3586,Wai Qing Song Road, Qing Pu County, Shanghai China

Tel: + 86-21-59741348 · + 86-21-59744101~4

Fax: + 86-21-59741347

SU ZHOU AEON TECH CO., LTD. (CHINA)

蘇州華廣電通有限公司

Address:Limin North Road, LiLi Town,LiLi Industrial Park,LinHu Economic Zone

Wujiang City, Jiangu Province, China

Tel: + 86-512-63627980

Fax: + 86-512-63627981

Contents

<i>Item</i>	<i>Description</i>	<i>Page</i>
1.	天線規格表	1
2.	成品圖	2
3.	測試報告	3~5
4.	Cable 規格	6~7
5.	Connector 材質特性	8

REFERENCE ONLY

RF Antenna Cable Assembly

Specification

1. Electrical Properties :

- 1.1 Frequency Range..... 2.4GHz ~ 2.5GHz
- 1.2 Impedance 50 Nominal
- 1.3 VSWR 1.92 Max.
- 1.4 Return Loss..... -10 dB Maximum
- 1.5 Radiation Omni-directional
- 1.6 Gain(peak)..... 3dBi
- 1.7 Polarization..... Linear Vertical
- 1.8 Admitted Power..... 1W

2. Physical Properties :

- 2.1 Cable..... RG-178 Coaxial Cable
- 2.2 Antenna Cover..... TPE
- 2.3 Antenna Base..... PC
- 2.4 Antenna Base..... PBT
- 2.5 Operating Temp. -20 ~ +65
- 2.6 Storage Temp. -30 ~ +75
- 2.7 Color Black
- 2.8 Connector..... SMA Plug Reverse

CG-

REV	DATE	DESCRIPTION
X1	12/20-2005	New Issue
X2	3/2-2006	Add logo, modify conn material

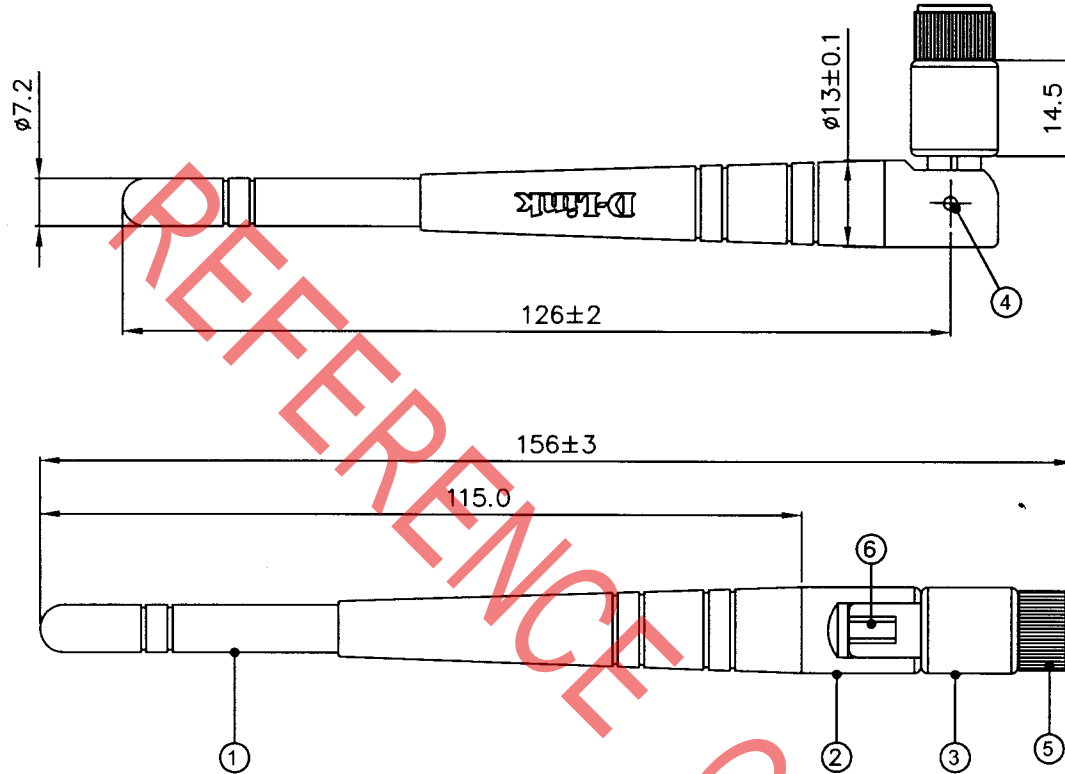

- 5/11 -
7-505924900017G (E13921) B

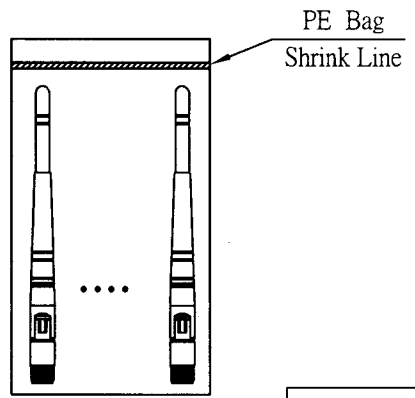

NO	DESCRIPTION	QTY	REMARK
6	Cable	RG-178 Cable	1
5	Connector	SMA Plug Reverse (POM)	1
4	Rivet	POM ; Black	2
3	Antenna Base	PBT ; Color : Black	1
2	Antenna Base	PC ; Color : Black	1
1	Antenna Body	TPE ; Color : Black	1

CUSTOMER'S SINGATURE	XX. ±5	APPROVED	CUSTOMER: 明泰科技股份有限公司 PART NO : PARTNAME: RF Antenna Assembly W.Y P/NO : C037-510694-A REV UNIT FILE : X2 m/m SHEET : 1/1
	X. ±3.0	CHECKED	
	.X ±1.0	DRAWING	
	.XX ±0.5		
	.XXX ±0.1		



Wha Yu
INDUSTRIAL CO.,LTD.
譚裕實業股份有限公司

THIS DRAWING, AND ITS INHERANT DESIGN CONCEPTS, ARE THE PROPERTY OF WHA YU AND AS SUCH MAY NOT BE COPIED, REPRODUCED, OR GIVEN TO THIRD PARTIES WITHOUT THE WRITTEN CONSENT OF WHA YU.



RF Antenna Assembly
P/NO : C037-510694-A SPEC : 2.4GHz

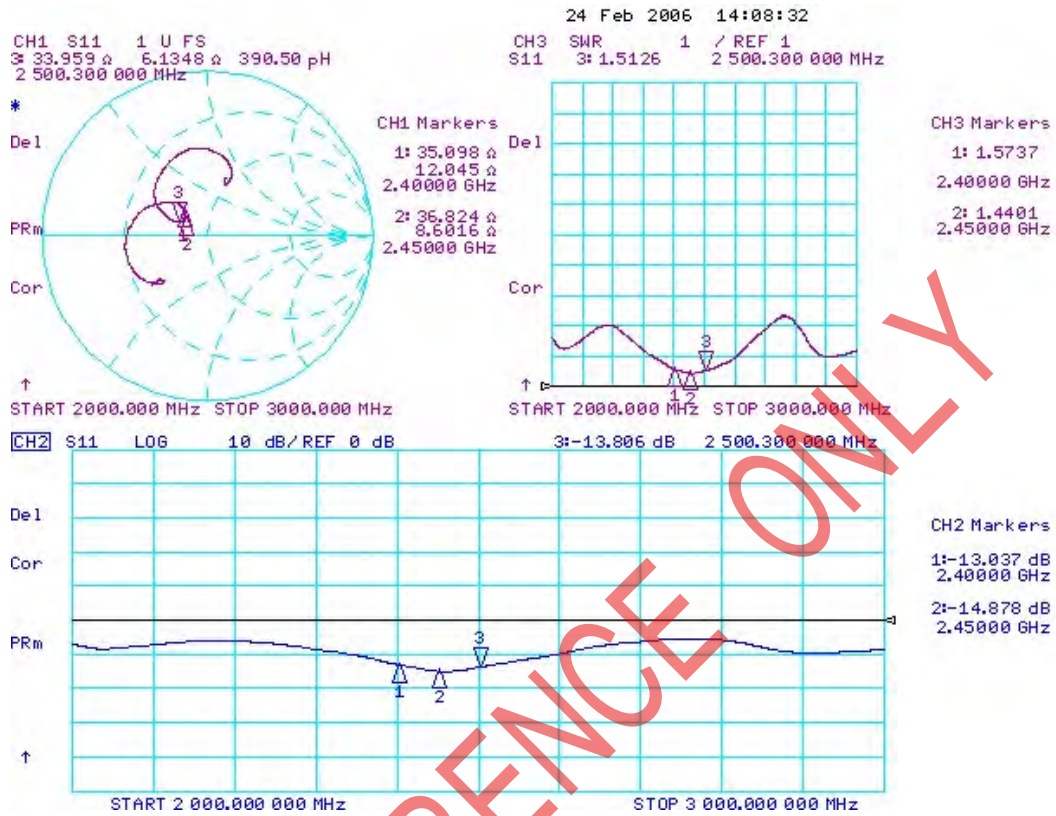

REFERENCE ONLY

3/2/2006

Far-field amplitude of C037-510694-A-H.nsi

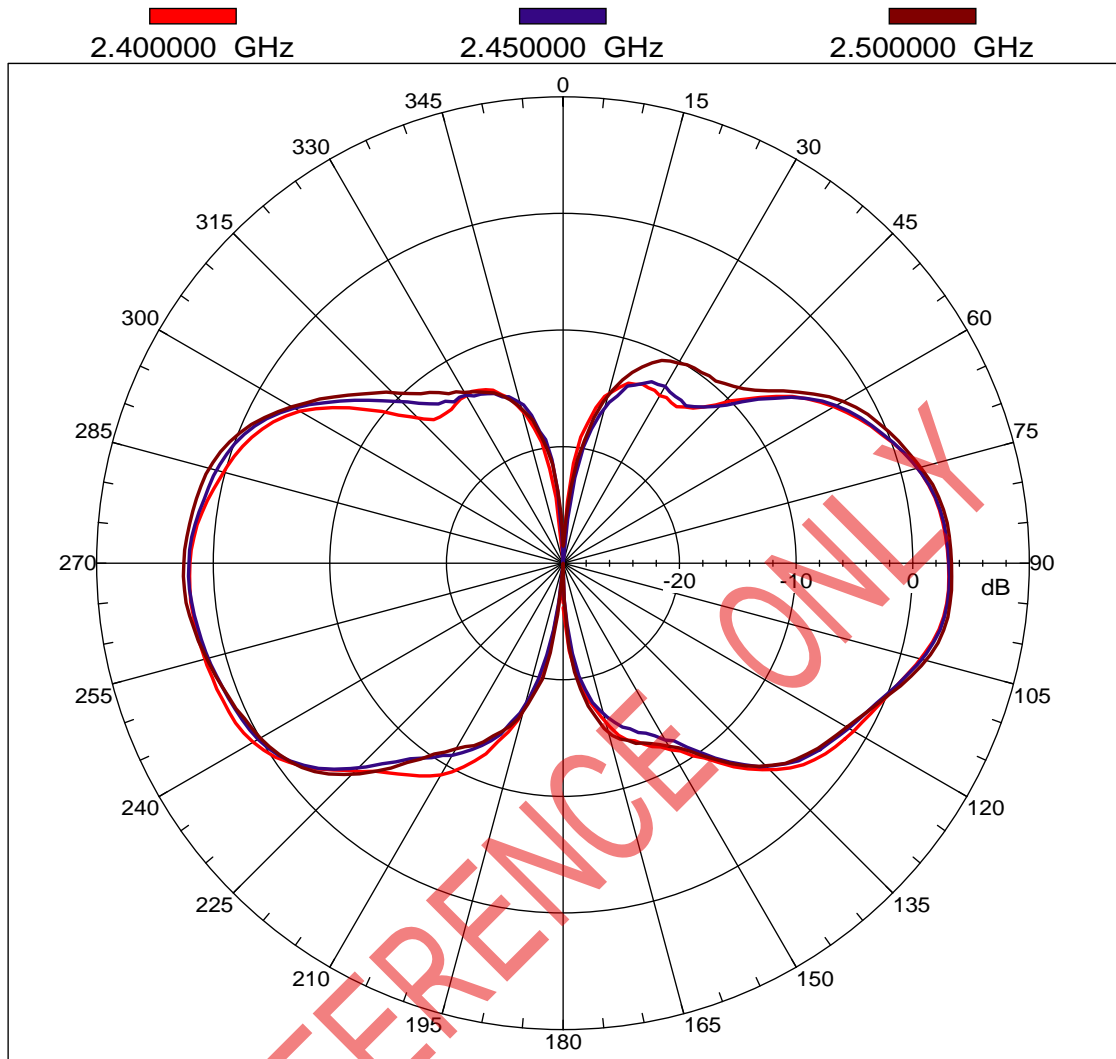

3/2/2006

Far-field amplitude of C037-510694-A-V.nsi

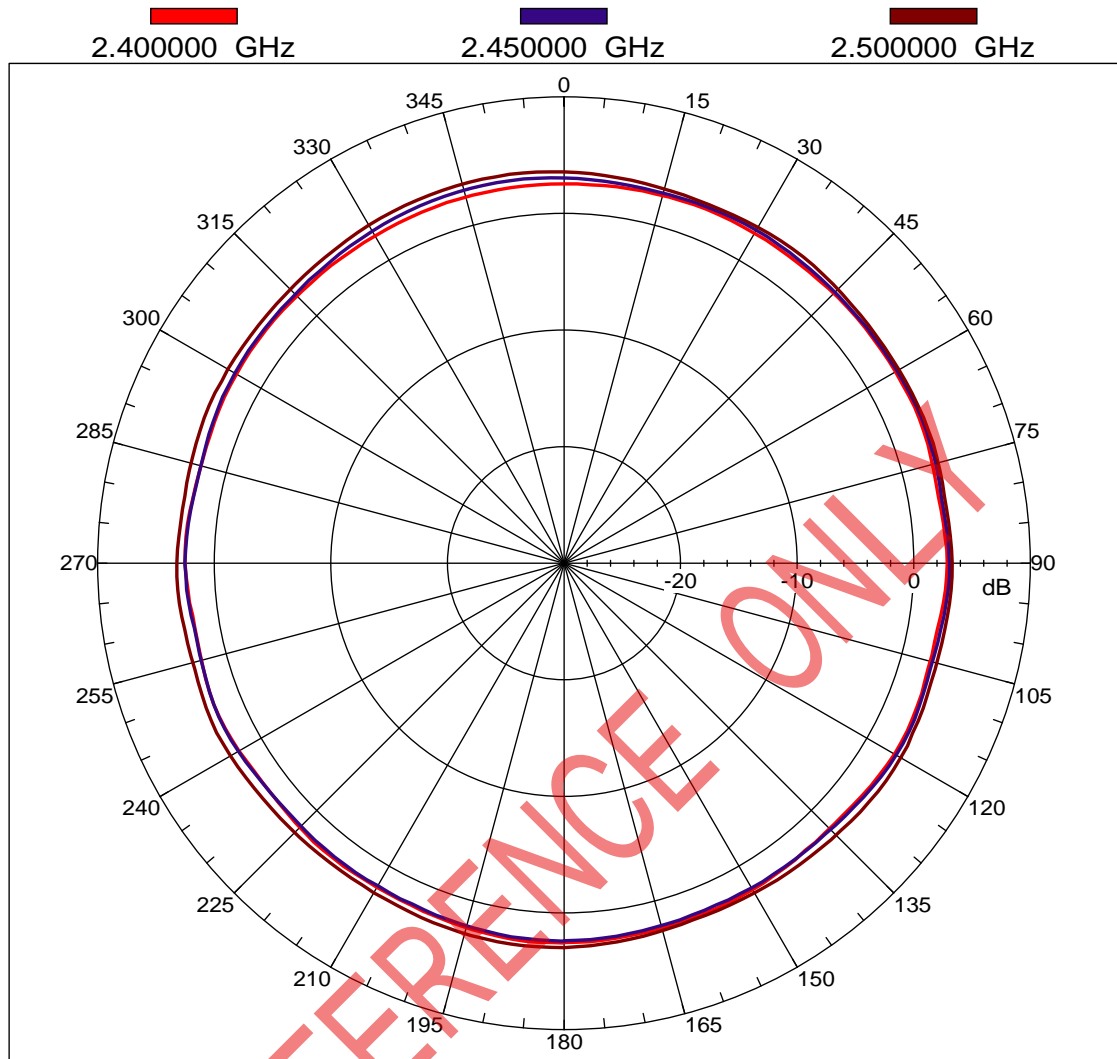

3/2/2006

PRODUCT SPECIFICATION	ISSUED DATE	July.12, 2000	PAGE	1/2
	REVISION		REVISION NO.	

PRODUCT NAME : Coaxial Cable
RATING : -55°C ~ 200°C
ITEM : RG 178 B/U

誠謙

No.	Revised Date	Revised Details	Page	Report

REPORTED BY :

APPROVED BY :



Q.C Engineer HOON LEE

Q.C Manager SOON-MOK SHIN

PRODUCT SPECIFICATION	ISSUED DATE	July.12, 2000	PAGE	2/2
	REVISION		REVISION NO.	

1. APPLICATIONS

This specification is applies to Coaxial Cable manufactured by the YOUNG CHANG SILICONE CO.,LTD

2. STRUCTURE

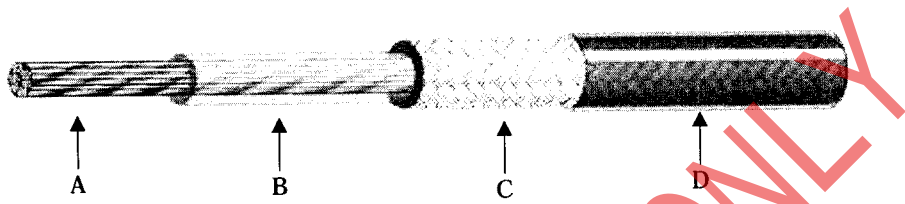

- A. Conductor: SCCS
- B. Insulation : PFA
- C. Shield : Silver-Plated Copper
- D. Jacket : FEP

3. DIMENSION

Conductor (SCCS)			Insulation		Shield		Jacket	
Structure	Cross sectional area	Diameter	Material	Diameter	Material	Diameter	Material	Diameter
Q'ty/mmφ	mm ² (SQ)	mmφ		mmφ		mmφ		mmφ
7/0.102	0.06	0.30	PFA	0.84±0.05	SPC	1.25	FEP	1.80±0.10

4. ELECTRIC PROPERTIES

Impedance	Capacitance	Maximum Attenuation (dB/100ft)				Dielectric Sterngth
		100Mhz	400Mhz	1Ghz	3Ghz	
ohms	pF/ft(Max)					V/1min
50 ± 2	32	16.0	33.0	52.0	94.0	2000



華裕實業股份有限公司

WHA YU INDUSTRIAL CO., LTD

Connector 材質證明書

華裕料號 Whayu P/N	100-2001164-AZ	產品名稱 Product Name	Big SMA Plug Reverse Straight For RG-178
-------------------	----------------	----------------------	--

結構圖面

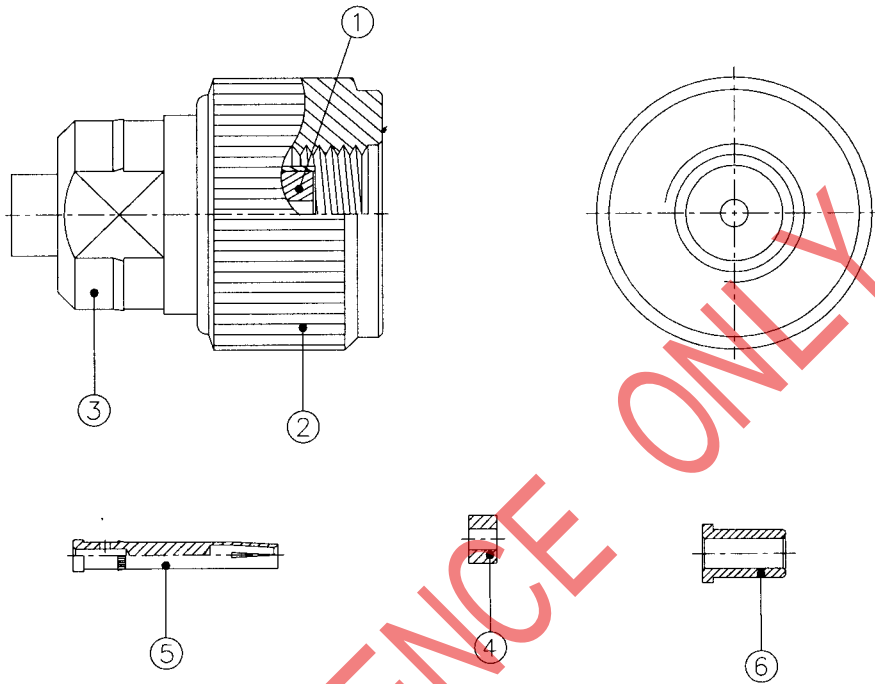

材質成份

表面處理

No.	名稱	材質	材質成份					表面處理
			Cu	Pb	Fe	Fe+Sn	Zn	
1	絕緣體	Teflon	PTFE					N/A
2	外殼	POM	POM					黑色
3	本體	Brass	Cu	Pb	Fe	Fe+Sn	Zn	鍍鎳
4	絕緣體	Teflon	PTFE					N/A
5	中心針	Phos. Bronze	Cu	Sn	P	Zn	Pb	鍍金
6	尾管	Brass	Cu	Pb	Fe	Fe+Sn	Zn	鍍鎳

Remark :

