



A D T

FCC TEST REPORT

REPORT NO.: RF120703C19 R1
MODEL NO.: DAP-1320
FCC ID: KA2AP1320A1
RECEIVED: Jul. 03, 2012
TESTED: Jul. 10 ~ Jul. 19, 2012
ISSUED: Aug. 16, 2012

APPLICANT: D-Link Corporation

ADDRESS: 17595 Mt. Hermann, Fountain Valley, CA 92708,
U.S.A

ISSUED BY: Bureau Veritas Consumer Products Services
(H.K.) Ltd., Taoyuan Branch

LAB ADDRESS: No. 47, 14th Ling, Chia Pau Vil., Lin Kou Dist.,
New Taipei City, Taiwan, R.O.C.

TEST LOCATION: No. 19, Hwa Ya 2nd Rd, Wen Hwa Tsuen, Kwei
Shan Hsiang, Taoyuan Hsien 333, Taiwan, R.O.C.

This report should not be used by the client to claim product certification, approval, or endorsement by TAF or any government agencies.



This report is for your exclusive use. Any copying or replication of this report to or for any other person or entity, or use of our name or trademark, is permitted only with our prior written permission. This report sets forth our findings solely with respect to the test samples identified herein. The results set forth in this report are not indicative or representative of the quality or characteristics of the lot from which a test sample was taken or any similar or identical product unless specifically and expressly noted. Our report includes all of the tests requested by you and the results thereof based upon the information that you provided to us. You have 60 days from date of issuance of this report to notify us of any material error or omission caused by our negligence, provided, however, that such notice shall be in writing and shall specifically address the issue you wish to raise. A failure to raise such issue within the prescribed time shall constitute your unqualified acceptance of the completeness of this report, the tests conducted and the correctness of the report contents. Unless specific mention, the uncertainty of measurement has been explicitly taken into account to declare the compliance or non-compliance to the specification.



A D T

TABLE OF CONTENTS

| | |
|---|----|
| RELEASE CONTROL RECORD | 4 |
| 1. CERTIFICATION..... | 5 |
| 2. SUMMARY OF TEST RESULTS | 6 |
| 2.1 MEASUREMENT UNCERTAINTY | 6 |
| 3. GENERAL INFORMATION..... | 7 |
| 3.1 GENERAL DESCRIPTION OF EUT..... | 7 |
| 3.2 DESCRIPTION OF TEST MODES..... | 8 |
| 3.2.1 TEST MODE APPLICABILITY AND TESTED CHANNEL DETAIL..... | 9 |
| 3.3 DESCRIPTION OF SUPPORT UNITS..... | 11 |
| 3.3.1 CONFIGURATION OF SYSTEM UNDER TEST..... | 11 |
| 3.4 GENERAL DESCRIPTION OF APPLIED STANDARDS..... | 11 |
| 4. TEST TYPES AND RESULTS | 12 |
| 4.1 RADIATED EMISSION AND BANDEDGE MEASUREMENT | 12 |
| 4.1.1 LIMITS OF RADIATED EMISSION AND BANDEDGE MEASUREMENT..... | 12 |
| 4.1.2 TEST INSTRUMENTS..... | 13 |
| 4.1.3 TEST PROCEDURES | 14 |
| 4.1.4 DEVIATION FROM TEST STANDARD | 14 |
| 4.1.5 TEST SETUP..... | 15 |
| 4.1.6 EUT OPERATING CONDITIONS | 15 |
| 4.1.7 TEST RESULTS | 16 |
| 4.2 CONDUCTED EMISSION MEASUREMENT | 29 |
| 4.2.1 LIMITS OF CONDUCTED EMISSION MEASUREMENT | 29 |
| 4.2.2 TEST INSTRUMENTS..... | 29 |
| 4.2.3 TEST PROCEDURES | 30 |
| 4.2.4 DEVIATION FROM TEST STANDARD | 30 |
| 4.2.5 TEST SETUP..... | 30 |
| 4.2.6 EUT OPERATING CONDITIONS | 30 |
| 4.2.7 TEST RESULTS | 32 |
| 4.3 6dB BANDWIDTH MEASUREMENT | 34 |
| 4.3.1 LIMITS OF 6dB BANDWIDTH MEASUREMENT..... | 34 |
| 4.3.2 TEST SETUP..... | 34 |
| 4.3.3 TEST INSTRUMENTS..... | 34 |
| 4.3.4 TEST PROCEDURE..... | 34 |
| 4.3.5 DEVIATION FROM TEST STANDARD | 34 |
| 4.3.6 EUT OPERATING CONDITIONS..... | 34 |
| 4.3.7 TEST RESULTS | 35 |
| 4.4 CONDUCTED OUTPUT POWER | 36 |
| 4.4.1 LIMITS OF CONDUCTED OUTPUT POWER MEASUREMENT | 36 |
| 4.4.2 TEST SETUP..... | 36 |
| 4.4.3 TEST INSTRUMENTS..... | 36 |
| 4.4.4 TEST PROCEDURES | 36 |
| 4.4.5 DEVIATION FROM TEST STANDARD | 36 |
| 4.4.6 EUT OPERATING CONDITIONS..... | 36 |
| 4.4.7 TEST RESULTS | 37 |
| 4.5 POWER SPECTRAL DENSITY MEASUREMENT..... | 38 |
| 4.5.1 LIMITS OF POWER SPECTRAL DENSITY MEASUREMENT..... | 38 |



A D T

| | | |
|-------|---|----|
| 4.5.2 | TEST SETUP | 38 |
| 4.5.3 | TEST INSTRUMENTS..... | 38 |
| 4.5.4 | TEST PROCEDURE..... | 38 |
| 4.5.5 | DEVIATION FROM TEST STANDARD | 38 |
| 4.5.6 | EUT OPERATING CONDITION | 38 |
| 4.5.7 | TEST RESULTS | 39 |
| 4.6 | CONDUCTED OUT OF BAND EMISSION MEASUREMENT | 41 |
| 4.6.1 | LIMITS OF CONDUCTED OUT OF BAND EMISSION MEASUREMENT..... | 41 |
| 4.6.2 | TEST SETUP | 41 |
| 4.6.3 | TEST INSTRUMENTS..... | 41 |
| 4.6.4 | TEST PROCEDURE..... | 41 |
| 4.6.5 | DEVIATION FROM TEST STANDARD | 42 |
| 4.6.6 | EUT OPERATING CONDITION | 42 |
| 4.6.7 | TEST RESULTS | 42 |
| 5. | PHOTOGRAPHS OF THE TEST CONFIGURATION | 47 |
| 6. | INFORMATION ON THE TESTING LABORATORIES..... | 48 |
| 7. | APPENDIX A - MODIFICATIONS RECORDERS FOR ENGINEERING CHANGES TO THE EUT BY THE LAB..... | 49 |



A D T

RELEASE CONTROL RECORD

| ISSUE NO. | REASON FOR CHANGE | DATE ISSUED |
|----------------|----------------------|---------------|
| RF120703C19 | Original release | Jul. 23, 2012 |
| RF120703C19 R1 | Revised product name | Aug. 16, 2012 |



1. CERTIFICATION

PRODUCT: Wireless Range Extender N300
MODEL NO.: DAP-1320
BRAND: D-Link
APPLICANT: D-Link Corporation
TESTED: Jul. 10 ~ Jul. 19, 2012
TEST SAMPLE: ENGINEERING SAMPLE
STANDARDS: **FCC Part 15, Subpart C (Section 15.247)**
ANSI C63.10-2009

The above equipment (model: DAP-1320) has been tested by **Bureau Veritas Consumer Products Services (H.K.) Ltd., Taoyuan Branch**, and found compliance with the requirement of the above standards. The test record, data evaluation & Equipment Under Test (EUT) configurations represented herein are true and accurate accounts of the measurements of the sample's EMC characteristics under the conditions specified in this report.

PREPARED BY : Ivy Lin , DATE : Aug. 16, 2012
Ivy Lin / Specialist

APPROVED BY : Gary Chang , DATE : Aug. 16, 2012
Gary Chang / Technical Manager

2. SUMMARY OF TEST RESULTS

The EUT has been tested according to the following specifications:

| APPLIED STANDARD: FCC PART 15, SUBPART C (SECTION 15.247) | | | |
|---|-----------------------------|--------|---|
| STANDARD SECTION | TEST TYPE | RESULT | REMARK |
| 15.207 | AC Power Conducted Emission | PASS | Meet the requirement of limit. Minimum passing margin is -2.01dB at 0.17734MHz. |
| 15.247(d) 15.209 | Radiated Emissions | PASS | Meet the requirement of limit. Minimum passing margin is -1.0dB at 4874.00MHz, 4924.00MHz . |
| 15.247(d) | Band Edge Measurement | PASS | Meet the requirement of limit. |
| 15.247(a)(2) | 6dB bandwidth | PASS | Meet the requirement of limit. |
| 15.247(b) | Conducted power | PASS | Meet the requirement of limit. |
| 15.247(e) | Power Spectral Density | PASS | Meet the requirement of limit. |
| 15.203 | Antenna Requirement | PASS | Antenna connector is UFL not a standard connector. |

2.1 MEASUREMENT UNCERTAINTY

Where relevant, the following measurement uncertainty levels have been estimated for tests performed on the EUT as specified in CISPR 16-4-2:

| MEASUREMENT | FREQUENCY | UNCERTAINTY |
|---------------------|-----------------|-------------|
| Conducted emissions | 150kHz~30MHz | 2.44 dB |
| Radiated emissions | 30MHz ~ 200MHz | 2.93 dB |
| | 200MHz ~1000MHz | 2.95 dB |
| | 1GHz ~ 18GHz | 2.26 dB |
| | 18GHz ~ 40GHz | 1.94 dB |

This uncertainty represents an expanded uncertainty expressed at approximately the 95% confidence level using a coverage factor of $k = 2$.



3. GENERAL INFORMATION

3.1 GENERAL DESCRIPTION OF EUT

| | |
|------------------------------|--|
| EUT | Wireless Range Extender N300 |
| MODEL NO. | DAP-1320 |
| POWER SUPPLY | 100-240Vac |
| MODULATION TYPE | CCK, DQPSK, DBPSK for DSSS 64QAM, 16QAM, QPSK, BPSK for OFDM |
| MODULATION TECHNOLOGY | DSSS, OFDM |
| TRANSFER RATE | 802.11b:11.0/ 5.5/ 2.0/ 1.0Mbps 802.11g: 54.0/ 48.0/ 36.0/ 24.0/ 18.0/ 12.0/ 9.0/ 6.0Mbps 802.11n: up to 300.0Mbps |
| OPERATING FREQUENCY | 2412 ~ 2462MHz |
| NUMBER OF CHANNEL | 11 for 802.11b, 802.11g, 802.11n (20MHz) 7 for 802.11n (40MHz) |
| OUTPUT POWER | 804.52mW |
| ANTENNA TYPE | Printed antenna with 0dBi gain |
| ANTENNA CONNECTOR | UFL |
| DATA CABLE | N/A |
| I/O PORTS | N/A |
| ACCESSORY DEVICES | N/A |

NOTE:

1. The EUT incorporates a MIMO function. Physically, the EUT provides two completed transmitters and two receivers.

| MODULATION MODE | TX FUNCTION |
|------------------------|--------------------|
| 802.11b | 2TX |
| 802.11g | 2TX |
| 802.11n (20MHz) | 2TX |
| 802.11n (40MHz) | 2TX |

2. The above EUT information is declared by manufacturer and for more detailed features description, please refer to the manufacturer's specifications or user's manual.

3.2 DESCRIPTION OF TEST MODES

11 channels are provided for 802.11b, 802.11g and 802.11n (20MHz):

| CHANNEL | FREQUENCY | CHANNEL | FREQUENCY |
|---------|-----------|---------|-----------|
| 1 | 2412MHz | 7 | 2442MHz |
| 2 | 2417MHz | 8 | 2447MHz |
| 3 | 2422MHz | 9 | 2452MHz |
| 4 | 2427MHz | 10 | 2457MHz |
| 5 | 2432MHz | 11 | 2462MHz |
| 6 | 2437MHz | | |

7 channels are provided for 802.11n (40MHz):

| CHANNEL | FREQUENCY | CHANNEL | FREQUENCY |
|---------|-----------|---------|-----------|
| 3 | 2422MHz | 7 | 2442MHz |
| 4 | 2427MHz | 8 | 2447MHz |
| 5 | 2432MHz | 9 | 2452MHz |
| 6 | 2437MHz | | |



3.2.1 TEST MODE APPLICABILITY AND TESTED CHANNEL DETAIL

| EUT CONFIGURE MODE | APPLICABLE TO | | | | DESCRIPTION |
|--------------------|---------------|-------|-----|------|-------------|
| | RE≥1G | RE<1G | PLC | APCM | |
| - | √ | √ | √ | √ | - |

Where **RE≥1G**: Radiated Emission above 1GHz **RE<1G**: Radiated Emission below 1GHz
PLC: Power Line Conducted Emission **APCM**: Antenna Port Conducted Measurement

NOTE:
The EUT had been pre-tested on the positioned of each 3 axis. The worst case was found when positioned on X-plane.

RADIATED EMISSION TEST (ABOVE 1GHz):

- Pre-Scan has been conducted to determine the worst-case mode from all possible combinations between available modulations, data rates and antenna ports (if EUT with antenna diversity architecture).
- Following channel(s) was (were) selected for the final test as listed below.

| EUT CONFIGURE MODE | MODE | AVAILABLE CHANNEL | TESTED CHANNEL | MODULATION TECHNOLOGY | MODULATION TYPE | DATA RATE (Mbps) |
|--------------------|-----------------|-------------------|----------------|-----------------------|-----------------|------------------|
| - | 802.11b | 1 to 11 | 1, 6, 11 | DSSS | DBPSK | 1.0 |
| - | 802.11g | 1 to 11 | 1, 6, 11 | OFDM | BPSK | 6.0 |
| - | 802.11n (20MHz) | 1 to 11 | 1, 6, 11 | OFDM | BPSK | 7.2 |
| - | 802.11n (40MHz) | 3 to 9 | 3, 6, 9 | OFDM | BPSK | 15.0 |

RADIATED EMISSION TEST (BELOW 1GHz):

- Pre-Scan has been conducted to determine the worst-case mode from all possible combinations between available modulations, data rates and antenna ports (if EUT with antenna diversity architecture).
- Following channel(s) was (were) selected for the final test as listed below.

| EUT CONFIGURE MODE | MODE | AVAILABLE CHANNEL | TESTED CHANNEL | MODULATION TECHNOLOGY | MODULATION TYPE | DATA RATE (Mbps) |
|--------------------|-----------------|-------------------|----------------|-----------------------|-----------------|------------------|
| - | 802.11n (20MHz) | 1 to 11 | 6 | OFDM | BPSK | 7.2 |

POWER LINE CONDUCTED EMISSION TEST:

- Pre-Scan has been conducted to determine the worst-case mode from all possible combinations between available modulations, data rates and antenna ports (if EUT with antenna diversity architecture).
- Following channel(s) was (were) selected for the final test as listed below.

| EUT CONFIGURE MODE | MODE | AVAILABLE CHANNEL | TESTED CHANNEL | MODULATION TECHNOLOGY | MODULATION TYPE | DATA RATE (Mbps) |
|--------------------|-----------------|-------------------|----------------|-----------------------|-----------------|------------------|
| - | 802.11n (20MHz) | 1 to 11 | 6 | OFDM | BPSK | 7.2 |



BANDEDGE MEASUREMENT:

- Pre-Scan has been conducted to determine the worst-case mode from all possible combinations between available modulations, data rates and antenna ports (if EUT with antenna diversity architecture).
- Following channel(s) was (were) selected for the final test as listed below.

| EUT CONFIGURE MODE | MODE | AVAILABLE CHANNEL | TESTED CHANNEL | MODULATION TECHNOLOGY | MODULATION TYPE | DATA RATE (Mbps) |
|--------------------|-----------------|-------------------|----------------|-----------------------|-----------------|------------------|
| - | 802.11b | 1 to 11 | 1, 11 | DSSS | DBPSK | 1.0 |
| - | 802.11g | 1 to 11 | 1, 11 | OFDM | BPSK | 6.0 |
| - | 802.11n (20MHz) | 1 to 11 | 1, 11 | OFDM | BPSK | 7.2 |
| - | 802.11n (40MHz) | 3 to 9 | 3, 9 | OFDM | BPSK | 15.0 |

ANTENNA PORT CONDUCTED MEASUREMENT:

- This item includes all test value of each mode, but only includes spectrum plot of worst value of each mode.
- Pre-Scan has been conducted to determine the worst-case mode from all possible combinations between available modulations, data rates and antenna ports (if EUT with antenna diversity architecture).
- Following channel(s) was (were) selected for the final test as listed below.

| EUT CONFIGURE MODE | MODE | AVAILABLE CHANNEL | TESTED CHANNEL | MODULATION TECHNOLOGY | MODULATION TYPE | DATA RATE (Mbps) |
|--------------------|-----------------|-------------------|----------------|-----------------------|-----------------|------------------|
| - | 802.11b | 1 to 11 | 1, 6, 11 | DSSS | DBPSK | 1.0 |
| - | 802.11g | 1 to 11 | 1, 6, 11 | OFDM | BPSK | 6.0 |
| - | 802.11n (20MHz) | 1 to 11 | 1, 6, 11 | OFDM | BPSK | 7.2 |
| - | 802.11n (40MHz) | 3 to 9 | 3, 6, 9 | OFDM | BPSK | 15.0 |

TEST CONDITION:

| APPLICABLE TO | ENVIRONMENTAL CONDITIONS | INPUT POWER | TESTED BY |
|---------------|--------------------------|--------------|------------------------------------|
| RE≥1G | 25deg. C, 65%RH | 120Vac, 60Hz | Sun Lin, Anderson Hong, Aska Huang |
| RE<1G | 25deg. C, 65%RH | 120Vac, 60Hz | Anderson Hong |
| PLC | 25deg. C, 65%RH | 120Vac, 60Hz | Hero Su |
| APCM | 25deg. C, 65%RH | 120Vac, 60Hz | Sun Lin |

3.3 DESCRIPTION OF SUPPORT UNITS

The EUT has been tested as an independent unit.

3.3.1 CONFIGURATION OF SYSTEM UNDER TEST

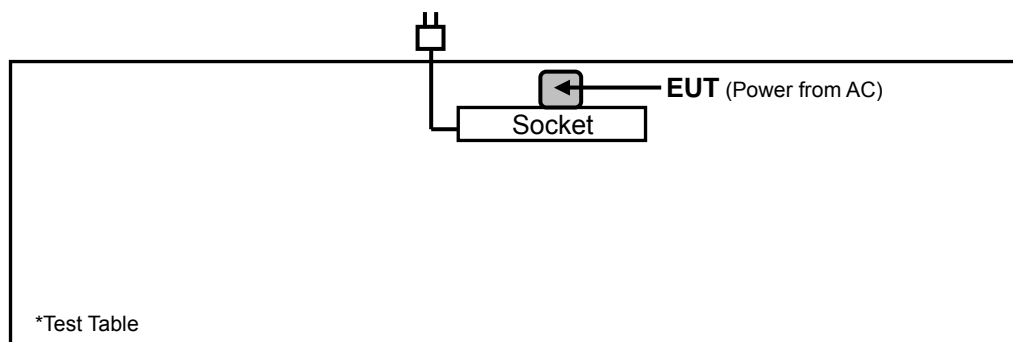

3.4 GENERAL DESCRIPTION OF APPLIED STANDARDS

The EUT is a RF Product. According to the specifications of the manufacturer, it must comply with the requirements of the following standards:

FCC Part 15, Subpart C (15.247)
558074 D01 DTS Meas Guidance v01
ANSI C63.10-2009

All test items have been performed and recorded as per the above standards.

NOTE: The EUT is also considered as a kind of computer peripheral, because the connection to computer is necessary for typical use. It has been verified to comply with the requirements of FCC Part 15, Subpart B, Class B (DoC). The test report has been issued separately.

4. TEST TYPES AND RESULTS

4.1 RADIATED EMISSION AND BANDEDGE MEASUREMENT

4.1.1 LIMITS OF RADIATED EMISSION AND BANDEDGE MEASUREMENT

Radiated emissions which fall in the restricted bands must comply with the radiated emission limits specified as below table. Other emissions shall be at least 20dB below the highest level of the desired power:

| FREQUENCIES (MHz) | FIELD STRENGTH (microvolts/meter) | MEASUREMENT DISTANCE (meters) |
|-------------------|-----------------------------------|-------------------------------|
| 0.009 ~ 0.490 | 2400/F(kHz) | 300 |
| 0.490 ~ 1.705 | 24000/F(kHz) | 30 |
| 1.705 ~ 30.0 | 30 | 30 |
| 30 ~ 88 | 100 | 3 |
| 88 ~ 216 | 150 | 3 |
| 216 ~ 960 | 200 | 3 |
| Above 960 | 500 | 3 |

NOTE:

1. The lower limit shall apply at the transition frequencies.
2. Emission level (dBuV/m) = 20 log Emission level (uV/m).
3. For frequencies above 1000MHz, the field strength limits are based on average detector, however, the peak field strength of any emission shall not exceed the maximum permitted average limits, specified above by more than 20dB under any condition of modulation.

4.1.2 TEST INSTRUMENTS

| DESCRIPTION & MANUFACTURER | MODEL NO. | SERIAL NO. | DATE OF CALIBRATION | DUE DATE OF CALIBRATION |
|--|------------------------------|----------------------|---------------------|-------------------------|
| Test Receiver ROHDE & SCHWARZ | ESCI | 100744 | Apr. 19, 2012 | Apr. 18, 2013 |
| Spectrum Analyzer ROHDE & SCHWARZ | FSP40 | 100269 | Jan. 30, 2012 | Jan. 29, 2013 |
| BILOG Antenna SCHWARZBECK | VULB9168 | 9168-156 | Apr. 03, 2012 | Apr. 02, 2013 |
| HORN Antenna SCHWARZBECK | BBHA 9120 D | 9120D-563 | Sep. 06, 2011 | Sep. 05, 2012 |
| HORN Antenna SCHWARZBECK | BBHA 9170 | 148 | Jul. 11, 2012 | Jul. 10, 2013 |
| Loop Antenna | HFH2-Z2 | 100070 | Jan. 31, 2012 | Jan. 30, 2014 |
| Preamplifier Agilent | 8449B | 3008A01911 | Oct. 29, 2011 | Oct. 28, 2012 |
| Preamplifier Agilent | 8447D | 2944A10638 | Oct. 29, 2011 | Oct. 28, 2012 |
| RF signal cable HUBER+SUHNNER | SUCOFLEX 104 | 295013/4 283403/4 | Aug. 19, 2011 | Aug. 18, 2012 |
| RF signal cable Worken | 8D-FB | Cable-HYCH9-01 | Aug. 13, 2011 | Aug. 12, 2012 |
| Software | ADT_Radiated_ V7.6.15.9.2 | NA | NA | NA |
| Antenna Tower EMCO | 2070/2080 | 512.835.4684 | NA | NA |
| Turn Table EMCO | 2087-2.03 | NA | NA | NA |
| Antenna Tower & Turn Table Controller EMCO | 2090 | NA | NA | NA |

- NOTE:**
1. The calibration interval of the above test instruments is 12 months and the calibrations are traceable to NML/ROC and NIST/USA.
 2. The calibration interval of the loop antenna is 24 months and the calibrations are traceable to NML/ROC and NIST/USA.
 3. The test was performed in HwaYa Chamber 9.
 4. The horn antenna and HP preamplifier (model: 8449B) are used only for the measurement of emission frequency above 1GHz if tested.
 5. The FCC Site Registration No. is 460141.
 6. The IC Site Registration No. is IC 7450F-4.

4.1.3 TEST PROCEDURES

- a. The EUT was placed on the top of a rotating table 0.8 meters above the ground at a 3 meters semi-anechoic chamber. The table was rotated 360 degrees to determine the position of the highest radiation.
- b. The EUT was set 3 meters away from the interference-receiving antenna, which was mounted on the top of a variable-height antenna tower.
- c. Height of receiving antenna is varied from one meter to four meters above the ground to determine the maximum value of the field strength. Both horizontal and vertical polarizations of the antenna are set to make the measurement.
- d. For each suspected emission, the EUT was arranged to its worst case and then the antenna was tuned to heights from 1 meter to 4 meters and the rotatable table was turned from 0 degrees to 360 degrees to find the maximum reading.
- e. The test-receiver system was set to Peak Detect Function and Specified Bandwidth with Maximum Hold Mode.
- f. If the emission level of the EUT in peak mode was lower than the limit specified, then testing could be stopped and the peak values of the EUT would be reported. Otherwise the emissions would be re-tested one by one using peak, quasi-peak or average method as specified and then reported in a data sheet.

NOTE:

1. The resolution bandwidth and video bandwidth of test receiver/spectrum analyzer is 120kHz for Quasi-peak detection at frequency below 1GHz.
2. The resolution bandwidth of test receiver/spectrum analyzer is 1MHz and video bandwidth is 3MHz for Peak detection at frequency above 1GHz.
3. The resolution bandwidth of test receiver/spectrum analyzer is 1MHz and the video bandwidth is 10Hz for Average detection (AV) at frequency above 1GHz.
4. All modes of operation were investigated and the worst-case emissions are reported.

4.1.4 DEVIATION FROM TEST STANDARD

No deviation.

4.1.5 TEST SETUP

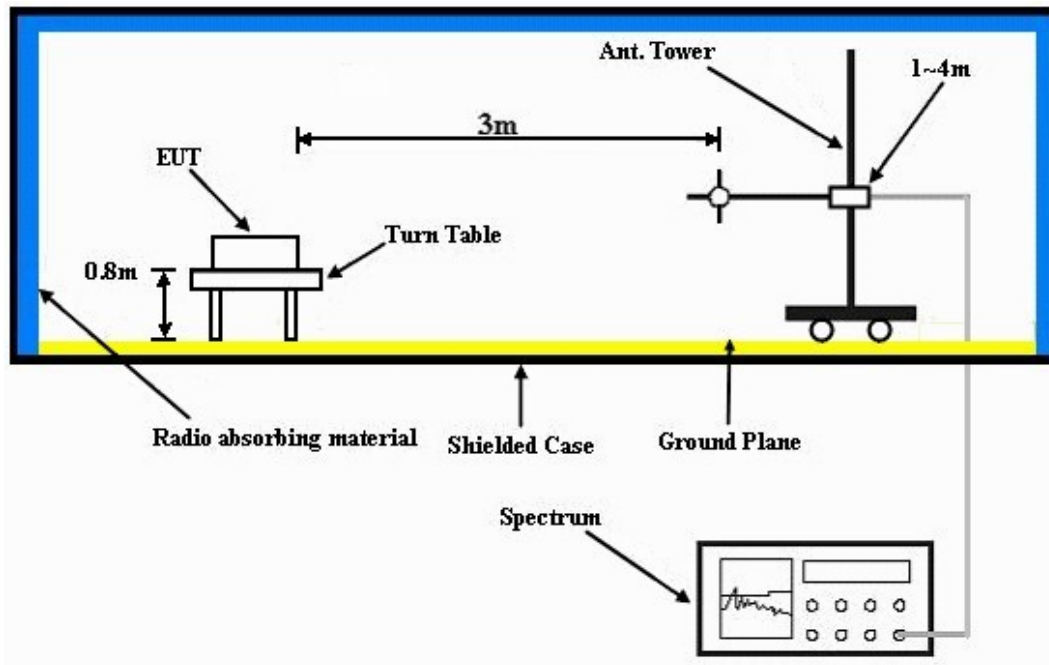

For the actual test configuration, please refer to the attached file (Test Setup Photo).

4.1.6 EUT OPERATING CONDITIONS

Set the EUT under transmission condition continuously at specific channel frequency.



A D T

4.1.7 TEST RESULTS

802.11b

| EUT TEST CONDITION | | MEASUREMENT DETAIL | |
|--------------------------|-----------------|--------------------|---------------------------|
| CHANNEL | Channel 1 | FREQUENCY RANGE | 1 ~ 25GHz |
| INPUT POWER (SYSTEM) | 120Vac, 60Hz | DETECTOR FUNCTION | Peak (PK) Average (AV) |
| ENVIRONMENTAL CONDITIONS | 25deg. C, 68%RH | TESTED BY | Sun Lin, Anderson Hong |

| ANTENNA POLARITY & TEST DISTANCE: HORIZONTAL AT 3 M | | | | | | | | |
|---|-------------|-------------------------|----------------|-------------|--------------------|----------------------|------------------|--------------------------|
| NO. | FREQ. (MHz) | EMISSION LEVEL (dBuV/m) | LIMIT (dBuV/m) | MARGIN (dB) | ANTENNA HEIGHT (m) | TABLE ANGLE (Degree) | RAW VALUE (dBuV) | CORRECTION FACTOR (dB/m) |
| 1 | 2390.00 | 63.1 PK | 74.0 | -10.9 | 1.81 H | 296 | 31.70 | 31.40 |
| 2 | 2390.00 | 45.7 AV | 54.0 | -8.3 | 1.81 H | 296 | 14.30 | 31.40 |
| 3 | *2412.00 | 104.4 PK | | | 1.81 H | 296 | 73.00 | 31.40 |
| 4 | *2412.00 | 100.5 AV | | | 1.81 H | 296 | 69.10 | 31.40 |
| 5 | 4824.00 | 54.3 PK | 74.0 | -19.7 | 1.32 H | 329 | 16.80 | 37.50 |
| 6 | 4824.00 | 52.4 AV | 54.0 | -1.6 | 1.32 H | 329 | 14.90 | 37.50 |
| ANTENNA POLARITY & TEST DISTANCE: VERTICAL AT 3 M | | | | | | | | |
| NO. | FREQ. (MHz) | EMISSION LEVEL (dBuV/m) | LIMIT (dBuV/m) | MARGIN (dB) | ANTENNA HEIGHT (m) | TABLE ANGLE (Degree) | RAW VALUE (dBuV) | CORRECTION FACTOR (dB/m) |
| 1 | 2390.00 | 61.5 PK | 74.0 | -12.5 | 1.00 V | 19 | 30.10 | 31.40 |
| 2 | 2390.00 | 44.9 AV | 54.0 | -9.1 | 1.00 V | 19 | 13.50 | 31.40 |
| 3 | *2412.00 | 100.8 PK | | | 1.00 V | 19 | 69.40 | 31.40 |
| 4 | *2412.00 | 97.0 AV | | | 1.00 V | 19 | 65.60 | 31.40 |
| 5 | 4824.00 | 53.1 PK | 74.0 | -20.9 | 1.14 V | 5 | 15.60 | 37.50 |
| 6 | 4824.00 | 49.0 AV | 54.0 | -5.0 | 1.14 V | 5 | 11.50 | 37.50 |

REMARKS:

1. Emission level (dBuV/m) = Raw Value (dBuV) + Correction Factor (dB/m).
2. Correction Factor (dB/m) = Antenna Factor (dB/m) + Cable Factor (dB).
3. The other emission levels were very low against the limit.
4. Margin value = Emission level – Limit value.
5. “ * “: Fundamental frequency.



A D T

| EUT TEST CONDITION | | MEASUREMENT DETAIL | |
|--------------------------|-----------------|--------------------|---------------------------|
| CHANNEL | Channel 6 | FREQUENCY RANGE | 1 ~ 25GHz |
| INPUT POWER (SYSTEM) | 120Vac, 60Hz | DETECTOR FUNCTION | Peak (PK) Average (AV) |
| ENVIRONMENTAL CONDITIONS | 25deg. C, 68%RH | TESTED BY | Sun Lin, Anderson Hong |

| ANTENNA POLARITY & TEST DISTANCE: HORIZONTAL AT 3 M | | | | | | | | |
|---|-------------|-------------------------|----------------|-------------|--------------------|----------------------|------------------|--------------------------|
| NO. | FREQ. (MHz) | EMISSION LEVEL (dBuV/m) | LIMIT (dBuV/m) | MARGIN (dB) | ANTENNA HEIGHT (m) | TABLE ANGLE (Degree) | RAW VALUE (dBuV) | CORRECTION FACTOR (dB/m) |
| 1 | *2437.00 | 106.2 PK | | | 1.77 H | 100 | 74.70 | 31.50 |
| 2 | *2437.00 | 103.0 AV | | | 1.77 H | 100 | 71.50 | 31.50 |
| 3 | 2488.00 | 62.3 PK | 74.0 | -11.7 | 1.76 H | 99 | 30.60 | 31.70 |
| 4 | 2488.00 | 52.6 AV | 54.0 | -1.4 | 1.76 H | 99 | 20.90 | 31.70 |
| 5 | 4874.00 | 54.6 PK | 74.0 | -19.4 | 1.60 H | 142 | 17.00 | 37.60 |
| 6 | 4874.00 | 52.0 AV | 54.0 | -2.0 | 1.60 H | 142 | 14.40 | 37.60 |
| 7 | 7311.00 | 56.1 PK | 74.0 | -17.9 | 1.36 H | 147 | 12.40 | 43.70 |
| 8 | 7311.00 | 49.6 AV | 54.0 | -4.4 | 1.36 H | 147 | 5.90 | 43.70 |
| ANTENNA POLARITY & TEST DISTANCE: VERTICAL AT 3 M | | | | | | | | |
| NO. | FREQ. (MHz) | EMISSION LEVEL (dBuV/m) | LIMIT (dBuV/m) | MARGIN (dB) | ANTENNA HEIGHT (m) | TABLE ANGLE (Degree) | RAW VALUE (dBuV) | CORRECTION FACTOR (dB/m) |
| 1 | *2437.00 | 104.3 PK | | | 1.21 V | 26 | 72.80 | 31.50 |
| 2 | *2437.00 | 100.7 AV | | | 1.21 V | 26 | 69.20 | 31.50 |
| 3 | 2488.00 | 60.8 PK | 74.0 | -13.2 | 1.16 V | 21 | 29.10 | 31.70 |
| 4 | 2488.00 | 49.6 AV | 54.0 | -4.4 | 1.16 V | 21 | 17.90 | 31.70 |
| 5 | 4874.00 | 55.7 PK | 74.0 | -18.3 | 1.00 V | 124 | 18.10 | 37.60 |
| 6 | 4874.00 | 53.0 AV | 54.0 | -1.0 | 1.00 V | 124 | 15.40 | 37.60 |
| 7 | 7311.00 | 59.8 PK | 74.0 | -14.2 | 1.00 V | 356 | 16.10 | 43.70 |
| 8 | 7311.00 | 53.0 AV | 54.0 | -1.0 | 1.00 V | 356 | 9.30 | 43.70 |

REMARKS:

1. Emission level (dBuV/m) = Raw Value (dBuV) + Correction Factor (dB/m).
2. Correction Factor (dB/m) = Antenna Factor (dB/m) + Cable Factor (dB).
3. The other emission levels were very low against the limit.
4. Margin value = Emission level – Limit value.
5. “ * “: Fundamental frequency.



A D T

| EUT TEST CONDITION | | MEASUREMENT DETAIL | |
|--------------------------|-----------------|--------------------|---------------------------|
| CHANNEL | Channel 11 | FREQUENCY RANGE | 1 ~ 25GHz |
| INPUT POWER (SYSTEM) | 120Vac, 60Hz | DETECTOR FUNCTION | Peak (PK) Average (AV) |
| ENVIRONMENTAL CONDITIONS | 25deg. C, 68%RH | TESTED BY | Sun Lin, Anderson Hong |

| ANTENNA POLARITY & TEST DISTANCE: HORIZONTAL AT 3 M | | | | | | | | |
|---|-------------|-------------------------|----------------|-------------|--------------------|----------------------|------------------|--------------------------|
| NO. | FREQ. (MHz) | EMISSION LEVEL (dBuV/m) | LIMIT (dBuV/m) | MARGIN (dB) | ANTENNA HEIGHT (m) | TABLE ANGLE (Degree) | RAW VALUE (dBuV) | CORRECTION FACTOR (dB/m) |
| 1 | *2462.00 | 106.9 PK | | | 1.25 H | 282 | 75.30 | 31.60 |
| 2 | *2462.00 | 103.6 AV | | | 1.25 H | 282 | 72.00 | 31.60 |
| 3 | 2483.50 | 68.7 PK | 74.0 | -5.3 | 1.25 H | 282 | 37.00 | 31.70 |
| 4 | 2483.50 | 47.4 AV | 54.0 | -6.6 | 1.25 H | 282 | 15.70 | 31.70 |
| 5 | 4924.00 | 54.7 PK | 74.0 | -19.3 | 1.49 H | 146 | 17.00 | 37.70 |
| 6 | 4924.00 | 52.3 AV | 54.0 | -1.7 | 1.49 H | 146 | 14.60 | 37.70 |
| 7 | 7386.00 | 57.9 PK | 74.0 | -16.1 | 1.43 H | 145 | 14.00 | 43.90 |
| 8 | 7386.00 | 52.1 AV | 54.0 | -1.9 | 1.43 H | 145 | 8.20 | 43.90 |

| ANTENNA POLARITY & TEST DISTANCE: VERTICAL AT 3 M | | | | | | | | |
|---|----------------|-------------------------|----------------|-------------|--------------------|----------------------|------------------|--------------------------|
| NO. | FREQ. (MHz) | EMISSION LEVEL (dBuV/m) | LIMIT (dBuV/m) | MARGIN (dB) | ANTENNA HEIGHT (m) | TABLE ANGLE (Degree) | RAW VALUE (dBuV) | CORRECTION FACTOR (dB/m) |
| 1 | *2462.00 | 104.1 PK | | | 1.18 V | 19 | 72.50 | 31.60 |
| 2 | *2462.00 | 100.5 AV | | | 1.18 V | 19 | 68.90 | 31.60 |
| 3 | 2483.50 | 68.0 PK | 74.0 | -6.0 | 1.18 V | 19 | 36.30 | 31.70 |
| 4 | 2483.50 | 46.3 AV | 54.0 | -7.7 | 1.18 V | 19 | 14.60 | 31.70 |
| 5 | 4924.00 | 56.3 PK | 74.0 | -17.7 | 1.05 V | 206 | 18.60 | 37.70 |
| 6 | 4924.00 | 53.0 AV | 54.0 | -1.0 | 1.05 V | 206 | 15.30 | 37.70 |
| 7 | 7386.00 | 56.9 PK | 74.0 | -17.1 | 1.00 V | 209 | 13.00 | 43.90 |
| 8 | 7386.00 | 50.1 AV | 54.0 | -3.9 | 1.00 V | 209 | 6.20 | 43.90 |

REMARKS:

1. Emission level (dBuV/m) = Raw Value (dBuV) + Correction Factor (dB/m).
2. Correction Factor (dB/m) = Antenna Factor (dB/m) + Cable Factor (dB).
3. The other emission levels were very low against the limit.
4. Margin value = Emission level – Limit value.
5. “ * “: Fundamental frequency.



A D T

802.11g

| EUT TEST CONDITION | | MEASUREMENT DETAIL | |
|--------------------------|-----------------|--------------------|---------------------------|
| CHANNEL | Channel 1 | FREQUENCY RANGE | 1 ~ 25GHz |
| INPUT POWER (SYSTEM) | 120Vac, 60Hz | DETECTOR FUNCTION | Peak (PK) Average (AV) |
| ENVIRONMENTAL CONDITIONS | 25deg. C, 68%RH | TESTED BY | Sun Lin, Anderson Hong |

| ANTENNA POLARITY & TEST DISTANCE: HORIZONTAL AT 3 M | | | | | | | | |
|---|-------------|-------------------------|----------------|-------------|--------------------|----------------------|------------------|--------------------------|
| NO. | FREQ. (MHz) | EMISSION LEVEL (dBuV/m) | LIMIT (dBuV/m) | MARGIN (dB) | ANTENNA HEIGHT (m) | TABLE ANGLE (Degree) | RAW VALUE (dBuV) | CORRECTION FACTOR (dB/m) |
| 1 | 2390.00 | 64.0 PK | 74.0 | -10.0 | 1.24 H | 109 | 32.60 | 31.40 |
| 2 | 2390.00 | 52.7 AV | 54.0 | -1.3 | 1.24 H | 109 | 21.30 | 31.40 |
| 3 | *2412.00 | 103.9 PK | | | 1.81 H | 124 | 72.50 | 31.40 |
| 4 | *2412.00 | 97.0 AV | | | 1.81 H | 124 | 65.60 | 31.40 |
| 5 | 4824.00 | 54.3 PK | 74.0 | -19.7 | 1.36 H | 59 | 16.80 | 37.50 |
| 6 | 4824.00 | 45.9 AV | 54.0 | -8.1 | 1.36 H | 59 | 8.40 | 37.50 |
| ANTENNA POLARITY & TEST DISTANCE: VERTICAL AT 3 M | | | | | | | | |
| NO. | FREQ. (MHz) | EMISSION LEVEL (dBuV/m) | LIMIT (dBuV/m) | MARGIN (dB) | ANTENNA HEIGHT (m) | TABLE ANGLE (Degree) | RAW VALUE (dBuV) | CORRECTION FACTOR (dB/m) |
| 1 | 2390.00 | 55.7 PK | 74.0 | -18.3 | 1.00 V | 20 | 24.30 | 31.40 |
| 2 | 2390.00 | 48.3 AV | 54.0 | -5.7 | 1.00 V | 20 | 16.90 | 31.40 |
| 3 | *2412.00 | 101.8 PK | | | 1.00 V | 20 | 70.40 | 31.40 |
| 4 | *2412.00 | 95.1 AV | | | 1.00 V | 20 | 63.70 | 31.40 |
| 5 | 4824.00 | 55.5 PK | 74.0 | -18.5 | 1.18 V | 229 | 18.00 | 37.50 |
| 6 | 4824.00 | 46.5 AV | 54.0 | -7.5 | 1.18 V | 229 | 9.00 | 37.50 |

REMARKS:

1. Emission level (dBuV/m) = Raw Value (dBuV) + Correction Factor (dB/m).
2. Correction Factor (dB/m) = Antenna Factor (dB/m) + Cable Factor (dB).
3. The other emission levels were very low against the limit.
4. Margin value = Emission level – Limit value.
5. “ * “: Fundamental frequency.



A D T

| EUT TEST CONDITION | | MEASUREMENT DETAIL | |
|--------------------------|-----------------|--------------------|---------------------------|
| CHANNEL | Channel 6 | FREQUENCY RANGE | 1 ~ 25GHz |
| INPUT POWER (SYSTEM) | 120Vac, 60Hz | DETECTOR FUNCTION | Peak (PK) Average (AV) |
| ENVIRONMENTAL CONDITIONS | 25deg. C, 68%RH | TESTED BY | Sun Lin, Anderson Hong |

| ANTENNA POLARITY & TEST DISTANCE: HORIZONTAL AT 3 M | | | | | | | | |
|---|-------------|-------------------------|----------------|-------------|--------------------|----------------------|------------------|--------------------------|
| NO. | FREQ. (MHz) | EMISSION LEVEL (dBuV/m) | LIMIT (dBuV/m) | MARGIN (dB) | ANTENNA HEIGHT (m) | TABLE ANGLE (Degree) | RAW VALUE (dBuV) | CORRECTION FACTOR (dB/m) |
| 1 | *2437.00 | 105.4 PK | | | 1.23 H | 278 | 73.90 | 31.50 |
| 2 | *2437.00 | 98.8 AV | | | 1.23 H | 278 | 67.30 | 31.50 |
| 3 | 2483.50 | 59.9 PK | 74.0 | -14.1 | 1.24 H | 285 | 28.20 | 31.70 |
| 4 | 2483.50 | 52.5 AV | 54.0 | -1.5 | 1.24 H | 285 | 20.80 | 31.70 |
| 5 | 4874.00 | 56.2 PK | 74.0 | -17.8 | 1.43 H | 67 | 18.60 | 37.60 |
| 6 | 4874.00 | 47.8 AV | 54.0 | -6.2 | 1.43 H | 67 | 10.20 | 37.60 |
| 7 | 7311.00 | 72.3 PK | 74.0 | -1.7 | 1.61 H | 289 | 28.60 | 43.70 |
| 8 | 7311.00 | 53.0 AV | 54.0 | -1.0 | 1.61 H | 289 | 9.30 | 43.70 |
| ANTENNA POLARITY & TEST DISTANCE: VERTICAL AT 3 M | | | | | | | | |
| NO. | FREQ. (MHz) | EMISSION LEVEL (dBuV/m) | LIMIT (dBuV/m) | MARGIN (dB) | ANTENNA HEIGHT (m) | TABLE ANGLE (Degree) | RAW VALUE (dBuV) | CORRECTION FACTOR (dB/m) |
| 1 | *2437.00 | 103.6 PK | | | 1.22 V | 25 | 72.10 | 31.50 |
| 2 | *2437.00 | 96.2 AV | | | 1.22 V | 25 | 64.70 | 31.50 |
| 3 | 2483.50 | 57.6 PK | 74.0 | -16.4 | 1.22 V | 25 | 25.90 | 31.70 |
| 4 | 2483.50 | 48.6 AV | 54.0 | -5.4 | 1.22 V | 25 | 16.90 | 31.70 |
| 5 | 4874.00 | 57.8 PK | 74.0 | -16.2 | 1.15 V | 230 | 20.20 | 37.60 |
| 6 | 4874.00 | 47.8 AV | 54.0 | -6.2 | 1.15 V | 230 | 10.20 | 37.60 |
| 7 | 7311.00 | 67.4 PK | 74.0 | -6.6 | 1.00 V | 355 | 23.70 | 43.70 |
| 8 | 7311.00 | 50.3 AV | 54.0 | -3.7 | 1.00 V | 355 | 6.60 | 43.70 |

REMARKS:

1. Emission level (dBuV/m) = Raw Value (dBuV) + Correction Factor (dB/m).
2. Correction Factor (dB/m) = Antenna Factor (dB/m) + Cable Factor (dB).
3. The other emission levels were very low against the limit.
4. Margin value = Emission level – Limit value.
5. “ * “: Fundamental frequency.



A D T

| EUT TEST CONDITION | | MEASUREMENT DETAIL | |
|--------------------------|-----------------|--------------------|---------------------------|
| CHANNEL | Channel 11 | FREQUENCY RANGE | 1 ~ 25GHz |
| INPUT POWER (SYSTEM) | 120Vac, 60Hz | DETECTOR FUNCTION | Peak (PK) Average (AV) |
| ENVIRONMENTAL CONDITIONS | 25deg. C, 68%RH | TESTED BY | Sun Lin, Anderson Hong |

| ANTENNA POLARITY & TEST DISTANCE: HORIZONTAL AT 3 M | | | | | | | | |
|---|-------------|-------------------------|----------------|-------------|--------------------|----------------------|------------------|--------------------------|
| NO. | FREQ. (MHz) | EMISSION LEVEL (dBuV/m) | LIMIT (dBuV/m) | MARGIN (dB) | ANTENNA HEIGHT (m) | TABLE ANGLE (Degree) | RAW VALUE (dBuV) | CORRECTION FACTOR (dB/m) |
| 1 | *2462.00 | 104.7 PK | | | 1.20 H | 288 | 73.10 | 31.60 |
| 2 | *2462.00 | 97.5 AV | | | 1.20 H | 288 | 65.90 | 31.60 |
| 3 | 2483.50 | 63.3 PK | 74.0 | -10.7 | 1.20 H | 285 | 31.60 | 31.70 |
| 4 | 2483.50 | 52.5 AV | 54.0 | -1.5 | 1.20 H | 285 | 20.80 | 31.70 |
| 5 | 4924.00 | 51.1 PK | 74.0 | -22.9 | 1.47 H | 219 | 13.40 | 37.70 |
| 6 | 4924.00 | 41.7 AV | 54.0 | -12.3 | 1.47 H | 219 | 4.00 | 37.70 |
| 7 | 7386.00 | 63.6 PK | 74.0 | -10.4 | 1.26 H | 303 | 19.70 | 43.90 |
| 8 | 7386.00 | 49.2 AV | 54.0 | -4.8 | 1.26 H | 303 | 5.30 | 43.90 |
| ANTENNA POLARITY & TEST DISTANCE: VERTICAL AT 3 M | | | | | | | | |
| NO. | FREQ. (MHz) | EMISSION LEVEL (dBuV/m) | LIMIT (dBuV/m) | MARGIN (dB) | ANTENNA HEIGHT (m) | TABLE ANGLE (Degree) | RAW VALUE (dBuV) | CORRECTION FACTOR (dB/m) |
| 1 | *2462.00 | 102.3 PK | | | 1.16 V | 35 | 70.70 | 31.60 |
| 2 | *2462.00 | 94.9 AV | | | 1.16 V | 35 | 63.30 | 31.60 |
| 3 | 2483.50 | 56.7 PK | 74.0 | -17.3 | 1.16 V | 35 | 25.00 | 31.70 |
| 4 | 2483.50 | 48.1 AV | 54.0 | -5.9 | 1.16 V | 35 | 16.40 | 31.70 |
| 5 | 4924.00 | 51.8 PK | 74.0 | -22.2 | 1.28 V | 231 | 14.10 | 37.70 |
| 6 | 4924.00 | 44.2 AV | 54.0 | -9.8 | 1.28 V | 231 | 6.50 | 37.70 |
| 7 | 7386.00 | 63.2 PK | 74.0 | -10.8 | 1.34 V | 348 | 19.30 | 43.90 |
| 8 | 7386.00 | 47.8 AV | 54.0 | -6.2 | 1.34 V | 348 | 3.90 | 43.90 |

REMARKS:

1. Emission level (dBuV/m) = Raw Value (dBuV) + Correction Factor (dB/m).
2. Correction Factor (dB/m) = Antenna Factor (dB/m) + Cable Factor (dB).
3. The other emission levels were very low against the limit.
4. Margin value = Emission level – Limit value.
5. “ * “: Fundamental frequency.



A D T

802.11n (20MHz)

| EUT TEST CONDITION | | MEASUREMENT DETAIL | |
|--------------------------|-----------------|--------------------|------------------------------|
| CHANNEL | Channel 1 | FREQUENCY RANGE | 1 ~ 25GHz |
| INPUT POWER (SYSTEM) | 120Vac, 60Hz | DETECTOR FUNCTION | Peak (PK) Average (AV) |
| ENVIRONMENTAL CONDITIONS | 25deg. C, 68%RH | TESTED BY | Aska Huang, Anderson Hong |

| ANTENNA POLARITY & TEST DISTANCE: HORIZONTAL AT 3 M | | | | | | | | |
|---|-------------|-------------------------|----------------|-------------|--------------------|----------------------|------------------|--------------------------|
| NO. | FREQ. (MHz) | EMISSION LEVEL (dBuV/m) | LIMIT (dBuV/m) | MARGIN (dB) | ANTENNA HEIGHT (m) | TABLE ANGLE (Degree) | RAW VALUE (dBuV) | CORRECTION FACTOR (dB/m) |
| 1 | 2390.00 | 61.7 PK | 74.0 | -12.3 | 1.74 H | 88 | 30.30 | 31.40 |
| 2 | 2390.00 | 53.0 AV | 54.0 | -1.0 | 1.74 H | 88 | 21.60 | 31.40 |
| 3 | *2412.00 | 103.0 PK | | | 1.74 H | 299 | 71.60 | 31.40 |
| 4 | *2412.00 | 96.0 AV | | | 1.74 H | 299 | 64.60 | 31.40 |
| 5 | 4824.00 | 47.9 PK | 74.0 | -26.1 | 1.24 H | 61 | 10.40 | 37.50 |
| 6 | 4824.00 | 38.5 AV | 54.0 | -15.5 | 1.24 H | 61 | 1.00 | 37.50 |
| ANTENNA POLARITY & TEST DISTANCE: VERTICAL AT 3 M | | | | | | | | |
| NO. | FREQ. (MHz) | EMISSION LEVEL (dBuV/m) | LIMIT (dBuV/m) | MARGIN (dB) | ANTENNA HEIGHT (m) | TABLE ANGLE (Degree) | RAW VALUE (dBuV) | CORRECTION FACTOR (dB/m) |
| 1 | 2390.00 | 55.0 PK | 74.0 | -19.0 | 1.00 V | 18 | 23.60 | 31.40 |
| 2 | 2390.00 | 48.2 AV | 54.0 | -5.8 | 1.00 V | 18 | 16.80 | 31.40 |
| 3 | *2412.00 | 100.3 PK | | | 1.00 V | 18 | 68.90 | 31.40 |
| 4 | *2412.00 | 94.0 AV | | | 1.00 V | 18 | 62.60 | 31.40 |
| 5 | 4824.00 | 52.8 PK | 74.0 | -21.2 | 1.26 V | 230 | 15.30 | 37.50 |
| 6 | 4824.00 | 43.2 AV | 54.0 | -10.8 | 1.26 V | 230 | 5.70 | 37.50 |

REMARKS:

1. Emission level (dBuV/m) = Raw Value (dBuV) + Correction Factor (dB/m).
2. Correction Factor (dB/m) = Antenna Factor (dB/m) + Cable Factor (dB).
3. The other emission levels were very low against the limit.
4. Margin value = Emission level – Limit value.
5. “ * “: Fundamental frequency.



A D T

| EUT TEST CONDITION | | MEASUREMENT DETAIL | |
|--------------------------|-----------------|--------------------|------------------------------|
| CHANNEL | Channel 6 | FREQUENCY RANGE | 1 ~ 25GHz |
| INPUT POWER (SYSTEM) | 120Vac, 60Hz | DETECTOR FUNCTION | Peak (PK) Average (AV) |
| ENVIRONMENTAL CONDITIONS | 25deg. C, 68%RH | TESTED BY | Aska Huang, Anderson Hong |

| ANTENNA POLARITY & TEST DISTANCE: HORIZONTAL AT 3 M | | | | | | | | |
|---|-------------|-------------------------|----------------|-------------|--------------------|----------------------|------------------|--------------------------|
| NO. | FREQ. (MHz) | EMISSION LEVEL (dBuV/m) | LIMIT (dBuV/m) | MARGIN (dB) | ANTENNA HEIGHT (m) | TABLE ANGLE (Degree) | RAW VALUE (dBuV) | CORRECTION FACTOR (dB/m) |
| 1 | *2437.00 | 106.3 PK | | | 1.76 H | 305 | 74.80 | 31.50 |
| 2 | *2437.00 | 99.9 AV | | | 1.76 H | 305 | 68.40 | 31.50 |
| 3 | 2486.00 | 60.7 PK | 74.0 | -13.3 | 1.74 H | 96 | 29.00 | 31.70 |
| 4 | 2486.00 | 52.9 AV | 54.0 | -1.1 | 1.74 H | 96 | 21.20 | 31.70 |
| 5 | 4874.00 | 58.9 PK | 74.0 | -15.1 | 1.76 H | 58 | 21.30 | 37.60 |
| 6 | 4874.00 | 47.5 AV | 54.0 | -6.5 | 1.76 H | 58 | 9.90 | 37.60 |
| 7 | 7311.00 | 72.0 PK | 74.0 | -2.0 | 1.23 H | 297 | 28.30 | 43.70 |
| 8 | 7311.00 | 53.0 AV | 54.0 | -1.0 | 1.23 H | 297 | 9.30 | 43.70 |
| ANTENNA POLARITY & TEST DISTANCE: VERTICAL AT 3 M | | | | | | | | |
| NO. | FREQ. (MHz) | EMISSION LEVEL (dBuV/m) | LIMIT (dBuV/m) | MARGIN (dB) | ANTENNA HEIGHT (m) | TABLE ANGLE (Degree) | RAW VALUE (dBuV) | CORRECTION FACTOR (dB/m) |
| 1 | *2437.00 | 104.0 PK | | | 1.20 V | 23 | 72.50 | 31.50 |
| 2 | *2437.00 | 97.0 AV | | | 1.20 V | 23 | 65.50 | 31.50 |
| 3 | 2486.00 | 58.5 PK | 74.0 | -15.5 | 1.20 V | 23 | 26.80 | 31.70 |
| 4 | 2486.00 | 51.3 AV | 54.0 | -2.7 | 1.20 V | 23 | 19.60 | 31.70 |
| 5 | 4874.00 | 60.3 PK | 74.0 | -13.7 | 1.16 V | 229 | 22.70 | 37.60 |
| 6 | 4874.00 | 50.1 AV | 54.0 | -3.9 | 1.16 V | 229 | 12.50 | 37.60 |
| 7 | 7311.00 | 71.2 PK | 74.0 | -2.8 | 1.44 V | 182 | 27.50 | 43.70 |
| 8 | 7311.00 | 52.9 AV | 54.0 | -1.1 | 1.44 V | 182 | 9.20 | 43.70 |

REMARKS:

1. Emission level (dBuV/m) = Raw Value (dBuV) + Correction Factor (dB/m).
2. Correction Factor (dB/m) = Antenna Factor (dB/m) + Cable Factor (dB).
3. The other emission levels were very low against the limit.
4. Margin value = Emission level – Limit value.
5. “ * “: Fundamental frequency.



A D T

| EUT TEST CONDITION | | MEASUREMENT DETAIL | |
|--------------------------|-----------------|--------------------|------------------------------|
| CHANNEL | Channel 11 | FREQUENCY RANGE | 1 ~ 25GHz |
| INPUT POWER (SYSTEM) | 120Vac, 60Hz | DETECTOR FUNCTION | Peak (PK) Average (AV) |
| ENVIRONMENTAL CONDITIONS | 25deg. C, 68%RH | TESTED BY | Aska Huang, Anderson Hong |

| ANTENNA POLARITY & TEST DISTANCE: HORIZONTAL AT 3 M | | | | | | | | |
|---|-------------|-------------------------|----------------|-------------|--------------------|----------------------|------------------|--------------------------|
| NO. | FREQ. (MHz) | EMISSION LEVEL (dBuV/m) | LIMIT (dBuV/m) | MARGIN (dB) | ANTENNA HEIGHT (m) | TABLE ANGLE (Degree) | RAW VALUE (dBuV) | CORRECTION FACTOR (dB/m) |
| 1 | *2462.00 | 105.3 PK | | | 1.76 H | 300 | 73.70 | 31.60 |
| 2 | *2462.00 | 97.7 AV | | | 1.76 H | 300 | 66.10 | 31.60 |
| 3 | 2483.50 | 63.7 PK | 74.0 | -10.3 | 1.76 H | 99 | 32.00 | 31.70 |
| 4 | 2483.50 | 52.6 AV | 54.0 | -1.4 | 1.76 H | 99 | 20.90 | 31.70 |
| 5 | 4924.00 | 48.2 PK | 74.0 | -25.8 | 1.35 H | 102 | 10.50 | 37.70 |
| 6 | 4924.00 | 39.2 AV | 54.0 | -14.8 | 1.35 H | 102 | 1.50 | 37.70 |
| ANTENNA POLARITY & TEST DISTANCE: VERTICAL AT 3 M | | | | | | | | |
| NO. | FREQ. (MHz) | EMISSION LEVEL (dBuV/m) | LIMIT (dBuV/m) | MARGIN (dB) | ANTENNA HEIGHT (m) | TABLE ANGLE (Degree) | RAW VALUE (dBuV) | CORRECTION FACTOR (dB/m) |
| 1 | *2462.00 | 102.1 PK | | | 1.13 V | 22 | 70.50 | 31.60 |
| 2 | *2462.00 | 94.6 AV | | | 1.13 V | 22 | 63.00 | 31.60 |
| 3 | 2483.50 | 61.6 PK | 74.0 | -12.4 | 1.13 V | 22 | 29.90 | 31.70 |
| 4 | 2483.50 | 50.3 AV | 54.0 | -3.7 | 1.13 V | 22 | 18.60 | 31.70 |
| 5 | 4924.00 | 52.5 PK | 74.0 | -21.5 | 1.28 V | 229 | 14.80 | 37.70 |
| 6 | 4924.00 | 43.7 AV | 54.0 | -10.3 | 1.28 V | 229 | 6.00 | 37.70 |

REMARKS:

1. Emission level (dBuV/m) = Raw Value (dBuV) + Correction Factor (dB/m).
2. Correction Factor (dB/m) = Antenna Factor (dB/m) + Cable Factor (dB).
3. The other emission levels were very low against the limit.
4. Margin value = Emission level – Limit value.
5. “ * “: Fundamental frequency.



A D T

802.11n (40MHz)

| EUT TEST CONDITION | | MEASUREMENT DETAIL | |
|--------------------------|-----------------|--------------------|---------------------------|
| CHANNEL | Channel 3 | FREQUENCY RANGE | 1 ~ 25GHz |
| INPUT POWER (SYSTEM) | 120Vac, 60Hz | DETECTOR FUNCTION | Peak (PK) Average (AV) |
| ENVIRONMENTAL CONDITIONS | 25deg. C, 68%RH | TESTED BY | Sun Lin, Anderson Hong |

| ANTENNA POLARITY & TEST DISTANCE: HORIZONTAL AT 3 M | | | | | | | | |
|---|-------------|-------------------------|----------------|-------------|--------------------|----------------------|------------------|--------------------------|
| NO. | FREQ. (MHz) | EMISSION LEVEL (dBuV/m) | LIMIT (dBuV/m) | MARGIN (dB) | ANTENNA HEIGHT (m) | TABLE ANGLE (Degree) | RAW VALUE (dBuV) | CORRECTION FACTOR (dB/m) |
| 1 | 2390.00 | 59.8 PK | 74.0 | -14.2 | 1.29 H | 281 | 28.40 | 31.40 |
| 2 | 2390.00 | 52.9 AV | 54.0 | -1.1 | 1.29 H | 281 | 21.50 | 31.40 |
| 3 | *2422.00 | 97.4 PK | | | 1.29 H | 289 | 65.90 | 31.50 |
| 4 | *2422.00 | 91.0 AV | | | 1.29 H | 289 | 59.50 | 31.50 |
| 5 | 4844.00 | 48.1 PK | 74.0 | -25.9 | 1.24 H | 148 | 10.60 | 37.50 |
| 6 | 4844.00 | 38.6 AV | 54.0 | -15.4 | 1.24 H | 148 | 1.10 | 37.50 |
| ANTENNA POLARITY & TEST DISTANCE: VERTICAL AT 3 M | | | | | | | | |
| NO. | FREQ. (MHz) | EMISSION LEVEL (dBuV/m) | LIMIT (dBuV/m) | MARGIN (dB) | ANTENNA HEIGHT (m) | TABLE ANGLE (Degree) | RAW VALUE (dBuV) | CORRECTION FACTOR (dB/m) |
| 1 | 2390.00 | 57.2 PK | 74.0 | -16.8 | 1.21 V | 23 | 25.80 | 31.40 |
| 2 | 2390.00 | 48.1 AV | 54.0 | -5.9 | 1.21 V | 23 | 16.70 | 31.40 |
| 3 | *2422.00 | 94.4 PK | | | 1.21 V | 23 | 62.90 | 31.50 |
| 4 | *2422.00 | 87.8 AV | | | 1.21 V | 23 | 56.30 | 31.50 |
| 5 | 4944.00 | 44.0 PK | 74.0 | -30.0 | 1.00 V | 80 | 6.30 | 37.70 |
| 6 | 4944.00 | 35.9 AV | 54.0 | -18.1 | 1.00 V | 80 | -1.80 | 37.70 |

REMARKS:

1. Emission level (dBuV/m) = Raw Value (dBuV) + Correction Factor (dB/m).
2. Correction Factor (dB/m) = Antenna Factor (dB/m) + Cable Factor (dB).
3. The other emission levels were very low against the limit.
4. Margin value = Emission level – Limit value.
5. “ * “: Fundamental frequency.



A D T

| EUT TEST CONDITION | | MEASUREMENT DETAIL | |
|--------------------------|-----------------|--------------------|---------------------------|
| CHANNEL | Channel 6 | FREQUENCY RANGE | 1 ~ 25GHz |
| INPUT POWER (SYSTEM) | 120Vac, 60Hz | DETECTOR FUNCTION | Peak (PK) Average (AV) |
| ENVIRONMENTAL CONDITIONS | 25deg. C, 68%RH | TESTED BY | Sun Lin, Anderson Hong |

| ANTENNA POLARITY & TEST DISTANCE: HORIZONTAL AT 3 M | | | | | | | | |
|---|-------------|-------------------------|----------------|-------------|--------------------|----------------------|------------------|--------------------------|
| NO. | FREQ. (MHz) | EMISSION LEVEL (dBuV/m) | LIMIT (dBuV/m) | MARGIN (dB) | ANTENNA HEIGHT (m) | TABLE ANGLE (Degree) | RAW VALUE (dBuV) | CORRECTION FACTOR (dB/m) |
| 1 | *2437.00 | 101.8 PK | | | 1.20 H | 271 | 70.30 | 31.50 |
| 2 | *2437.00 | 95.2 AV | | | 1.20 H | 271 | 63.70 | 31.50 |
| 3 | 2483.50 | 60.8 PK | 74.0 | -13.2 | 1.20 H | 283 | 29.10 | 31.70 |
| 4 | 2483.50 | 52.3 AV | 54.0 | -1.7 | 1.20 H | 283 | 20.60 | 31.70 |
| 5 | 4874.00 | 48.5 PK | 74.0 | -25.5 | 1.47 H | 70 | 10.90 | 37.60 |
| 6 | 4874.00 | 39.7 AV | 54.0 | -14.3 | 1.47 H | 70 | 2.10 | 37.60 |

| ANTENNA POLARITY & TEST DISTANCE: VERTICAL AT 3 M | | | | | | | | |
|---|-------------|-------------------------|----------------|-------------|--------------------|----------------------|------------------|--------------------------|
| NO. | FREQ. (MHz) | EMISSION LEVEL (dBuV/m) | LIMIT (dBuV/m) | MARGIN (dB) | ANTENNA HEIGHT (m) | TABLE ANGLE (Degree) | RAW VALUE (dBuV) | CORRECTION FACTOR (dB/m) |
| 1 | *2437.00 | 98.2 PK | | | 1.18 V | 23 | 66.70 | 31.50 |
| 2 | *2437.00 | 91.6 AV | | | 1.18 V | 23 | 60.10 | 31.50 |
| 3 | 2483.50 | 56.8 PK | 74.0 | -17.2 | 1.18 V | 23 | 25.10 | 31.70 |
| 4 | 2483.50 | 49.4 AV | 54.0 | -4.6 | 1.18 V | 23 | 17.70 | 31.70 |
| 5 | 4874.00 | 49.9 PK | 74.0 | -24.1 | 1.05 V | 192 | 12.30 | 37.60 |
| 6 | 4874.00 | 41.2 AV | 54.0 | -12.8 | 1.05 V | 192 | 3.60 | 37.60 |

REMARKS:

1. Emission level (dBuV/m) = Raw Value (dBuV) + Correction Factor (dB/m).
2. Correction Factor (dB/m) = Antenna Factor (dB/m) + Cable Factor (dB).
3. The other emission levels were very low against the limit.
4. Margin value = Emission level – Limit value.
5. “ * “: Fundamental frequency.



A D T

| EUT TEST CONDITION | | MEASUREMENT DETAIL | |
|--------------------------|-----------------|--------------------|---------------------------|
| CHANNEL | Channel 9 | FREQUENCY RANGE | 1 ~ 25GHz |
| INPUT POWER (SYSTEM) | 120Vac, 60Hz | DETECTOR FUNCTION | Peak (PK) Average (AV) |
| ENVIRONMENTAL CONDITIONS | 25deg. C, 68%RH | TESTED BY | Sun Lin, Anderson Hong |

| ANTENNA POLARITY & TEST DISTANCE: HORIZONTAL AT 3 M | | | | | | | | |
|---|-------------|-------------------------|----------------|-------------|--------------------|----------------------|------------------|--------------------------|
| NO. | FREQ. (MHz) | EMISSION LEVEL (dBuV/m) | LIMIT (dBuV/m) | MARGIN (dB) | ANTENNA HEIGHT (m) | TABLE ANGLE (Degree) | RAW VALUE (dBuV) | CORRECTION FACTOR (dB/m) |
| 1 | *2452.00 | 98.6 PK | | | 1.22 H | 283 | 67.00 | 31.60 |
| 2 | *2452.00 | 92.4 AV | | | 1.22 H | 283 | 60.80 | 31.60 |
| 3 | 2483.50 | 62.8 PK | 74.0 | -11.2 | 1.22 H | 283 | 31.10 | 31.70 |
| 4 | 2483.50 | 52.4 AV | 54.0 | -1.6 | 1.22 H | 283 | 20.70 | 31.70 |
| 5 | 4904.00 | 49.4 PK | 74.0 | -24.6 | 1.12 H | 231 | 11.80 | 37.60 |
| 6 | 4904.00 | 38.3 AV | 54.0 | -15.7 | 1.12 H | 231 | 0.70 | 37.60 |

| ANTENNA POLARITY & TEST DISTANCE: VERTICAL AT 3 M | | | | | | | | |
|---|-------------|-------------------------|----------------|-------------|--------------------|----------------------|------------------|--------------------------|
| NO. | FREQ. (MHz) | EMISSION LEVEL (dBuV/m) | LIMIT (dBuV/m) | MARGIN (dB) | ANTENNA HEIGHT (m) | TABLE ANGLE (Degree) | RAW VALUE (dBuV) | CORRECTION FACTOR (dB/m) |
| 1 | *2452.00 | 95.5 PK | | | 1.20 V | 23 | 63.90 | 31.60 |
| 2 | *2452.00 | 89.0 AV | | | 1.20 V | 23 | 57.40 | 31.60 |
| 3 | 2483.50 | 61.0 PK | 74.0 | -13.0 | 1.20 V | 23 | 29.30 | 31.70 |
| 4 | 2483.50 | 50.1 AV | 54.0 | -3.9 | 1.20 V | 23 | 18.40 | 31.70 |
| 5 | 4904.00 | 46.3 PK | 74.0 | -27.7 | 1.23 V | 244 | 8.70 | 37.60 |
| 6 | 4904.00 | 38.6 AV | 54.0 | -15.4 | 1.23 V | 244 | 1.00 | 37.60 |

REMARKS:

1. Emission level (dBuV/m) = Raw Value (dBuV) + Correction Factor (dB/m).
2. Correction Factor (dB/m) = Antenna Factor (dB/m) + Cable Factor (dB).
3. The other emission levels were very low against the limit.
4. Margin value = Emission level – Limit value.
5. “ * “: Fundamental frequency.



A D T

BELOW 1GHz WORST-CASE DATA : 802.11n (20MHz)

| EUT TEST CONDITION | | MEASUREMENT DETAIL | |
|--------------------------|-----------------|--------------------|---------------|
| CHANNEL | Channel 6 | FREQUENCY RANGE | Below 1000MHz |
| INPUT POWER (SYSTEM) | 120Vac, 60Hz | DETECTOR FUNCTION | Quasi-Peak |
| ENVIRONMENTAL CONDITIONS | 25deg. C, 65%RH | TESTED BY | Anderson Hong |

ANTENNA POLARITY & TEST DISTANCE: HORIZONTAL AT 3 M

| NO. | FREQ. (MHz) | EMISSION LEVEL (dBuV/m) | LIMIT (dBuV/m) | MARGIN (dB) | ANTENNA HEIGHT (m) | TABLE ANGLE (Degree) | RAW VALUE (dBuV) | CORRECTION FACTOR (dB/m) |
|-----|-------------|-------------------------|----------------|-------------|--------------------|----------------------|------------------|--------------------------|
| 1 | 127.00 | 19.1 QP | 43.5 | -24.4 | 1.25 H | 101 | 6.60 | 12.50 |
| 2 | 189.08 | 22.2 QP | 43.5 | -21.3 | 1.25 H | 103 | 10.20 | 12.00 |
| 3 | 280.26 | 25.4 QP | 46.0 | -20.6 | 1.00 H | 294 | 11.20 | 14.20 |
| 4 | 544.10 | 27.6 QP | 46.0 | -18.4 | 1.00 H | 180 | 6.50 | 21.10 |
| 5 | 600.36 | 27.5 QP | 46.0 | -18.5 | 1.25 H | 252 | 5.10 | 22.40 |
| 6 | 751.68 | 26.9 QP | 46.0 | -19.1 | 1.00 H | 195 | 2.90 | 24.00 |

ANTENNA POLARITY & TEST DISTANCE: VERTICAL AT 3 M

| NO. | FREQ. (MHz) | EMISSION LEVEL (dBuV/m) | LIMIT (dBuV/m) | MARGIN (dB) | ANTENNA HEIGHT (m) | TABLE ANGLE (Degree) | RAW VALUE (dBuV) | CORRECTION FACTOR (dB/m) |
|-----|-------------|-------------------------|----------------|-------------|--------------------|----------------------|------------------|--------------------------|
| 1 | 107.60 | 22.1 QP | 43.5 | -21.4 | 1.25 V | 17 | 11.70 | 10.40 |
| 2 | 189.08 | 28.3 QP | 43.5 | -15.2 | 1.00 V | 100 | 16.30 | 12.00 |
| 3 | 297.72 | 24.3 QP | 46.0 | -21.7 | 1.00 V | 347 | 9.50 | 14.80 |
| 4 | 400.54 | 24.6 QP | 46.0 | -21.4 | 1.25 V | 100 | 7.10 | 17.50 |
| 5 | 600.36 | 28.7 QP | 46.0 | -17.3 | 1.00 V | 70 | 6.30 | 22.40 |
| 6 | 724.52 | 26.6 QP | 46.0 | -19.4 | 1.50 V | 334 | 3.20 | 23.40 |

REMARKS:

1. Emission level (dBuV/m) = Raw Value (dBuV) + Correction Factor (dB/m).
2. Correction Factor (dB/m) = Antenna Factor (dB/m) + Cable Factor (dB).
3. The other emission levels were very low against the limit.
4. Margin value = Emission level – Limit value.

4.2 CONDUCTED EMISSION MEASUREMENT

4.2.1 LIMITS OF CONDUCTED EMISSION MEASUREMENT

| FREQUENCY OF EMISSION (MHz) | CONDUCTED LIMIT (dB μ V) | |
|-----------------------------|------------------------------|----------|
| | Quasi-peak | Average |
| 0.15 ~ 0.5 | 66 to 56 | 56 to 46 |
| 0.5 ~ 5 | 56 | 46 |
| 5 ~ 30 | 60 | 50 |

- NOTE:** 1. The lower limit shall apply at the transition frequencies.
2. The limit decreases in line with the logarithm of the frequency in the range of 0.15 to 0.50MHz.
3. All emanations from a class A/B digital device or system, including any network of conductors and apparatus connected thereto, shall not exceed the level of field strengths specified above.

4.2.2 TEST INSTRUMENTS

| DESCRIPTION & MANUFACTURER | MODEL NO. | SERIAL NO. | DATE OF CALIBRATION | DUE DATE OF CALIBRATION |
|---|--------------------------|----------------|---------------------|-------------------------|
| Test Receiver ROHDE & SCHWARZ | ESCS30 | 100291 | Nov. 23, 2011 | Nov. 22, 2012 |
| RF signal cable Woken | 5D-FB | Cable-HYC01-01 | Dec. 29, 2011 | Dec. 28, 2012 |
| LISN ROHDE & SCHWARZ (Peripheral) | ESH3-Z5 | 100312 | Jul. 02, 2012 | Jul. 01, 2013 |
| LISN ROHDE & SCHWARZ (EUT) | ESH3-Z5 | 835239/001 | Feb. 07, 2012 | Feb. 06, 2013 |
| Software ADT | BV ADT_Cond_ V7.3.7.3 | NA | NA | NA |

- NOTE:** 1. The calibration interval of the above test instruments is 12 months and the calibrations are traceable to NML/ROC and NIST/USA.
2. The test was performed in HwaYa Shielded Room 1.
3. The VCCI Site Registration No. is C-2040.

4.2.3 TEST PROCEDURES

- a. The EUT was placed 0.4 meters from the conducting wall of the shielded room with EUT being connected to the power mains through a line impedance stabilization network (LISN). Other support units were connected to the power mains through another LISN. The two LISNs provide 50 ohm/ 50uH of coupling impedance for the measuring instrument.
- b. Both lines of the power mains connected to the EUT were checked for maximum conducted interference.
- c. The frequency range from 150kHz to 30MHz was searched. Emission levels under (Limit - 20dB) was not recorded.

NOTE: All modes of operation were investigated and the worst-case emissions are reported.

4.2.4 DEVIATION FROM TEST STANDARD

No deviation.

4.2.5 TEST SETUP

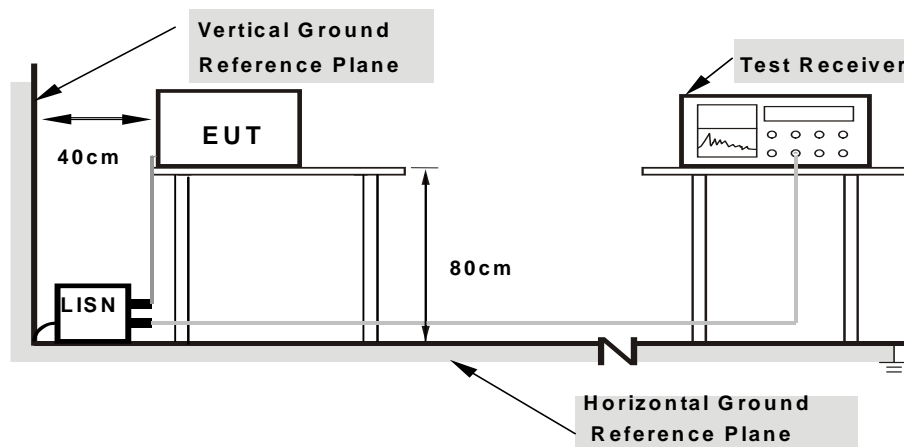

Note: 1.Support units were connected to second LISN.
 2.Both of LISNs (AMN) are 80 cm from EUT and at least 80 from other units and other metal planes

For the actual test configuration, please refer to the attached file (Test Setup Photo).

4.2.6 EUT OPERATING CONDITIONS

Same as 4.1.6.



A D T

4.2.7 TEST RESULTS

CONDUCTED WORST-CASE DATA : 802.11n (20MHz)

| | | | |
|--------------|--------|----------------------|------|
| PHASE | Line 1 | 6dB BANDWIDTH | 9kHz |
|--------------|--------|----------------------|------|

| No | Freq. [MHz] | Corr. Factor (dB) | Reading Value | | Emission Level | | Limit | | Margin | |
|----|----------------|-------------------------|---------------|-------|----------------|-------|-----------|-------|--------|-------|
| | | | [dB (uV)] | | [dB (uV)] | | [dB (uV)] | | (dB) | |
| | | | Q.P. | AV. | Q.P. | AV. | Q.P. | AV. | Q.P. | AV. |
| 1 | 0.15000 | 0.14 | 61.12 | 52.28 | 61.26 | 52.42 | 66.00 | 56.00 | -4.74 | -3.58 |
| 2 | 0.16172 | 0.16 | 63.01 | 47.08 | 63.17 | 47.24 | 65.38 | 55.38 | -2.21 | -8.14 |
| 3 | 0.17734 | 0.19 | 61.49 | 47.26 | 61.68 | 47.45 | 64.61 | 54.61 | -2.93 | -7.16 |
| 4 | 0.20469 | 0.23 | 60.67 | 47.34 | 60.90 | 47.57 | 63.42 | 53.42 | -2.52 | -5.85 |
| 5 | 0.22812 | 0.22 | 58.42 | 44.89 | 58.64 | 45.11 | 62.52 | 52.52 | -3.88 | -7.41 |
| 6 | 0.26719 | 0.21 | 55.47 | 43.17 | 55.68 | 43.38 | 61.20 | 51.20 | -5.53 | -7.83 |

REMARKS:

1. Q.P. and AV. are abbreviations of quasi-peak and average individually.
2. The emission levels of other frequencies were very low against the limit.
3. Margin value = Emission level - Limit value
4. Correction factor = Insertion loss + Cable loss
5. Emission Level = Correction Factor + Reading Value.

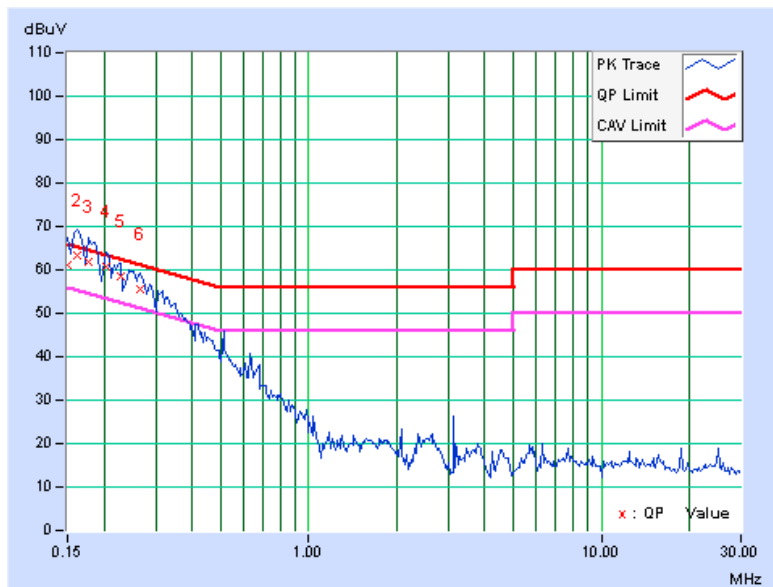

| | | | |
|-------|--------|---------------|------|
| PHASE | Line 2 | 6dB BANDWIDTH | 9kHz |
|-------|--------|---------------|------|

| No | Freq. | Corr. Factor | Reading Value | | Emission Level | | Limit | | Margin | |
|----------|----------------|--------------|---------------|--------------|----------------|--------------|--------------|--------------|--------------|--------------|
| | [MHz] | | [dB (uV)] | | [dB (uV)] | | [dB (uV)] | | (dB) | |
| | | | Q.P. | AV. | Q.P. | AV. | Q.P. | AV. | Q.P. | AV. |
| 1 | 0.15391 | 0.24 | 63.01 | 52.82 | 63.25 | 53.06 | 65.79 | 55.79 | -2.54 | -2.73 |
| 2 | 0.16562 | 0.26 | 62.57 | 49.48 | 62.83 | 49.74 | 65.18 | 55.18 | -2.35 | -5.44 |
| 3 | 0.17734 | 0.28 | 62.32 | 45.22 | 62.60 | 45.50 | 64.61 | 54.61 | -2.01 | -9.11 |
| 4 | 0.21250 | 0.31 | 58.62 | 44.85 | 58.93 | 45.16 | 63.11 | 53.11 | -4.18 | -7.95 |
| 5 | 0.26719 | 0.29 | 53.64 | 41.53 | 53.93 | 41.82 | 61.20 | 51.20 | -7.27 | -9.38 |
| 6 | 0.29453 | 0.28 | 50.34 | 36.12 | 50.62 | 36.40 | 60.40 | 50.40 | -9.77 | -13.99 |
| 7 | 0.31797 | 0.27 | 49.94 | 36.04 | 50.21 | 36.31 | 59.76 | 49.76 | -9.55 | -13.45 |

REMARKS:

1. Q.P. and AV. are abbreviations of quasi-peak and average individually.
2. The emission levels of other frequencies were very low against the limit.
3. Margin value = Emission level - Limit value
4. Correction factor = Insertion loss + Cable loss
5. Emission Level = Correction Factor + Reading Value.

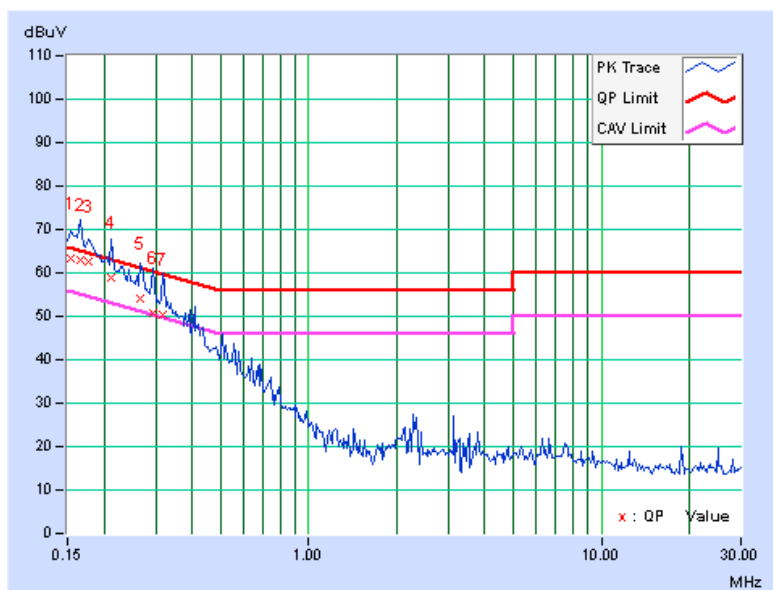

4.3 6dB BANDWIDTH MEASUREMENT

4.3.1 LIMITS OF 6dB BANDWIDTH MEASUREMENT

The minimum of 6dB Bandwidth Measurement is 0.5 MHz.

4.3.2 TEST SETUP

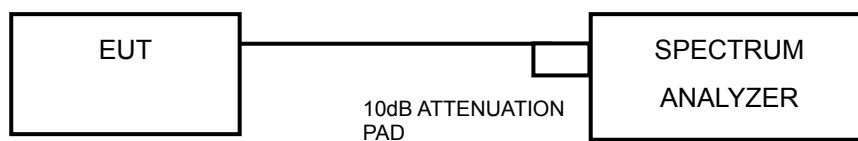

4.3.3 TEST INSTRUMENTS

Refer to section 4.1.2 to get information of above instrument.

4.3.4 TEST PROCEDURE

- a. Set resolution bandwidth (RBW) = approximately 1% of the emission bandwidth
- b. Set the video bandwidth (VBW) $\geq 3 \times$ RBW, Detector = Peak.
- c. Trace mode = max hold.
- d. Sweep = auto couple.
- e. Measure the maximum width of the emission that is constrained by the frequencies associated with the two amplitude points (upper and lower) that are attenuated by 6 dB relative to the maximum level measured in the fundamental emission

4.3.5 DEVIATION FROM TEST STANDARD

No deviation.

4.3.6 EUT OPERATING CONDITIONS

The software provided by client to enable the EUT under transmission condition continuously at lowest, middle and highest channel frequencies individually.



A D T

4.3.7 TEST RESULTS

802.11b

| CHANNEL | FREQUENCY (MHz) | 6dB BANDWIDTH (MHz) | | MINIMUM LIMIT (MHz) | PASS / FAIL |
|---------|-----------------|---------------------|---------|---------------------|-------------|
| | | CHAIN 0 | CHAIN 1 | | |
| 1 | 2412 | 10.32 | 10.27 | 0.5 | PASS |
| 6 | 2437 | 10.33 | 10.28 | 0.5 | PASS |
| 11 | 2462 | 10.20 | 10.31 | 0.5 | PASS |

802.11g

| CHANNEL | FREQUENCY (MHz) | 6dB BANDWIDTH (MHz) | | MINIMUM LIMIT (MHz) | PASS / FAIL |
|---------|-----------------|---------------------|---------|---------------------|-------------|
| | | CHAIN 0 | CHAIN 1 | | |
| 1 | 2412 | 16.52 | 16.50 | 0.5 | PASS |
| 6 | 2437 | 16.46 | 16.50 | 0.5 | PASS |
| 11 | 2462 | 16.45 | 16.58 | 0.5 | PASS |

802.11n (20MHz)

| CHANNEL | FREQUENCY (MHz) | 6dB BANDWIDTH (MHz) | | MINIMUM LIMIT (MHz) | PASS / FAIL |
|---------|-----------------|---------------------|---------|---------------------|-------------|
| | | CHAIN 0 | CHAIN 1 | | |
| 1 | 2412 | 17.64 | 17.72 | 0.5 | PASS |
| 6 | 2437 | 17.60 | 17.61 | 0.5 | PASS |
| 11 | 2462 | 17.83 | 17.60 | 0.5 | PASS |

802.11n (40MHz)

| CHANNEL | FREQUENCY (MHz) | 6dB BANDWIDTH (MHz) | | MINIMUM LIMIT (MHz) | PASS / FAIL |
|---------|-----------------|---------------------|---------|---------------------|-------------|
| | | CHAIN 0 | CHAIN 1 | | |
| 3 | 2422 | 36.98 | 36.64 | 0.5 | PASS |
| 6 | 2437 | 37.03 | 36.70 | 0.5 | PASS |
| 9 | 2452 | 37.36 | 36.73 | 0.5 | PASS |

4.4 CONDUCTED OUTPUT POWER

4.4.1 LIMITS OF CONDUCTED OUTPUT POWER MEASUREMENT

For systems using digital modulation in the 2400–2483.5 MHz bands: 1 Watt (30dBm)

4.4.2 TEST SETUP

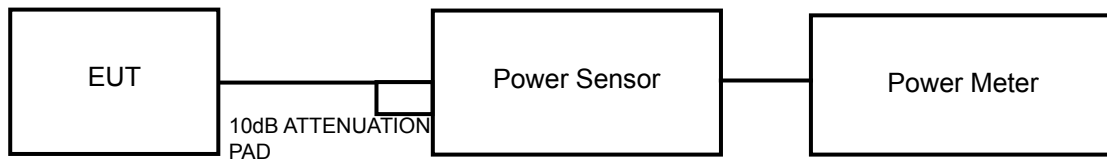

4.4.3 TEST INSTRUMENTS

Refer to section 4.1.2 to get information of above instrument.

4.4.4 TEST PROCEDURES

A peak power sensor was used on the output port of the EUT. A power meter was used to read the response of the peak power sensor. Record the peak power level.

4.4.5 DEVIATION FROM TEST STANDARD

No deviation.

4.4.6 EUT OPERATING CONDITIONS

Same as Item 4.3.6.

4.4.7 TEST RESULTS

802.11b

| CHAN. | FREQUENCY (MHz) | PEAK POWER (dBm) | | TOTAL POWER (mW) | TOTAL POWER (dBm) | LIMIT (dBm) | PASS / FAIL |
|-------|-----------------|------------------|---------|------------------|-------------------|-------------|-------------|
| | | CHAIN 0 | CHAIN 1 | | | | |
| 1 | 2412 | 18.68 | 18.79 | 149.47 | 21.75 | 30 | PASS |
| 6 | 2437 | 20.37 | 20.08 | 210.75 | 23.24 | 30 | PASS |
| 11 | 2462 | 21.32 | 20.01 | 235.75 | 23.72 | 30 | PASS |

NOTE: Directional gain = 0dBi + 10log(2) = 3.01dBi < 6dBi , so the conducted power limit shall be not reduced.

802.11g

| CHAN. | FREQUENCY (MHz) | PEAK POWER (dBm) | | TOTAL POWER (mW) | TOTAL POWER (dBm) | LIMIT (dBm) | PASS / FAIL |
|-------|-----------------|------------------|---------|------------------|-------------------|-------------|-------------|
| | | CHAIN 0 | CHAIN 1 | | | | |
| 1 | 2412 | 23.43 | 23.77 | 458.52 | 26.61 | 30 | PASS |
| 6 | 2437 | 24.07 | 24.18 | 517.09 | 27.14 | 30 | PASS |
| 11 | 2462 | 24.32 | 24.12 | 528.62 | 27.23 | 30 | PASS |

NOTE: Directional gain = 0dBi + 10log(2) = 3.01dBi < 6dBi , so the conducted power limit shall be not reduced.

802.11n (20MHz)

| CHAN. | FREQUENCY (MHz) | PEAK POWER (dBm) | | TOTAL POWER (mW) | TOTAL POWER (dBm) | LIMIT (dBm) | PASS / FAIL |
|-------|-----------------|------------------|---------|------------------|-------------------|-------------|-------------|
| | | CHAIN 0 | CHAIN 1 | | | | |
| 1 | 2412 | 23.32 | 23.48 | 437.63 | 26.41 | 30 | PASS |
| 6 | 2437 | 26.02 | 26.07 | 804.52 | 29.06 | 30 | PASS |
| 11 | 2462 | 25.18 | 25.02 | 647.30 | 28.11 | 30 | PASS |

802.11n (40MHz)

| CHAN. | FREQUENCY (MHz) | PEAK POWER (dBm) | | TOTAL POWER (mW) | TOTAL POWER (dBm) | LIMIT (dBm) | PASS / FAIL |
|-------|-----------------|------------------|---------|------------------|-------------------|-------------|-------------|
| | | CHAIN 0 | CHAIN 1 | | | | |
| 3 | 2422 | 21.31 | 21.52 | 277.11 | 24.43 | 30 | PASS |
| 6 | 2437 | 24.82 | 25.47 | 655.76 | 28.17 | 30 | PASS |
| 9 | 2452 | 22.32 | 21.89 | 325.13 | 25.12 | 30 | PASS |

4.5 POWER SPECTRAL DENSITY MEASUREMENT

4.5.1 LIMITS OF POWER SPECTRAL DENSITY MEASUREMENT

The Maximum of Power Spectral Density Measurement is 8dBm.

4.5.2 TEST SETUP

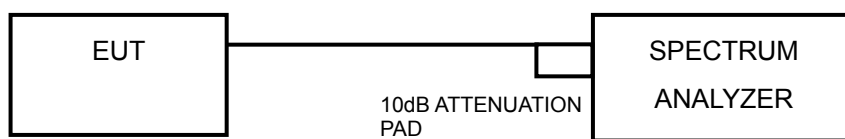

4.5.3 TEST INSTRUMENTS

Refer to section 4.1.2 to get information of above instrument.

4.5.4 TEST PROCEDURE

- Set the RBW = 100 kHz, VBW =300 kHz, Detector = peak.
- Sweep time = auto couple, Trace mode = max hold, allow trace to fully stabilize.
- Use the peak marker function to determine the maximum power level in any 100 kHz band segment within the fundamental EBW.
- Scale the observed power level to an equivalent value in 3 kHz by adjusting (reducing) the measured power by a bandwidth correction factor (BWCF) where $BWCF = 10\log(3 \text{ kHz}/100\text{kHz})$

4.5.5 DEVIATION FROM TEST STANDARD

No deviation.

4.5.6 EUT OPERATING CONDITION

Same as Item 4.3.6

4.5.7 TEST RESULTS

802.11b

| TX chain | Channel | FREQ. (MHz) | PSD (dBm/100kHz) | PSD (dBm/3kHz) | 10 log (N=2) dB | Total PSD (dBm/3kHz) | Limit (dBm/3kHz) | PASS /FAIL |
|----------|---------|-------------|------------------|----------------|-----------------|----------------------|------------------|------------|
| 0 | 1 | 2412 | 6.36 | -8.87 | 3.01 | -5.86 | 8 | PASS |
| | 6 | 2437 | 8.01 | -7.22 | 3.01 | -4.21 | 8 | PASS |
| | 11 | 2462 | 8.99 | -6.24 | 3.01 | -3.23 | 8 | PASS |
| 1 | 1 | 2412 | 5.09 | -10.14 | 3.01 | -7.13 | 8 | PASS |
| | 6 | 2437 | 6.87 | -8.36 | 3.01 | -5.35 | 8 | PASS |
| | 11 | 2462 | 6.54 | -8.69 | 3.01 | -5.68 | 8 | PASS |

NOTE: Directional gain = 0dBi + 10log(2) = 3.01dBi < 6dBi , so the power density limit shall be not reduced.

802.11g

| TX chain | Channel | FREQ. (MHz) | PSD (dBm/100kHz) | PSD (dBm/3kHz) | 10 log (N=2) dB | Total PSD (dBm/3kHz) | Limit (dBm/3kHz) | PASS /FAIL |
|----------|---------|-------------|------------------|----------------|-----------------|----------------------|------------------|------------|
| 0 | 1 | 2412 | 4.40 | -10.83 | 3.01 | -7.82 | 8 | PASS |
| | 6 | 2437 | 5.08 | -10.15 | 3.01 | -7.14 | 8 | PASS |
| | 11 | 2462 | 5.05 | -10.18 | 3.01 | -7.17 | 8 | PASS |
| 1 | 1 | 2412 | 2.81 | -12.42 | 3.01 | -9.41 | 8 | PASS |
| | 6 | 2437 | 4.23 | -11.00 | 3.01 | -7.99 | 8 | PASS |
| | 11 | 2462 | 3.21 | -12.02 | 3.01 | -9.01 | 8 | PASS |

NOTE: Directional gain = 0dBi + 10log(2) = 3.01dBi < 6dBi , so the power density limit shall be not reduced.

802.11n (20MHz)

| TX chain | Channel | FREQ. (MHz) | PSD (dBm/100kHz) | PSD (dBm/3kHz) | 10 log (N=2) dB | Total PSD (dBm/3kHz) | Limit (dBm/3kHz) | PASS /FAIL |
|----------|---------|-------------|------------------|----------------|-----------------|----------------------|------------------|------------|
| 0 | 1 | 2412 | 2.79 | -12.44 | 3.01 | -9.43 | 8 | PASS |
| | 6 | 2437 | 5.86 | -9.37 | 3.01 | -6.36 | 8 | PASS |
| | 11 | 2462 | 4.64 | -10.59 | 3.01 | -7.58 | 8 | PASS |
| 1 | 1 | 2412 | 2.61 | -12.62 | 3.01 | -9.61 | 8 | PASS |
| | 6 | 2437 | 5.89 | -9.34 | 3.01 | -6.33 | 8 | PASS |
| | 11 | 2462 | 4.59 | -10.64 | 3.01 | -7.63 | 8 | PASS |



A D T

802.11n (40MHz)

| TX chain | Channel | FREQ. (MHz) | PSD (dBm/100kHz) | PSD (dBm/3kHz) | 10 log (N=2) dB | Total PSD (dBm/3kHz) | Limit (dBm/3kHz) | PASS /FAIL |
|----------|---------|-------------|------------------|----------------|-----------------|----------------------|------------------|------------|
| 0 | 3 | 2422 | -3.63 | -18.86 | 3.01 | -15.85 | 8 | PASS |
| | 6 | 2437 | 0.36 | -14.87 | 3.01 | -11.86 | 8 | PASS |
| | 9 | 2452 | -2.13 | -17.36 | 3.01 | -14.35 | 8 | PASS |
| 1 | 3 | 2422 | -4.52 | -19.75 | 3.01 | -16.74 | 8 | PASS |
| | 6 | 2437 | 0.06 | -15.17 | 3.01 | -12.16 | 8 | PASS |
| | 9 | 2452 | -2.52 | -17.75 | 3.01 | -14.74 | 8 | PASS |

4.6 CONDUCTED OUT OF BAND EMISSION MEASUREMENT

4.6.1 LIMITS OF CONDUCTED OUT OF BAND EMISSION MEASUREMENT

Below -20dB of the highest emission level of operating band (in 100kHz Resolution Bandwidth).

4.6.2 TEST SETUP

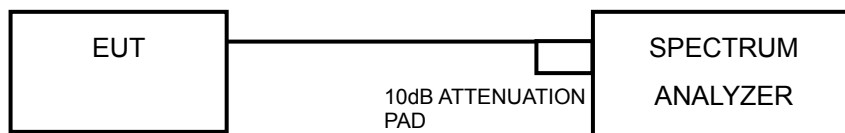

4.6.3 TEST INSTRUMENTS

Refer to section 4.1.2 to get information of above instrument.

4.6.4 TEST PROCEDURE

MEASUREMENT PROCEDURE REF

1. Set the RBW = 100 kHz.
2. Set the VBW \geq 300 kHz.
3. Detector = peak.
4. Sweep time = auto couple.
5. Trace mode = max hold.
6. Allow trace to fully stabilize.
7. Use the peak marker function to determine the maximum power level in any 100 kHz band segment within the fundamental EBW.

MEASUREMENT PROCEDURE OOB

1. Set RBW = 100 kHz.
2. Set VBW \geq 300 kHz.
3. Set span to encompass the spectrum to be examined.
4. Detector = peak.
5. Trace Mode = max hold.
6. Sweep = auto couple.

4.6.5 DEVIATION FROM TEST STANDARD

No deviation.

4.6.6 EUT OPERATING CONDITION

Same as Item 4.3.6

4.6.7 TEST RESULTS

The spectrum plots are attached on the following pages. D1 line indicates the highest level, and D2 line indicates the 20dB offset below D1. It shows compliance with the requirement.



A D T

802.11b

CH 1

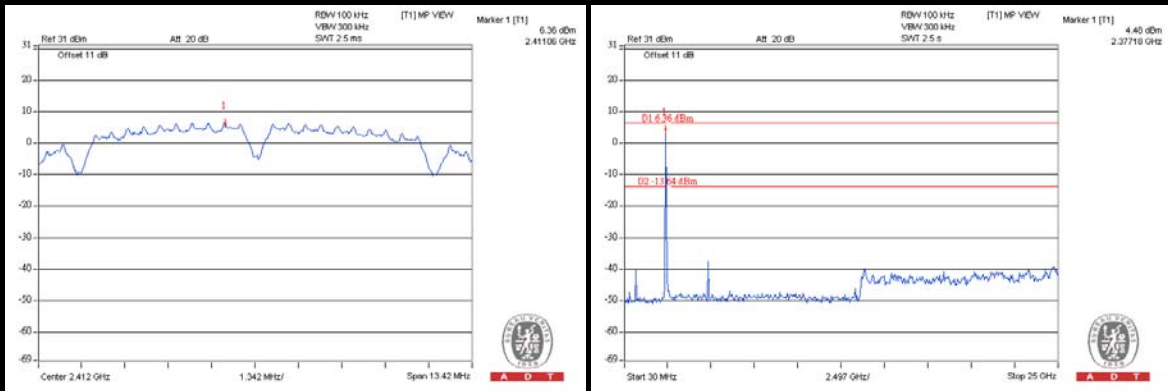

CH 6

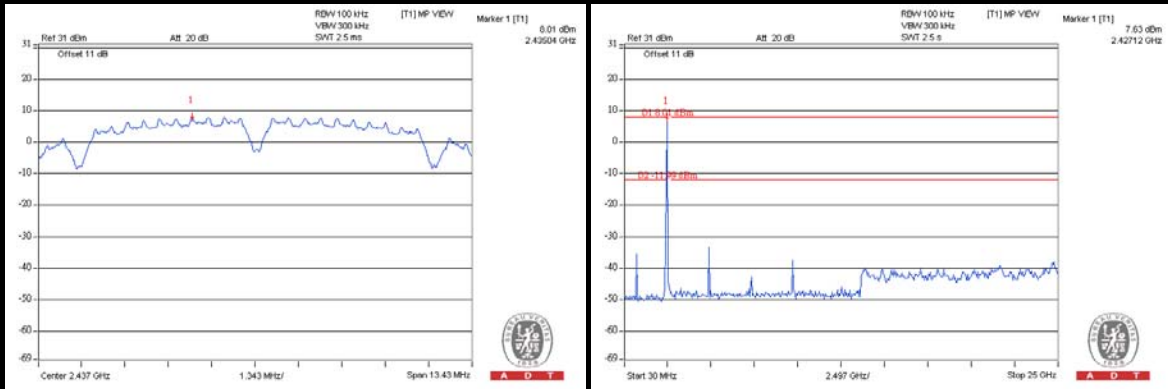

CH 11

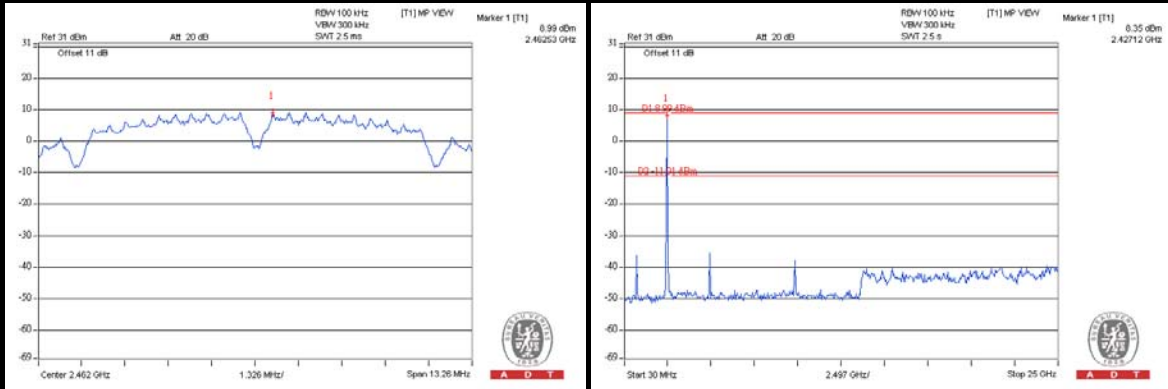

802.11g

CH 1

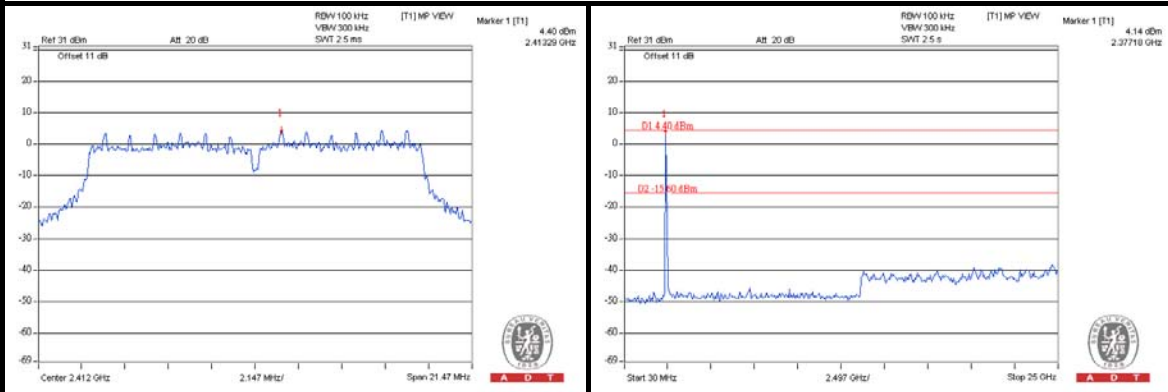

CH 6

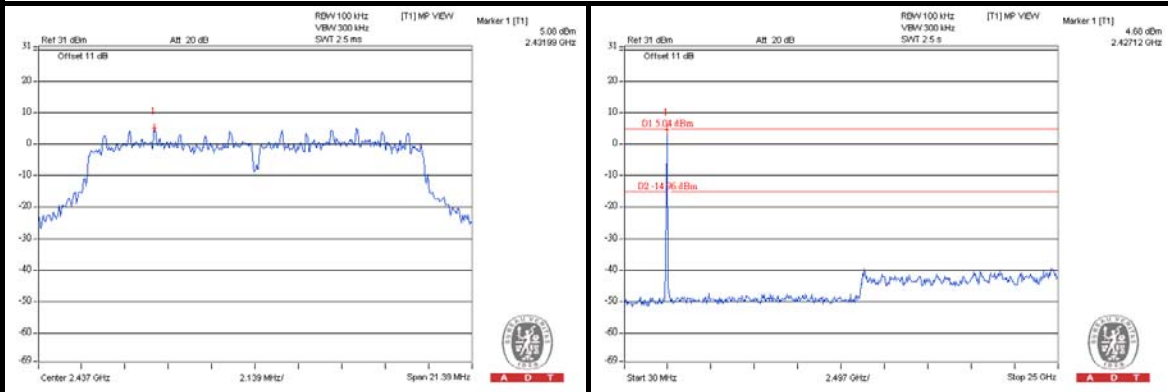

CH 11

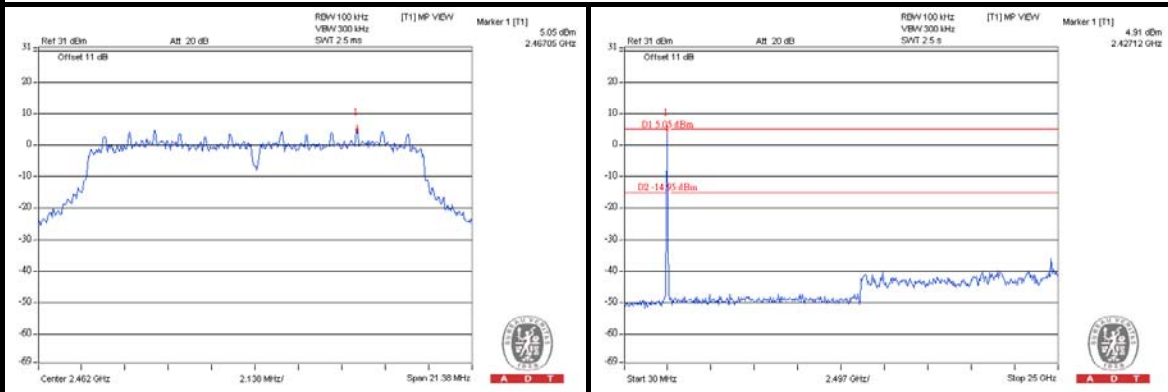

802.11n (20MHz)

CH 1

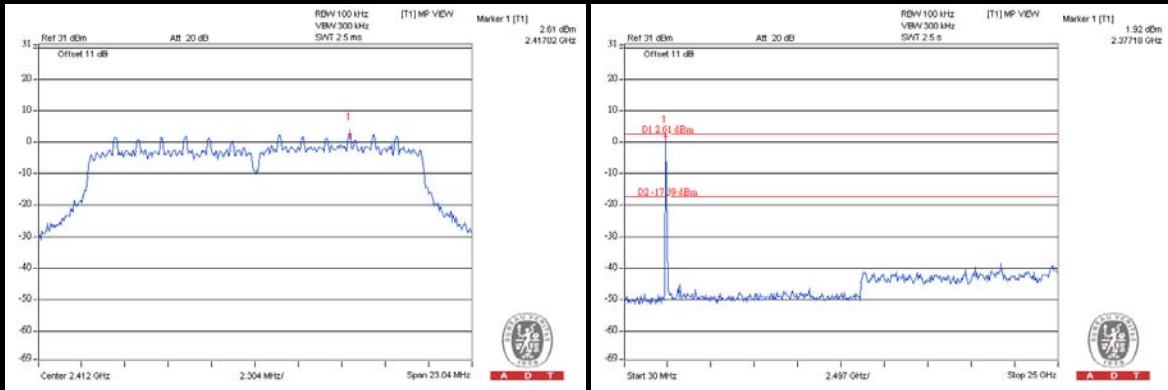

CH 6

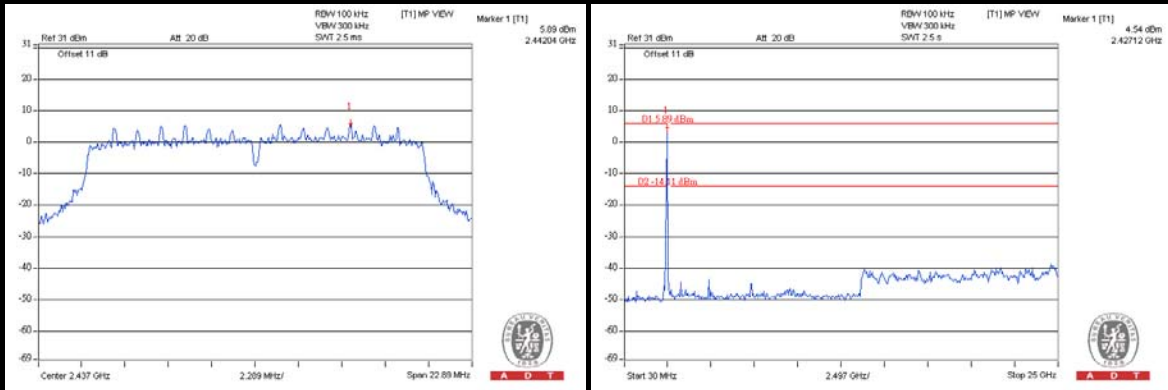

CH 11

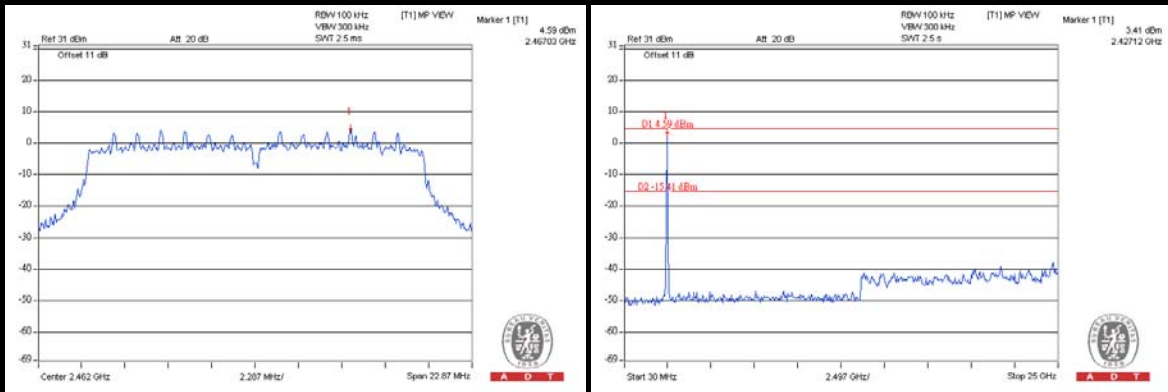

802.11n (40MHz)

CH 3

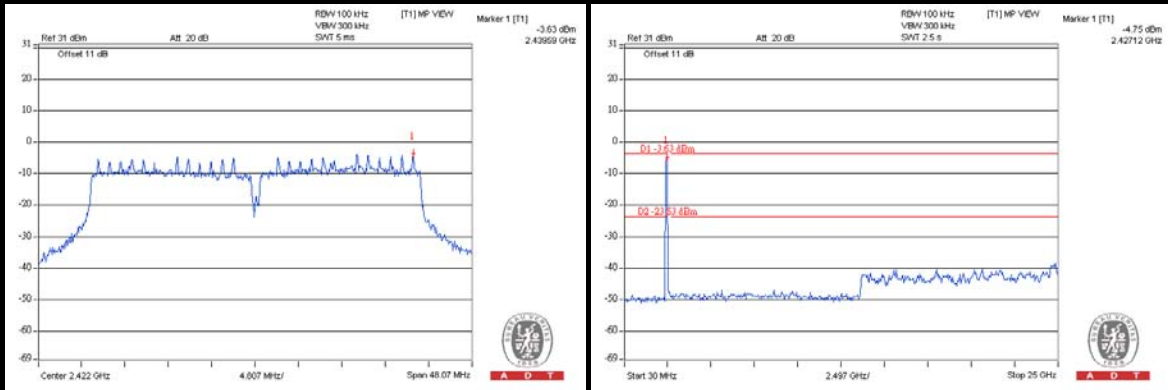

CH 6

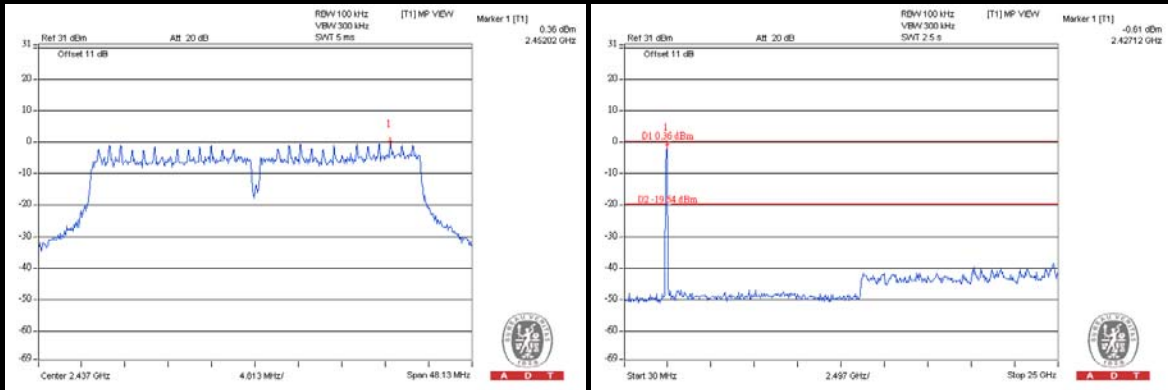

CH 9

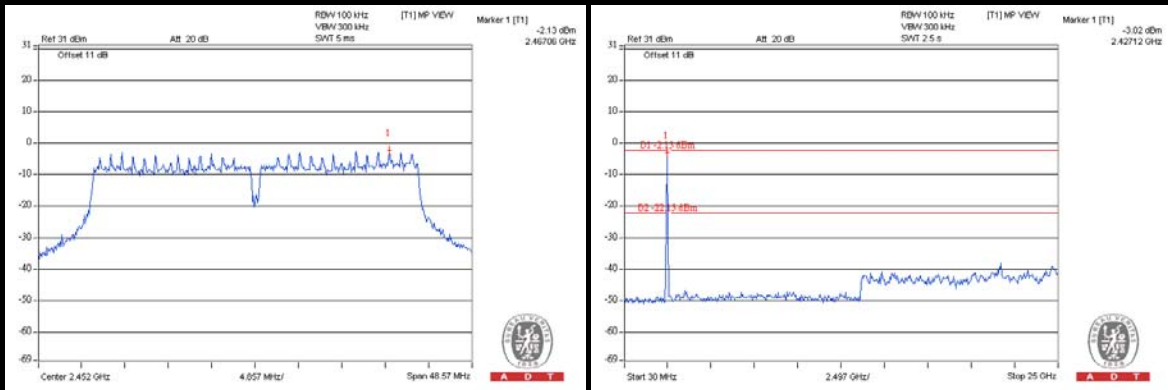



A D T

5. PHOTOGRAPHS OF THE TEST CONFIGURATION

Please refer to the attached file (Test Setup Photo).



6. INFORMATION ON THE TESTING LABORATORIES

We, Bureau Veritas Consumer Products Services (H.K.) Ltd., Taoyuan Branch, were founded in 1988 to provide our best service in EMC, Radio, Telecom and Safety consultation. Our laboratories are accredited and approved according to ISO/IEC 17025.

If you have any comments, please feel free to contact us at the following:

Linko EMC/RF Lab:

Tel: 886-2-26052180

Fax: 886-2-26051924

Hsin Chu EMC/RF Lab:

Tel: 886-3-5935343

Fax: 886-3-5935342

Hwa Ya EMC/RF/Safety Telecom Lab:

Tel: 886-3-3183232

Fax: 886-3-3270892

Email: service.adt@tw.bureauveritas.com

Web Site: www.adt.com.tw

The address and road map of all our labs can be found in our web site also.

7. APPENDIX A - MODIFICATIONS RECORDERS FOR ENGINEERING CHANGES TO THE EUT BY THE LAB

No any modifications are made to the EUT by the lab during the test.

---END---