



## Model: CON1001TH-1

### INSTALLATION AND OPERATING INSTRUCTIONS

MULTI-FUNCTION WIRELESS REMOTE CONTROL SYSTEM FOR OPERATING A LATCHING SOLENOID VALVE, MANUALLY OR WITH A THERMOSTAT FUNCTION

**IF YOU CANNOT READ OR UNDERSTAND THESE INSTALLATION INSTRUCTIONS  
DO NOT ATTEMPT TO INSTALL OR OPERATE**

#### INTRODUCTION

This remote control system was developed to provide a safe, reliable, and user-friendly remote control system for gas heating appliances. The system is operated manually from the transmitter. The system operates on radio frequencies (RF) within a 20-foot range using non-directional signals. The system operates on one of 1,048,576 security codes that are programmed into the transmitter at the factory; the remote receiver's code must be matched to that of the transmitter prior to initial use.

**Review COMMUNICATION SAFETY under GENERAL INFORMATION section. This safety feature shuts down the appliance when a potentially unsafe condition exists.**

**NOTE:** This product is designed for use with an attended hearth appliance or fire feature. Adults must be present when the Control System is operating. DO NOT program or thermostatically set this Control to operate a hearth appliance or fire feature when Adults are not physically present. Furthermore, DO NOT leave the hearth appliance or fire feature burning unattended; it may cause damage or serious injury. If an Adult is going to be away from the hearth appliance or fire feature for any length of time, then the handheld/wall mount, receiver/control module and application should be in the "OFF" position.

#### TRANSMITTER

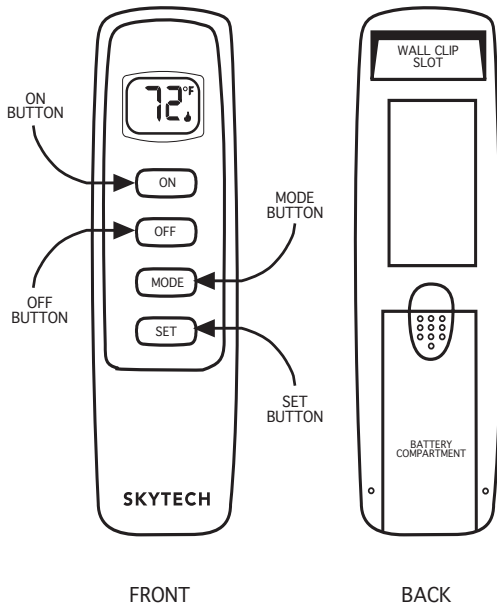

This remote control SYSTEM offers the user a battery-operated remote control to power a latching solenoid such as those used with gas valves used in some heater rated gas logs, gas fireplaces and other gas heating appliances.

The solenoid circuit uses the battery power from the receiver to operate a solenoid. The circuit has reversing polarity software which reverses the positive (+) and negative (-) output of the receiver's battery power to drive a latching solenoid ON/OFF. The SYSTEM is controlled by the remote transmitter.

The transmitter operates on a (2) 1.5V AAA batteries.

It is recommended that ALKALINE batteries always be used for longer battery life and maximum operational performance.

Before using the transmitter, install the (2) AAA transmitter batteries into the battery compartment. (Use caution that batteries are installed in the proper direction)

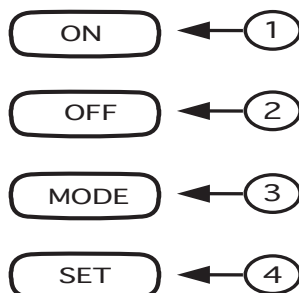

#### BUTTON SETTINGS

1. ON - Operates unit to on position, Manually operated solenoid ON.
2. OFF - Operates unit to off position, Manually operated solenoid OFF.
3. MODE - Changes unit from manual mode to thermo mode.
4. SET - Sets temperature in thermo mode.

## LCD DISPLAY FUNCTIONS

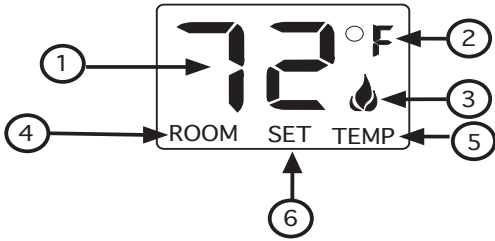

1. DISPLAY Indicates CURRENT room temperature .
2. °F OR °C Indicates degrees Fahrenheit or Celsius.
3. FLAME Indicates burner/valve in operation.
4. ROOM Indicates remote is in THERMO operation.
5. TEMP Appears during manual operation.
6. SET Appears during time the of setting the desired temperature in the thermo operation.

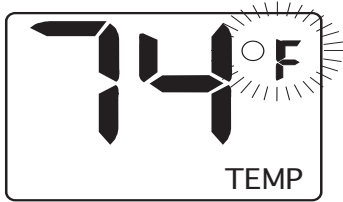

## SETTING °F / °C SCALE

The factory setting for temperature is °F. To change this setting to °C, first:

- Press the ON key and the OFF key on the transmitter at the same time this will change from °F to °C. Follow this same procedure to change from °C back to °F.



Screen view pressing ON button

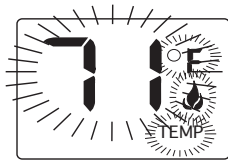

Screen view after 3 second default

## MANUAL FUNCTION

To operate the system in the manual "MODE" do the following:

### **ON OPERATION**

Press the ON key the appliance flame will come ON. During this time the LCD screen will show ON, after 3 seconds the LCD screen will default to display room temperature and the word TEMP will show. (Flame icon will appear on LCD screen in manual ON mode)



Screen view pressing OFF button

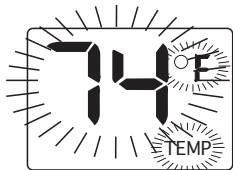

Screen view after 3 second default

### **OFF OPERATION**

Press the OFF key the appliance flame will shut OFF. During this time the LCD screen will show OF (OFF), after 3 seconds the LCD screen will default to display room temperature and the word TEMP will show.

## THERMOSTAT FUNCTION

### **SETTING DESIRED ROOM TEMPERATURE**

This remote control system can be thermostatically controlled when the transmitter is in the THERMO mode (The word ROOM must be displayed on the screen). To set the THERMO MODE and DESIRED room temperature,

Press the MODE key until the LCD screen shows the word ROOM, then the remote is in the thermostatic mode.

### **TO CHANGE THE SET TEMPERATURE**

Press and hold the SET button until the desired set temperature is reached. (By pressing and holding the set button the LCD screen set numbers will increase from 45° to 99° then restart over at 45°) Next release the SET button. The LCD screen will display the set temperature for 3 seconds and the LCD screen will flash the set temperature for 3 seconds, then the LCD screen will default to display the room temperature.

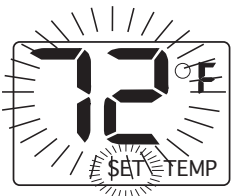

Thermo SET

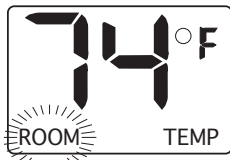

Thermo MODE

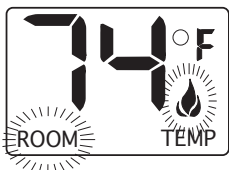

Thermo ON

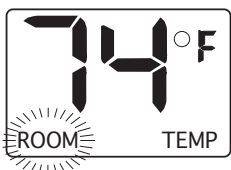

Thermo OFF

## OPERATIONAL NOTES

The Thermo Feature on the transmitter operates the appliance whenever the ROOM TEMPERATURE varies a certain number of degrees from the SET TEMPERATURE. This variation is called the “SWING” or TEMPERATURE DIFFERENTIAL. The normal operating cycle of an appliance may be 2-4 times per hour depending on how well the room or home is insulated from the cold or drafts. The factory setting for the “swing number” is 2. This represents a temperature variation of +/- 2°F (1°C) between SET temperature and ROOM temperature, which determines when the fireplace will be activated.

The transmitter has ON and OFF manual functions that are activated by pressing either button on the face of the transmitter. When a button on the transmitter is pressed the word ON or OF will appear on the LCD screen to show while the signal is being sent. Upon initial use, there may be a delay of three seconds before the remote receiver will respond to the transmitter. This is part of the system’s design.

## POWER SETTING – CON1001TH-1

The electronics in the remote control system have the capability of “powering” two different types of DC-powered components. If any operational problems are noted, contact Skytech Systems, Inc.

The RECEIVER comes from the factory programmed to provide pulse DC voltage (5.5 VDC to 6.3 VDC) to a latching solenoid.

## REMOTE RECEIVER

### IMPORTANT

**THE REMOTE RECEIVER SHOULD BE POSITIONED WHERE AMBIENT TEMPERATURES DO NOT EXCEED 130° F.**

The remote receiver (right) operates on (4) 1.5V AA-size batteries. It is recommended that ALKALINE batteries be used for longer battery life and maximum microprocessor performance. **IMPORTANT:** New or fully charged batteries are essential to proper operation of the remote receiver as a latching solenoid power consumption is substantially higher than standard remote control systems.

**NOTE:** The remote receiver will only respond to the transmitter when the 3-position slide button on the remote receiver is in the REMOTE position. The remote receiver houses the microprocessor that responds to commands from the transmitter to control system operation.

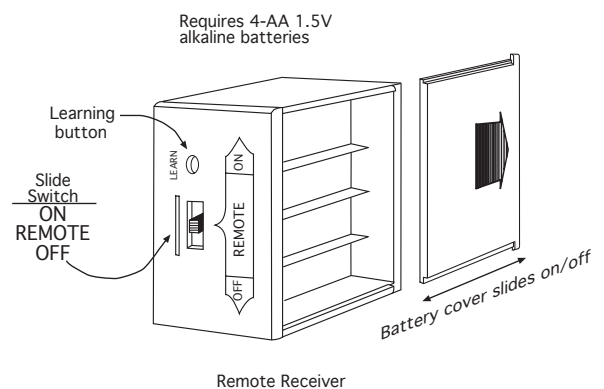

## RECEIVER FUNCTIONS:

- With the slide switch in the REMOTE position, the system will only operate if the remote receiver receives commands from the transmitter.
- Upon initial use or after an extended period of no use, the ON button may have to be pressed for up to three seconds before activating servo motor. If the system does not respond to the transmitter on initial use, see LEARNING TRANSMITTER TO RECEIVER.
- With the slide switch in the ON position you can manually turn ON the system.
- With the slide in the OFF position, the system is OFF.
- It is suggested that the slide switch be placed in the OFF position if you will be away from your home for an extended period of time.
- Placing the slide switch in the OFF position also functions as a safety "lock out" by both turning the system OFF and rendering the transmitter inoperative.

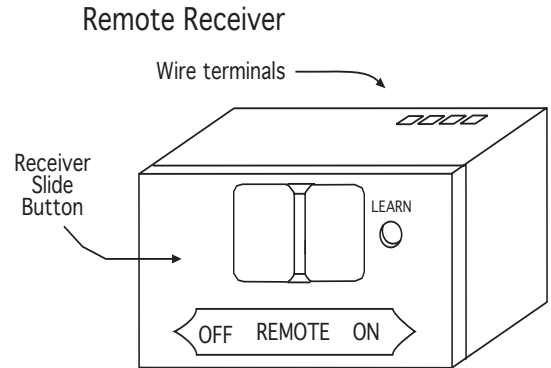

## INSTALLATION INSTRUCTIONS

### WARNING

**DO NOT CONNECT REMOTE RECEIVER DIRECTLY TO 110-120VAC POWER. THIS WILL BURN OUT THE RECEIVER. FOLLOW INSTRUCTIONS FROM MANUFACTURER OF GAS VALVE FOR CORRECT WIRING PROCEDURES. IMPROPER INSTALLATION OF ELECTRIC COMPONENTS CAN CAUSE DAMAGE TO GAS VALVE AND REMOTE RECEIVER.**

The remote receiver can be mounted on or near the fireplace hearth. PROTECTION FROM EXTREME HEAT IS VERY IMPORTANT. Like any piece of electronic equipment, the remote receiver should be kept away from temperatures exceeding 130° F inside the receiver case. Battery life is also significantly shortened if batteries are exposed to high temperatures.

### HEARTH MOUNT

The remote receiver can be placed on the fireplace hearth or under the fireplace, behind the control access panel. Position where the ambient temperature inside the receiver case does not exceed 130° F.

**NOTE:** Black Button is used on Hearth Mount Applications

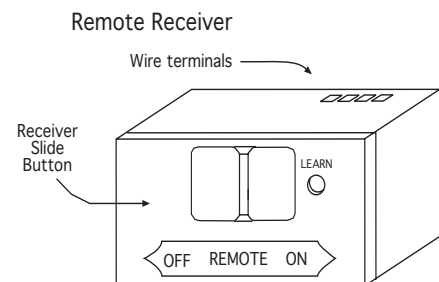

## WIRING INSTRUCTIONS

Make sure the remote receiver switch is in the OFF position. For best results it is recommended that 18 gauge stranded wires should be used to make connections and no longer than 20-feet.

This CON1001 TH remote receiver is to be connected to a manual valve with a latching ON/OFF solenoid.

Connect two 18 gauge stranded or solid wires from the remote receiver terminals to the latching solenoid. (See drawings to the right)

**IMPORTANT NOTE:** Operation of this control is dependent on which wire is attached to which terminal. If operation of control does not correspond to operating buttons on transmitter, reverse wire installation at the receiver or at the control.

**NOTE:** Up to 6.3 VDC of power is provided at the receiver terminal.

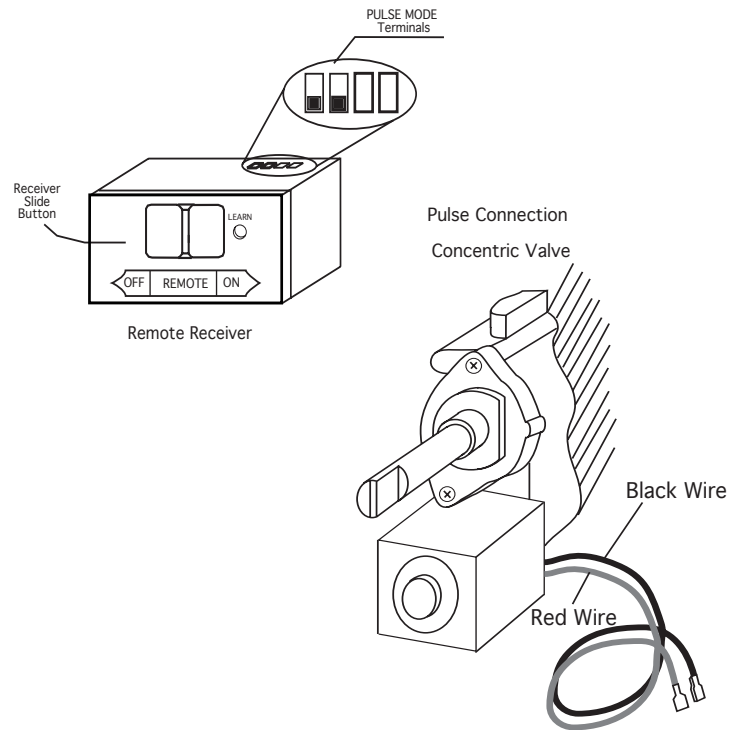

## GENERAL INFORMATION

### **COMMUNICATION – SAFETY – TRANSMITTER – (C/S – TX)**

This SKYTECH remote control has a COMMUNICATION –SAFETY function built into its software. It provides an extra margin of safety when the TRANSMITTER is out of the normal 20-foot operating range of the receiver.

The COMMUNICATION – SAFETY feature operates in the following manner, in all OPERATING MODES – ON/ ON THERMO.

At all times and in all OPERATING MODES, the transmitter sends an RF signal every fifteen (15) minutes, to the receiver, indicating that the transmitter is within the normal operating range of 20-feet. Should the receiver NOT receive a transmitter signal every 15 minutes, the IC software, in the RECEIVER, will begin a 2-HOUR (120-minute) countdown timing function. If during this 2-hour period, the receiver does not receive a signal from the transmitter, the receiver will shut down the appliance being controlled by the receiver. The RECEIVER will then emit a series of rapid “beeps” for a period of 10 seconds. Then after 10 seconds of rapid beeping, the RECEIVER will continue to emit a single “beep” every 4 seconds until a transmitter ON or MODE Button is pressed to reset the receiver. The intermittent 4-second beeping will go on for as long as the receiver’s batteries last which could be in excess of one year.

To “reset” the RECEIVER and operate the appliance, you must press the ON or MODE button on the transmitter. By turning the system to ON, the COMMUNICATION -SAFETY operation is overridden and the system will return to normal operation depending on the MODE selected at the transmitter. The COMMUNICATION – SAFETY feature will reactivate should the transmitter be taken out of the normal operating range or should the transmitter’s batteries fail or be removed.

## **CHILDPROOF (CP) FEATURE**

This SKYTECH remote control includes a CHILDPROOF “LOCK-OUT” feature that allows the user to “LOCK-OUT” operation of the appliance, from the TRANSMITTER.

### **SETTING “LOCK-OUT” – (CP)**

- To activate the “LOCK-OUT” feature, press and hold the ON button and the MODE button at the same time for 5 seconds. The letters CP will appear in the TEMP frame on the LCD screen.
- To disengage the “LOCK-OUT”, press and hold the ON button and the MODE button at the same time for 5 seconds and the letters CP will disappear from the LCD screen and the transmitter will return to its normal operating condition.
- To verify that transmitter is in the CP lock-out mode press any key and the LCD screen will show “CP”

**NOTE:** If the appliance is already operating in the ON or THERMO MODES, engaging the “LOCK-OUT” will not cancel the operating MODE. Engaging the “LOCK-OUT” prevents only the manual operation of the TRANSMITTER. If in the auto modes, the THERMO operation will continue to operate normally. To totally “LOCK-OUT” the operation of the TRANSMITTER’S operating signals; the transmitter’s MODE must be set to OFF.

## **LEARNING TRANSMITTER TO RECEIVER**

Each transmitter uses a unique security code. It will be necessary to press the LEARN button on the receiver to accept the transmitter security code upon initial use, if batteries are replaced, or if a replacement transmitter is purchased from your dealer or the factory. In order for the receiver to accept the transmitter security code, be sure the slide button on the receiver is in the REMOTE position; the receiver will not LEARN if the slide switch is in the ON or OFF position. The LEARN button is located on the front face of the receiver; inside the small hole labeled LEARN. Using a small screwdriver or end of a paper clip gently press and release the black LEARN button inside the hole. When you release the LEARN button the receiver will emit an audible “beep”. After the receiver emits the beep press the transmitter ANY button and release. The receiver will emit several beeps indicating that the transmitter’s code has been accepted into the receiver.

The microprocessor that controls the security code matching procedure is controlled by a timing function. If you are unsuccessful in matching the security code on the first attempt, wait 1 - 2 minutes before trying again--this delay allows the microprocessor to reset its timer circuitry--and try up to two or three more times.

## **TRANSMITTER WALL CLIP**

The transmitter can be hung on a wall using the clip provided. If the clip is installed on a solid wood wall, drill 1/8” pilot holes and install with the screws provided. If it is installed on a plaster/wallboard wall, first drill two 1/4” holes into the wall. Then use a hammer to tap in the two plastic wall anchors flush with the wall; then install the screws provided.

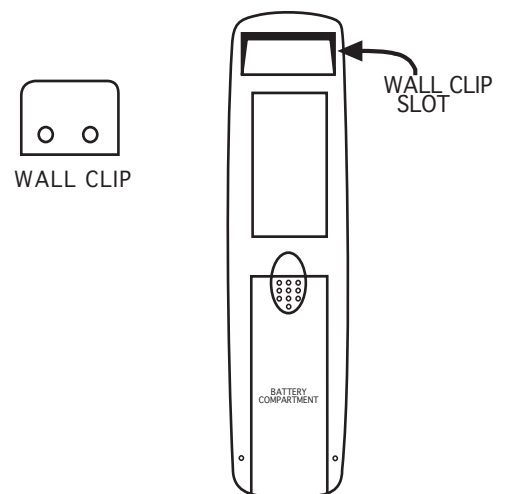

## **BATTERY LIFE**

Life expectancy of the alkaline batteries in the CON1001-TH can be up to 12 months depending on use of the solenoid function. Replace all batteries annually. When the transmitter no longer operates the remote receiver from a distance it did previously (i.e., the transmitter’s range has decreased) or the remote receiver does not function at all, the batteries should be checked. It is important that the remote receiver batteries are fully charged, providing combined output voltage of at least 5.5volts. The transmitter should operate with as little as 2.5 volts battery power.

## **TROUBLE SHOOTING**

If you encounter problems with your fireplace system, the problem may be the fireplace itself or it could be with the CON1001TH-1 remote system. Review the fireplace manufacturer's operation manual to make sure all connections are properly made. Then check the operation of the remote in the following manner:

- Make sure the batteries are correctly installed in the RECEIVER. One reversed battery will keep receiver from operating properly.
- Check battery in TRANSMITTER to ensure contacts are touching (+) and (-) ends of battery. Bend metal contacts in for tighter fit.
- Be sure RECEIVER and TRANSMITTER is within 20 to 25-foot operating range.
- Clear Codes: Memory in the receiver might be full if the learn button is pressed too many times. If this happens it will not allow any more codes to be learned and no audible beep will be heard. To clear memory, place the receiver slide switch into the REMOTE position. Press the learn button and release after 10 seconds. You should hear three (3) long audible beeps indicating all codes have cleared. You can now "learn" the transmitter to the receiver as described in the General Information Section.
- Keep RECEIVER from temperatures exceeding 130°F. Battery life shortened when ambient temperatures are above 115°F.
- If RECEIVER is installed in tightly enclosed metal surround, the operating distance will be shortened.

## **SPECIFICATIONS**

**BATTERIES:** Transmitter (2) 1.5 volt AAA batteries  
Remote Receiver 6V - 4 ea. AA 1.5 Alkaline  
Operating Frequency: 303.8 MHZ

## **FCC REQUIREMENTS**

NOTE: THE MANUFACTURER IS NOT RESPONSIBLE FOR ANY RADIO OR TV INTERFERENCE CAUSED BY UNAUTHORIZED MODIFICATIONS TO THE EQUIPMENT. SUCH MODIFICATIONS COULD VOID THE USER'S AUTHORITY TO OPERATE THE EQUIPMENT

### **Federal Communication Commission Interference Statement**

This equipment has been tested and found to comply with the limits for a Class B digital device, pursuant to Part 15 of the FCC Rules.

These limits are designed to provide reasonable protection against harmful interference in a residential installation. This equipment generates, uses, and can radiate radio frequency energy and, if not installed and used in accordance with the instructions, may cause harmful interference to radio communications. However, there is no guarantee that interference will not occur in a particular installation.

If this equipment does cause harmful interference to radio or television reception, which can be determined by turning the equipment off and on, the user is encouraged to try to correct the interference by one or more of the following measures:

- Reorient or relocate the receiving antenna.
- Increase the separation between the equipment and receiver.
- Connect the equipment into an outlet on a circuit different from that to which the receiver is connected.
- Consult the dealer or an experienced radio/TV technician for help.

This device complies with Industry Canada license - exempt RSS standard(s).

Operation is subject to the following two conditions:

- (1) This device may not cause interference, and
- (2) This device must accept any interference, including interference that may cause undesired operation of the device.

Cet appareil est conforme aux normes RSS exemptes de licence d'Industrie Canada.

Le fonctionnement est soumis aux deux conditions suivantes:

- (1) Cet appareil ne doit pas causer d'interférences et
- (2) Cet appareil doit accepter toute interférence, y compris les interférences pouvant entraîner un fonctionnement indésirable de l'appareil.

This device complies with RSS 210 of Industry Canada. This Class B device meets all the requirements of the Canadian interference-causing equipment regulations.

Cet appareil est conforme à la norme RSS 210 d'Industrie Canada. Cet appareil de classe B respecte toutes les exigences du règlement canadien sur le matériel brouilleur.



## LIMITED WARRANTY

1. **Limited Warranty.** Skytech II, Inc. ("Skytech") warrants that each new Skytech Remote Control System, including all hardware, parts and components (the "System"), when used in accordance with the instructions furnished by Skytech provided with each System, shall be free in all material respects of defects in material and workmanship, subject to proper installment and normal use (the "Warranty"). The Warranty extends only to the original retail purchaser of the System (the "Customer"), is not transferable, and expires upon any sale or transfer of the System by the Customer.
2. **System Sold As Is.** Subject to this Warranty and any applicable state law, each System is sold by Skytech to a Customer on an "as is" basis. In addition, each System and Skytech's obligations are and remain subject to all additional disclaimers, limitations, reservations of rights, exclusions, and qualifications set forth on Skytech's website, [www.skytechpg.com](http://www.skytechpg.com), all of which are considered part of the Warranty and are incorporated herein (collectively, the "Additional Terms"). Each Customer, by purchasing and/or using any System or any portion thereof, does so subject to the Warranty and the Additional Terms.
3. **Repair or Replacement of System or Parts.** Should any System, or any hardware, components and/or parts contained therein fail due to a defect in workmanship or material provided by Skytech after the purchase of a System by a Customer, Skytech shall repair or, at its option, replace the defective System or part, hardware, or component, subject to the Customer's compliance with all terms and conditions contained herein governing service and claims under the Warranty. Skytech shall provide replacement parts at no charge for the first (5) five years of this warranty, and at market cost for the Lifetime of the product to the Customer. Gas valve and gas valve components will be available at no charge for one (1) year. If Skytech does not have the parts for an individual model, then a replacement System will be provided at no charge within the first (5) five years after purchase, and then at market cost for the Lifetime of that product to the Customer.
4. **Warranty Claims; Skytech Service.** To submit a valid claim under the Warranty (each, a "Valid Claim"), a Customer must comply with the following:
  - (a) Provide written notice to a Skytech or an Authorized Dealer ("Dealer") and provide the Name, Address and Telephone Number of the Customer.
  - (b) Describe the System model number and nature of the defect, nonconformity, or other problem with the System;
  - (c) Provide such notice within thirty (30) days of discovery of such defect, nonconformity, or problem;
  - (d) Obtain a Return Merchandise Authorization ("RMA") number from Skytech by calling (855) 498-8324; and
  - (e) Securely pack and ship the defective System to Skytech at 9230 Conservation Way, Fort Wayne, IN 46809, at the Customer's cost, within thirty (30) days from the date Skytech issued the RMA to the Customer with the RMA number clearly marked on the outside of the box containing the returned System.

Any shipment that does not meet all the Valid Claim requirements may be refused by Skytech. Skytech is not responsible for any refused shipments, or any damage caused due to shipping, whether or not it was a Valid Claim. Skytech shall be responsible for return shipment charges for any System returned should Skytech determine there is no defect with the System, reject for failure of the Customer to submit a Valid Claim, or otherwise determine is not eligible for service under the Warranty.

Upon receipt of a Valid Claim and the properly returned System, Skytech shall, at its option, either (a) repair the System, at no charge to the Customer, or (b) replace the returned System with a new System, at no charge to the Customer, or (c) provide the Customer with a refund in an amount equal to the price paid by the Customer for the defective System. Any System or hardware, component or part repaired by Skytech hereunder, or any replacement System, hardware, component or part shall be shipped to the Customer by Skytech at Skytech's cost and the Warranty, the Additional Terms, and all other terms and conditions set forth herein shall extend to such repaired or replacement System, hardware, component or part. No refund shall be paid by Skytech before the defective System, hardware, component and/or part are received by Skytech from the Customer. Any obligation of Skytech under this Section 4 shall be and remain subject to Skytech's right to physically inspect the defective System, hardware, component and/or part returned to Skytech by the Customer.

5. Some States do not allow the exclusion or limitation of incidental and consequential damages or limitation on how long an implied warranty lasts, so the above limitation may not apply to you. This warranty gives you specific rights and you may have other rights, which vary from state, province, or nation. To the extent allowable under any law, the liability of Skytech is limited to the express terms of this warranty, and Skytech expressly disclaims all implied warranties, including any warranties of fitness for a particular purpose or merchantability.

### How to Obtain Service:

In addition to the foregoing, contact Skytech or your Skytech Dealer direct with the following information:

- Name, Address, Telephone Number of Customer
- Date of Purchase, Proof of Purchase
- Model Name, Date Code of Product, and any relevant information or circumstances, concerning installation, mode of operation and/or when defect was noted

Warranty claim process will start with all this information. Skytech reserves the right to physically inspect the product for defects, by authorized representatives.

**Print information below and return form to:**

Skytech Products Group, 9230 Conservation Way,  
Fort Wayne, IN. 46809; Attn. Warranty Dept  
Phone: (855) 498-8224

Warranty Information

Purchase Date: \_\_\_\_\_ Model: \_\_\_\_\_ Date Code: \_\_\_\_\_

Note: Date code may be in one of two formats -

(1) Printed 4-digit number: YYMM format. Example: 2111 = 2021, November

(2) Check box with date code marked: 2-year boxes and 1-12 month box format. Example:

21'	<input checked="" type="checkbox"/>	1	2	3	4	5	6
22'	<input type="checkbox"/>	7	8	9	10	<input checked="" type="checkbox"/>	12

= 2021, November

Purchased From: \_\_\_\_\_

Customer Name: \_\_\_\_\_ Phone: \_\_\_\_\_

Address: \_\_\_\_\_

City: \_\_\_\_\_ State/Prov. \_\_\_\_\_ Zip/Postal Code \_\_\_\_\_

E-mail Address: \_\_\_\_\_

**Please send a "Proof of Purchase" (original receipt) copy along with your warranty form.**

**FOR TECHNICAL  
SERVICE, CALL:**

**U.S. INQUIRIES**  
(855) 498-8324 or (260) 459-1703

**CANADIAN INQUIRIES**  
(877) 472-3923

Skytech Products Group  
9230 Conservation Way  
Fort Wayne, IN 46809  
Sales Support: (888) 699-6167  
Website: www.skytechpg.com

**MANUFACTURED EXCLUSIVELY FOR SKYTECH II, INC**

