

Model: 4001TH-A TX

INSTALLATION AND OPERATING INSTRUCTIONS

IF YOU CANNOT READ OR UNDERSTAND THESE INSTALLATION INSTRUCTIONS DO NOT ATTEMPT TO INSTALL OR OPERATE

INTRODUCTION

This remote control system was developed to provide a safe, reliable and user-friendly remote control system for gas heating appliances. It has a built-in thermostat. This all battery system operates independently of household current. The system operates on radio frequencies with a non-directional signals. The systems operating range is approximately 20-feet. The system operates on one of 10,000,000 security codes that are programmed into the transmitter at the factory, the remote receiver's code must be matched to that of the transmitter prior to initial use. It is designed to be used with millivolt gas valves as a dry contact switch.

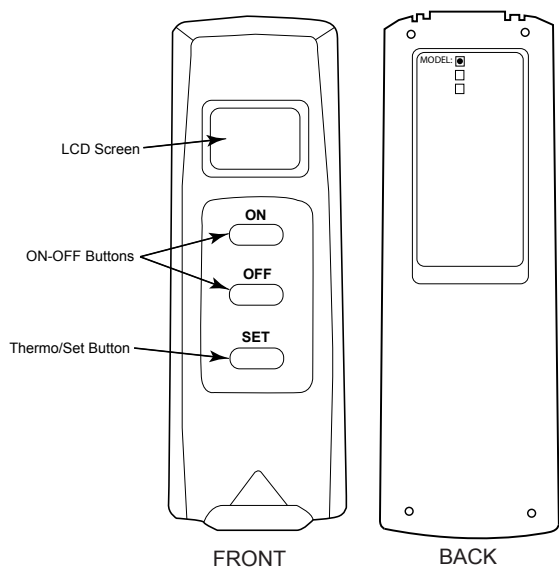

The transmitter has ON and OFF and THERMOSTAT functions. If the LCD screen is not working, check the position of the transmitter's battery.

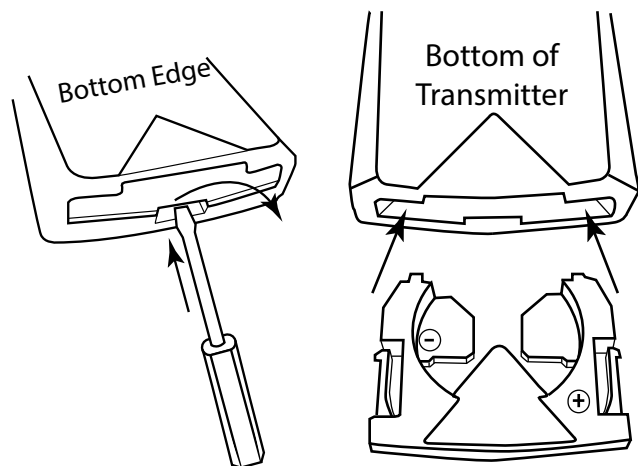

The transmitter operates on (1) 3V Button Cell (included) that powers the RF signal. Before using the transmitter, the 3V battery must be installed into the battery compartment.

Tools Needed: Small jewelers screwdriver

To remove the battery holder from the bottom of the transmitter insert a small jewelers screwdriver into the notch at the bottom of the transmitter, then gently pry out the battery holder out. Once it is started, it will pull out with your fingers. Insert the 3-volt button cell battery in the battery holder with the plus (+) side up. See the drawings at the right.

It is recommended that CR2032 lithium battery always be used for longer battery life and maximum operational performance.

- 1 ON - Operates unit to ON position, Manually ON.
 - 2 OFF - Operates unit to OFF position, Manually OFF.
 - 3 SET - Sets temperature in THERMO mode.
-

Liquid Crystal Display (LCD)

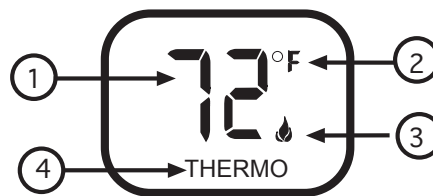

- 1 ROOM Temperature
- 2 °F or °C Icon
- 3 "ON" Flame Icon
- 4 THERMO Mode



SETTING °F / °C

- The factory setting for temperature is °F. To change this setting to °C, press the ON key and the OFF key on the transmitter at the same time. Follow this same procedure to change from °C back to °F.

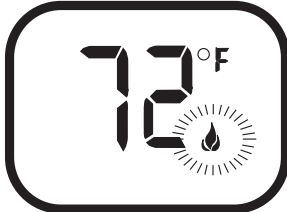

MANUAL FUNCTION

To operate the system manually perform the following:

ON OPERATION

Press the ON key the appliance flame will come ON. The Flame icon will appear on LCD screen in ON mode

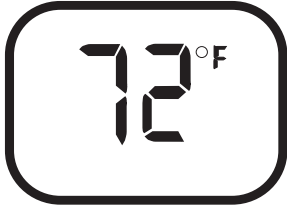

OFF OPERATION

Press the OFF key the appliance flame will shut OFF. The Flame icon will not appear on LCD screen in OFF mode

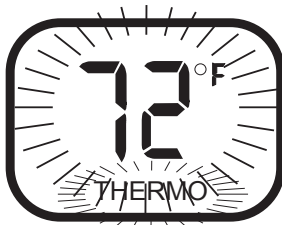

THERMO-SET

THERMOSTAT FUNCTION

SETTING DESIRED ROOM TEMPERATURE

This remote control system can be thermostatically controlled when the transmitter is in the THERMO mode (The word THERMO must be displayed on the screen). To set the THERMO MODE and DESIRED room temperature, press the SET button and the word THERMO will appear on the LCD screen; remote is now in the thermostatic mode.

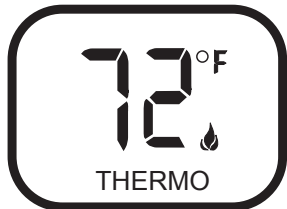

THERMO-ON

TO CHANGE SET TEMPERATURE

Press and hold the SET button until the desired set temperature is reached. (By pressing and holding the SET button the LCD screen numbers will increase from 45° to 99° then restart over at 45° again) Next release the SET button. The LCD screen will display the set temperature for 3 seconds and the LCD screen will flash the set temperature for 3 seconds, then the LCD screen will default to display the room temperature:

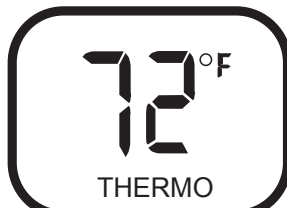

THERMO-OFF

NOTE: The highest SET temperature is 99° Fahrenheit (37° Celsius) and the lowest temperature is 45° Fahrenheit (7° Celsius).

When THERMO is operating in the **ON** position, the LCD screen will read THERMO at the bottom with the flame icon. See THERMO-ON drawing.

When THERMO is OFF, the flame icon will not be displayed. See THERMO-OFF drawing.

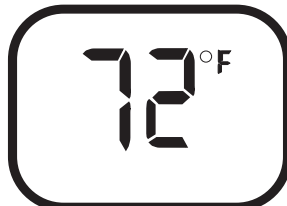

Press and release the OFF button to disengage the thermo mode. The word THERMO on the LCD screen will not show when the thermo is not in operation.

REMOTE RECEIVER

The remote receiver operates on 4 AA-size 1.5V batteries. It is recommended that ALKALINE batteries be used for longer battery life and maximum microprocessor performance. **IMPORTANT:** New or fully charged batteries are essential for proper operation of the remote receiver.

The remote receiver houses the microprocessor that responds to commands from the transmitter to control system operation. The remote receiver has a 3-position slide switch for selecting the MODE of operation: OFF/REMOTE/ON

- With the slide switch in the ON position the system will remain on until the slide switch is placed in the OFF or REMOTE position.
- With the slide switch in the REMOTE position (centered), the system will only operate if the remote receiver receives commands from the transmitter. If the system does not work see LEARNING TRANSMITTER TO RECEIVER Section.
- With the slide switch in the OFF position the system is OFF.
- It is suggested that the slide switch be placed in the off position if you will be away from your home for an extended period of time. Placing the slide switch in the OFF position also functions as a safety "lock-out" by both turning the system off and rendering the remote receiver inoperative.

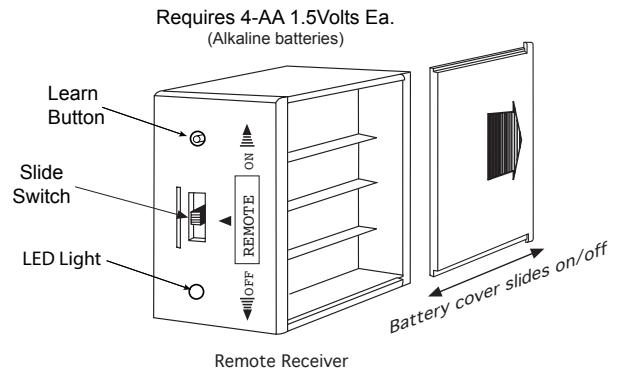

NOTE: This product is designed for use with an attended hearth appliance or fire feature. Adults must be present when the Control System is operating. DO NOT program or thermostatically set this Control to operate a hearth appliance or fire feature when adults are not physically present. Furthermore, DO NOT leave the hearth appliance or fire feature burning unattended; it may cause damage or serious injury. If an adult is going to be away from the hearth appliance or fire feature for any length of time, then the handheld/wall mount, receiver/control module and application should be in the "OFF" position.

INSTALLATION INSTRUCTIONS

WARNING

This remote control system must be installed exactly as outlined in these instructions. Read all instructions completely before attempting installation. Follow instructions carefully during installation. Any modifications of the remote control or any of its components will void the warrant and may be pose a fire hazard.

Do not connect any gas valve or electronic module directly to 110-120VAC power. Consult gas appliance manufacturer's instructions and wiring schematics for proper placement of all wires. All electronic modules are to be wired to manufacturer's specifications.

The following wiring diagrams are for illustration purpose only. Follow instructions from manufacturer of gas valve and/or electronic module for correct wiring procedures. Improper installation of electric components can cause damage to electronic module, gas valve and remote receiver.

RECEIVER INSTALLATION

The remote receiver can be either wall-mounted in a standard plastic switch box or placed on or near the fireplace hearth. Preferably, the remote receiver should be wall-mounted in a plastic switch box. When locating the receiver at the hearth PROTECTION FROM EXTREME HEAT IS VERY IMPORTANT. Like any piece of electronic equipment, the remote receiver should be kept away from temperatures exceeding 130° F inside the receiver case. Battery life is also significantly shortened if batteries are exposed to high temperatures.

Make sure the remote receiver switch is in the OFF position. It is recommended that 18 gauge solid or stranded wires (included) be used to make connections between the terminal wiring block on the millivolt gas valve or electronic module and the wire terminals on the remote receiver. For the best results use wire with no splices and measuring no longer than 20-feet.

WALL MOUNTING RECEIVER

Install (4) AA-size 1.5 ALKALINE batteries in the remote receiver. For best performance, remote receiver batteries should be factory fresh when installed. Very little battery power is required to operate the remote receiver, but the electronics are tuned to operate best when total battery output is greater than 5.3 volts. Four new AA batteries should provide a total output voltage of 6.0 to 6.2 volts. Be sure batteries are installed with the (+) and (-) ends facing the correct direction.

To attach Cover Plate to Receiver Box:

Position the receiver as shown in diagram to the left with lower tab on cover plate inserted into groove of receiver (Make sure LEARN hole on cover plate properly aligns with remote receiver) Pull Receiver up and snap into top tab of cover plate.

Position the cover plate so the word ON is facing up; then, install the remote receiver into the plastic switch box using the two long screws provided. Push the white slide button over the receiver slide switch.

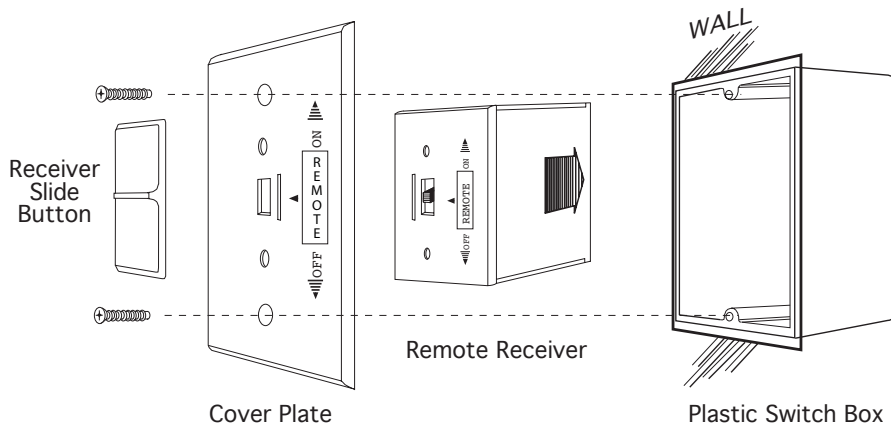
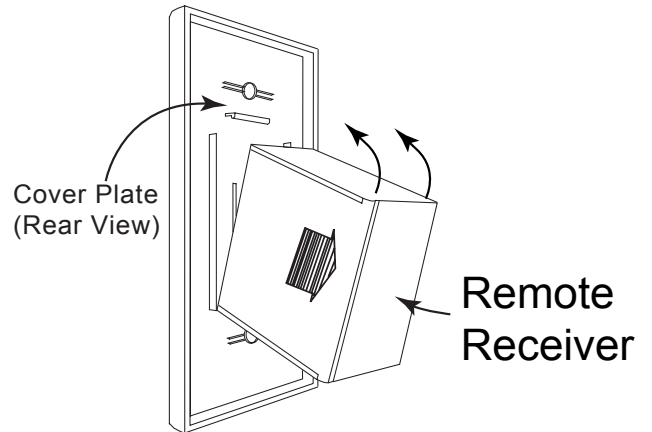

NOTE: The remote receiver will only respond to the transmitter when the 3-position slide button on the remote receiver is in the REMOTE position. If the system does not respond to the battery transmitter on initial use, see LEARNING TRANSMITTER TO RECEIVER, and recheck battery positions in the remote receiver.

HEARTH MOUNT

The remote receiver can be placed on the fireplace hearth or under the fireplace, behind the control access panel.

Position where the ambient temperature inside the receiver case does not exceed 130° F. **NOTE:** Black slide button (accessory pack) is used on Hearth Mount Applications.

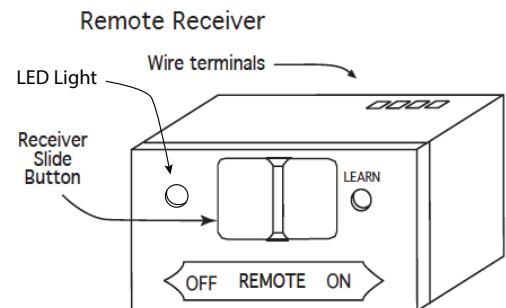

WIRING INSTRUCTIONS

A qualified electrician or a gas technician who is familiar with the gas appliance and gas valves that will be operated by this remote should install the remote control system. Incorrect wiring connections WILL cause damage to the gas valve or electronic module operating the gas appliance and may also damage the remote receiver.

WIRING MILLIVOLT VALVES

The remote receiver is connected to the millivolt valve using the TH (thermostat) terminals (TH & TH/TP) on the terminal block on the millivolt gas valve. Connect 18 gauge solid or stranded wires from the remote receiver to the gas valve.

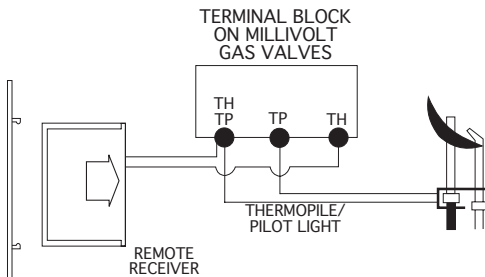

Operation of the remote receiver is similar to that of a thermostat in that both turn the gas valve ON and OFF based on input signals. A thermostat's input signals are different temperatures. The remote receiver's input signals come from the transmitter.

Connect each of the two wires leading from the TH terminals on the millivolt gas valve to either of the two wire terminals on the remote receiver. Normally it does not matter which wires go to which terminal. They are not polarity sensitive.

WIRING ELECTRONIC SPARK IGNITIONS

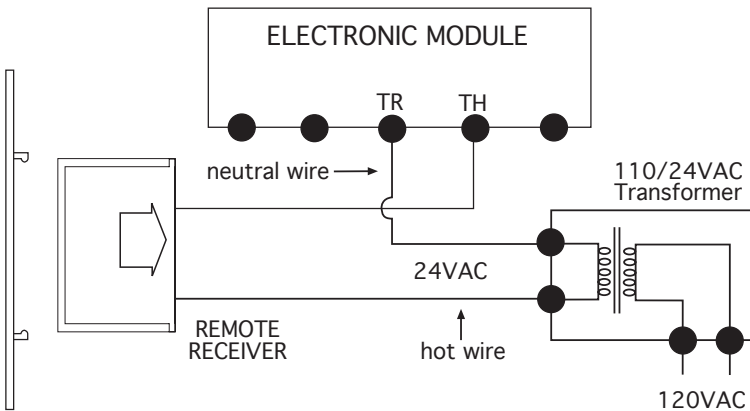

The remote control receiver can be connected, in series, to a 24VAC transformer to the TR (transformer) terminal on the ELECTRONIC MODULE. Connect the hot wire from the 24VAC transformer to either of the wire terminals on the remote receiver. Connect another wire (not included) between the other receiver wire terminal and the TH (thermostat) terminal on the ELECTRONIC MODULE.

SYSTEM CHECK

MILLIVOLT VALVES

Light your gas appliance following the lighting instructions that came with the appliance. Confirm that the pilot flame is ON; it must be in operation for the main gas valve to operate.

- Slide the 3-position button on the remote receiver to the ON position. The main gas flame (i.e., the fire) should ignite.
- Slide the button to OFF. The flame should extinguish (the pilot flame will remain ON).
- Slide the button to REMOTE (the center position), and then press the ON button on the transmitter to turn the system to ON. The main gas flame should ignite.
- Press the OFF button on the transmitter to turn the system to OFF. The flame should extinguish (the pilot flame will remain on).
- Press the MODE button on the transmitter to change the system to THERMO. Advance the SET temperature on the transmitter to a temperature of at least 1°F (1°C) above the ROOM temperature displayed on the LCD screen. Flame icon will appear and fireplace should light.
- Set the SET temperature to at least 1°F (1°C) below the room temperature and the system flame will extinguish in a few seconds. Thereafter, it should continue to cycle ON and OFF thermostatically as the ROOM temperature changes, but only when the temperature differential between ROOM and SET temperatures differ at least 1°F (1°C). The 1° F differential is the factory setting.

SYSTEM CHECK

ELECTRONIC IGNITION SYSTEMS

- Slide the 3-position button on the remote receiver to the ON position. The spark electrode should begin sparking to ignite the pilot (the pilot may ignite after only one spark). After the pilot flame is lit, the main gas valve should open and the main gas flame should ignite.
- Slide the button to OFF. The main gas flame and pilot flame should BOTH extinguish.
- Slide the button to REMOTE (the center position), and then press the ON button on the transmitter to turn the system to ON. The spark electrode should begin sparking to ignite the pilot. After the pilot is lit, the main gas valve should open and the main gas flame should ignite.
- Press the OFF button on the transmitter to OFF. The main gas flame and pilot flame should BOTH extinguish.
- Press the MODE button on the transmitter to change the system to THERMO. Advance the SET temperature on the transmitter to a temperature of at least 1°F (1°C) above the ROOM temperature displayed on the LCD screen. Flame icon will appear and fireplace should light.
- Set the SET temperature to at least 1°F (1°C) below the room temperature and the system flame will extinguish in a few seconds. Thereafter, it should continue to cycle ON and OFF thermostatically approximately every two minutes as the ROOM temperature changes, but only when the temperature differential between ROOM and SET temperatures differ at least 1°F (1°C). (The 1°F differential is the factory setting).

LEARNING TRANSMITTER TO RECEIVER

Each transmitter uses a unique security code. The receiver will learn up to three (3) security codes. It will be necessary to press and release the LEARN button on the receiver to accept the transmitter security code upon initial use or if a replacement transmitter is purchased from your dealer or the factory. In order for the receiver to accept the transmitter security code, be sure the slide button on the receiver is in the REMOTE position; the receiver will not LEARN if the slide switch is in the ON or OFF position. The LEARN button is located on the front face of the receiver; inside the small hole labeled LEARN. Using a small screwdriver or a tip of a pencil gently press and release the LEARN button inside the hole. When you release the LEARN button the LED light on the receiver will begin flashing every 1-second. Press ANY button on the transmitter and release. The LED light will flash quickly, indicating that the transmitter's code has been accepted into the receiver. To "clear" the learn memory, press and hold the learn button for 10-seconds. The LED light will flash three (3) times to indicate the memory is cleared.

BATTERY LIFE

Life expectancy of the alkaline batteries in the transmitter should be at least 12 months. Check and replace all batteries annually. When the transmitter no longer operates the remote receiver from a distance it did previously (i.e. transmitter's range has decreased) or the remote receiver does not function at all, the batteries should be checked. It is important that the remote receiver batteries are fully charged and provides continuous output voltage of at least 5.3 volts. The transmitter should operate with as little as 2.5-volts battery power.

TROUBLE SHOOTING

If you encounter problems with your fireplace system, the problem may be with the fireplace itself or it could be with the remote. Review the fireplace manufacturer's operation manual to make sure all connections are properly made. Then check the operation of the remote in the following manner:

- Make sure the batteries are correctly installed in the RECEIVER. One reversed battery will keep receiver from operating properly.
- Check battery in Transmitter to make sure it is installed with the (+) side up.
- See LEARNING TRANSMITTER TO RECEIVER section.
- Keep RECEIVER from temperatures exceeding 130° F. Battery life shortened when ambient temperatures are above 130° F.
- If RECEIVER is installed in tightly enclosed metal surround, the operating distance will be shortened.
- Ensure the transmitter is within 20-25 feet of the receiver for proper operating range.

Federal Communication Commission Interference Statement

This device complies with part 15 of the FCC Rules. Operation is subject to the following two conditions:

(1) This device may not cause harmful interference, and (2) this device must accept any interference received, including interference that may cause undesired operation.

Note: This equipment has been tested and found to comply with the limits for a Class B digital device, pursuant to part 15 of the FCC Rules. These limits are designed to provide reasonable protection against harmful interference in a residential installation. This equipment generates, uses and can radiate radio frequency energy and, if not installed and used in accordance with the instructions, may cause harmful interference to radio communications. However, there is no guarantee that interference will not occur in a particular installation. If this equipment does cause harmful interference to radio or television reception, which can be determined by turning the equipment off and on, the user is encouraged to try to correct the interference by one or more of the following measures:

—Reorient or relocate the receiving antenna.

—Increase the separation between the equipment and receiver.

—Connect the equipment into an outlet on a circuit different from that to which the receiver is connected.

—Consult the dealer or an experienced radio/TV technician for help.

Note: The Grantee is not responsible for any changes or modifications not expressly approved by the party responsible for compliance. such modifications could void the user's authority to operate the equipment.

IC Warning

This device complies with Industry Canada license-exempt RSS standard(s).

Operation is subject to the following two conditions: (1) this device may not cause interference, and (2) this device must accept any interference, including interference that may cause undesired operation of the device.

Le présent appareil est conforme aux CNR d'Industrie Canada applicables aux appareils radio exempts de licence.

L'exploitation est autorisée aux deux conditions suivantes : (1) l'appareil ne doit pas produire de brouillage, et (2)

l'utilisateur de l'appareil doit accepter tout brouillage radioélectrique subi, même si le brouillage est susceptible d'en compromettre le fonctionnement.

SPECIFICATIONS

BATTERIES: Transmitter 3V button cell (CR2032)

Remote Receiver 6V – 4ea. AA 1.5 Alkaline

FCC ID No.'s. Transmitter: K9L-4001THATX Canadian IC ID No.'s: Transmitter 2439A-4001THATX

Operating Frequency: 433.92MHZ

See your supplier for warranty details of this product.