



TEST REPORT

BNetzA-CAB-02/21-102

Test report no.: 1-3693/21-01-09

Testing laboratory

CTC advanced GmbH
Untertuerkheimer Strasse 6 – 10
66117 Saarbruecken / Germany
Phone: + 49 681 5 98 - 0
Fax: + 49 681 5 98 - 9075
Internet: <http://www.ctcadvanced.com>
e-mail: mail@ctcadvanced.com

Accredited Testing Laboratory:

The testing laboratory (area of testing) is accredited according to DIN EN ISO/IEC 17025 (2005) by the Deutsche Akkreditierungsstelle GmbH (DAkkS). The accreditation is valid for the scope of testing procedures as stated in the accreditation certificate starting with the registration number: D-PL-12076-01.

Applicant

Rosemount Tank Radar AB
Layoutvägen 1
P O Box 150
435 33 Mölnlycke / SWEDEN
Phone: +46 31 3370 0000
Contact: Björn Hallberg
e-mail: Bjorn.Hallberg@Emerson.com
Phone: +46 313 370 765

Manufacturer

Rosemount Tank Radar AB
P O Box 150
Layoutvägen 1
435 33 Mölnlycke / SWEDEN

Test standard/s

47 CFR Part 15 Title 47 of the Code of Federal Regulations; Chapter I; Part 15 – Radio frequency devices
RSS-211 Level Probing Radar Equipment
For further applied test standards please refer to section 3 of this test report.

Test Item

Kind of test item: 77-81 GHz level probing radar
Model name: Rosemount 3408 Level Transmitter
FCC ID: K8C3408L
K8C3408LB
IC: 2827A-3408L
2827A-3408LB
Frequency: 77 – 81 GHz
Technology tested: FMCW radar
Antenna: Lens antenna (ATAP antenna)
Power supply: 24 V (min. 18 to max. 35 V DC)
Temperature range: -40° to +85°

This test report is electronically signed and valid without handwritten signature. For verification of the electronic signatures, the public keys can be requested at the testing laboratory.

Test report authorized:

Meheza Walla
Lab Manager
Radio Communications

Test performed:

Thomas Vogler
Lab Manager
Radio Communications

1 Table of contents

1	Table of contents	2
2	General information	3
2.1	Notes and disclaimer.....	3
2.2	Application details.....	3
2.3	Test laboratories sub-contracted.....	3
3	Test standard/s, references and accreditations	4
4	Reporting statements of conformity – decision rule	5
5	Test environment	6
6	Test item.....	6
6.1	General description	6
6.2	Additional information.....	6
7	Description of the test setup	7
7.1	Shielded semi anechoic chamber	8
7.2	Shielded fully anechoic chamber	10
7.3	Radiated measurements > 18 GHz.....	11
7.4	Radiated measurements > 50/85 GHz.....	11
7.5	AC power-line conducted emissions.....	13
8	Sequence of testing	14
8.1	Sequence of testing radiated spurious 9 kHz to 30 MHz.....	14
8.2	Sequence of testing radiated spurious 30 MHz to 1 GHz	15
8.3	Sequence of testing radiated spurious 1 GHz to 18 GHz	16
8.4	Sequence of testing radiated spurious above 18 GHz	17
8.5	Sequence of testing radiated spurious above 50/85 GHz with external mixers.....	18
9	Measurement uncertainty	19
10	Far field consideration for measurements above 18 GHz	19
11	Summary of measurement results.....	20
12	Summary of measurement results.....	21
12.1	Frequency stability and fundamental bandwidth	21
12.2	Fundamental emissions	23
12.3	Unwanted emissions limit.....	26
12.4	Antenna beamwidth and antenna side lobe gain	34
12.5	Emissions from digital circuitry	35
12.6	Spurious emissions conducted < 30 MHz (AC power line)	36
13	Glossary.....	39
14	Document history	40
15	Accreditation Certificate – D-PL-12076-01-04.....	40
16	Accreditation Certificate – D-PL-12076-01-05.....	41

2 General information

2.1 Notes and disclaimer

The test results of this test report relate exclusively to the test item specified in this test report. CTC advanced GmbH does not assume responsibility for any conclusions and generalizations drawn from the test results with regard to other specimens or samples of the type of the equipment represented by the test item.

The test report may only be reproduced or published in full. Reproduction or publication of extracts from the report requires the prior written approval of CTC advanced GmbH.

The testing service provided by CTC advanced GmbH has been rendered under the current "General Terms and Conditions for CTC advanced GmbH".

CTC advanced GmbH will not be liable for any loss or damage resulting from false, inaccurate, inappropriate or incomplete product information provided by the customer.

Under no circumstances does the CTC advanced GmbH test report include any endorsement or warranty regarding the functionality, quality or performance of any other product or service provided.

Under no circumstances does the CTC advanced GmbH test report include or imply any product or service warranties from CTC advanced GmbH, including, without limitation, any implied warranties of merchantability, fitness for purpose, or non-infringement, all of which are expressly disclaimed by CTC advanced GmbH.

All rights and remedies regarding vendor's products and services for which CTC advanced GmbH has prepared this test report shall be provided by the party offering such products or services and not by CTC advanced GmbH. In no case this test report can be considered as a Letter of Approval.

This test report is electronically signed and valid without handwritten signature. For verification of the electronic signatures, the public keys can be requested at the testing laboratory.

2.2 Application details

Date of receipt of order:	2021-12-21
Date of receipt of test item:	2022-04-20
Start of test:	2022-04-25
End of test:	2022-06-28
Person(s) present during the test:	Mr. Anders Jirskog (during set-up) Mr. Magnus Olsson (during set-up)

2.3 Test laboratories sub-contracted

None



3 Test standard/s, references and accreditations

Test standard	Date	Description
---------------	------	-------------

Test standard	Date	Description
47 CFR Part 15		Title 47 of the Code of Federal Regulations; Chapter I; Part 15 – Radio frequency devices
RSS-211	2015-03	Level Probing Radar Equipment
890966 D01 v01r01	2014-09	Measurement Procedure for Level Probing Radars

Reference	Version	Description
ANSI C63.4-2014	-/-	American national standard for methods of measurement of radio-noise emissions from low-voltage electrical and electronic equipment in the range of 9 kHz to 40 GHz
ANSI C63.10-2013	-/-	American national standard of procedures for compliance testing of unlicensed wireless devices

Accreditation	Description
---------------	-------------

D-PL-12076-01-04	<p>Telecommunication and EMC Canada https://www.dakks.de/as/ast/d/D-PL-12076-01-04.pdf</p> 
D-PL-12076-01-05	<p>Telecommunication FCC requirements https://www.dakks.de/files/data/as/pdf/D-PL-12076-01-05e.pdf</p> 

4 Reporting statements of conformity – decision rule

Only the measured values related to their corresponding limits will be used to decide whether the equipment under test meets the requirements of the test standards listed in chapter 3.

The measurement uncertainty is mentioned in this test report, see chapter 9, but is not taken into account - neither to the limits nor to the measurement results. Measurement results with a smaller margin to the corresponding limits than the measurement uncertainty have a potential risk of more than 5% that the decision might be wrong."

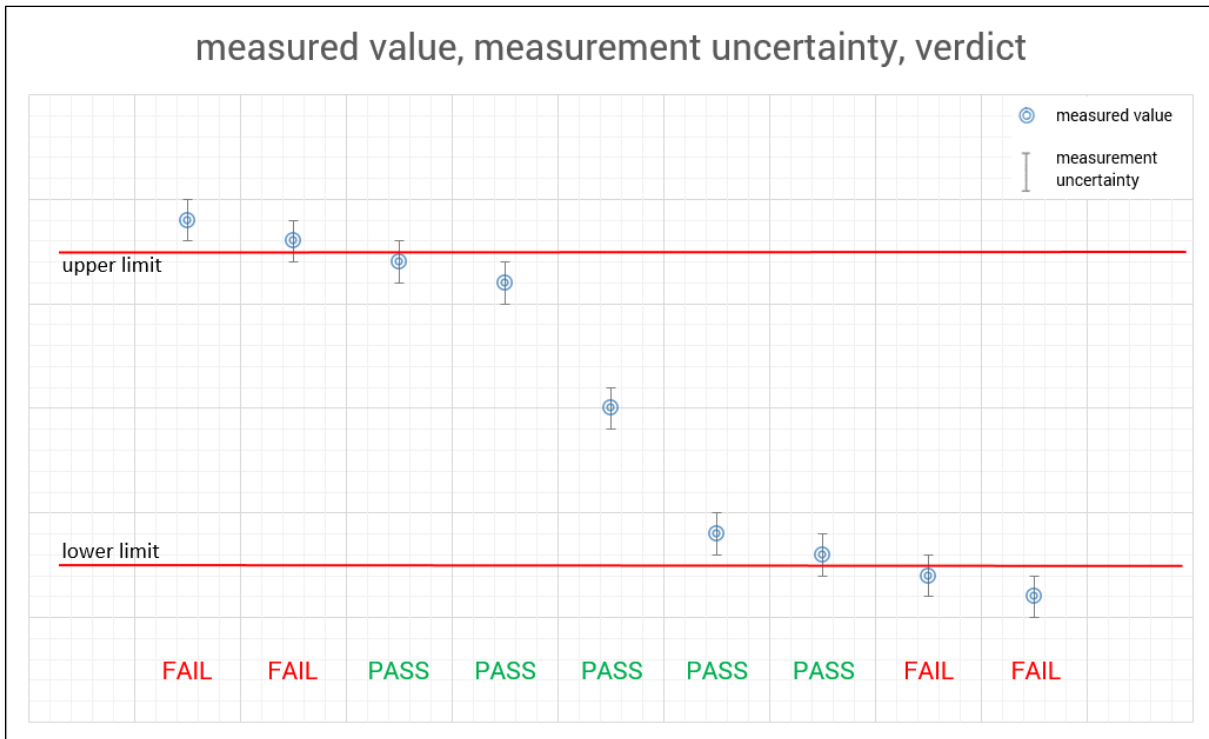

7 Description of the test setup

Typically, the calibrations of the test apparatus are commissioned to and performed by an accredited calibration laboratory. The calibration intervals are determined in accordance with the DIN EN ISO/IEC 17025. In addition to the external calibrations, the laboratory executes comparison measurements with other calibrated test systems or effective verifications. Weekly chamber inspections and range calibrations are performed. Where possible, RF generating and signaling equipment as well as measuring receivers and analyzers are connected to an external high-precision 10 MHz reference (GPS-based or rubidium frequency standard).

In order to simplify the identification of the equipment used at some special tests, some items of test equipment and ancillaries can be provided with an identifier or number in the equipment list below (Lab/Item).

Agenda: Kind of Calibration

k	calibration / calibrated	EK	limited calibration
ne	not required (k, ev, izw, zw not required)	zw	cyclical maintenance (external cyclical maintenance)
ev	periodic self verification	izw	internal cyclical maintenance
Ve	long-term stability recognized	g	blocked for accredited testing
v/k!	Attention: extended calibration interval		
NK!	Attention: not calibrated	*)	next calibration ordered / currently in progress

7.1 Shielded semi anechoic chamber

The radiated measurements are performed in vertical and horizontal plane in the frequency range from 30 MHz to 1 GHz in semi-anechoic chambers. The EUT is positioned on a non-conductive support with a height of 0.80 m above a conductive ground plane that covers the whole chamber. The receiving antennas are conform to specifications ANSI C63. These antennas can be moved over the height range between 1.0 m and 4.0 m in order to search for maximum field strength emitted from EUT. The measurement distances between EUT and receiving antennas are indicated in the test setups for the various frequency ranges. For each measurement, the EUT is rotated in all three axes until the maximum field strength is received. The wanted and unwanted emissions are received by spectrum analyzers where the detector modes and resolution bandwidths over various frequency ranges are set according to requirement ANSI C63.

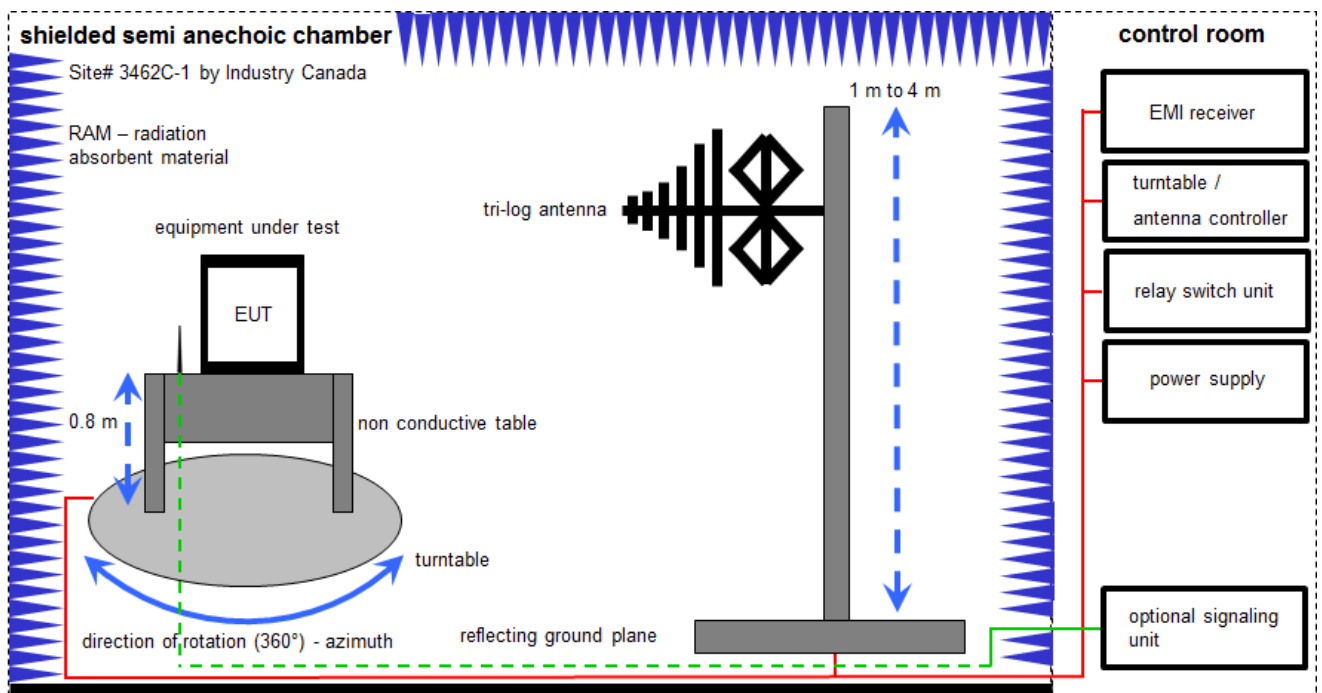

Measurement distance: tri-log antenna 10 meter

$$FS = UR + CL + AF$$

(FS-field strength; UR-voltage at the receiver; CL-loss of the cable; AF-antenna factor)

Example calculation:

$$FS [dB\mu V/m] = 12.35 [dB\mu V/m] + 1.90 [dB] + 16.80 [dB/m] = 31.05 [dB\mu V/m] (35.69 \mu V/m)$$

Equipment table:

No.	Lab / Item	Equipment	Type	Manufacturer	Serial No.	INV. No.	Kind of Calibration	Last Calibration	Next Calibration
1	n. a.	Switch-Unit	3488A	HP	2719A14505	300000368	ev	-/-	-/-
2	n. a.	DC power supply, 60Vdc, 50A, 1200 W	6032A	HP	2920A04466	300000580	ne	-/-	-/-
3	n. a.	Meßkabine 1	HF-Absorberhalle	MWB AG 300023		300000551	ne	-/-	-/-
4	n. a.	EMI Test Receiver	ESCI 3	R&S	100083	300003312	k	09.12.2021	21.12.2022
5	n. a.	Antenna Tower	Model 2175	ETS-Lindgren	64762	300003745	izw	-/-	-/-
6	n. a.	Positioning Controller	Model 2090	ETS-Lindgren	64672	300003746	izw	-/-	-/-
7	n. a.	Turntable Interface-Box	Model 105637	ETS-Lindgren	44583	300003747	izw	-/-	-/-
8	n. a.	TRILOG Broadband Test-Antenna 30 MHz - 3 GHz	VULB9163	Schwarzbeck Mess - Elektronik	318	300003696	vKI!	30.09.2019	29.09.2023
9	n. a.	Switch-Unit	3488A	HP	2719A14505	300000368	ev	-/-	-/-
10	n. a.	EMI Test Receiver	ESR3	Rohde & Schwarz	102587	300005771	k	20.05.2022	19.05.2022

7.2 Shielded fully anechoic chamber

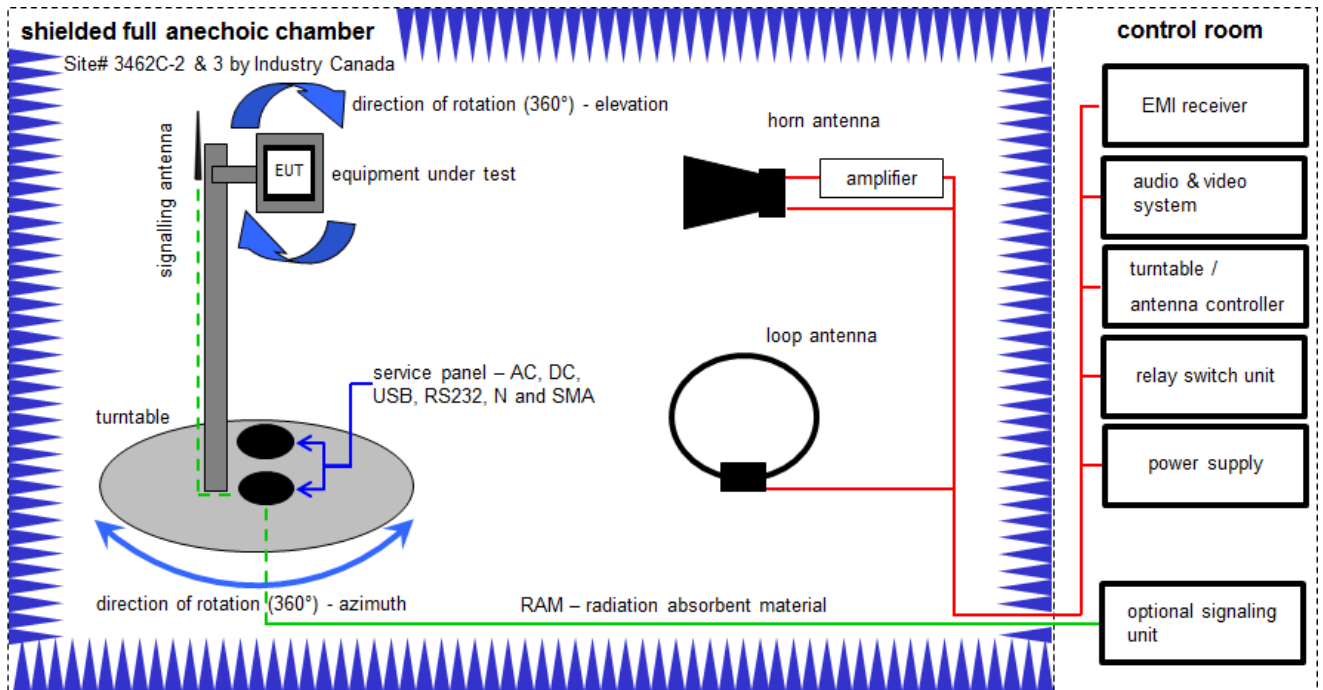

Measurement distance: horn antenna 3 meter; loop antenna 3 meter / 1 meter

FS = UR + CA + AF
(FS-field strength; UR-voltage at the receiver; CA-loss of the signal path; AF-antenna factor)

Example calculation:

$$FS [dB\mu V/m] = 40.0 [dB\mu V/m] + (-35.8) [dB] + 32.9 [dB/m] = 37.1 [dB\mu V/m] (71.61 \mu V/m)$$

Equipment table:

No.	Lab / Item	Equipment	Type	Manufacturer	Serial No.	INV. No.	Kind of Calibration	Last Calibration	Next Calibration
1	n. a.	DC power supply, 60Vdc, 50A, 1200 W	6032A	HP	2818A03450	300001040	vKI!	09.12.2020	08.12.2023
2	n. a.	Active Loop Antenna 9 kHz to 30 MHz	6502	EMCO	2210	300001015	vKI!	01.07.2021	31.07.2023
3	n. a.	Anechoic chamber	FAC 3/5m	MWB / TDK	87400/02	300000996	ev	-/-	-/-
4	n. a.	TRILOG Broadband Test-Antenna 30 MHz - 3 GHz	VULB9163	Schwarzbeck Mess - Elektronik	318	300003696	vKI!	30.09.2021	29.09.2023
5	n. a.	Double-Ridged Waveguide Horn Antenna 1-18.0GHz	3115	EMCO	9709-5289	300000213	vKI!	14.07.2020	13.07.2022
6	n. a.	Switch / Control Unit	3488A	HP	*	300000199	ne	-/-	-/-
7	n. a.	Variable isolating transformer	MPL IEC625 Bus Variable isolating transformer	Erfi	91350	300001155	ne	-/-	-/-
8	n. a.	EMI Test Receiver 20Hz- 26,5GHz	ESU26	R&S	100037	300003555	k	09.12.2020	31.12.2022
9	n. a.	Highpass Filter	WHKX7.0/18G-8SS	Wainwright	19	300003790	ne	-/-	-/-
10	n. a.	Broadband Amplifier 0.5-18 GHz	CBLU5184540	CERNEX	22049	300004481	ev	-/-	-/-
11	n. a.	Broadband Amplifier 5-13 GHz	CBLU5135235	CERNEX	22010	300004491	ev	-/-	-/-
12	n. a.	4U RF Switch Platform	L4491A	Agilent Technologies	MY50000037	300004509	ne	-/-	-/-
13	n. a.	NEXIO EMV-Software	BAT EMC V3.16.0.49	EMCO		300004682	ne	-/-	-/-
14	n. a.	PC	ExOne	F+W		300004703	ne	-/-	-/-
15	n. a.	RF-Amplifier	AMF-6F06001800-30-10P-R	NARDA-MITEQ Inc	2011572	300005241	ev	-/-	-/-

7.3 Radiated measurements > 18 GHz

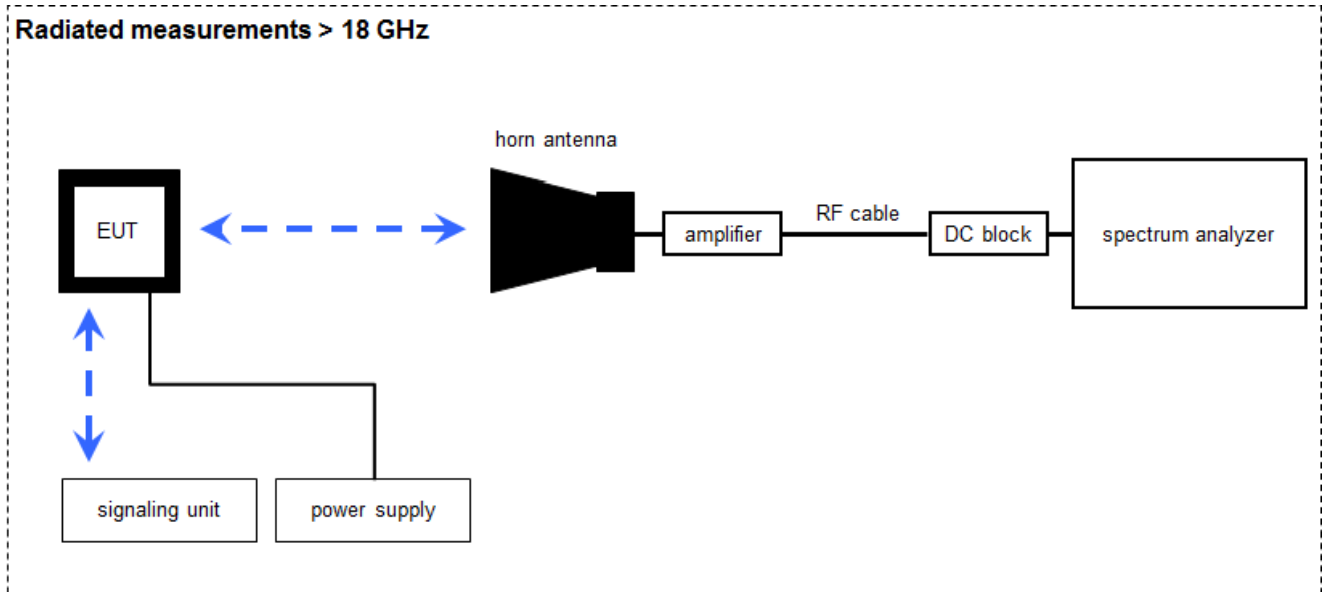

7.4 Radiated measurements > 50/85 GHz

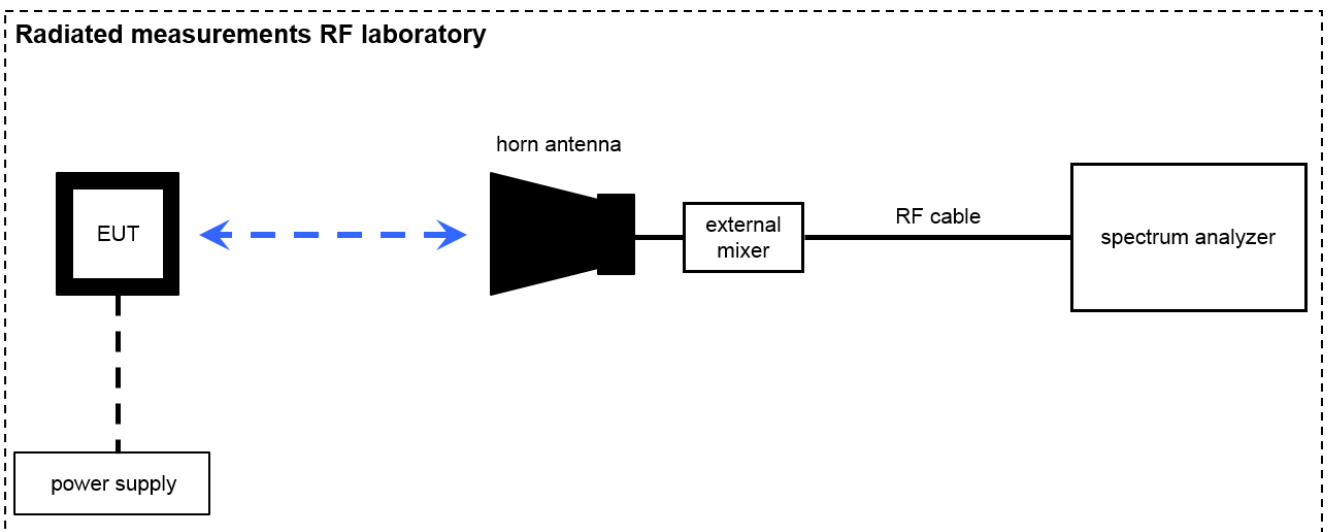

$$OP = AV + D - G$$

(OP-rad. output power; AV-analyzer value; D-free field attenuation of measurement distance; G-antenna gain)

Example calculation:

$$OP \text{ [dBm]} = -54.0 \text{ [dBm]} + 64.0 \text{ [dB]} - 20.0 \text{ [dBi]} = -10 \text{ [dBm]} \text{ (100 } \mu\text{W)}$$

Note: conversion loss of mixer is already included in analyzer value.

Equipment table (radiated measurements in test lab):

No.	Lab / Item	Equipment	Type	Manufacturer	Serial No.	INV. No.	Kind of Calibration	Last Calibration	Next Calibration
1	n.a.	Horn Antenna 18,0-40,0 GHz	LHAF180	Microw.Devel	39180-103-021	300001747	vKI!	17.01.2022	31.01.2024
4	n.a.	Std. Gain Horn Antenna 40-60 GHz	2424-20	Flann	76	400001981	ne	-/-	-/-
5	n. a.	Std. Gain Horn Antenna 49.9-75.8 GHz	2524-20	Flann	*	300001983	ne	-/-	-/-
6	n. a.	Std. Gain Horn Antenna 60-90 GHz	COR 60_90	Thomson CSF		300000814	ev	-/-	-/-
7	n. a.	Std. Gain Horn Antenna 73.8-112 GHz	2724-20	Flann	*	300001988	ne	-/-	-/-
9	n. a.	Std. Gain Horn Antenna 114-173 GHz	2924-20	Flann	*	300001999	ne	-/-	-/-
10	n. a.	Std. Gain Horn Antenna 145-220 GHz	3024-20	Flann	*	300002000	ne	-/-	-/-
13	n. a.	Broadband LNA 18-50 GHz	CBL18503070PN	CERNEX	25240	300004948	ev	09.03.2022	08.03.2024
14	n. a.	Harmonic Mixer 3-Port, 50-75 GHz	FS-Z75	Rohde & Schwarz	101578	300005788	k	15.06.2021	30.06.2022
15	n. a.	Harmonic Mixer 3-Port, 60-90 GHz	FS-Z90	R&S	101555	300004691	k	22.07.2021	31.07.2022
16	n. a.	Harmonic Mixer 3-Port, 75-110 GHz	FS-Z110	R&S	101411	300004959	k	15.06.2021	30.06.2022
18	n. a.	Harmonic Mixer 3-Port, 110-170 GHz	FS-Z170	Radiometer Physics GmbH	100014	300004156	k	11.06.2021	30.06.2022
19	n. a.	Harmonic Mixer 3-Port, 140-220 GHz	SAM-220	Radiometer Physics GmbH	200001	300004157	k	22.07.2020	31.07.2022
21	n. a.	Spectrum Analyzer 2 Hz - 85 GHz	FSW85	R&S	101333	300005568	k	30.06.2021	29.06.2022
22	n.a.	Power Supply	E3632A	Agilent Technologies	MY40001320	400000396	ev	-/-	-/-
25	n. a.	Temperature Test Chamber	T-40/50	CTS GmbH	064023	300003540	ev	08.05.2022	07.05.2024

7.5 AC power-line conducted emissions

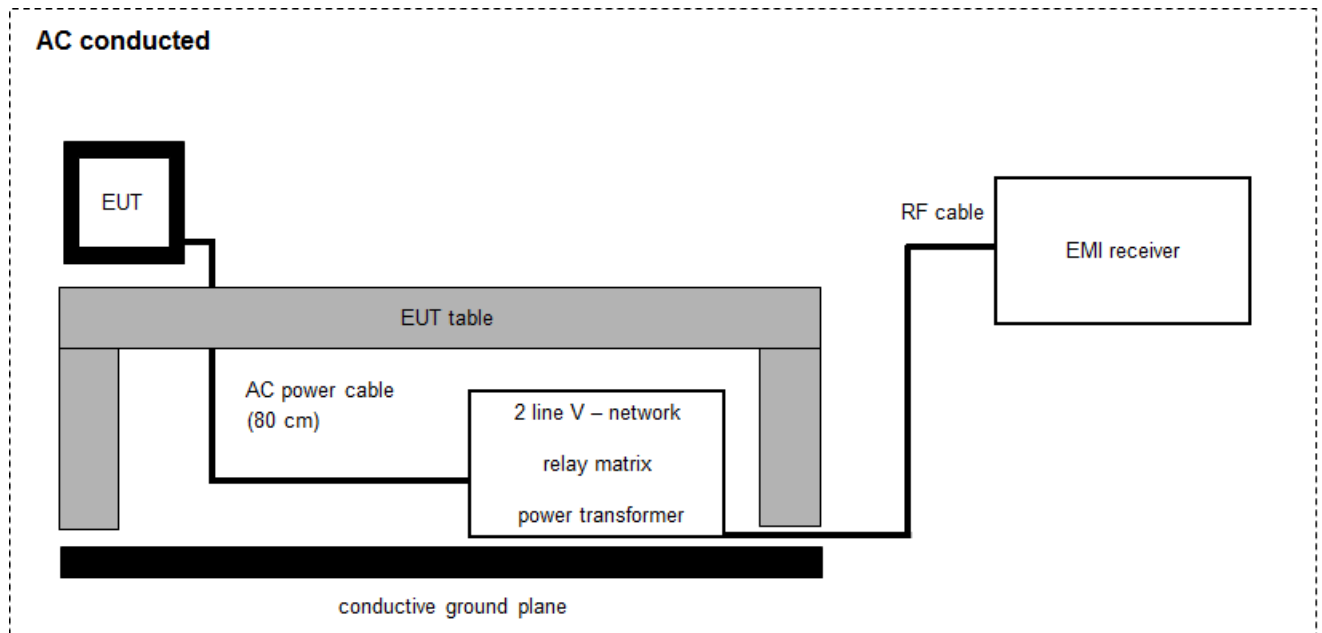

$$FS = UR + CF + VC$$

(FS-field strength; UR-voltage at the receiver; CR-loss of the cable and filter; VC-correction factor of the ISN)

Example calculation:

$$FS [dB\mu V/m] = 37.62 [dB\mu V/m] + 9.90 [dB] + 0.23 [dB] = 47.75 [dB\mu V/m] \quad (244.06 \mu V/m)$$

Equipment table:

No.	Lab / Item	Equipment	Type	Manufacturer	Serial No.	INV. No.	Kind of Calibration	Last Calibration	Next Calibration
1	-/-	Two-line V-Network (LISN) 9 kHz to 30 MHz	ESH3-Z5	R&S	892475/017	300002209	vKI!	14.12.2021	31.12.2023
2	-/-	RF-Filter-section	85420E	HP	3427A00162	300002214	NK!	-/-	-/-
3	-/-	EMI Test Receiver	ESCI 3	R&S	101240	300004427	k	07.12.2021	31.12.2022
4	-/-	Hochpass 150 kHz	EZ-25	R&S	100010	300003798	ev	-/-	-/-

8 Sequence of testing

8.1 Sequence of testing radiated spurious 9 kHz to 30 MHz

Setup

- The equipment is set up to simulate normal operation mode as described in the user manual or defined by the manufacturer.
- If the EUT is a tabletop system, it is placed on a table with 0.8 m height.
- If the EUT is a floor standing device, it is placed directly on the turn table.
- Auxiliary equipment and cables are positioned to simulate normal operation conditions as described in ANSI C 63.4.
- The AC power port of the EUT (if available) is connected to a power outlet below the turntable.
- Measurement distance is 3 m (see ANSI C 63.4) – see test details.
- EUT is set into operation.

Premeasurement*

- The turntable rotates from 0° to 315° using 45° steps.
- The antenna height is 1 m.
- At each turntable position the analyzer sweeps with positive-peak detector to find the maximum of all emissions.

Final measurement

- Identified emissions during the pre-measurement are maximized by the software by rotating the turntable from 0° to 360°.
- Loop antenna is rotated about its vertical axis for maximum response at each azimuth about the EUT. (For certain applications, the loop antenna plane may also need to be positioned horizontally at the specified distance from the EUT)
- The final measurement is done in the position (turntable and elevation) causing the highest emissions with quasi-peak (as described in ANSI C 63.4).
- Final levels, frequency, measuring time, bandwidth, turntable position, correction factor, margin to the limit and limit will be recorded. A plot with the graph of the premeasurement and the limit is stored.

*)Note: The sequence will be repeated three times with different EUT orientations.

8.2 Sequence of testing radiated spurious 30 MHz to 1 GHz

Setup

- The equipment is set up to simulate normal operation mode as described in the user manual or defined by the manufacturer.
- If the EUT is a tabletop system, a table with 0.8 m height is used, which is placed on the ground plane.
- If the EUT is a floor standing device, it is placed on the ground plane with insulation between both.
- Auxiliary equipment and cables are positioned to simulate normal operation conditions as described in ANSI C 63.4.
- The AC power port of the EUT (if available) is connected to a power outlet below the turntable.
- Measurement distance is 10 m or 3 m (see ANSI C 63.4) – see test details.
- EUT is set into operation.

Premeasurement

- The turntable rotates from 0° to 315° using 45° steps.
- The antenna is polarized vertical and horizontal.
- The antenna height changes from 1 m to 3 m.
- At each turntable position, antenna polarization and height the analyzer sweeps three times in peak to find the maximum of all emissions.

Final measurement

- The final measurement is performed for at least six highest peaks according to the requirements of the ANSI C63.4.
- Based on antenna and turntable positions at which the peak values are measured the software maximize the peaks by changing turntable position $\pm 45^\circ$ and antenna height between 1 and 4 m.
- The final measurement is done with quasi-peak detector (as described in ANSI C 63.4).
- Final levels, frequency, measuring time, bandwidth, antenna height, antenna polarization, turntable angle, correction factor, margin to the limit and limit are recorded. A plot with the graph of the premeasurement with marked maximum final results and the limit is stored.

8.3 Sequence of testing radiated spurious 1 GHz to 18 GHz

Setup

- The equipment is set up to simulate normal operation mode as described in the user manual or defined by the manufacturer.
- If the EUT is a tabletop system, a 2-axis positioner with 1.5 m height is used.
- If the EUT is a floor standing device, it is placed directly on the turn table.
- Auxiliary equipment and cables are positioned to simulate normal operation conditions as described in ANSI C 63.4.
- The AC power port of the EUT (if available) is connected to a power outlet below the turntable.
- Measurement distance is 3 m (see ANSI C 63.4) – see test details.
- EUT is set into operation.

Premeasurement

- The turntable rotates from 0° to 315° using 45° steps.
- The antenna is polarized vertical and horizontal.
- The antenna height is 1.5 m.
- At each turntable position and antenna polarization the analyzer sweeps with positive peak detector to find the maximum of all emissions.

Final measurement

- The final measurement is performed for at least six highest peaks according to the requirements of the ANSI C63.4.
- Based on antenna and turntable positions at which the peak values are measured the software maximizes the peaks by rotating the turntable from 0° to 360°. This measurement is repeated for different EUT-table positions (0° to 150° in 30°-steps) and for both antenna polarizations.
- The final measurement is done in the position (turntable, EUT-table and antenna polarization) causing the highest emissions with Peak and RMS detector (as described in ANSI C 63.4).
- Final levels, frequency, measuring time, bandwidth, turntable position, EUT-table position, antenna polarization, correction factor, margin to the limit and limit are recorded. A plot with the graph of the premeasurement with marked maximum final results and the limit is stored.

8.4 Sequence of testing radiated spurious above 18 GHz

Setup

- The equipment is set up to simulate normal operation mode as described in the user manual or defined by the manufacturer.
- Auxiliary equipment and cables are positioned to simulate normal operation conditions as described in ANSI C 63.4.
- The AC power port of the EUT (if available) is connected to a power outlet.
- The measurement distance is as appropriate (e.g. 0.5 m).
- The EUT is set into operation.

Premeasurement

- The test antenna is handheld and moved carefully over the EUT to cover the EUT's whole sphere and different polarizations of the antenna.

Final measurement

- The final measurement is performed at the position and antenna orientation causing the highest emissions with Peak and RMS detector (as described in ANSI C 63.4).
- Final levels, frequency, measuring time, bandwidth, correction factor, margin to the limit and limit are recorded. A plot with the graph of the premeasurement and the limit is stored.

8.5 Sequence of testing radiated spurious above 50/85 GHz with external mixers

Setup

- The equipment is set up to simulate normal operation mode as described in the user manual or defined by the manufacturer.
- Auxiliary equipment and cables are positioned to simulate normal operation conditions as described in ANSI C 63.4.
- The AC power port of the EUT (if available) is connected to a power outlet.
- The measurement distance is as appropriate for far field (e.g. 0.25 m).
- The EUT is set into operation.

Premeasurement

- The test antenna with external mixer is handheld and moved carefully over the EUT to cover the EUT's whole sphere and different polarizations of the antenna.
- Caution is taken to reduce the possible overloading of the external mixer.

Final measurement

- The final measurement is performed at the position and antenna orientation causing the highest emissions with Peak and RMS detector (as described in ANSI C 63.4).
- As external mixers may generate false images care is taken to ensure that any emission measured by the spectrum analyzer does indeed originate in the EUT. Signal identification feature of spectrum analyzer is used to eliminate false mixer images (i.e., it is not the fundamental emission or a harmonic falling precisely at the measured frequency).
- Final levels, frequency, measuring time, bandwidth, correction factor, margin to the limit and limit are recorded. A plot with the graph of the premeasurement and the limit is stored.

9 Measurement uncertainty

Test case	Uncertainty
Equivalent isotropically radiated power (e.i.r.p.)	Conducted value ± 1 dB Radiated value ± 3 dB
Permitted range of operating frequencies	± 100 kHz
Conducted unwanted emissions in the spurious domain (up to 40 GHz)	± 1 dB
Radiated unwanted emissions in the spurious domain (up to 40 GHz)	± 3 dB
Conducted unwanted emissions in the spurious domain (40 to 50 GHz)	± 4 dB
Radiated unwanted emissions in the spurious domain (40 to 50 GHz)	± 4 dB
Conducted unwanted emissions in the spurious domain (50 to 300 GHz)	± 5 dB
Radiated unwanted emissions in the spurious domain (50 to 300 GHz)	± 5 dB
DC and low frequency voltages	± 3 %
Temperature	± 1 °C
Humidity	± 3 %

10 Far field consideration for measurements above 18 GHz

Far field distance calculation:

$$D_{ff} = 2 \times D^2 / \lambda$$

with

D_{ff} Far field distance
 D Antenna dimension
 λ wavelength

Spurious emission measurements:

Antenna frequency range in GHz	Highest measured frequency in GHz	D in cm	λ in cm	D_{ff} in cm
18-26	26	3.4	1.15	20.04
26-40	40	2.2	0.75	12.91
40-50	50	2.77	0.60	25.58
50-75	75	1.85	0.40	17.11
75-110	110	1.24	0.27	11.28
90-140	140	1.02	0.22	9.72
110-170	170	0.85	0.18	8.19
140-220	220	0.68	0.14	6.78
220-325	325	0.43	0.09	4.01
325-500	500	0.26	0.06	2.22

11 Summary of measurement results

<input checked="" type="checkbox"/>	No deviations from the technical specifications were ascertained
<input type="checkbox"/>	There were deviations from the technical specifications ascertained
<input type="checkbox"/>	This test report is only a partial test report. The content and verdict of the performed test cases are listed below.

TC identifier	Description	verdict	date	Remark
RF-Testing	47 CFR Part 15 / RSS-211	see below	2022-07-26	-/-

Test Specification Clause	Test Case	Temperature Conditions	Power Source Voltages	C	NC	NA	NP	Results (max.)
§15.215(c)	Frequency stability	Nominal Extreme	Nominal Extreme	<input checked="" type="checkbox"/>	<input type="checkbox"/>	<input type="checkbox"/>	<input type="checkbox"/>	complies
§15.256(f) RSS-211, 2.4	Fundamental bandwidth	Nominal	Nominal	<input checked="" type="checkbox"/>	<input type="checkbox"/>	<input type="checkbox"/>	<input type="checkbox"/>	complies
§15.256(g) RSS-211,5.2b	Fundamental emissions limits	Nominal	Nominal	<input checked="" type="checkbox"/>	<input type="checkbox"/>	<input type="checkbox"/>	<input type="checkbox"/>	complies
§15.256(h) RSS-211,5.1d	Unwanted emissions limit	Nominal	Nominal	<input checked="" type="checkbox"/>	<input type="checkbox"/>	<input type="checkbox"/>	<input type="checkbox"/>	complies
§15.256(i) RSS-211,5.2a	Antenna beamwidth	Nominal	Nominal	<input checked="" type="checkbox"/>	<input type="checkbox"/>	<input type="checkbox"/>	<input type="checkbox"/>	complies
§15.256(j) RSS-211,5.2c	Antenna side lobe gain	Nominal	Nominal	<input checked="" type="checkbox"/>	<input type="checkbox"/>	<input type="checkbox"/>	<input type="checkbox"/>	complies
§15.256(k) RSS-Gen, 7.1	Emissions from digital circuitry	Nominal	Nominal	<input checked="" type="checkbox"/>	<input type="checkbox"/>	<input type="checkbox"/>	<input type="checkbox"/>	complies
§15.107/207 RSS-Gen, 8.8	Conducted limits	Nominal	Nominal	<input type="checkbox"/>	<input type="checkbox"/>	<input checked="" type="checkbox"/>	<input type="checkbox"/>	complies

Note: C = Compliant; NC = Not compliant; NA = Not applicable; NP = Not performed

12 Summary of measurement results

12.1 Frequency stability and fundamental bandwidth

Description:

§15.215(c) Intentional radiators operating under the alternative provisions to the general emission limits, as contained in §§15.217 through 15.257 and in subpart E of this part, must be designed to ensure that the 20 dB bandwidth of the emission, or whatever bandwidth may otherwise be specified in the specific rule section under which the equipment operates, is contained within the frequency band designated in the rule section under which the equipment is operated. In the case of intentional radiators operating under the provisions of subpart E, the emission bandwidth may span across multiple contiguous frequency bands identified in that subpart. The requirement to contain the designated bandwidth of the emission within the specified frequency band includes the effects from frequency sweeping, frequency hopping and other modulation techniques that may be employed as well as the frequency stability of the transmitter over expected variations in temperature and supply voltage. If a frequency stability is not specified in the regulations, it is recommended that the fundamental emission be kept within at least the central 80% of the permitted band in order to minimize the possibility of out-of-band operation.

§15.256(f) The fundamental bandwidth of an LPR emission is defined as the width of the signal between two points, one below and one above the center frequency, outside of which all emissions are attenuated by at least 10 dB relative to the maximum transmitter output power when measured in an equivalent resolution bandwidth.

Measurement:

f_C is the point in the radiation where the power is at maximum. The frequency points where the power falls 10 dB below the f_C level and above f_C level are designated as f_L and f_H respectively. The operating frequency range (i.e. the frequency band of operation) is defined as $f_H - f_L$.

Measurement parameters:

Resolution bandwidth: 1 MHz
Video bandwidth: ≥ 1 MHz
Detector: Pos-Peak
Trace: Max hold

Limits:

As specified in Section 15.215(c), the bandwidth of the fundamental emission must be contained within the frequency band over the temperature range -20 to +50 degrees Celsius with an input voltage variation of 85% to 115% of rated input voltage. Frequency stability is to be measured according to Section 2.1055 at the highest and lowest frequency of operation and with the modulation that produces the widest emission bandwidth.

§15.256(f)(1) The minimum fundamental emission bandwidth shall be 50 MHz for LPR operation under the provisions of this section.

§15.256(f)(2) LPR devices operating under this section must confine their fundamental emission bandwidth within the 5.925-7.250 GHz, 24.05-29.00 GHz, and 75-85 GHz bands under all conditions of operation.

Same requirements for fundamental emission bandwidth are given in RSS-211, 2.4 and 5.1.a)

Results:

Test Conditions	Transmitter Frequency Range (GHz)		10 dB bandwidth (GHz)
	f_L	f_H	
-30 °C / V_{nom}	77.024	80.996	3.97
-20 °C / V_{nom}	77.024	80.996	3.97
-10 °C / V_{nom}	77.024	80.996	3.97
0 °C / V_{nom}	77.014	80.996	3.97
10 °C / V_{nom}	77.014	80.996	3.98
20 °C / $V_{min} - V_{max}$	77.014	80.996	3.98
30 °C / V_{nom}	77.014	80.996	3.98
40 °C / V_{nom}	77.014	80.996	3.98
50 °C / V_{nom}	77.024	80.996	3.97
deviation based on 20 °C	±5.0 MHz (±65 ppm)	0 MHz (0 ppm)	

Plot 1: 10 dB bandwidth, Pos-Peak measurement, reference at 20°

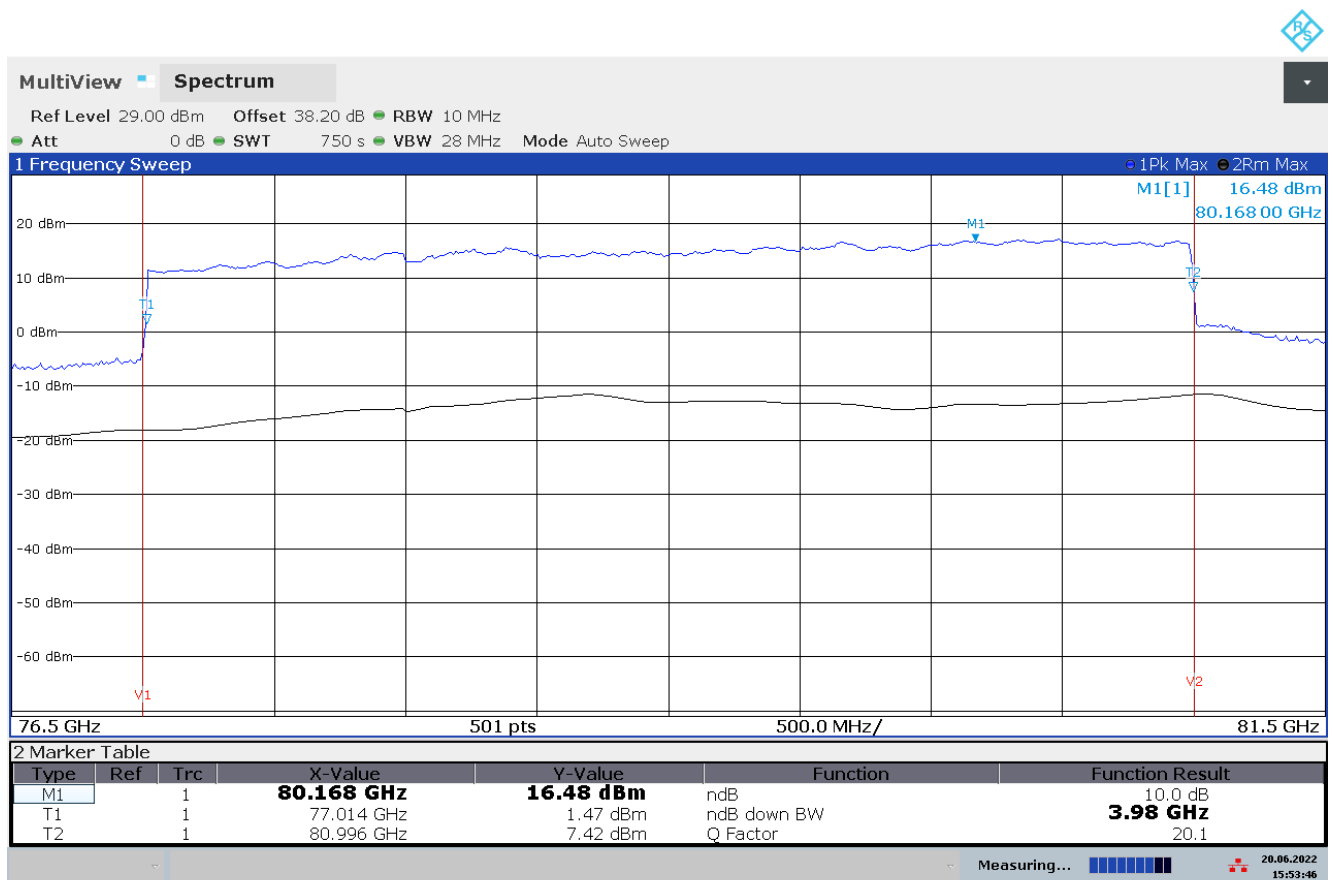

15:53:47 20.06.2022

12.2 Fundamental emissions

Description:

§15.256(g) Fundamental emissions limits.

- (1) All emission limits provided in this section are expressed in terms of Equivalent Isotropic Radiated Power (EIRP).
- (2) The EIRP level is to be determined from the maximum measured power within a specified bandwidth.
 - (i) The EIRP in 1 MHz is computed from the maximum power level measured within any 1 MHz bandwidth using a power averaging detector;
 - (ii) The EIRP in 50 MHz is computed from the maximum power level measured with a peak detector in a 50-MHz bandwidth centered on the frequency at which the maximum average power level is realized and this 50 MHz bandwidth must be contained within the authorized operating bandwidth. For a RBW less than 50 MHz, the peak EIRP limit (in dBm) is reduced by $20 \log(\text{RBW}/50)$ dB where RBW is the resolution bandwidth in megahertz. The RBW shall not be lower than 1 MHz or greater than 50 MHz. The video bandwidth of the measurement instrument shall not be less than the RBW. If the RBW is greater than 3 MHz, the application for certification filed shall contain a detailed description of the test procedure, calibration of the test setup, and the instrumentation employed in the testing.
- (3) The EIRP limits for LPR operations in the bands authorized by this rule section are provided in Table below. The emission limits in Table below are based on boresight measurements (i.e., measurements performed within the main beam of an LPR antenna).

Limits:

Frequency range (GHz)	Average emission limit (EIRP in dBm / 1 MHz)	Peak emission limit (EIRP in dBm / 50 MHz)
5.925 to 7.250	-33	+7 dBm
24.05 to 29.00	-14	+26 dBm
75.00 to 85.00	-3	+34 dBm

Same requirements are given in RSS-211, 5.2.b)

Measurement parameters:

Resolution bandwidth: 1 MHz
 Video bandwidth: ≥ 1 MHz
 Span: depends on DUT
 Detector: Pos-Peak
 Trace: Max hold

Results:

There are two different aspects which will affect the peak-to-average ratio resp. RMS value at all:

- Duty cycle of the device
- Frequency domain mitigation / dwell time due to FMCW-modulation

The EUT uses FMCW with a negative or positive ramp over a bandwidth of 4 GHz within $T_S = 8 \times 167 \mu s$. The total DUT cycle is 1000 ms. Therefore the gap (blanking period) between the emissions is approx. 999 ms. This will lead to:

Mode	Operating bandwidth (ΔF) [GHz]	dwell time (T_D)* [μs /MHz]	averaging factor (AF)** [dB]
Normal	3.970	0.364	-64.38

*dwell time $T_D = T_S / \Delta F$

**averaging factor $AF = T_D / \text{cycle time}$

Mode	Equivalent isotropically radiated power (e.i.r.p.)	
	Peak power	Average power
Normal	25.33 dBm	-33.21 dBm

Plot 2: Peak EIRP

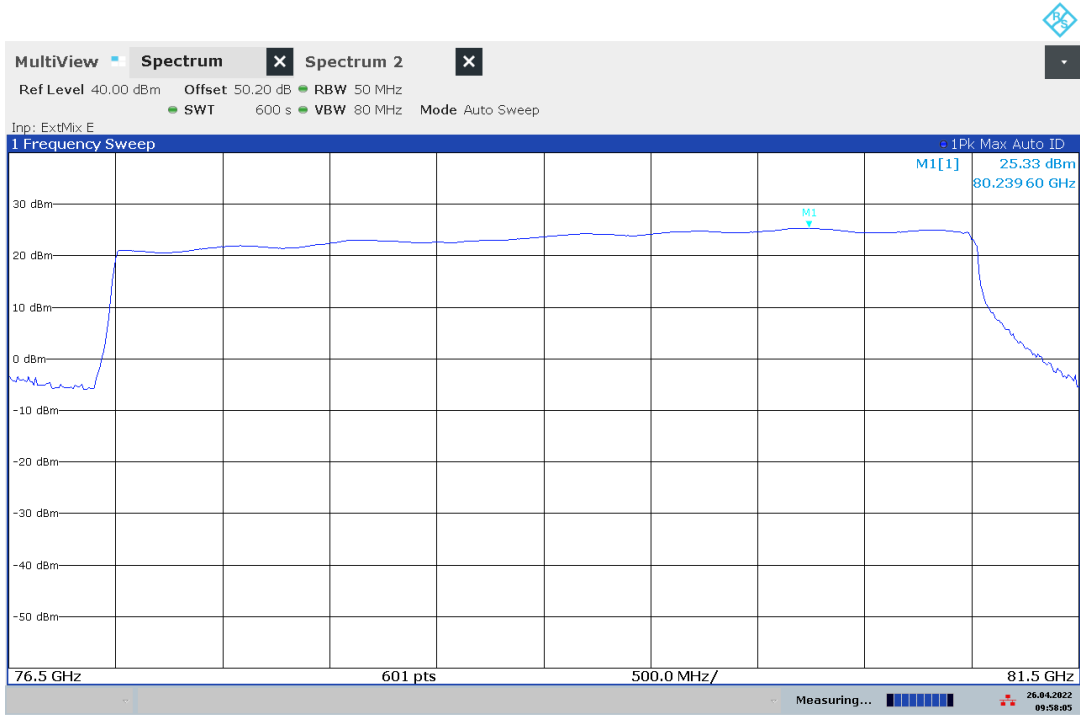

09:58:06 26.04.2022

Plot 3: RMS measurement

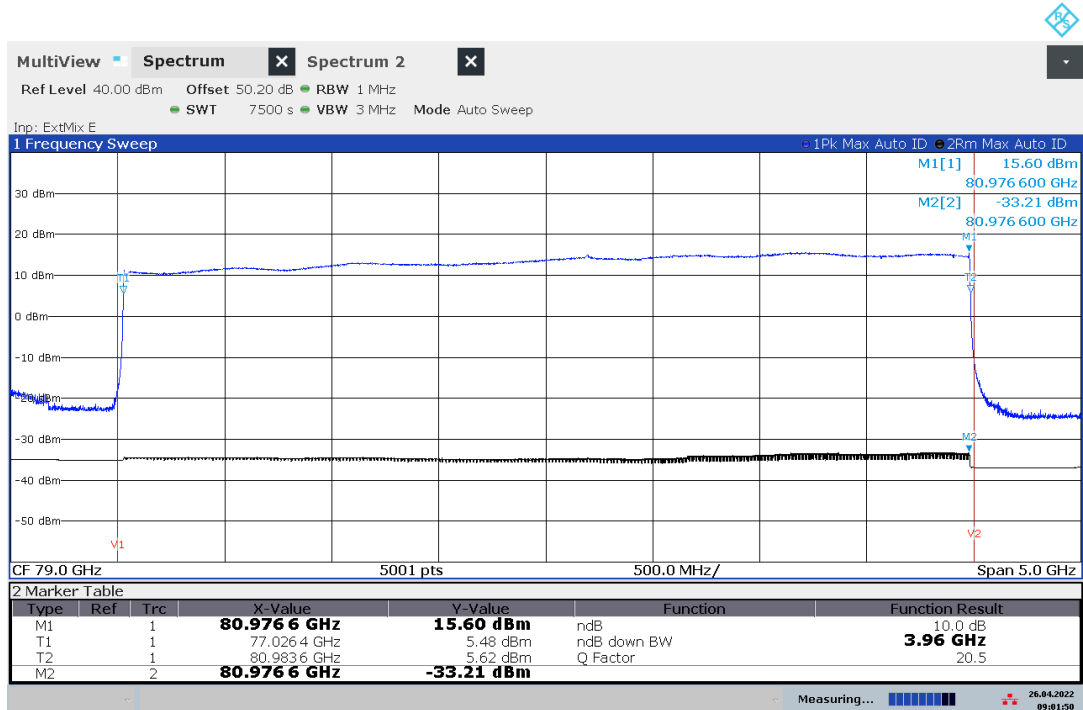

09:01:50 26.04.2022

12.3 Unwanted emissions limit

Description:

§15.256(h)

Unwanted emissions from LPR devices shall not exceed the general emission limit in §15.209 of this chapter.

Measurement parameters:

Resolution bandwidth: 100 kHz / 1 MHz
 Video bandwidth: ≥ resolution bandwidth
 Detector: Quasi Peak / Average (RMS)
 Trace: Max hold

Limits:

FCC §15.209 / RSS-Gen		
Field strength of the harmonics and spurious.		
Frequency (MHz)	Field strength (µV/m)	Measurement distance (m)
0.009 – 0.490	2400/F(kHz)	300
0.490 – 1.705	24000/F(kHz)	30
1.705 – 30	30 (29.5 dBµV/m)	30
30 – 88	100 (40 dBµV/m)	3
88 – 216	150 (43.5 dBµV/m)	3
216 – 960	200 (46 dBµV/m)	3
>960	500 (54 dBµV/m)	3

Results:

Spurious emission level (dBm)								
-/-			-/-			-/-		
Frequency [GHz]	BW [kHz]	Level [dBm]	Frequency [GHz]	BW [kHz]	Level [dBm]	Frequency [GHz]	BW [kHz]	Level [dBm]
see plots								

Plot 4: 9 kHz – 30 MHz

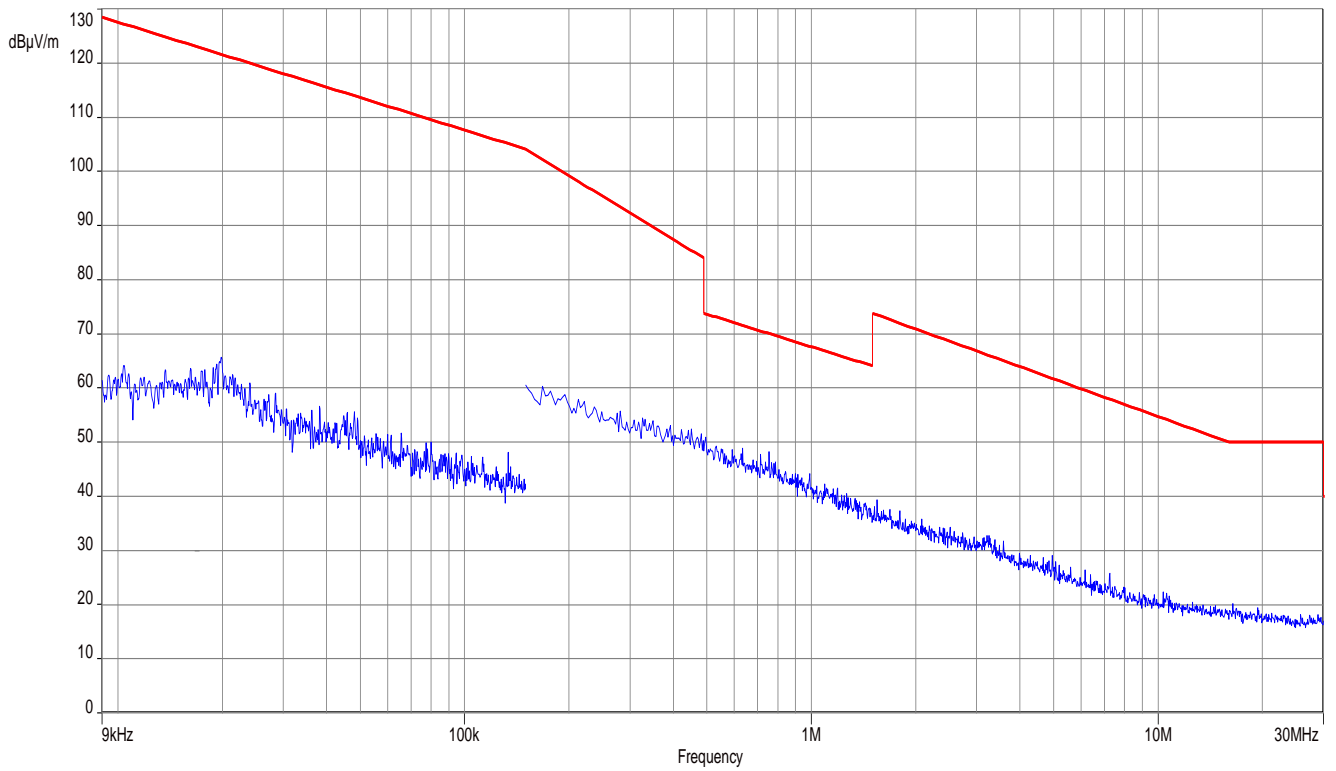

Plot 5: 30 MHz – 1000 MHz

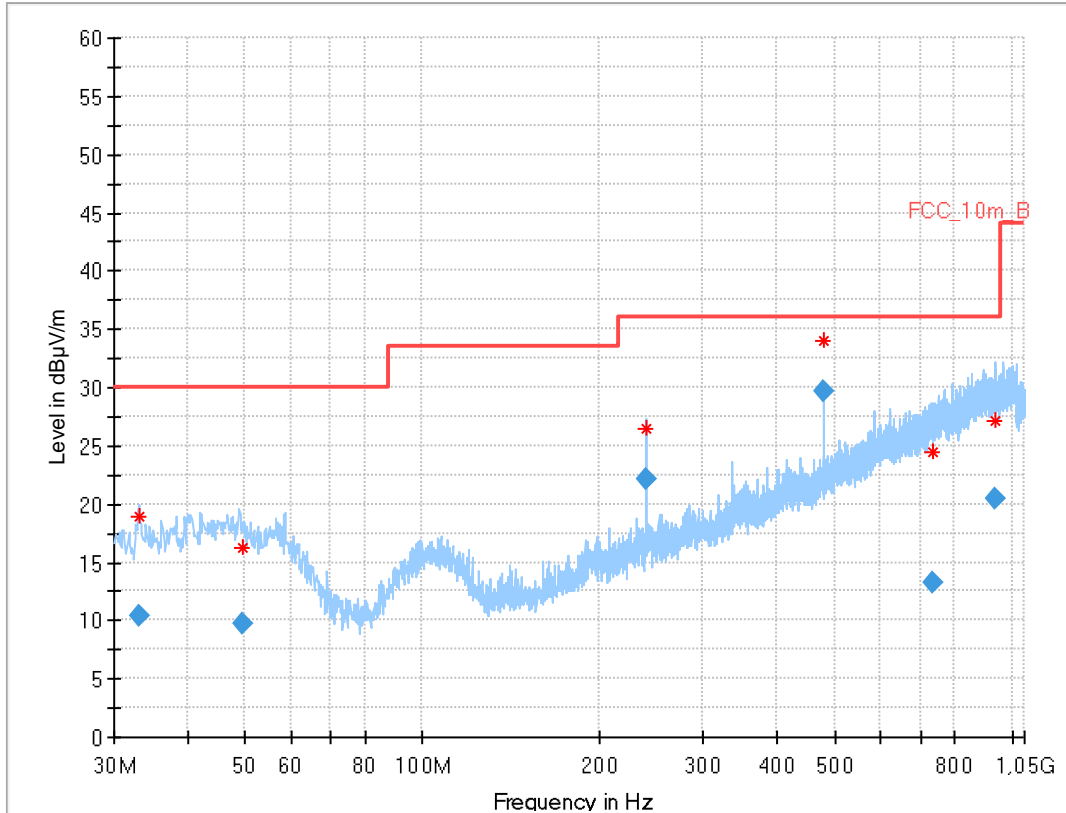

Final Result

Frequency (MHz)	QuasiPeak (dBµV/m)	Limit (dBµV/m)	Margin (dB)	Meas. Time (ms)	Bandwidth (kHz)	Height (cm)	Pol	Azimuth (deg)	Corr. (dB/m)
33.021	10.44	30.0	19.6	1000	120.0	343.0	H	-45	14
49.591	9.72	30.0	20.3	1000	120.0	200.0	V	135	16
239.990	22.07	36.0	13.9	1000	120.0	112.0	V	349	14
479.977	29.67	36.0	6.3	1000	120.0	324.0	V	45	19
734.556	13.31	36.0	22.7	1000	120.0	200.0	H	-29	23
936.280	20.45	36.0	15.6	1000	120.0	116.0	V	270	26

Plot 6: 1 GHz – 18 GHz, PEAK/RMS-measurement

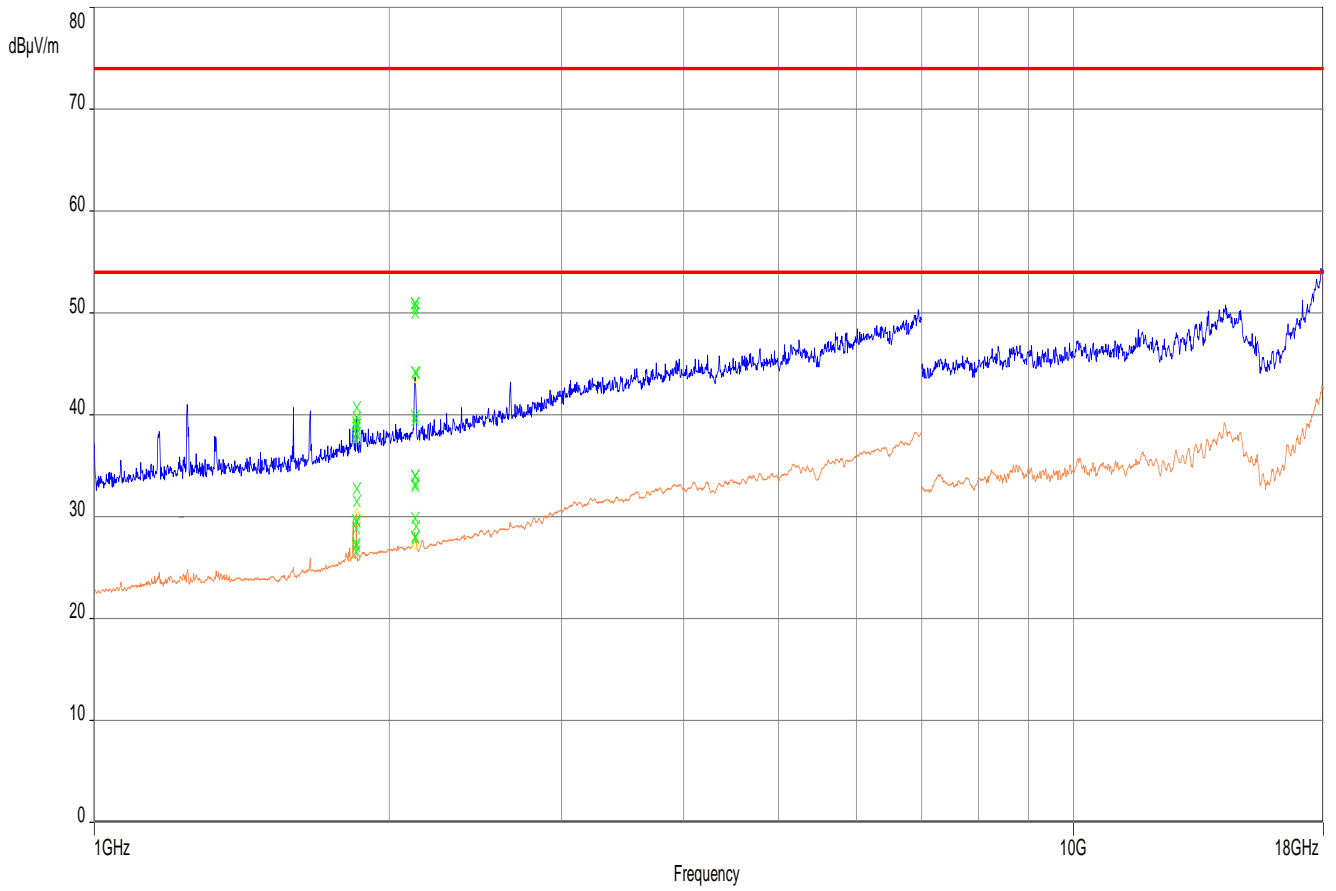

Plot 7: 18 GHz – 40 GHz, PEAK/RMS-measurement

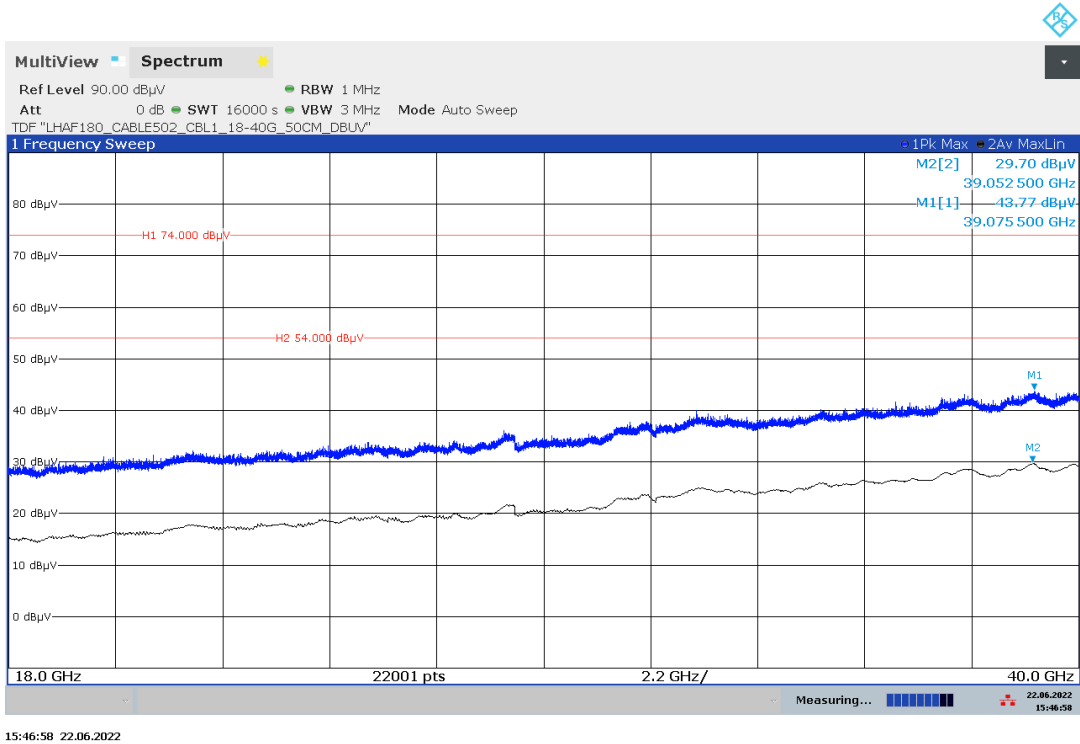

Plot 8: 40 GHz – 50 GHz, PEAK/RMS-measurement

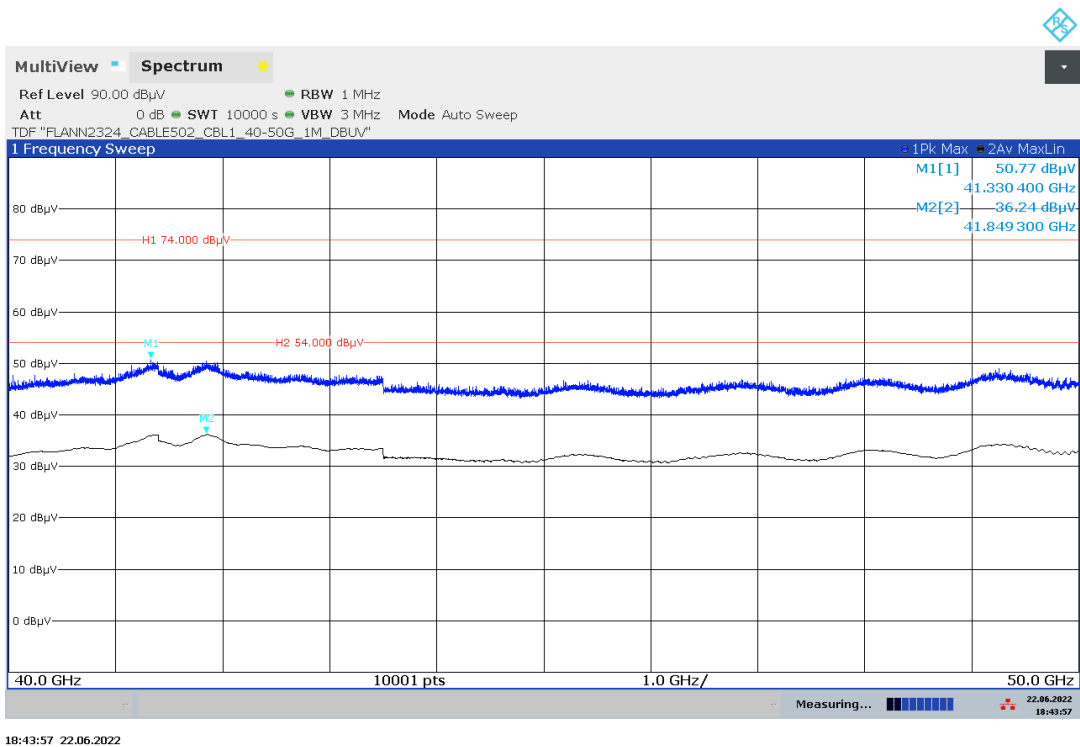

Plot 9: 50 GHz – 75 GHz, PEAK/RMS-measurement

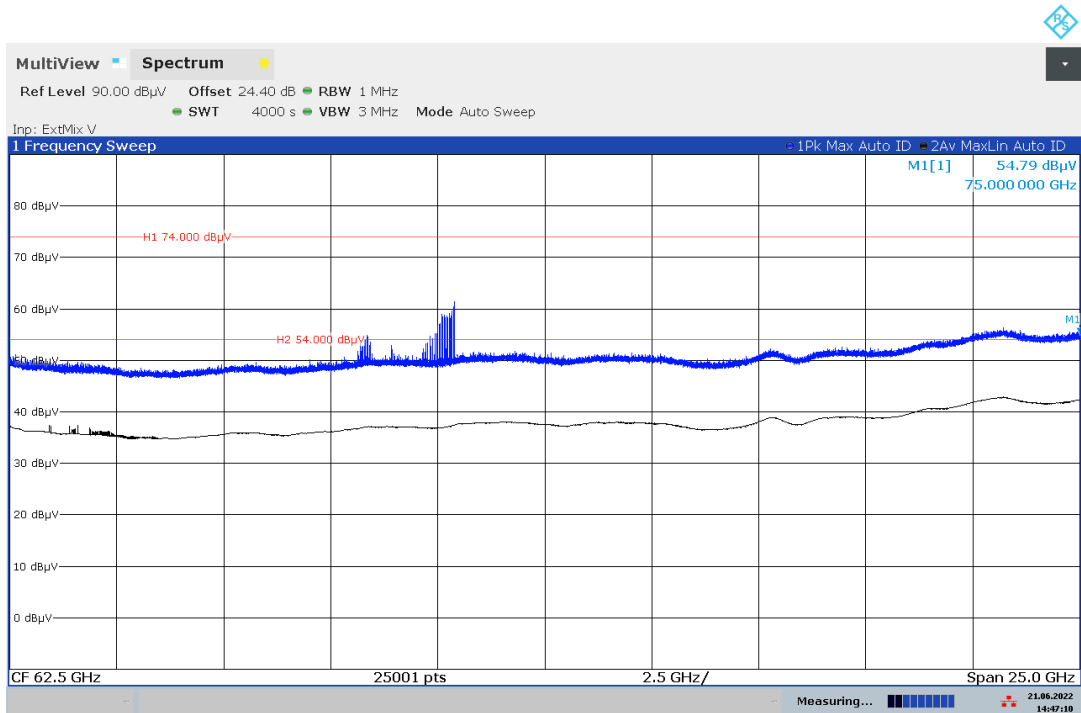

14:47:11 21.06.2022

Note: Mixer products visible on plot

Plot 10: 75 GHz – 76.5 GHz, PEAK/RMS-measurement

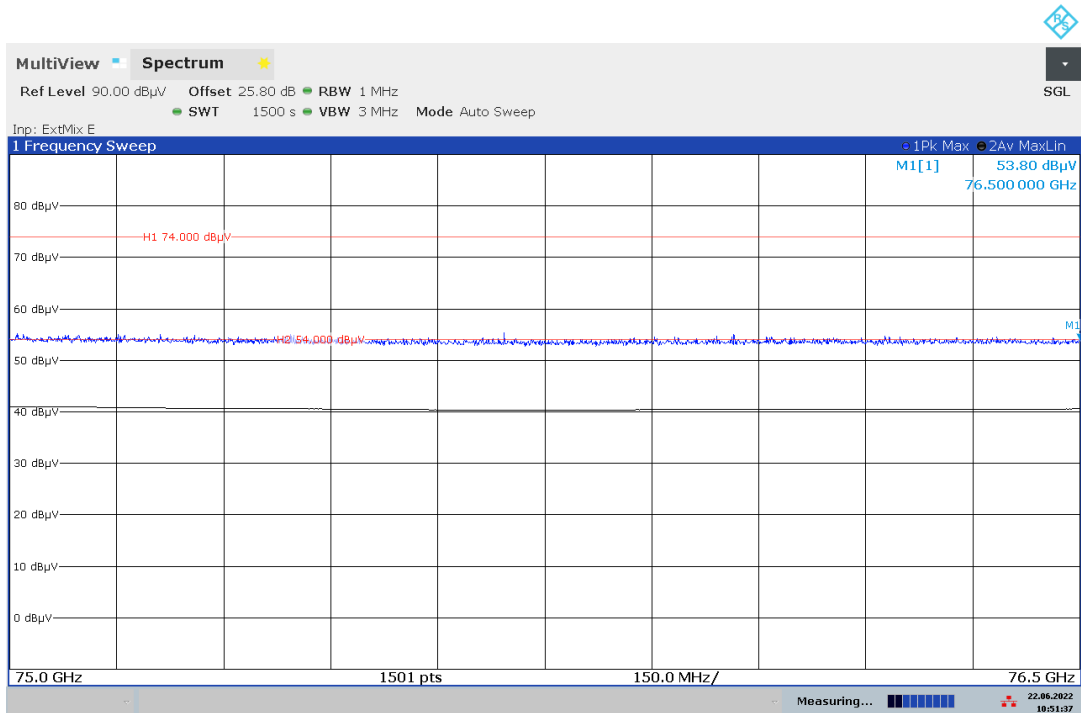

10:51:37 22.06.2022

Plot 11: 81 GHz – 110 GHz, PEAK/RMS-measurement

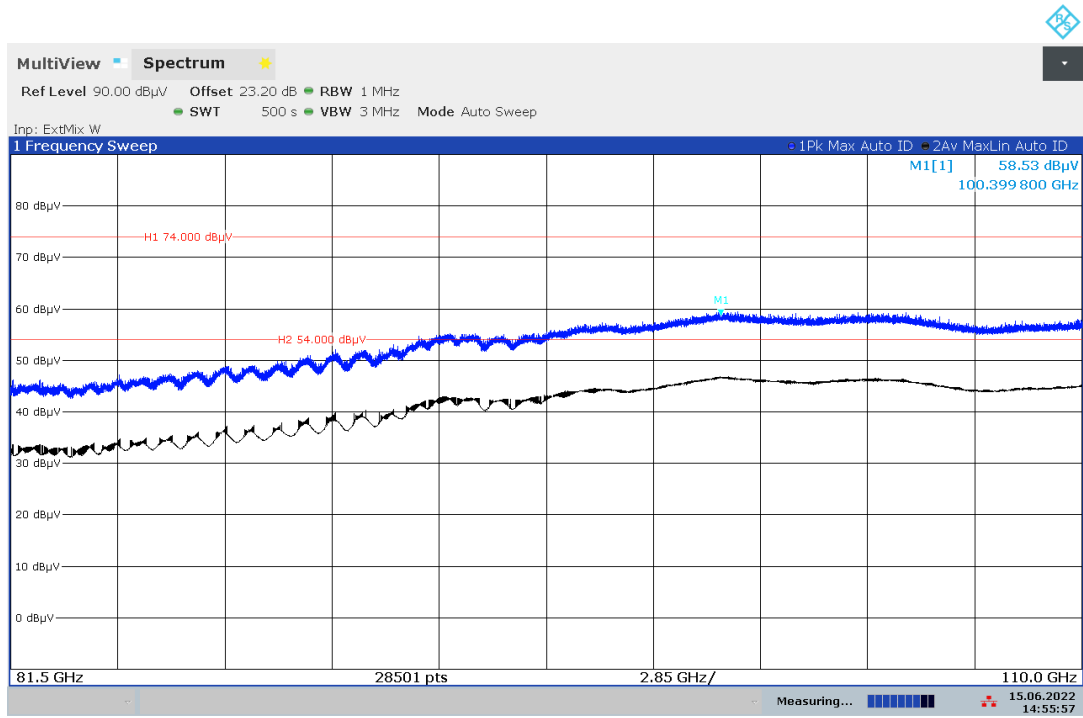

Plot 12: 110 GHz – 170 GHz, PEAK/RMS-measurement

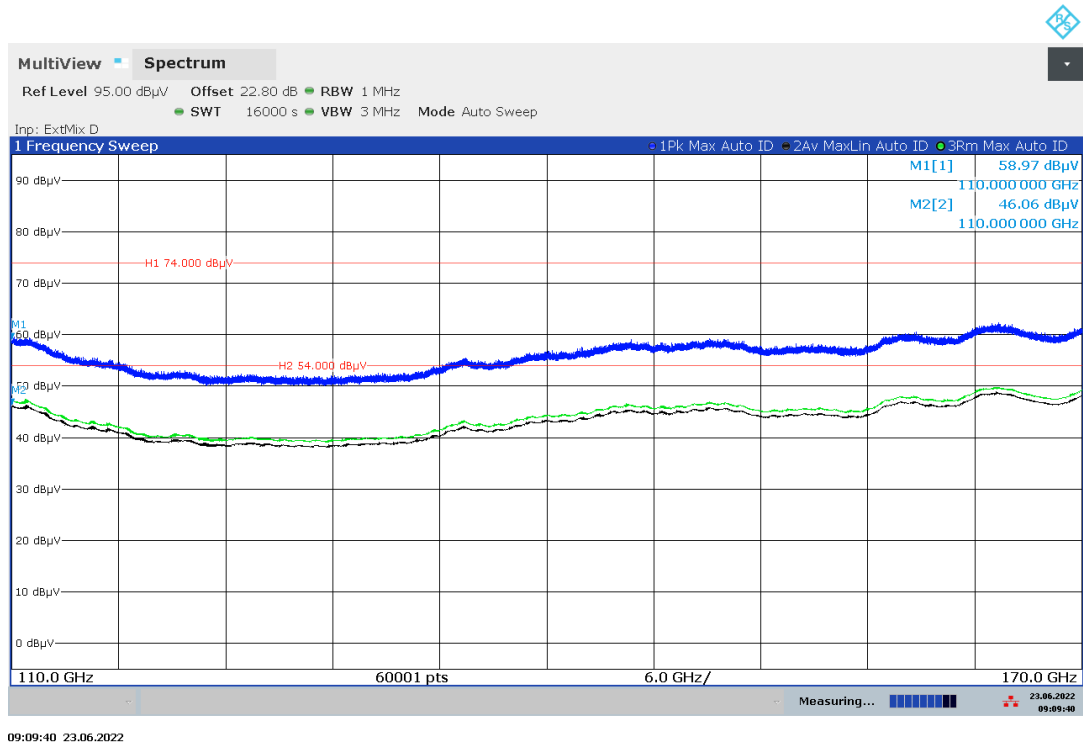

Plot 13: 170 GHz – 200 GHz, PEAK/RMS-measurement

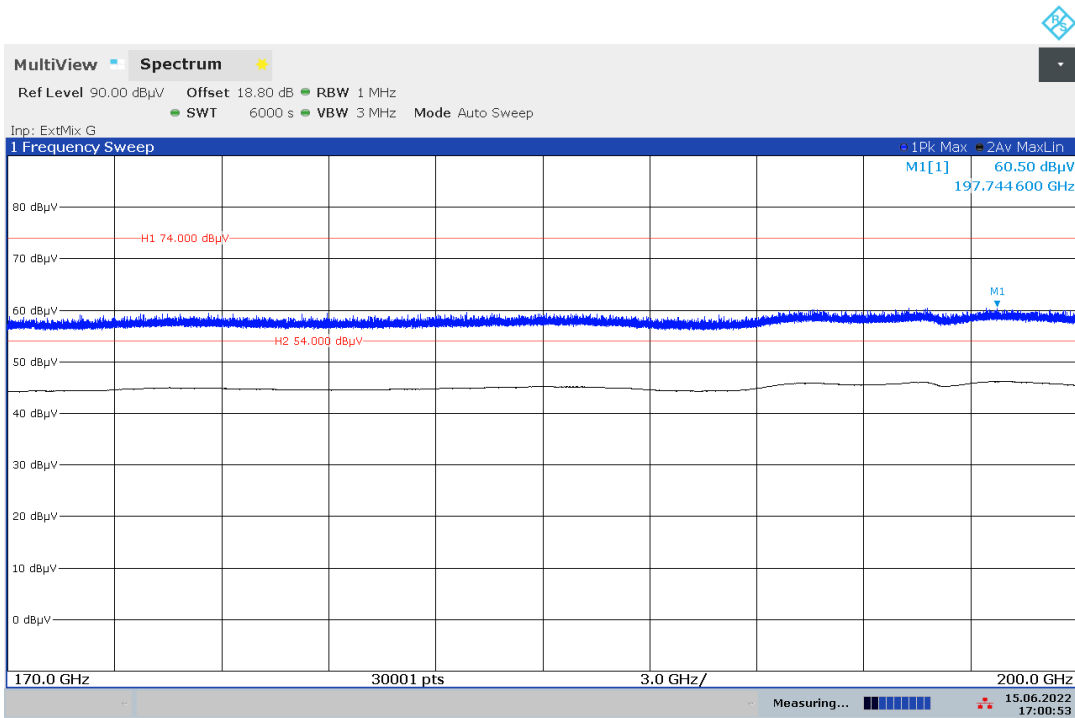

17:00:54 15.06.2022

12.4 Antenna beamwidth and antenna side lobe gain

Description:

§15.256(i) Antenna beamwidth

(A) LPR devices operating under the provisions of this section within the 5.925-7.250 GHz and 24.05-29.00 GHz bands must use an antenna with a -3 dB beamwidth no greater than 12 degrees.

(B) LPR devices operating under the provisions of this section within the 75-85 GHz band must use an antenna with a -3 dB beamwidth no greater than 8 degrees.

(j) Antenna side lobe gain. LPR devices operating under the provisions of this section must limit the side lobe antenna gain relative to the main beam gain for off-axis angles from the main beam of greater than 60 degrees to the levels provided in Table below.

Limits:

FCC §15.256 / RSS-211 5.2a) c)		
Frequency range (GHz)	Antenna beamwidth in degree (°)	Antenna side lobe gain limit relative to main beam gain (dB)
5.925 to 7.250	12	-22
24.05 to 29.00	12	-27
75.00 to 85.00	8	-38

Same requirements are given in RSS-211, 5.2.a) and c)

Antenna data:

Antennas	Maximum gain	Maximum 3 dB beam width	Maximum side lobe level > 60°
40 mm lens antenna	26 dBi	7.6	-15 dBi (-41 dBc)

Note:

See manufacturer's documentation

12.5 Emissions from digital circuitry

Description:

§15.256(k) Emissions from digital circuitry used to enable the operation of the transmitter may comply with the limits in §15.209 of this chapter provided it can be clearly demonstrated that those emissions are due solely to emissions from digital circuitry contained within the transmitter and the emissions are not intended to be radiated from the transmitter's antenna. Emissions from associated digital devices, as defined in §15.3(k) of this part, e.g., emissions from digital circuitry used to control additional functions or capabilities other than the operation of the transmitter, are subject to the limits contained in subpart B, part 15 of this chapter. Emissions from these digital circuits shall not be employed in determining the -10 dB bandwidth of the fundamental emission or the frequency at which the highest emission level occurs.

Measurement:

Measurement parameter	
Detector:	Quasi Peak / Average (RMS)
Sweep time:	Auto
Resolution bandwidth:	100 kHz / 1 MHz
Video bandwidth:	> resbw
Trace-Mode:	Max-Hold

Limits:

FCC §15.109 / RSS-Gen, 7.1		
Field strength of the harmonics and spurious.		
Frequency (MHz)	Field strength ($\mu\text{V}/\text{m}$)	Measurement distance (m)
0.009 – 0.490	2400/F(kHz)	300
0.490 – 1.705	24000/F(kHz)	30
1.705 – 30	30 (29.5 dB $\mu\text{V}/\text{m}$)	30
30 – 88	100 (40 dB $\mu\text{V}/\text{m}$)	3
88 – 216	150 (43.5 dB $\mu\text{V}/\text{m}$)	3
216 – 960	200 (46 dB $\mu\text{V}/\text{m}$)	3
>960	500 (54 dB $\mu\text{V}/\text{m}$)	3

Results:

See 12.3 Unwanted emissions limit according to §15.256(h) / RSS-211, 5.1 d).

12.6 Spurious emissions conducted < 30 MHz (AC power line)

Description:

Measurement of the conducted spurious emissions in transmit mode below 30 MHz. Both power lines, phase and neutral line, are measured. Found peaks are re-measured with average and quasi peak detection to show compliance to the limits.

Measurement:

Measurement parameter	
Detector:	Peak - Quasi Peak / Average
Sweep time:	Auto
Resolution bandwidth:	F < 150 kHz: 1 kHz F > 150 kHz: 100 kHz
Video bandwidth:	F < 150 kHz: 200 Hz F > 150 kHz: 9 kHz
Span:	9 kHz to 30 MHz
Trace-Mode:	Max Hold

Limits:

FCC	IC	
CFR Part 15.107 / 15.207(a)	RSS-Gen 8.8	
Conducted Spurious Emissions < 30 MHz		
Frequency (MHz)	Quasi-Peak (dBµV/m)	Average (dBµV/m)
0.15 – 0.5	79 (Class A) 66 to 56* (Class B)	66 (Class A) 56 to 46* (Class B)
0.5 – 5	73 (Class A) 56 (Class B)	63 (Class A) 46 (Class B)
5 – 30.0	73 (Class A) 60 (Class B)	63 (Class A) 50 (Class B)

*Decreases with the logarithm of the frequency

Plot 14: Phase line

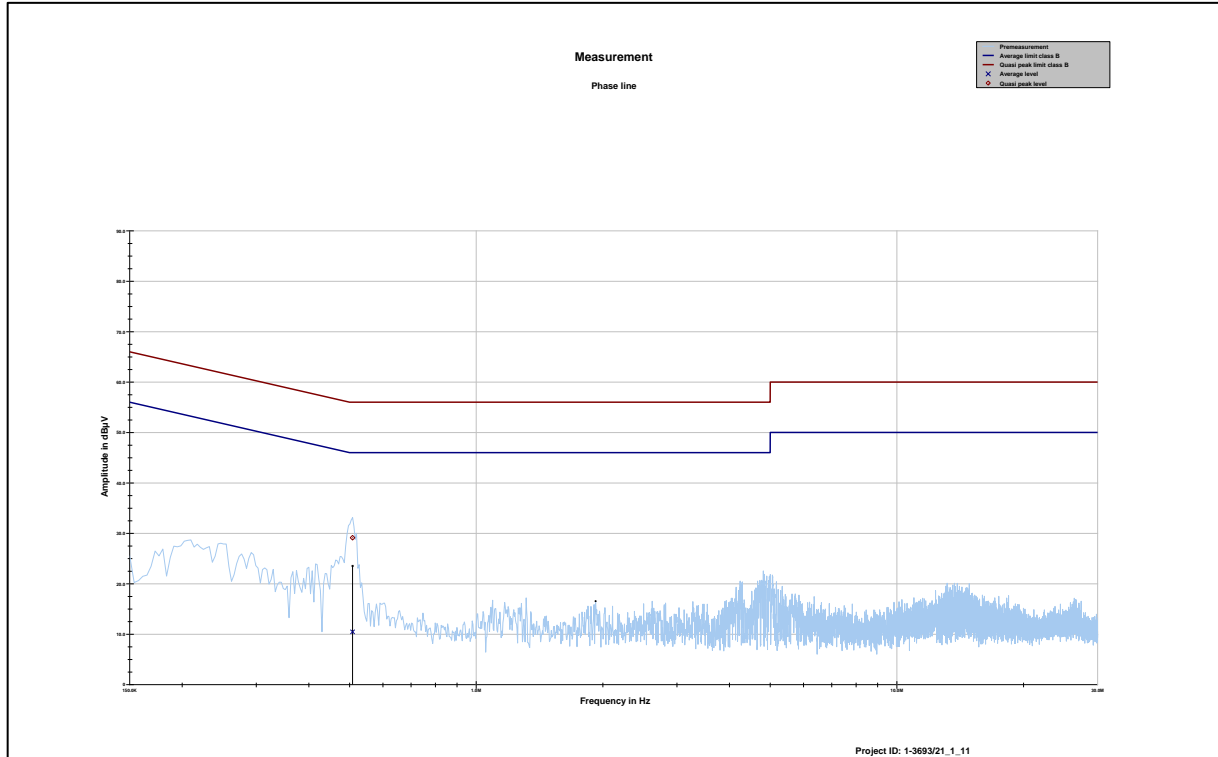

Frequency	Quasi peak level	Margin quasi peak	Limit QP	Average level	Margin Average	Limit AV
MHz	dBµV	dB	dBµV	dBµV	dB	dBµV
0.508200	29.12	26.88	56.000	10.46	35.54	46.000

Plot 15: Neutral line

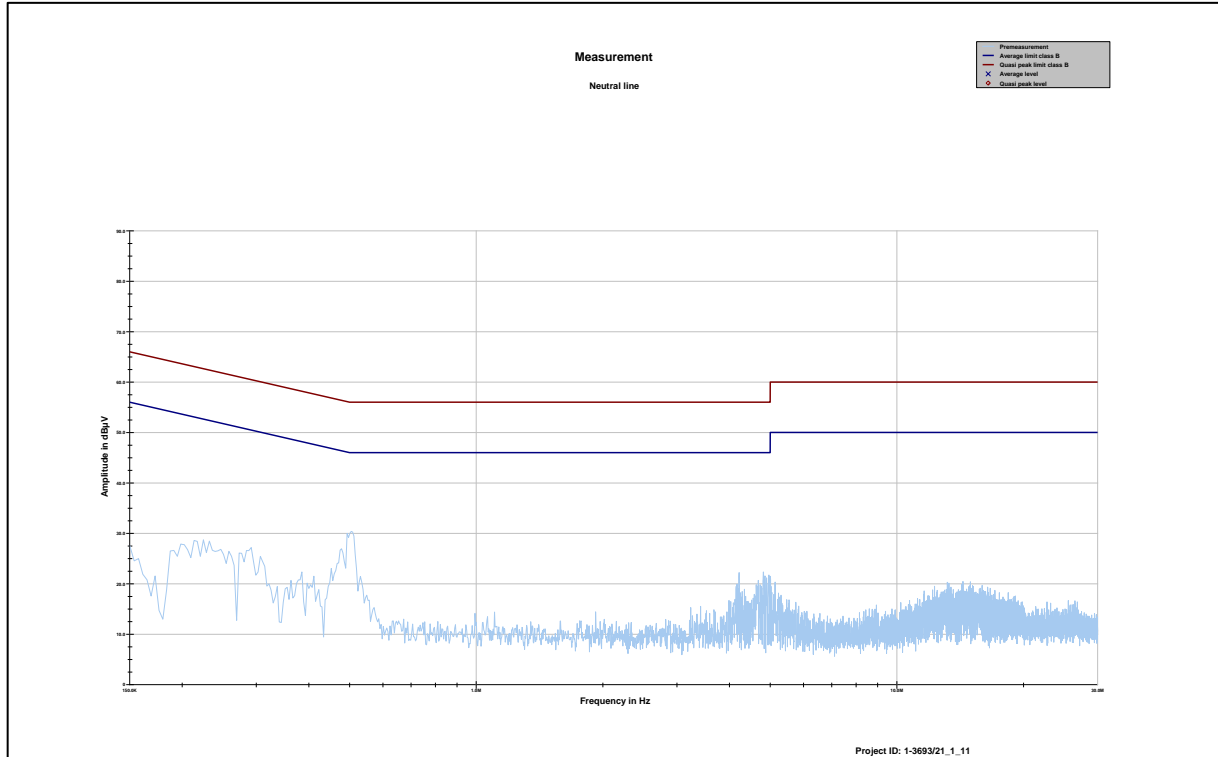

Frequency	Quasi peak level	Margin quasi peak	Limit QP	Average level	Margin Average	Limit AV
MHz	dBµV	dB	dBµV	dBµV	dB	dBµV

13 Glossary

EUT	Equipment under test
DUT	Device under test
UUT	Unit under test
GUE	GNSS User Equipment
ETSI	European Telecommunications Standards Institute
EN	European Standard
FCC	Federal Communications Commission
FCC ID	Company Identifier at FCC
IC	Industry Canada
PMN	Product marketing name
HMN	Host marketing name
HVIN	Hardware version identification number
FVIN	Firmware version identification number
EMC	Electromagnetic Compatibility
HW	Hardware
SW	Software
Inv. No.	Inventory number
S/N or SN	Serial number
C	Compliant
NC	Not compliant
NA	Not applicable
NP	Not performed
PP	Positive peak
QP	Quasi peak
AVG	Average
OC	Operating channel
OCW	Operating channel bandwidth
OBW	Occupied bandwidth
OOB	Out of band
DFS	Dynamic frequency selection
CAC	Channel availability check
OP	Occupancy period
NOP	Non occupancy period
DC	Duty cycle
PER	Packet error rate
CW	Clean wave
MC	Modulated carrier
WLAN	Wireless local area network
RLAN	Radio local area network
DSSS	Dynamic sequence spread spectrum
OFDM	Orthogonal frequency division multiplexing
FHSS	Frequency hopping spread spectrum
GNSS	Global Navigation Satellite System
C/N₀	Carrier to noise-density ratio, expressed in dB-Hz

14 Document history

Version	Applied changes	Date of release
-/-	Draft	2022-07-05
	Initial release	2022-07-26

15 Accreditation Certificate – D-PL-12076-01-04

first page	last page
 <p>Deutsche Akkreditierungsstelle GmbH</p> <p>Entrusted according to Section 8 subsection 1 AkkStelleG in connection with Section 1 subsection 1 AkkStelleGBV Signatory to the Multilateral Agreements of EA, ILAC and IAF for Mutual Recognition</p> <p>Accreditation </p> <p>The Deutsche Akkreditierungsstelle GmbH attests that the testing laboratory CTC advanced GmbH Untertürkheimer Straße 6-10, 66117 Saarbrücken is competent under the terms of DIN EN ISO/IEC 17025:2018 to carry out tests in the following fields: Telecommunication (TC) and Electromagnetic Compatibility (EMC) for Canadian Standards</p> <p>The accreditation certificate shall only apply in connection with the notice of accreditation of 09.06.2020 with the accreditation number D-PL-12076-01. It comprises the cover sheet, the reverse side of the cover sheet and the following annex with a total of 07 pages. Registration number of the certificate: D-PL-12076-01-04</p> <p>Frankfurt am Main, 09.06.2020 by order Prof.-Ing. (FH) Ralf Egner Head of Division</p> <p><small>The certificate together with its annex reflects the status at the time of the date of issue. The current status of the scope of accreditation can be found in the database of accredited bodies of Deutsche Akkreditierungsstelle GmbH. https://www.dakks.de/en/content/accredited-bodies-dakks See also annex.</small></p>	<p>Deutsche Akkreditierungsstelle GmbH</p> <p>Office Berlin Spittelmarkt 10 10117 Berlin</p> <p>Office Frankfurt am Main Europa-Allee 52 60327 Frankfurt am Main</p> <p>Office Braunschweig Bundesallee 100 38116 Braunschweig</p> <p>The publication of extracts of the accreditation certificate is subject to the prior written approval by Deutsche Akkreditierungsstelle GmbH (DAKKS). Exempted is the unchanged form of separate disseminations of the cover sheet by the conformity assessment body mentioned overleaf.</p> <p>No impression shall be made that the accreditation also extends to fields beyond the scope of accreditation attested by DAKKS.</p> <p>The accreditation was granted pursuant to the Act on the Accreditation Body (AkkStelleG) of 31 July 2009 (Federal Law Gazette I p. 2625) and the Regulation (EC) No 765/2008 of the European Parliament and of the Council of 9 July 2008 setting out the requirements for accreditation and market surveillance relating to the marketing of products (Official Journal of the European Union L 218 of 9 July 2008, p. 30). DAKKS is a signatory to the Multilateral Agreements for Mutual Recognition of the European co-operation for Accreditation (EA), International Accreditation Forum (IAF) and International Laboratory Accreditation Cooperation (ILAC). The signatories to these agreements recognise each other's accreditations.</p> <p>The up-to-date state of membership can be retrieved from the following websites: EA: www.european-accreditation.org ILAC: www.ilac.org IAF: www.iaf.nu</p>

Note: The current certificate annex is published on the websites (link see below).

<https://www.dakks.de/files/data/as/pdf/D-PL-12076-01-04e.pdf>

or

https://ctcadvanced.com/app/uploads/2020/06/D-PL-12076-01-04_Canada_TCEMC.pdf

16 Accreditation Certificate – D-PL-12076-01-05

first page	last page			
 <p>Deutsche Akkreditierungsstelle GmbH</p> <p>Entrusted according to Section 8 subsection 1 AkkStelleG in connection with Section 1 subsection 1 AkkStelleGBV Signatory to the Multilateral Agreements of EA, ILAC and IAF for Mutual Recognition</p> <p>Accreditation </p> <p>The Deutsche Akkreditierungsstelle GmbH attests that the testing laboratory CTC advanced GmbH Untertürkheimer Straße 6-10, 66117 Saarbrücken is competent under the terms of DIN EN ISO/IEC 17025:2018 to carry out tests in the following fields: Telecommunication (FCC Requirements)</p> <p>The accreditation certificate shall only apply in connection with the notice of accreditation of 09.06.2020 with the accreditation number D-PL-12076-01. It comprises the cover sheet, the reverse side of the cover sheet and the following annex with a total of 05 pages. Registration number of the certificate: D-PL-12076-01-05</p> <p>Frankfurt am Main, 09.06.2020 by ordy. Dipl.-Ing. (FH)  H. Egner Head of Division</p> <p><small>The certificate together with its annex reflects the status at the time of the date of issue. The current status of the scope of accreditation can be found in the database of accredited bodies of Deutsche Akkreditierungsstelle GmbH. https://www.dakks.de/en/content/accredited-bodies-dakks See water event.</small></p>	<p>Deutsche Akkreditierungsstelle GmbH</p> <table border="0"> <tr> <td>Office Berlin Spittelmarkt 10 10117 Berlin</td> <td>Office Frankfurt am Main Europa-Allee 52 60327 Frankfurt am Main</td> <td>Office Braunschweig Bundesallee 100 38116 Braunschweig</td> </tr> </table> <p>The publication of extracts of the accreditation certificate is subject to the prior written approval by Deutsche Akkreditierungsstelle GmbH (DAkKS). Exempted is the unchanged form of separate disseminations of the cover sheet by the conformity assessment body mentioned overleaf.</p> <p>No impression shall be made that the accreditation also extends to fields beyond the scope of accreditation attested by DAkKS.</p> <p>The accreditation was granted pursuant to the Act on the Accreditation Body (AkkStelleG) of 31 July 2009 (Federal Law Gazette I p. 2625) and the Regulation (EC) No 765/2008 of the European Parliament and of the Council of 9 July 2008 setting out the requirements for accreditation and market surveillance relating to the marketing of products (Official Journal of the European Union L 218 of 9 July 2008, p. 30). DAkKS is a signatory to the Multilateral Agreements for Mutual Recognition of the European co-operation for Accreditation (EA), International Accreditation Forum (IAF) and International Laboratory Accreditation Cooperation (ILAC). The signatories to these agreements recognise each other's accreditations.</p> <p>The up-to-date state of membership can be retrieved from the following websites: EA: www.european-accreditation.org ILAC: www.ilac.org IAF: www.iaf.nu</p>	Office Berlin Spittelmarkt 10 10117 Berlin	Office Frankfurt am Main Europa-Allee 52 60327 Frankfurt am Main	Office Braunschweig Bundesallee 100 38116 Braunschweig
Office Berlin Spittelmarkt 10 10117 Berlin	Office Frankfurt am Main Europa-Allee 52 60327 Frankfurt am Main	Office Braunschweig Bundesallee 100 38116 Braunschweig		

Note: The current certificate annex is published on the websites (link see below).

<https://www.dakks.de/files/data/as/pdf/D-PL-12076-01-05e.pdf>

or

https://ctcadvanced.com/app/uploads/2020/06/D-PL-12076-01-05_TCB_USA.pdf

END OF TEST REPORT