

Rosemount™ 1208C Level and Flow Transmitter

Non-Contacting Radar



Contents

About this guide.....	3
Installing on a tank.....	5
Prepare the electrical connections.....	8
Power up transmitter.....	10
Configuration.....	11

1 About this guide

This Quick Start Guide provides basic guidelines for the Rosemount 1208C Level and Flow Transmitter. Refer to the 1208C [Reference Manual](#) for more instructions.

1.1 Safety messages

⚠ WARNING

Failure to follow safe installation and servicing guidelines could result in death or serious injury.

Ensure the transmitter is installed by qualified personnel and in accordance with applicable code of practice.

Use the equipment only as specified in this Quick Start Guide and the Reference Manual. Failure to do so may impair the protection provided by the equipment.

Repair, e.g. substitution of components, etc. may jeopardize safety and is under no circumstances allowed.

⚠ WARNING

Explosions could result in death or serious injury.

To prevent ignition of flammable or combustible atmospheres, disconnect power before servicing.

Before connecting a handheld communicator in an explosive atmosphere, ensure that the instruments are installed in accordance with intrinsically safe or non-incendive field wiring practices.

⚠ WARNING

Process leaks could result in death or serious injury.

Handle the transmitter carefully.

Install and tighten process connectors before applying pressure.

Do not attempt to loosen or remove process connectors while the transmitter is in service.

⚠ WARNING**Physical access**

Unauthorized personnel may potentially cause significant damage to and/or misconfiguration of end users' equipment. This could be intentional or unintentional and needs to be protected against.

Physical security is an important part of any security program and fundamental to protecting your system. Restrict physical access by unauthorized personnel to protect end users' assets. This is true for all systems used within the facility.

⚠ CAUTION**Hot surfaces**

The transmitter and process seal may be hot at high process temperatures. Allow to cool before servicing.



1.2 Bracket mounting

See the documentation supplied with the bracket kit.

2 Installing on a tank

2.1 Mount the flange

Procedure

1. Place a suitable gasket on the tank flange.

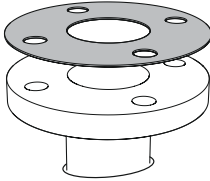

2. Place the flange over the gasket.

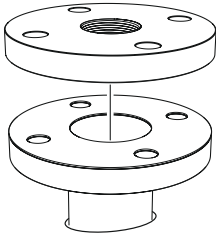

3. Tighten the bolts and nuts with sufficient torque for the flange and gasket choice.

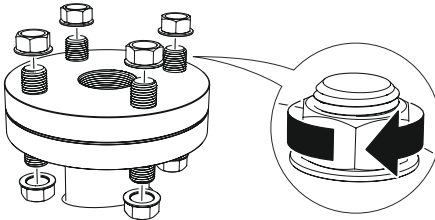

4. Apply appropriate thread sealant to the transmitter threads.

Note

Only for NPT threaded tank connection.

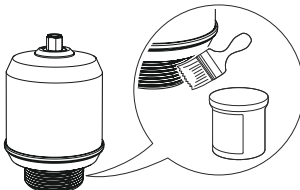

5. Install and hand tighten the transmitter.

Note

The gasket is necessary for the G threaded version only.

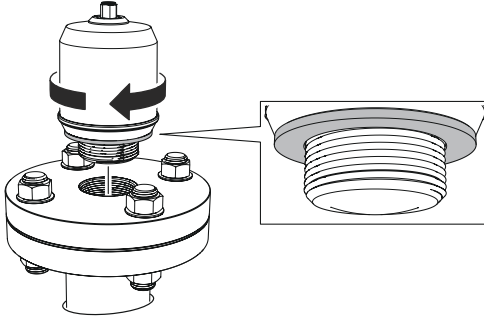

2.2 Mount the NPT threaded adapter

Procedure

1. Apply appropriate thread sealant to the outer threads.

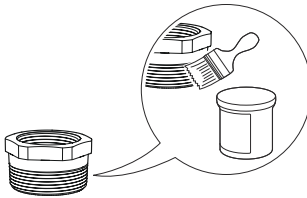

2. Mount the threaded adapter on the tank.

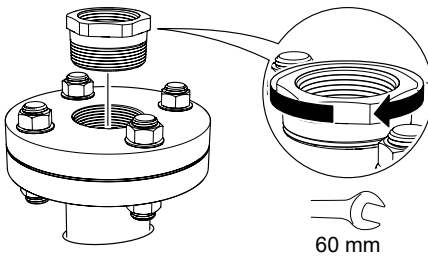

3. Apply appropriate thread sealant to the transmitter threads.

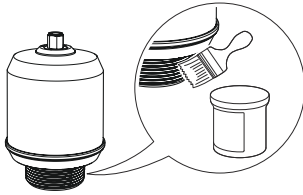

4. Install and hand tighten the transmitter.

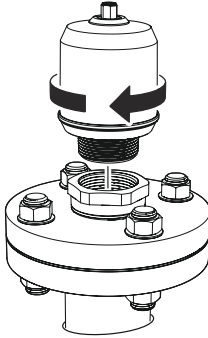

3 Prepare the electrical connections

3.1 Connector type

M12 male (A-coded)

3.2 Cable selection

Use 24-18 AWG wire (0.20-0.75 mm²). Twisted pairs and shielded wiring are recommended for environments with high EMI (electromagnetic interference).

3.3 Internal power consumption

< 0.8 W in normal operation

3.4 Cable shield grounding

Make sure the instrument cable shield is:

- Continuously connected throughout the segment.
- Connected to a good earth ground at the power supply end.

3.5 Power supply

The transmitter operates on 14-35 Vdc at the transmitter terminals.

3.6 Load limitations

For HART[®] communication, a minimum loop resistance of 250 Ω is required. Maximum loop resistance (R) is determined by the voltage level of the external power supply (U_E):

$$R = 44.4 \times (U_E - 14)$$

Figure 3-1: Load Limits

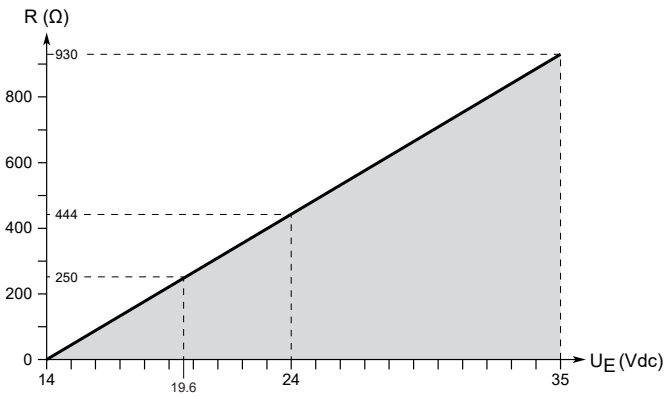

3.7 Wiring diagram

Figure 3-2: Connection

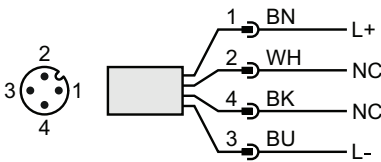

Table 3-1: Pin Assignment

Pin	Wire color ⁽¹⁾		Signal	
1	BN	Brown	L+	24 V
2	WH	White	NC	Not connected
3	BU	Blue	L-	0 V
4	BK	Black	NC	Not connected

(1) According to IEC 60947-5-2.

4 Power up transmitter

Procedure

1. ⚠ Verify the power supply is disconnected.
2. Insert the M12 connector gently.

Note

Do not force the connector into place. Check that it is aligned properly.

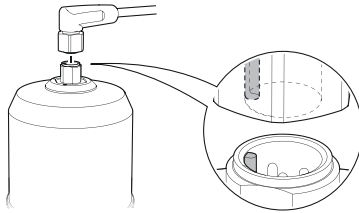

3. Once fully inserted, turn the screw ring until tight.
See the manufacturer's instruction manual for recommended torque.

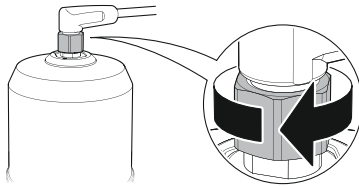

4. Connect the power supply.

5 Configuration

5.1 Configuration tools

- Field Device Integration (FDI) compliant systems
- Device Descriptor (DD) compliant systems
- Device Type Manager (DTM™) compliant systems (pending)

5.2 Download AMS Device Configurator

AMS Device Configurator is a software for configuration of Emerson field devices using FDI technology.

Procedure

Download the software at [Emerson.com/AMSDeviceConfigurator](https://emerson.com/AMSDeviceConfigurator).

5.3 Confirm correct device driver

Procedure

1. Verify that the correct FDI/DD/DTM Package is loaded on your systems to ensure proper communication.
2. Download the latest FDI/DD/DTM Package at [Emerson.com/DeviceInstallKits](https://emerson.com/DeviceInstallKits).

5.4 Configure transmitter using guided setup

The options available in the Guided Setup wizard include all items required for basic operation.

Procedure

1. Select **Configure** → **Guided Setup** → **Initial Setup**.
2. Select **Basic Setup** and follow the on-screen instructions.
3. Select **Verify Level** to check your level measurement.



Quick Start Guide
00825-0200-7062, Rev. AA
February 2023

For more information: [Emerson.com](https://www.emerson.com)

©2023 Emerson. All rights reserved.

Emerson Terms and Conditions of Sale are available upon request. The Emerson logo is a trademark and service mark of Emerson Electric Co. Rosemount is a mark of one of the Emerson family of companies. All other marks are the property of their respective owners.

ROSEMOUNT™

