



International Certification Corp.

No. 3-1, Lane 6, Wen San 3rd St., Kwei Shan Hsiang, Tao Yuan Hsien 333, Taiwan, R.O.C.

Tel: 886-3-271-8666

Fax: 886-3-318-0155

FCC Test Report

FCC ID : K7T-BPM2001
Equipment : CSR8311 BlueTooth Module
Model No. : BPM2001
Brand Name : Radicom Research Inc
Applicant : Radicom Research Inc
Address : 2148 Bering Drive, San Jose, California 95131
Standard : 47 CFR FCC Part 15.247
Received Date : Aug. 07, 2013
Tested Date : Aug. 19 ~ Aug. 26, 2013

We, International Certification Corp., would like to declare that the tested sample has been evaluated and in compliance with the requirement of the above standards. The test results contained in this report refer exclusively to the product. It may be duplicated completely for legal use with the approval of the applicant. It shall not be reproduced except in full without the written approval of our laboratory.

Approved & Reviewed by:



Gary Chang / Manager





Table of Contents

1	GENERAL DESCRIPTION	5
1.1	Information.....	5
1.2	Local Support Equipment List	7
1.3	Test Setup Chart	7
1.4	The Equipment List	8
1.5	Test Standards	9
1.6	Measurement Uncertainty	10
2	TEST CONFIGURATION	11
2.1	Testing Condition	11
2.2	The Worst Test Modes and Channel Details	11
3	TRANSMITTER TEST RESULTS.....	12
3.1	Conducted Emissions.....	12
3.2	Unwanted Emissions into Restricted Frequency Bands	15
3.3	Emissions in non-restricted frequency bands	25
3.4	Conducted Output Power	28
3.5	Number of Hopping Frequency	30
3.6	20dB and Occupied Bandwidth	32
3.7	Channel Separation.....	34
3.8	Number of Dwell Time.....	36



Release Record

Report No.	Version	Description	Issued Date
FR381603AD	Rev. 01	Initial issue	Sep. 05, 2013



Summary of Test Results

FCC Rules	Test Items	Measured	Result
15.207	Conducted Emissions	[dBuV]: 0.161MHz 40.24 (Margin -15.19dB) - AV	Pass
15.247(d) 15.209	Radiated Emissions	[dBuV/m at 3m]: 2323.00MHz 46.98 (Margin -7.02dB) - AV	Pass
15.247(d)	Band Edge	Meet the requirement of limit	Pass
15.247(b)(1)	Conducted Output Power	Power [dBm]: BR: 9.16	Pass
15.247(a)(1)(iii)	Number of Hopping Channels	Meet the requirement of limit	Pass
15.247(a)(1)	Hopping Channel Separation	Meet the requirement of limit	Pass
15.247(a)(1)(iii)	Dwell Time	Meet the requirement of limit	Pass
15.203	Antenna Requirement	Meet the requirement of limit	Pass



1 General Description

1.1 Information

1.1.1 Specification of the Equipment under Test (EUT)

RF General Information				
Frequency Range (MHz)	Bluetooth Mode	Ch. Frequency (MHz)	Channel Number	Data Rate
2400-2483.5	BR V4.0	2402-2480	0-78 [79]	1 Mbps

Note 1: RF output power specifies that Maximum Peak Conducted Output Power.
Note 2: Bluetooth BR uses a GFSK.

1.1.2 Antenna Details

Ant. No.	Type	Gain (dBi)	Connector	Remark
1	Inverted-F	-1	---	---

1.1.3 EUT Operational Condition

Supply Voltage	<input type="checkbox"/> AC mains	<input checked="" type="checkbox"/> DC (3.3Vdc)	
Type of DC Source	<input type="checkbox"/> Internal DC supply	<input type="checkbox"/> External DC adapter	<input checked="" type="checkbox"/> From Host

1.1.4 Accessories

N/A



1.1.5 Channel List

Frequency band (MHz)				2400~2483.5			
Channel	Frequency (MHz)	Channel	Frequency (MHz)	Channel	Frequency (MHz)	Channel	Frequency (MHz)
0	2402	20	2422	40	2442	60	2462
1	2403	21	2423	41	2443	61	2463
2	2404	22	2424	42	2444	62	2464
3	2405	23	2425	43	2445	63	2465
4	2406	24	2426	44	2446	64	2466
5	2407	25	2427	45	2447	65	2467
6	2408	26	2428	46	2448	66	2468
7	2409	27	2429	47	2449	67	2469
8	2410	28	2430	48	2450	68	2470
9	2411	29	2431	49	2451	69	2471
10	2412	30	2432	50	2452	70	2472
11	2413	31	2433	51	2453	71	2473
12	2414	32	2434	52	2454	72	2474
13	2415	33	2435	53	2455	73	2475
14	2416	34	2436	54	2456	74	2476
15	2417	35	2437	55	2457	75	2477
16	2418	36	2438	56	2458	76	2478
17	2419	37	2439	57	2459	77	2479
18	2420	38	2440	58	2460	78	2480
19	2421	39	2441	59	2461	---	---



1.1.6 Test Tool and Duty Cycle

Test Tool	Blue Test3 ver. 2.4.8.0
-----------	-------------------------

1.1.7 Power Setting

Modulation Mode	Test Frequency (MHz)		
	2402	2441	2480
GFSK/1Mbps	255,63	255,63	255,63

1.2 Local Support Equipment List

Support Equipment List						
No.	Equipment	Brand	Model	S/N	FCC ID	Signal cable / Length (m)
1	Notebook	DELL	E6420	---	DoC	USB 1.8m non-shielded cable w/o core.

1.3 Test Setup Chart

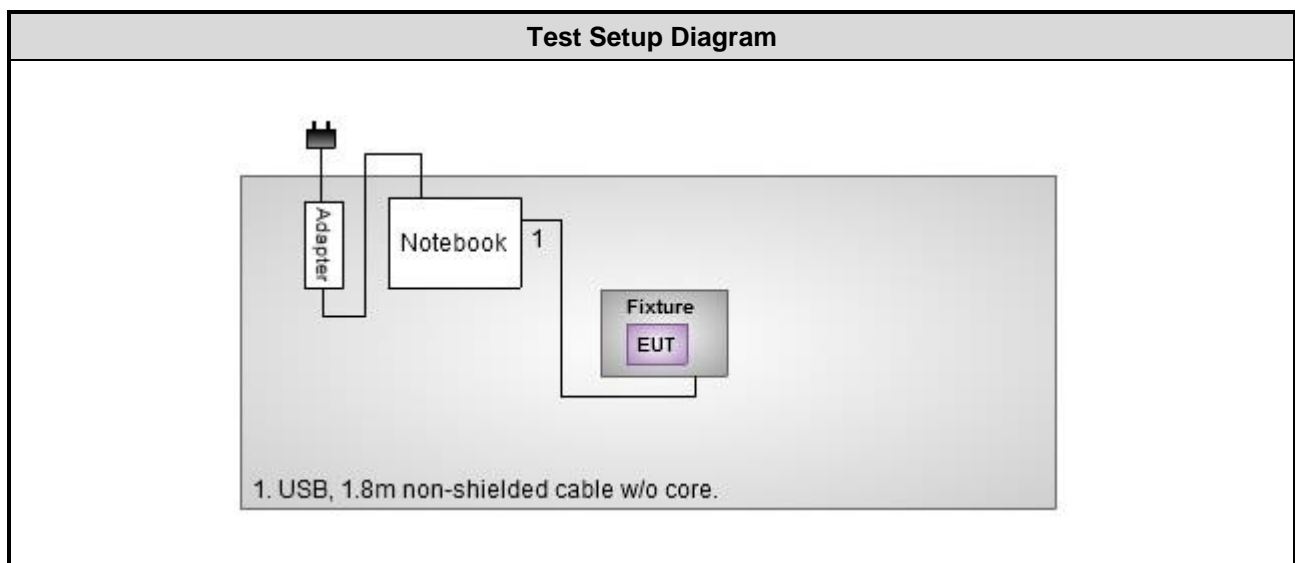



1.4 The Equipment List

Test Item	Conducted Emission				
Test Site	Conduction room 1 / (CO01-WS)				
Instrument	Manufacturer	Model No.	Serial No.	Calibration Date	Calibration Until
EMC Receiver	R&S	ESCS 30	100169	Oct. 02, 2012	Oct. 01, 2013
LISN	SCHWARZBECK MESS-ELEKTRONIK	Schwarzbeck 8127	8127-667	Dec. 04, 2012	Dec. 03, 2013
LISN (Support Unit)	SCHWARZBECK MESS-ELEKTRONIK	Schwarzbeck 8127	8127-666	Dec. 04, 2012	Dec. 03, 2013
ISN	TESEQ	ISN T800	34406	Apr. 08, 2013	Apr. 07, 2014
ISN	TESEQ	ISN T200A	30494	Apr. 09, 2013	Apr. 08, 2014
ISN	TESEQ	ISN T8-Cat6	27262	Sep. 17, 2012	Sep. 16, 2013
ISN	TESEQ	ISN ST08	22589	Jan. 24, 2013	Jan. 23, 2014
RF Current Probe	FCC	F-33-4	121630	Dec. 04, 2012	Dec. 03, 2013
RF Cable-CON	Woken	CFD200-NL	CFD200-NL-001	Dec. 25, 2012	Dec. 24, 2013
ESH3-Z6 V-Network(+)	R&S	ESH3-Z6	100920	Nov. 21, 2012	Nov. 20, 2013
ESH3-Z6 V-Network(-)	R&S	ESH3-Z6	100951	Jan. 30, 2013	Jan. 29, 2014
Two-Line V-Network	R&S	ENV216	101579	Jan. 07, 2013	Jan. 06, 2014
50 ohm terminal	NA	50	01	Apr. 22, 2013	Apr. 21, 2014
50 ohm terminal	NA	50	02	Apr. 22, 2013	Apr. 21, 2014
50 ohm terminal	NA	50	03	Apr. 22, 2013	Apr. 21, 2014
50 ohm terminal (Support Unit)	NA	50	04	Apr. 22, 2013	Apr. 21, 2014

Note: Calibration Interval of instruments listed above is one year.

Test Item	Radiated Emission above 1GHz				
Test Site	966 chamber1 / (03CH01-WS)				
Instrument	Manufacturer	Model No.	Serial No.	Calibration Date	Calibration Until
3m semi-anechoic chamber	CHAMPRO	SAC-03	03CH01-WS	Jan. 04, 2013	Jan. 03, 2014
Spectrum Analyzer	R&S	FSV40	101498	Jan. 24, 2013	Jan. 23, 2014
Receiver	ROHDE&SCHWARZ	ESR3	101658	Jan. 28, 2013	Jan. 27, 2014
Bilog Antenna	SCHWARZBECK	VULB9168	VULB9168-522	Jan. 11, 2013	Jan. 10, 2014
Horn Antenna 1G-18G	SCHWARZBECK	BBHA 9120 D	BBHA 9120 D 1096	Feb. 18, 2013	Feb. 17, 2014
Horn Antenna 18G-40G	SCHWARZBECK	BBHA 9170	BBHA 9170517	Jan. 14, 2013	Jan. 13, 2014
Amplifier	Burgeon	BPA-530	100219	Nov. 28, 2012	Nov. 27, 2013
Amplifier	Agilent	83017A	MY39501308	Dec. 18, 2012	Dec. 17, 2013
RF Cable	HUBER+SUHNER	SUCOFLEX104	MY16014/4	Dec. 25, 2012	Dec. 24, 2013
RF Cable	HUBER+SUHNER	SUCOFLEX104	MY16019/4	Dec. 25, 2012	Dec. 24, 2013
RF Cable	HUBER+SUHNER	SUCOFLEX104	MY16139/4	Dec. 25, 2012	Dec. 24, 2013



Test Item	Radiated Emission above 1GHz				
Test Site	966 chamber1 / (03CH01-WS)				
Instrument	Manufacturer	Model No.	Serial No.	Calibration Date	Calibration Until
RF Cable-R03m	Woken	CFD400NL-LW	CFD400NL-001	Dec. 25, 2012	Dec. 24, 2013
RF Cable-R10m	Woken	CFD400NL-LW	CFD400NL-002	Dec. 25, 2012	Dec. 24, 2013
control	EM Electronics	EM1000	60612	N/A	N/A
Note: Calibration Interval of instruments listed above is one year.					

Loop Antenna	R&S	HFH2-Z2	100330	Nov. 15, 2012	Nov. 14, 2014
Amplifier	MITEQ	AMF-6F-260400	9121372	Apr. 19, 2013	Apr. 18, 2015
Note: Calibration Interval of instruments listed above is two year.					

Test Item	RF Conducted				
Test Site	(TH01-WS)				
Instrument	Manufacturer	Model No.	Serial No.	Calibration Date	Calibration Until
Spectrum Analyzer	R&S	FSV 40	101063	Feb. 18, 2013	Feb. 17, 2014
TEMP&HUMIDITY CHAMBER	GIANT FORCE	GCT-225-40-SP-SD	MAF1212-002	Nov. 29, 2012	Nov. 28, 2013
Power Meter	Anritsu	ML2495A	1241002	Oct. 15, 2012	Oct. 14, 2013
Power Sensor	Anritsu	MA2411B	1027366	Oct. 24, 2012	Oct. 23, 2013
Signal Generator	R&S	SMB100A	175727	Jan. 14, 2013	Jan. 13, 2014
Radio Communication Analyzer	Anritsu	MT8820C	6201240341	Mar. 13, 2013	Mar. 12, 2014
Wideband Radio Communication Tester	R&S	CMW500	106070	Jan. 29, 2013	Jan. 28, 2014
Bluetooth Tester	R&S	CBT	100959	Jan. 09, 2013	Jan. 08, 2014
MXG-B RF Vector Signal Generator	Agilent	N5182B	MY53050081	Apr. 19, 2013	Apr. 18, 2014
Mobile WiMAX test set	Agilent	E6651A	MY47310158	Oct. 09, 2012	Oct. 09, 2013
Note: Calibration Interval of instruments listed above is one year.					

1.5 Test Standards

According to the specification of EUT, the EUT must comply with following standards and KDB documents.

47 CFR FCC Part 15.247

FCC Public notice DA 00-705

ANSI C63.10-2009

Note: The EUT has been tested and complied with FCC part 15B requirement. FCC Part 15B test results are issued to another report.



1.6 Measurement Uncertainty

ISO/IEC 17025 requires that an estimate of the measurement uncertainties associated with the emissions test results be included in the report. The measurement uncertainties given below are based on a 95% confidence level (based on a coverage factor (k=2))

Measurement Uncertainty	
Parameters	Uncertainty
Bandwidth	±35.286 Hz
Conducted power	±0.536 dB
Frequency error	±35.286 Hz
Temperature	±0.3 °C
Conducted emission	±2.946 dB
AC conducted emission	±2.43 dB
Radiated emission	±2.49 dB



2 Test Configuration

2.1 Testing Condition

Test Item	Test Site	Ambient Condition	Tested By
AC Conduction	CO01-WS	23°C / 66%	Peter Lin
Radiated Emissions	03CH01-WS	23°C / 65% 24°C / 65%	Aska Huang Haru Yang
RF Conducted	TH01-WS	24°C / 61%	Brad Wu

➤ FCC site registration No.: 657002

➤ IC site registration No.: 10807A-1

2.2 The Worst Test Modes and Channel Details

Test item	Mode	Test Frequency (MHz)	Data rate (Mbps)	Test Configuration
Conducted Emissions	GFSK	2480	1Mbps	-
Radiated Emissions (below 1GHz)	GFSK	2480	1Mbps	-
Radiated Emissions (above 1GHz)	GFSK	2402, 2441, 2480	1Mbps	-
Conducted Output Power	GFSK	2402, 2441, 2480	1Mbps	-
Number of Hopping Channels	GFSK	2402~2480	1Mbps	-
Hopping Channel Separation	GFSK	2402, 2441, 2480	1Mbps	-
Dwell Time	GFSK	2402	1Mbps	-

NOTE:

1. The EUT was pretested with 3 orientations placed on the table for the radiated emission measurement – X, Y, and Z-plane. The **Z-plane** results were found as the worst case and were shown in this report.



3 Transmitter Test Results

3.1 Conducted Emissions

3.1.1 Limit of Conducted Emissions

Conducted Emissions Limit		
Frequency Emission (MHz)	Quasi-Peak	Average
0.15-0.5	66 - 56 *	56 - 46 *
0.5-5	56	46
5-30	60	50

Note 1: * Decreases with the logarithm of the frequency.

3.1.2 Test Procedures

1. The device is placed on a test table, raised 80 cm above the reference ground plane. The vertical conducting plane is located 40 cm to the rear of the device.
2. The device is connected to line impedance stabilization network (LISN) and other accessories are connected to other LISN. Measured levels of AC power line conducted emission are across the 50 Ω LISN port.
3. AC conducted emission measurements is made over frequency range from 150 kHz to 30 MHz.
4. This measurement was performed with AC 120V / 60Hz.

3.1.3 Test Setup

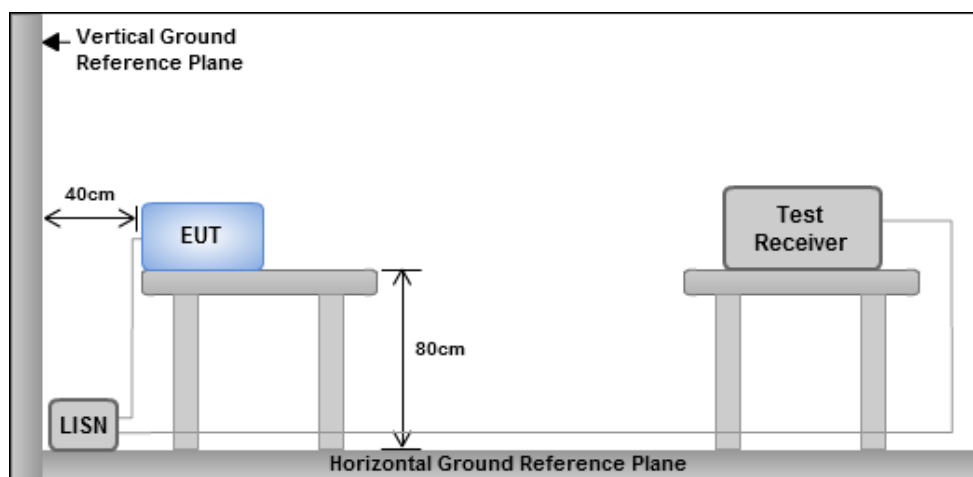

Note: 1. Support units were connected to second LISN.

2. Both of LISNs (AMN) are 80 cm from EUT and at least 80 cm from other units and other metal planes



3.1.4 Test Result of Conducted Emissions

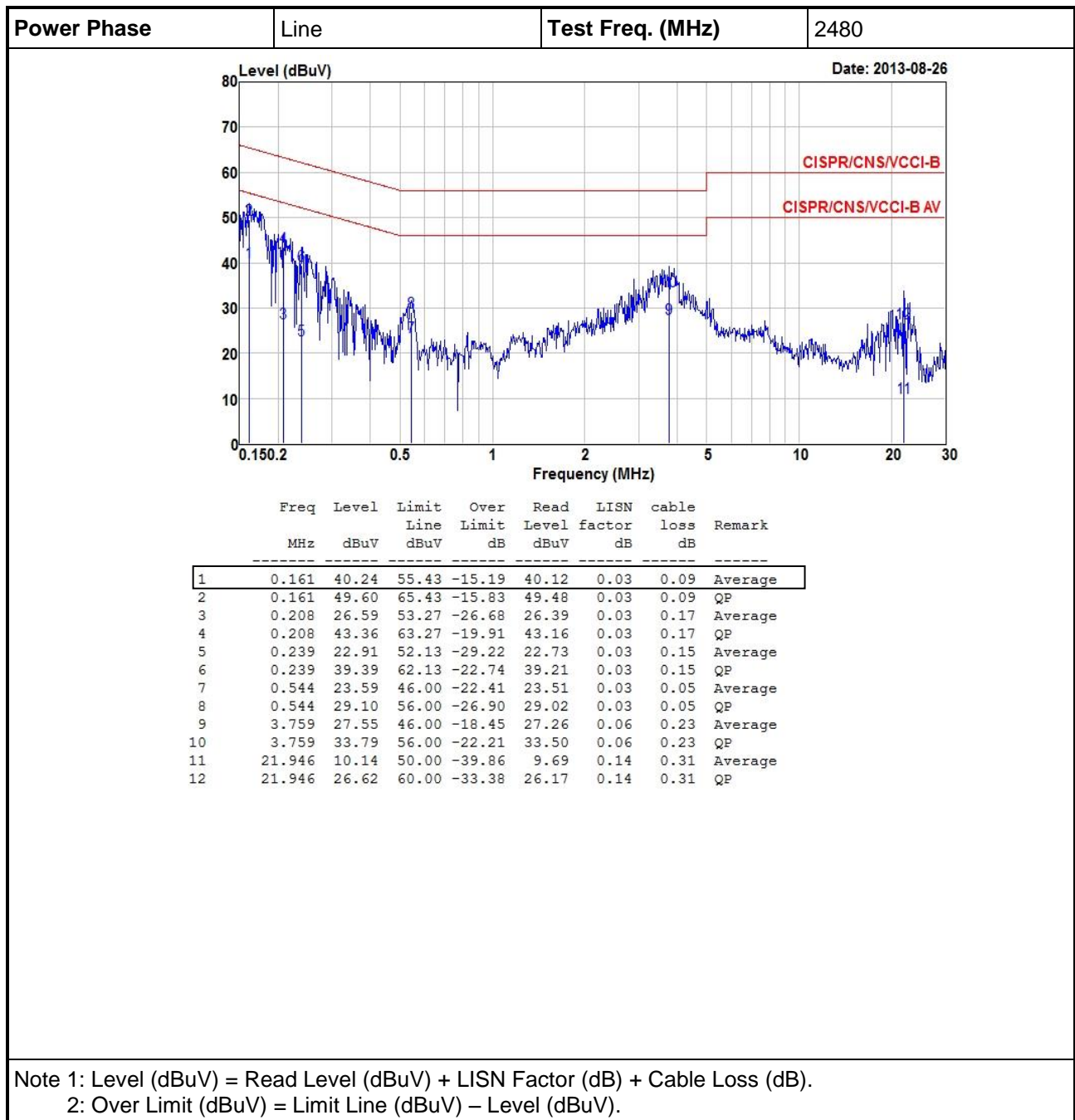

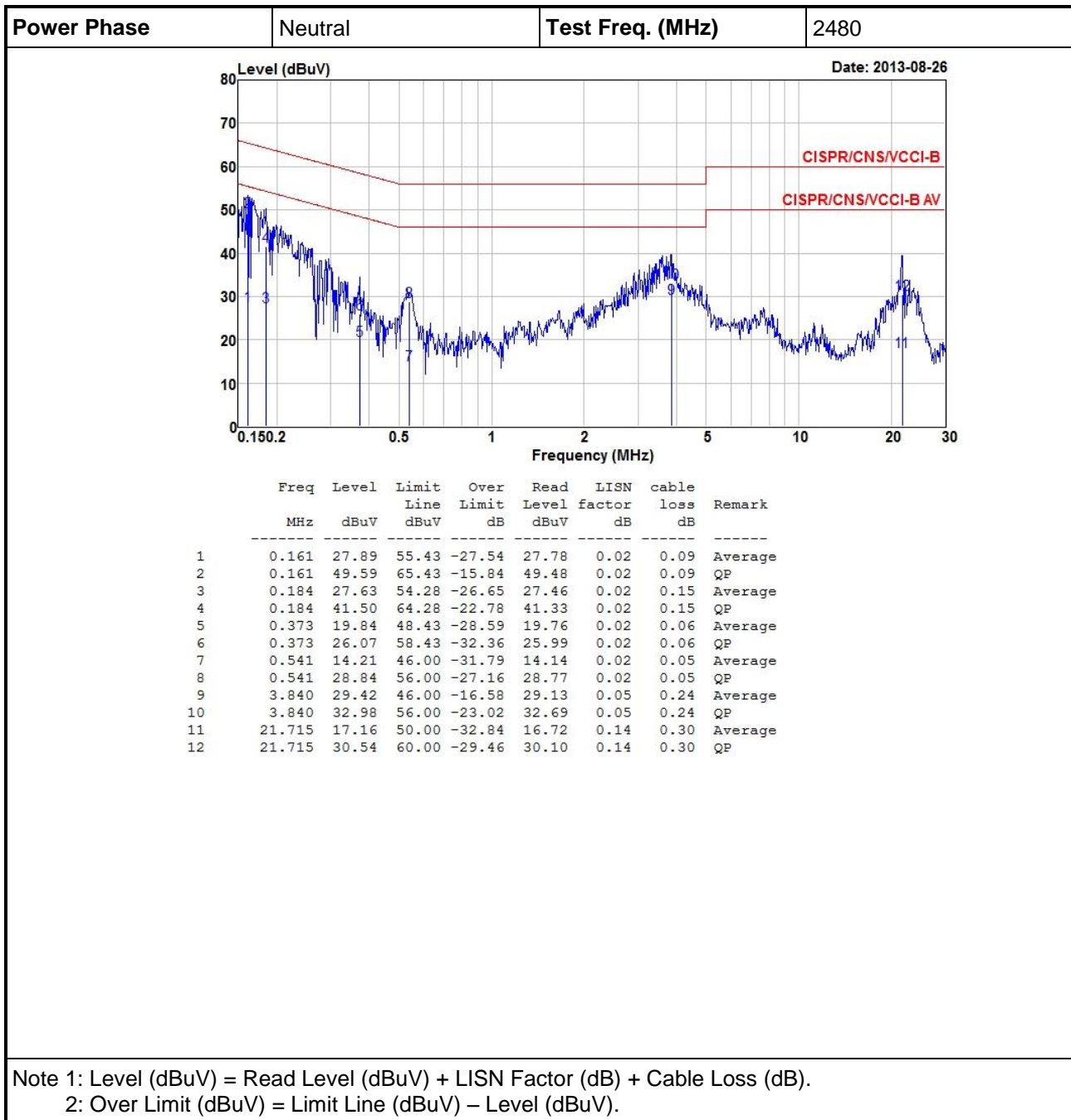



3.2 Unwanted Emissions into Restricted Frequency Bands

3.2.1 Limit of Unwanted Emissions into Restricted Frequency Bands

Restricted Band Emissions Limit			
Frequency Range (MHz)	Field Strength (uV/m)	Field Strength (dBuV/m)	Measure Distance (m)
0.009~0.490	2400/F(kHz)	48.5 - 13.8	300
0.490~1.705	24000/F(kHz)	33.8 - 23	30
1.705~30.0	30	29	30
30~88	100	40	3
88~216	150	43.5	3
216~960	200	46	3
Above 960	500	54	3

Note 1:
Qusai-Peak value is measured for frequency below 1GHz except for 9–90 kHz, 110–490 kHz frequency band. Peak and average value are measured for frequency above 1GHz. The limit on average radio frequency emission is as above table. The limit on peak radio frequency emissions is 20 dB above the maximum permitted average emission limit

Note 2:
Measurements may be performed at a distance other than what is specified provided. When performing measurements at a distance other than that specified, the results shall be extrapolated to the specified distance using an extrapolation factor as below, Frequency at or above 30 MHz: 20 dB/decade Frequency below 30 MHz: 40 dB/decade.

3.2.2 Test Procedures

1. Measurement is made at a semi-anechoic chamber that incorporates a turntable allowing a EUT rotation of 360°. A continuously-rotating, remotely-controlled turntable is installed at the test site to support the EUT and facilitate determination of the direction of maximum radiation for each EUT emission frequency. The EUT is placed at a height of 0.8 m test table above the ground plane.
2. Measurement is made with the antenna positioned in both the horizontal and vertical planes of polarization. The measurement antenna is varied in height (1m ~ 4m) above the reference ground plane to obtain the maximum signal strength. Distance between EUT and antenna is 3 m.
3. This investigation is performed with the EUT rotated 360°, the antenna height scanned between 1 m and 4 m, and the antenna rotated to repeat the measurements for both the horizontal and vertical antenna polarizations.

Note:

1. 120kHz measurement bandwidth of test receiver and Quasi-peak detector is for radiated emission below 1GHz.
2. Radiated emission above 1GHz / Peak value
RBW=1MHz, VBW=3MHz and Peak detector
Radiated emission above 1GHz / Average value for harmonics
The average value is: Average = Peak value + 20log(Duty cycle) Where the duty factor is calculated from following formula for DH5 packet type which has worst duty factor:
3.
$$20\log(\text{Duty cycle}) = 20\log \frac{1\text{s} / 1600 * 5}{100 \text{ ms}} = -30.1\text{dB}$$
4. Radiated emission above 1GHz / Average value for other emissions
RBW=1MHz, VBW=1/T and Peak detector



3.2.3 Test Setup

Radiated Emissions below 1 GHz

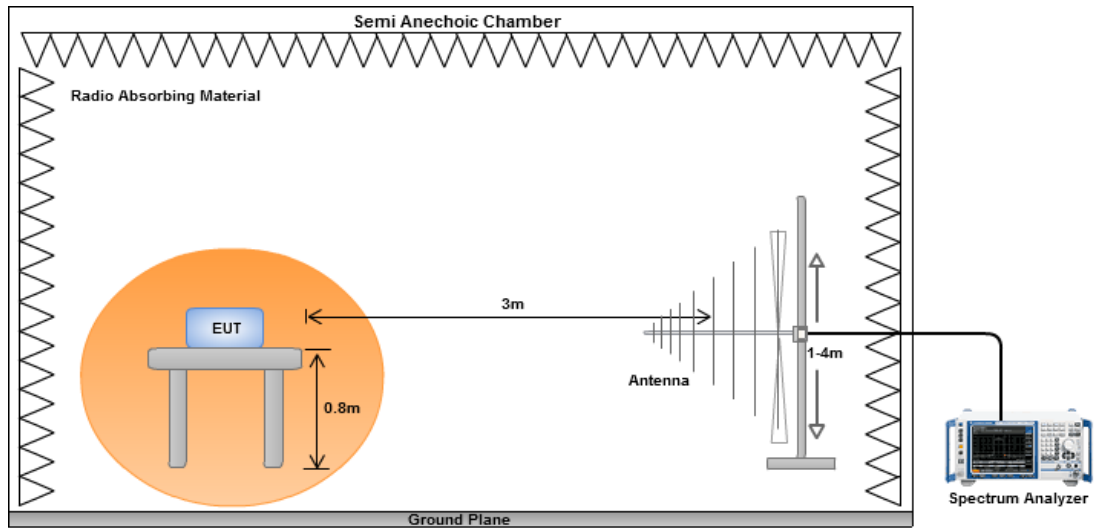

Radiated Emissions above 1 GHz

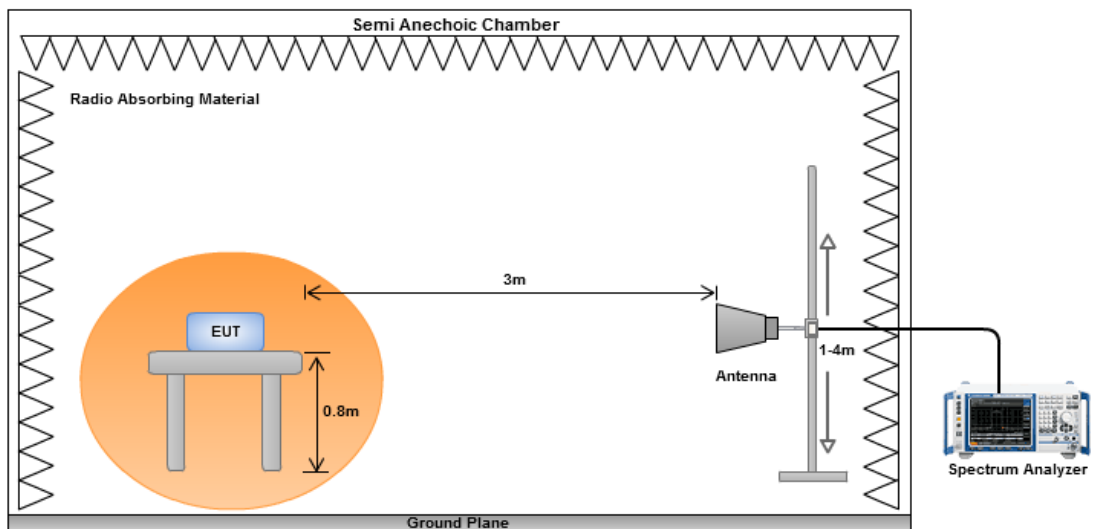



3.2.4 Transmitter Radiated Unwanted Emissions (Below 1GHz)

Polarization	Horizontal		Test Freq. (MHz)	2480					
<p>The graph plots Level (dBuV/m) on the y-axis (0 to 90) against Frequency (MHz) on the x-axis (30 to 1000). A red step function represents the FCC CLASS-B limit. Six blue vertical lines indicate measured emission levels at specific frequencies, labeled 1 through 6. The measured levels are all below the limit line.</p>									
	Freq.	Emission level	Limit	Margin	SA reading	Factor	Remark	ANT High	Turn Table
	MHz	dBuV/m	dBuV/m	dB	dBuV	dB		cm	deg
1	44.55	26.76	40.00	-13.24	43.49	-16.73	Peak	---	---
2	98.87	27.59	43.50	-15.91	49.36	-21.77	Peak	---	---
3	165.80	33.62	43.50	-9.88	50.64	-17.02	Peak	---	---
4	298.69	30.66	46.00	-15.34	46.92	-16.26	Peak	---	---
5	398.60	34.92	46.00	-11.08	48.61	-13.69	Peak	---	---
6	431.58	33.87	46.00	-12.13	46.76	-12.89	Peak	---	---

Note 1: Emission Level (dBuV/m) = SA Reading (dBuV/m) + Factor* (dB)

*Factor includes antenna factor , cable loss and amplifier gain

Note 2: Margin (dB) = Emission level (dBuV/m) – Limit (dBuV/m).



Polarization	Vertical	Test Freq. (MHz)	2480
---------------------	----------	-------------------------	------

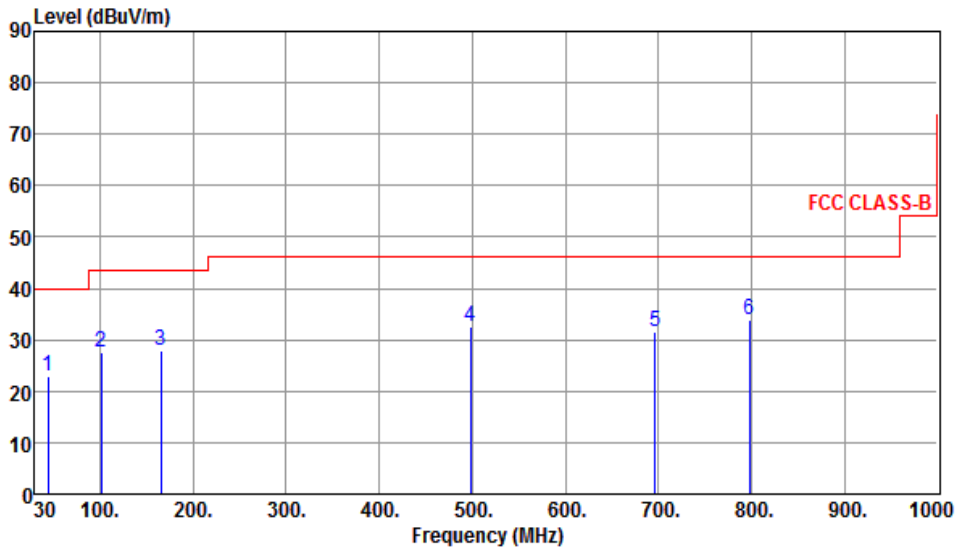

	Freq. MHz	Emission level dBUV/m	Limit dBUV/m	Margin dB	SA reading dBUV	Factor dB	Remark	ANT High cm	Turn Table deg
1	44.55	23.07	40.00	-16.93	39.80	-16.73	Peak	---	---
2	101.78	27.62	43.50	-15.88	48.96	-21.34	Peak	---	---
3	165.80	28.05	43.50	-15.45	45.07	-17.02	Peak	---	---
4	498.51	32.66	46.00	-13.34	44.36	-11.70	Peak	---	---
5	696.39	31.62	46.00	-14.38	39.92	-8.30	Peak	---	---
6	798.24	33.92	46.00	-12.08	40.69	-6.77	Peak	---	---

Note 1: Emission Level (dBUV/m) = SA Reading (dBUV/m) + Factor* (dB)

*Factor includes antenna factor , cable loss and amplifier gain

Note 2: Margin (dB) = Emission level (dBUV/m) – Limit (dBUV/m).



3.2.5 Transmitter Radiated Unwanted Emissions (Above 1GHz)

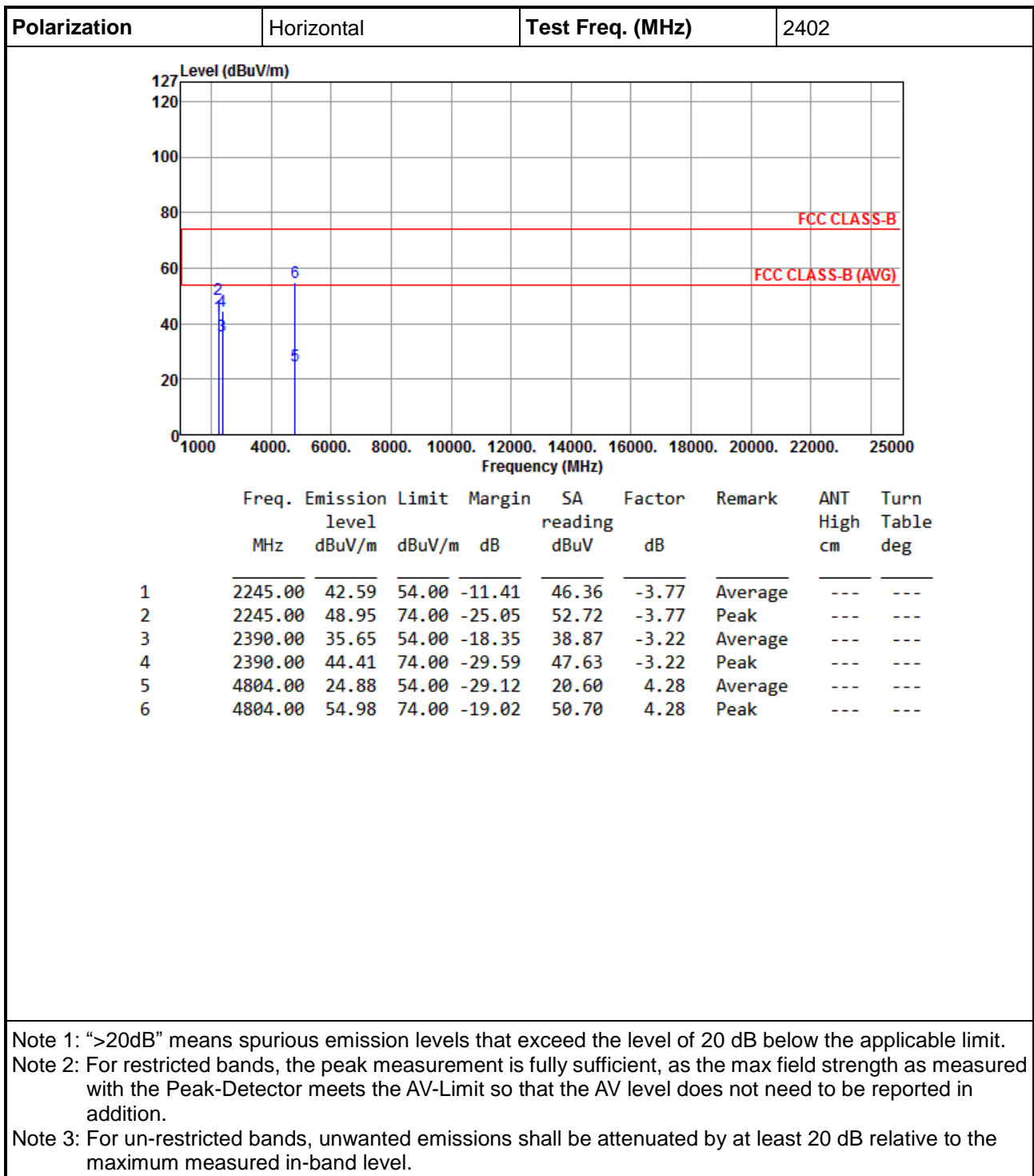



Polarization	Vertical	Test Freq. (MHz)	2402
---------------------	----------	-------------------------	------

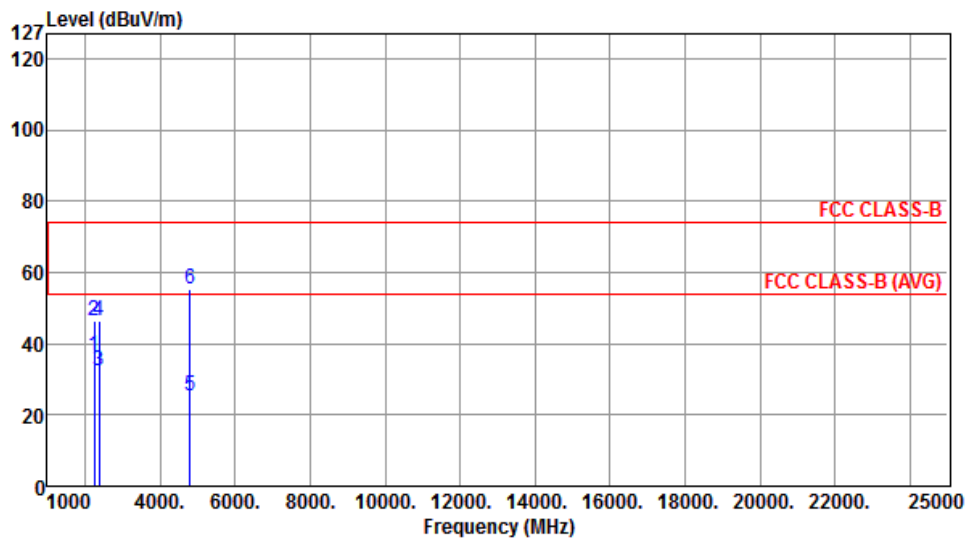

	Freq. MHz	Emission level dBuV/m	Limit dBuV/m	Margin dB	SA reading dBuV	Factor dB	Remark	ANT High cm	Turn Table deg
1	2245.00	36.44	54.00	-17.56	40.21	-3.77	Average	---	---
2	2245.00	46.20	74.00	-27.80	49.97	-3.77	Peak	---	---
3	2390.00	32.20	54.00	-21.80	35.42	-3.22	Average	---	---
4	2390.00	46.62	74.00	-27.38	49.84	-3.22	Peak	---	---
5	4804.00	25.10	54.00	-28.90	20.82	4.28	Average	---	---
6	4804.00	55.20	74.00	-18.80	50.92	4.28	Peak	---	---

Note 1: ">20dB" means spurious emission levels that exceed the level of 20 dB below the applicable limit.
 Note 2: For restricted bands, the peak measurement is fully sufficient, as the max field strength as measured with the Peak-Detector meets the AV-Limit so that the AV level does not need to be reported in addition.
 Note 3: For un-restricted bands, unwanted emissions shall be attenuated by at least 20 dB relative to the maximum measured in-band level.



Polarization	Horizontal		Test Freq. (MHz)	2441					
	Freq.	Emission level	Limit	Margin	SA reading	Factor	Remark	ANT High	Turn Table
	MHz	dBuV/m	dBuV/m	dB	dBuV	dB		cm	deg
1	2285.00	44.18	54.00	-9.82	47.80	-3.62	Average	---	---
2	2285.00	49.97	74.00	-24.03	53.59	-3.62	Peak	---	---
3	2311.00	41.05	54.00	-12.95	44.57	-3.52	Average	---	---
4	2311.00	48.06	74.00	-25.94	51.58	-3.52	Peak	---	---
5	4882.00	26.03	54.00	-27.97	21.63	4.40	Average	---	---
6	4882.00	56.13	74.00	-17.87	51.73	4.40	Peak	---	---
7	7323.00	26.01	54.00	-27.99	17.08	8.93	Average	---	---
8	7323.00	56.11	74.00	-17.89	47.18	8.93	Peak	---	---
<p>Note 1: ">20dB" means spurious emission levels that exceed the level of 20 dB below the applicable limit.</p> <p>Note 2: For restricted bands, the peak measurement is fully sufficient, as the max field strength as measured with the Peak-Detector meets the AV-Limit so that the AV level does not need to be reported in addition.</p> <p>Note 3: For un-restricted bands, unwanted emissions shall be attenuated by at least 20 dB relative to the maximum measured in-band level.</p>									



Polarization	Vertical	Test Freq. (MHz)	2441						
	Freq.	Emission level	Limit	Margin	SA reading	Factor	Remark	ANT High	Turn Table
	MHz	dBuV/m	dBuV/m	dB	dBuV	dB		cm	deg
1	2285.00	39.39	54.00	-14.61	43.01	-3.62	Average	---	---
2	2285.00	47.42	74.00	-26.58	51.04	-3.62	Peak	---	---
3	2311.00	37.30	54.00	-16.70	40.82	-3.52	Average	---	---
4	2311.00	47.07	74.00	-26.93	50.59	-3.52	Peak	---	---
5	4882.00	26.76	54.00	-27.24	22.36	4.40	Average	---	---
6	4882.00	56.86	74.00	-17.14	52.46	4.40	Peak	---	---
7	7323.00	28.44	54.00	-25.56	19.51	8.93	Average	---	---
8	7323.00	58.54	74.00	-15.46	49.61	8.93	Peak	---	---
<p>Note 1: ">20dB" means spurious emission levels that exceed the level of 20 dB below the applicable limit.</p> <p>Note 2: For restricted bands, the peak measurement is fully sufficient, as the max field strength as measured with the Peak-Detector meets the AV-Limit so that the AV level does not need to be reported in addition.</p> <p>Note 3: For un-restricted bands, unwanted emissions shall be attenuated by at least 20 dB relative to the maximum measured in-band level.</p>									



Polarization	Horizontal		Test Freq. (MHz)	2480					
	Freq.	Emission level	Limit	Margin	SA	Factor	Remark	ANT	Turn
	MHz	dBuV/m	dBuV/m	dB	reading	dB		High	Table
								cm	deg
1	2323.00	46.98	54.00	-7.02	50.45	-3.47	Average	---	---
2	2323.00	51.50	74.00	-22.50	54.97	-3.47	Peak	---	---
3	2350.00	43.65	54.00	-10.35	47.02	-3.37	Average	---	---
4	2350.00	49.01	74.00	-24.99	52.38	-3.37	Peak	---	---
5	2483.50	36.83	54.00	-17.17	39.66	-2.83	Average	---	---
6	2483.50	49.20	74.00	-24.80	52.03	-2.83	Peak	---	---
7	4960.00	23.29	54.00	-30.71	18.75	4.54	Average	---	---
8	4960.00	53.39	74.00	-20.61	48.85	4.54	Peak	---	---
9	7440.00	24.31	54.00	-29.69	15.19	9.12	Average	---	---
10	7440.00	54.41	74.00	-19.59	45.29	9.12	Peak	---	---
<p>Note 1: ">20dB" means spurious emission levels that exceed the level of 20 dB below the applicable limit.</p> <p>Note 2: For restricted bands, the peak measurement is fully sufficient, as the max field strength as measured with the Peak-Detector meets the AV-Limit so that the AV level does not need to be reported in addition.</p> <p>Note 3: For un-restricted bands, unwanted emissions shall be attenuated by at least 20 dB relative to the maximum measured in-band level.</p>									



Polarization	Vertical	Test Freq. (MHz)	2480
---------------------	----------	-------------------------	------

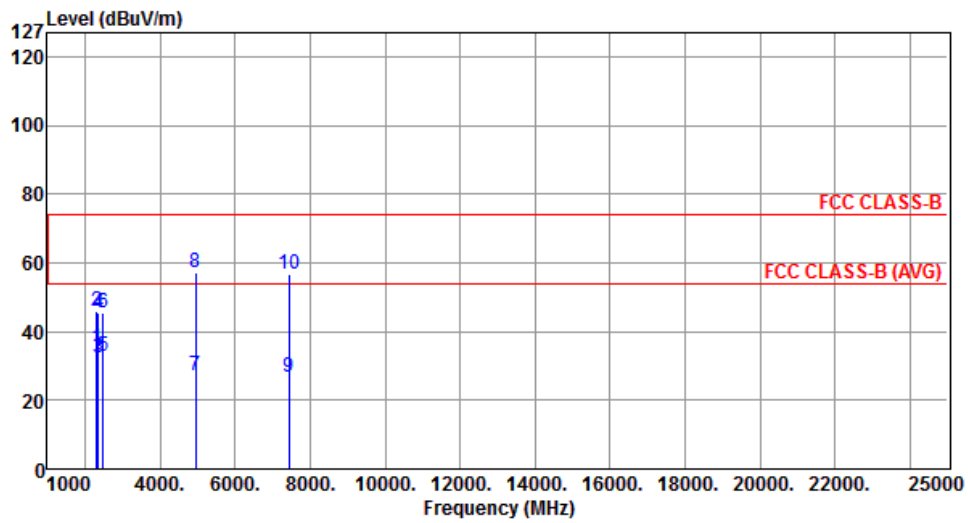

	Freq. MHz	Emission level dBuV/m	Limit dBuV/m	Margin dB	SA reading dBuV	Factor dB	Remark	ANT High cm	Turn Table deg
1	2323.00	35.28	54.00	-18.72	38.75	-3.47	Average	---	---
2	2323.00	45.77	74.00	-28.23	49.24	-3.47	Peak	---	---
3	2350.00	32.19	54.00	-21.81	35.56	-3.37	Average	---	---
4	2350.00	45.34	74.00	-28.66	48.71	-3.37	Peak	---	---
5	2483.50	32.68	54.00	-21.32	35.51	-2.83	Average	---	---
6	2483.50	45.65	74.00	-28.35	48.48	-2.83	Peak	---	---
7	4960.00	27.15	54.00	-26.85	22.61	4.54	Average	---	---
8	4960.00	57.25	74.00	-16.75	52.71	4.54	Peak	---	---
9	7440.00	26.65	54.00	-27.35	17.53	9.12	Average	---	---
10	7440.00	56.75	74.00	-17.25	47.63	9.12	Peak	---	---

Note 1: ">20dB" means spurious emission levels that exceed the level of 20 dB below the applicable limit.
 Note 2: For restricted bands, the peak measurement is fully sufficient, as the max field strength as measured with the Peak-Detector meets the AV-Limit so that the AV level does not need to be reported in addition.
 Note 3: For un-restricted bands, unwanted emissions shall be attenuated by at least 20 dB relative to the maximum measured in-band level.



3.3 Emissions in non-restricted frequency bands

3.3.1 Emissions in non-restricted frequency bands limit

Peak power in any 100 kHz bandwidth outside of the authorized frequency band shall be attenuated by at least 20 dB relative to the maximum in-band peak PSD level in 100 kHz

3.3.2 Measuring Instruments

Refer a test equipment and calibration data table in this test report.

3.3.3 Test Procedures

Reference level measurement

1. Set RBW=100kHz, VBW = 300kHz , Detector = Peak, Sweep time = Auto
2. Trace = max hold , Allow Trace to fully stabilize
3. Use the peak marker function to determine the maximum PSD level

Emission level measurement

1. Set RBW=100kHz, VBW = 300kHz , Detector = Peak, Sweep time = Auto
2. Trace = max hold , Allow Trace to fully stabilize
3. Scan Frequency range is up to 25GHz
4. Use the peak marker function to determine the maximum amplitude level

3.3.4 Test Setup

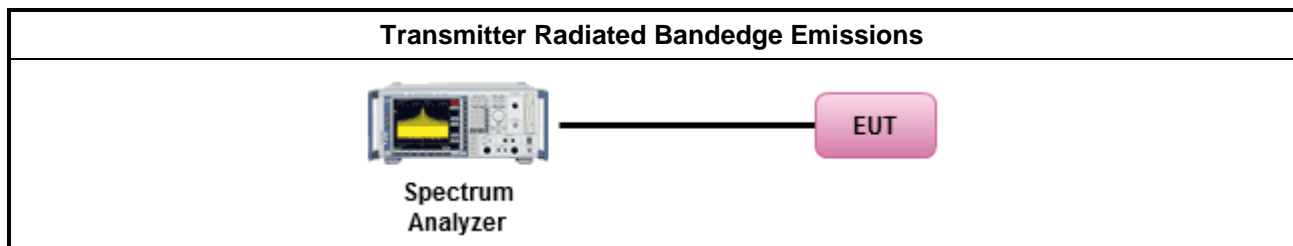



3.3.5 Test Result of Emissions in non-restricted frequency bands

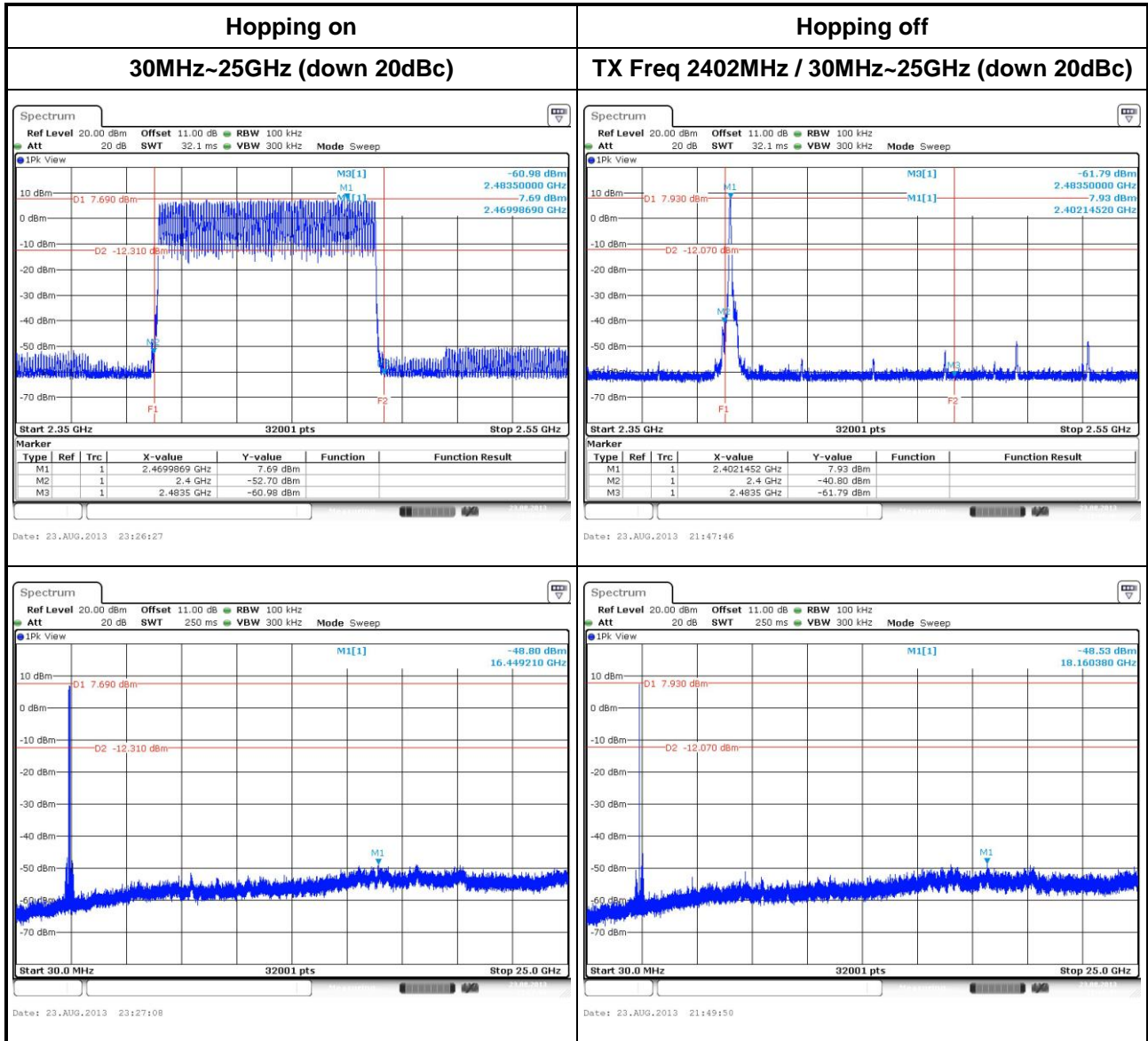

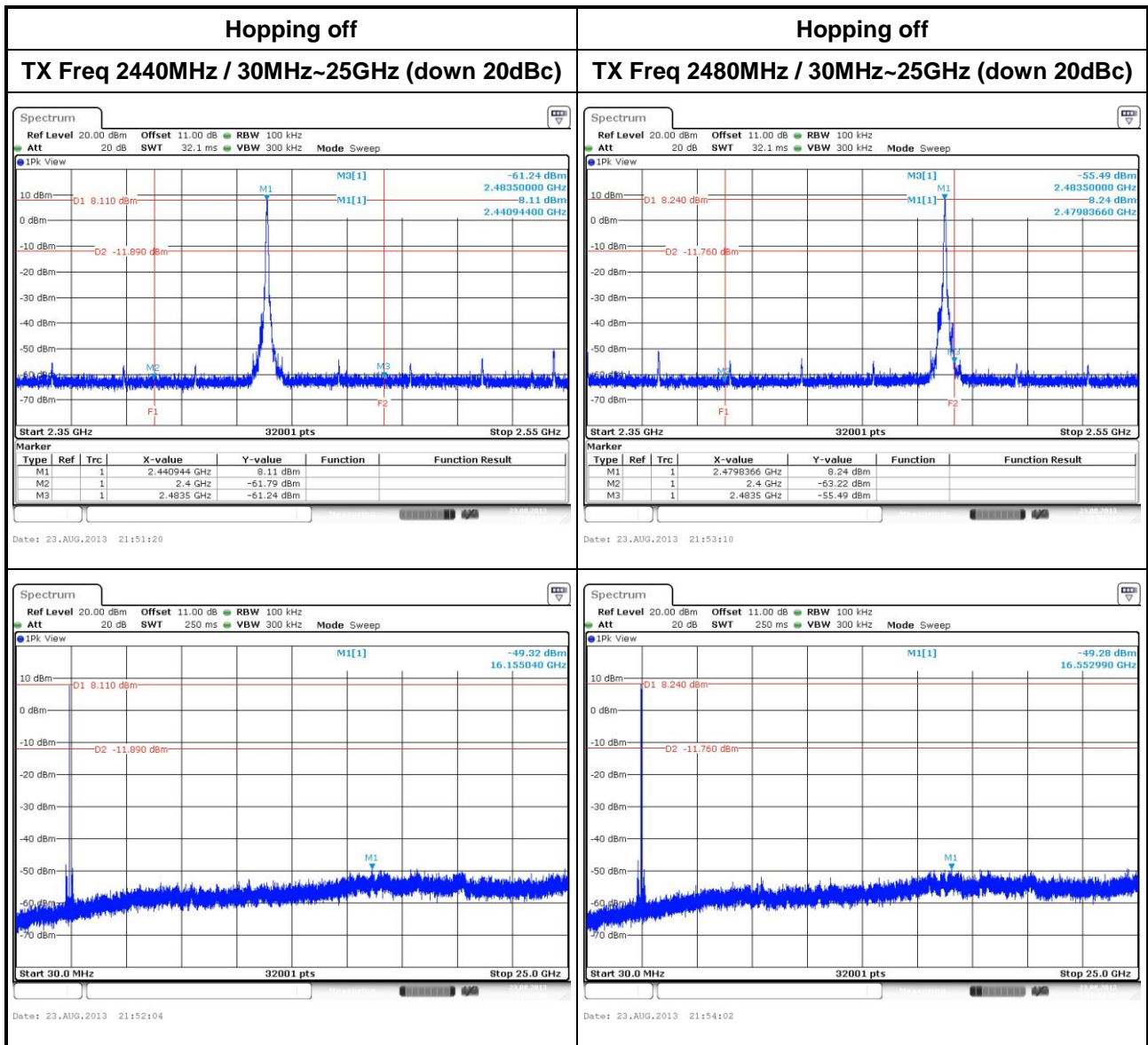



3.4 Conducted Output Power

3.4.1 Limit of Unwanted Emissions into Non-Restricted Frequency Bands

- 1 Watt
For frequency hopping systems operating in the 2400–2483.5 MHz band employing at least 75 non overlapping hopping channels, and all frequency hopping systems in the 5725–5850 MHz band.
- 0.125 Watt
For all other frequency hopping systems in the 2400–2483.5 MHz band.
- 0.125 Watt
For Frequency hopping systems operating in the 2400–2483.5 MHz band have hopping channel carrier frequencies that are separated by two-thirds of the 20 dB bandwidth of the hopping channel.

3.4.2 Test Procedures

1. A wideband power meter is used for power measurement. Bandwidth of power sensor and meter is 50MHz
2. If duty cycle of test signal is not 100 %, trigger and gating function of power meter will be enabled to capture transmission burst for measuring output power

3.4.3 Test Setup

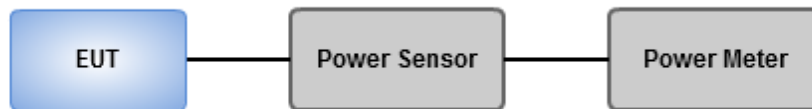



3.4.4 Test Result of Conducted Output Power

Modulation Mode	Freq. (MHz)	Output Power (mW)	Output Power (dBm)	Limit (mW)
GFSK	2402	6.44	8.09	20.96
GFSK	2441	7.66	8.84	20.96
GFSK	2480	8.24	9.16	20.96

Modulation Mode	Freq. (MHz)	AV Output Power (mW)	AV Output Power (dBm)
GFSK	2402	6.14	7.88
GFSK	2441	7.38	8.68
GFSK	2480	8.00	9.03

Note: Average power is for reference only



3.5 Number of Hopping Frequency

3.5.1 Limit of Number of Hopping Frequency

Frequency hopping systems in the 2400–2483.5 MHz band shall use at least 15 channels.

3.5.2 Test Procedures

1. Set RBW = 100kHz, VBW = 300kHz, Sweep time = Auto, Detector = Peak Trace max hold.
2. Allow trace to stabilize.

3.5.3 Test Setup

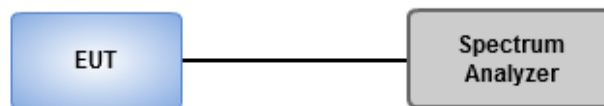



3.5.4 Test Result of Number of Hopping Frequency

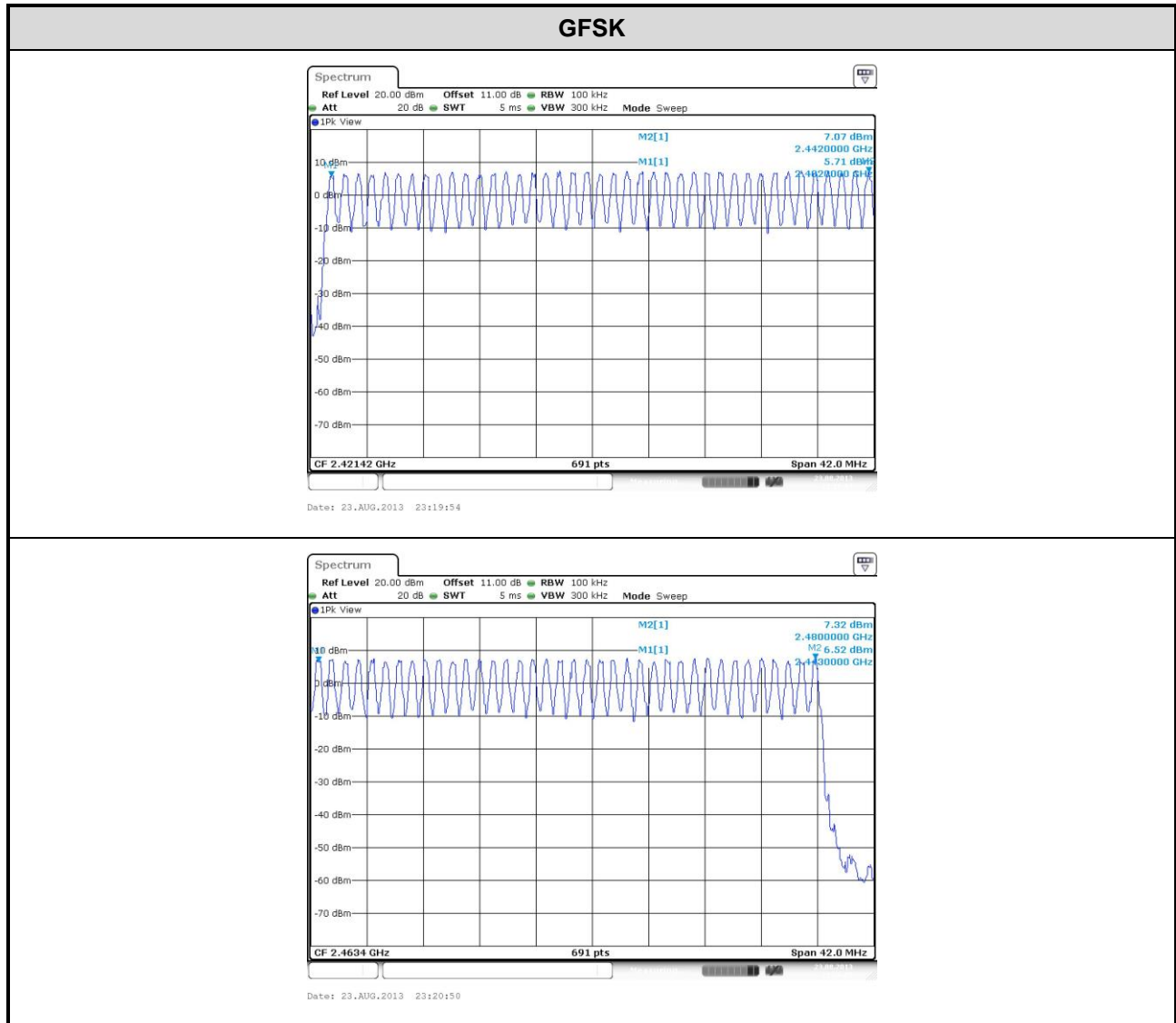



3.6 20dB and Occupied Bandwidth

3.6.1 Test Procedures

1. Set RBW=30kHz, VBW=100kHz, Sweep time = Auto, Detector=Peak Trace max hold
2. Allow trace to stabilize
3. Use N dB function of spectrum analyzer to measuring 20 dB bandwidth
4. Use Occupied bandwidth function of spectrum analyzer to measuring 99% occupied bandwidth

3.6.2 Test Setup

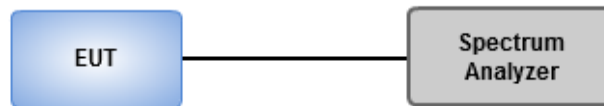



3.6.3 Test result of 20dB and Occupied Bandwidth

Modulation Mode	Freq. (MHz)	20dB Bandwidth (MHz)	Occupied Bandwidth (MHz)
GFSK	2402	0.957	0.873
GFSK	2441	0.952	0.868
GFSK	2480	0.948	0.868

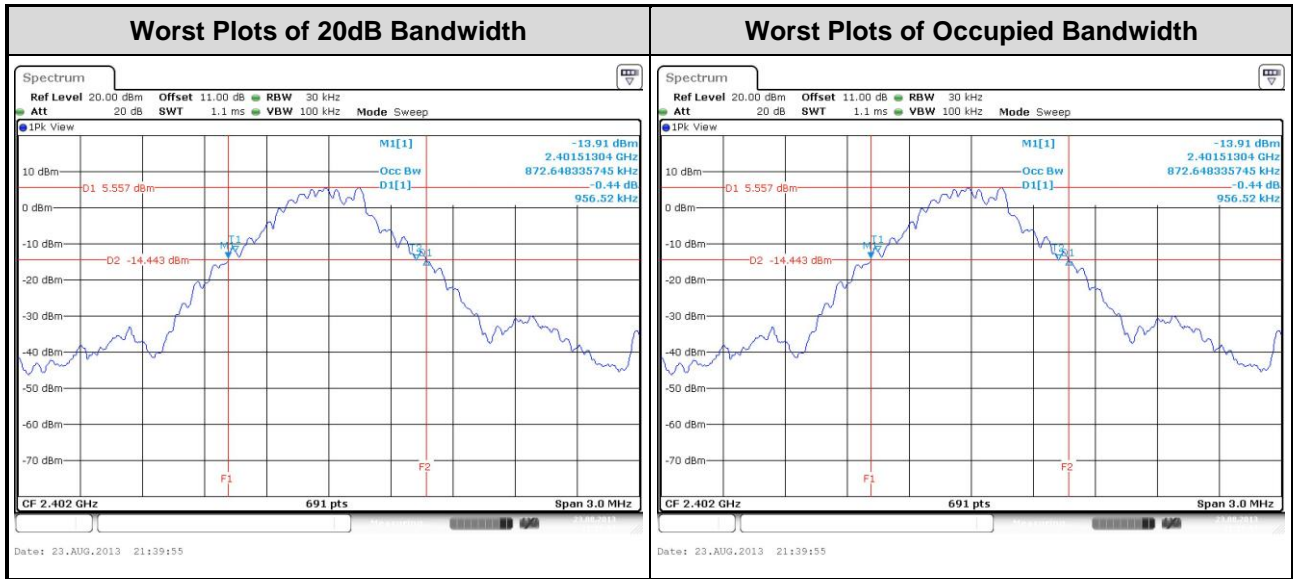



3.7 Channel Separation

3.7.1 Limit of Channel Separation

- Frequency hopping systems shall have hopping channel carrier frequencies separated by a minimum of 25 kHz or the 20 dB bandwidth of the hopping channel, whichever is greater.
- Frequency hopping systems operating in the 2400–2483.5 MHz band may have hopping channel carrier frequencies that are separated by 25 kHz or two-thirds of the 20 dB bandwidth of the hopping channel, whichever is greater.

3.7.2 Test Procedures

1. Set RBW=100kHz, VBW=300kHz, Sweep time = Auto, Detector=Peak Trace max hold
2. Allow trace to stabilize
3. Use the marker-delta function to determine the separation between the peaks of the adjacent channels. The EUT shall show compliance with the appropriate regulatory limit

3.7.3 Test Setup

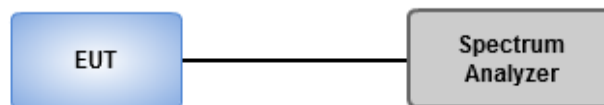



3.7.4 Test result of Channel Separation

Modulation Mode	Freq. (MHz)	Channel Separation (MHz)	20dB Bandwidth (MHz)	Minimum Limit (MHz)
GFSK	2402	1.003	0.957	0.638
GFSK	2441	1.003	0.952	0.635
GFSK	2480	1.003	0.948	0.632

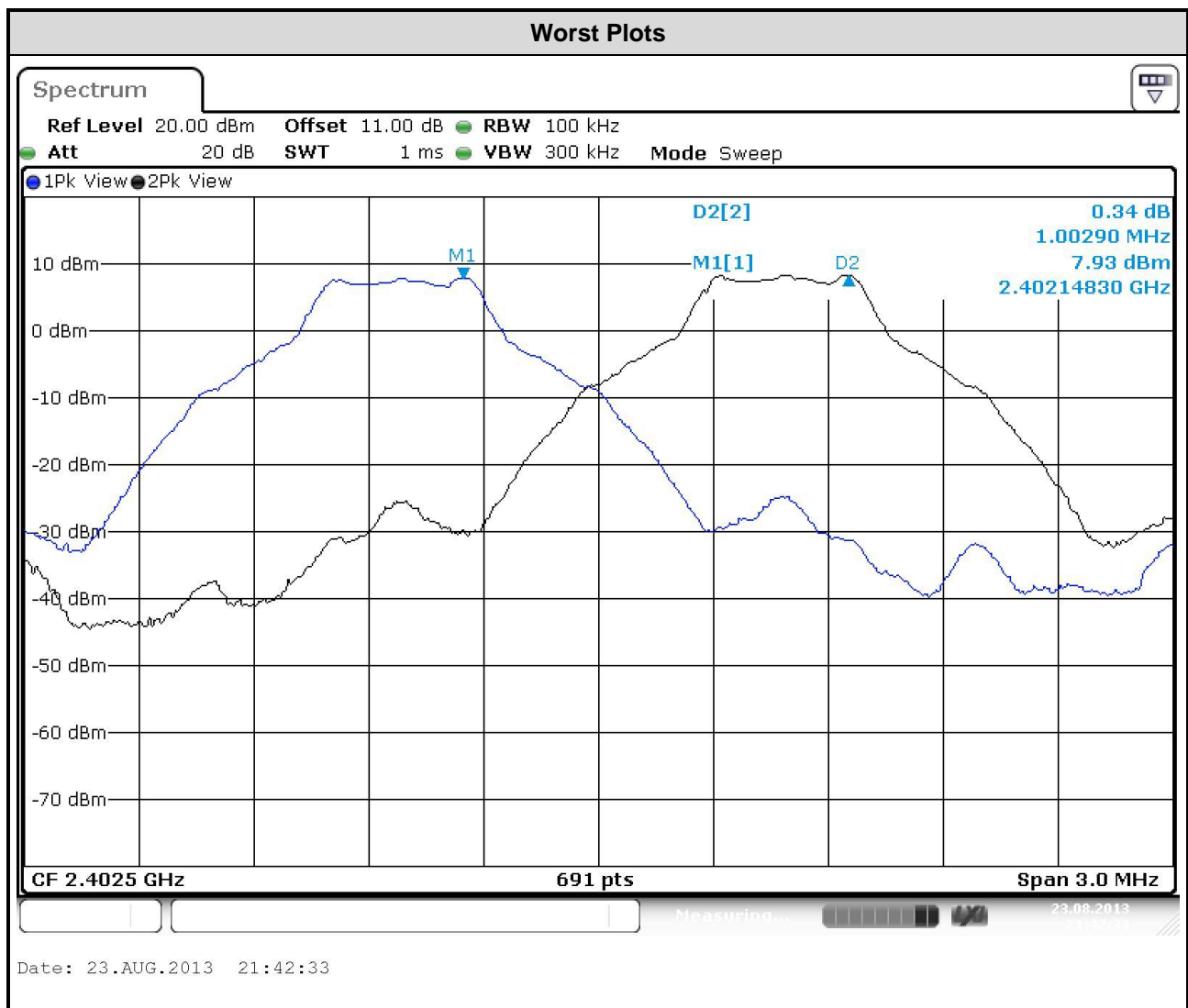



3.8 Number of Dwell Time

3.8.1 Limit of Dwell time

The average time of occupancy on any channel shall not be greater than 0.4 seconds within a period of 0.4 seconds multiplied by the number of hopping channels employed.

3.8.2 Test Procedures

1. Set RBW=100kHz,VBW=300kHz,Sweep time = 500us(DH1),2ms(DH3),4ms(DH5), Detector=Peak, Span=0Hz,Trace max hold
2. Enable gating and trigger function of spectrum analyzer to measure burst on time.
3. The DH1 packet can cover a single time slot. A maximum length packet has duration of 1 time slots. The hopping rate is 1600 hops/second so the maximum dwell time is 1/1600 seconds, or 0.625ms. DH1 Packet permit maximum $1600 / 79 / 2 = 10.12$ hops per second in each channel (1 time slot RX, 1 time slot TX). So, the dwell time is the time duration of the pulse times $10.12 \times 31.6 = 320$ within 31.6 seconds.
4. The DH3 packet can cover up to 3 time slots. A maximum length packet has duration of 3 time slots. The hopping rate is 1600 hops/second so the maximum dwell time is 3/1600 seconds, or 1.875ms. DH3 Packet permit maximum $1600 / 79 / 4 = 5.06$ hops per second in each channel (3 time slots RX, 1 time slot TX). So, the dwell time is the time duration of the pulse times $5.06 \times 31.6 = 160$ within 31.6 seconds.
5. The DH5 packet can cover up to 5 time slots. Operate DH5 at maximum dwell time and maximum duty cycle. A maximum length packet has duration of 5 time slots. The hopping rate is 1600 hops/second so the maximum dwell time is 5/1600 seconds, or 3.125ms. DH5 Packet permit maximum $1600 / 79 / 6 = 3.37$ hops per second in each channel (5 time slots RX, 1 time slot TX). So, the dwell time is the time duration of the pulse times $3.37 \times 31.6 = 106.6$ within 31.6 seconds

3.8.3 Test Setup

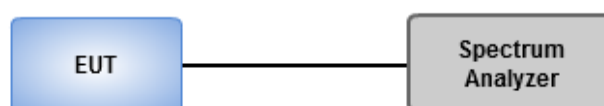



3.8.4 Test Result of Dwell Time

Time of Occupancy (Dwell Time) Result					
Modulation Mode	Freq. (MHz)	Pulse Time per Hop (ms)	Number of Pulse in [0.4 x N sec]	Dwell Time in [0.4 x N sec] (s)	Dwell Time Limits (s)
GFSK-DH1	2402	0.43623	320	0.140	0.4
GFSK-DH3	2402	1.70580	160	0.273	0.4
GFSK-DH5	2402	2.95217	106.6	0.315	0.4

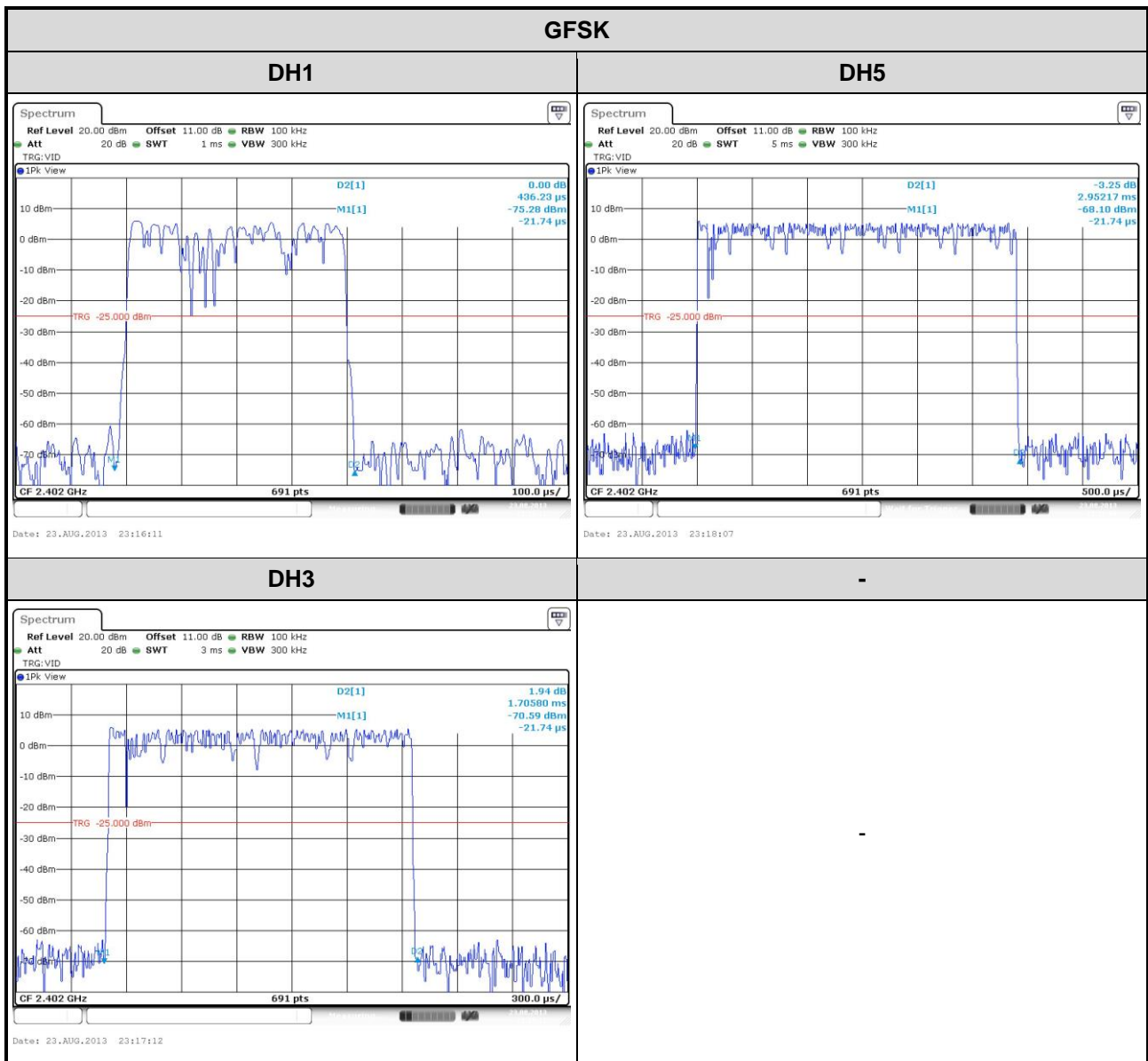

==END==