



IDS-XXXXXX

CMF SPECIFICATION  
WIN019

REVISION: 04      2020-09-11

REVISION NOTES:  
02: remove Anti-coating/ adjust RC icon  
03: change "charging" to "charger"  
04: add EPA number

SCALE: 1:1      DESIGNER: [RC]

COLOR STANDARDS USED:

WHITE SKU

ABS+PC  
COLOR: SNOWCAP WHITE  
TEXTURE: VDI 21

LED LIGHTPIPE  
MATERIAL: PC  
COLOR: WATER CLEAR  
TEXTURE: VDI 21 ON VISIBLE SURFACE, HIGH POLISH ON ALL OTHER PARTS

DIECUT SILICONE SHEET TEXTURED VDI 21,  
COLOR: SNOWCAP WHITE

LOGO: SILK SCREEN  
PRINT COLOR: PANTONE 428C

TYPE C PLASTIC MODULE: WHITE

DO NOT MAKE CHANGES WITHOUT PERMISSION FROM BELKIN IDG.

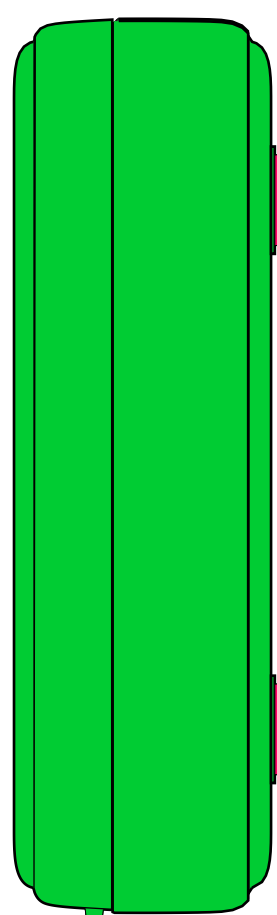
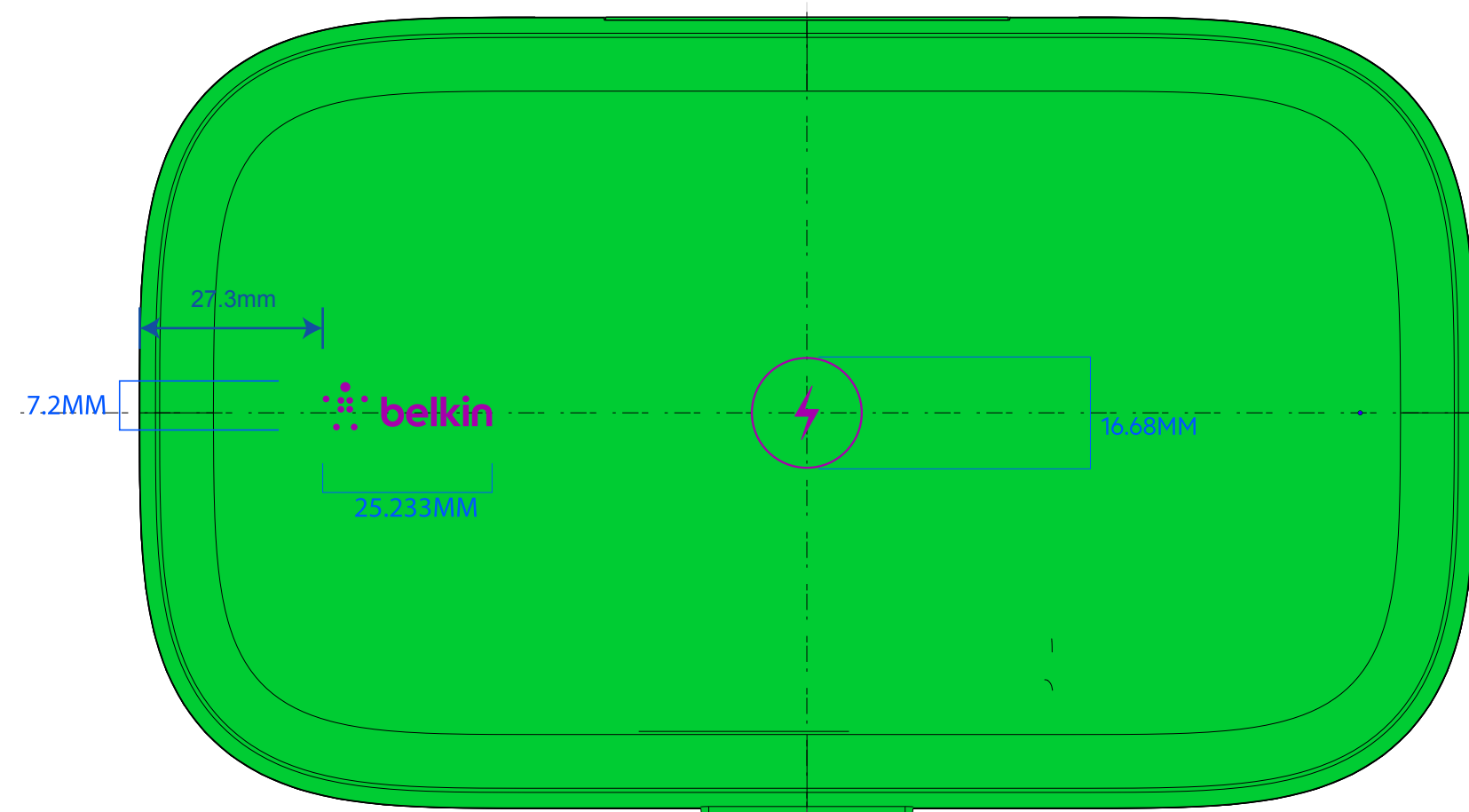
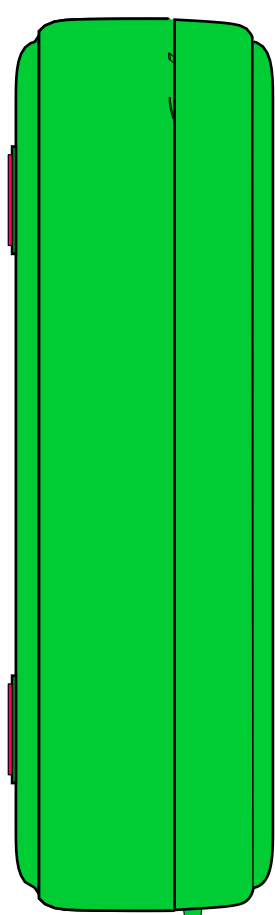
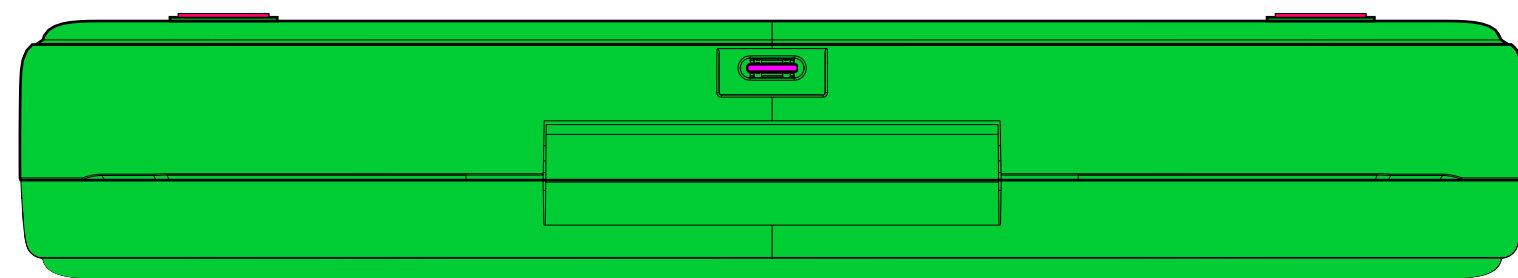

25.2x7.2mm



16.68x16.68mm

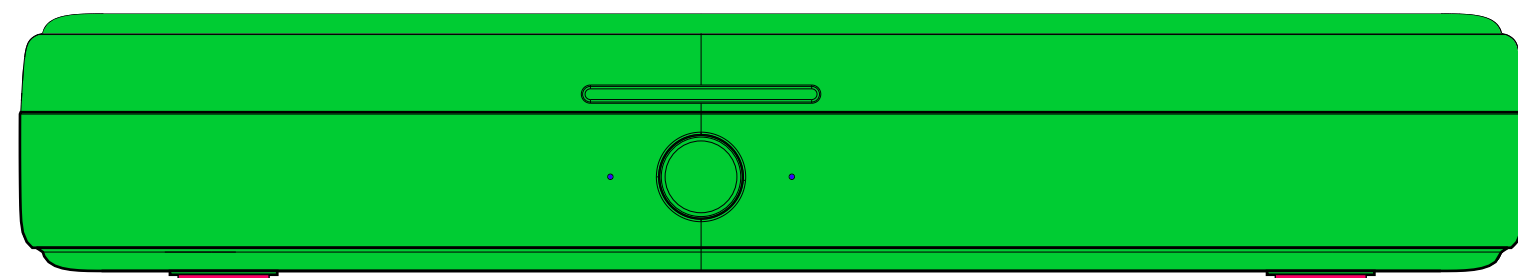

# 白色外壳 428C印字

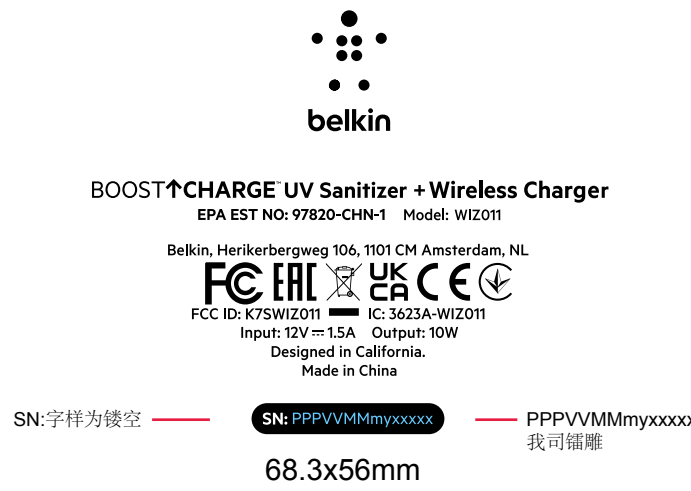
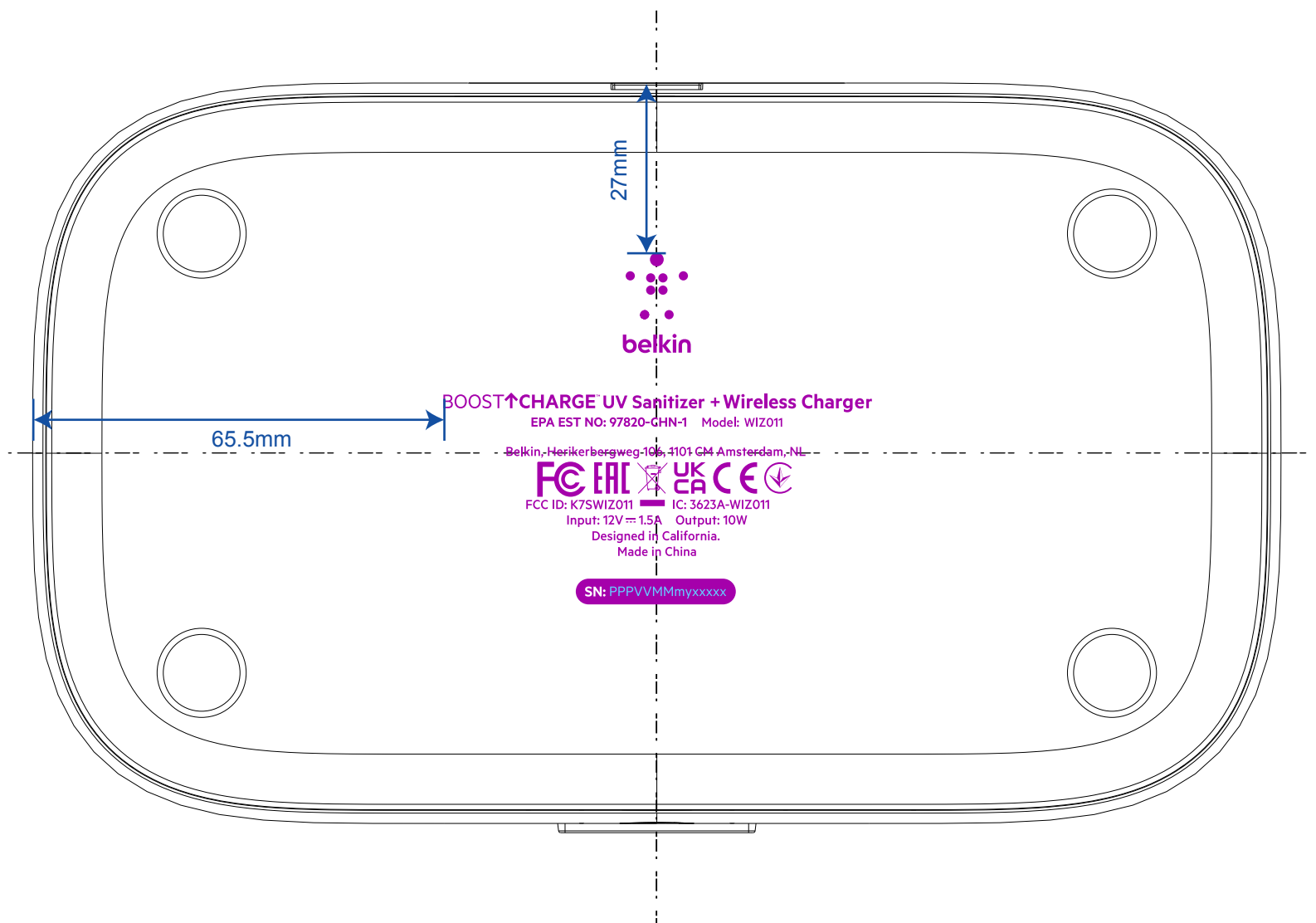

PPP: Product Code/产品代码, 此产品代码 35H (固定)  
VV: Product Version Code/产品版本号 10 (目前固定, 后续若有变更再变动)  
MM: Manufacturer Code/工厂代码 (如: CL-海能深圳工厂\_DJ-深圳安福工厂, ER-遂宁工厂\_EV-越南工厂) 随订单变化  
m: Month (1-9, A-C for Jan-Sep, Oct-Dec, 1 digit)/生产月份, 只有一位数, 1-9月份用1-9的数字表示, 10月份开始用字母表示, A:10月, B:11月, C:12月  
y: Year (2010 to 2019 = 0 - 9, 2020 and beyond = A - Z, excluding the usage of "I", "O" and "Q")  
/生产年份: 2010-2019用0-9表示, 2020年开始从字母A-Z开始编, I, O and Q这三个字母不能用  
xxxx: Monthly Unit Count (00001 to 99999, then A0000 to Z9999, excluding the usage of "I", "O" and "Q") 流水号从00001到99999, 超过99999就用A0000到Z9999表示, I, O and Q这三个字母不能用

ABS+PC  
COLOR: SNOWCAP WHITE  
TEXTURE: Polished

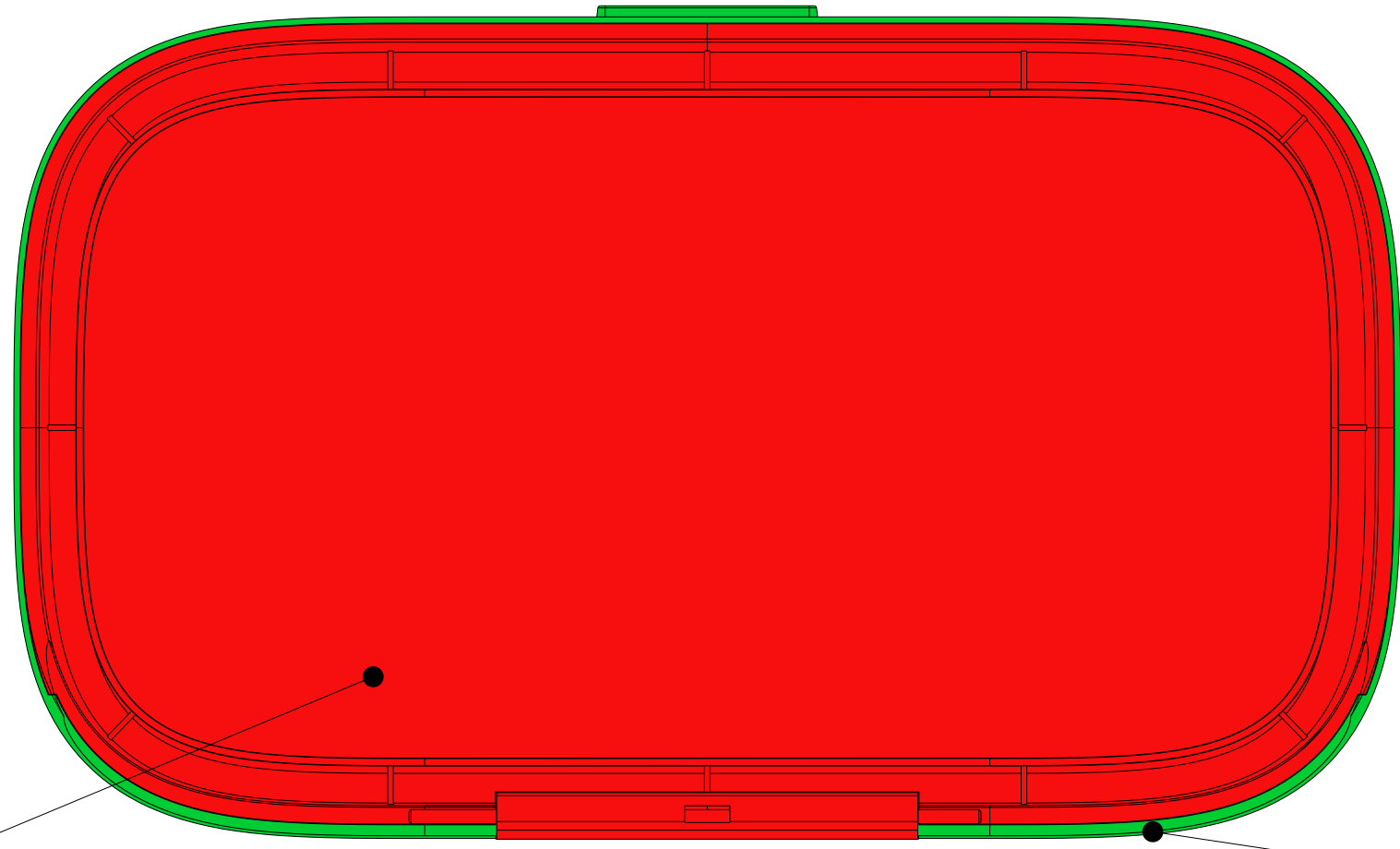

ABS+PC  
COLOR: SNOWCAP WHITE  
TEXTURE: VDI 21

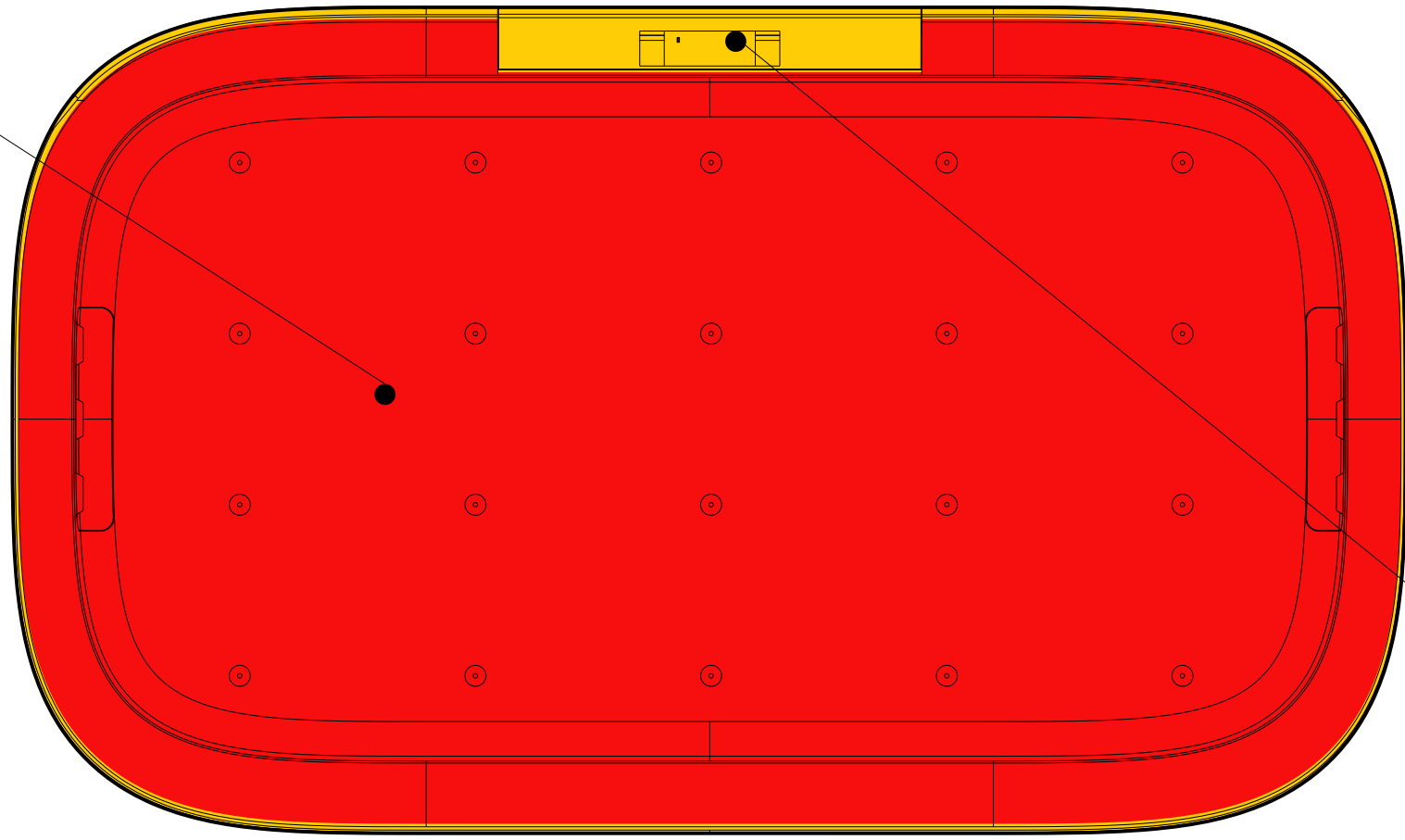
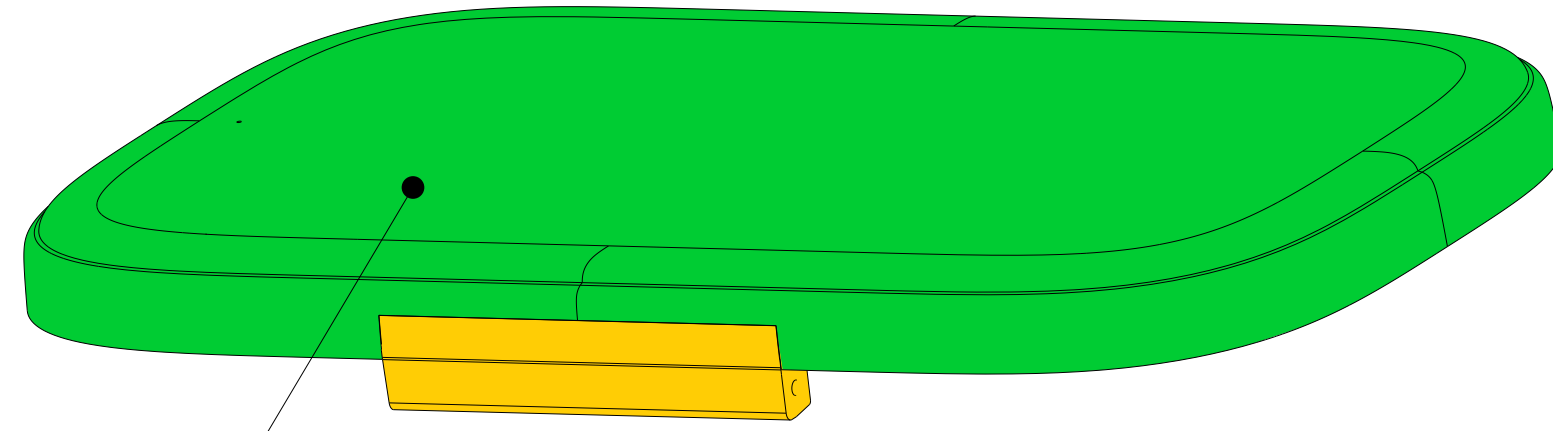

ABS+PC  
COLOR: SNOWCAP WHITE  
TEXTURE: VDI 21

