



# SPORTON International Inc.

No. 52, Hwa Ya 1st Rd., Kwei-Shan Hsiang, TaoYuan Hsien, Taiwan, R.O.C.  
Ph: 886-3-327-3456 / FAX: 886-3-327-0973 / www.sporton.com.tw

## FCC RADIO TEST REPORT

Applicant's company	Belkin International, Inc.
Applicant Address	12045 East Waterfront Drive, Playa Vista, CA 90094
FCC ID	K7SF9L1106V1

Product Name	AC Wi-Fi Dual-Band USB Adapter
Brand Name	Belkin
Model Name	F9L1106v1
Test Rule Part(s)	47 CFR FCC Part 15 Subpart E § 15.407
Test Freq. Range	5150 ~ 5250MHz
Received Date	Jun. 16, 2012
Final Test Date	Sep. 05, 2012
Submission Type	Original Equipment



### Statement

Test result included is for the IEEE 802.11n, IEEE 802.11a and IEEE 802.11ac (5150 ~ 5250MHz) of the product.

The test result in this report refers exclusively to the presented test model / sample.

Without written approval of SPORTON International Inc., the test report shall not be reproduced except in full.

The measurements and test results shown in this test report were made in accordance with the procedures and found in compliance with the limit given in **ANSI C63.10-2009** and **47 CFR FCC Part 15 Subpart E**.

The test equipment used to perform the test is calibrated and traceable to NML/ROC.



## Table of Contents

<b>1. CERTIFICATE OF COMPLIANCE</b> .....	<b>1</b>
<b>2. SUMMARY OF THE TEST RESULT</b> .....	<b>2</b>
<b>3. GENERAL INFORMATION</b> .....	<b>3</b>
3.1. Product Details .....	3
3.2. Accessories .....	6
3.3. Table for Filed Antenna .....	6
3.4. Table for Carrier Frequencies .....	7
3.5. Table for Test Modes .....	7
3.6. Table for Testing Locations.....	8
3.7. Table for Supporting Units .....	8
3.8. Table for Parameters of Test Software Setting .....	9
3.9. Test Configurations.....	10
<b>4. TEST RESULT</b> .....	<b>13</b>
4.1. AC Power Line Conducted Emissions Measurement .....	13
4.2. 99% Occupied Bandwidth Measurement.....	17
4.3. Maximum Conducted Output Power Measurement.....	25
4.4. Power Spectral Density Measurement.....	36
4.5. Peak Excursion Measurement .....	41
4.6. Radiated Emissions Measurement.....	46
4.7. Band Edge Emissions Measurement.....	61
4.8. Frequency Stability Measurement.....	69
4.9. Antenna Requirements .....	71
<b>5. LIST OF MEASURING EQUIPMENTS</b> .....	<b>72</b>
<b>6. TEST LOCATION</b> .....	<b>74</b>
<b>7. TAF CERTIFICATE OF ACCREDITATION</b> .....	<b>75</b>
<b>APPENDIX A. PHOTOGRAPHS OF EUT</b> .....	<b>A1 ~ A9</b>
<b>APPENDIX B. TEST PHOTOS</b> .....	<b>B1 ~ B5</b>



## History of This Test Report

REPORT NO.	VERSION	DESCRIPTION	ISSUED DATE
FR280102AA	Rev. 01	Initial issue of report	Sep. 10, 2012



## 1. CERTIFICATE OF COMPLIANCE

**Product Name** : AC Wi-Fi Dual-Band USB Adapter  
**Brand Name** : Belkin  
**Model Name** : F9L1106v1  
**Applicant** : Belkin International, Inc.  
**Test Rule Part(s)** : 47 CFR FCC Part 15 Subpart E § 15.407

Sporton International as requested by the applicant to evaluate the EMC performance of the product sample received on Jun. 16, 2012 would like to declare that the tested sample has been evaluated and found to be in compliance with the tested rule parts. The data recorded as well as the test configuration specified is true and accurate for showing the sample's EMC nature.

A handwritten signature in blue ink that reads 'Jordan Hsiao'. The signature is written in a cursive style and is positioned above a horizontal line.

**Jordan Hsiao**

**SPORTON INTERNATIONAL INC.**

## 2. SUMMARY OF THE TEST RESULT

Applied Standard: 47 CFR FCC Part 15 Subpart E				
Part	Rule Section	Description of Test	Result	Under Limit
4.1	15.207	AC Power Line Conducted Emissions	Complies	15.20 dB
4.2	15.407(a)	26dB Spectrum Bandwidth	Complies	-
4.3	15.407(a)	Maximum Conducted Output Power	Complies	1.04 dB
4.4	15.407(a)	Power Spectral Density	Complies	1.03 dB
4.5	15.407(a)	Peak Excursion	Complies	3.04 dB
4.6	15.407(b)	Radiated Emissions	Complies	3.69 dB
4.7	15.407(b)	Band Edge Emissions	Complies	1.00 dB
4.8	15.407(g)	Frequency Stability	Complies	-
4.9	15.203	Antenna Requirements	Complies	-

Test Items	Uncertainty	Remark
AC Power Line Conducted Emissions	±2.3dB	Confidence levels of 95%
Maximum Conducted Output Power	±0.5dB	Confidence levels of 95%
Power Spectral Density	±0.5dB	Confidence levels of 95%
Peak Excursion	±0.5dB	Confidence levels of 95%
26dB Spectrum Bandwidth / Frequency Stability	±8.5×10 <sup>-8</sup>	Confidence levels of 95%
Radiated Emissions (9kHz~30MHz)	±0.8dB	Confidence levels of 95%
Radiated Emissions (30MHz~1000MHz)	±1.9dB	Confidence levels of 95%
Radiated / Band Edge Emissions (1GHz~18GHz)	±1.9dB	Confidence levels of 95%
Radiated Emissions (18GHz~40GHz)	±1.9dB	Confidence levels of 95%
Temperature	±0.7°C	Confidence levels of 95%
Humidity	±3.2%	Confidence levels of 95%
DC / AC Power Source	±1.4%	Confidence levels of 95%

### 3. GENERAL INFORMATION

#### 3.1. Product Details

##### IEEE 802.11n/ac

Items	Description
Product Type	WLAN (2TX, 2RX)
Radio Type	Intentional Transceiver
Power Type	From Host System
Modulation	see the below table for IEEE 802.11n see the below table for IEEE 802.11ac
Data Modulation	OFDM (BPSK / QPSK / 16QAM / 64QAM)
Data Rate (Mbps)	see the below table for IEEE 802.11n see the below table for IEEE 802.11ac
Frequency Range	5150 ~ 5250MHz
Channel Number	4 for 20MHz bandwidth ; 2 for 40MHz bandwidth 1 for 80MHz bandwidth
Channel Band Width (99%)	11n MCS0 (HT 20MHz): 17.44 MHz ; 11n MCS0 (HT40 MHz): 37.12 MHz; 11ac MCS0 (VHT 80MHz): 76.80 MHz
Conducted Output Power	11n MCS0 (HT20 MHz): 15.89 dBm ; 11n MCS0 (HT40 MHz): 15.79dBm; 11ac MCS0 (VHT 20MHz): 15.74 dBm; 11ac MCS0 (VHT 40MHz): 15.96 dBm; 11ac MCS0 (VHT 80MHz): 15.93 dBm
Carrier Frequencies	Please refer to section 3.4
Antenna	Please refer to section 3.3

**IEEE 802.11a**

Items	Description
Product Type	WLAN (2TX, 2RX)
Radio Type	Intentional Transceiver
Power Type	From Host System
Modulation	OFDM for IEEE 802.11a
Data Modulation	OFDM (BPSK / QPSK / 16QAM / 64QAM)
Data Rate (Mbps)	OFDM (6/9/12/18/24/36/48/54)
Frequency Range	5150 ~ 5250MHz
Channel Number	4
Channel Band Width (99%)	11a: 16.32 MHz
Conducted Output Power	11a: 15.35 dBm
Carrier Frequencies	Please refer to section 3.4
Antenna	Please refer to section 3.3

**Antenna & Band width**

Antenna	Single (TX)			Two (TX)		
	20 MHz	40 MHz	80 MHz	20 MHz	40 MHz	80 MHz
Band width Mode						
IEEE 802.11a	X	X	X	V	X	X
IEEE 802.11n	X	X	X	V	V	X
IEEE 802.11ac	X	X	X	V	V	V

## IEEE 802. 11a, 11n and 11ac Spec.

<b>Worst Modulation Used for Conformance Testing</b>				
<b>Power Level</b>		1		
<b>IEEE 802.11 Protocol</b>	<b>Number of Transmit Chains (N<sub>TX</sub>)</b>	<b>Data Rate / MCS</b>	<b>Worst Data Rate / MCS</b>	<b>Worst Modulation Mode</b>
a	2	6-54 Mbps	6Mbps	11A5.2G-20M
n (HT20)	2	MCS 0-15	MCS 0	11N5.2G-20M
n (HT40)	2	MCS 0-15	MCS 0	11N5.2G-40M
ac (VHT80)	2	MCS 0-9	MCS 0-Nss1	11AC5.2G-80M

Note 1: IEEE Std. 802.11-2007 modulation consists of IEEE Std. 802.11a-1999.

Note 2: IEEE Std. 802.11n-2009 modulation consists of HT20 and HT40 (HT: High Throughput). Then EUT support HT20 and HT40. Worst modulation mode of Guard Interval (GI) is 400ns.

Note 3: draft IEEE Std. 802.11ac-2012 modulation consists of VHT20, VHT40, VHT80 and VHT160. Then EUT support VHT80. (VHT: Very High Throughput).

Note 4: Modulation modes consist of 11A5.2G-20M, 11N5.2G-20M, 11N5.2G-40M, 11AC5.2G-80M

11A: IEEE 802.11a, 11N: IEEE 802.11n, 11AC: IEEE 802.11ac. 5.2G: 5.15-5.25 GHz band, 5.3G: 20M/40M/80M: Channel Bandwidth 20MHz/40MHz/80MHz



### 3.2. Accessories

N/A

### 3.3. Table for Filed Antenna

Ant.	Brand	Model Name	Antenna Type	Connector	Gain (dBi)		Remark
					2.4G	5G	
0	-	-	Printed Antenna	N/A	2.15	3.81	TX/RX
1	-	-	Printed Antenna	N/A	3.54	3.29	TX/RX

Note:

**For IEEE 802.11a/n/ac mode (2TX/2RX):**

Ant. 0 and Ant. 1 will transmit/receive the signal simultaneously.

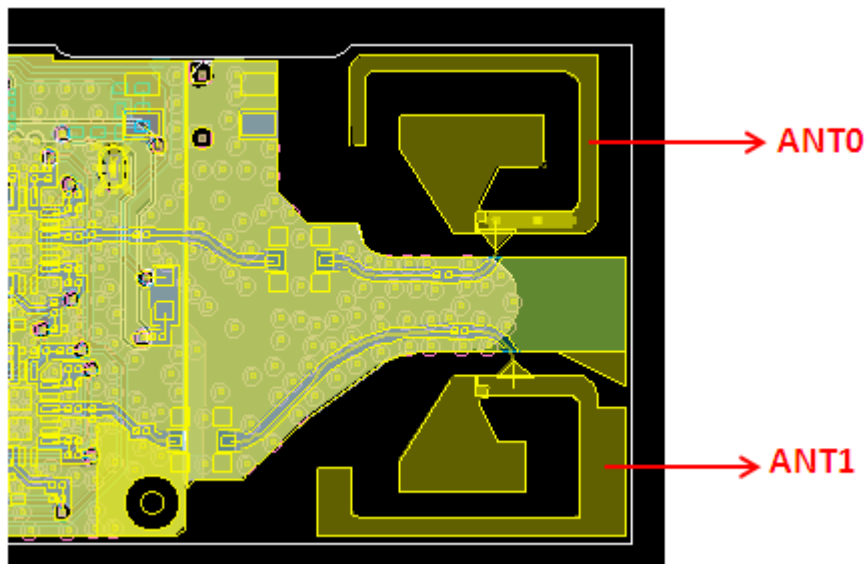

### 3.4. Table for Carrier Frequencies

There are three bandwidth systems for the device.

For 20MHz bandwidth systems, use Channel 36, 40, 44, 48.

For 40MHz bandwidth systems, use Channel 38, 46.

For 80MHz bandwidth systems, use Channel 42.

Frequency Band	Channel No.	Frequency	Channel No.	Frequency
5150~5250 MHz Band 1	36	5180 MHz	44	5220 MHz
	38	5190 MHz	46	5230 MHz
	40	5200 MHz	48	5240 MHz
	42	5210 MHz	-	-

### 3.5. Table for Test Modes

Preliminary tests were performed in different data rate to find the worst radiated emission. The data rate shown in the table below is the worst-case rate with respect to the specific test item. Investigation has been done on all the possible configurations for searching the worst cases. The following table is a list of the test modes shown in this test report.

Test Items	Mode		Data Rate	Channel	Antenna
AC Power Conducted Emission	Normal Link		Auto	-	-
Max. Conducted Output Power Power Spectral Density	20MHz	Band 1	MCS0	36/40/48	0/1/0+1
	40MHz	Band 1	MCS0	38/46	0/1/0+1
	80MHz	Band 1	MCS0	42	0/1/0+1
	11a	Band 1	BPSK	36/40/48	0/1/0+1
26dB Spectrum Bandwidth 99% Occupied Bandwidth Measurement Peak Excursion	20MHz	Band 1	MCS0	36/40/48	0+1
	40MHz	Band 1	MCS0	38/46	0+1
	80MHz	Band 1	MCS0	42	0+1
	11a	Band 1	BPSK	36/40/48	0+1
Radiated Emission Below 1GHz	Normal Link		Auto	-	-
Radiated Emission Above 1GHz	20MHz	Band 1	MCS0	36/40/48	0+1
	40MHz	Band 1	MCS0	38/46	0+1
	80MHz	Band 1	MCS0	42	0+1
	11a	Band 1	BPSK	36/40/48	0+1
Band Edge Emission	20MHz	Band 1	MCS0	36/40/48	0+1
	40MHz	Band 1	MCS0	38/46	0+1
	80MHz	Band 1	MCS0	42	0+1
	11a	Band 1	BPSK	36/40/48	0+1

Frequency Stability	Un-modulation	-	40	N/A
---------------------	---------------	---	----	-----

**For Radiated Emission test:**

Mode 1: EUT- Upright

Mode 2: EUT-Lying

Mode 2 generated the worst case, so it was selected to perform test and its test result was written in the report.

### 3.6. Table for Testing Locations

Test Site No.	Site Category	Location	FCC Reg. No.	IC File No.	VCCI Reg. No
03CH01-CB	SAC	Hsin Chu	262045	IC 4086D	-
CO01-CB	Conduction	Hsin Chu	262045	IC 4086D	-
TH01-CB	OVEN Room	Hsin Chu	-	-	-

Open Area Test Site (OATS); Semi Anechoic Chamber (SAC); Fully Anechoic Chamber (FAC).

Please refer section 6 for Test Site Address.

### 3.7. Table for Supporting Units

Support Unit	Brand	Model	FCC ID
Notebook	DELL	M1330	E2K4965AGNM
Mouse	iCooky	AMS0706W	DoC
Earphone	SHYARO CHI	MIC-04	N/A
Notebook	DELL	M1330	E2KWM3945ABG

### 3.8. Table for Parameters of Test Software Setting

During testing, Channel & Power Controlling Software provided by the customer was used to control the operating channel as well as the output power level. The RF output power selection is for the setting of RF output power expected by the customer and is going to be fixed on the firmware of the final end product.

#### Power Parameters of IEEE 802.11n MCS0 20MHz

Test Software Version	Manual Tool 1.0.0.9		
Frequency	5180 MHz	5200 MHz	5240 MHz
MCS0 20MHz	44.00	40.00	46.00

#### Power Parameters of IEEE 802.11n MCS0 40MHz

Test Software Version	Manual Tool 1.0.0.9	
Frequency	5190 MHz	5230 MHz
MCS0 40MHz	45.00	43.00

#### Power Parameters of IEEE 802.11a

Test Software Version	Manual Tool 1.0.0.9		
Frequency	5180 MHz	5200 MHz	5240 MHz
11a OFDM	44.00	44.00	43.00

#### Power Parameters of IEEE 802.11ac MCS0 VHT 20MHz

Test Software Version	Manual Tool 1.0.0.9		
Frequency	5180 MHz	5200 MHz	5240 MHz
MCS0 NSS1 20MHz	36.00	44.00	45.00

#### Power Parameters of IEEE 802.11ac MCS0 VHT 40MHz

Test Software Version	Manual Tool 1.0.0.9	
Frequency	5190 MHz	5230 MHz
MCS0 NSS1 40MHz	45.00	43.00

#### Power Parameters of IEEE 802.11ac MCS0 VHT 80MHz

Test Software Version	Manual Tool 1.0.0.9
Frequency	5210 MHz
MCS0 NSS1 80MHz	48.00

During the test, "Manual Tool 1.0.0.9" under WIN XP was executed the test program to control the EUT continuously transmit RF signal.

### 3.9. Test Configurations

#### 3.9.1. Radiation Emissions Test Configuration

Test Configuration: 30MHz ~1GHz

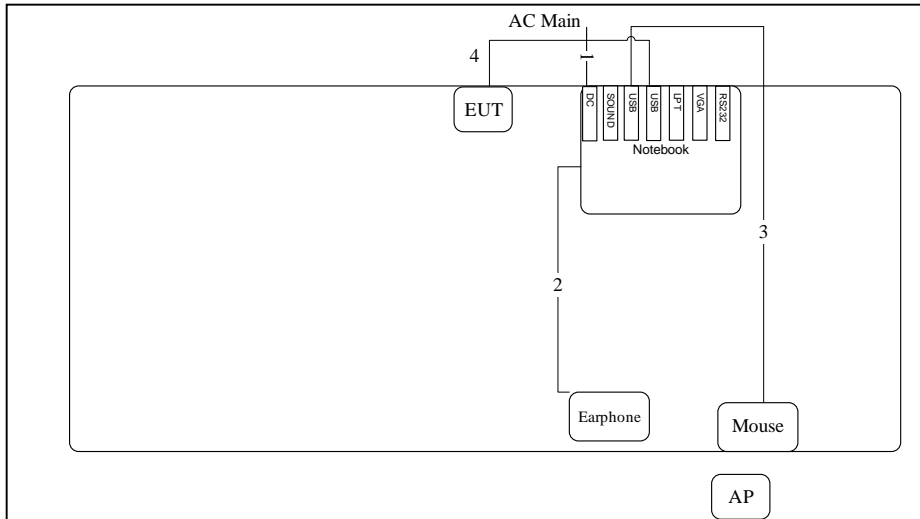

Item	Connection	Shield	Length
1	Power cable	No	1.8m
2	Earphone Cable	No	0.15m
3	USB Cable	No	0.6m
4	USB Cable	Yes	0.15m

Test Configuration: above 1GHz

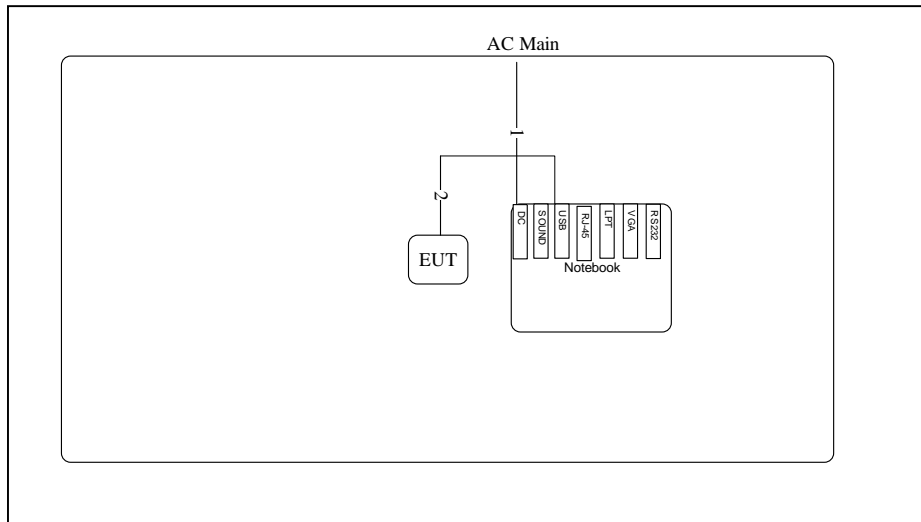

Item	Connection	Shield	Length
1	Power cable	No	1.8m
2	USB cable	Yes	0.15m

### 3.9.2. AC Power Line Conduction Emissions Test Configuration

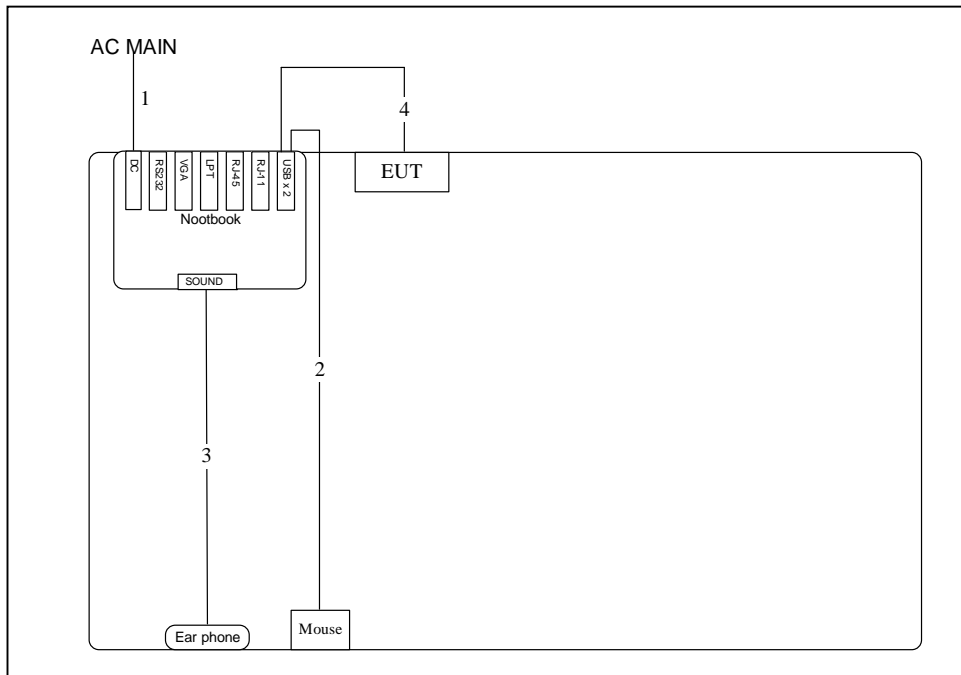

Item	Connection	Shield	Length
1	Power cable	No	2.6M
2	USB cable	No	1.8M
3	Earphone cable	No	1.1M
4	USB cable	Yes	1.8M

## 4. TEST RESULT

### 4.1. AC Power Line Conducted Emissions Measurement

#### 4.1.1. Limit

For this product that is designed to connect to the AC power line, the radio frequency voltage that is conducted back onto the AC power line on any frequency or frequencies within the band 150 kHz to 30 MHz shall not exceed below limits table.

Frequency (MHz)	QP Limit (dBuV)	AV Limit (dBuV)
0.15~0.5	66~56	56~46
0.5~5	56	46
5~30	60	50

#### 4.1.2. Measuring Instruments and Setting

Please refer to section 5 of equipments list in this report. The following table is the setting of the receiver.

Receiver Parameters	Setting
Attenuation	10 dB
Start Frequency	0.15 MHz
Stop Frequency	30 MHz
IF Bandwidth	9 KHz

#### 4.1.3. Test Procedures

1. Configure the EUT according to ANSI C63.10. The EUT or host of EUT has to be placed 0.4 meter far from the conducting wall of the shielding room and at least 80 centimeters from any other grounded conducting surface.
2. Connect EUT or host of EUT to the power mains through a line impedance stabilization network (LISN).
3. All the support units are connected to the other LISNs. The LISN should provide 50uH/50ohms coupling impedance.
4. The frequency range from 150 KHz to 30 MHz was searched.
5. Set the test-receiver system to Peak Detect Function and Specified Bandwidth with Maximum Hold Mode.
6. The measurement has to be done between each power line and ground at the power terminal.



#### 4.1.4. Test Setup Layout

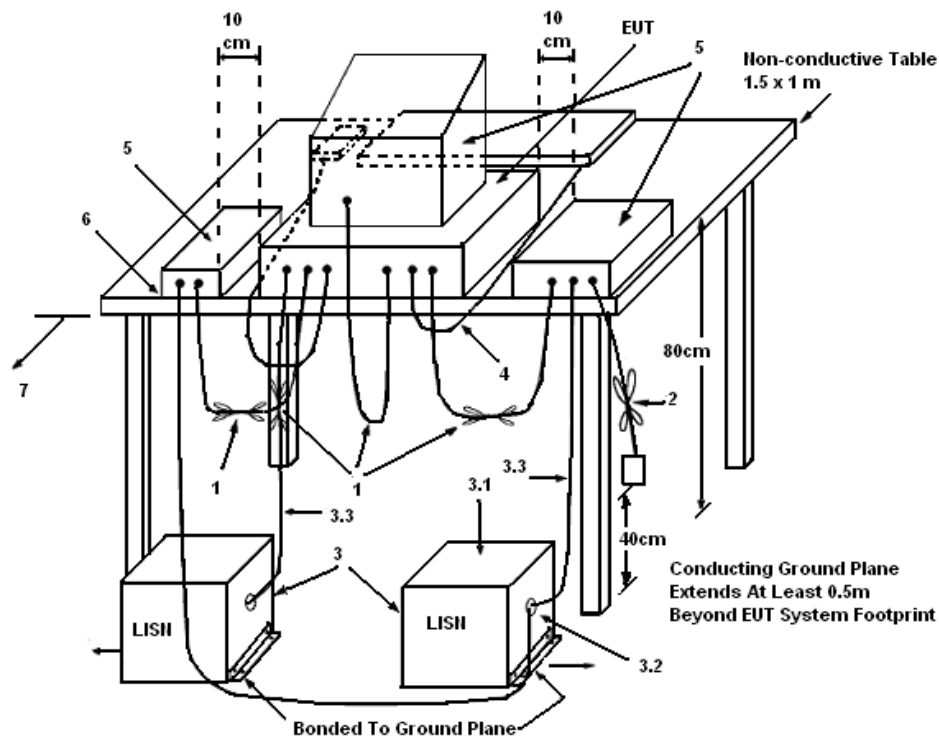

#### LEGEND:

- (1) Interconnecting cables that hang closer than 40 cm to the ground plane shall be folded back and forth in the center forming a bundle 30 to 40 cm long.
- (2) I/O cables that are not connected to a peripheral shall be bundled in the center. The end of the cable may be terminated, if required, using the correct terminating impedance. The overall length shall not exceed 1 m.
- (3) EUT connected to one LISN. Unused LISN measuring port connectors shall be terminated in 50  $\Omega$ . LISN can be placed on top of, or immediately beneath, reference ground plane.
  - (3.1) All other equipment powered from additional LISN(s).
  - (3.2) Multiple outlet strip can be used for multiple power cords of non-EUT equipment.
  - (3.3) LISN at least 80 cm from nearest part of EUT chassis.
- (4) Cables of hand-operated devices, such as keyboards, mice, etc., shall be placed as for normal use.
- (5) Non-EUT components of EUT system being tested.
- (6) Rear of EUT, including peripherals, shall all be aligned and flush with rear of tabletop.
- (7) Rear of tabletop shall be 40 cm removed from a vertical conducting plane that is bonded to the ground plane.

#### 4.1.5. Test Deviation

There is no deviation with the original standard.

#### 4.1.6. EUT Operation during Test

The EUT was placed on the test table and programmed in normal function.

#### 4.1.7. Results of AC Power Line Conducted Emissions Measurement

Temperature	25°C	Humidity	63%
Test Engineer	Ryo Fan	Phase	Line
Configuration	Normal Link		

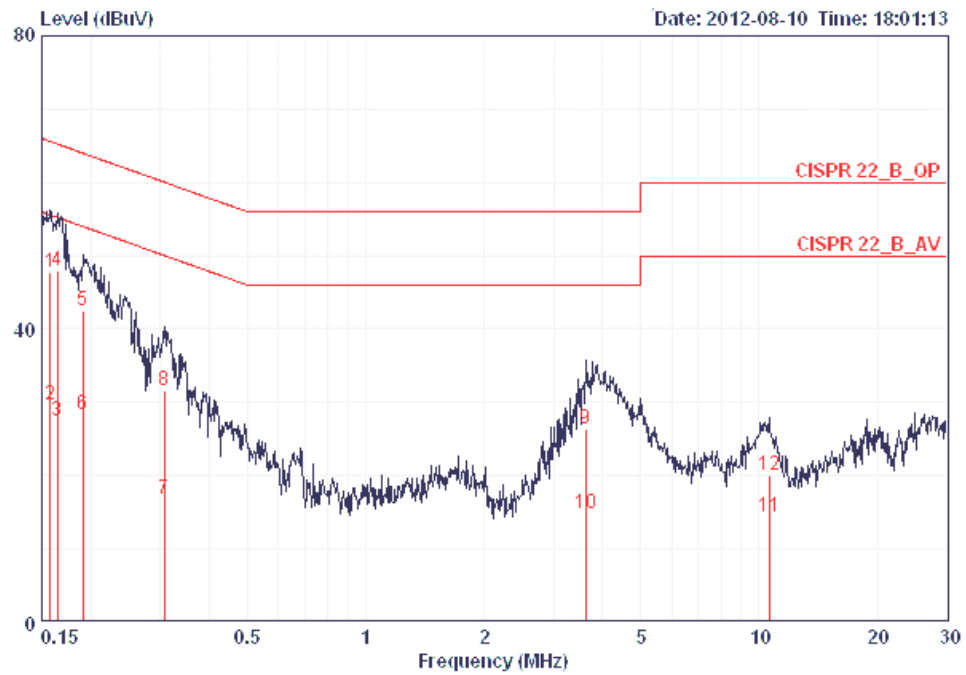

	Freq	Level	Over Limit	Limit Line	Read Level	LISN Factor	Cable Loss	Pol/Phase	Remark
	MHz	dBuV	dB	dBuV	dBuV	dB	dB		
1	0.15733	47.73	-17.87	65.60	47.37	0.16	0.20	LINE	QP
2	0.15733	29.63	-25.97	55.60	29.27	0.16	0.20	LINE	AVERAGE
3	0.16414	27.46	-27.79	55.25	27.10	0.16	0.20	LINE	AVERAGE
4	0.16414	47.89	-17.36	65.25	47.53	0.16	0.20	LINE	QP
5	0.19039	42.44	-21.58	64.02	42.09	0.15	0.20	LINE	QP
6	0.19039	28.28	-25.74	54.02	27.93	0.15	0.20	LINE	AVERAGE
7	0.30671	16.79	-33.27	50.06	16.44	0.15	0.20	LINE	AVERAGE
8	0.30671	31.59	-28.47	60.06	31.24	0.15	0.20	LINE	QP
9	3.623	26.41	-29.59	56.00	25.90	0.21	0.30	LINE	QP
10	3.623	14.82	-31.18	46.00	14.31	0.21	0.30	LINE	AVERAGE
11	10.620	14.45	-35.55	50.00	13.70	0.35	0.40	LINE	AVERAGE
12	10.620	20.05	-39.95	60.00	19.30	0.35	0.40	LINE	QP

Temperature	25°C	Humidity	63%
Test Engineer	Ryo Fan	Phase	Neutral
Configuration	Normal Link		

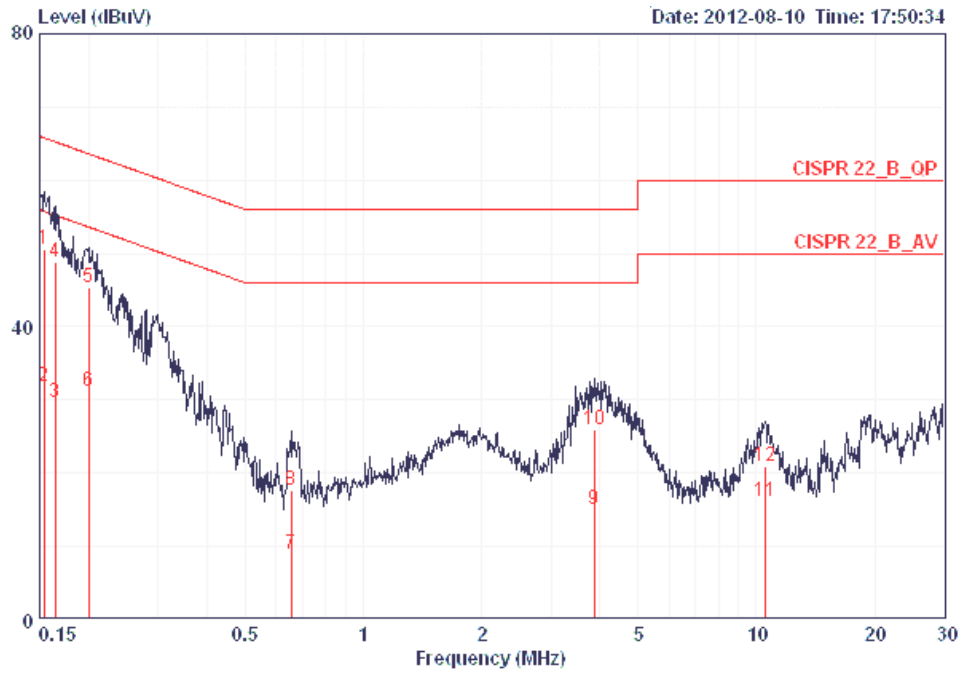

	Freq	Level	Over Limit	Limit Line	Read Level	LISN Factor	Cable Loss	Pol/Phase	Remark
	MHz	dBuV	dB	dBuV	dBuV	dB	dB		
1	0.15403	50.58	-15.20	65.78	50.30	0.08	0.20	NEUTRAL	QP
2	0.15403	31.79	-23.99	55.78	31.51	0.08	0.20	NEUTRAL	AVERAGE
3	0.16414	29.55	-25.70	55.25	29.27	0.08	0.20	NEUTRAL	AVERAGE
4	0.16414	48.87	-16.38	65.25	48.59	0.08	0.20	NEUTRAL	QP
5	0.19969	45.37	-18.25	63.62	45.09	0.08	0.20	NEUTRAL	QP
6	0.19969	31.09	-22.53	53.62	30.81	0.08	0.20	NEUTRAL	AVERAGE
7	0.65430	8.98	-37.02	46.00	8.70	0.08	0.20	NEUTRAL	AVERAGE
8	0.65430	17.73	-38.27	56.00	17.45	0.08	0.20	NEUTRAL	QP
9	3.860	15.15	-30.85	46.00	14.72	0.13	0.30	NEUTRAL	AVERAGE
10	3.860	25.84	-30.16	56.00	25.41	0.13	0.30	NEUTRAL	QP
11	10.564	16.21	-33.79	50.00	15.57	0.25	0.39	NEUTRAL	AVERAGE
12	10.564	20.98	-39.02	60.00	20.34	0.25	0.39	NEUTRAL	QP

Note:

Level = Read Level + LISN Factor + Cable Loss.

## 4.2. 99% Occupied Bandwidth Measurement

### 4.2.1. Limit

No restriction limits. But resolution bandwidth within band edge measurement is 1% of the 99% occupied bandwidth.

### 4.2.2. Measuring Instruments and Setting

Please refer to section 5 of equipments list in this report. The following table is the setting of the spectrum analyzer.

Spectrum Parameters	Setting
Attenuation	Auto
Span Frequency	> 26dB Bandwidth
RB	300 kHz
VB	1000 kHz
Detector	Peak
Trace	Max Hold
Sweep Time	Auto

### 4.2.3. Test Procedures

1. The transmitter output (antenna port) was connected to the spectrum analyzer in peak hold mode.
2. The resolution bandwidth of 300 kHz and the video bandwidth of 1000 kHz were used.
3. Measured the spectrum width with power higher than 26dB below carrier.

### 4.2.4. Test Setup Layout

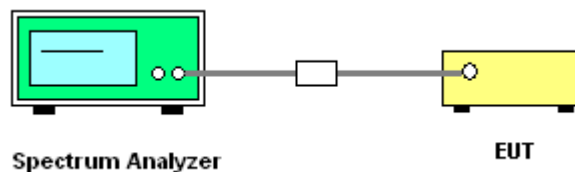

### 4.2.5. Test Deviation

There is no deviation with the original standard.

### 4.2.6. EUT Operation during Test

The EUT was programmed to be in continuously transmitting mode.

#### 4.2.7. Test Result of 99% Occupied Bandwidth

Temperature	23°C	Humidity	63%
Test Engineer	Benson Peng	Configurations	IEEE 802.11 n / ac

##### Configuration IEEE 802.11n MCS0 HT 20MHz / Ant. 0 + Ant. 1

Channel	Frequency	26dB Bandwidth (MHz)	99% Occupied Bandwidth (MHz)
36	5180 MHz	20.16	17.44
40	5200 MHz	20.48	17.44
48	5240 MHz	20.16	17.44

##### Configuration IEEE 802.11n MCS0 HT 40MHz / Ant. 0 + Ant. 1

Channel	Frequency	26dB Bandwidth (MHz)	99% Occupied Bandwidth (MHz)
38	5190 MHz	40.96	37.12
46	5230 MHz	40.96	37.12

##### Configuration IEEE 802.11ac MCS0 VHT 20MHz / Ant. 0 + Ant. 1

Channel	Frequency	26dB Bandwidth (MHz)	99% Occupied Bandwidth (MHz)
36	5180 MHz	20.16	17.44
40	5200 MHz	20.00	17.44
48	5240 MHz	20.16	17.44

##### Configuration IEEE 802.11ac MCS0 VHT 40MHz / Ant. 0 + Ant. 1

Channel	Frequency	26dB Bandwidth (MHz)	99% Occupied Bandwidth (MHz)
38	5190 MHz	40.96	37.12
46	5230 MHz	40.96	37.12

##### Configuration IEEE 802.11ac MCS0 VHT 80MHz / Ant. 0 + Ant. 1

Channel	Frequency	26dB Bandwidth (MHz)	99% Occupied Bandwidth (MHz)
42	5210 MHz	82.56	76.80

<b>Temperature</b>	23°C	<b>Humidity</b>	63%
<b>Test Engineer</b>	Benson Peng	<b>Configurations</b>	IEEE 802.11a

**Configuration IEEE 802.11a / Ant. 0 + Ant. 1**

<b>Channel</b>	<b>Frequency</b>	<b>26dB Bandwidth (MHz)</b>	<b>99% Occupied Bandwidth (MHz)</b>
36	5180 MHz	19.84	16.32
40	5200 MHz	19.84	16.32
48	5240 MHz	19.68	16.32

26 dB Bandwidth Plot on Configuration IEEE 802.11n MCS0 HT 20MHz / Ant. 0 + Ant. 1/ 5180 MHz

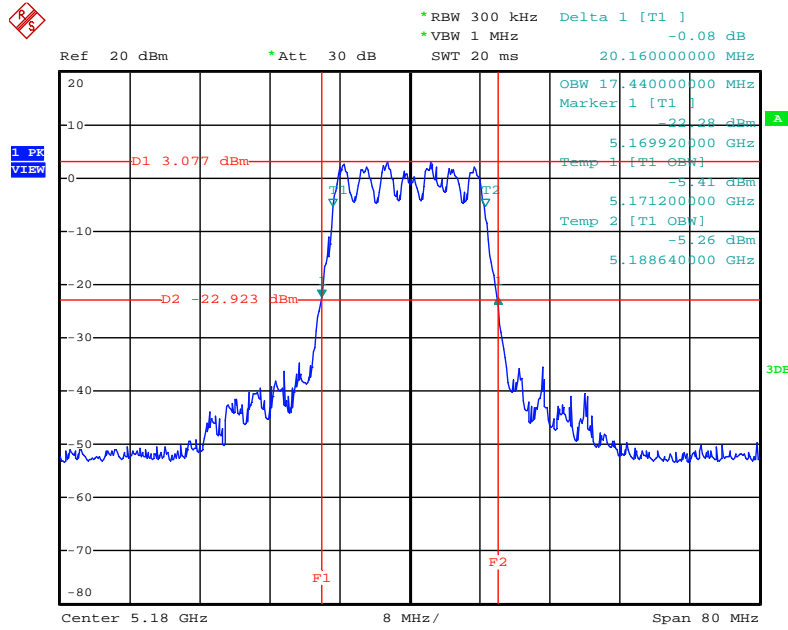

Date: 23.AUG.2012 22:16:07

26 dB Bandwidth Plot on Configuration IEEE 802.11n MCS0 HT 20MHz / Ant. 0 + Ant. 1/ 5200 MHz

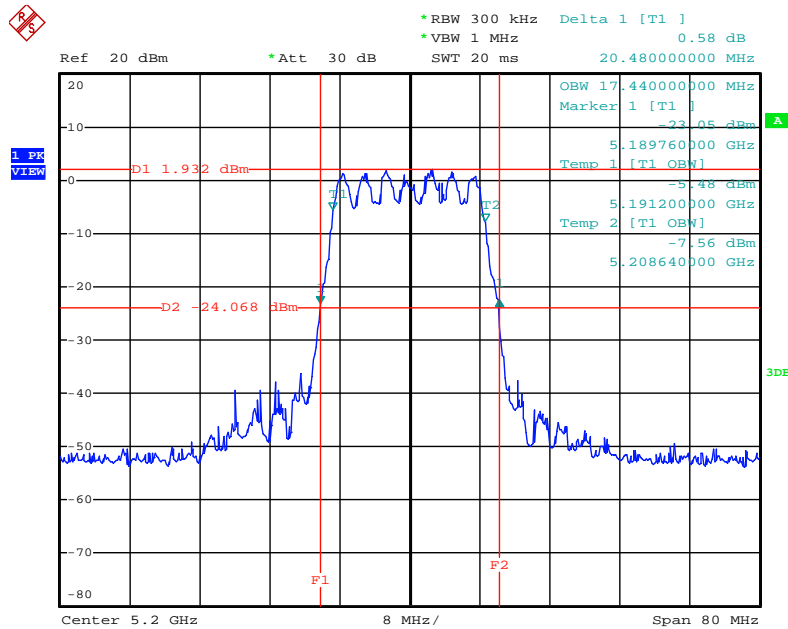

Date: 23.AUG.2012 22:15:39

26 dB Bandwidth Plot on Configuration IEEE 802.11n MCS0 HT 20MHz / Ant. 0 + Ant. 1/ 5240 MHz

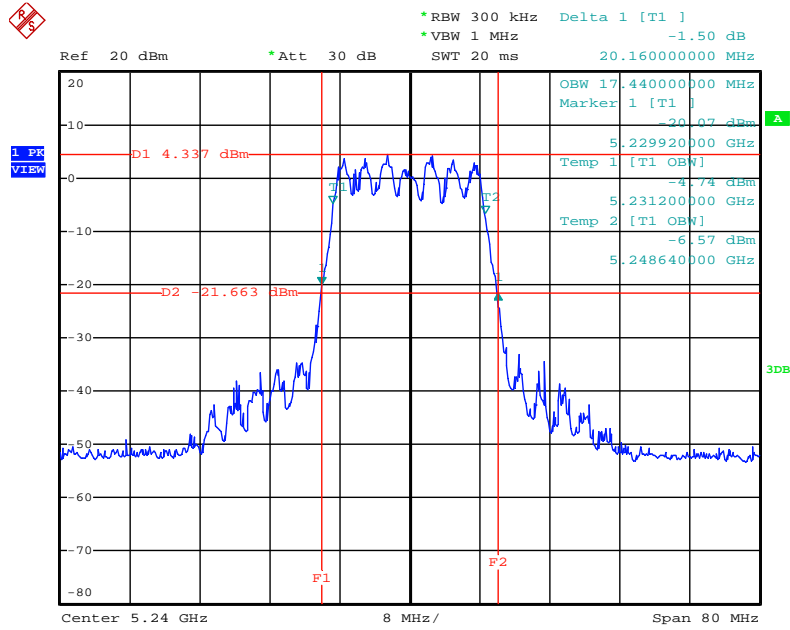

Date: 23.AUG.2012 22:14:58

26 dB Bandwidth Plot on Configuration IEEE 802.11n MCS0 HT 40MHz / Ant. 0 + Ant. 1/ 5190 MHz

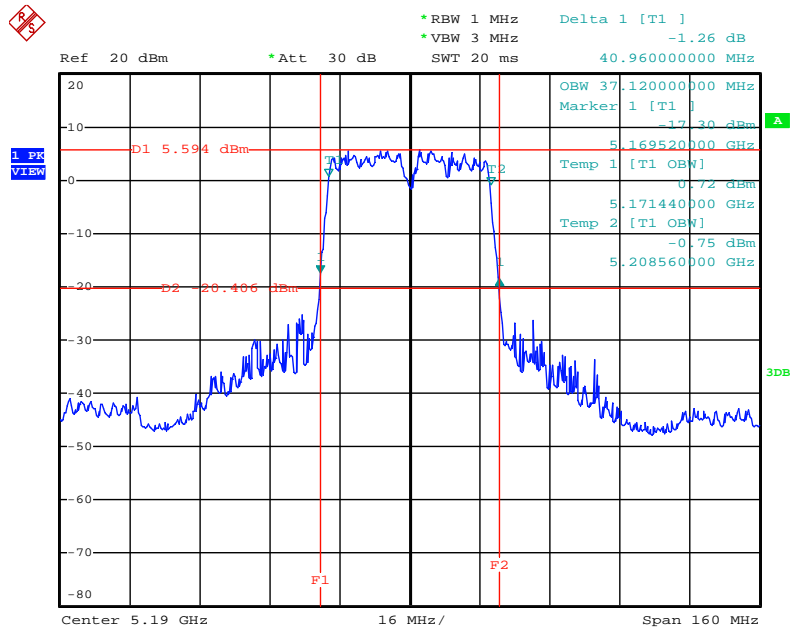

Date: 23.AUG.2012 22:24:41



26 dB Bandwidth Plot on Configuration IEEE 802.11n MCS0 HT 40MHz / Ant. 0 + Ant. 1/ 5230 MHz

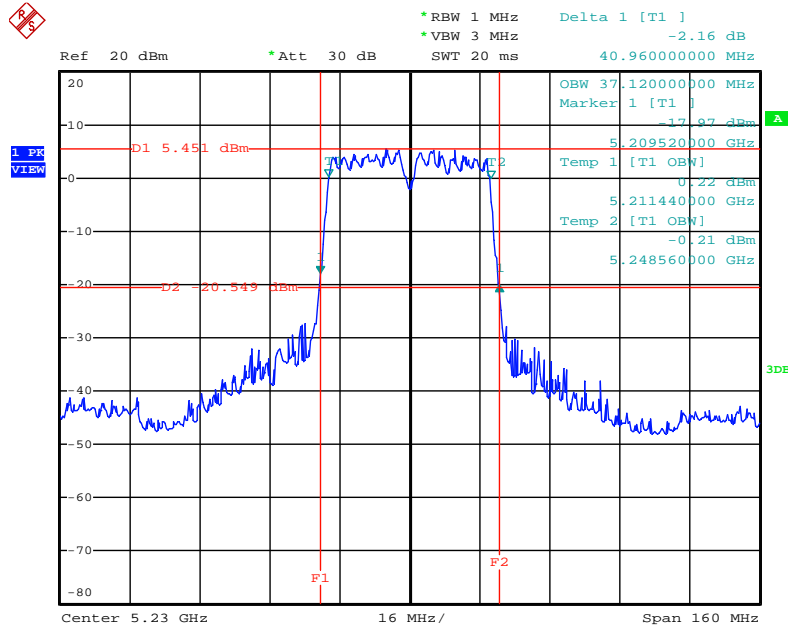

Date: 23.AUG.2012 22:24:19

26 dB Bandwidth Plot on Configuration IEEE 802.11ac MCS0 VHT80MHz / Ant. 0 + Ant. 1 / 5210 MHz

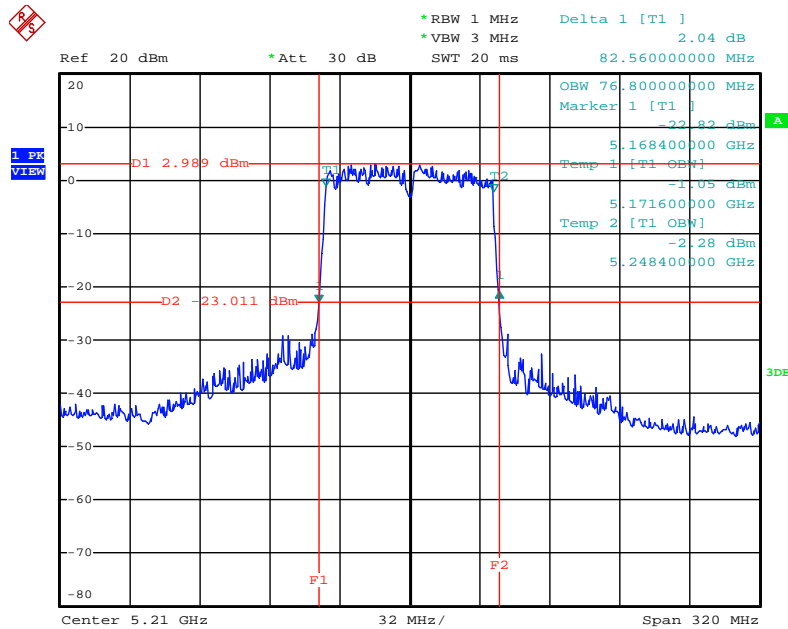

Date: 23.AUG.2012 22:21:20

26 dB Bandwidth Plot on Configuration IEEE 802.11a / Ant. 0 + Ant. 1 / 5180 MHz

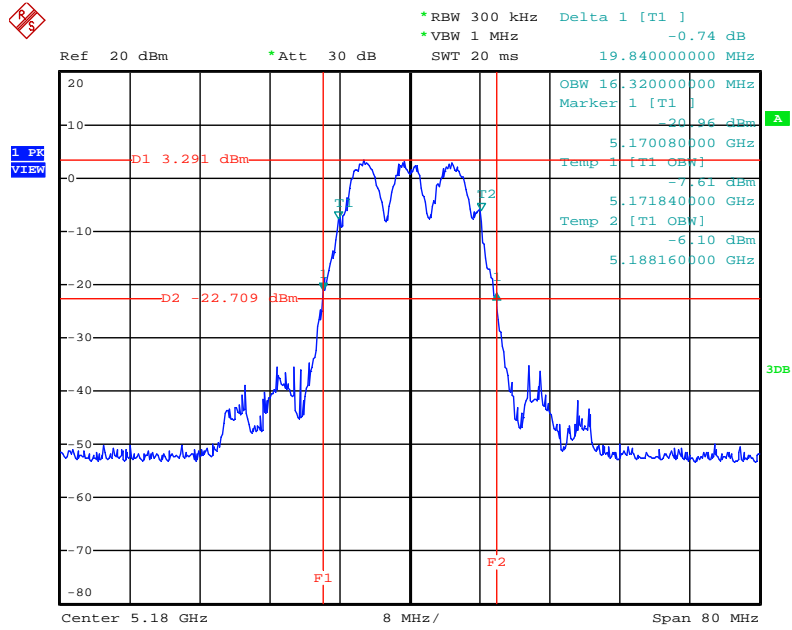

Date: 23.AUG.2012 22:09:28

26 dB Bandwidth Plot on Configuration IEEE 802.11a / Ant. 0 + Ant. 1 / 5200 MHz

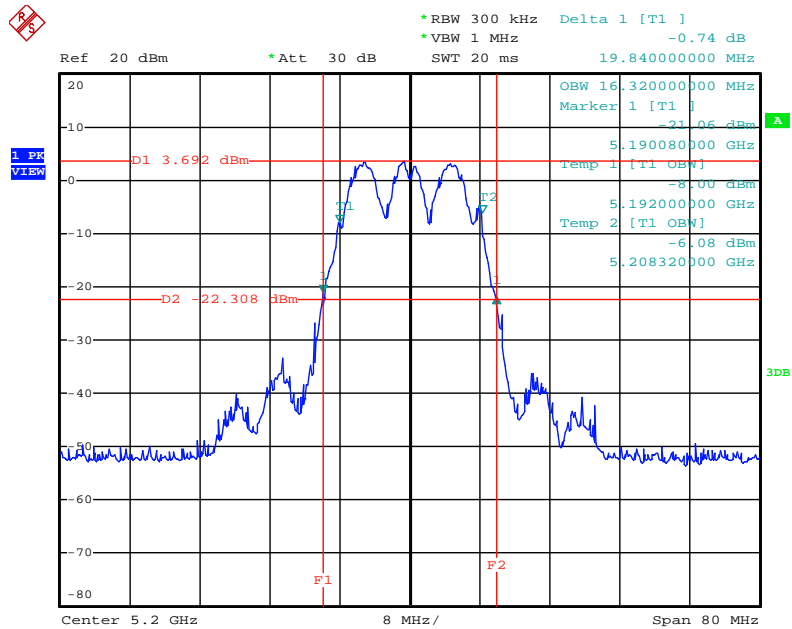

Date: 23.AUG.2012 22:13:08

26 dB Bandwidth Plot on Configuration IEEE 802.11a / Ant. 0 + Ant. 1 / 5240 MHz

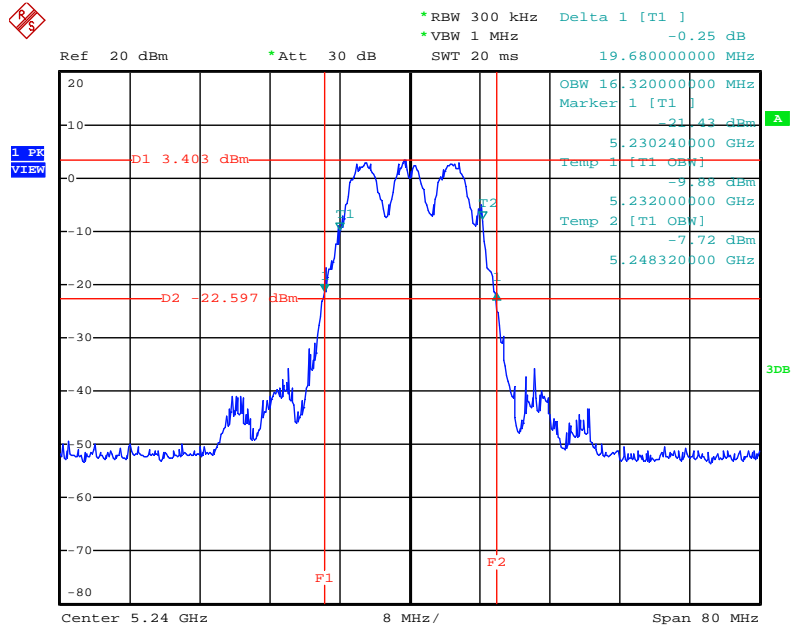

Date: 23.AUG.2012 22:13:57

### 4.3. Maximum Conducted Output Power Measurement

#### 4.3.1. Limit

For the band 5.15~5.25 GHz, the maximum conducted output power over the frequency band of operation shall not exceed the lesser of 50 mW (17dBm) or  $4 \text{ dBm} + 10\log B$ , where B is the 26 dB emissions bandwidth in MHz. If transmitting antennas of directional gain greater than 6 dBi are used, the peak output power and power density from the intentional radiator shall be reduced by the amount in dB that the directional gain of the antenna exceeds 6 dBi.

#### 4.3.2. Measuring Instruments and Setting

Please refer to section 5 of equipments list in this report. The following table is the setting of the spectrum analyzer.

Spectrum Parameter	Setting
Attenuation	Auto
Span Frequency	Encompass the entire emissions bandwidth (EBW) of the signal
RB	1000 kHz
VB	3000 kHz
Detector	RMS
Trace	Average sweep count 100
Sweep Time	Auto

#### 4.3.3. Test Procedures

1. The transmitter output (antenna port) was connected to the power meter.
2. Test was performed in accordance with KDB 789033 Guidelines for Compliance Testing of Unlicensed National Information Infrastructure (U-NII) Devices - Part 15, Subpart E, section (C) Maximum conducted output power =>(4) Method PM (Measurement using an RF average power meter) Multiple antenna systems was performed in accordance with KDB 662911 Emissions Testing of Transmitters with Multiple Outputs in the Same Band.
3. When measuring maximum conducted output power with multiple antenna systems, add every result of the values by mathematic formula.

#### 4.3.4. Test Setup Layout

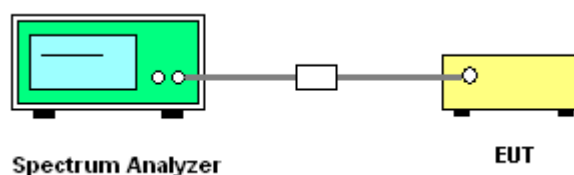

#### 4.3.5. Test Deviation

There is no deviation with the original standard.

#### 4.3.6. EUT Operation during Test

The EUT was programmed to be in continuously transmitting mode.

## 4.3.7. Test Result of Maximum Conducted Output Power

Temperature	23°C	Humidity	63%
Test Engineer	Benson Peng	Configurations	IEEE 802.11n / ac

## Configuration IEEE 802.11n MCS0 HT20MHz / Ant. 0+ Ant. 1

Channel	Frequency	Conducted Power (dBm)		Total Conducted Output Power (dBm)	Max. Limit (dBm)	Result
		Ant.0	Ant.1			
36	5180 MHz	12.20	12.23	15.23	17.00	Complies
40	5200 MHz	11.53	11.21	14.38	17.00	Complies
48	5240 MHz	12.84	12.91	15.89	17.00	Complies

## Configuration IEEE 802.11n MCS0 HT40MHz / Ant. 0+ Ant. 1

Channel	Frequency	Conducted Power (dBm)		Total Conducted Output Power (dBm)	Max. Limit (dBm)	Result
		Ant.0	Ant.1			
38	5190 MHz	12.75	12.78	15.78	17.00	Complies
46	5230 MHz	12.93	12.62	15.79	17.00	Complies

## Configuration IEEE 802.11ac MCS0 VHT 20MHz / Ant. 0+ Ant. 1

Channel	Frequency	Conducted Power (dBm)		Total Conducted Output Power (dBm)	Max. Limit (dBm)	Result
		Ant.0	Ant.1			
36	5180 MHz	10.29	10.30	13.31	17.00	Complies
40	5200 MHz	12.58	12.30	15.45	17.00	Complies
48	5240 MHz	12.60	12.85	15.74	17.00	Complies

## Configuration IEEE 802.11ac MCS0 VHT 40MHz / Ant. 0+ Ant. 1

Channel	Frequency	Conducted Power (dBm)		Total Conducted Output Power (dBm)	Max. Limit (dBm)	Result
		Ant.0	Ant.1			
38	5190 MHz	12.89	13.01	15.96	17.00	Complies
46	5230 MHz	12.80	12.85	15.84	17.00	Complies

Configuration IEEE 802.11ac MCS0 VHT 80MHz / Ant. 0+ Ant. 1

Channel	Frequency	Conducted Power (dBm)		Total Conducted Output Power (dBm)	Max. Limit (dBm)	Result
		Ant.0	Ant.1			
42	5210 MHz	12.82	13.01	15.93	17.00	Complies

Temperature	23°C	Humidity	63%
Test Engineer	Benson Peng	Configurations	IEEE 802.11a

**Configuration IEEE 802.11a / Ant. 0+ Ant. 1**

Channel	Frequency	Conducted Power (dBm)		Total Conducted Output Power (dBm)	Max. Limit (dBm)	Result
		Ant.0	Ant.1			
36	5180 MHz	12.13	12.32	15.24	16.42	Complies
40	5200 MHz	12.28	12.39	15.35	16.42	Complies
48	5240 MHz	12.16	12.41	15.30	16.38	Complies

NOTE: Directional gain =  $10 \log[(10^{G_1/20} + 10^{G_2/20} + \dots + 10^{G_N/20})^2 / N]$  dBi = 6.56dBi > 6dBi , so the conducted power limit = (17 or 4+10log B)-(6.56dBi-6)=16.44dBm

Note: All the test values were listed in the report.

For plots, only the channel with maximum results was shown.



Conducted Output Power Plot on Configuration IEEE 802.11n MCS0 HT20MHz / Ant. 0 / 5240 MHz

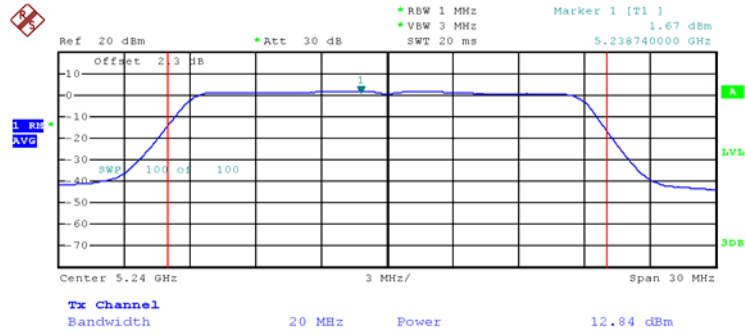

Date: 23.AUG.2012 19:54:26

Conducted Output Power Plot on Configuration IEEE 802.11n MCS0 HT20MHz / Ant. 1 / 5240 MHz

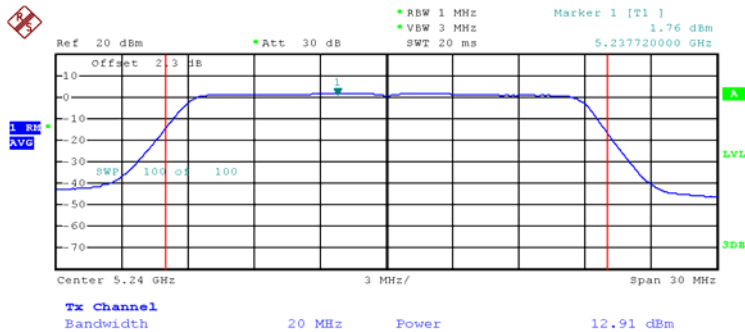

Date: 23.AUG.2012 19:53:58

Conducted Output Power Plot on Configuration IEEE 802.11n MCS0 HT40MHz / Ant. 0 / 5230 MHz

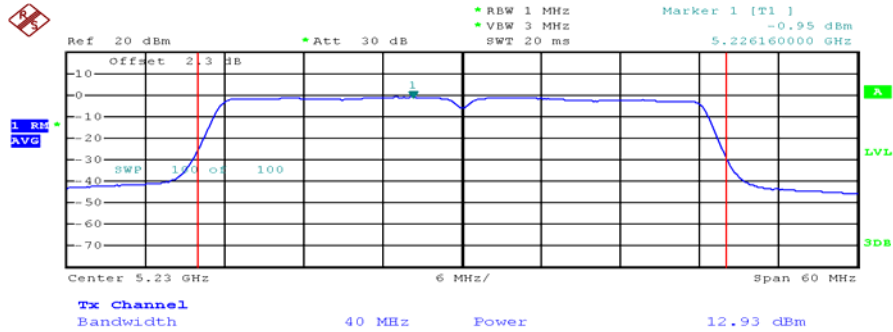

Date: 23.AUG.2012 20:09:34

Conducted Output Power Plot on Configuration IEEE 802.11n MCS0 HT40MHz / Ant. 1 / 5230 MHz

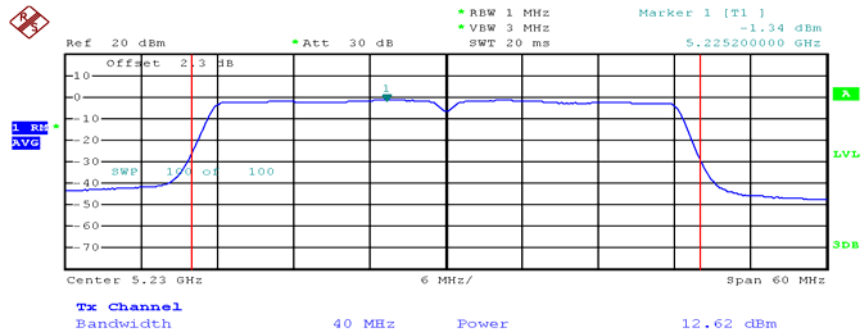

Date: 23.AUG.2012 20:10:01

Conducted Output Power Plot on Configuration IEEE 802.11ac MCS0 VHT 20MHz / Ant. 0 / 5240 MHz

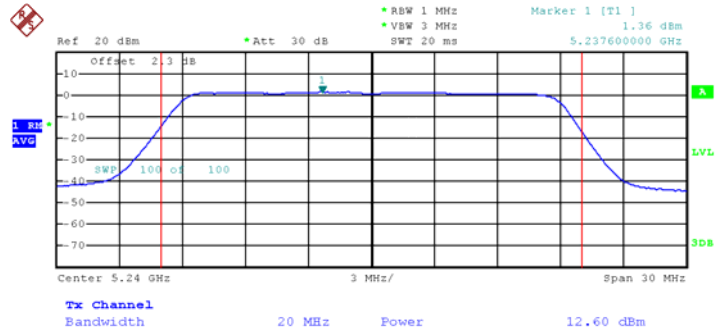

Date: 23.AUG.2012 20:29:21

Conducted Output Power Plot on Configuration IEEE 802.11ac MCS0 VHT 20MHz / Ant. 1 / 5240 MHz

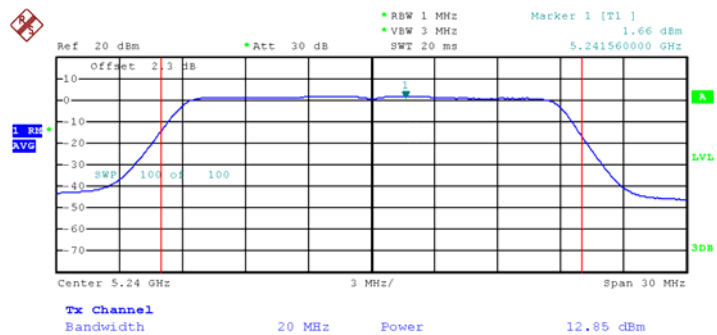

Date: 23.AUG.2012 20:28:59

Conducted Output Power Plot on Configuration IEEE 802.11ac MCS0 VHT 40MHz / Ant. 0 / 5190 MHz

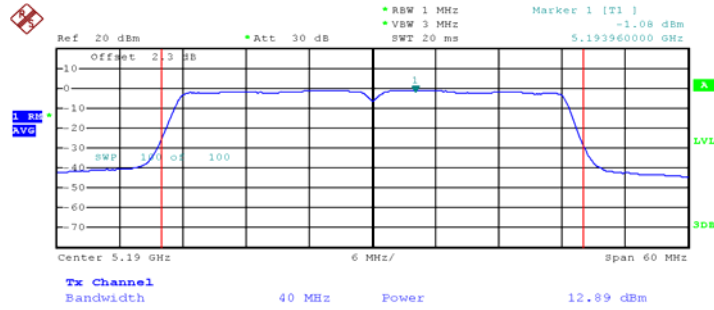

Date: 23.AUG.2012 20:32:34

Conducted Output Power Plot on Configuration IEEE 802.11ac MCS0 VHT 40MHz / Ant. 1 / 5190 MHz

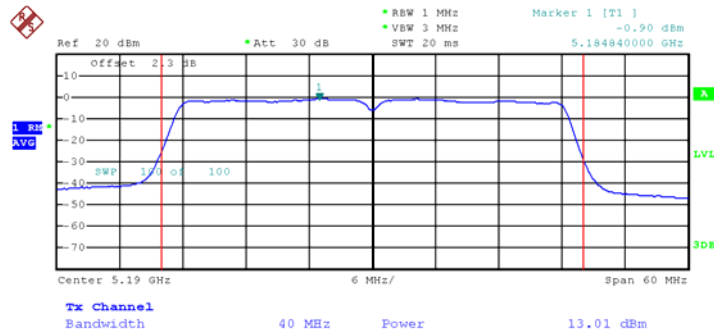

Date: 23.AUG.2012 20:31:50

Conducted Output Power Plot on Configuration IEEE 802.11ac MCS0 VHT 80MHz / Ant. 0 / 5210 MHz

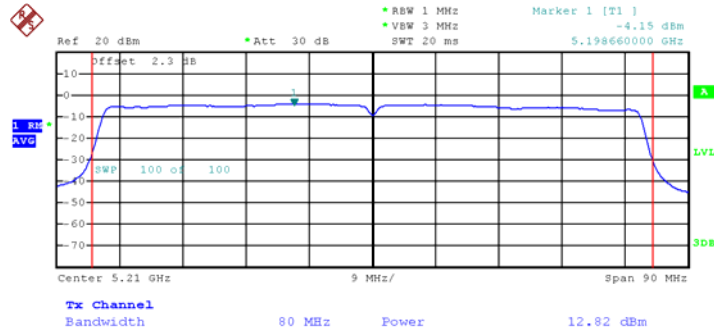

Date: 23.AUG.2012 20:40:16

Conducted Output Power Plot on Configuration IEEE 802.11ac MCS0 VHT 80MHz / Ant. 1 / 5210 MHz

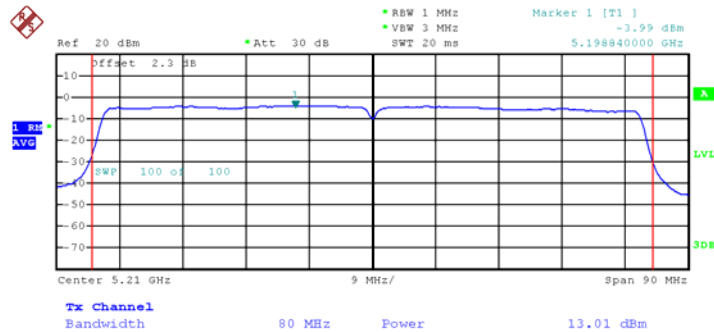

Date: 23.AUG.2012 20:40:42

Conducted Output Power Plot on Configuration IEEE 802.11a / Ant. 0 / 5200 MHz

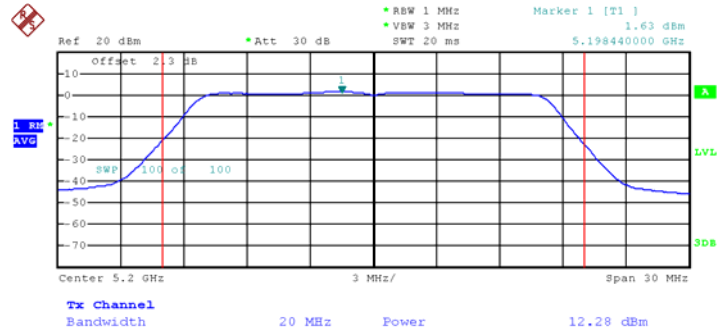

Date: 23.AUG.2012 22:42:31

Conducted Output Power Plot on Configuration IEEE 802.11a / Ant. 1 / 5200 MHz

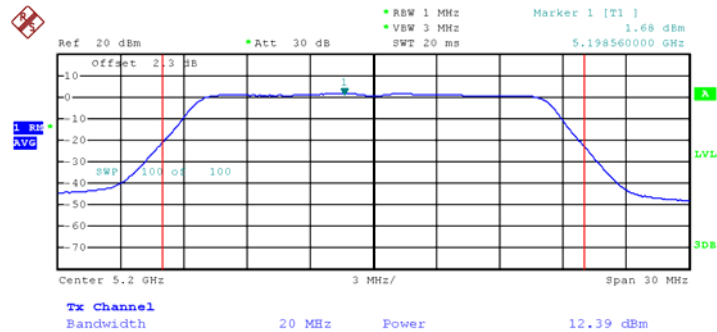

Date: 23.AUG.2012 22:42:53

## 4.4. Power Spectral Density Measurement

### 4.4.1. Limit

The power spectral density is defined as the highest level of power in dBm per MHz generated by the transmitter within the power envelope. The following table is power spectral density limits and decrease power density limit rule refer to section 4.3.1.

Frequency Range	Power Spectral Density limit (dBm/MHz)
5.15~5.25 GHz	4

### 4.4.2. Measuring Instruments and Setting

Please refer to section 5 of equipments list in this report. The following table is the setting of the spectrum analyzer.

Spectrum Parameter	Setting
Attenuation	Auto
Span Frequency	Encompass the entire emissions bandwidth (EBW) of the signal
RB	1000 kHz
VB	3000 kHz
Detector	RMS
Sweep Time	Auto
Trace Average	100 times

### 4.4.3. Test Procedures

1. The test procedure is the same as section 4.6.3.
2. Trace A, Set RBW =1MHz, VBW = 3MHz, Span >26dB bandwidth, Max. hold.
3. Delta Mark trace A Maximum frequency and trace B same frequency.
4. Repeat the above procedure until measurements for all frequencies were complete.
5. Procedures refer KDB 662911 : Measure and sum the spectra across the outputs.

The first spectral bin of output 1 is summed with that in the first spectral bin of output 2 and that from the first spectral bin of output 3, and so on up to the Nth output to obtain the value for the first frequency bin of the summed spectrum. The summed spectrum value for each of the other frequency bins is computed in the same way. This will likely require transferring the measured spectra to a computer, where the bin-by-bin summing can be performed

### 4.4.4. Test Setup Layout

This test setup layout is the same as that shown in section 4.6.4.

### 4.4.5. Test Deviation

There is no deviation with the original standard.

### 4.4.6. EUT Operation during Test

The EUT was programmed to be in continuously transmitting mode.

#### 4.4.7. Test Result of Power Spectral Density

Temperature	23°C	Humidity	63%
Test Engineer	Benson Peng	Configurations	IEEE 802.11n / ac
Test Date	Aug. 23, 2012		

##### Configuration IEEE 802.11n MCS0 HT20MHz / Ant. 0 + Ant.1

Channel	Frequency	Total Conducted Output Power (dBm)	Max. Limit (dBm)	Result
36	5180 MHz	2.45	4.00	Complies
40	5200 MHz	1.60	4.00	Complies
48	5240 MHz	2.94	4.00	Complies

##### Configuration IEEE 802.11n MCS0 HT40MHz / Ant. 0 + Ant.1

Channel	Frequency	Total Conducted Output Power (dBm)	Max. Limit (dBm)	Result
38	5190 MHz	0.40	4.00	Complies
46	5230 MHz	-0.25	4.00	Complies

##### Configuration IEEE 802.11ac MCS0 VHT 80MHz

Channel	Frequency	Total Power Density (dBm/MHz)	Max. Limit (dBm/MHz)	Result
42	5210 MHz	-2.39	4.00	Complies



Temperature	25°C	Humidity	63%
Test Engineer	Benson Peng	Configurations	IEEE 802.11a
Test Date	Aug. 23, 2012		

**Configuration IEEE 802.11a**

Channel	Frequency	Total Power Density (dBm/MHz)	Max. Limit (dBm/MHz)	Result
36	5180 MHz	2.91	3.44	Complies
40	5200 MHz	2.97	3.44	Complies
48	5240 MHz	2.76	3.44	Complies

Note: **Directional gain** =  $G_{ANT} + 10 \log(N)$  dBi = 6.56dBi > 6dBi , so the power density limit =  $4 - (6.56 - 6) = 3.44$ dBm.

Note: All the test values were listed in the report.

For plots, only the channel with maximum results was shown.

Power Density Plot on Configuration IEEE 802.11n MCS0 20MHz / Ant. 0 + Ant. 1 / 5240 MHz

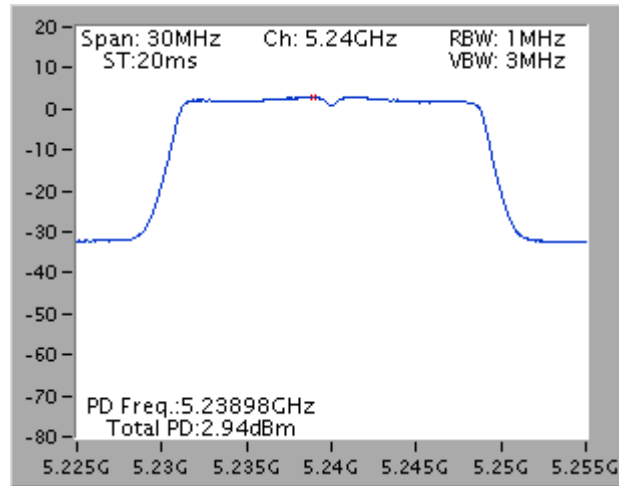

Power Density Plot on Configuration IEEE 802.11n MCS0 40MHz / Ant. 0 + Ant. 1 / 5190 MHz

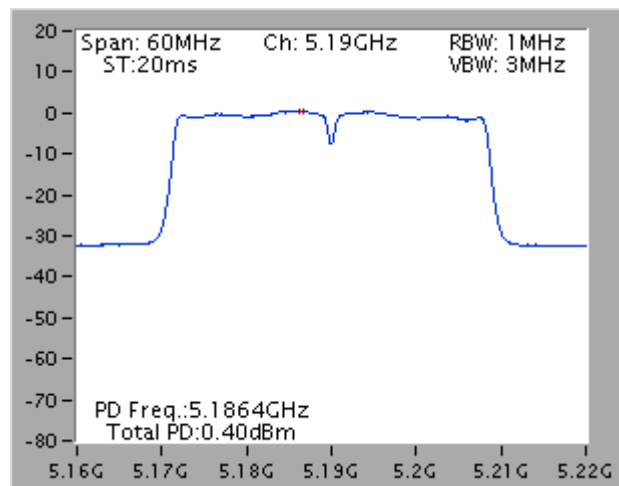

Power Density Plot on Configuration IEEE 802.11a / Ant. 0 + Ant. 1 / 5200 MHz

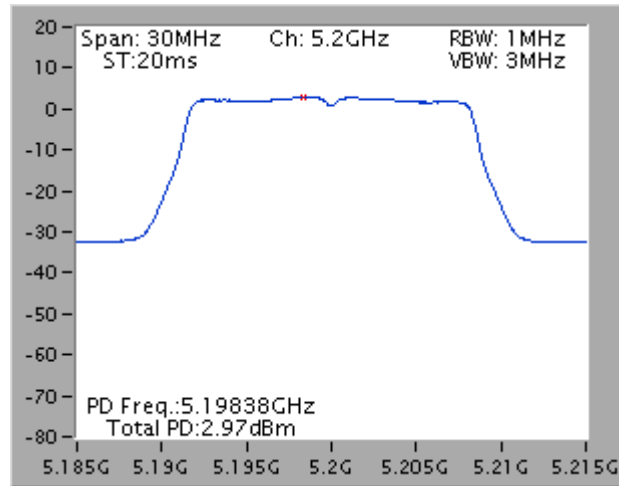

Power Density Plot on Configuration IEEE 802.11ac MCS0 80MHz/ Ant. 0 + Ant. 1 / 5210 MHz

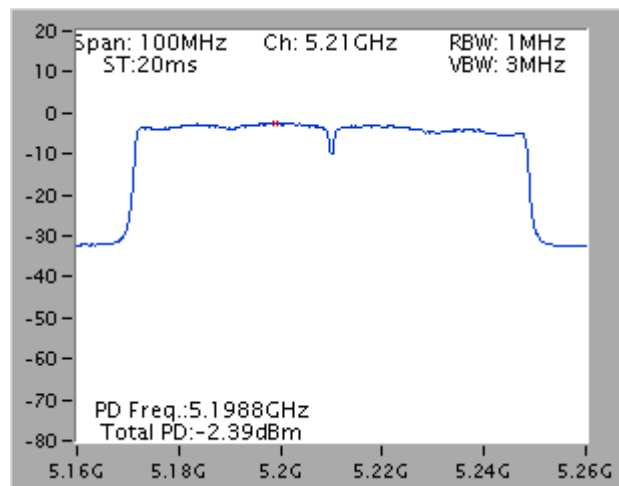

## 4.5. Peak Excursion Measurement

### 4.5.1. Limit

The ratio of the peak excursion of the modulation envelope (measured using a peak hold function) to the maximum conducted output power (measured as specified above) shall not exceed 13 dB across any 1 MHz bandwidth or the emissions bandwidth whichever is less.

### 4.5.2. Measuring Instruments and Setting

Please refer to section 5 of equipments list in this report. The following table is the setting of the spectrum analyzer.

Spectrum Parameter	Setting
Attenuation	Auto
Span Frequency	Encompass the entire emissions bandwidth (EBW) of the signal
RB	1MHz (Peak Trace) / 1MHz (Average Trace)
VB	3MHz (Peak Trace) / 3MHz (Average Trace)
Detector	Peak (Peak Trace) / RMS
Trace	Peak : Trace :Max hold/Average: Trace Average Sweep Count 100
Sweep Time	AUTO

### 4.5.3. Test Procedures

1. The test procedure is the same as section 4.6.3.
2. Trace A, Set RBW =1MHz, VBW = 3MHz, Span >26dB bandwidth, Max. hold.
3. Delta Mark trace A Maximum frequency and trace B same frequency.
4. Repeat the above procedure until measurements for all frequencies were complete.

### 4.5.4. Test Setup Layout

This test setup layout is the same as that shown in section 4.6.4.

### 4.5.5. Test Deviation

There is no deviation with the original standard.

### 4.5.6. EUT Operation during Test

The EUT was programmed to be in continuously transmitting mode.

## 4.5.7. Test Result of Peak Excursion

Temperature	23°C	Humidity	63%
Test Engineer	Benson Peng	Configurations	IEEE 802.11n / ac

## Configuration IEEE 802.11n MCS0 HT20MHz / Ant. 0 + Ant. 1

Channel	Frequency	Peak Excursion (dB)	Max. Limit (dB)	Result
36	5180 MHz	9.10	13	Complies
40	5200 MHz	8.76	13	Complies
48	5240 MHz	9.05	13	Complies

## Configuration IEEE 802.11n MCS0 HT40MHz / Ant. 0 + Ant. 1

Channel	Frequency	Peak Excursion (dB)	Max. Limit (dB)	Result
38	5190 MHz	8.48	13	Complies
46	5230 MHz	8.79	13	Complies

## Configuration IEEE 802.11ac MCS0 VHT80MHz / Ant. 0 + Ant. 1

Channel	Frequency	Peak Excursion (dB)	Max. Limit (dB)	Result
42	5210 MHz	8.85	13	Complies

Temperature	23°C	Humidity	63%
Test Engineer	Benson Peng	Configurations	IEEE 802.11a

**Configuration IEEE 802.11a / Ant. 0 + Ant. 1**

Channel	Frequency	Peak Excursion (dB)	Max. Limit (dB)	Result
36	5180 MHz	8.68	13	Complies
40	5200 MHz	9.96	13	Complies
48	5240 MHz	8.45	13	Complies

Note: All the test values were listed in the report.

For plots, only the channel with maximum results was shown.

Peak Excursion Plot on Configuration IEEE 802.11n MCS0 HT20MHz / Ant. 0 + Ant. 1 / 5180

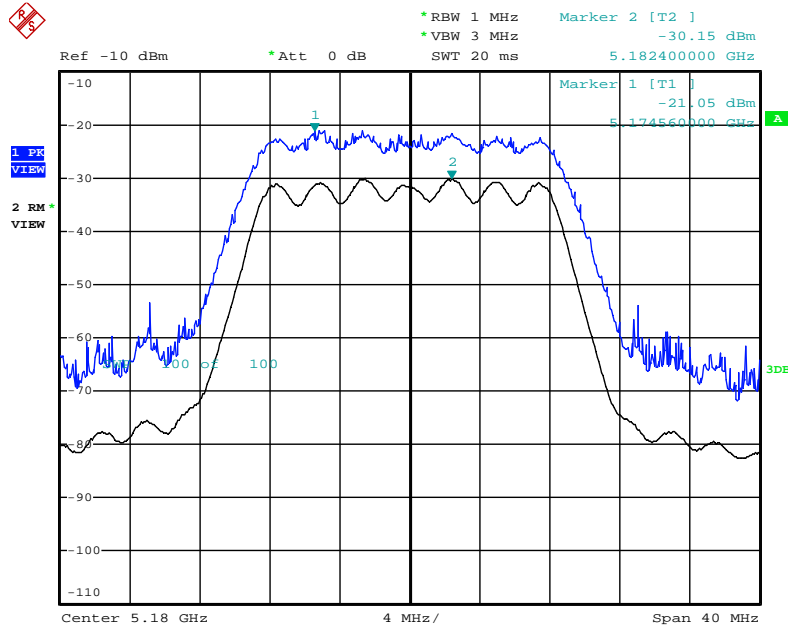

Date: 23.AUG.2012 22:33:46

Peak Excursion Plot on Configuration IEEE 802.11n MCS0 HT40MHz / Ant. 0 + Ant. 1 / 5230

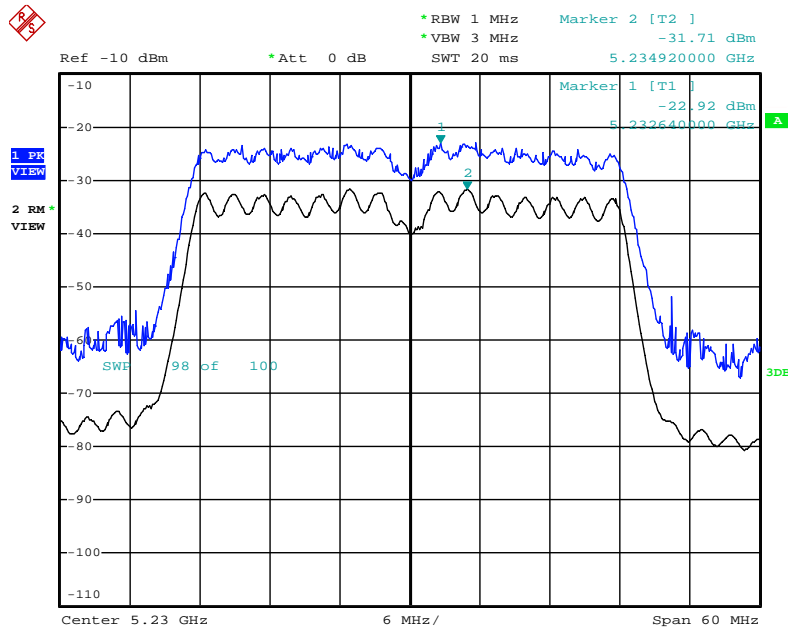

Date: 23.AUG.2012 22:35:18

Peak Excursion Plot on Configuration IEEE 802.11ac MCS0 VHT 80MHz / Ant. 0 + Ant. 1 / 5210

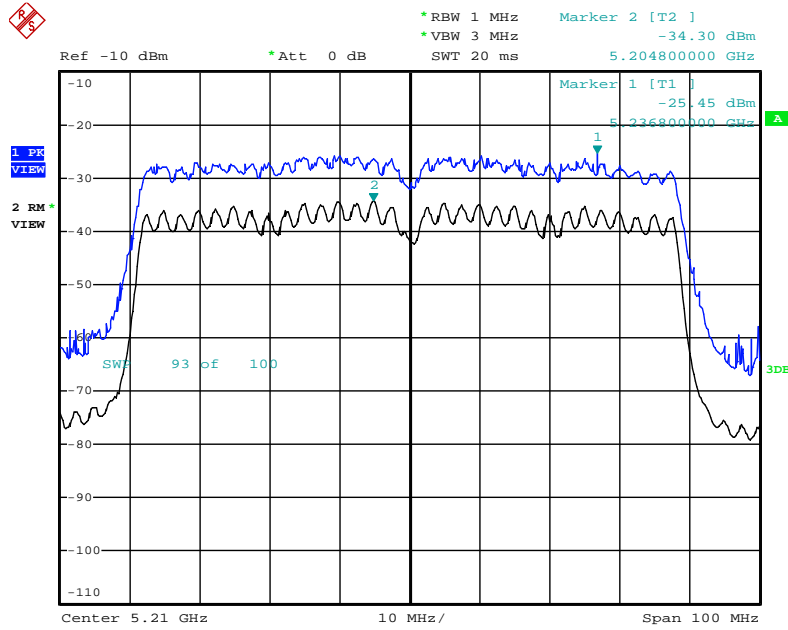

Date: 23.AUG.2012 22:36:23

Peak Excursion Plot on Configuration IEEE 802.11a / Ant. 0 + Ant. 1 / 5200

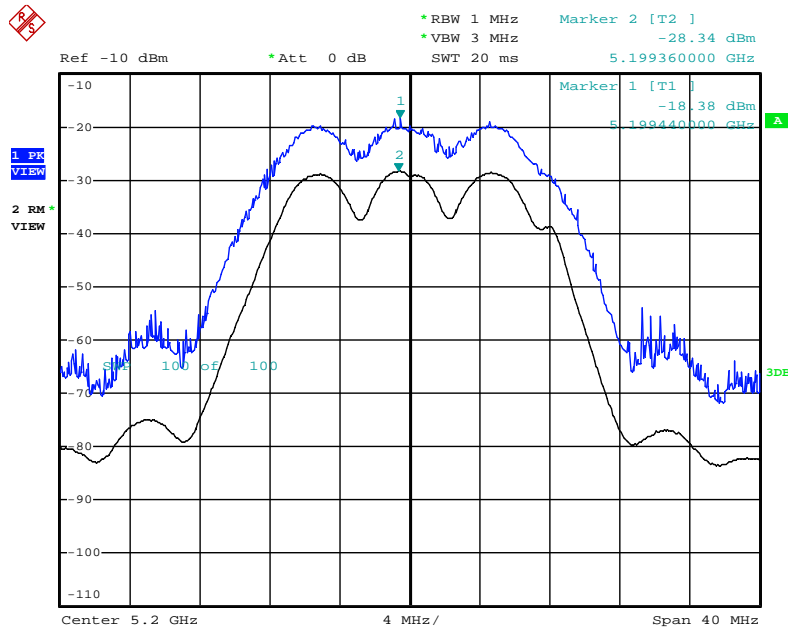

Date: 23.AUG.2012 22:31:15



## 4.6. Radiated Emissions Measurement

### 4.6.1. Limit

For transmitters operating in the 5.15-5.35 GHz band: all emissions outside of the 5.15-5.35 GHz band shall not exceed an EIRP of -27 dBm/MHz (68.3dBuV/m at 3m). For transmitters operating in the.

In addition, In case the emission fall within the restricted band specified on 15.205(a), then the 15.209(a) limit in the table below has to be followed.

Frequencies (MHz)	Field Strength (micorvolts/meter)	Measurement Distance (meters)
0.009~0.490	2400/F(KHz)	300
0.490~1.705	24000/F(KHz)	30
1.705~30.0	30	30
30~88	100	3
88~216	150	3
216~960	200	3
Above 960	500	3

### 4.6.2. Measuring Instruments and Setting

Please refer to section 5 of equipments list in this report. The following table is the setting of spectrum analyzer and receiver.

Spectrum Parameter	Setting
Attenuation	Auto
Start Frequency	1000 MHz
Stop Frequency	40 GHz
RB / VB (Emission in restricted band)	1MHz / 3MHz for Peak, 1 MHz / 10Hz for Average
RB / VB (Emission in non-restricted band)	1MHz / 3MHz for peak

Receiver Parameter	Setting
Attenuation	Auto
Start ~ Stop Frequency	9kHz~150kHz / RB 200Hz for QP
Start ~ Stop Frequency	150kHz~30MHz / RB 9kHz for QP
Start ~ Stop Frequency	30MHz~1000MHz / RB 120kHz for QP

#### 4.6.3. Test Procedures

6. Configure the EUT according to ANSI C63.10. The EUT was placed on the top of the turntable 0.8 meter above ground. The phase center of the receiving antenna mounted on the top of a height-variable antenna tower was placed 3 meters far away from the turntable.
7. Power on the EUT and all the supporting units. The turntable was rotated by 360 degrees to determine the position of the highest radiation.
8. The height of the broadband receiving antenna was varied between one meter and four meters above ground to find the maximum emissions field strength of both horizontal and vertical polarization.
9. For each suspected emissions, the antenna tower was scan (from 1 M to 4 M) and then the turntable was rotated (from 0 degree to 360 degrees) to find the maximum reading.
10. Set the test-receiver system to Peak or CISPR quasi-peak Detect Function with specified bandwidth under Maximum Hold Mode.
11. For emissions above 1GHz, use 1MHz VBW and 3MHz for peak reading. Then 1MHz RBW and 10Hz VBW for average reading in spectrum analyzer.
12. When the radiated emissions limits are expressed in terms of the average value of the emissions, and pulsed operation is employed, the measurement field strength shall be determined by averaging over one complete pulse train, including blanking intervals, as long as the pulse train does not exceed 0.1 seconds. As an alternative (provided the transmitter operates for longer than 0.1 seconds) or in cases where the pulse train exceeds 0.1 seconds, the measured field strength shall be determined from the average absolute voltage during a 0.1 second interval during which the field strength is at its maximum value.
13. If the emissions level of the EUT in peak mode was 3 dB lower than the average limit specified, then testing will be stopped and peak values of EUT will be reported, otherwise, the emissions which do not have 3 dB margin will be repeated one by one using the quasi-peak method for below 1GHz.
14. For testing above 1GHz, the emissions level of the EUT in peak mode was lower than average limit (that means the emissions level in peak mode also complies with the limit in average mode), then testing will be stopped and peak values of EUT will be reported, otherwise, the emissions will be measured in average mode again and reported.
15. In case the emission is lower than 30MHz, loop antenna has to be used for measurement and the recorded data should be QP measured by receiver. High – Low scan is not required in this case.

#### 4.6.4. Test Setup Layout

For radiated emissions below 1GHz

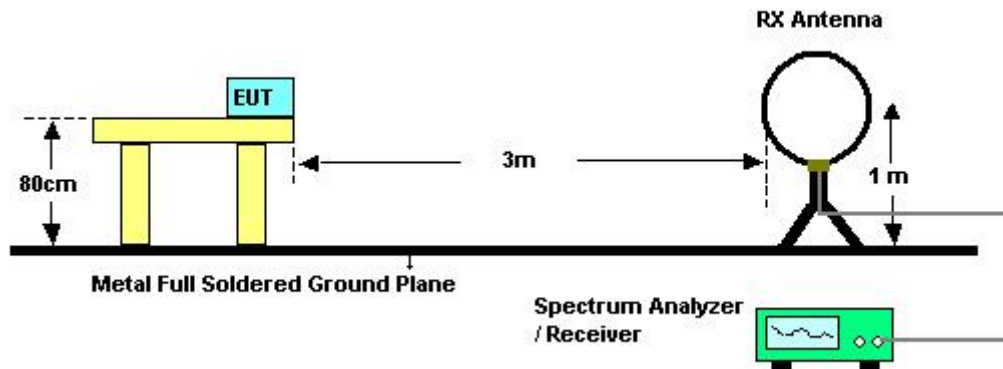

For radiated emissions above 1GHz

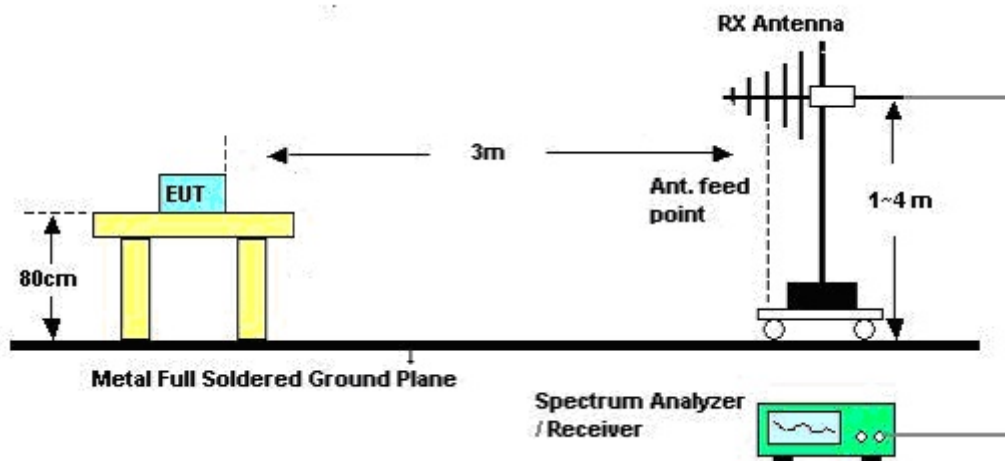

#### 4.6.5. Test Deviation

There is no deviation with the original standard.

#### 4.6.6. EUT Operation during Test

The EUT was programmed to be in continuously transmitting mode.

## 4.6.7. Results of Radiated Emissions (9kHz~30MHz)

Temperature	26°C	Humidity	60%
Test Engineer	Serway Lee	Configurations	Normal Link
Test Date	Sep. 05, 2012		

Freq. (MHz)	Level (dBuV)	Over Limit (dB)	Limit Line (dBuV)	Remark
-	-	-	-	See Note

Note:

The amplitude of spurious emissions that are attenuated by more than 20dB below the permissible value has no need to be reported.

Distance extrapolation factor =  $40 \log (\text{specific distance} / \text{test distance})$  (dB);

Limit line = specific limits (dBuV) + distance extrapolation factor.

4.6.8. Results of Radiated Emissions (30MHz~1GHz)

Temperature	26°C	Humidity	60%
Test Engineer	Wen Chao	Configurations	Normal Link/ Mode 2

Horizontal

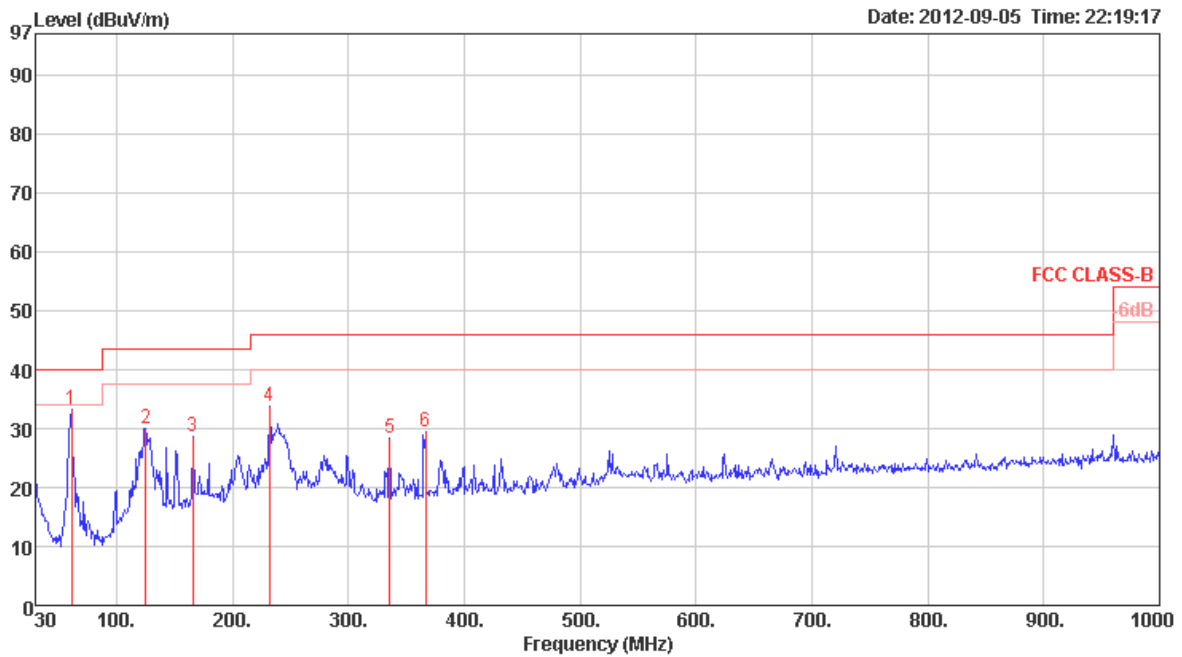

	Freq	Level	Limit Line	Over Limit	Read Level	CableAntenna Loss	Preamp Factor	Preamp Factor	Remark	A/Pos	T/Pos	Pol/Phase	Aux Factor
	MHz	dBuV/m	dBuV/m	dB	dBuV	dB	dB/m	dB		cm	deg		dB
1	61.04	33.18	40.00	-6.82	53.36	0.82	6.76	27.76	Peak	100	0	HORIZONTAL	0.00
2	125.06	30.06	43.50	-13.44	44.08	1.25	12.21	27.48	Peak	100	0	HORIZONTAL	0.00
3	165.80	28.59	43.50	-14.91	41.86	1.53	12.47	27.27	Peak	100	0	HORIZONTAL	0.00
4	231.76	33.79	46.00	-12.21	47.59	1.83	11.41	27.04	Peak	100	0	HORIZONTAL	0.00
5	335.55	28.46	46.00	-17.54	39.11	2.17	14.33	27.15	Peak	100	0	HORIZONTAL	0.00
6	366.59	29.42	46.00	-16.58	39.39	2.23	15.17	27.37	Peak	100	0	HORIZONTAL	0.00

*Vertical*

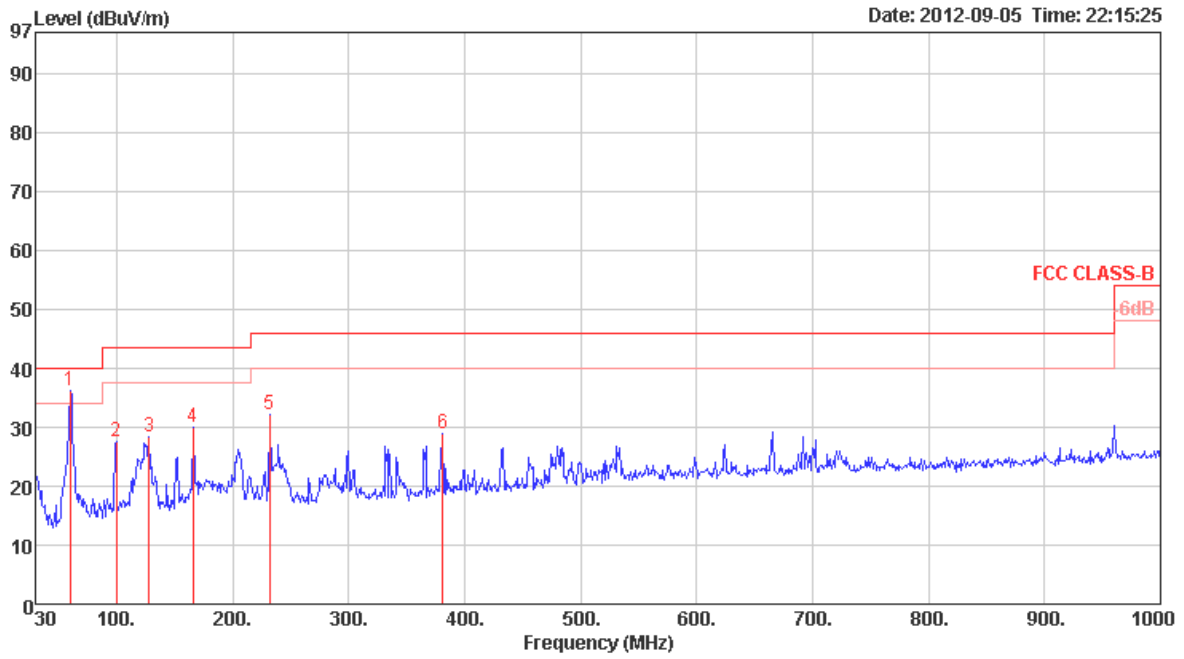

	Freq	Level	Limit Line	Over Limit	Read Level	Cable Loss	Antenna Factor	Preamp Factor	Remark	A/Pos	T/Pos	Aux Factor	
	MHz	dBuV/m	dBuV/m	dB	dBuV	dB	dB/m	dB		cm	deg	dB	
1	60.07	36.31	40.00	-3.69	56.50	0.80	6.77	27.76	Peak	400	0	VERTICAL	0.00
2	99.84	27.49	43.50	-16.01	42.90	1.20	10.99	27.60	Peak	400	0	VERTICAL	0.00
3	127.97	28.31	43.50	-15.19	42.25	1.28	12.24	27.46	Peak	400	0	VERTICAL	0.00
4	165.80	30.12	43.50	-13.38	43.39	1.53	12.47	27.27	Peak	400	0	VERTICAL	0.00
5	231.76	32.28	46.00	-13.72	46.08	1.83	11.41	27.04	Peak	400	0	VERTICAL	0.00
6	381.14	29.04	46.00	-16.96	38.69	2.26	15.56	27.47	Peak	400	0	VERTICAL	0.00

Note:

The amplitude of spurious emissions that are attenuated by more than 20dB below the permissible value has no need to be reported.

Emission level (dBuV/m) = 20 log Emission level (uV/m).

Corrected Reading: Antenna Factor + Cable Loss + Read Level - Preamp Factor = Level.

## 4.6.9. Results for Radiated Emissions (1GHz~40GHz)

Temperature	26°C	Humidity	60%
Test Engineer	Wen Chao	Configurations	IEEE 802.11n MCS0 HT20MHz Ch 36 / Ant. 0 + Ant.1
Test Date	Aug. 23, 2012		

*Horizontal*

	Freq	Level	Limit Line	Over Limit	Read Level	CableAntenna Loss	Antenna Factor	Preamp Factor	Remark	A/Pos	T/Pos	Pol/Phase
	MHz	dBuV/m	dBuV/m	dB	dBuV	dB	dB/m	dB		cm	deg	
1	15538.06	53.28	74.00	-20.72	44.81	6.13	37.65	35.31	Peak	100	189	HORIZONTAL
2	15539.83	39.90	54.00	-14.10	31.43	6.13	37.65	35.31	Average	100	189	HORIZONTAL

*Vertical*

	Freq	Level	Limit Line	Over Limit	Read Level	CableAntenna Loss	Antenna Factor	Preamp Factor	Remark	A/Pos	T/Pos	Pol/Phase
	MHz	dBuV/m	dBuV/m	dB	dBuV	dB	dB/m	dB		cm	deg	
1	15537.59	53.08	74.00	-20.92	44.51	6.13	37.73	35.29	Peak	100	151	VERTICAL
2	15539.45	39.77	54.00	-14.23	31.26	6.13	37.69	35.31	Average	100	151	VERTICAL



<b>Temperature</b>	26°C	<b>Humidity</b>	60%
<b>Test Engineer</b>	Wen Chao	<b>Configurations</b>	IEEE 802.11n MCS0 HT20MHz Ch 40 / Ant. 0 + Ant.1
<b>Test Date</b>	Aug. 23, 2012		

*Horizontal*

	Freq	Level	Limit Line	Over Limit	Read Level	CableAntenna Loss	Antenna Factor	Preamp Factor	Remark	A/Pos	T/Pos	Pol/Phase
	MHz	dBuV/m	dBuV/m	dB	dBuV	dB	dB/m	dB		cm	deg	
1	15598.15	52.97	74.00	-21.03	44.58	6.13	37.60	35.34	Peak	100	33	HORIZONTAL
2	15600.08	38.92	54.00	-15.08	30.53	6.13	37.60	35.34	Average	100	33	HORIZONTAL

*Vertical*

	Freq	Level	Limit Line	Over Limit	Read Level	CableAntenna Loss	Antenna Factor	Preamp Factor	Remark	A/Pos	T/Pos	Pol/Phase
	MHz	dBuV/m	dBuV/m	dB	dBuV	dB	dB/m	dB		cm	deg	
1	15600.22	39.10	54.00	-14.90	30.71	6.13	37.60	35.34	Average	100	93	VERTICAL
2	15601.06	51.82	74.00	-22.18	43.43	6.13	37.60	35.34	Peak	100	93	VERTICAL





<b>Temperature</b>	26°C	<b>Humidity</b>	60%
<b>Test Engineer</b>	Wen Chao	<b>Configurations</b>	IEEE 802.11n MCS0 HT20MHz Ch 48 / Ant. 0 + Ant.1
<b>Test Date</b>	Aug. 23, 2012		

*Horizontal*

	Freq	Level	Limit Line	Over Limit	Read Level	Cable Loss	Antenna Factor	Preamp Factor	Remark	A/Pos	T/Pos	Pol/Phase
	MHz	dBuV/m	dBuV/m	dB	dBuV	dB	dB/m	dB		cm	deg	
1	15720.84	51.55	74.00	-22.45	43.32	6.14	37.48	35.39	Peak	100	176	HORIZONTAL
2	15721.70	38.20	54.00	-15.80	29.97	6.14	37.48	35.39	Average	100	176	HORIZONTAL

*Vertical*

	Freq	Level	Limit Line	Over Limit	Read Level	Cable Loss	Antenna Factor	Preamp Factor	Remark	A/Pos	T/Pos	Pol/Phase
	MHz	dBuV/m	dBuV/m	dB	dBuV	dB	dB/m	dB		cm	deg	
1	15721.41	51.49	74.00	-22.51	43.26	6.14	37.48	35.39	Peak	100	231	VERTICAL
2	15721.71	38.13	54.00	-15.87	29.90	6.14	37.48	35.39	Average	100	231	VERTICAL



<b>Temperature</b>	26°C	<b>Humidity</b>	60%
<b>Test Engineer</b>	Wen Chao	<b>Configurations</b>	IEEE 802.11n MCS0 HT40MHz Ch 38 / Ant. 0 + Ant.1
<b>Test Date</b>	Aug. 23, 2012		

*Horizontal*

	Freq	Level	Limit Line	Over Limit	Read Level	CableAntenna Loss	Antenna Factor	Preamp Factor	Remark	A/Pos	T/Pos	Pol/Phase
	MHz	dBuV/m	dBuV/m	dB	dBuV	dB	dB/m	dB		cm	deg	
1	15568.43	52.53	74.00	-21.47	44.10	6.13	37.63	35.33	Peak	100	219	HORIZONTAL
2	15570.44	39.38	54.00	-14.62	30.95	6.13	37.63	35.33	Average	100	219	HORIZONTAL

*Vertical*

	Freq	Level	Limit Line	Over Limit	Read Level	CableAntenna Loss	Antenna Factor	Preamp Factor	Remark	A/Pos	T/Pos	Pol/Phase
	MHz	dBuV/m	dBuV/m	dB	dBuV	dB	dB/m	dB		cm	deg	
1	15570.74	39.49	54.00	-14.51	31.04	6.13	37.65	35.33	Average	100	312	VERTICAL
2	15571.95	52.25	74.00	-21.75	43.84	6.13	37.61	35.33	Peak	100	312	VERTICAL



<b>Temperature</b>	26°C	<b>Humidity</b>	60%
<b>Test Engineer</b>	Wen Chao	<b>Configurations</b>	IEEE 802.11n MCS0 HT40MHz Ch 46 / Ant. 0 + Ant.1
<b>Test Date</b>	Aug. 23, 2012		

*Horizontal*

	Freq	Level	Limit Line	Over Limit	Read Level	CableAntenna Loss	Antenna Factor	Preamp Factor	Remark	A/Pos	T/Pos	Pol/Phase
	MHz	dBuV/m	dBuV/m	dB	dBuV	dB	dB/m	dB		cm	deg	
1	15689.38	39.17	54.00	-14.83	30.89	6.14	37.51	35.37	Average	100	135	HORIZONTAL
2	15689.58	51.81	74.00	-22.19	43.53	6.14	37.51	35.37	Peak	100	135	HORIZONTAL

*Vertical*

	Freq	Level	Limit Line	Over Limit	Read Level	CableAntenna Loss	Antenna Factor	Preamp Factor	Remark	A/Pos	T/Pos	Pol/Phase
	MHz	dBuV/m	dBuV/m	dB	dBuV	dB	dB/m	dB		cm	deg	
1	15689.44	52.00	74.00	-22.00	43.72	6.14	37.51	35.37	Peak	100	200	VERTICAL
2	15692.28	38.86	54.00	-15.14	30.61	6.14	37.49	35.38	Average	100	200	VERTICAL



<b>Temperature</b>	26°C	<b>Humidity</b>	60%
<b>Test Engineer</b>	Wen Chao	<b>Configurations</b>	IEEE 802.11ac MCS0 VHT80MHz Ch 42 / Ant. 0 + Ant.1
<b>Test Date</b>	Aug. 23, 2012		

*Horizontal*

	Freq	Level	Limit Line	Over Limit	Read Level	CableAntenna Loss	Antenna Factor	Preamp Factor	Remark	A/Pos	T/Pos	Pol/Phase
	MHz	dBuV/m	dBuV/m	dB	dBuV	dB	dB/m	dB		cm	deg	
1	15633.52	51.74	74.00	-22.26	43.39	6.14	37.56	35.35	Peak	100	205	HORIZONTAL
2	15638.72	38.80	54.00	-15.20	30.45	6.14	37.56	35.35	Average	100	205	HORIZONTAL

*Vertical*

	Freq	Level	Limit Line	Over Limit	Read Level	CableAntenna Loss	Antenna Factor	Preamp Factor	Remark	A/Pos	T/Pos	Pol/Phase
	MHz	dBuV/m	dBuV/m	dB	dBuV	dB	dB/m	dB		cm	deg	
1	15625.84	39.01	54.00	-14.99	30.66	6.14	37.56	35.35	Average	100	296	VERTICAL
2	15637.48	51.77	74.00	-22.23	43.42	6.14	37.56	35.35	Peak	100	296	VERTICAL



<b>Temperature</b>	26°C	<b>Humidity</b>	60%
<b>Test Engineer</b>	Wen Chao	<b>Configurations</b>	IEEE 802.11a Ch 36 / Ant. 0 + Ant.1
<b>Test Date</b>	Aug. 23, 2012		

*Horizontal*

	Freq	Level	Limit Line	Over Limit	Read Level	CableAntenna Loss	Antenna Factor	Preamp Factor	Remark	A/Pos	T/Pos	Pol/Phase
	MHz	dBuV/m	dBuV/m	dB	dBuV	dB	dB/m	dB		cm	deg	
1	15535.76	54.03	74.00	-19.97	45.52	6.13	37.67	35.29	Peak	100	304	HORIZONTAL
2	15544.66	39.64	54.00	-14.36	31.17	6.13	37.65	35.31	Average	100	304	HORIZONTAL

*Vertical*

	Freq	Level	Limit Line	Over Limit	Read Level	CableAntenna Loss	Antenna Factor	Preamp Factor	Remark	A/Pos	T/Pos	Pol/Phase
	MHz	dBuV/m	dBuV/m	dB	dBuV	dB	dB/m	dB		cm	deg	
1	15535.66	53.07	74.00	-20.93	44.50	6.13	37.73	35.29	Peak	100	332	VERTICAL
2	15536.74	40.20	54.00	-13.80	31.63	6.13	37.73	35.29	Average	100	332	VERTICAL



Temperature	26°C	Humidity	60%
Test Engineer	Wen Chao	Configurations	IEEE 802.11a Ch 40 / Ant. 0 + Ant.1
Test Date	Aug. 23, 2012		

*Horizontal*

	Freq	Level	Limit Line	Over Limit	Read Level	CableAntenna Loss	Antenna Factor	Preamp Factor	Remark	A/Pos	T/Pos	Pol/Phase
	MHz	dBuV/m	dBuV/m	dB	dBuV	dB	dB/m	dB		cm	deg	
1	15598.02	39.24	54.00	-14.76	30.85	6.13	37.60	35.34	Average	100	283	HORIZONTAL
2	15601.62	52.20	74.00	-21.80	43.81	6.13	37.60	35.34	Peak	100	283	HORIZONTAL

*Vertical*

	Freq	Level	Limit Line	Over Limit	Read Level	CableAntenna Loss	Antenna Factor	Preamp Factor	Remark	A/Pos	T/Pos	Pol/Phase
	MHz	dBuV/m	dBuV/m	dB	dBuV	dB	dB/m	dB		cm	deg	
1	15599.81	39.16	54.00	-14.84	30.77	6.13	37.60	35.34	Average	100	259	VERTICAL
2	15602.48	52.67	74.00	-21.33	44.28	6.13	37.60	35.34	Peak	100	259	VERTICAL

<b>Temperature</b>	26°C	<b>Humidity</b>	60%
<b>Test Engineer</b>	Wen Chao	<b>Configurations</b>	IEEE 802.11a Ch 48 / Ant. 0 + Ant.1
<b>Test Date</b>	Jul. 05, 2012		

### Horizontal

	Freq	Level	Limit Line	Over Limit	Read Level	CableAntenna Loss	Antenna Factor	Preamp Factor	Remark	A/Pos	T/Pos	Pol/Phase
	MHz	dBuV/m	dBuV/m	dB	dBuV	dB	dB/m	dB		cm	deg	
1	15718.14	51.56	74.00	-22.44	43.33	6.14	37.48	35.39	Peak	100	221	HORIZONTAL
2	15718.57	38.04	54.00	-15.96	29.81	6.14	37.48	35.39	Average	100	221	HORIZONTAL

### Vertical

	Freq	Level	Limit Line	Over Limit	Read Level	CableAntenna Loss	Antenna Factor	Preamp Factor	Remark	A/Pos	T/Pos	Pol/Phase
	MHz	dBuV/m	dBuV/m	dB	dBuV	dB	dB/m	dB		cm	deg	
1	15720.43	38.09	54.00	-15.91	29.86	6.14	37.48	35.39	Average	100	259	VERTICAL
2	15720.72	50.99	74.00	-23.01	42.76	6.14	37.48	35.39	Peak	100	259	VERTICAL

### Note:

The amplitude of spurious emissions that are attenuated by more than 20dB below the permissible value has no need to be reported.

Emission level (dBuV/m) = 20 log Emission level (uV/m).

Corrected Reading: Antenna Factor + Cable Loss + Read Level - Preamp Factor = Level.

## 4.7. Band Edge Emissions Measurement

### 4.7.1. Limit

For transmitters operating in the 5.15-5.35 GHz band: all emissions outside of the 5.15-5.35 GHz band shall not exceed an EIRP of -27 dBm/MHz (68.3dBuV/m at 3m). For transmitters operating in the 5.470-5.725 GHz band: all emissions outside of the 5.470-5.725 GHz band shall not exceed an EIRP of -27 dBm/MHz (68.3dBuV/m at 3m). For transmitters operating in the 5.725-5.825 GHz band: all emissions within the frequency range from the band edge to 10 MHz above or below the band edge shall not exceed an EIRP of -17 dBm/MHz (78.3dBuV/m at 3m); for frequencies 10 MHz or greater above or below the band edge, emissions shall not exceed an EIRP of -27 dBm/MHz (68.3dBuV/m at 3m). In addition, In case the emission fall within the restricted band specified on 15.205(a), then the 15.209(a) limit in the table below has to be followed.

Frequencies (MHz)	Field Strength (micorvolts/meter)	Measurement Distance (meters)
0.009~0.490	2400/F(KHz)	300
0.490~1.705	24000/F(KHz)	30
1.705~30.0	30	30
30~88	100	3
88~216	150	3
216~960	200	3
Above 960	500	3

### 4.7.2. Measuring Instruments and Setting

Please refer to section 5 of equipments list in this report. The following table is the setting of the spectrum analyzer.

Spectrum Parameter	Setting
Attenuation	Auto
Span Frequency	100 MHz
RB / VB (Emission in restricted band)	1MHz / 3MHz for Peak, 1 MHz / 10Hz for Average
RB / VB (Emission in non-restricted band)	1MHz / 3MHz for Peak

### 4.7.3. Test Procedures

16. The test procedure is the same as section 4.6.3, only the frequency range investigated is limited to 100MHz around bandedges.
17. In case the emission is fail due to the used RB/VB is too wide, marker-delta method of FCC Public Notice DA00-705 will be followed.



#### 4.7.4. Test Setup Layout

This test setup layout is the same as that shown in section 4.6.4.

#### 4.7.5. Test Deviation

There is no deviation with the original standard.

#### 4.7.6. EUT Operation during Test

The EUT was programmed to be in continuously transmitting mode.

## 4.7.7. Test Result of Band Edge and Fundamental Emissions

Temperature	26°C	Humidity	60%
Test Engineer	Wen Chao	Configurations	IEEE 802.11n MCS0 20MHz Ch 36, 40, 48 /Ant. 0 + Ant. 1
Test Date	Aug. 20, 2012		

## Channel 36

	Freq	Level	Limit Line	Over Limit	Read Level	Cable Loss	Antenna Factor	Preamp Factor	Remark	A/Pos	T/Pos	Pol/Phase
	MHz	dBuV/m	dBuV/m	dB	dBuV	dB	dB/m	dB		cm	deg	
1	5108.33	50.99	54.00	-3.01	13.99	3.42	33.58	0.00	Average	100	80	VERTICAL
2	5108.33	60.83	74.00	-13.17	23.83	3.42	33.58	0.00	Peak	100	80	VERTICAL
3	5176.80	109.13				3.44	33.70	0.00	Peak	100	80	VERTICAL
4	5178.40	98.20				3.44	33.73	0.00	Average	100	80	VERTICAL

Item 3, 4 are the fundamental frequency at 5180 MHz.

## Channel 40

	Freq	Level	Limit Line	Over Limit	Read Level	Cable Loss	Antenna Factor	Preamp Factor	Remark	A/Pos	T/Pos	Pol/Phase
	MHz	dBuV/m	dBuV/m	dB	dBuV	dB	dB/m	dB		cm	deg	
1	4766.35	52.84	54.00	-1.16	16.64	3.28	32.92	0.00	Average	109	80	VERTICAL
2	4767.95	58.95	74.00	-15.05	22.75	3.28	32.92	0.00	Peak	109	80	VERTICAL
3	5191.99	105.57				.44	33.73	0.00	Peak	109	80	VERTICAL
4	5196.80	96.90				.45	33.76	0.00	Average	109	80	VERTICAL

Item 3, 4 are the fundamental frequency at 5200 MHz.

## Channel 48

	Freq	Level	Limit Line	Over Limit	Read Level	Cable Loss	Antenna Factor	Preamp Factor	Remark	A/Pos	T/Pos	Pol/Phase
	MHz	dBuV/m	dBuV/m	dB	dBuV	dB	dB/m	dB		cm	deg	
1	4802.24	61.13	74.00	-12.87	24.85	3.29	32.99	0.00	Peak	103	94	VERTICAL
2	4803.21	52.99	54.00	-1.01	16.68	3.29	33.02	0.00	Average	103	94	VERTICAL
3	5243.21	100.84				3.46	33.82	0.00	Average	103	94	VERTICAL
4	5244.81	111.46				3.46	33.82	0.00	Peak	103	94	VERTICAL

Item 3, 4 are the fundamental frequency at 5240 MHz.

<b>Temperature</b>	26°C	<b>Humidity</b>	60%
<b>Test Engineer</b>	Wen Chao	<b>Configurations</b>	IEEE 802.11n MCS0 40MHz Ch 38, 46 / Ant. 0 + Ant. 1
<b>Test Date</b>	Aug. 20, 2012		

### Channel 38

	Freq	Level	Limit Line	Over Limit	Read Level	CableAntenna Loss Factor	Preamp Factor	Remark	A/Pos	T/Pos	Pol/Phase
	MHz	dBuV/m	dBuV/m	dB	dBuV	dB	dB/m	dB	cm	deg	
1	5029.81	51.75	54.00	-2.25	14.89	3.40	33.46	0.00 Average	100	81	VERTICAL
2	5150.00	63.62	74.00	-10.38	26.52	3.43	33.67	0.00 Peak	100	81	VERTICAL
3	5185.19	94.91				3.44	33.73	0.00 Average	100	81	VERTICAL
4	5194.81	106.56				3.45	33.76	0.00 Peak	100	81	VERTICAL

Item 3, 4 are the fundamental frequency at 5190 MHz.

### Channel 46

	Freq	Level	Limit Line	Over Limit	Read Level	CableAntenna Loss Factor	Preamp Factor	Remark	A/Pos	T/Pos	Pol/Phase
	MHz	dBuV/m	dBuV/m	dB	dBuV	dB	dB/m	dB	cm	deg	
1	4794.23	48.95	54.00	-5.05	12.67	3.29	32.99	0.00 Average	100	2	HORIZONTAL
2	4794.23	54.60	74.00	-19.40	18.32	3.29	32.99	0.00 Peak	100	2	HORIZONTAL
3	5234.81	90.99				3.46	33.82	0.00 Average	100	2	HORIZONTAL
4	5234.81	101.78				3.46	33.82	0.00 Peak	100	2	HORIZONTAL

Item 3, 4 are the fundamental frequency at 5230 MHz.

Note:

Emission level (dBuV/m) = 20 log Emission level (uV/m)

Corrected Reading: Antenna Factor + Cable Loss + Read Level - Preamp Factor = Level



Temperature	26°C	Humidity	60%
Test Engineer	Wen Chao	Configurations	IEEE 802.11a Ch 36, 40, 48 / Ant. 0 + Ant. 1
Test Date	Aug. 20, 2012		

**Channel 36**

	Freq	Level	Limit Line	Over Limit	Read Level	CableAntenna Loss	Antenna Factor	Preamp Factor	Remark	A/Pos	T/Pos	Pol/Phase
	MHz	dBuV/m	dBuV/m	dB	dBuV	dB	dB/m	dB		cm	deg	
1	5020.19	52.38	54.00	-1.62	15.55	3.40	33.43	0.00	Average	100	80	VERTICAL
2	5021.80	60.47	74.00	-13.53	23.64	3.40	33.43	0.00	Peak	100	80	VERTICAL
3	5176.80	109.62				.44	33.70	0.00	Peak	100	80	VERTICAL
4	5180.00	99.66				.44	33.73	0.00	Average	100	80	VERTICAL

Item 3, 4 are the fundamental frequency at 5180 MHz.

**Channel 40**

	Freq	Level	Limit Line	Over Limit	Read Level	CableAntenna Loss	Antenna Factor	Preamp Factor	Remark	A/Pos	T/Pos	Pol/Phase
	MHz	dBuV/m	dBuV/m	dB	dBuV	dB	dB/m	dB		cm	deg	
1	4766.35	52.75	54.00	-1.25	16.55	3.28	32.92	0.00	Average	100	80	VERTICAL
2	4767.95	61.10	74.00	-12.90	24.90	3.28	32.92	0.00	Peak	100	80	VERTICAL
3	5195.19	97.80				.45	33.76	0.00	Average	100	80	VERTICAL
4	5195.19	107.41				.45	33.76	0.00	Peak	100	80	VERTICAL

Item 3, 4 are the fundamental frequency at 5200 MHz.

**Channel 48**

	Freq	Level	Limit Line	Over Limit	Read Level	CableAntenna Loss	Antenna Factor	Preamp Factor	Remark	A/Pos	T/Pos	Pol/Phase
	MHz	dBuV/m	dBuV/m	dB	dBuV	dB	dB/m	dB		cm	deg	
1	4802.24	62.17	74.00	-11.83	25.89	3.29	32.99	0.00	Peak	103	94	VERTICAL
2	4803.21	53.00	54.00	-1.00	16.69	3.29	33.02	0.00	Average	103	94	VERTICAL
3	5240.00	102.41				.46	33.82	0.00	Average	103	94	VERTICAL
4	5241.60	111.23				.46	33.82	0.00	Peak	103	94	VERTICAL

Item 3, 4 are the fundamental frequency at 5240 MHz.

Temperature	26°C	Humidity	60%
Test Engineer	Wen Chao	Configurations	IEEE 802.11ac MCS0 VHT20MHz Ch 36, 40, 48 / Ant. 0 + Ant. 1
Test Date	Aug. 20, 2012		

### Channel 36

	Freq	Level	Limit	Over	Read	CableAntenna	Preamp	Remark	A/Pos	T/Pos	Pol/Phase
	MHz	dBuV/m	dBuV/m	dB	dBuV	dB	dB/m	dB	cm	deg	
1	4748.11	52.70	54.00	-1.30	16.55	3.27	32.88	0.00	Average	100	77 VERTICAL
2	4749.36	59.35	74.00	-14.65	23.20	3.27	32.88	0.00	Peak	100	77 VERTICAL
3	5176.80	95.79				3.44	33.70	0.00	Average	100	77 VERTICAL
4	5178.40	107.12				3.44	33.73	0.00	Peak	100	77 VERTICAL

Item 3, 4 are the fundamental frequency at 5180 MHz.

### Channel 40

	Freq	Level	Limit	Over	Read	CableAntenna	Preamp	Remark	A/Pos	T/Pos	Pol/Phase
	MHz	dBuV/m	dBuV/m	dB	dBuV	dB	dB/m	dB	cm	deg	
1	4765.39	52.94	54.00	-1.06	16.74	3.28	32.92	0.00	Average	105	95 VERTICAL
2	4767.95	61.11	74.00	-12.89	24.91	3.28	32.92	0.00	Peak	105	95 VERTICAL
3	5195.19	108.86				3.45	33.76	0.00	Peak	105	95 VERTICAL
4	5196.80	98.69				3.45	33.76	0.00	Average	105	95 VERTICAL

Item 3, 4 are the fundamental frequency at 5200 MHz.

### Channel 48

	Freq	Level	Limit	Over	Read	CableAntenna	Preamp	Remark	A/Pos	T/Pos	Pol/Phase
	MHz	dBuV/m	dBuV/m	dB	dBuV	dB	dB/m	dB	cm	deg	
1	4803.21	52.31	54.00	-1.69	16.00	3.29	33.02	0.00	Average	103	94 VERTICAL
2	4803.21	60.73	74.00	-13.27	24.42	3.29	33.02	0.00	Peak	103	94 VERTICAL
3	5243.21	100.36				3.46	33.82	0.00	Average	103	94 VERTICAL
4	5243.21	110.79				3.46	33.82	0.00	Peak	103	94 VERTICAL

Item 3, 4 are the fundamental frequency at 5240 MHz.

Note:

Emission level (dBuV/m) = 20 log Emission level (uV/m)

Corrected Reading: Antenna Factor + Cable Loss + Read Level - Preamp Factor = Level

Temperature	26°C	Humidity	60%
Test Engineer	Wen Chao	Configurations	IEEE 802.11ac MCS0 VHT40MHz Ch 38, 46 / Ant. 0 + Ant. 1
Test Date	Aug. 20, 2012		

### Channel 38

	Freq	Level	Limit Line	Over Limit	Read Level	CableAntenna Loss	Antenna Factor	Preamp Factor	Remark	A/Pos	T/Pos	Pol/Phase
	MHz	dBuV/m	dBuV/m	dB	dBuV	dB	dB/m	dB		cm	deg	
1	5029.81	52.20	54.00	-1.80	15.34	3.40	33.46	0.00	Average	100	81	VERTICAL
2	5150.00	66.60	74.00	-7.40	29.50	3.43	33.67	0.00	Peak	100	81	VERTICAL
3	5185.19	94.85				3.44	33.73	0.00	Average	100	81	VERTICAL
4	5194.81	106.60				3.45	33.76	0.00	Peak	100	81	VERTICAL

Item 3, 4 are the fundamental frequency at 5190 MHz.

### Channel 46

	Freq	Level	Limit Line	Over Limit	Read Level	CableAntenna Loss	Antenna Factor	Preamp Factor	Remark	A/Pos	T/Pos	Pol/Phase
	MHz	dBuV/m	dBuV/m	dB	dBuV	dB	dB/m	dB		cm	deg	
1	5069.87	50.86	54.00	-3.14	13.93	3.41	33.52	0.00	Average	100	74	VERTICAL
2	5069.87	57.84	74.00	-16.16	20.91	3.41	33.52	0.00	Peak	100	74	VERTICAL
3	5234.81	96.79				3.46	33.82	0.00	Average	100	74	VERTICAL
4	5234.81	107.56				3.46	33.82	0.00	Peak	100	74	VERTICAL

Item 3, 4 are the fundamental frequency at 5230 MHz.

Note:

Emission level (dBuV/m) = 20 log Emission level (uV/m)

Corrected Reading: Antenna Factor + Cable Loss + Read Level - Preamp Factor = Level

<b>Temperature</b>	26°C	<b>Humidity</b>	60%
<b>Test Engineer</b>	Wen Chao	<b>Configurations</b>	IEEE 802.11ac MCS0 VHT80MHz Ch 42 / Ant. 0 + Ant. 1
<b>Test Date</b>	Aug. 20, 2012		

### Channel 42

	Freq	Level	Limit Line	Over Limit	Read Level	Cable Loss	Antenna Factor	Preamp Factor	Remark	A/Pos	T/Pos	Pol/Phase
	MHz	dBuV/m	dBuV/m	dB	dBuV	dB	dB/m	dB		cm	deg	
1	5137.18	66.28	74.00	-7.72	29.21	3.43	33.64	0.00	Peak	100	271	VERTICAL
2	5145.19	51.38	54.00	-2.62	14.28	3.43	33.67	0.00	Average	100	271	VERTICAL
3	5180.35	102.77				3.44	33.73	0.00	Peak	100	271	VERTICAL
4	5185.16	90.11				3.44	33.73	0.00	Average	100	271	VERTICAL

Item 3, 4 are the fundamental frequency at 5210 MHz.

Note:

Emission level (dBuV/m) = 20 log Emission level (uV/m)

Corrected Reading: Antenna Factor + Cable Loss + Read Level - Preamp Factor = Level

## 4.8. Frequency Stability Measurement

### 4.8.1. Limit

Manufacturers of U-NII devices are responsible for ensuring frequency stability such that an emissions is maintained within the band of operation under all conditions of normal operation as specified in the user’s manual or  $\pm 20\text{ppm}$  (IEEE 802.11nspecification).

### 4.8.2. Measuring Instruments and Setting

Please refer to section 5 of equipments list in this report. The following table is the setting of the spectrum analyzer.

Spectrum Parameter	Setting
Attenuation	Auto
Span Frequency	Entire absence of modulation emissions bandwidth
RB	10 kHz
VB	10 kHz
Sweep Time	Auto

### 4.8.3. Test Procedures

1. The transmitter output (antenna port) was connected to the spectrum analyzer.
2. EUT have transmitted absence of modulation signal and fixed channelize.
3. Set the spectrum analyzer span to view the entire absence of modulation emissions bandwidth.
4. Set RBW = 10 kHz, VBW = 10 kHz with peak detector and maxhold settings.
5.  $f_c$  is declaring of channel frequency. Then the frequency error formula is  $(f_c - f) / f_c \times 10^6$  ppm and the limit is less than  $\pm 20\text{ppm}$  (IEEE 802.11nspecification).
6. The test extreme voltage is to change the primary supply voltage from 85 to 115 percent of the nominal value
7. Extreme temperature rule is  $-30^\circ\text{C} \sim 50^\circ\text{C}$ .

### 4.8.4. Test Setup Layout

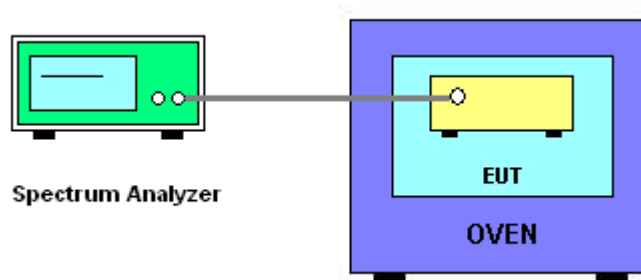



#### 4.8.5. Test Deviation

There is no deviation with the original standard.

#### 4.8.6. EUT Operation during Test

The EUT was programmed to be in continuously un-modulation transmitting mode.

#### 4.8.7. Test Result of Frequency Stability

##### Voltage vs. Frequency Stability

Voltage	Measurement Frequency (MHz)
(V)	<b>5200</b>
126.50	5200.0010
110.00	5200.0028
93.50	5200.0032
Max. Deviation (MHz)	0.003200
Max. Deviation (ppm)	<b>0.62</b>

##### Temperature vs. Frequency Stability

Temperature	Measurement Frequency (MHz)
(°C)	<b>5200</b>
-30	5200.0112
-20	5200.0103
-10	5200.0088
0	5200.0046
10	5199.9963
20	5199.9942
30	5199.9938
40	5199.9929
50	5199.9912
Max. Deviation (MHz)	0.011200
Max. Deviation (ppm)	<b>2.15</b>

## 4.9. Antenna Requirements

### 4.9.1. Limit

Except for special regulations, the Low-power Radio-frequency Devices must not be equipped with any jacket for installing an antenna with extension cable. An intentional radiator shall be designed to ensure that no antenna other than that furnished by the responsible party shall be used with the device. The use of a permanently attached antenna or of an antenna that uses a unique coupling to the intentional radiator shall be considered sufficient to comply with the provisions of this Section. The manufacturer may design the unit so that the user can replace a broken antenna, but the use of a standard antenna jack or electrical connector is prohibited. Further, this requirement does not apply to intentional radiators that must be professionally installed.

### 4.9.2. Antenna Connector Construction

Please refer to section 3.3 in this test report; antenna connector complied with the requirements.

## 5. LIST OF MEASURING EQUIPMENTS

Instrument	Manufacturer	Model No.	Serial No.	Characteristics	Calibration Date	Remark
EMI Test Receiver	R&S	ESCS 30	100377	9kHz ~ 2.75GHz	Sep. 14, 2011	Conduction (CO01-CB)
LISN	F.C.C.	FCC-LISN-50-16-2	04083	150kHz ~ 100MHz	Nov. 14, 2011	Conduction (CO01-CB)
V- LISN	Schwarzbeck	NSLK 8127	8127-478	9K ~ 30MHz	Nov. 30, 2011	Conduction (CO01-CB)
PULSE LIMITER	R&S	ESH3-Z2	100430	9K-30MHz	Feb. 03, 2012	Conduction (CO01-CB)
COND Cable	Woken	Cable	01	0.15MHz~30MHz	Dec. 4, 2011	Conduction (CO01-CB)
BILOG ANTENNA	Schaffner	CBL6112D	22021	20MHz ~ 2GHz	Jan. 11, 2012	Radiation (03CH01-CB)
Horn Antenna	EMCO	3115	00075790	750MHz~18GHz	Nov. 25, 2011	Radiation (03CH01-CB)
Horn Antenna	SCHWARZBEAK	BBHA 9170	BBHA9170252	15GHz ~ 40GHz	Nov. 22, 2011	Radiation (03CH01-CB)
Pre-Amplifier	Agilent	8447D	2944A10991	0.1MHz ~ 1.3GHz	Nov. 17, 2011	Radiation (03CH01-CB)
Pre-Amplifier	Agilent	8449B	3008A02310	1GHz ~ 26.5GHz	Nov. 29, 2011	Radiation (03CH01-CB)
Pre-Amplifier	WM	TF-130N-R1	923365	26.5GHz ~ 40GHz	Nov. 17, 2011	Radiation (03CH01-CB)
Spectrum analyzer	R&S	FSP40	100056	9KHz~40GHz	Nov. 03, 2011	Radiation (03CH01-CB)
EMI Test Receiver	R&S	ESCS 30	100355	9KHz ~ 2.75GHz	Mar. 20, 2012	Radiation (03CH01-CB)
Loop Antenna	Teseq	HLA 6120	24155	9 kHz - 30 MHz	Sep. 09, 2011	Radiation (03CH01-CB)
Turn Table	INN CO	CO 2000	N/A	0 ~ 360 degree	N/A	Radiation (03CH01-CB)
Antenna Mast	INN CO	CO2000	N/A	1 m - 4 m	N/A	Radiation (03CH01-CB)
RF Cable-low	Woken	Low Cable-1	N/A	30 MHz - 1 GHz	Nov. 17, 2011	Radiation (03CH01-CB)
RF Cable-high	Woken	High Cable-1	N/A	1 GHz – 26.5 GHz	Nov. 17, 2011	Radiation (03CH01-CB)
RF Cable-high	Woken	High Cable-2	N/A	1 GHz – 26.5 GHz	Nov. 17, 2011	Radiation (03CH01-CB)
RF Cable-high	Woken	High Cable-3	N/A	1 GHz - 40 GHz	Nov. 17, 2011	Radiation (03CH01-CB)
RF Cable-high	Woken	High Cable-4	N/A	1 GHz - 40 GHz	Nov. 17, 2011	Radiation (03CH01-CB)
Signal analyzer	R&S	FSV40	100979	9KHz~40GHz	Sep. 26, 2011	Conducted (TH01-CB)

Instrument	Manufacturer	Model No.	Serial No.	Characteristics	Calibration Date	Remark
Temp. and Humidity Chamber	Ten Billion	TTH-D3SP	TBN-931011	-30~100 degree	May 20, 2012	Conducted (TH01-CB)
Thermo-Hygro Meter	N/A	HC 520	#1	15~70 degree	Nov. 02, 2011	Conducted (TH01-CB)
Signal Generator	R&S	SMR40	100302	10MHz-40GHz	Nov. 22, 2011	Conducted (TH01-CB)
RF Power Divider	HP	11636A	00306	2GHz ~ 18GHz	N/A	Conducted (TH01-CB)
RF Power Splitter	Anaren	44100	1839	2GHz ~ 18GHz	N/A	Conducted (TH01-CB)
RF Power Splitter	Anaren	42100	17930	2GHz ~ 18GHz	N/A	Conducted (TH01-CB)
RF Cable-high	Woken	High Cable-7	-	1 GHz – 26.5 GHz	Nov. 17, 2011	Conducted (TH01-CB)
RF Cable-high	Woken	High Cable-8	-	1 GHz – 26.5 GHz	Nov. 17, 2011	Conducted (TH01-CB)
RF Cable-high	Woken	High Cable-9	-	1 GHz – 26.5 GHz	Nov. 17, 2011	Conducted (TH01-CB)
RF Cable-high	Woken	High Cable-10	-	1 GHz – 26.5 GHz	Nov. 17, 2011	Conducted (TH01-CB)
RF Cable-high	Woken	High Cable-11	-	1 GHz – 26.5 GHz	Nov. 17, 2011	Conducted (TH01-CB)
RF Cable-high	Woken	High Cable-12	-	1 GHz – 26.5 GHz	Nov. 17, 2011	Conducted (TH01-CB)
RF Cable-high	Woken	High Cable-13	-	1 GHz – 26.5 GHz	Nov. 17, 2011	Conducted (TH01-CB)
Power Sensor	Anritsu	MA2411B	0917223	300MHz~40GHz	Nov. 01, 2011	Conducted (TH01-CB)
Power Meter	Anritsu	ML2495A	1035008	300MHz~40GHz	Nov. 01, 2011	Conducted (TH01-CB)

Note: Calibration Interval of instruments listed above is one year.

“\*” Calibration Interval of instruments listed above is two years.

NCR means Non-Calibration required.

## 6. TEST LOCATION

SHIJR	ADD : 6Fl., No. 106, Sec. 1, Shintai 5th Rd., Shijr City, Taipei, Taiwan 221, R.O.C. TEL : 886-2-2696-2468 FAX : 886-2-2696-2255
HWA YA	ADD : No. 52, Hwa Ya 1st Rd., Kwei-Shan Hsiang, Tao Yuan Hsien, Taiwan, R.O.C. TEL : 886-3-327-3456 FAX : 886-3-318-0055
LINKOU	ADD : No. 30-2, Dingfu Tsuen, Linkou Shiang, Taipei, Taiwan 244, R.O.C TEL : 886-2-2601-1640 FAX : 886-2-2601-1695
DUNGHU	ADD : No. 3, Lane 238, Kangle St., Neihu Chiu, Taipei, Taiwan 114, R.O.C. TEL : 886-2-2631-4739 FAX : 886-2-2631-9740
JUNGHE	ADD : 7Fl., No. 758, Jungjeng Rd., Junghe City, Taipei, Taiwan 235, R.O.C. TEL : 886-2-8227-2020 FAX : 886-2-8227-2626
NEIHU	ADD : 4Fl., No. 339, Hsin Hu 2 <sup>nd</sup> Rd., Taipei 114, Taiwan, R.O.C. TEL : 886-2-2794-8886 FAX : 886-2-2794-9777
JHUBEI	ADD : No.8, Lane 724, Bo-ai St., Jhubei City, HsinChu County 302, Taiwan, R.O.C. TEL : 886-3-656-9065 FAX : 886-3-656-9085

## 7. TAF CERTIFICATE OF ACCREDITATION



Certificate No. : L1190-110702

財團法人全國認證基金會  
Taiwan Accreditation Foundation

### Certificate of Accreditation

This is to certify that

**Sporton International Inc.**  
**EMC & Wireless Communications Laboratory**  
No.52, Hwa Ya 1st Road, Hwa Ya Technology Park, Kwei-Shan Hsiang, Tao Yuan Hsien,  
Taiwan, R.O.C.

**is accredited in respect of laboratory**

<b>Accreditation Criteria</b>	: ISO/IEC 17025:2005
<b>Accreditation Number</b>	: 1190
<b>Originally Accredited</b>	: December 15, 2003
<b>Effective Period</b>	: January 10, 2010 to January 09, 2013
<b>Accredited Scope</b>	: Testing Field, see described in the Appendix
<b>Specific Accreditation Program</b>	: Accreditation Program for Designated Testing Laboratory for Commodities Inspection Accreditation Program for Telecommunication Equipment Testing Laboratory Accreditation Program for BSMI Mutual Recognition Arrangement with Foreign Authorities

  
Jay-San Chen  
President, Taiwan Accreditation Foundation  
Date : July 02, 2011

P1, total 22 pages

The Appendix forms an integral part of this Certificate, which shall be invalid when use without the Appendix