

FCC Test Report

Report No.: RF160321D09-1

FCC ID: K7SF9K1124V1

Test Model: F9K1124V1

Received Date: Mar. 21, 2016

Test Date: Mar. 23 ~ 25, 2016

Issued Date: Apr. 1, 2016

Applicant: Belkin International, Inc.

Address: 12045 East Waterfront Drive, Playa Vista, CA 90094 USA

Issued By: Bureau Veritas Consumer Products Services (H.K.) Ltd., Taoyuan Branch

Lab Address: No. 47-2, 14th Ling, Chia Pau Vil., Lin Kou Dist., New Taipei City, Taiwan (R.O.C.)



This report is for your exclusive use. Any copying or replication of this report to or for any other person or entity, or use of our name or trademark, is permitted only with our prior written permission. This report sets forth our findings solely with respect to the test samples identified herein. The results set forth in this report are not indicative or representative of the quality or characteristics of the lot from which a test sample was taken or any similar or identical product unless specifically and expressly noted. Our report includes all of the tests requested by you and the results thereof based upon the information that you provided to us. You have 60 days from date of issuance of this report to notify us of any material error or omission caused by our negligence, provided, however, that such notice shall be in writing and shall specifically address the issue you wish to raise. A failure to raise such issue within the prescribed time shall constitute your unqualified acceptance of the completeness of this report, the tests conducted and the correctness of the report contents. Unless specific mention, the uncertainty of measurement has been explicitly taken into account to declare the compliance or non-compliance to the specification. The report must not be used by the client to claim product certification, approval, or endorsement by TAF or any government agencies.

Table of Contents

Release Control Record	4
1 Certificate of Conformity	5
2 Summary of Test Results	6
2.1 Measurement Uncertainty.....	6
2.2 Modification Record.....	6
3 General Information	7
3.1 General Description of EUT.....	7
3.2 Description of Test Modes.....	9
3.2.1 Test Mode Applicability and Tested Channel Detail.....	10
3.3 Duty Cycle of Test Signal.....	12
3.4 Description of Support Units.....	13
3.4.1 Configuration of System under Test.....	14
3.5 General Description of Applied Standard.....	15
4 Test Types and Results	16
4.1 Radiated Emission and Bandedge Measurement.....	16
4.1.1 Limits of Radiated Emission and Bandedge Measurement.....	16
4.1.2 Test Instruments.....	17
4.1.3 Test Procedure.....	18
4.1.4 Deviation from Test Standard.....	18
4.1.5 Test Setup.....	19
4.1.6 EUT Operating Condition.....	19
4.1.7 Test Results.....	20
4.2 Conducted Emission Measurement.....	39
4.2.1 Limits of Conducted Emission Measurement.....	39
4.2.2 Test Instruments.....	39
4.2.3 Test Procedure.....	40
4.2.4 Deviation from Test Standard.....	40
4.2.5 Test Setup.....	40
4.2.6 EUT Operating Condition.....	40
4.2.7 Test Results.....	41
4.3 Transmit Power Measurement.....	45
4.3.1 Limits of Transmit Power Measurement.....	45
4.3.2 Test Setup.....	45
4.3.3 Test Instruments.....	45
4.3.4 Test Procedure.....	46
4.3.5 Deviation from Test Standard.....	46
4.3.6 EUT Operating Condition.....	46
4.3.7 Test Result.....	47
4.4 Peak Power Spectral Density Measurement.....	53
4.4.1 Limits of Peak Power Spectral Density Measurement.....	53
4.4.2 Test Setup.....	53
4.4.3 Test Instruments.....	53
4.4.4 Test Procedure.....	54
4.4.5 Deviation from Test Standard.....	54
4.4.6 EUT Operating Condition.....	54
4.4.7 Test Results.....	55
4.5 Frequency Stability Measurement.....	61
4.5.1 Limits of Frequency Stability Measurement.....	61
4.5.2 Test Setup.....	61
4.5.3 Test Instruments.....	61
4.5.4 Test Procedure.....	61
4.5.5 Deviation from Test Standard.....	61

4.5.6 EUT Operating Condition.....	61
4.5.7 Test Results.....	62
4.6 6dB Bandwidth Measurement.....	63
4.6.1 Limits of 6dB Bandwidth Measurement.....	63
4.6.2 Test Setup.....	63
4.6.3 Test Instruments.....	63
4.6.4 Test Procedure.....	63
4.6.5 Deviation from Test Standard.....	63
4.6.6 EUT Operating Condition.....	63
4.6.7 Test Results.....	64
5 Pictures of Test Arrangements.....	66
Appendix – Information on the Testing Laboratories.....	67



A D T

Release Control Record

Issue No.	Description	Date Issued
RF160321D09-1	Original release.	Apr. 1, 2016

1 Certificate of Conformity

Product: AC1900 DB Wi-Fi Dual-Band AC+ Gigabit Router

Brand: Belkin

Test Model: F9K1124V1

Sample Status: Engineering sample

Applicant: Belkin International, Inc.

Test Date: Mar. 23 ~ 25, 2016

Standard: 47 CFR FCC Part 15, Subpart E (Section 15.407)
ANSI C63.10: 2013

The above equipment has been tested by **Bureau Veritas Consumer Products Services (H.K.) Ltd., Taoyuan Branch**, and found compliance with the requirement of the above standards. The test record, data evaluation & Equipment Under Test (EUT) configurations represented herein are true and accurate accounts of the measurements of the sample's EMC characteristics under the conditions specified in this report.

Prepared by :



(Celia Chen / Supervisor)

Date: Apr. 1, 2016

Approved by :



(Rex Lai / Assistant Manager)

Date: Apr. 1, 2016

2 Summary of Test Results

47 CFR FCC Part 15, Subpart E (SECTION 15.407)			
FCC Clause	Test Item	Result	Remarks
15.407(b)(6)	AC Power Conducted Emissions	PASS	Meet the requirement of limit. Minimum passing margin is -6.80dB at 0.15000MHz.
15.407(b) (1/2/3/4/6)	Radiated Emissions & Band Edge Measurement	PASS	Meet the requirement of limit. Minimum passing margin is -1.0dB at 5150.00MHz, 5714.99MHz, 5715.00MHz, 5860.01MHz, 10360.00MHz, 11570.00MHz.
15.407(a)(1/2 /3)	Max Average Transmit Power	PASS	Meet the requirement of limit.
15.407(a)(1/2 /3)	Peak Power Spectral Density	PASS	Meet the requirement of limit.
15.407(e)	6dB bandwidth	PASS	Meet the requirement of limit. (U-NII-3 Band only)
15.407(g)	Frequency Stability	PASS	Meet the requirement of limit.
15.203	Antenna Requirement	PASS	Antenna connector is U.FL not a standard connector.

2.1 Measurement Uncertainty

Where relevant, the following measurement uncertainty levels have been estimated for tests performed on the EUT as specified in CISPR 16-4-2:

Measurement	Frequency	Expanded Uncertainty (k=2) (\pm)
Conducted Emissions at mains ports	150kHz ~ 30MHz	2.78 dB
Radiated Emissions up to 1 GHz	30MHz ~ 1000MHz	4.00 dB
Radiated Emissions above 1 GHz	1GHz ~ 40GHz	3.36 dB

2.2 Modification Record

There were no modifications required for compliance.

3 General Information

3.1 General Description of EUT

Product	AC1900 DB Wi-Fi Dual-Band AC+ Gigabit Router
Brand	Belkin
Test Model	F9K1124V1
Status of EUT	Engineering sample
Power Supply Rating	12Vdc from Adapter
Modulation Type	64QAM, 16QAM, QPSK, BPSK 256QAM for OFDM in 11ac mode only.
Modulation Technology	OFDM
Transfer Rate	802.11a: 54/48/36/24/18/12/9/6Mbps 802.11n: up to 600Mbps 802.11ac: up to 1300Mbps
Operating Frequency	5180 ~ 5240MHz 5745 ~ 5825MHz
Number of Channel	5180 ~ 5240MHz 4 for 802.11a, 802.11n (HT20) 2 for 802.11n (HT40) 1 for 802.11ac (VHT80) 5745 ~ 5825MHz 5 for 802.11a, 802.11n (HT20) 2 for 802.11n (HT40) 1 for 802.11ac (VHT80)
Output Power	5180 ~ 5240MHz 293.129 mW 5745 ~ 5825MHz 406.579mW
Antenna Type	Refer to table as below
Antenna Connector	Refer to table as below
Accessory Device	Adapter
Data Cable Supplied	N/A
Driver Version	V1.04.03
Product SW Version	V1.04.03
Product HW Version	V1.0
Radio SW Version	V1.04.03
Radio HW Version	V1.0

Note:

1. The EUT incorporates a MIMO function. Physically, the EUT provides three completed transmitters and four receivers.

Modulation Mode	TX FUNCTION
802.11a	3TX
802.11n (20MHz)	3TX
802.11n (40MHz)	3TX
802.11ac (20MHz)	3TX
802.11ac (40MHz)	3TX
802.11ac (80MHz)	3TX

* The modulation and bandwidth are similar for 802.11n mode for 20MHz / 40MHz and 802.11ac mode for 20MHz / 40MHz, therefore investigated worst case to representative mode in test report. (Final test mode refer section 3.2.1)

2. The following antennas were applied to the EUT:

Antenna	Brand	Model	Type	Connector	Gain (dBi)	
					2.4GHz	5.0GHz
TX & RX						
1	Airgain	N2420DG	Printed	U.FL	2.71	3.05
2	Airgain	N2420DGCS	Printed	U.FL	2.1	2.4
3	Airgain	N2420DG	Printed	U.FL	2.71	3.05
RX						
4	Airgain	N5X20SD	Printed	U.FL	-	3.48

3. The EUT was power supplied from the following power adapters:

Item	Brand	Model No.	Design No.	Plug Type	Rating
Adapter 1	Belkin	MU24-Y120200-A1	MU24-Y1120-AS1S	US	AC I/P: 100-240V, 50/60Hz, 0.7A DC O/P: 12V, 2A Non-shielded DC (1.5m)
	Belkin	MU24-Y120200-C5	MU24-Y1120-KS1S	EU	
	Belkin	MU24-Y120200-A3	MU24-Y1120-ES1S	AU	
	Belkin	MU24-Y120200-B2	MU24-Y1120-IS1S	UK	
Four adapters are identical with each other except for their plug type difference					
Adapter 2	Belkin	LW0NCA-US1220		US	AC I/P: 100-240V, 50/60Hz, 0.6A DC O/P: 12V, 2A Non-shielded DC (1.5m)
	Belkin	LW0NCA-EU1220		EU	
	Belkin	LW0NCA-UK1220		UK	
Three adapters are identical with each other except for their plug type difference					

4. The above EUT information is declared by manufacturer and for more detailed features description, please refer to the manufacturer's specifications or user's manual.

3.2 Description of Test Modes

FOR 5180 ~ 5240MHz

4 channels are provided for 802.11a, 802.11n (20MHz), 802.11ac (20MHz):

Channel	Frequency	Channel	Frequency
36	5180 MHz	44	5220 MHz
40	5200 MHz	48	5240 MHz

2 channels are provided for 802.11n (40MHz), 802.11ac (40MHz):

Channel	Frequency	Channel	Frequency
38	5190 MHz	46	5230 MHz

1 channel is provided for 802.11ac (80MHz):

Channel	Frequency
42	5210MHz

FOR 5745 ~ 5825MHz:

5 channels are provided for 802.11a, 802.11n (20MHz), 802.11ac (20MHz):

Channel	Frequency	Channel	Frequency
149	5745MHz	161	5805MHz
153	5765MHz	165	5825MHz
157	5785MHz		

2 channels are provided for 802.11n (40MHz), 802.11ac (40MHz):

Channel	Frequency	Channel	Frequency
151	5755MHz	159	5795MHz

1 channel is provided for 802.11ac (80MHz):

Channel	Frequency
155	5775MHz

3.2.1 Test Mode Applicability and Tested Channel Detail

EUT CONFIGURE MODE	APPLICABLE TO				DESCRIPTION
	RE \geq 1G	RE<1G	PLC	APCM	
A	√	√	√	√	With Adatper 1
B	-	-	√	-	With Adatper 2

Where **RE \geq 1G**: Radiated Emission above 1GHz **RE<1G**: Radiated Emission below 1GHz
PLC: Power Line Conducted Emission **APCM**: Antenna Port Conducted Measurement

Radiated Emission Test (Above 1GHz):

- Pre-Scan has been conducted to determine the worst-case mode from all possible combinations between available modulations, data rates and antenna ports (if EUT with antenna diversity architecture).
- Following channel(s) was (were) selected for the final test as listed below.

EUT CONFIGURE MODE	MODE	FREQ. BAND (MHz)	AVAILABLE CHANNEL	TESTED CHANNEL	MODULATION TECHNOLOGY	MODULATION TYPE	DATA RATE (Mbps)
A	802.11a	5180-5240	36 to 48	36, 40, 48	OFDM	BPSK	6.0
A	802.11n (20MHz)		36 to 48	36, 40, 48	OFDM	BPSK	6.5
A	802.11n (40MHz)		38 to 46	38, 46	OFDM	BPSK	13.5
A	802.11ac (80MHz)		42	42	OFDM	BPSK	29.3
A	802.11a	5745-5825	149 to 165	149, 157, 165	OFDM	BPSK	6.0
A	802.11n (20MHz)		149 to 165	149, 157, 165	OFDM	BPSK	6.5
A	802.11n (40MHz)		151 to 159	151, 159	OFDM	BPSK	13.5
A	802.11ac (80MHz)		155	155	OFDM	BPSK	29.3

Radiated Emission Test (Below 1GHz):

- Pre-Scan has been conducted to determine the worst-case mode from all possible combinations between available modulations, data rates and antenna ports (if EUT with antenna diversity architecture).
- Following channel(s) was (were) selected for the final test as listed below.

EUT CONFIGURE MODE	MODE	FREQ. BAND (MHz)	AVAILABLE CHANNEL	TESTED CHANNEL	MODULATION TECHNOLOGY	MODULATION TYPE	DATA RATE (Mbps)
A	802.11n (40MHz)	5745-5825	151 to 159	159	OFDM	BPSK	13.5

Power Line Conducted Emission Test:

- Pre-Scan has been conducted to determine the worst-case mode from all possible combinations between available modulations, data rates and antenna ports (if EUT with antenna diversity architecture).
- Following channel(s) was (were) selected for the final test as listed below.

EUT CONFIGURE MODE	MODE	FREQ. BAND (MHz)	AVAILABLE CHANNEL	TESTED CHANNEL	MODULATION TECHNOLOGY	MODULATION TYPE	DATA RATE (Mbps)
A & B	802.11n (40MHz)	5745-5825	151 to 159	159	OFDM	BPSK	13.5

Antenna Port Conducted Measurement:

- This item includes all test value of each mode, but only includes spectrum plot of worst value of each mode.
- Pre-Scan has been conducted to determine the worst-case mode from all possible combinations between available modulations, data rates and antenna ports (if EUT with antenna diversity architecture).
- Following channel(s) was (were) selected for the final test as listed below.

EUT CONFIGURE MODE	MODE	FREQ. BAND (MHz)	AVAILABLE CHANNEL	TESTED CHANNEL	MODULATION TECHNOLOGY	MODULATION TYPE	DATA RATE (Mbps)
A	802.11a	5180-5240	36 to 48	36, 40, 48	OFDM	BPSK	6.0
A	802.11n (20MHz)		36 to 48	36, 40, 48	OFDM	BPSK	6.5
A	802.11n (40MHz)		38 to 46	38, 46	OFDM	BPSK	13.5
A	802.11ac (80MHz)		42	42	OFDM	BPSK	29.3
A	802.11a	5745-5825	149 to 165	149, 157, 165	OFDM	BPSK	6.0
A	802.11n (20MHz)		149 to 165	149, 157, 165	OFDM	BPSK	6.5
A	802.11n (40MHz)		151 to 159	151, 159	OFDM	BPSK	13.5
A	802.11ac (80MHz)		155	155	OFDM	BPSK	29.3

Test Condition:

APPLICABLE TO	EUT CONFIGURE MODE	ENVIRONMENTAL CONDITIONS	INPUT POWER	TESTED BY
RE\geq1G	A	22deg. C, 71%RH	120Vac, 60Hz	Aaron You
RE$<$1G	A	22deg. C, 67%RH	120Vac, 60Hz	Aaron You
PLC	A & B	20deg. C, 81%RH	120Vac, 60Hz	Paul Chen
APCM	A	25deg. C, 60%RH	120Vac, 60Hz	Dalen Dai

3.3 Duty Cycle of Test Signal

Duty cycle of test signal is < 98 %, duty factor is required

802.11a: Duty cycle = 1.289/1.42 = 0.908, Duty factor = $10 * \log(1/0.908) = 0.42$

802.11n (20MHz): Duty cycle = 1.231/1.318 = 0.934, Duty factor = $10 * \log(1/0.934) = 0.30$

802.11n (40MHz): Duty cycle = 0.586/0.688 = 0.852, Duty factor = $10 * \log(1/0.852) = 0.70$

802.11ac (80MHz): Duty cycle = 0.279/0.372 = 0.75, Duty factor = $10 * \log(1/0.75) = 1.25$

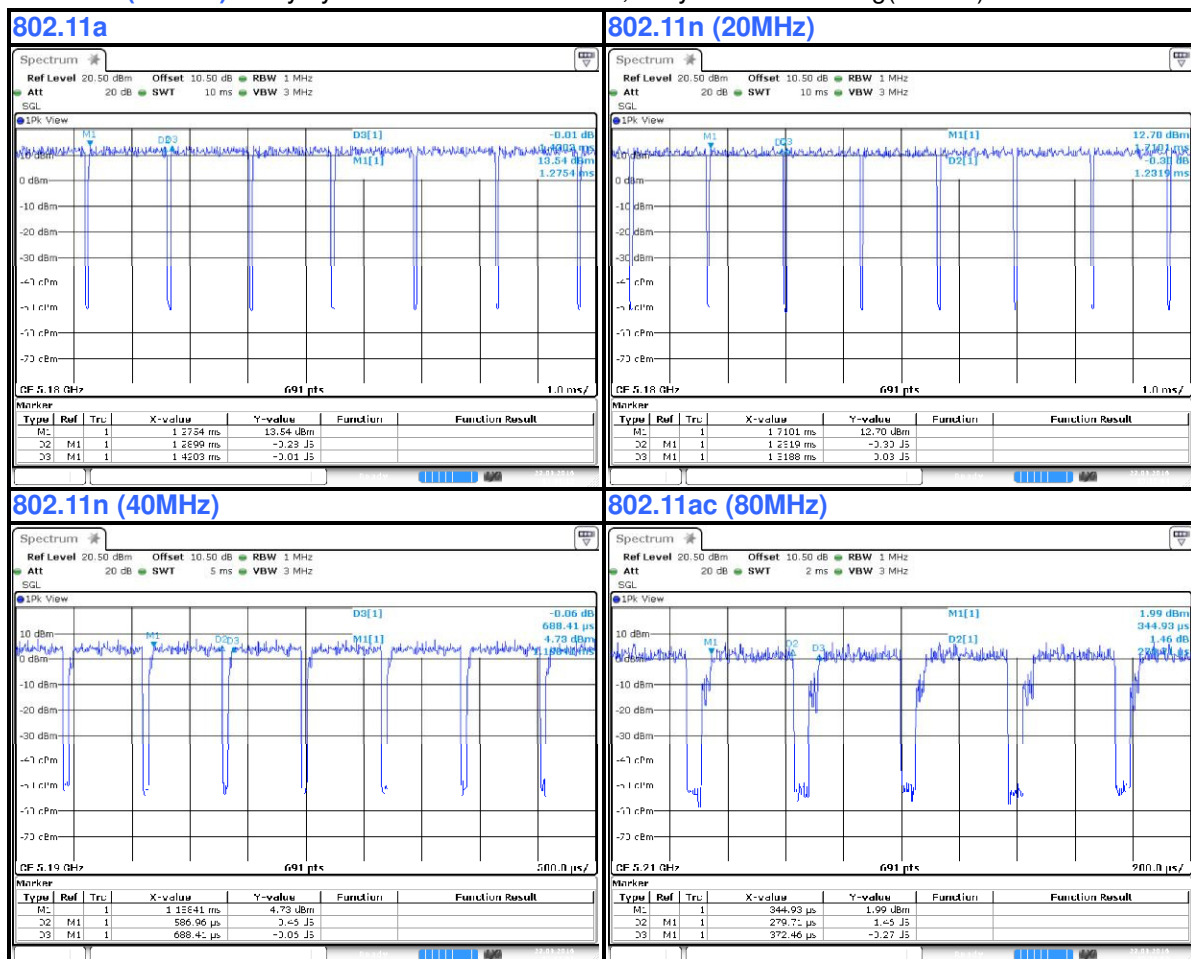

3.4 Description of Support Units

The EUT has been tested as an independent unit together with other necessary accessories or support units. The following support units or accessories were used to form a representative test configuration during the tests.

ID	Product	Brand	Model No.	Serial No.	FCC ID	Remarks
A.	USB 3.0 Hard Disk	WD	WDBACY5000ABL-PESN	WXD1E91JMPR4	FCC DoC Approved	Provided by Lab
B.	LAN Load	NA	NA	NA	NA	Provided by Lab
C.	Notebook PC	DELL	E6530	9331GV1	FCC DoC Approved	Provided by Lab
D.	Notebook PC	DELL	PP27L	8SNZ12S	FCC DoC Approved	Provided by Lab
E.	Notebook PC	DELL	E5410	BW33YM1	FCC DoC Approved	Provided by Lab
F.	Notebook PC	Lenovo	L440	R90HE6YK	FCC DoC Approved	Provided by Lab

Note:

1. All power cords of the above support units are non-shielded (1.8m).
2. Items C~F acted as communication partners to transfer data.

ID	Descriptions	Qty.	Length (m)	Shielding (Yes/No)	Cores (Qty.)	Remarks
1.	USB cable	1	0.5	Y	0	Provided by Lab
2.	LAN cable	3	1.8	N	0	Provided by Lab
3.	DC cable	1	1.5	N	0	Supplied by client
4.	LAN cable	2	10	N	0	Provided by Lab

Note: The core(s) is(are) originally attached to the cable(s).

3.4.1 Configuration of System under Test

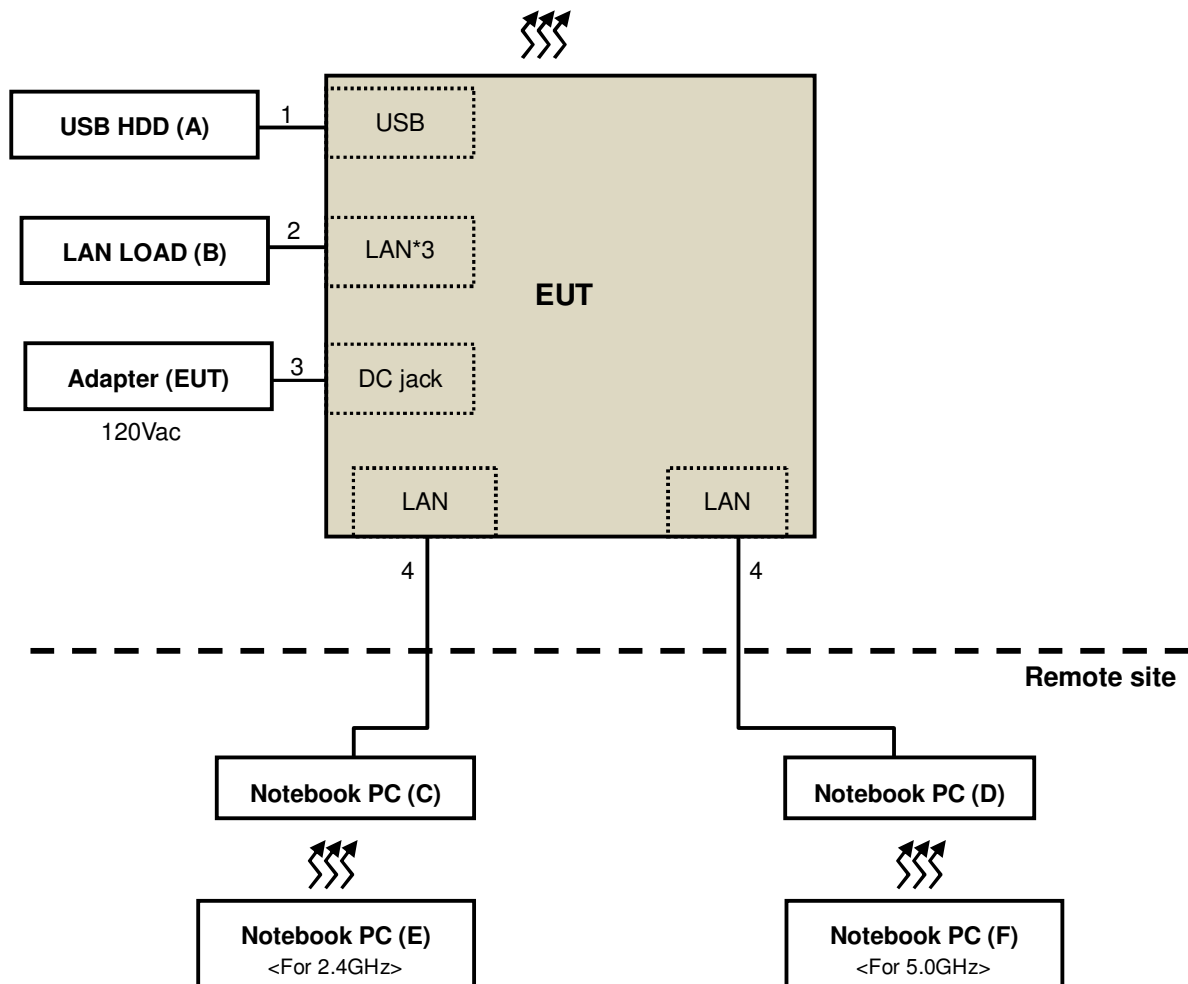

3.5 General Description of Applied Standard

The EUT is a RF Product. According to the specifications of the manufacturer, it must comply with the requirements of the following standards:

FCC Part 15, Subpart E (15.407)

KDB 789033 D02 General UNII Test Procedure New Rules v01r01

KDB 662911 D01 Multiple Transmitter Output v02r01

ANSI C63.10-2013

All test items have been performed and recorded as per the above standards.

NOTE: The EUT has been verified to comply with the requirements of FCC Part 15, Subpart B, Class B (DoC). The test report has been issued separately.

4 Test Types and Results

4.1 Radiated Emission and Bandedge Measurement

4.1.1 Limits of Radiated Emission and Bandedge Measurement

Radiated emissions which fall in the restricted bands must comply with the radiated emission limits specified as below table.

Frequencies (MHz)	Field Strength (microvolts/meter)	Measurement Distance (meters)
0.009 ~ 0.490	2400/F(kHz)	300
0.490 ~ 1.705	24000/F(kHz)	30
1.705 ~ 30.0	30	30
30 ~ 88	100	3
88 ~ 216	150	3
216 ~ 960	200	3
Above 960	500	3

NOTE:

1. The lower limit shall apply at the transition frequencies.
2. Emission level (dBuV/m) = 20 log Emission level (uV/m).
3. For frequencies above 1000MHz, the field strength limits are based on average detector, however, the peak field strength of any emission shall not exceed the maximum permitted average limits, specified above by more than 20dB under any condition of modulation.

LIMITS OF UNWANTED EMISSION OUT OF THE RESTRICTED BANDS

APPLICABLE TO	LIMIT	
789033 D02 General UNII Test Procedure New Rules v01	FIELD STRENGTH AT 3m	
	PK:74 (dBμV/m)	AV:54 (dBμV/m)
APPLICABLE TO	EIRP LIMIT	EQUIVALENT FIELD STRENGTH AT 3m
15.407(b)(1)	PK:-27 (dBm/MHz)	PK:68.2(dBμV/m)
15.407(b)(2)		
15.407(b)(3)		
15.407(b)(4)	PK:-27 (dBm/MHz) ^{*1} PK:-17 (dBm/MHz) ^{*2}	PK: 68.2(dBμV/m) ^{*1} PK:78.2 (dBμV/m) ^{*2}

NOTE: ^{*1}beyond 10MHz of the band edge ^{*2}within 10 MHz of band edge

The following formula is used to convert the equipment isotropic radiated power (eirp) to field strength:

$$E = \frac{1000000\sqrt{30P}}{3} \mu\text{V/m, where } P \text{ is the eirp (Watts).}$$

4.1.2 Test Instruments

DESCRIPTION & MANUFACTURER	MODEL NO.	SERIAL NO.	CALIBRATED DATE	CALIBRATED UNTIL
HP Preamplifier	8447D	2432A03504	Feb. 26, 2016	Feb. 25, 2017
HP Preamplifier	8449B	3008A01201	Feb. 26, 2016	Feb. 25, 2017
MITEQ Preamplifier	AMF-6F-260400-33-8P	892164	Mar. 01, 2016	Feb. 28, 2017
Agilent TEST RECEIVER	N9038A	MY51210129	Feb. 02, 2016	Feb. 01, 2017
Schwarzbeck Antenna	VULB 9168	139	Jan. 04, 2016	Jan. 03, 2017
Schwarzbeck Antenna	VHBA 9123	480	May 29, 2015	May 28, 2017
Schwarzbeck Horn Antenna	BBHA-9170	212	Jan. 08, 2016	Jan. 07, 2017
Schwarzbeck Horn Antenna	BBHA 9120-D1	D130	Jan. 21, 2016	Jan. 20, 2017
ADT. Turn Table	TT100	0306	NA	NA
ADT. Tower	AT100	0306	NA	NA
Software	Radiated_V7.6.15.9.4	NA	NA	NA
SUHNER RF cable With 4dB PAD	SF104	CABLE-CH6	Aug. 15, 2015	Aug. 14, 2016
SUHNER RF cable With 3dB PAD	SF102	Cable-CH8-3.6m	Aug. 15, 2015	Aug. 14, 2016
KEYSIGHT MIMO Powermeasurement Test set	U2021XA	U2021XA-001	May 04, 2015	May 03, 2016
KEYSIGHT Spectrum Analyzer	N9030A	MY54490260	Jul. 14, 2015	Jul. 13, 2016
EMCO Horn Antenna	3115	00028257	Jan. 19, 2016	Jan. 18, 2017
Highpass filter Wainwright Instruments	WHK 3.1/18G-10SS	SN 8	NA	NA
ROHDE & SCHWARZ Spectrum Analyzer	FSV40	101042	Sep. 23, 2015	Sep. 22, 2016
Anritsu Power Sensor	MA2411B	0738404	Apr. 21, 2015	Apr. 20, 2016
Anritsu Power Meter	ML2495A	0842014	Apr. 21, 2015	Apr. 20, 2016

- NOTE:**
1. The calibration interval of the above test instruments is 12/24 months. And the calibrations are traceable to NML/ROC and NIST/USA.
 2. The horn antenna and HP preamplifier (model: 8449B) are used only for the measurement of emission frequency above 1GHz if tested.
 3. The test was performed in Chamber No. 6.
 4. The Industry Canada Reference No. IC 7450E-6.
 5. The FCC Site Registration No. is 447212.

4.1.3 Test Procedure

- a. The EUT was placed on the top of a rotating table 0.8 meters (for below 1GHz) / 1.5 meters (for above 1GHz) above the ground at 3 meter chamber room for test. The table was rotated 360 degrees to determine the position of the highest radiation.
- b. The EUT was set 3 meters away from the interference-receiving antenna, which was mounted on the top of a variable-height antenna tower.
- c. The height of antenna is varied from one meter to four meters above the ground to determine the maximum value of the field strength. Both horizontal and vertical polarizations of the antenna are set to make the measurement.
- d. For each suspected emission, the EUT was arranged to its worst case and then the antenna was tuned to heights from 1 meter to 4 meters and the rotatable table was turned from 0 degrees to 360 degrees to find the maximum reading.
- e. The test-receiver system was set to quasi-peak detect function and specified bandwidth with maximum hold mode when the test frequency is below 1 GHz.
- f. The test-receiver system was set to peak and average detect function and specified bandwidth with maximum hold mode when the test frequency is above 1 GHz. If the peak reading value also meets average limit, measurement with the average detector is unnecessary.

Note:

1. The resolution bandwidth and video bandwidth of test receiver/spectrum analyzer is 120kHz for Quasi-peak detection (QP) at frequency below 1GHz.
2. The resolution bandwidth of test receiver/spectrum analyzer is 1 MHz and the video bandwidth is 3 MHz for Peak detection (PK) at frequency above 1GHz.
3. The resolution bandwidth of test receiver/spectrum analyzer is 1MHz and the video bandwidth is 3MHz for RMS Average (Duty cycle < 98%) for Average detection (AV) at frequency above 1GHz, then the measurement results was added to a correction factor ($10 \log(1/\text{duty cycle})$).
4. All modes of operation were investigated and the worst-case emissions are reported.

4.1.4 Deviation from Test Standard

No deviation.

4.1.5 Test Setup

<Frequency Range below 1GHz>

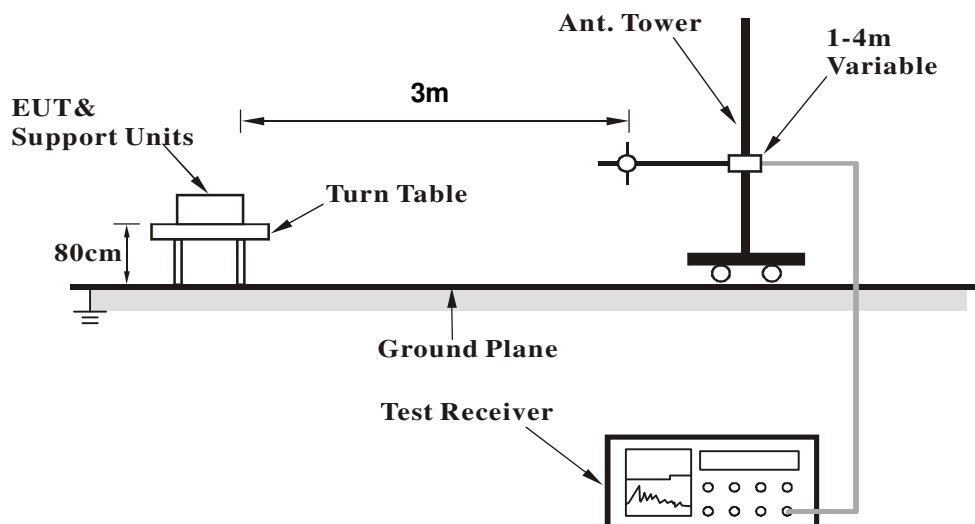

<Frequency Range above 1GHz>

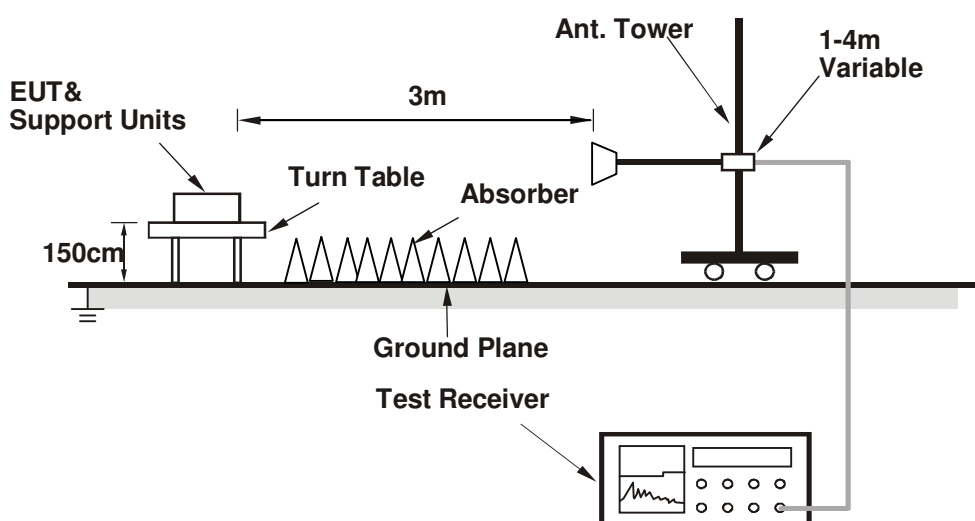

For the actual test configuration, please refer to the attached file (Test Setup Photo).

4.1.6 EUT Operating Condition

- Placed the EUT on the testing table.
- Prepared notebooks to act as communication partner and placed it outside of testing area.
- The communication partner connected with EUT via a RJ45 cable and ran a test program (provided by manufacturer) to enable EUT under transmission condition continuously at specific channel frequency.
- The communication partner sent data to EUT by command "PING".
- The necessary accessories enable the system in full functions.

4.1.7 Test Results

Mode A

ABOVE 1GHz DATA

802.11a

CHANNEL	TX Channel 36	DETECTOR FUNCTION	Peak (PK)
FREQUENCY RANGE	1GHz ~ 40GHz		Average (AV)

ANTENNA POLARITY & TEST DISTANCE: HORIZONTAL AT 3 M

NO.	FREQ. (MHz)	EMISSION LEVEL (dBuV/m)	LIMIT (dBuV/m)	MARGIN (dB)	ANTENNA HEIGHT (m)	TABLE ANGLE (Degree)	RAW VALUE (dBuV)	CORRECTION FACTOR (dB/m)
1	5150.00	71.2 PK	74.0	-2.8	2.66 H	250	62.66	8.53
2	5150.00	53.0 AV	54.0	-1.0	2.66 H	250	44.45	8.53
3	*5180.00	113.1 PK			2.66 H	250	104.40	8.71
4	*5180.00	103.7 AV			2.66 H	250	94.98	8.71
5	#10360.00	65.5 PK	68.2	-2.7	1.42 H	189	45.12	20.33

ANTENNA POLARITY & TEST DISTANCE: VERTICAL AT 3 M

NO.	FREQ. (MHz)	EMISSION LEVEL (dBuV/m)	LIMIT (dBuV/m)	MARGIN (dB)	ANTENNA HEIGHT (m)	TABLE ANGLE (Degree)	RAW VALUE (dBuV)	CORRECTION FACTOR (dB/m)
1	5150.00	70.4 PK	74.0	-3.6	1.43 V	183	61.85	8.53
2	5150.00	53.0 AV	54.0	-1.1	1.43 V	183	44.42	8.53
3	*5180.00	112.9 PK			1.43 V	183	104.18	8.71
4	*5180.00	103.6 AV			1.43 V	183	94.91	8.71
5	#10360.00	67.1 PK	68.2	-1.1	1.88 V	243	46.79	20.33

REMARKS:

- Emission Level(dBuV/m) = Raw Value(dBuV) + Correction Factor(dB/m)
- Correction Factor(dB/m) = Antenna Factor(dB/m) + Cable Factor(dB) – Pre-Amplifier Factor(dB)
- The other emission levels were very low against the limit.
- Margin value = Emission Level – Limit value
- " * ": Fundamental frequency.
- " # ": The radiated frequency is out of the restricted band.

CHANNEL	TX Channel 40	DETECTOR FUNCTION	Peak (PK)
FREQUENCY RANGE	1GHz ~ 40GHz		Average (AV)

ANTENNA POLARITY & TEST DISTANCE: HORIZONTAL AT 3 M								
NO.	FREQ. (MHz)	EMISSION LEVEL (dBuV/m)	LIMIT (dBuV/m)	MARGIN (dB)	ANTENNA HEIGHT (m)	TABLE ANGLE (Degree)	RAW VALUE (dBuV)	CORRECTION FACTOR (dB/m)
1	*5200.00	114.0 PK			2.25 H	249	105.17	8.82
2	*5200.00	104.4 AV			2.25 H	249	95.59	8.82
3	#10400.00	64.4 PK	68.2	-3.8	2.55 H	167	43.92	20.46
ANTENNA POLARITY & TEST DISTANCE: VERTICAL AT 3 M								
NO.	FREQ. (MHz)	EMISSION LEVEL (dBuV/m)	LIMIT (dBuV/m)	MARGIN (dB)	ANTENNA HEIGHT (m)	TABLE ANGLE (Degree)	RAW VALUE (dBuV)	CORRECTION FACTOR (dB/m)
1	*5200.00	113.3 PK			1.50 V	182	104.49	8.82
2	*5200.00	104.1 AV			1.50 V	182	95.32	8.82
3	#10400.00	67.0 PK	68.2	-1.2	2.00 V	250	46.54	20.46

REMARKS:

1. Emission Level(dBuV/m) = Raw Value(dBuV) + Correction Factor(dB/m)
2. Correction Factor(dB/m) = Antenna Factor(dB/m) + Cable Factor(dB) – Pre-Amplifier Factor(dB)
3. The other emission levels were very low against the limit.
4. Margin value = Emission Level – Limit value
5. " * ": Fundamental frequency.
6. " # ": The radiated frequency is out of the restricted band.

CHANNEL	TX Channel 48	DETECTOR FUNCTION	Peak (PK)
FREQUENCY RANGE	1GHz ~ 40GHz		Average (AV)

ANTENNA POLARITY & TEST DISTANCE: HORIZONTAL AT 3 M								
NO.	FREQ. (MHz)	EMISSION LEVEL (dBuV/m)	LIMIT (dBuV/m)	MARGIN (dB)	ANTENNA HEIGHT (m)	TABLE ANGLE (Degree)	RAW VALUE (dBuV)	CORRECTION FACTOR (dB/m)
1	*5240.00	114.7 PK			2.53 H	249	105.68	8.97
2	*5240.00	105.4 AV			2.53 H	249	96.47	8.97
3	5350.00	61.6 PK	74.0	-12.4	2.53 H	249	52.18	9.43
4	5350.00	47.2 AV	54.0	-6.8	2.53 H	249	37.80	9.43
5	#10480.00	63.1 PK	68.2	-5.1	2.12 H	269	42.16	20.89

ANTENNA POLARITY & TEST DISTANCE: VERTICAL AT 3 M								
NO.	FREQ. (MHz)	EMISSION LEVEL (dBuV/m)	LIMIT (dBuV/m)	MARGIN (dB)	ANTENNA HEIGHT (m)	TABLE ANGLE (Degree)	RAW VALUE (dBuV)	CORRECTION FACTOR (dB/m)
1	*5240.00	112.5 PK			1.21 V	263	103.55	8.97
2	*5240.00	103.8 AV			1.21 V	263	94.86	8.97
3	5350.00	61.0 PK	74.0	-13.0	1.21 V	264	51.53	9.43
4	5350.00	46.8 AV	54.0	-7.2	1.21 V	264	37.37	9.43
5	#10480.00	66.8 PK	68.2	-1.4	1.92 V	190	45.94	20.89

REMARKS:

1. Emission Level(dBuV/m) = Raw Value(dBuV) + Correction Factor(dB/m)
2. Correction Factor(dB/m) = Antenna Factor(dB/m) + Cable Factor(dB) – Pre-Amplifier Factor(dB)
3. The other emission levels were very low against the limit.
4. Margin value = Emission Level – Limit value
5. " * ": Fundamental frequency.
6. " # ": The radiated frequency is out of the restricted band.



CHANNEL	TX Channel 149	DETECTOR FUNCTION	Peak (PK)
FREQUENCY RANGE	1GHz ~ 40GHz		Average (AV)

ANTENNA POLARITY & TEST DISTANCE: HORIZONTAL AT 3 M

NO.	FREQ. (MHz)	EMISSION LEVEL (dBuV/m)	LIMIT (dBuV/m)	MARGIN (dB)	ANTENNA HEIGHT (m)	TABLE ANGLE (Degree)	RAW VALUE (dBuV)	CORRECTION FACTOR (dB/m)
1	#5714.99	67.2 PK	68.2	-1.0	3.55 H	278	56.73	10.43
2	#5725.00	77.0 PK	78.2	-1.2	3.55 H	278	66.57	10.40
3	*5745.00	113.2 PK			3.55 H	278	102.81	10.35
4	*5745.00	103.9 AV			3.55 H	278	93.59	10.35
5	11490.00	62.6 PK	74.0	-11.4	2.03 H	275	40.31	22.26
6	11490.00	51.6 AV	54.0	-2.5	2.03 H	275	29.29	22.26

ANTENNA POLARITY & TEST DISTANCE: VERTICAL AT 3 M

NO.	FREQ. (MHz)	EMISSION LEVEL (dBuV/m)	LIMIT (dBuV/m)	MARGIN (dB)	ANTENNA HEIGHT (m)	TABLE ANGLE (Degree)	RAW VALUE (dBuV)	CORRECTION FACTOR (dB/m)
1	#5714.99	62.5 PK	68.2	-5.7	2.08 V	283	52.04	10.43
2	#5725.00	67.1 PK	78.2	-11.1	2.08 V	283	56.72	10.40
3	*5745.00	107.2 PK			2.08 V	283	96.86	10.35
4	*5745.00	97.4 AV			2.08 V	283	87.06	10.35
5	11490.00	61.8 PK	74.0	-12.2	2.41 V	260	39.52	22.26
6	11490.00	49.4 AV	54.0	-4.6	2.41 V	260	27.10	22.26

REMARKS:

1. Emission Level(dBuV/m) = Raw Value(dBuV) + Correction Factor(dB/m)
2. Correction Factor(dB/m) = Antenna Factor(dB/m) + Cable Factor(dB) – Pre-Amplifier Factor(dB)
3. The other emission levels were very low against the limit.
4. Margin value = Emission Level – Limit value
5. " * ": Fundamental frequency.
6. " # ": The radiated frequency is out of the restricted band.

CHANNEL	TX Channel 157	DETECTOR FUNCTION	Peak (PK)
FREQUENCY RANGE	1GHz ~ 40GHz		Average (AV)

ANTENNA POLARITY & TEST DISTANCE: HORIZONTAL AT 3 M								
NO.	FREQ. (MHz)	EMISSION LEVEL (dBuV/m)	LIMIT (dBuV/m)	MARGIN (dB)	ANTENNA HEIGHT (m)	TABLE ANGLE (Degree)	RAW VALUE (dBuV)	CORRECTION FACTOR (dB/m)
1	*5785.00	111.7 PK			3.00 H	286	101.45	10.26
2	*5785.00	102.6 AV			3.00 H	286	92.31	10.26
3	11570.00	65.5 PK	74.0	-8.5	1.52 H	203	43.17	22.35
4	11570.00	52.9 AV	54.0	-1.1	1.52 H	203	30.55	22.35

ANTENNA POLARITY & TEST DISTANCE: VERTICAL AT 3 M								
NO.	FREQ. (MHz)	EMISSION LEVEL (dBuV/m)	LIMIT (dBuV/m)	MARGIN (dB)	ANTENNA HEIGHT (m)	TABLE ANGLE (Degree)	RAW VALUE (dBuV)	CORRECTION FACTOR (dB/m)
1	*5785.00	109.1 PK			1.05 V	274	98.85	10.26
2	*5785.00	99.6 AV			1.05 V	274	89.34	10.26
3	11570.00	63.2 PK	74.0	-10.8	3.07 V	291	40.87	22.35
4	11570.00	50.0 AV	54.0	-4.0	3.07 V	291	27.61	22.35

REMARKS:

1. Emission Level(dBuV/m) = Raw Value(dBuV) + Correction Factor(dB/m)
2. Correction Factor(dB/m) = Antenna Factor(dB/m) + Cable Factor(dB) – Pre-Amplifier Factor(dB)
3. The other emission levels were very low against the limit.
4. Margin value = Emission Level – Limit value
5. " * ": Fundamental frequency.

CHANNEL	TX Channel 165	DETECTOR FUNCTION	Peak (PK)
FREQUENCY RANGE	1GHz ~ 40GHz		Average (AV)

ANTENNA POLARITY & TEST DISTANCE: HORIZONTAL AT 3 M								
NO.	FREQ. (MHz)	EMISSION LEVEL (dBuV/m)	LIMIT (dBuV/m)	MARGIN (dB)	ANTENNA HEIGHT (m)	TABLE ANGLE (Degree)	RAW VALUE (dBuV)	CORRECTION FACTOR (dB/m)
1	*5825.00	112.2 PK			2.64 H	278	101.91	10.27
2	*5825.00	102.4 AV			2.64 H	278	92.15	10.27
3	#5850.00	76.5 PK	78.2	-1.7	2.64 H	278	66.17	10.29
4	#5860.01	67.1 PK	68.2	-1.1	2.64 H	278	56.84	10.30
5	11650.00	64.8 PK	74.0	-9.2	1.55 H	252	42.71	22.06
6	11650.00	52.9 AV	54.0	-1.1	1.55 H	252	30.88	22.06
ANTENNA POLARITY & TEST DISTANCE: VERTICAL AT 3 M								
NO.	FREQ. (MHz)	EMISSION LEVEL (dBuV/m)	LIMIT (dBuV/m)	MARGIN (dB)	ANTENNA HEIGHT (m)	TABLE ANGLE (Degree)	RAW VALUE (dBuV)	CORRECTION FACTOR (dB/m)
1	*5825.00	107.9 PK			1.35 V	278	97.59	10.27
2	*5825.00	98.8 AV			1.35 V	278	88.53	10.27
3	#5850.00	67.1 PK	78.2	-11.1	1.35 V	278	56.83	10.29
4	#5860.01	61.6 PK	68.2	-6.6	1.35 V	278	51.33	10.30
5	11650.00	62.6 PK	74.0	-11.4	1.97 V	216	40.55	22.06
6	11650.00	50.1 AV	54.0	-3.9	1.97 V	216	28.08	22.06

REMARKS:

1. Emission Level(dBuV/m) = Raw Value(dBuV) + Correction Factor(dB/m)
2. Correction Factor(dB/m) = Antenna Factor(dB/m) + Cable Factor(dB) – Pre-Amplifier Factor(dB)
3. The other emission levels were very low against the limit.
4. Margin value = Emission Level – Limit value
5. " * ": Fundamental frequency.
6. " # ": The radiated frequency is out of the restricted band.

802.11n (20MHz)

CHANNEL	TX Channel 36	DETECTOR FUNCTION	Peak (PK)
FREQUENCY RANGE	1GHz ~ 40GHz		Average (AV)

ANTENNA POLARITY & TEST DISTANCE: HORIZONTAL AT 3 M

NO.	FREQ. (MHz)	EMISSION LEVEL (dBuV/m)	LIMIT (dBuV/m)	MARGIN (dB)	ANTENNA HEIGHT (m)	TABLE ANGLE (Degree)	RAW VALUE (dBuV)	CORRECTION FACTOR (dB/m)
1	5150.00	69.5 PK	74.0	-4.5	1.37 H	263	60.97	8.53
2	5150.00	52.7 AV	54.0	-1.3	1.37 H	263	44.20	8.53
3	*5180.00	111.8 PK			1.37 H	263	103.08	8.71
4	*5180.00	99.8 AV			1.37 H	263	91.08	8.71
5	#10360.00	65.5 PK	68.2	-2.7	1.21 H	311	45.20	20.33

ANTENNA POLARITY & TEST DISTANCE: VERTICAL AT 3 M

NO.	FREQ. (MHz)	EMISSION LEVEL (dBuV/m)	LIMIT (dBuV/m)	MARGIN (dB)	ANTENNA HEIGHT (m)	TABLE ANGLE (Degree)	RAW VALUE (dBuV)	CORRECTION FACTOR (dB/m)
1	5150.00	68.9 PK	74.0	-5.1	1.24 V	255	60.36	8.53
2	5150.00	51.2 AV	54.0	-2.9	1.24 V	255	42.62	8.53
3	*5180.00	111.3 PK			1.24 V	254	102.58	8.71
4	*5180.00	103.1 AV			1.24 V	254	94.36	8.71
5	#10360.00	67.2 PK	68.2	-1.0	1.36 V	250	46.83	20.33

REMARKS:

- Emission Level(dBuV/m) = Raw Value(dBuV) + Correction Factor(dB/m)
- Correction Factor(dB/m) = Antenna Factor(dB/m) + Cable Factor(dB) – Pre-Amplifier Factor(dB)
- The other emission levels were very low against the limit.
- Margin value = Emission Level – Limit value
- " * ": Fundamental frequency.
- " # ": The radiated frequency is out of the restricted band.

CHANNEL	TX Channel 40	DETECTOR FUNCTION	Peak (PK)
FREQUENCY RANGE	1GHz ~ 40GHz		Average (AV)

ANTENNA POLARITY & TEST DISTANCE: HORIZONTAL AT 3 M								
NO.	FREQ. (MHz)	EMISSION LEVEL (dBuV/m)	LIMIT (dBuV/m)	MARGIN (dB)	ANTENNA HEIGHT (m)	TABLE ANGLE (Degree)	RAW VALUE (dBuV)	CORRECTION FACTOR (dB/m)
1	*5200.00	111.1 PK			1.85 H	283	102.24	8.82
2	*5200.00	102.9 AV			1.85 H	283	94.06	8.82
3	#10400.00	65.5 PK	68.2	-2.7	1.28 H	307	45.06	20.46
ANTENNA POLARITY & TEST DISTANCE: VERTICAL AT 3 M								
NO.	FREQ. (MHz)	EMISSION LEVEL (dBuV/m)	LIMIT (dBuV/m)	MARGIN (dB)	ANTENNA HEIGHT (m)	TABLE ANGLE (Degree)	RAW VALUE (dBuV)	CORRECTION FACTOR (dB/m)
1	*5200.00	110.9 PK			2.94 V	181	102.08	8.82
2	*5200.00	102.6 AV			2.94 V	181	93.80	8.82
3	#10400.00	67.1 PK	68.2	-1.1	1.43 V	249	46.65	20.46

REMARKS:

1. Emission Level(dBuV/m) = Raw Value(dBuV) + Correction Factor(dB/m)
2. Correction Factor(dB/m) = Antenna Factor(dB/m) + Cable Factor(dB) – Pre-Amplifier Factor(dB)
3. The other emission levels were very low against the limit.
4. Margin value = Emission Level – Limit value
5. " * ": Fundamental frequency.
6. " # ": The radiated frequency is out of the restricted band.

CHANNEL	TX Channel 48	DETECTOR FUNCTION	Peak (PK)
FREQUENCY RANGE	1GHz ~ 40GHz		Average (AV)

ANTENNA POLARITY & TEST DISTANCE: HORIZONTAL AT 3 M								
NO.	FREQ. (MHz)	EMISSION LEVEL (dBuV/m)	LIMIT (dBuV/m)	MARGIN (dB)	ANTENNA HEIGHT (m)	TABLE ANGLE (Degree)	RAW VALUE (dBuV)	CORRECTION FACTOR (dB/m)
1	*5240.00	112.7 PK			1.50 H	269	103.71	8.97
2	*5240.00	104.4 AV			1.50 H	269	95.40	8.97
3	5350.00	61.8 PK	74.0	-12.2	1.50 H	269	52.33	9.43
4	5350.00	47.5 AV	54.0	-6.5	1.50 H	269	38.05	9.43
5	#10400.00	65.4 PK	68.2	-2.8	1.30 H	297	44.97	20.46

ANTENNA POLARITY & TEST DISTANCE: VERTICAL AT 3 M								
NO.	FREQ. (MHz)	EMISSION LEVEL (dBuV/m)	LIMIT (dBuV/m)	MARGIN (dB)	ANTENNA HEIGHT (m)	TABLE ANGLE (Degree)	RAW VALUE (dBuV)	CORRECTION FACTOR (dB/m)
1	*5240.00	112.2 PK			1.44 V	256	103.26	8.97
2	*5240.00	104.0 AV			1.44 V	256	95.05	8.97
3	5350.00	61.1 PK	74.0	-12.9	1.44 V	256	51.66	9.43
4	5350.00	46.8 AV	54.0	-7.2	1.44 V	256	37.35	9.43
5	#10480.00	66.9 PK	68.2	-1.3	3.40 V	205	45.99	20.89

REMARKS:

1. Emission Level(dBuV/m) = Raw Value(dBuV) + Correction Factor(dB/m)
2. Correction Factor(dB/m) = Antenna Factor(dB/m) + Cable Factor(dB) – Pre-Amplifier Factor(dB)
3. The other emission levels were very low against the limit.
4. Margin value = Emission Level – Limit value
5. " * ": Fundamental frequency.
6. " # ": The radiated frequency is out of the restricted band.

CHANNEL	TX Channel 149	DETECTOR FUNCTION	Peak (PK)
FREQUENCY RANGE	1GHz ~ 40GHz		Average (AV)

ANTENNA POLARITY & TEST DISTANCE: HORIZONTAL AT 3 M								
NO.	FREQ. (MHz)	EMISSION LEVEL (dBuV/m)	LIMIT (dBuV/m)	MARGIN (dB)	ANTENNA HEIGHT (m)	TABLE ANGLE (Degree)	RAW VALUE (dBuV)	CORRECTION FACTOR (dB/m)
1	#5714.99	65.8 PK	68.2	-2.4	1.93 H	279	55.38	10.43
2	#5725.00	77.0 PK	78.2	-1.2	1.93 H	279	66.63	10.40
3	*5745.00	107.0 PK			1.93 H	279	96.67	10.35
4	*5745.00	94.7 AV			1.93 H	279	84.39	10.35
5	11490.00	63.8 PK	74.0	-10.2	1.51 H	253	41.51	22.26
6	11490.00	51.2 AV	54.0	-2.8	1.51 H	253	28.90	22.26

ANTENNA POLARITY & TEST DISTANCE: VERTICAL AT 3 M								
NO.	FREQ. (MHz)	EMISSION LEVEL (dBuV/m)	LIMIT (dBuV/m)	MARGIN (dB)	ANTENNA HEIGHT (m)	TABLE ANGLE (Degree)	RAW VALUE (dBuV)	CORRECTION FACTOR (dB/m)
1	#5714.99	62.3 PK	68.2	-5.9	1.30 V	300	51.84	10.43
2	#5725.00	67.8 PK	78.2	-10.4	1.30 V	300	57.44	10.40
3	*5745.00	100.5 PK			1.30 V	300	90.15	10.35
4	*5745.00	91.8 AV			1.30 V	300	81.48	10.35
5	11490.00	62.2 PK	74.0	-11.8	2.27 V	230	39.92	22.26
6	11490.00	49.5 AV	54.0	-4.5	2.27 V	230	27.22	22.26

REMARKS:

- Emission Level(dBuV/m) = Raw Value(dBuV) + Correction Factor(dB/m)
- Correction Factor(dB/m) = Antenna Factor(dB/m) + Cable Factor(dB) – Pre-Amplifier Factor(dB)
- The other emission levels were very low against the limit.
- Margin value = Emission Level – Limit value
- " * ": Fundamental frequency.
- " # ": The radiated frequency is out of the restricted band.

CHANNEL	TX Channel 157	DETECTOR FUNCTION	Peak (PK)
FREQUENCY RANGE	1GHz ~ 40GHz		Average (AV)

ANTENNA POLARITY & TEST DISTANCE: HORIZONTAL AT 3 M								
NO.	FREQ. (MHz)	EMISSION LEVEL (dBuV/m)	LIMIT (dBuV/m)	MARGIN (dB)	ANTENNA HEIGHT (m)	TABLE ANGLE (Degree)	RAW VALUE (dBuV)	CORRECTION FACTOR (dB/m)
1	*5785.00	112.2 PK			1.84 H	271	101.94	10.26
2	*5785.00	104.2 AV			1.84 H	271	93.96	10.26
3	11570.00	66.1 PK	74.0	-7.9	1.53 H	203	43.77	22.35
4	11570.00	53.0 AV	54.0	-1.0	1.53 H	203	30.64	22.35

ANTENNA POLARITY & TEST DISTANCE: VERTICAL AT 3 M								
NO.	FREQ. (MHz)	EMISSION LEVEL (dBuV/m)	LIMIT (dBuV/m)	MARGIN (dB)	ANTENNA HEIGHT (m)	TABLE ANGLE (Degree)	RAW VALUE (dBuV)	CORRECTION FACTOR (dB/m)
1	*5785.00	109.0 PK			1.55 V	251	98.72	10.26
2	*5785.00	100.5 AV			1.55 V	251	90.27	10.26
3	11570.00	61.1 PK	74.0	-12.9	2.18 V	203	38.71	22.35
4	11570.00	49.7 AV	54.0	-4.3	2.18 V	203	27.35	22.35

REMARKS:

1. Emission Level(dBuV/m) = Raw Value(dBuV) + Correction Factor(dB/m)
2. Correction Factor(dB/m) = Antenna Factor(dB/m) + Cable Factor(dB) – Pre-Amplifier Factor(dB)
3. The other emission levels were very low against the limit.
4. Margin value = Emission Level – Limit value
5. " * ": Fundamental frequency.

CHANNEL	TX Channel 165	DETECTOR FUNCTION	Peak (PK)
FREQUENCY RANGE	1GHz ~ 40GHz		Average (AV)

ANTENNA POLARITY & TEST DISTANCE: HORIZONTAL AT 3 M								
NO.	FREQ. (MHz)	EMISSION LEVEL (dBuV/m)	LIMIT (dBuV/m)	MARGIN (dB)	ANTENNA HEIGHT (m)	TABLE ANGLE (Degree)	RAW VALUE (dBuV)	CORRECTION FACTOR (dB/m)
1	*5825.00	111.3 PK			3.09 H	285	101.07	10.27
2	*5825.00	99.9 AV			3.09 H	285	89.67	10.27
3	#5850.00	75.2 PK	78.2	-3.0	3.09 H	284	64.91	10.29
4	#5860.01	67.1 PK	68.2	-1.1	3.09 H	285	56.84	10.30
5	11650.00	64.3 PK	74.0	-9.7	1.32 H	255	42.23	22.06
6	11650.00	51.5 AV	54.0	-2.5	1.32 H	255	29.40	22.06
ANTENNA POLARITY & TEST DISTANCE: VERTICAL AT 3 M								
NO.	FREQ. (MHz)	EMISSION LEVEL (dBuV/m)	LIMIT (dBuV/m)	MARGIN (dB)	ANTENNA HEIGHT (m)	TABLE ANGLE (Degree)	RAW VALUE (dBuV)	CORRECTION FACTOR (dB/m)
1	*5825.00	106.7 PK			1.64 V	319	96.46	10.27
2	*5825.00	97.3 AV			1.64 V	319	87.03	10.27
3	#5850.00	66.0 PK	78.2	-12.2	1.64 V	319	55.69	10.29
4	#5860.01	62.1 PK	68.2	-6.1	1.64 V	319	51.75	10.30
5	11650.00	61.8 PK	74.0	-12.2	2.03 V	237	39.76	22.06
6	11650.00	48.6 AV	54.0	-5.4	2.03 V	237	26.50	22.06

REMARKS:

1. Emission Level(dBuV/m) = Raw Value(dBuV) + Correction Factor(dB/m)
2. Correction Factor(dB/m) = Antenna Factor(dB/m) + Cable Factor(dB) – Pre-Amplifier Factor(dB)
3. The other emission levels were very low against the limit.
4. Margin value = Emission Level – Limit value
5. " * ": Fundamental frequency.
6. " # ": The radiated frequency is out of the restricted band.

802.11n (40MHz)

CHANNEL	TX Channel 38	DETECTOR FUNCTION	Peak (PK)
FREQUENCY RANGE	1GHz ~ 40GHz		Average (AV)

ANTENNA POLARITY & TEST DISTANCE: HORIZONTAL AT 3 M

NO.	FREQ. (MHz)	EMISSION LEVEL (dBuV/m)	LIMIT (dBuV/m)	MARGIN (dB)	ANTENNA HEIGHT (m)	TABLE ANGLE (Degree)	RAW VALUE (dBuV)	CORRECTION FACTOR (dB/m)
1	5150.00	69.9 PK	74.0	-4.1	1.27 H	261	61.36	8.53
2	5150.00	53.0 AV	54.0	-1.0	1.27 H	261	44.46	8.53
3	*5190.00	106.1 PK			1.27 H	261	97.32	8.77
4	*5190.00	98.1 AV			1.27 H	261	89.34	8.77
5	#10380.00	64.1 PK	68.2	-4.1	1.11 H	314	43.70	20.40

ANTENNA POLARITY & TEST DISTANCE: VERTICAL AT 3 M

NO.	FREQ. (MHz)	EMISSION LEVEL (dBuV/m)	LIMIT (dBuV/m)	MARGIN (dB)	ANTENNA HEIGHT (m)	TABLE ANGLE (Degree)	RAW VALUE (dBuV)	CORRECTION FACTOR (dB/m)
1	5150.00	69.1 PK	74.0	-4.9	2.93 V	183	60.59	8.53
2	5150.00	52.5 AV	54.0	-1.5	2.93 V	183	43.97	8.53
3	*5190.00	105.9 PK			2.93 V	183	97.21	8.71
4	*5190.00	98.0 AV			2.93 V	183	89.26	8.71
5	#10380.00	64.8 PK	68.2	-3.4	2.22 V	304	44.39	20.40

REMARKS:

- Emission Level(dBuV/m) = Raw Value(dBuV) + Correction Factor(dB/m)
- Correction Factor(dB/m) = Antenna Factor(dB/m) + Cable Factor(dB) – Pre-Amplifier Factor(dB)
- The other emission levels were very low against the limit.
- Margin value = Emission Level – Limit value
- " * ": Fundamental frequency.
- " # ": The radiated frequency is out of the restricted band.

CHANNEL	TX Channel 46	DETECTOR FUNCTION	Peak (PK)
FREQUENCY RANGE	1GHz ~ 40GHz		Average (AV)

ANTENNA POLARITY & TEST DISTANCE: HORIZONTAL AT 3 M								
NO.	FREQ. (MHz)	EMISSION LEVEL (dBuV/m)	LIMIT (dBuV/m)	MARGIN (dB)	ANTENNA HEIGHT (m)	TABLE ANGLE (Degree)	RAW VALUE (dBuV)	CORRECTION FACTOR (dB/m)
1	5150.00	66.1 PK	74.0	-7.9	1.91 H	279	57.59	8.53
2	5150.00	51.4 AV	54.0	-2.6	1.91 H	279	42.90	8.53
3	*5230.00	111.7 PK			1.91 H	279	102.73	8.94
4	*5230.00	102.8 AV			1.91 H	279	93.86	8.94
5	5350.00	64.1 PK	74.0	-9.9	1.91 H	279	54.65	9.43
6	5350.00	48.9 AV	54.0	-5.1	1.91 H	279	39.43	9.43
7	#10460.00	64.6 PK	68.2	-3.6	1.49 H	324	43.80	20.79

ANTENNA POLARITY & TEST DISTANCE: VERTICAL AT 3 M								
NO.	FREQ. (MHz)	EMISSION LEVEL (dBuV/m)	LIMIT (dBuV/m)	MARGIN (dB)	ANTENNA HEIGHT (m)	TABLE ANGLE (Degree)	RAW VALUE (dBuV)	CORRECTION FACTOR (dB/m)
1	5150.00	63.7 PK	74.0	-10.3	1.29 V	271	55.21	8.53
2	5150.00	49.6 AV	54.0	-4.4	1.29 V	271	41.10	8.53
3	*5230.00	111.5 PK			1.29 V	271	102.55	8.94
4	*5230.00	102.7 AV			1.29 V	271	93.71	8.94
5	5350.00	61.3 PK	74.0	-12.7	1.29 V	271	51.87	9.43
6	5350.00	47.4 AV	54.0	-6.7	1.29 V	271	37.92	9.43
7	#10460.00	66.9 PK	68.2	-1.3	1.50 V	80	46.14	20.79

REMARKS:

- Emission Level(dBuV/m) = Raw Value(dBuV) + Correction Factor(dB/m)
- Correction Factor(dB/m) = Antenna Factor(dB/m) + Cable Factor(dB) – Pre-Amplifier Factor(dB)
- The other emission levels were very low against the limit.
- Margin value = Emission Level – Limit value
- " * ": Fundamental frequency.
- " # ": The radiated frequency is out of the restricted band.

CHANNEL	TX Channel 151	DETECTOR FUNCTION	Peak (PK)
FREQUENCY RANGE	1GHz ~ 40GHz		Average (AV)

ANTENNA POLARITY & TEST DISTANCE: HORIZONTAL AT 3 M								
NO.	FREQ. (MHz)	EMISSION LEVEL (dBuV/m)	LIMIT (dBuV/m)	MARGIN (dB)	ANTENNA HEIGHT (m)	TABLE ANGLE (Degree)	RAW VALUE (dBuV)	CORRECTION FACTOR (dB/m)
1	#5714.99	67.2 PK	68.2	-1.0	1.58 H	280	56.73	10.43
2	#5725.00	72.3 PK	78.2	-5.9	1.58 H	280	61.88	10.40
3	*5755.00	104.8 PK			1.58 H	280	94.46	10.34
4	*5755.00	96.3 AV			1.58 H	280	85.91	10.34
5	11510.00	62.8 PK	74.0	-11.2	1.64 H	274	40.52	22.29
6	11510.00	51.8 AV	54.0	-2.2	1.64 H	274	29.47	22.29
ANTENNA POLARITY & TEST DISTANCE: VERTICAL AT 3 M								
NO.	FREQ. (MHz)	EMISSION LEVEL (dBuV/m)	LIMIT (dBuV/m)	MARGIN (dB)	ANTENNA HEIGHT (m)	TABLE ANGLE (Degree)	RAW VALUE (dBuV)	CORRECTION FACTOR (dB/m)
1	#5714.99	63.3 PK	68.2	-4.9	1.79 V	198	52.82	10.43
2	#5725.00	65.7 PK	78.2	-12.5	1.79 V	198	55.29	10.40
3	*5755.00	99.8 PK			1.79 V	198	89.42	10.34
4	*5755.00	90.9 AV			1.79 V	198	80.53	10.34
5	11510.00	61.3 PK	74.0	-12.7	2.27 V	279	38.97	22.29
6	11510.00	49.4 AV	54.0	-4.6	2.27 V	279	27.14	22.29

REMARKS:

- Emission Level(dBuV/m) = Raw Value(dBuV) + Correction Factor(dB/m)
- Correction Factor(dB/m) = Antenna Factor(dB/m) + Cable Factor(dB) – Pre-Amplifier Factor(dB)
- The other emission levels were very low against the limit.
- Margin value = Emission Level – Limit value
- " * ": Fundamental frequency.
- " # ": The radiated frequency is out of the restricted band.

CHANNEL	TX Channel 159	DETECTOR FUNCTION	Peak (PK)
FREQUENCY RANGE	1GHz ~ 40GHz		Average (AV)

ANTENNA POLARITY & TEST DISTANCE: HORIZONTAL AT 3 M								
NO.	FREQ. (MHz)	EMISSION LEVEL (dBuV/m)	LIMIT (dBuV/m)	MARGIN (dB)	ANTENNA HEIGHT (m)	TABLE ANGLE (Degree)	RAW VALUE (dBuV)	CORRECTION FACTOR (dB/m)
1	*5795.00	108.9 PK			2.87 H	283	98.67	10.24
2	*5795.00	98.6 AV			2.87 H	283	88.32	10.24
3	#5850.00	71.5 PK	78.2	-6.7	2.87 H	283	61.25	10.29
4	#5860.01	67.2 PK	68.2	-1.0	2.87 H	283	56.90	10.30
5	11590.00	63.8 PK	74.0	-10.2	1.57 H	275	41.40	22.37
6	11590.00	52.4 AV	54.0	-1.6	1.57 H	275	30.05	22.37
ANTENNA POLARITY & TEST DISTANCE: VERTICAL AT 3 M								
NO.	FREQ. (MHz)	EMISSION LEVEL (dBuV/m)	LIMIT (dBuV/m)	MARGIN (dB)	ANTENNA HEIGHT (m)	TABLE ANGLE (Degree)	RAW VALUE (dBuV)	CORRECTION FACTOR (dB/m)
1	*5795.00	104.5 PK			1.76 V	274	94.21	10.24
2	*5795.00	95.7 AV			1.76 V	274	85.42	10.24
3	#5850.00	62.8 PK	78.2	-15.4	1.76 V	274	52.55	10.29
4	#5860.01	62.3 PK	68.2	-5.9	1.76 V	274	51.99	10.30
5	11590.00	62.2 PK	74.0	-11.8	2.30 V	245	39.87	22.37
6	11590.00	50.3 AV	54.0	-3.7	2.30 V	245	27.93	22.37

REMARKS:

1. Emission Level(dBuV/m) = Raw Value(dBuV) + Correction Factor(dB/m)
2. Correction Factor(dB/m) = Antenna Factor(dB/m) + Cable Factor(dB) – Pre-Amplifier Factor(dB)
3. The other emission levels were very low against the limit.
4. Margin value = Emission Level – Limit value
5. " * ": Fundamental frequency.
6. " # ": The radiated frequency is out of the restricted band.

802.11ac (80MHz)

CHANNEL	TX Channel 42	DETECTOR FUNCTION	Peak (PK)
FREQUENCY RANGE	1GHz ~ 40GHz		Average (AV)

ANTENNA POLARITY & TEST DISTANCE: HORIZONTAL AT 3 M

NO.	FREQ. (MHz)	EMISSION LEVEL (dBuV/m)	LIMIT (dBuV/m)	MARGIN (dB)	ANTENNA HEIGHT (m)	TABLE ANGLE (Degree)	RAW VALUE (dBuV)	CORRECTION FACTOR (dB/m)
1	5150.00	71.5 PK	74.0	-2.5	2.62 H	249	62.96	8.53
2	5150.00	52.8 AV	54.0	-1.2	2.62 H	249	44.29	8.53
3	*5210.00	106.2 PK			2.62 H	249	97.33	8.86
4	*5210.00	96.3 AV			2.62 H	249	87.41	8.86
5	5350.00	61.4 PK	74.0	-12.6	2.62 H	249	51.98	9.43
6	5350.00	47.8 AV	54.0	-6.2	2.62 H	249	38.34	9.43
7	#10420.00	64.1 PK	68.2	-4.1	1.08 H	307	43.52	20.58

ANTENNA POLARITY & TEST DISTANCE: VERTICAL AT 3 M

NO.	FREQ. (MHz)	EMISSION LEVEL (dBuV/m)	LIMIT (dBuV/m)	MARGIN (dB)	ANTENNA HEIGHT (m)	TABLE ANGLE (Degree)	RAW VALUE (dBuV)	CORRECTION FACTOR (dB/m)
1	5150.00	70.5 PK	74.0	-3.5	1.49 V	182	62.01	8.53
2	5150.00	52.0 AV	54.0	-2.0	1.49 V	182	43.51	8.53
3	*5210.00	104.5 PK			1.49 V	182	95.66	8.86
4	*5210.00	95.2 AV			1.49 V	182	86.36	8.86
5	5350.00	60.3 PK	74.0	-13.7	1.49 V	182	50.87	9.43
6	5350.00	46.8 AV	54.0	-7.2	1.49 V	182	37.41	9.43
7	#10420.00	64.8 PK	68.2	-3.4	2.17 V	288	44.26	20.58

REMARKS:

- Emission Level(dBuV/m) = Raw Value(dBuV) + Correction Factor(dB/m)
- Correction Factor(dB/m) = Antenna Factor(dB/m) + Cable Factor(dB) – Pre-Amplifier Factor(dB)
- The other emission levels were very low against the limit.
- Margin value = Emission Level – Limit value
- " * ": Fundamental frequency.
- " # ": The radiated frequency is out of the restricted band.

CHANNEL	TX Channel 155	DETECTOR FUNCTION	Peak (PK)
FREQUENCY RANGE	1GHz ~ 40GHz		Average (AV)

ANTENNA POLARITY & TEST DISTANCE: HORIZONTAL AT 3 M

NO.	FREQ. (MHz)	EMISSION LEVEL (dBuV/m)	LIMIT (dBuV/m)	MARGIN (dB)	ANTENNA HEIGHT (m)	TABLE ANGLE (Degree)	RAW VALUE (dBuV)	CORRECTION FACTOR (dB/m)
1	#5714.99	66.9 PK	68.2	-1.3	2.08 H	286	56.48	10.43
2	#5725.00	69.8 PK	78.2	-8.4	2.08 H	286	59.39	10.40
3	*5775.00	101.2 PK			2.08 H	286	90.88	10.29
4	*5775.00	91.6 AV			2.08 H	286	81.27	10.29
5	#5850.00	66.9 PK	78.2	-11.3	2.08 H	286	56.63	10.29
6	#5860.01	65.0 PK	68.2	-3.2	2.08 H	286	54.73	10.30
7	11550.00	62.0 PK	74.0	-12.1	1.30 H	274	39.62	22.33
8	11550.00	51.8 AV	54.0	-2.2	1.30 H	274	29.48	22.33

ANTENNA POLARITY & TEST DISTANCE: VERTICAL AT 3 M

NO.	FREQ. (MHz)	EMISSION LEVEL (dBuV/m)	LIMIT (dBuV/m)	MARGIN (dB)	ANTENNA HEIGHT (m)	TABLE ANGLE (Degree)	RAW VALUE (dBuV)	CORRECTION FACTOR (dB/m)
1	#5714.99	63.1 PK	68.2	-5.1	1.73 V	260	52.68	10.43
2	#5725.00	65.2 PK	78.2	-13.0	1.73 V	260	54.82	10.40
3	*5775.00	94.9 PK			1.73 V	260	84.62	10.29
4	*5775.00	86.2 AV			1.73 V	260	75.95	10.29
5	#5850.00	63.9 PK	78.2	-14.3	1.73 V	260	53.60	10.29
6	#5860.10	62.8 PK	68.2	-5.4	1.73 V	260	52.49	10.30
7	11550.00	61.4 PK	74.0	-12.6	2.53 V	283	39.10	22.33
8	11550.00	49.8 AV	54.0	-4.2	2.53 V	283	27.48	22.33

REMARKS:

1. Emission Level(dBuV/m) = Raw Value(dBuV) + Correction Factor(dB/m)
2. Correction Factor(dB/m) = Antenna Factor(dB/m) + Cable Factor(dB) – Pre-Amplifier Factor(dB)
3. The other emission levels were very low against the limit.
4. Margin value = Emission Level – Limit value
5. " * ": Fundamental frequency.
6. " # ": The radiated frequency is out of the restricted band.

BELOW 1GHz WORST-CASE DATA
802.11n (40MHz)

CHANNEL	TX Channel 159	DETECTOR FUNCTION	Quasi-Peak (QP)
FREQUENCY RANGE	30MHz ~ 1GHz		

ANTENNA POLARITY & TEST DISTANCE: HORIZONTAL AT 3 M

NO.	FREQ. (MHz)	EMISSION LEVEL (dBuV/m)	LIMIT (dBuV/m)	MARGIN (dB)	ANTENNA HEIGHT (m)	TABLE ANGLE (Degree)	RAW VALUE (dBuV)	CORRECTION FACTOR (dB/m)
1	30.44	32.0 QP	40.0	-8.0	4.00 H	91	43.50	-11.49
2	70.35	32.0 QP	40.0	-8.0	4.00 H	227	43.43	-11.40
3	98.14	33.4 QP	43.5	-10.1	4.00 H	252	47.86	-14.47
4	163.47	32.1 QP	43.5	-11.4	3.81 H	250	41.48	-9.35
5	223.61	32.9 QP	46.0	-13.1	2.94 H	79	44.71	-11.81
6	579.99	39.6 QP	46.0	-6.4	1.36 H	104	41.64	-2.05
7	901.88	37.4 QP	46.0	-8.6	1.00 H	81	34.04	3.34

ANTENNA POLARITY & TEST DISTANCE: VERTICAL AT 3 M

NO.	FREQ. (MHz)	EMISSION LEVEL (dBuV/m)	LIMIT (dBuV/m)	MARGIN (dB)	ANTENNA HEIGHT (m)	TABLE ANGLE (Degree)	RAW VALUE (dBuV)	CORRECTION FACTOR (dB/m)
1	35.26	38.7 QP	40.0	-1.3	1.33 V	131	49.76	-11.03
2	62.64	37.9 QP	40.0	-2.1	1.25 V	0	48.30	-10.39
3	125.01	36.7 QP	43.5	-6.9	1.00 V	125	48.13	-11.48
4	258.14	31.6 QP	46.0	-14.4	2.06 V	121	40.88	-9.25
5	386.72	31.0 QP	46.0	-15.0	2.43 V	111	36.80	-5.81
6	575.53	37.7 QP	46.0	-8.3	2.88 V	136	39.80	-2.10
7	966.68	36.6 QP	54.0	-17.5	3.17 V	116	31.54	5.01

REMARKS:

1. Emission Level(dBuV/m) = Raw Value(dBuV) + Correction Factor(dB/m)
2. Correction Factor(dB/m) = Antenna Factor(dB/m) + Cable Factor(dB) – Pre-Amplifier Factor(dB)
3. The other emission levels were very low against the limit.
4. Margin value = Emission Level – Limit value

4.2 Conducted Emission Measurement

4.2.1 Limits of Conducted Emission Measurement

Frequency (MHz)	Conducted Limit (dBuV)	
	Quasi-peak	Average
0.15 - 0.5	66 - 56	56 - 46
0.50 - 5.0	56	46
5.0 - 30.0	60	50

Note: 1. The lower limit shall apply at the transition frequencies.

2. The limit decreases in line with the logarithm of the frequency in the range of 0.15 to 0.50MHz.

4.2.2 Test Instruments

Description & Manufacturer	Model No.	Serial No.	Cal. Date	Cal. Due
ROHDE & SCHWARZ TEST RECEIVER	ESCS 30	100276	Apr. 01, 2015	Mar. 31, 2016
ROHDE & SCHWARZ Artificial Mains Network (for EUT)	ENV216	101197	Apr. 27, 2015	Apr. 26, 2016
LISN With Adapter (for EUT)	AD10	C10Ada-002	Apr. 27, 2015	Apr. 26, 2016
ROHDE & SCHWARZ Artificial Mains Network (for peripherals)	ESH3-Z5	100218	Nov. 25, 2015	Nov. 24, 2016
SCHWARZBECK Artificial Mains Network (For EUT)	NNLK8129	8129229	May 06, 2015	May 05, 2016
Software	Cond_V7.3.7	NA	NA	NA
RF cable (JYEBAO) With 10dB PAD	5D-FB	Cable-C10.01	Feb. 15, 2016	Feb. 14, 2017
SUHNER Terminator (For ROHDE & SCHWARZ LISN)	65BNC-5001	E1-011484	May 19, 2015	May 18, 2016
ROHDE & SCHWARZ Artificial Mains Network (For TV EUT)	ESH3-Z5	100220	Nov. 13, 2015	Nov. 12, 2016
LISN With Adapter (for TV EUT)	100220	N/A	Nov. 13, 2015	Nov. 12, 2016

Notes: 1. The calibration interval of the above test instruments is 12 months and the calibrations are traceable to NML/ROC and NIST/USA.

2. The test was performed in Shielded Room No. 10.

3. The VCCI Site Registration No. C-1852.

4.2.3 Test Procedure

- a. The EUT was placed 0.4 meters from the conducting wall of the shielded room with EUT being connected to the power mains through a line impedance stabilization network (LISN). Other support units were connected to the power mains through another LISN. The two LISNs provide 50 ohm/ 50uH of coupling impedance for the measuring instrument.
- b. Both lines of the power mains connected to the EUT were checked for maximum conducted interference.
- c. The frequency range from 150kHz to 30MHz was searched. Emission levels under (Limit - 20dB) was not recorded.

NOTE: All modes of operation were investigated and the worst-case emissions are reported.

4.2.4 Deviation from Test Standard

No deviation.

4.2.5 Test Setup

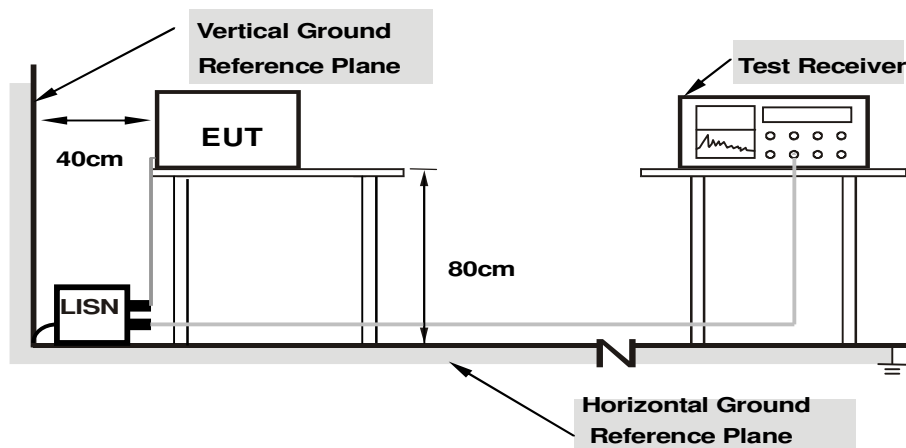

- Note:**
- 1.Support units were connected to second LISN.
 - 2.Both of LISNs (AMN) are 80 cm from EUT and at least 80 from other units and other metal planes

For the actual test configuration, please refer to the attached file (Test Setup Photo).

4.2.6 EUT Operating Condition

Same as 4.1.6.

4.2.7 Test Results

Mode A

802.11n (40MHz): CH159

Phase	Line (L)	Detector Function	Quasi-Peak (QP) / Average (AV)
-------	----------	-------------------	--------------------------------

No	Frequency (MHz)	Correction Factor (dB)	Reading Value (dBUV)		Emission Level (dBUV)		Limit (dBUV)		Margin (dB)	
			Q.P.	AV.	Q.P.	AV.	Q.P.	AV.	Q.P.	AV.
1	0.15000	9.66	49.54	37.53	59.20	47.19	66.00	56.00	-6.80	-8.81
2	0.18125	9.65	43.22	32.28	52.87	41.93	64.43	54.43	-11.55	-12.49
3	0.23203	9.65	38.51	28.28	48.16	37.93	62.38	52.38	-14.21	-14.44
4	0.39336	9.68	32.94	28.04	42.62	37.72	57.99	47.99	-15.37	-10.27
5	1.90234	9.86	13.48	7.60	23.34	17.46	56.00	46.00	-32.66	-28.54
6	12.49219	10.16	29.59	24.56	39.75	34.72	60.00	50.00	-20.25	-15.28

Remarks:

1. Q.P. and AV. are abbreviations of quasi-peak and average individually.
2. The emission levels of other frequencies were very low against the limit.
3. Margin value = Emission level – Limit value
4. Correction factor = Insertion loss + Cable loss
5. Emission Level = Correction Factor + Reading Value

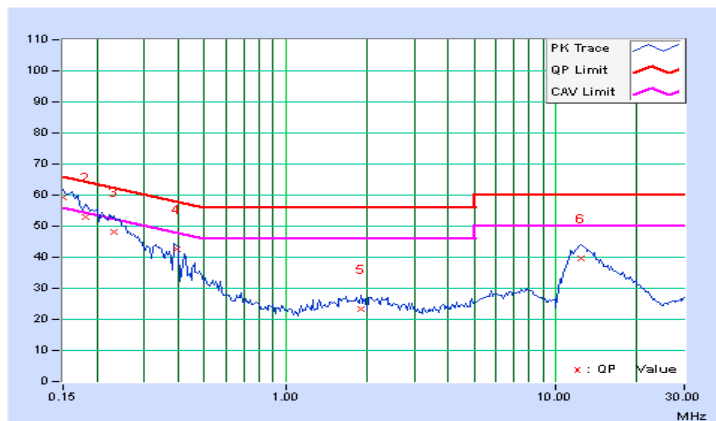

Phase	Neutral (N)	Detector Function	Quasi-Peak (QP) / Average (AV)
-------	-------------	-------------------	--------------------------------

No	Frequency (MHz)	Correction Factor (dB)	Reading Value (dBuV)		Emission Level (dBuV)		Limit (dBuV)		Margin (dB)	
			Q.P.	AV.	Q.P.	AV.	Q.P.	AV.	Q.P.	AV.
1	0.15000	9.69	49.13	38.72	58.82	48.41	66.00	56.00	-7.18	-7.59
2	0.20078	9.69	40.24	29.64	49.93	39.33	63.58	53.58	-13.65	-14.25
3	0.24766	9.70	36.62	26.03	46.32	35.73	61.84	51.84	-15.52	-16.11
4	0.39219	9.72	31.12	23.57	40.84	33.29	58.02	48.02	-17.18	-14.73
5	1.25391	9.82	16.83	9.95	26.65	19.77	56.00	46.00	-29.35	-26.23
6	12.60938	10.25	29.28	24.11	39.53	34.36	60.00	50.00	-20.47	-15.64

Remarks:

1. Q.P. and AV. are abbreviations of quasi-peak and average individually.
2. The emission levels of other frequencies were very low against the limit.
3. Margin value = Emission level – Limit value
4. Correction factor = Insertion loss + Cable loss
5. Emission Level = Correction Factor + Reading Value

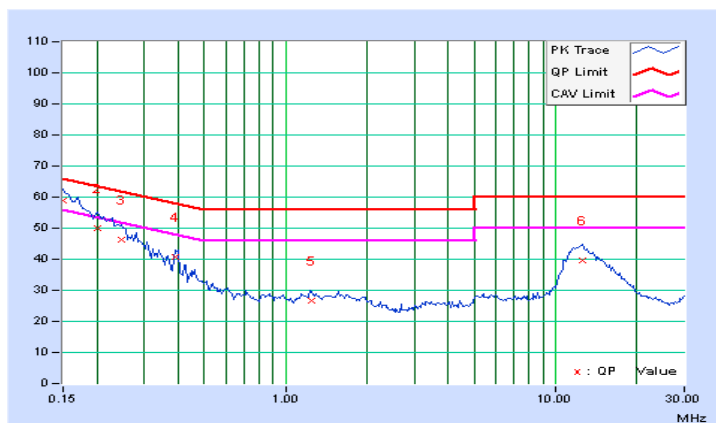

Mode B

802.11n (40MHz): CH159

Phase	Line (L)	Detector Function	Quasi-Peak (QP) / Average (AV)
-------	----------	-------------------	--------------------------------

No	Frequency (MHz)	Correction Factor (dB)	Reading Value (dBuV)		Emission Level (dBuV)		Limit (dBuV)		Margin (dB)	
			Q.P.	AV.	Q.P.	AV.	Q.P.	AV.	Q.P.	AV.
1	0.15000	9.66	49.17	37.12	58.83	46.78	66.00	56.00	-7.17	-9.22
2	0.16562	9.66	41.48	29.02	51.14	38.68	65.18	55.18	-14.04	-16.50
3	0.18906	9.65	37.48	24.51	47.13	34.16	64.08	54.08	-16.95	-19.92
4	0.22422	9.65	30.43	17.87	40.08	27.52	62.66	52.66	-22.58	-25.14
5	0.28281	9.66	32.83	15.26	42.49	24.92	60.73	50.73	-18.24	-25.81
6	0.38438	9.68	25.60	18.11	35.28	27.79	58.18	48.18	-22.91	-20.40
7	7.16016	10.06	20.42	14.52	30.48	24.58	60.00	50.00	-29.52	-25.42

Remarks:

1. Q.P. and AV. are abbreviations of quasi-peak and average individually.
2. The emission levels of other frequencies were very low against the limit.
3. Margin value = Emission level – Limit value
4. Correction factor = Insertion loss + Cable loss
5. Emission Level = Correction Factor + Reading Value

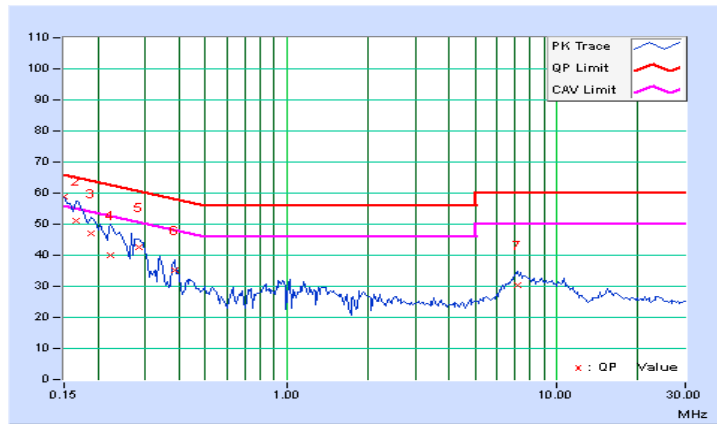

Phase	Neutral (N)	Detector Function	Quasi-Peak (QP) / Average (AV)
-------	-------------	-------------------	--------------------------------

No	Frequency (MHz)	Correction Factor (dB)	Reading Value (dBuV)		Emission Level (dBuV)		Limit (dBuV)		Margin (dB)	
			Q.P.	AV.	Q.P.	AV.	Q.P.	AV.	Q.P.	AV.
1	0.15000	9.69	48.07	36.58	57.76	46.27	66.00	56.00	-8.24	-9.73
2	0.17344	9.69	40.60	32.60	50.29	42.29	64.79	54.79	-14.50	-12.50
3	0.19297	9.69	40.48	28.93	50.17	38.62	63.91	53.91	-13.74	-15.29
4	0.23594	9.70	35.03	24.48	44.73	34.18	62.24	52.24	-17.51	-18.06
5	0.29453	9.70	32.86	26.49	42.56	36.19	60.40	50.40	-17.83	-14.20
6	0.38438	9.72	27.90	20.81	37.62	30.53	58.18	48.18	-20.57	-17.66
7	11.20703	10.22	17.36	11.43	27.58	21.65	60.00	50.00	-32.42	-28.35

Remarks:

1. Q.P. and AV. are abbreviations of quasi-peak and average individually.
2. The emission levels of other frequencies were very low against the limit.
3. Margin value = Emission level – Limit value
4. Correction factor = Insertion loss + Cable loss
5. Emission Level = Correction Factor + Reading Value

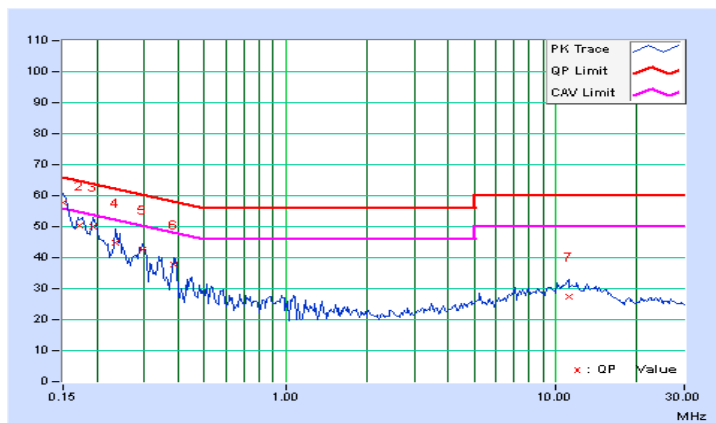

4.3 Transmit Power Measurement

4.3.1 Limits of Transmit Power Measurement

Operation Band	EUT Category		LIMIT
U-NII-1		Outdoor Access Point	1 Watt (30 dBm) (Max. e.i.r.p \leq 125mW(21 dBm) at any elevation angle above 30 degrees as measured from the horizon)
		Fixed point-to-point Access Point	1 Watt (30 dBm)
	√	Indoor Access Point	1 Watt (30 dBm)
		Mobile and Portable client device	250mW (24 dBm)
U-NII-2A	---		250mW (24 dBm) or 11 dBm+10 log B*
U-NII-2C	---		250mW (24 dBm) or 11 dBm+10 log B*
U-NII-3	√		1 Watt (30 dBm)

*B is the 26 dB emission bandwidth in megahertz

Per KDB 662911 Method of conducted output power measurement on IEEE 802.11 devices,

Array Gain = 0 dB (i.e., no array gain) for $N_{ANT} \leq 4$;

Array Gain = 0 dB (i.e., no array gain) for channel widths ≥ 40 MHz for any N_{ANT} ;

Array Gain = $5 \log(N_{ANT}/N_{SS})$ dB or 3 dB, whichever is less for 20-MHz channel widths with $N_{ANT} \geq 5$.

For power measurements on all other devices: Array Gain = $10 \log(N_{ANT}/N_{SS})$ dB.

4.3.2 Test Setup

FOR POWER OUTPUT MEASUREMENT

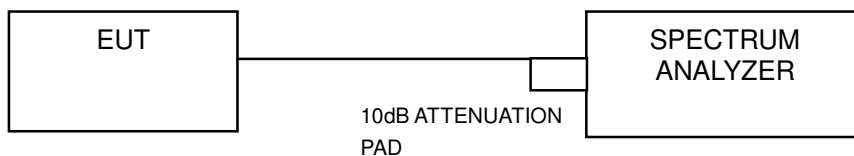

FOR 26dB & OCCUPIED BANDWIDTH

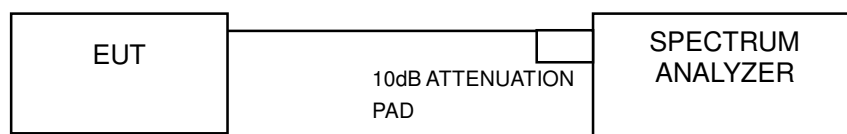

4.3.3 Test Instruments

Refer to section 4.1.2 to get information of above instrument.

4.3.4 Test Procedure

FOR AVERAGE POWER MEASUREMENT

For 802.11a, 802.11n (20MHz), 802.11n (40MHz)

Method PM is used to perform output power measurement, trigger and gating function of wide band power meter is enabled to measure max output power of TX on burst. Duty factor is not added to measured value.

For 802.11ac (80MHz)

- 1) Set span to encompass the entire 26 dB EBW (or, alternatively, the entire 99% occupied bandwidth) of the signal.
- 2) Set sweep trigger to "free run".
- 3) Set RBW = 1 MHz.
- 4) Set VBW \geq 3 MHz
- 5) Number of points in sweep \geq 2 Span / RBW.
- 6) Sweep time \leq (number of points in sweep) * T
- 7) Using emission bandwidth to determine the frequency span for integration the channel bandwidth.
- 8) Detector = RMS.
- 9) Trace mode = max hold.
- 10) Allow max hold to run for at least 60 seconds, or longer as needed to allow the trace to stabilize.

FOR 26dB BANDWIDTH

- 1) Set RBW = approximately 1% of the emission bandwidth.
- 2) Set the VBW > RBW.
- 3) Detector = Peak.
- 4) Trace mode = max hold.
- 5) Measure the maximum width of the emission that is 26 dB down from the peak of the emission. Compare this with the RBW setting of the analyzer. Readjust RBW and repeat measurement as needed until the RBW/EBW ratio is approximately 1%.

FOR OCCUPIED BANDWIDTH

The transmitter output was connected to the spectrum analyzer through an attenuator. The bandwidth of the fundamental frequency was measured by spectrum analyzer with resolution bandwidth in the range of 1% to 5% of the anticipated emission bandwidth, and a video bandwidth at least 3x the resolution bandwidth and set the detector to AVERAGE. The width of a frequency band such that, below the lower and above the upper frequency limits, the mean powers emitted are each equal to a specified percentage 0.5 %of the total mean power of a given emission.

4.3.5 Deviation from Test Standard

No deviation.

4.3.6 EUT Operating Condition

The software provided by client to enable the EUT under transmission condition continuously at lowest, middle and highest channel frequencies individually.

4.3.7 Test Result

POWER OUTPUT:

Mode A

802.11a

CHAN.	CHAN. FREQ. (MHz)	MAXIMUM CONDUCTED POWER (dBm)			TOTAL POWER (mW)	TOTAL POWER (dBm)	POWER LIMIT (dBm)	PASS / FAIL
		CHAIN 0	CHAIN 1	CHAIN 2				
36	5180	19.37	18.92	18.95	243.004	23.86	30	PASS
40	5200	19.03	18.62	18.60	225.205	23.53	30	PASS
48	5240	19.68	19.52	19.47	270.945	24.33	30	PASS
149	5745	17.89	17.86	17.82	183.146	22.63	30	PASS
157	5785	19.83	19.76	19.72	284.541	24.54	30	PASS
165	5825	20.88	20.85	20.82	364.862	25.62	30	PASS

802.11n (20MHz)

CHAN.	CHAN. FREQ. (MHz)	MAXIMUM CONDUCTED POWER (dBm)			TOTAL POWER (mW)	TOTAL POWER (dBm)	POWER LIMIT (dBm)	PASS / FAIL
		CHAIN 0	CHAIN 1	CHAIN 2				
36	5180	18.82	18.53	18.48	217.962	23.38	30	PASS
40	5200	19.24	18.88	18.80	237.072	23.75	30	PASS
48	5240	20.11	19.82	19.76	293.129	24.67	30	PASS
149	5745	16.21	16.19	16.13	124.394	20.95	30	PASS
157	5785	20.89	20.86	20.81	365.147	25.62	30	PASS
165	5825	21.08	21.04	20.99	380.893	25.81	30	PASS

802.11n (40MHz)

CHAN.	CHAN. FREQ. (MHz)	MAXIMUM CONDUCTED POWER (dBm)			TOTAL POWER (mW)	TOTAL POWER (dBm)	POWER LIMIT (dBm)	PASS / FAIL
		CHAIN 0	CHAIN 1	CHAIN 2				
38	5190	18.29	17.94	17.91	191.485	22.82	30	PASS
46	5230	19.94	19.79	19.67	286.591	24.57	30	PASS
151	5755	14.41	14.37	14.32	81.999	19.14	30	PASS
159	5795	21.38	21.31	21.27	406.579	26.09	30	PASS

802.11ac (80MHz)

CHAN.	CHAN. FREQ. (MHz)	MAXIMUM CONDUCTED POWER (dBm)			TOTAL POWER (mW)	TOTAL POWER (dBm)	POWER LIMIT (dBm)	PASS / FAIL
		CHAIN 0	CHAIN 1	CHAIN 2				
42	5210	16.45	16.16	16.09	126.106	21.01	30	PASS
155	5775	15.39	15.36	15.29	102.756	20.12	30	PASS

26dB BANDWIDTH:
Mode A
802.11a

CHANNEL	CHANNEL FREQUENCY (MHz)	26dBc BANDWIDTH (MHz)			PASS / FAIL
		CHAIN 0	CHAIN 1	CHAIN 2	
36	5180	34.81	34.66	34.61	PASS
40	5200	26.82	28.83	29.38	PASS
48	5240	35.72	35.64	35.77	PASS

802.11n (20MHz)

CHANNEL	CHANNEL FREQUENCY (MHz)	26dBc BANDWIDTH (MHz)			PASS / FAIL
		CHAIN 0	CHAIN 1	CHAIN 2	
36	5180	28.32	28.11	27.39	PASS
40	5200	28.15	28.27	28.35	PASS
48	5240	43.07	43.13	43.04	PASS

802.11n (40MHz)

CHANNEL	CHANNEL FREQUENCY (MHz)	26dBc BANDWIDTH (MHz)			PASS / FAIL
		CHAIN 0	CHAIN 1	CHAIN 2	
38	5190	44.92	47.09	44.75	PASS
46	5230	77.18	77.10	77.16	PASS

802.11ac (80MHz)

CHANNEL	CHANNEL FREQUENCY (MHz)	26dBc BANDWIDTH (MHz)			PASS / FAIL
		CHAIN 0	CHAIN 1	CHAIN 2	
42	5210	81.57	81.43	81.61	PASS

SPECTRUM PLOT OF WORST VALUE

802.11a

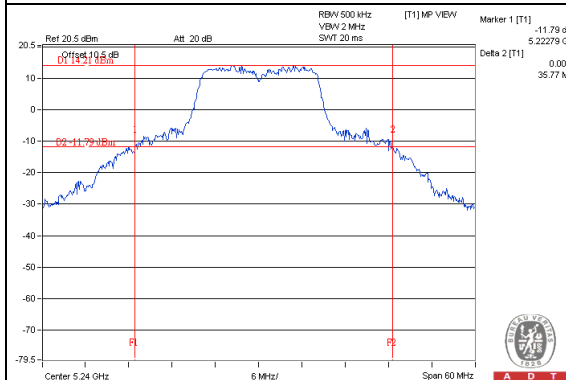

802.11n (20MHz)

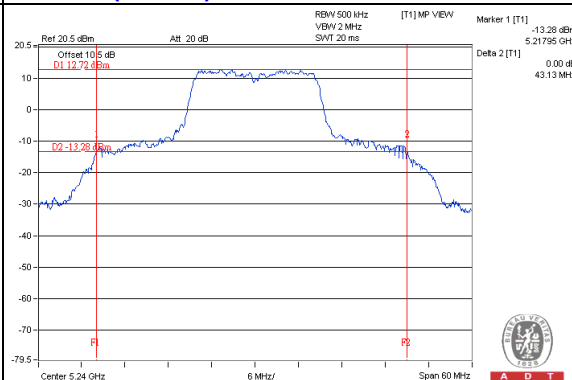

802.11n (40MHz)

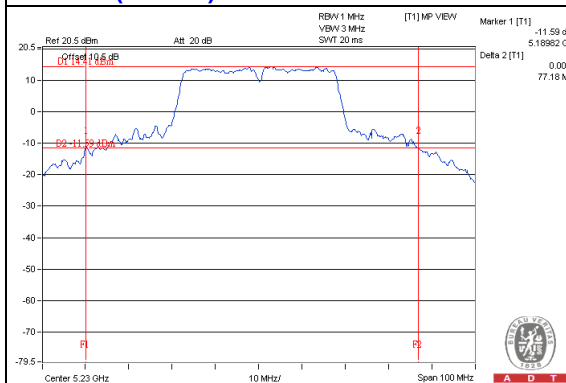

802.11ac (80MHz)

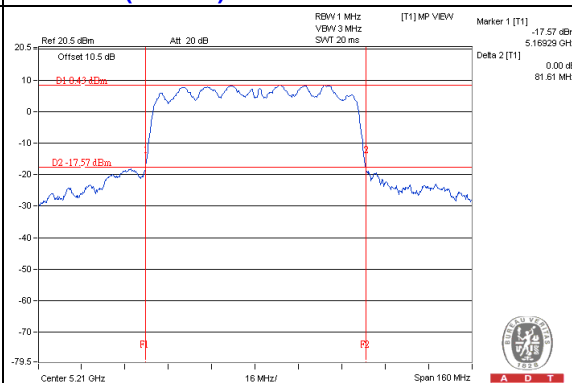

OCCUPIED BANDWIDTH:
Mode A
802.11a

CHANNEL	CHANNEL FREQUENCY (MHz)	OCCUPIED BANDWIDTH (MHz)			PASS / FAIL
		CHAIN 0	CHAIN 1	CHAIN 2	
36	5180	17.28	17.28	17.28	PASS
40	5200	17.04	17.04	17.16	PASS
48	5240	17.40	17.28	17.28	PASS
149	5745	17.04	16.90	17.00	PASS
157	5785	17.30	17.30	17.30	PASS
165	5825	20.70	19.90	19.60	PASS

802.11n (20MHz)

CHANNEL	CHANNEL FREQUENCY (MHz)	OCCUPIED BANDWIDTH (MHz)			PASS / FAIL
		CHAIN 0	CHAIN 1	CHAIN 2	
36	5180	17.88	18.00	18.00	PASS
40	5200	18.00	18.00	18.00	PASS
48	5240	18.24	18.24	18.24	PASS
149	5745	17.74	17.80	17.80	PASS
157	5785	19.90	19.30	19.30	PASS
165	5825	22.60	21.30	21.30	PASS

802.11n (40MHz)

CHANNEL	CHANNEL FREQUENCY (MHz)	OCCUPIED BANDWIDTH (MHz)			PASS / FAIL
		CHAIN 0	CHAIN 1	CHAIN 2	
38	5190	37.00	37.00	37.00	PASS
46	5230	37.60	37.20	37.40	PASS
151	5755	36.81	36.83	36.83	PASS
159	5795	41.74	41.50	41.33	PASS

802.11ac (80MHz)

CHANNEL	CHANNEL FREQUENCY (MHz)	OCCUPIED BANDWIDTH (MHz)			PASS / FAIL
		CHAIN 0	CHAIN 1	CHAIN 2	
42	5210	75.12	75.12	75.12	PASS
155	5775	75.07	75.04	75.04	PASS

SPECTRUM PLOT OF WORST VALUE

802.11a

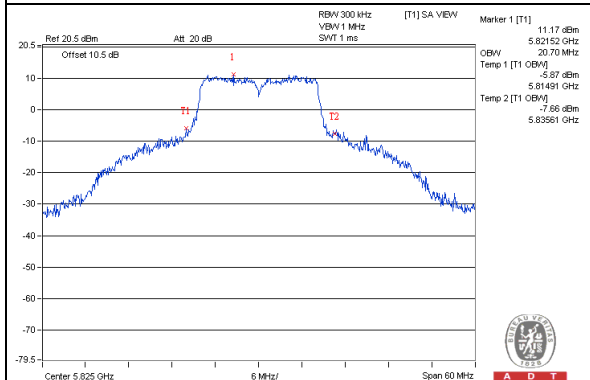

802.11n (20MHz)

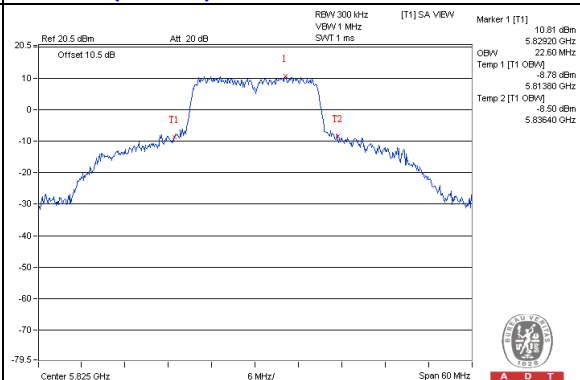

802.11n (40MHz)

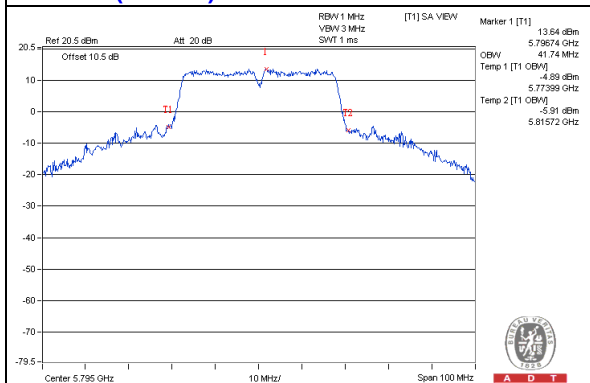

802.11ac (80MHz)

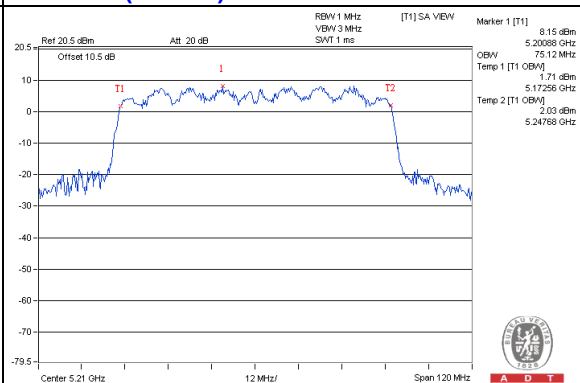

4.4 Peak Power Spectral Density Measurement

4.4.1 Limits of Peak Power Spectral Density Measurement

Operation Band	EUT Category		LIMIT
U-NII-1		Outdoor Access Point	17dBm/ MHz
		Fixed point-to-point Access Point	
	√	Indoor Access Point	
		Mobile and Portable client device	11dBm/ MHz
U-NII-2A	---		11dBm/ MHz
U-NII-2C	---		11dBm/ MHz
U-NII-3	√		30dBm/ 500kHz

4.4.2 Test Setup

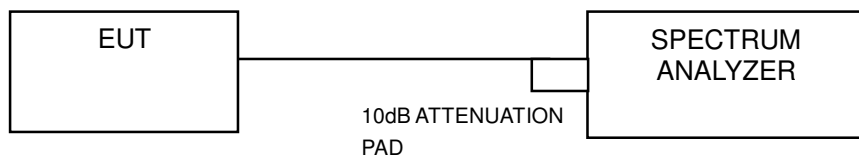

4.4.3 Test Instruments

Refer to section 4.1.2 to get information of above instrument.

4.4.4 Test Procedure

For U-NII-1 band:

Using method SA-2

1. Set span to encompass the entire emission bandwidth (EBW) of the signal.
2. Set RBW = 1 MHz, Set VBW \geq 3 MHz, Detector = RMS
3. Sweep time = auto, trigger set to "free run".
4. Trace average at least 100 traces in power averaging mode.
5. Record the max value and add 10 log (1/duty cycle)

For U-NII-3 band:

- 1) Set span to encompass the entire emission bandwidth (EBW) of the signal.
- 2) Set RBW = 500 kHz, Set VBW \geq 3 RBW, Detector = RMS
- 3) Sweep time = auto, trigger set to "free run".
- 4) Trace average at least 100 traces in power averaging mode.
- 5) Record the max value and add 10 log (1/duty cycle)

4.4.5 Deviation from Test Standard

No deviation.

4.4.6 EUT Operating Condition

Same as Item 4.3.6.

4.4.7 Test Results

Mode A

802.11a

CHAN.	CHAN. FREQ. (MHz)	PSD (dBm)			TOTAL PSD W/O DUTY FACTOR (dBm)	DUTY FACTOR	TOTAL PSD WITH DUTY FACTOR (dBm)	MAX. LIMIT (dBm)	PASS / FAIL
		CHAIN 0	CHAIN 1	CHAIN 2					
36	5180	6.68	6.05	6.03	11.03	0.42	11.45	15.18	PASS
40	5200	5.45	5.55	5.87	10.40	0.42	10.82	15.18	PASS
48	5240	6.33	5.93	5.78	10.79	0.42	11.21	15.18	PASS

NOTE:

- Method 1 of power density measurement of KDB 662911 is using for calculating total power density. Total power density is summing entire spectra across corresponding frequency bins on the various outputs by computer.
- For U-NII-1 Band:**
 $\text{Directional gain} = 3.05\text{dBi} + 10\log(4.77) = 7.82\text{dBi} > 6\text{dBi}$, so the power density limit shall be reduced to $17-(7.82-6) = 15.18\text{dBm}$.
- Refer to section 3.3 for duty cycle spectrum plot.

802.11n (20MHz)

CHAN.	CHAN. FREQ. (MHz)	PSD (dBm)			TOTAL PSD W/O DUTY FACTOR (dBm)	DUTY FACTOR	TOTAL PSD WITH DUTY FACTOR (dBm)	MAX. LIMIT (dBm)	PASS / FAIL
		CHAIN 0	CHAIN 1	CHAIN 2					
36	5180	5.03	4.93	4.84	9.70	0.30	10.00	15.18	PASS
40	5200	5.12	5.04	5.25	9.91	0.30	10.21	15.18	PASS
48	5240	6.41	6.00	5.89	10.87	0.30	11.17	15.18	PASS

NOTE:

- Method 1 of power density measurement of KDB 662911 is using for calculating total power density. Total power density is summing entire spectra across corresponding frequency bins on the various outputs by computer.
- For U-NII-1 Band:**
 $\text{Directional gain} = 3.05\text{dBi} + 10\log(4.77) = 7.82\text{dBi} > 6\text{dBi}$, so the power density limit shall be reduced to $17-(7.82-6) = 15.18\text{dBm}$.
- Refer to section 3.3 for duty cycle spectrum plot.

802.11n (40MHz)

CHAN.	CHAN. FREQ. (MHz)	PSD (dBm)			TOTAL PSD W/O DUTY FACTOR (dBm)	DUTY FACTOR	TOTAL PSD WITH DUTY FACTOR (dBm)	MAX. LIMIT (dBm)	PASS / FAIL
		CHAIN 0	CHAIN 1	CHAIN 2					
38	5190	0.28	-0.04	-0.17	4.79	0.70	5.49	15.18	PASS
46	5230	2.89	2.49	2.22	7.31	0.70	8.01	15.18	PASS

NOTE:

- Method 1 of power density measurement of KDB 662911 is using for calculating total power density. Total power density is summing entire spectra across corresponding frequency bins on the various outputs by computer.
- For U-NII-1 Band:**
Directional gain = $3.05\text{dBi} + 10\log(4.77) = 7.82\text{dBi} > 6\text{dBi}$, so the power density limit shall be reduced to $17-(7.82-6) = 15.18\text{dBm}$.
- Refer to section 3.3 for duty cycle spectrum plot.

802.11ac (80MHz)

CHAN.	CHAN. FREQ. (MHz)	PSD (dBm)			TOTAL PSD W/O DUTY FACTOR (dBm)	DUTY FACTOR	TOTAL PSD WITH DUTY FACTOR (dBm)	MAX. LIMIT (dBm)	PASS / FAIL
		CHAIN 0	CHAIN 1	CHAIN 2					
42	5210	-1.28	-1.80	-1.98	3.09	1.25	4.34	15.18	PASS

NOTE:

- Method 1 of power density measurement of KDB 662911 is using for calculating total power density. Total power density is summing entire spectra across corresponding frequency bins on the various outputs by computer.
- For U-NII-1 Band:**
Directional gain = $3.05\text{dBi} + 10\log(4.77) = 7.82\text{dBi} > 6\text{dBi}$, so the power density limit shall be reduced to $17-(7.82-6) = 15.18\text{dBm}$.
- Refer to section 3.3 for duty cycle spectrum plot.

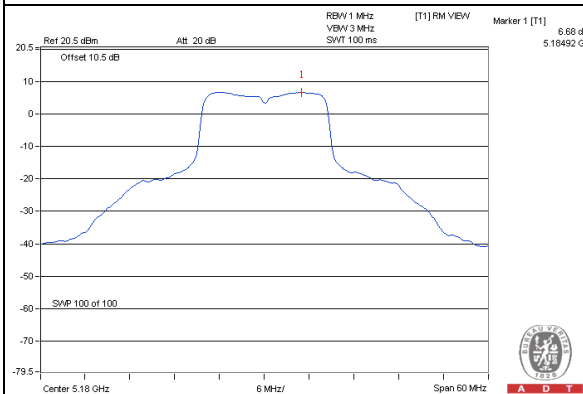
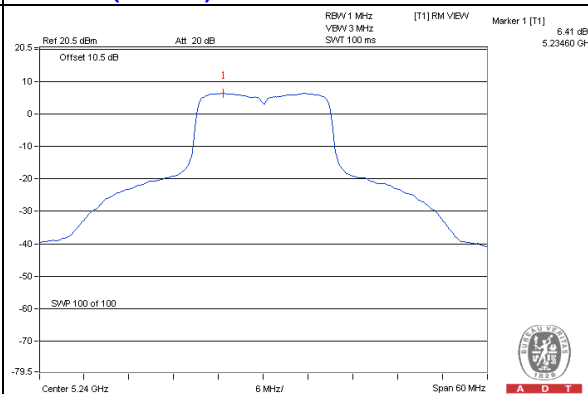
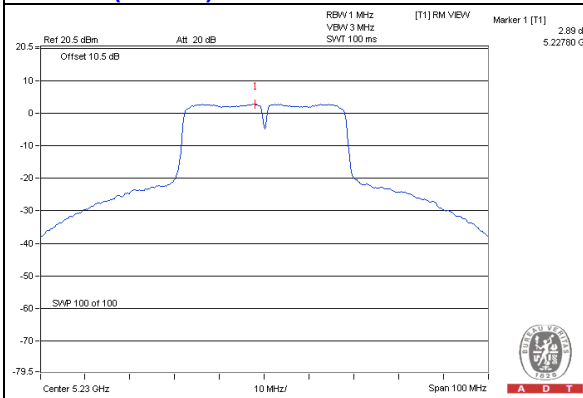
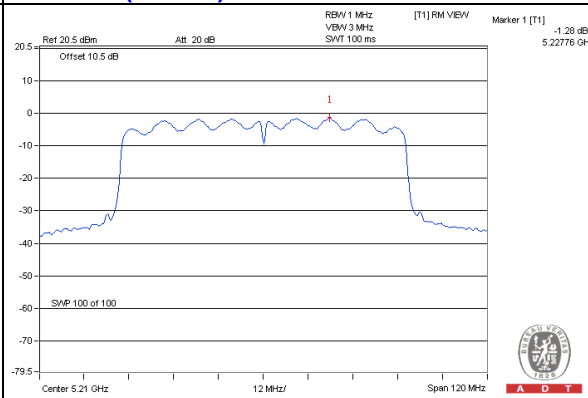
SPECTRUM PLOT OF WORST VALUE
802.11a

802.11n (20MHz)

802.11n (40MHz)

802.11ac (80MHz)

For U-NII-3 Band

802.11a

TX chain	Channel	Freq. (MHz)	PSD (dBm/500kHz)	10 log (N=3) dB	DUTY FACTOR	Total PSD (dBm/500kHz)	Limit (dBm/500kHz)	PASS /FAIL
0	149	5745	11.92	4.77	0.42	17.11	28.18	PASS
	157	5785	12.61	4.77	0.42	17.80	28.18	PASS
	165	5825	13.97	4.77	0.42	19.16	28.18	PASS
1	149	5745	11.45	4.77	0.42	16.64	28.18	PASS
	157	5785	12.59	4.77	0.42	17.78	28.18	PASS
	165	5825	13.84	4.77	0.42	19.03	28.18	PASS
2	149	5745	11.42	4.77	0.42	16.61	28.18	PASS
	157	5785	12.57	4.77	0.42	17.76	28.18	PASS
	165	5825	13.83	4.77	0.42	19.02	28.18	PASS

NOTE:

- Directional gain = $3.05\text{dBi} + 10\log(4.77) = 7.82\text{dBi} > 6\text{dBi}$, so the power density limit shall be reduced to $30 - (7.82 - 6) = 28.18\text{dBm}$.
- Refer to section 3.3 for duty cycle spectrum plot.

802.11n (20MHz)

TX chain	Channel	Freq. (MHz)	PSD (dBm/500kHz)	10 log (N=3) dB	DUTY FACTOR	Total PSD (dBm/500kHz)	Limit (dBm/500kHz)	PASS /FAIL
0	149	5745	8.51	4.77	0.30	13.58	28.18	PASS
	157	5785	12.80	4.77	0.30	17.87	28.18	PASS
	165	5825	13.17	4.77	0.30	18.24	28.18	PASS
1	149	5745	8.15	4.77	0.30	13.22	28.18	PASS
	157	5785	12.70	4.77	0.30	17.77	28.18	PASS
	165	5825	13.09	4.77	0.30	18.16	28.18	PASS
2	149	5745	8.21	4.77	0.30	13.28	28.18	PASS
	157	5785	12.68	4.77	0.30	17.75	28.18	PASS
	165	5825	13.06	4.77	0.30	18.13	28.18	PASS

NOTE:

- Directional gain = $3.05\text{dBi} + 10\log(4.77) = 7.82\text{dBi} > 6\text{dBi}$, so the power density limit shall be reduced to $30 - (7.82 - 6) = 28.18\text{dBm}$.
- Refer to section 3.3 for duty cycle spectrum plot.

802.11n (40MHz)

TX chain	Channel	Freq. (MHz)	PSD (dBm/500kHz)	10 log (N=3) dB	DUTY FACTOR	Total PSD (dBm/500kHz)	Limit (dBm/500kHz)	PASS /FAIL
0	151	5755	4.15	4.77	0.70	9.62	28.18	PASS
	159	5795	10.33	4.77	0.70	15.80	28.18	PASS
1	151	5755	3.83	4.77	0.70	9.30	28.18	PASS
	159	5795	10.31	4.77	0.70	15.78	28.18	PASS
2	151	5755	3.84	4.77	0.70	9.31	28.18	PASS
	159	5795	10.30	4.77	0.70	15.77	28.18	PASS

NOTE:

1. Directional gain = $3.05\text{dBi} + 10\log(4.77) = 7.82\text{dBi} > 6\text{dBi}$, so the power density limit shall be reduced to $30 - (7.82 - 6) = 28.18\text{dBm}$.
2. Refer to section 3.3 for duty cycle spectrum plot.

802.11ac (80MHz)

TX chain	Channel	Freq. (MHz)	PSD (dBm/500kHz)	10 log (N=3) dB	DUTY FACTOR	Total PSD (dBm/500kHz)	Limit (dBm/500kHz)	PASS /FAIL
0	155	5775	3.02	4.77	1.25	9.04	28.18	PASS
1	155	5775	2.64	4.77	1.25	8.66	28.18	PASS
2	155	5775	2.60	4.77	1.25	8.62	28.18	PASS

NOTE:

1. Directional gain = $3.05\text{dBi} + 10\log(4.77) = 7.82\text{dBi} > 6\text{dBi}$, so the power density limit shall be reduced to $30 - (7.82 - 6) = 28.18\text{dBm}$.
2. Refer to section 3.3 for duty cycle spectrum plot.

SPECTRUM PLOT OF WORST VALUE

802.11a

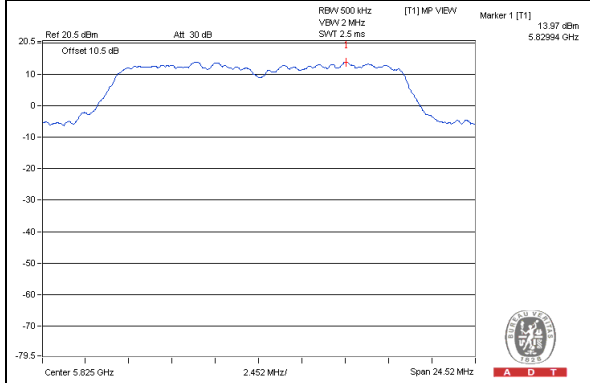

802.11n (20MHz)

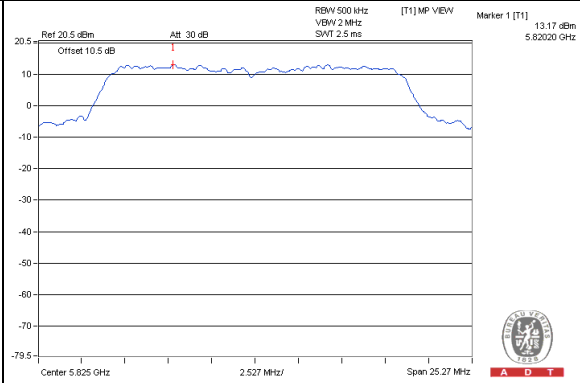

802.11n (40MHz)

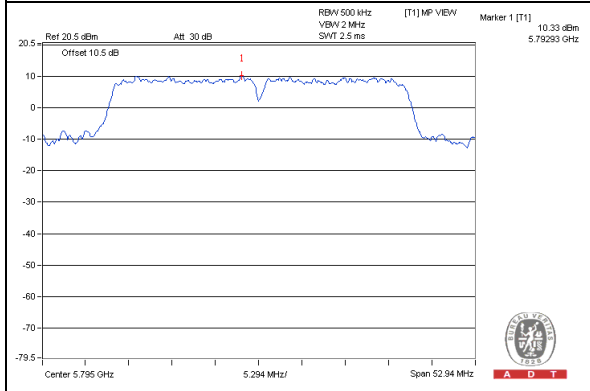

802.11ac (80MHz)

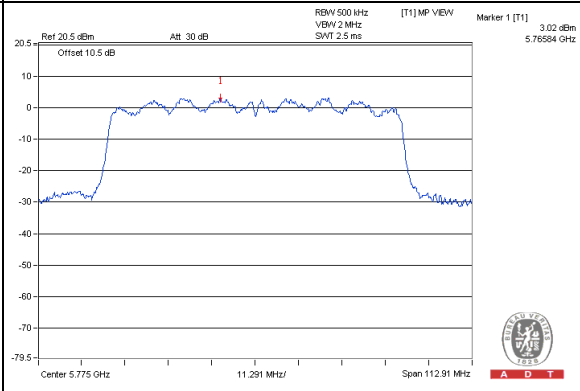

4.5 Frequency Stability Measurement

4.5.1 Limits of Frequency Stability Measurement

The frequency of the carrier signal shall be maintained within band of operation

4.5.2 Test Setup

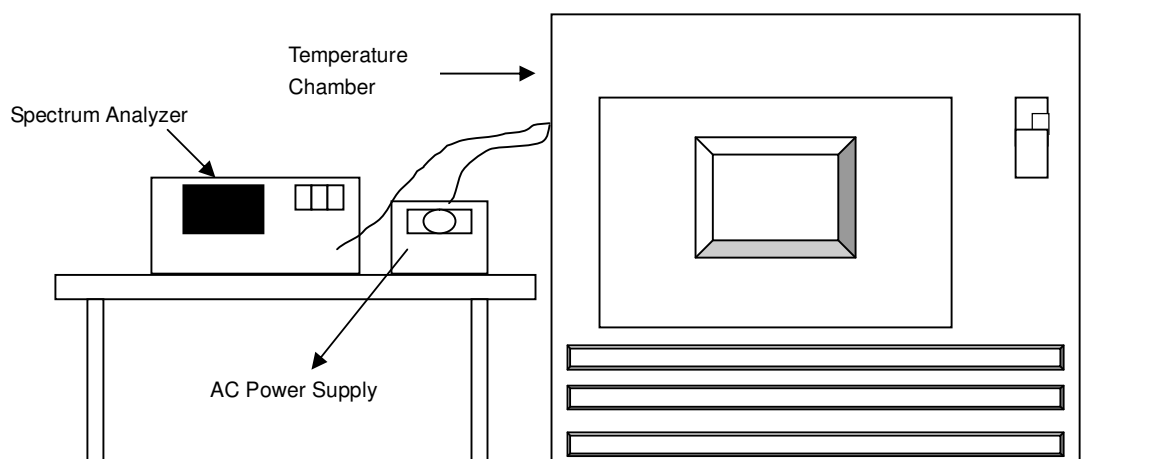

4.5.3 Test Instruments

Refer to section 4.1.2 to get information of above instrument.

4.5.4 Test Procedure

- The EUT was placed inside the environmental test chamber and powered by nominal AC voltage.
- Turn the EUT on and couple its output to a spectrum analyzer.
- Turn the EUT off and set the chamber to the highest temperature specified.
- Allow sufficient time (approximately 30 min) for the temperature of the chamber to stabilize, turn the EUT on and measure the operating frequency after 2, 5, and 10 minutes.
- Repeat step 2 and 3 with the temperature chamber set to the lowest temperature.
- The test chamber was allowed to stabilize at +20 degree C for a minimum of 30 minutes. The supply voltage was then adjusted on the EUT from 85% to 115% and the frequency record.

4.5.5 Deviation from Test Standard

No deviation.

4.5.6 EUT Operating Condition

Set the EUT transmit at un-modulation mode to test frequency stability.

4.5.7 Test Results

Mode A

FREQUENCY STABILITY VERSUS TEMP.									
OPERATING FREQUENCY: 5180MHz									
TEMP. (°C)	POWER SUPPLY (Vac)	0 MINUTE		2 MINUTE		5 MINUTE		10 MINUTE	
		Measured Frequency (MHz)	Frequency Drift (ppm)	Measured Frequency (MHz)	Frequency Drift (ppm)	Measured Frequency (MHz)	Frequency Drift (ppm)	Measured Frequency (MHz)	Frequency Drift (ppm)
50	120	5180.042618	8.2273168	5180.042235	8.1534749	5180.042461	8.1971094	5180.042616	8.2270270
40	120	5180.042647	8.2329783	5180.042696	8.2424710	5180.042750	8.2529119	5180.043016	8.3042471
30	120	5180.043233	8.3461960	5180.043175	8.3349421	5180.043319	8.3627417	5180.043329	8.3646718
20	120	5180.043046	8.3100526	5180.043191	8.3380309	5180.043387	8.3758164	5180.042969	8.2951737
10	120	5180.042711	8.2453397	5180.042578	8.2196911	5180.042691	8.2414391	5180.043066	8.3138996
0	120	5180.043014	8.3038041	5180.042938	8.2891892	5180.042958	8.2930668	5180.042633	8.2303089
-10	120	5180.043595	8.4159491	5180.043305	8.3600386	5180.043323	8.3635552	5180.043399	8.3781853
-20	120	5180.043668	8.4300813	5180.042725	8.2480695	5180.042976	8.2965251	5180.043052	8.3111969

FREQUENCY STABILITY VERSUS VOLTAGE									
OPERATING FREQUENCY: 5240MHz									
TEMP. (°C)	POWER SUPPLY (Vac)	0 MINUTE		2 MINUTE		5 MINUTE		10 MINUTE	
		Measured Frequency (MHz)	Frequency Drift (ppm)	Measured Frequency (MHz)	Frequency Drift (ppm)	Measured Frequency (MHz)	Frequency Drift (ppm)	Measured Frequency (MHz)	Frequency Drift (ppm)
20	138	5180.042959	8.2932272	5180.042766	8.2559846	5180.043119	8.3241164	5180.042842	8.2706564
	120	5180.043046	8.3100526	5180.043191	8.3380309	5180.043387	8.3758164	5180.042969	8.2951737
	102	5180.042947	8.2908432	5180.042512	8.2069498	5180.042638	8.2312694	5180.042769	8.2565637

4.6 6dB Bandwidth Measurement

4.6.1 Limits of 6dB Bandwidth Measurement

The minimum of 6dB Bandwidth Measurement is 0.5MHz.

4.6.2 Test Setup

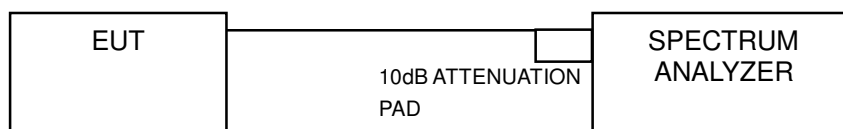

4.6.3 Test Instruments

Refer to section 4.1.2 to get information of above instrument.

4.6.4 Test Procedure

MEASUREMENT PROCEDURE REF

- a. Set resolution bandwidth (RBW) = 100kHz
- b. Set the video bandwidth (VBW) $\geq 3 \times$ RBW, Detector = Peak.
- c. Trace mode = max hold.
- d. Sweep = auto couple.
- e. Measure the maximum width of the emission that is constrained by the frequencies associated with the two amplitude points (upper and lower) that are attenuated by 6 dB relative to the maximum level measured in the fundamental emission

4.6.5 Deviation from Test Standard

No deviation.

4.6.6 EUT Operating Condition

The software provided by client to enable the EUT under transmission condition continuously at lowest, middle and highest channel frequencies individually.

4.6.7 Test Results

Mode A

802.11a

CHANNEL	FREQUENCY (MHz)	6dB BANDWIDTH (MHz)			MINIMUM LIMIT (MHz)	PASS / FAIL
		CHAIN 0	CHAIN 1	CHAIN 2		
149	5745	16.35	16.37	16.37	0.5	PASS
157	5785	16.37	16.38	16.37	0.5	PASS
165	5825	16.35	16.36	16.36	0.5	PASS

802.11n (20MHz)

CHANNEL	FREQUENCY (MHz)	6dB BANDWIDTH (MHz)			MINIMUM LIMIT (MHz)	PASS / FAIL
		CHAIN 0	CHAIN 1	CHAIN 2		
149	5745	17.07	16.98	16.99	0.5	PASS
157	5785	16.85	16.86	16.87	0.5	PASS
165	5825	16.85	16.85	16.84	0.5	PASS

802.11n (40MHz)

CHANNEL	FREQUENCY (MHz)	6dB BANDWIDTH (MHz)			MINIMUM LIMIT (MHz)	PASS / FAIL
		CHAIN 0	CHAIN 1	CHAIN 2		
151	5755	35.49	35.79	35.50	0.5	PASS
159	5795	35.30	35.28	35.27	0.5	PASS

802.11ac (80MHz)

CHANNEL	FREQUENCY (MHz)	6dB BANDWIDTH (MHz)			MINIMUM LIMIT (MHz)	PASS / FAIL
		CHAIN 0	CHAIN 1	CHAIN 2		
155	5775	75.28	75.32	75.32	0.5	PASS

SPECTRUM PLOT OF WORST VALUE

802.11a

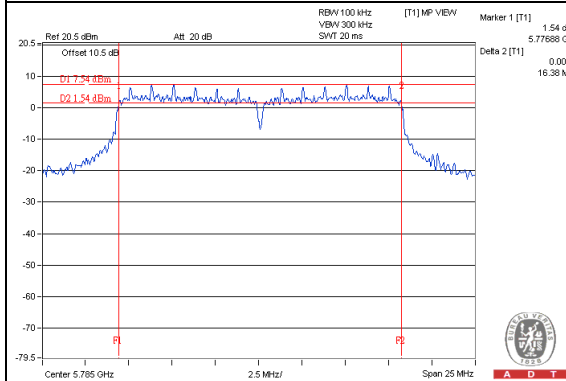

802.11n (20MHz)

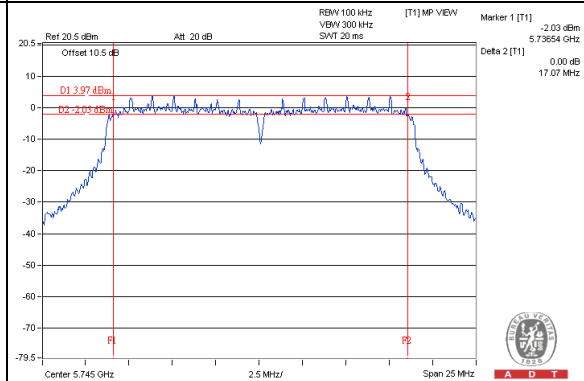

802.11n (40MHz)

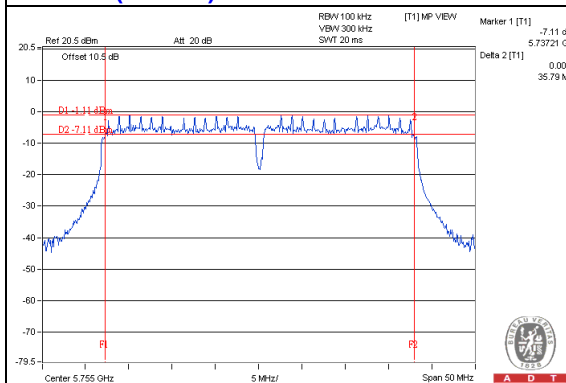

802.11ac (80MHz)

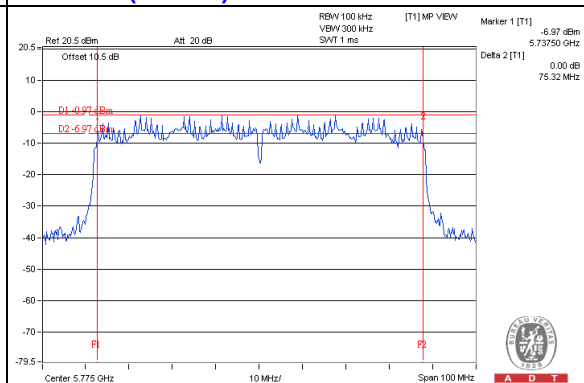

5 Pictures of Test Arrangements

Please refer to the attached file (Test Setup Photo).

Appendix – Information on the Testing Laboratories

We, Bureau Veritas Consumer Products Services (H.K.) Ltd., Taoyuan Branch, were founded in 1988 to provide our best service in EMC, Radio, Telecom and Safety consultation. Our laboratories are accredited and approved according to ISO/IEC 17025.

If you have any comments, please feel free to contact us at the following:

Linko EMC/RF Lab

Tel: 886-2-26052180

Fax: 886-2-26051924

Hsin Chu EMC/RF/Telecom Lab

Tel: 886-3-6668565

Fax: 886-3-6668323

Hwa Ya EMC/RF/Safety Lab

Tel: 886-3-3183232

Fax: 886-3-3270892

Email: service.adt@tw.bureauveritas.com

Web Site: www.bureauveritas-adt.com

The address and road map of all our labs can be found in our web site also.

--- END ---