



A D T

# FCC TEST REPORT (15.247)

**REPORT NO.:** RF110107E07I

**MODEL NO.:** F9K1108v1

**FCC ID:** K7SF9K1108V1

**RECEIVED:** Jan. 05, 2011

**TESTED:** Jan. 12 to Feb. 08, 2011 and May 19, 2011

**ISSUED:** Aug. 29, 2011

**APPLICANT:** Belkin International, Inc.

**ADDRESS:** 12045 East Waterfront Drive, Playa Vista,  
CA 90094

**ISSUED BY:** Bureau Veritas Consumer Products Services  
(H.K.) Ltd., Taoyuan Branch Hsin Chu Laboratory

**LAB ADDRESS :** No. 81-1, Lu Liao Keng, 9th Ling,Wu Lung Tsuen,  
Chiung Lin Hsiang, Hsin Chu Hsien 307, Taiwan

**TEST LOCATION (1):** No. 81-1, Lu Liao Keng, 9th Ling,Wu Lung Tsuen,  
Chiung Lin Hsiang, Hsin Chu Hsien 307, Taiwan

**TEST LOCATION (2):** No. 49, Ln. 206, Wende Rd., Shangshan Tsuen,  
Chiung Lin Hsiang, Hsin Chu Hsien 307, Taiwan

This test report consists of 111 pages in total. It may be duplicated completely for legal use with the approval of the applicant. It should not be reproduced except in full, without the written approval of our laboratory. The client should not use it to claim product certification, approval, or endorsement by TAF or any government agencies. The test results in the report only apply to the tested sample.





A D T

## Table of Contents

RELEASE CONTROL RECORD.....	5
1. CERTIFICATION.....	6
2. SUMMARY OF TEST RESULTS.....	7
2.1 MEASUREMENT UNCERTAINTY .....	9
3. GENERAL INFORMATION .....	10
3.1 GENERAL DESCRIPTION OF EUT.....	10
3.2 DESCRIPTION OF TEST MODES.....	13
3.2.1 TEST MODE APPLICABILITY AND TESTED CHANNEL DETAIL .....	14
3.3 GENERAL DESCRIPTION OF APPLIED STANDARDS .....	18
3.4 DESCRIPTION OF SUPPORT UNITS.....	19
3.5 CONFIGURATION OF SYSTEM UNDER TEST .....	20
4. TEST TYPES AND RESULTS (802.11b & g, 2400 ~ 2483.5MHz Band).....	21
4.1 CONDUCTED EMISSION MEASUREMENT .....	21
4.1.1 LIMITS OF CONDUCTED EMISSION MEASUREMENT.....	21
4.1.2 TEST INSTRUMENTS .....	21
4.1.3 TEST PROCEDURES.....	22
4.1.4 DEVIATION FROM TEST STANDARD .....	22
4.1.5 TEST SETUP .....	23
4.1.6 EUT OPERATING CONDITIONS.....	23
4.1.7 TEST RESULTS (With adapter 1) .....	24
4.1.8 TEST RESULTS (With adapter 2) .....	26
4.2 RADIATED EMISSION MEASUREMENT .....	28
4.2.1 LIMITS OF RADIATED EMISSION MEASUREMENT.....	28
4.2.2 TEST INSTRUMENTS .....	29
4.2.3 TEST PROCEDURES.....	31
4.2.4 DEVIATION FROM TEST STANDARD .....	31
4.2.5 TEST SETUP .....	32
4.2.6 EUT OPERATING CONDITIONS.....	32
4.2.7 TEST RESULTS.....	33
4.3 6dB BANDWIDTH MEASUREMENT .....	55
4.3.1 LIMITS OF 6dB BANDWIDTH MEASUREMENT.....	55
4.3.2 TEST INSTRUMENTS .....	55
4.3.3 TEST PROCEDURE .....	55
4.3.4 DEVIATION FROM TEST STANDARD .....	55
4.3.5 TEST SETUP .....	55
4.3.6 EUT OPERATING CONDITIONS.....	55
4.3.7 TEST RESULTS.....	56



A D T

4.4	MAXIMUM PEAK OUTPUT POWER .....	59
4.4.1	LIMITS OF MAXIMUM PEAK OUTPUT POWER MEASUREMENT .....	59
4.4.2	INSTRUMENTS .....	59
4.4.3	TEST PROCEDURES.....	59
4.4.4	DEVIATION FROM TEST STANDARD .....	59
4.4.5	TEST SETUP .....	59
4.4.6	EUT OPERATING CONDITIONS.....	59
4.4.7	TEST RESULTS.....	60
4.5	POWER SPECTRAL DENSITY MEASUREMENT.....	61
4.5.1	LIMITS OF POWER SPECTRAL DENSITY MEASUREMENT .....	61
4.5.2	TEST INSTRUMENTS .....	61
4.5.3	TEST PROCEDURE .....	61
4.5.4	DEVIATION FROM TEST STANDARD .....	61
4.5.5	TEST SETUP .....	61
4.5.6	EUT OPERATING CONDITION .....	61
4.5.7	TEST RESULTS.....	62
4.6	CONDUCTED OUT-BAND EMISSION MEASUREMENT.....	65
4.6.1	LIMITS OF CONDUCTED OUT-BAND EMISSION MEASUREMENT .....	65
4.6.2	TEST INSTRUMENTS .....	65
4.6.3	TEST PROCEDURE .....	65
4.6.4	DEVIATION FROM TEST STANDARD .....	65
4.6.5	EUT OPERATING CONDITION .....	65
4.6.6	TEST RESULTS.....	65
5.	TEST TYPES AND RESULTS (802.11a, 5725~5850MHz Band) .....	72
5.1	CONDUCTED EMISSION MEASUREMENT .....	72
5.1.1	LIMITS OF CONDUCTED EMISSION MEASUREMENT.....	72
5.1.2	TEST INSTRUMENTS .....	72
5.1.3	TEST PROCEDURES.....	73
5.1.4	DEVIATION FROM TEST STANDARD .....	73
5.1.5	TEST SETUP .....	74
5.1.6	EUT OPERATING CONDITIONS.....	74
5.1.7	TEST RESULTS (With adapter 1) .....	75
5.1.8	TEST RESULTS (With adapter 2) .....	77
5.2	RADIATED EMISSION MEASUREMENT .....	79
5.2.1	LIMITS OF RADIATED EMISSION MEASUREMENT.....	79
5.2.2	TEST INSTRUMENTS .....	80
5.2.3	TEST PROCEDURES.....	82
5.2.4	DEVIATION FROM TEST STANDARD .....	82
5.2.5	TEST SETUP .....	83



A D T

5.2.6	EUT OPERATING CONDITIONS.....	83
5.2.7	TEST RESULTS.....	84
5.3	6dB BANDWIDTH MEASUREMENT .....	93
5.3.1	LIMITS OF 6dB BANDWIDTH MEASUREMENT .....	93
5.3.2	TEST INSTRUMENTS .....	93
5.3.3	TEST PROCEDURE .....	93
5.3.4	DEVIATION FROM TEST STANDARD .....	93
5.3.5	TEST SETUP .....	93
5.3.6	EUT OPERATING CONDITIONS.....	93
5.3.7	TEST RESULTS.....	94
5.4	MAXIMUM PEAK OUTPUT POWER .....	97
5.4.1	LIMITS OF MAXIMUM PEAK OUTPUT POWER MEASUREMENT .....	97
5.4.2	INSTRUMENTS .....	97
5.4.3	TEST PROCEDURES.....	97
5.4.4	DEVIATION FROM TEST STANDARD .....	97
5.4.5	TEST SETUP .....	97
5.4.6	EUT OPERATING CONDITIONS.....	97
5.4.7	TEST RESULTS.....	98
5.5	POWER SPECTRAL DENSITY MEASUREMENT.....	99
5.5.1	LIMITS OF POWER SPECTRAL DENSITY MEASUREMENT .....	99
5.5.2	TEST INSTRUMENTS .....	99
5.5.3	TEST PROCEDURE .....	99
5.5.4	DEVIATION FROM TEST STANDARD .....	99
5.5.5	TEST SETUP .....	99
5.5.6	EUT OPERATING CONDITION .....	99
5.5.7	TEST RESULTS.....	100
5.6	CONDUCTED OUT-BAND EMISSION MEASUREMENT.....	103
5.6.1	LIMITS OF CONDUCTED OUT-BAND EMISSION MEASUREMENT .....	103
5.6.2	TEST INSTRUMENTS .....	103
5.6.3	TEST PROCEDURE .....	103
5.6.4	DEVIATION FROM TEST STANDARD .....	103
5.6.5	EUT OPERATING CONDITION .....	103
5.6.6	TEST RESULTS.....	103
6.	INFORMATION ON THE TESTING LABORATORIES .....	110
7.	APPENDIX A - MODIFICATIONS RECORDERS FOR ENGINEERING CHANGES TO THE EUT BY THE LAB.....	111



A D T

## RELEASE CONTROL RECORD

ISSUE NO.	REASON FOR CHANGE	DATE ISSUED
RF110107E071	Original release	Aug. 29, 2011



## 1. CERTIFICATION

**PRODUCT:** Wireless Dual-Band N Router  
**BRAND NAME:** Belkin  
**MODEL NO.:** F9K1108v1  
**TEST SAMPLE:** R&D SAMPLE  
**APPLICANT:** Belkin International, Inc.  
**TESTED:** Jan. 12 to Feb. 08, 2011 and  
May 19, 2011(Only for radiated test below 1GHz)  
**STANDARDS:** FCC Part 15, Subpart C (Section 15.247)  
ANSI C63.4-2003  
ANSI C63.10-2009

The above equipment (Model: F9K1108v1) has been tested by **Bureau Veritas Consumer Products Services (H.K.) Ltd., Taoyuan Branch**, and found compliance with the requirement of the above standards. The test record, data evaluation & Equipment Under Test (EUT) configurations represented herein are true and accurate accounts of the measurements of the sample's EMC characteristics under the conditions specified in this report.

**PREPARED BY :** Midoli Peng, **DATE:** Aug. 29, 2011  
( Midoli Peng, Specialist )

**APPROVED BY :** May Chen, **DATE:** Aug. 29, 2011  
( May Chen, Deputy Manager )

## 2. SUMMARY OF TEST RESULTS

The EUT has been tested according to the following specifications:

For 2.4GHz, 2412~2462MHz Band

<b>APPLIED STANDARD: FCC Part 15, Subpart C</b>			
<b>Standard Section</b>	<b>Test Type and Limit</b>	<b>Result</b>	<b>Remark</b>
15.207	AC Power Conducted Emission	PASS	Meet the requirement of limit. Minimum passing margin is -10.27dB at 0.389MHz
15.247(a)(2)	Spectrum Bandwidth of a Direct Sequence Spread Spectrum System Limit: min. 500kHz	PASS	Meet the requirement of limit.
15.247(b)	Maximum Peak Output Power Limit: max. 30dBm	PASS	Meet the requirement of limit.
15.247(d)	Radiated Emissions Limit: Table 15.209	PASS	Meet the requirement of limit. Minimum passing margin is -0.5dB at 2390.0MHz
15.247(e)	Power Spectral Density Limit: max. 8dBm	PASS	Meet the requirement of limit.
15.247(d)	Conducted Out-Band Emission Measurement Limit: 20dB less than the peak value of fundamental frequency	PASS	Meet the requirement of limit.
15.203	Antenna Requirement	PASS	No antenna connector is used.



A D T

For 5GHz, 5725~5850MHz Band

APPLIED STANDARD: FCC Part 15, Subpart C			
Standard Section	Test Type and Limit	Result	Remark
15.207	AC Power Conducted Emission	PASS	Meet the requirement of limit. Minimum passing margin is -7.15dB at 0.775MHz
15.247(a)(2)	Spectrum Bandwidth of a Direct Sequence Spread Spectrum System Limit: min. 500kHz	PASS	Meet the requirement of limit.
15.247(b)	Maximum Peak Output Power Limit: max. 30dBm	PASS	Meet the requirement of limit.
15.247(d)	Radiated Emissions Limit: Table 15.209	PASS	Meet the requirement of limit. Minimum passing margin is -0.6dB at 3856.6MHz & 3883.3MHz
15.247(e)	Power Spectral Density Limit: max. 8dBm	PASS	Meet the requirement of limit.
15.247(d)	Conducted Out-Band Emission Measurement Limit: 20dB less than the peak value of fundamental frequency	PASS	Meet the requirement of limit.
15.203	Antenna Requirement	PASS	No antenna connector is used.

**NOTE:**

1. The EUT was operating in 2400 ~ 2483.5MHz, 5.15~5.25GHz and 5.725~5.850GHz frequencies band. This report was recorded the RF parameters including 2400 ~ 2483.5MHz and 5.725~5.850GHz. For the 5.15~5.25GHz RF parameters was recorded in another test report.





A D T

## 2.1 MEASUREMENT UNCERTAINTY

Where relevant, the following measurement uncertainty levels have been estimated for tests performed on the EUT as specified in CISPR 16-4-2:

This uncertainty represents an expanded uncertainty expressed at approximately the 95% confidence level using a coverage factor of  $k=2$ .

Measurement	Value
Conducted emissions	2.45 dB
Radiated emissions (30MHz-1GHz)	3.28 dB
Radiated emissions (1GHz -18GHz)	3.3 dB
Radiated emissions (18GHz -40GHz)	2.19 dB



A D T

### 3. GENERAL INFORMATION

#### 3.1 GENERAL DESCRIPTION OF EUT

<b>PRODUCT</b>	Wireless Dual-Band N Router
<b>MODEL NO.</b>	F9K1108v1
<b>FCC ID</b>	K7SF9K1108V1
<b>POWER SUPPLY</b>	DC 12V from power adapter
<b>MODULATION TYPE</b>	CCK, DQPSK, DBPSK for DSSS 64QAM, 16QAM, QPSK, BPSK for OFDM
<b>MODULATION TECHNOLOGY</b>	DSSS, OFDM
<b>TRANSFER RATE</b>	802.11a/g : 54/48/36/24/18/12/9/6Mbps 802.11b :11/5.5/2/1Mbps 802.11n (20MHz, 400ns GI): 144.4/130/115.6/86.7/57.8/43.3/28.9/14.4/72.2 / 65 / 57.8 / 43.3 / 28.9 / 21.7 / 14.4 / 7.2Mbps 802.11n (40MHz, 400ns GI)<5G only>: 300/270/240/180/120/90/60/30/150 / 135 / 120 / 90 / 60 / 45 / 30 / 15Mbps
<b>OPERATING FREQUENCY</b>	<b>For 15.407</b> 802.11a: 5.18 ~ 5.24GHz <b>For 15.247</b> 802.11b & 802.11g: 2.412 ~ 2.462GHz 802.11a: 5.745 ~ 5.825GHz
<b>NUMBER OF CHANNEL</b>	<b>For 15.407</b> 4 for 802.11a, 802.11n (20MHz) 2 for 802.11n (40MHz) <b>For 15.247(2.4GHz)</b> 11 for 802.11b, 802.11g, 802.11n (20MHz) <b>For 15.247(5GHz)</b> 5 for 802.11a, 802.11n (20MHz) 2 for 802.11n (40MHz)



A D T

<b>MAXIMUM OUTPUT POWER</b>	<b>For 15.407</b> 802.11a: 14.0mW 802.11n (20MHz): 25.2mW 802.11n (40MHz): 41.8mW <b>For 15.247(2.4GHz)</b> 802.11b: 162.2mW 802.11g: 608.0mW 802.11n (20MHz): 472.6mW <b>For 15.247(5GHz)</b> 802.11a: 377.0mW 802.11n (20MHz): 368.2mW 802.11n (40MHz): 351.8mW
<b>ANTENNA TYPE</b>	Please see note 1
<b>DATA CABLE</b>	NA
<b>I/O PORTS</b>	WAN port x 1 LAN port (10, 100Mbps) x 4
<b>ASSOCIATED DEVICES</b>	Adapter x 1

**NOTE:**

1. There are two antennas provided to this EUT, please refer to the following table:

Transmitter Circuit	Antenna Type	2.4GHz Gain (dBi)	5 GHz Gain (dBi)
Chain (0)	PCB Printed	4.12	5.21
Chain (1)	PCB Printed	4.44	4.21

2. The EUT must be supplied with a power adapter and following two different model names could be chosen:

<b>Adapter 1</b>	
<b>BRAND</b>	LEI
<b>MODEL</b>	MT12-Y120100-A1
<b>INPUT POWER</b>	AC 120V, 60Hz, 0.3A
<b>OUTPUT POWER</b>	DC 12V, 1A DC Cable: 1.6m unshielded
<b>Adapter 2</b>	
<b>BRAND</b>	DVE
<b>MODEL</b>	DSA-12PFE-12 BUS 120100
<b>INPUT POWER</b>	AC 100-120V, 50-60Hz, 0.3A
<b>OUTPUT POWER</b>	DC 12V, 1A DC Cable: 1.6m unshielded

For radiated test, the EUT was pre-tested with above adapters, the worse case was found in adapter 1. Therefore only the test data of the adapter was recorded in this report.

3. The EUT incorporates CDD function with 802.11a, 802.11g.
4. 2.4GHz and 5GHz technology cannot transmit at same time.
5. The EUT incorporates a MIMO function with 802.11n.
6. The EUT is 2 \* 2 spatial MIMO (2Tx & 2Rx) without beam forming function. The 11b legacy mode is limited to single transmitter only.
7. When the EUT operating in 802.11n, the software operation, which is defined by manufacturer, MCS (Modulation and Coding Schemes) from 0 to 15.
8. The EUT complies with 802.11n standards and backwards compatible with 802.11a, 802.11b, 802.11g products.
9. The above EUT information was declared by the manufacturer and for more detailed features description, please refer to the manufacturer's specifications or User's Manual.

### 3.2 DESCRIPTION OF TEST MODES

#### Operated in 2400 ~ 2483.5MHz band:

Eleven channels are provided for 802.11b, 802.11g, 802.11n (20MHz):

CHANNEL	FREQUENCY	CHANNEL	FREQUENCY
1	2412MHz	7	2442MHz
2	2417MHz	8	2447MHz
3	2422MHz	9	2452MHz
4	2427MHz	10	2457MHz
5	2432MHz	11	2462MHz
6	2437MHz		

#### Operated in 5725 ~ 5850MHz band:

Five channels are provided for 802.11a, 802.11n (20MHz):

CHANNEL	FREQUENCY	CHANNEL	FREQUENCY
149	5745 MHz	161	5805 MHz
153	5765 MHz	165	5825 MHz
157	5785 MHz		

Two channels are provided for 802.11n (40MHz):

CHANNEL	FREQUENCY
151	5755 MHz
159	5795 MHz

### 3.2.1 TEST MODE APPLICABILITY AND TESTED CHANNEL DETAIL

EUT CONFIGURE MODE	APPLICABLE TO				DESCRIPTION
	PLC	RE < 1G	RE ≥ 1G	APCM	
1	√	√	√	√	With Adapter 1
2	√	-	-	-	With Adapter 2

Where **PLC**: Power Line Conducted Emission      **RE < 1G**: Radiated Emission below 1GHz  
**RE ≥ 1G**: Radiated Emission above 1GHz      **APCM**: Antenna Port Conducted Measurement

#### ANTENNA COMBINATION MODE:

COMBINATION MODE	OPERATION MODE	TX CHAIN(0)	TX CHAIN(1)
A	802.11 b	√	
B	802.11 g	√	√
C	802.11 a	√	√
D	802.11n(20MHz) for MCS0~15	√	√
E	802.11n(40MHz) for MCS0~15	√	√

Note: The above information was declared by manufacturer and for more detailed features description, please refer to the manufacturer's specifications or user's manual.

#### POWER LINE CONDUCTED EMISSION TEST:

- Pre-Scan has been conducted to determine the worst-case mode from all possible combinations between available modulations, data rates and antenna ports (if EUT with antenna diversity architecture).
- Following channel(s) was (were) selected for the final test as listed below.

MODE	AVAILABLE CHANNEL	TESTED CHANNEL	MODULATION TECHNOLOGY	MODULATION TYPE	DATA RATE (Mbps)	COMBINATION MODE
802.11g	1 to 11	6	OFDM	BPSK	6	B
802.11a	149 to 165	149	OFDM	BPSK	6	C



A D T

**RADIATED EMISSION TEST (BELOW 1 GHz):**

- Pre-Scan has been conducted to determine the worst-case mode from all possible combinations between available modulations, data rates and antenna ports (if EUT with antenna diversity architecture).
- Following channel(s) was (were) selected for the final test as listed below.

MODE	AVAILABLE CHANNEL	TESTED CHANNEL	MODULATION TECHNOLOGY	MODULATION TYPE	DATA RATE (Mbps)	COMBINATION MODE
802.11g	1 to 11	6	OFDM	BPSK	6	B
802.11a	149 to 165	149	OFDM	BPSK	6	C

**RADIATED EMISSION TEST (ABOVE 1 GHz):**

- Pre-Scan has been conducted to determine the worst-case mode from all possible combinations between available modulations, data rates and antenna ports (if EUT with antenna diversity architecture).
- Following channel(s) was (were) selected for the final test as listed below.

MODE	AVAILABLE CHANNEL	TESTED CHANNEL	MODULATION TECHNOLOGY	MODULATION TYPE	DATA RATE (Mbps)	COMBINATION MODE
802.11b	1 to 11	1, 6, 11	DSSS	DBPSK	1	A
802.11g	1 to 11	1, 6, 11	OFDM	BPSK	6	B
For 2.4 GHz 802.11n (20MHz)	1 to 11	1, 6, 11	OFDM	BPSK	7.2	D
802.11a	149 to 165	149, 157, 165	OFDM	BPSK	6	C
For 5 GHz 802.11n (20MHz)	149 to 165	149, 157, 165	OFDM	BPSK	7.2	D
For 5 GHz 802.11n (40MHz)	151 to 159	151, 159	OFDM	BPSK	15	E

**CONDUCTED OUT-BAND EMISSION MEASUREMENT:**

- Pre-Scan has been conducted to determine the worst-case mode from all possible combinations between available modulations, data rates and antenna ports (if EUT with antenna diversity architecture).
- Following channel(s) was (were) selected for the final test as listed below.

MODE	AVAILABLE CHANNEL	TESTED CHANNEL	MODULATION TECHNOLOGY	MODULATION TYPE	DATA RATE (Mbps)	COMBINATION MODE
802.11b	1 to 11	1, 11	DSSS	DBPSK	1	A
802.11g	1 to 11	1, 11	OFDM	BPSK	6	B
For 2.4 GHz 802.11n (20MHz)	1 to 11	1, 11	OFDM	BPSK	7.2	D
802.11a	149 to 165	149, 165	OFDM	BPSK	6	C
For 5 GHz 802.11n (20MHz)	149 to 165	149, 165	OFDM	BPSK	7.2	D
For 5 GHz 802.11n (40MHz)	151 to 159	151, 159	OFDM	BPSK	15	E

※ After verification, conducted out band emission as show worst chain in report by investigations.

**ANTENNA PORT CONDUCTED MEASUREMENT:**

- This item includes all test value of each mode, but only includes spectrum plot of worst value of each mode.
- Pre-Scan has been conducted to determine the worst-case mode from all possible combinations between available modulations, data rates and antenna ports (if EUT with antenna diversity architecture).
- Following channel(s) was (were) selected for the final test as listed below.

MODE	AVAILABLE CHANNEL	TESTED CHANNEL	MODULATION TECHNOLOGY	MODULATION TYPE	DATA RATE (Mbps)	COMBINATION MODE
802.11b	1 to 11	1, 6, 11	DSSS	DBPSK	1	A
802.11g	1 to 11	1, 6, 11	OFDM	BPSK	6	B
For 2.4 GHz 802.11n (20MHz)	1 to 11	1, 6, 11	OFDM	BPSK	7.2	D
802.11a	149 to 165	149, 157, 165	OFDM	BPSK	6	C
For 5 GHz 802.11n (20MHz)	149 to 165	149, 157, 165	OFDM	BPSK	7.2	D
For 5 GHz 802.11n (40MHz)	151 to 159	151, 159	OFDM	BPSK	15	E

※ After verification, bandwidth as show worst chain in report by investigations.





A D T

※ **TEST CONDITION:**

APPLICABLE TO	ENVIRONMENTAL CONDITIONS	INPUT POWER	TESTED BY
RE <sup>3</sup> 1G	12deg. C, 64%RH, 1023 hPa	120Vac, 60Hz	Frank Liu
RE<1G	22deg. C, 61%RH, 1023 hPa	120Vac, 60Hz	Kent Liu
PLC	20deg. C, 70%RH, 1023 hPa	120Vac, 60Hz	Eric Lee
APCM	20deg. C, 60%RH, 1023 hPa	120Vac, 60Hz	Rex Huang

### 3.3 GENERAL DESCRIPTION OF APPLIED STANDARDS

The EUT is a RF product. According to the specifications of the manufacturer, it must comply with the requirements of the following standards:

**FCC Part 15, Subpart C. (15.247)**

**ANSI C63.4-2003**

**ANSI C63.10-2009**

All test items have been performed and recorded as per the above standards.

**NOTE:** The EUT has been verified to comply with the requirements of FCC Part 15, Subpart B, Class B (DoC). The test report has been issued separately.



A D T

### 3.4 DESCRIPTION OF SUPPORT UNITS

The EUT has been tested as an independent unit together with other necessary accessories or support units. The following support units or accessories were used to form a representative test configuration during the tests.

No.	Product	Brand	Model No.	Serial No.	FCC ID
1	NOTEBOOK COMPUTER	DELL	PP32LA	FSLB32S	FCC DoC
2	NOTEBOOK COMPUTER	DELL	PP32LA	GSLB32S	FCC DoC
3	HUB	ZyXEL	ES-116P	S060H02000215	FCC DoC

No.	Signal cable description
1	UTP Cable (10m)
2	UTP Cable (10m)
3	UTP Cable (10m)

Note: The power cords of the above support units were unshielded (1.8m).

### 3.5 CONFIGURATION OF SYSTEM UNDER TEST

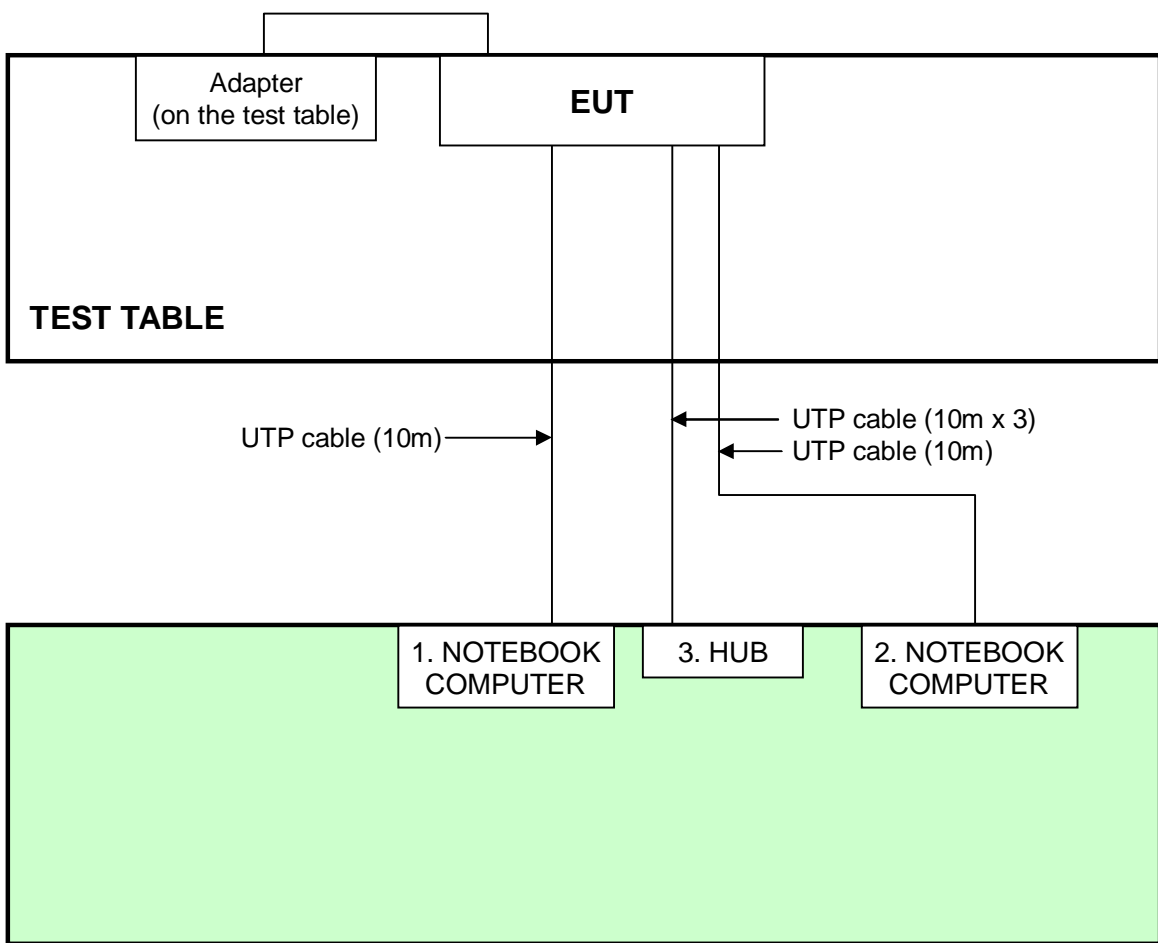



A D T

## 4. TEST TYPES AND RESULTS (802.11b & g, 2400 ~ 2483.5MHz Band)

### 4.1 CONDUCTED EMISSION MEASUREMENT

#### 4.1.1 LIMITS OF CONDUCTED EMISSION MEASUREMENT

FREQUENCY OF EMISSION (MHz)	CONDUCTED LIMIT (dBµV)	
0.15-0.5	Quasi-peak	Average
0.5-5	66 to 56	56 to 46
5-30	56	46
	60	50

- NOTE:**
1. The lower limit shall apply at the transition frequencies.
  2. The limit decreases in line with the logarithm of the frequency in the range of 0.15 to 0.50 MHz.
  3. All emanations from a class A/B digital device or system, including any network of conductors and apparatus connected thereto, shall not exceed the level of field strengths specified above.

#### 4.1.2 TEST INSTRUMENTS

DESCRIPTION & MANUFACTURER	MODEL NO.	SERIAL NO.	CALIBRATED DATE	CALIBRATED UNTIL
ROHDE & SCHWARZ Test Receiver	ESCS 30	100287	Mar. 01, 2010	Feb. 28, 2011
Line-Impedance Stabilization Network (for EUT)	NSLK 8127	8127-523	Sep. 17, 2010	Sep. 16, 2011
Line-Impedance Stabilization Network (for Peripheral)	ENV-216	100072	June 11, 2010	June 10, 2011
RF Cable (JYEBAO)	5DFB	CONCAB-003	Aug. 06, 2010	Aug. 05, 2011
50 ohms Terminator	50	3	Nov. 03, 2010	Nov. 02, 2011
Software	BV ADT_Cond_V7.3.7	NA	NA	NA

**Note:**

1. The calibration interval of the above test instruments is 12 months and the calibrations are traceable to NML/ROC and NIST/USA.
2. The test was performed in Shielded Room No. A.
3. The VCCI Con A Registration No. is C-817.

#### 4.1.3 TEST PROCEDURES

- a. The EUT was placed 0.4 meters from the conducting wall of the shielded room with EUT being connected to the power mains through a line impedance stabilization network (LISN). Other support units were connected to the power mains through another LISN. The two LISNs provide 50 ohm/ 50uH of coupling impedance for the measuring instrument.
- b. Both lines of the power mains connected to the EUT were checked for maximum conducted interference.
- c. The frequency range from 150kHz to 30MHz was searched. Emission levels under (Limit - 20dB) were not recorded.

#### 4.1.4 DEVIATION FROM TEST STANDARD

No deviation

#### 4.1.5 TEST SETUP

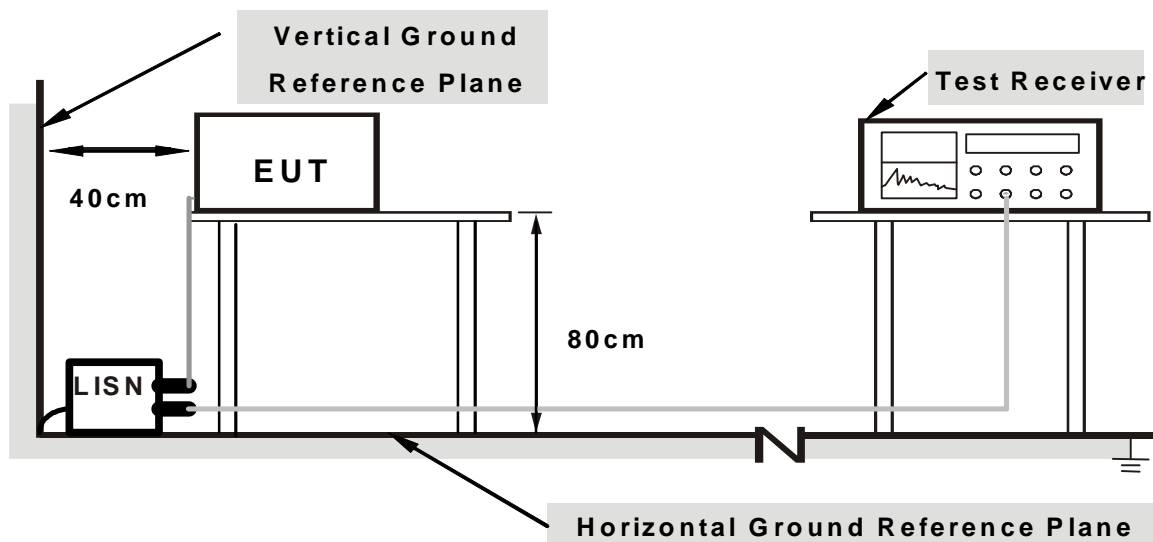

**Note: 1. Support units were connected to second LISN.**

**2. Both of LISNs (AMN) are 80 cm from EUT and at least 80 from other units and other metal planes**

For the actual test configuration, please refer to the related item – Photographs of the Test Configuration.

#### 4.1.6 EUT OPERATING CONDITIONS

1. Placed the EUT on testing table.
2. Prepared other computer systems (support units 1~2) to act as communication partners and placed them outside of testing area.
3. The communication partners ran test program “2.4GHz WL COMMANDS.txt” to enable EUT under transmission/receiving condition continuously via UTP cables transmission.

#### 4.1.7 TEST RESULTS (With adapter 1)

<b>PHASE</b>	Line (L)	<b>6dB BANDWIDTH</b>	9 kHz
--------------	----------	----------------------	-------

No	Freq.	Corr.	Reading Value		Emission Level		Limit		Margin	
	[MHz]	(dB)	[dB (uV)]		[dB (uV)]		[dB (uV)]		(dB)	
			Q.P.	AV.	Q.P.	AV.	Q.P.	AV.	Q.P.	AV.
1	0.185	0.36	43.43	-	43.79	-	64.25	54.25	-20.46	-
2	0.314	0.36	44.03	-	44.39	-	59.86	49.86	-15.47	-
<b>3</b>	<b>0.388</b>	<b>0.36</b>	<b>47.48</b>	-	<b>47.84</b>	-	<b>58.11</b>	<b>48.11</b>	<b>-10.27</b>	-
4	0.775	0.39	44.87	-	45.26	-	56.00	46.00	-10.74	-
5	3.961	0.51	43.11	-	43.62	-	56.00	46.00	-12.38	-
6	18.305	1.03	38.41	-	39.44	-	60.00	50.00	-20.56	-

- REMARKS:**
1. Q.P. and AV. are abbreviations of quasi-peak and average individually.
  2. "-": The Quasi-peak reading value also meets average limit and measurement with the average detector is unnecessary.
  3. The emission levels of other frequencies were very low against the limit.
  4. Margin value = Emission level - Limit value
  5. Correction factor = Insertion loss + Cable loss
  6. Emission Level = Correction Factor + Reading Value.

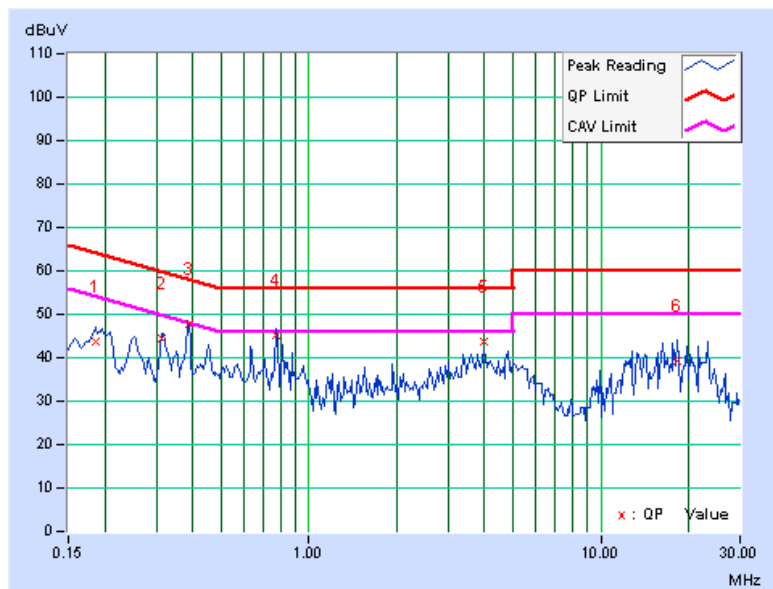





A D T

PHASE	Neutral (N)	6dB BANDWIDTH	9 kHz
-------	-------------	---------------	-------

No	Freq. [MHz]	Corr. Factor (dB)	Reading Value		Emission Level		Limit		Margin	
			[dB (uV)]		[dB (uV)]		[dB (uV)]		(dB)	
			Q.P.	AV.	Q.P.	AV.	Q.P.	AV.	Q.P.	AV.
1	0.177	0.10	37.30	-	37.40	-	64.61	54.61	-27.21	-
2	0.318	0.11	40.51	-	40.62	-	59.76	49.76	-19.14	-
3	0.388	0.11	43.60	-	43.71	-	58.10	48.10	-14.39	-
4	0.634	0.13	38.42	-	38.55	-	56.00	46.00	-17.45	-
5	0.775	0.14	41.58	-	41.72	-	56.00	46.00	-14.28	-
6	3.234	0.22	37.72	-	37.94	-	56.00	46.00	-18.06	-

- REMARKS:**
1. Q.P. and AV. are abbreviations of quasi-peak and average individually.
  2. "-": The Quasi-peak reading value also meets average limit and measurement with the average detector is unnecessary.
  3. The emission levels of other frequencies were very low against the limit.
  4. Margin value = Emission level - Limit value
  5. Correction factor = Insertion loss + Cable loss
  6. Emission Level = Correction Factor + Reading Value.

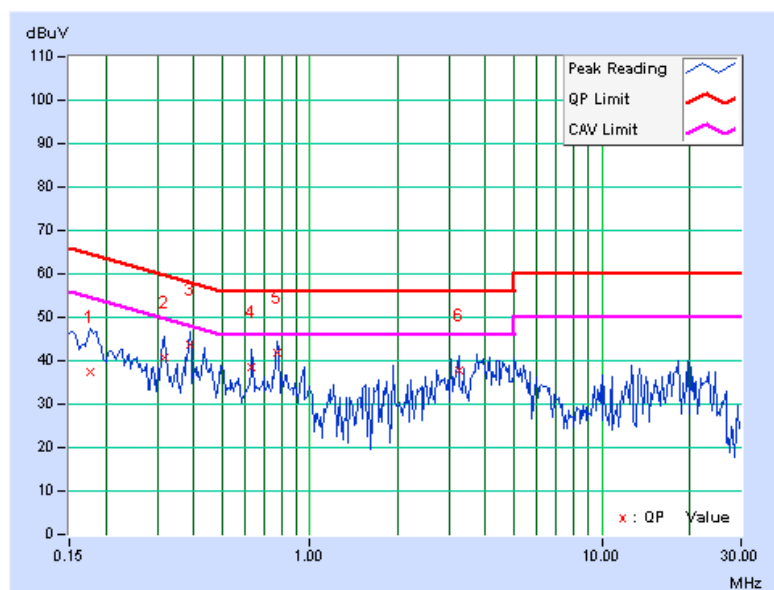

#### 4.1.8 TEST RESULTS (With adapter 2)

<b>PHASE</b>	Line (L)	<b>6dB BANDWIDTH</b>	9 kHz
--------------	----------	----------------------	-------

No	Freq.	Corr.	Reading Value		Emission Level		Limit		Margin	
	[MHz]	Factor	[dB (uV)]		[dB (uV)]		[dB (uV)]		(dB)	
		(dB)	Q.P.	AV.	Q.P.	AV.	Q.P.	AV.	Q.P.	AV.
1	0.155	0.36	42.47	-	42.83	-	65.75	55.75	-22.92	-
2	0.314	0.36	42.53	-	42.89	-	59.86	49.86	-16.97	-
3	0.775	0.39	33.44	-	33.83	-	56.00	46.00	-22.17	-
4	11.949	0.81	32.94	-	33.75	-	60.00	50.00	-26.25	-
5	18.305	1.03	38.76	-	39.79	-	60.00	50.00	-20.21	-
6	26.484	1.39	34.84	-	36.23	-	60.00	50.00	-23.77	-

- REMARKS:**
1. Q.P. and AV. are abbreviations of quasi-peak and average individually.
  2. "-": The Quasi-peak reading value also meets average limit and measurement with the average detector is unnecessary.
  3. The emission levels of other frequencies were very low against the limit.
  4. Margin value = Emission level - Limit value
  5. Correction factor = Insertion loss + Cable loss
  6. Emission Level = Correction Factor + Reading Value.

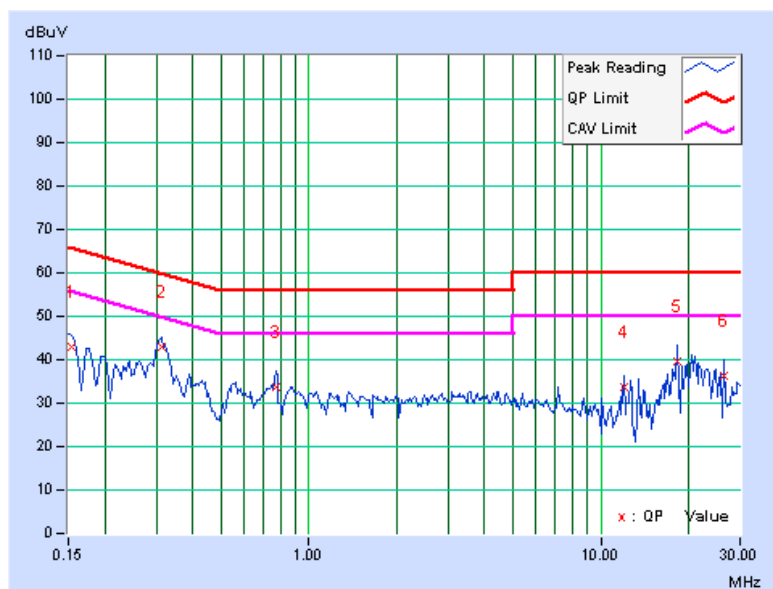

<b>PHASE</b>	Neutral (N)	<b>6dB BANDWIDTH</b>	9 kHz
--------------	-------------	----------------------	-------

No	Freq. [MHz]	Corr. Factor (dB)	Reading Value [dB (uV)]		Emission Level [dB (uV)]		Limit [dB (uV)]		Margin (dB)	
			Q.P.	AV.	Q.P.	AV.	Q.P.	AV.	Q.P.	AV.
			1	0.150	0.10	39.53	-	39.63	-	66.00
2	0.310	0.11	39.81	-	39.92	-	59.97	49.97	-20.05	-
3	0.775	0.14	31.04	-	31.18	-	56.00	46.00	-24.82	-
4	18.242	1.06	38.11	-	39.17	-	60.00	50.00	-20.83	-
5	19.586	1.11	34.51	-	35.62	-	60.00	50.00	-24.38	-
6	23.133	1.40	33.69	-	35.09	-	60.00	50.00	-24.91	-

- REMARKS:**
1. Q.P. and AV. are abbreviations of quasi-peak and average individually.
  2. "-": The Quasi-peak reading value also meets average limit and measurement with the average detector is unnecessary.
  3. The emission levels of other frequencies were very low against the limit.
  4. Margin value = Emission level - Limit value
  5. Correction factor = Insertion loss + Cable loss
  6. Emission Level = Correction Factor + Reading Value.

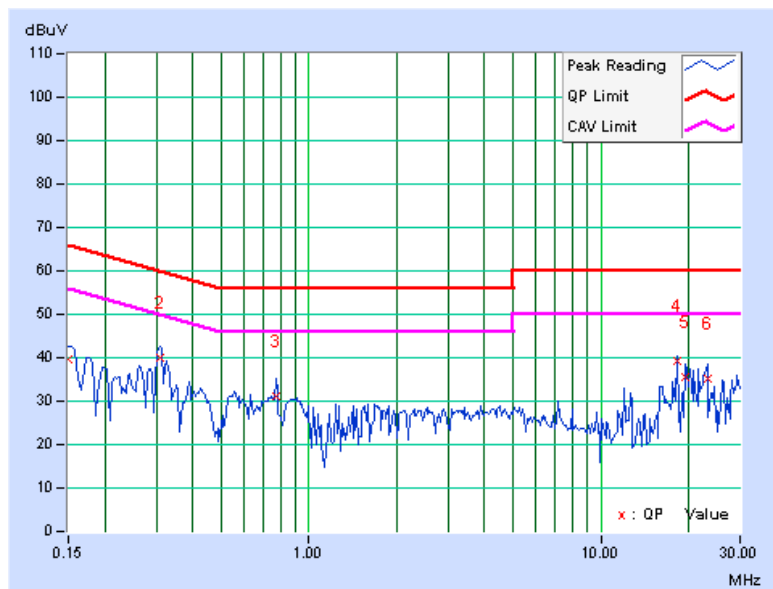

## 4.2 RADIATED EMISSION MEASUREMENT

### 4.2.1 LIMITS OF RADIATED EMISSION MEASUREMENT

Emissions radiated outside of the specified bands, shall be according to the general radiated limits in 15.209 as following:

Frequencies (MHz)	Field strength (microvolts/meter)	Measurement distance (meters)
0.009-0.490	2400/F(kHz)	300
0.490-1.705	24000/F(kHz)	30
1.705-30.0	30	30
30-88	100	3
88-216	150	3
216-960	200	3
Above 960	500	3

**NOTE:**

1. The lower limit shall apply at the transition frequencies.
2. Emission level (dBuV/m) = 20 log Emission level (uV/m).
3. As shown in 15.35(b), for frequencies above 1000MHz, the field strength limits are based on average detector, however, the peak field strength of any emission shall not exceed the maximum permitted average limits, specified above by more than 20dB under any condition of modulation.
4. Section 15.205 restricted bands of operation shall compliance with the limits in Section 15.209.



A D T

## 4.2.2 TEST INSTRUMENTS

### Below 1GHz test:

DESCRIPTION & MANUFACTURER	MODEL NO.	SERIAL NO.	CALIBRATED DATE	CALIBRATED UNTIL
Agilent Spectrum Analyzer	E4446A	MY48250253	Aug. 23, 2010	Aug. 22, 2011
Agilent Pre-Selector	N9039A	MY46520310	Aug. 23, 2010	Aug. 22, 2011
Agilent Signal Generator	N5181A	MY49060347	July 30, 2010	July 29, 2011
LIG NEX1 Test Receiver	ER-265	L09068005	Oct. 25, 2010	Oct. 24, 2011
Mini-Circuits Pre-Amplifier	ZFL-1000VH2B	AMP-ZFL-04	Nov. 16, 2010	Nov. 15, 2011
Agilent Pre-Amplifier	8449B	3008A02465	Feb. 28, 2011	Feb. 27, 2012
Miteq Pre-Amplifier	AFS33-1800265 0-30-8P-44	881786	NA	NA
SCHWARZBECK Trilog Broadband Antenna	VULB 9168	9168-361	Apr. 14, 2011	Apr. 13, 2012
AISI Horn_Antenna	AIH.8018	0000220091110	Nov. 22, 2010	Nov. 21, 2011
SCHWARZBECK Horn_Antenna	BBHA 9170	9170-424	Oct. 08, 2010	Oct. 07, 2011
RF CABLE	NA	RF104-205 RF104-207 RF104-202	Dec. 28, 2010	Dec. 27, 2011
RF Cable	NA	CHHCAB_001	NA	NA
Software	ADT_Radiated_V8.7.05	NA	NA	NA
CT Antenna Tower & Turn Table	NA	NA	NA	NA

- Note: 1. The calibration interval of the above test instruments is 12 months and the calibrations are traceable to NML/ROC and NIST/USA.  
 2. The horn antenna, preamplifier (model: 8449B) are used only for the measurement of emission frequency above 1GHz if tested.  
 3. The test was performed in 966 Chamber No. H.  
 4. The FCC Site Registration No. is 797305.  
 5. The CANADA Site Registration No. is IC 7450H-3.



A D T

**Above 1GHz test:**

<b>DESCRIPTION &amp; MANUFACTURER</b>	<b>MODEL NO.</b>	<b>SERIAL NO.</b>	<b>CALIBRATED DATE</b>	<b>CALIBRATED UNTIL</b>
Agilent Spectrum Analyzer	E4446A	MY48250254	July 14, 2010	July 13, 2011
Agilent Pre-Selector	N9039A	MY46520311	July 14, 2010	July 13, 2011
Agilent Signal Generator	N5181A	MY49060517	July 14, 2010	July 13, 2011
Mini-Circuits Pre-Amplifier	ZFL-1000VH2B	AMP-ZFL-03	Nov. 16, 2010	Nov. 15, 2011
Agilent Pre-Amplifier	8449B	3008A02578	July 05, 2010	July 04, 2011
Miteq Pre-Amplifier	AFS33-1800265 0-30-8P-44	881786	NA	NA
SCHWARZBECK Trilog Broadband Antenna	VULB 9168	9168-360	Apr. 29, 2010	Apr. 28, 2011
AISI Horn_Antenna	AIH.8018	0000320091110	Nov. 12, 2010	Nov. 11, 2011
SCHWARZBECK Horn_Antenna	BBHA 9170	9170-424	Oct. 08, 2010	Oct. 07, 2011
RF CABLE	NA	RF104-201 RF104-203 RF104-204	Dec. 27, 2010	Dec. 26, 2011
RF Cable	NA	CHGCAB_001	NA	NA
Software	ADT_Radiated_V8.7.05	NA	NA	NA
CT Antenna Tower & Turn Table	NA	NA	NA	NA

Note: 1. The calibration interval of the above test instruments is 12 months and the calibrations are traceable to NML/ROC and NIST/USA.

2. The horn antenna, preamplifier (model: 8449B) are used only for the measurement of emission frequency above 1GHz if tested.
3. The test was performed in 966 Chamber No. G.
4. The FCC Site Registration No. is 966073.
5. The VCCI Site Registration No. is G-137.
6. The CANADA Site Registration No. is IC 7450H-2.

### 4.2.3 TEST PROCEDURES

- a. The EUT was placed on the top of a rotating table 0.8 meters above the ground at a 3 meter chamber room. The table was rotated 360 degrees to determine the position of the highest radiation.
- b. The EUT was set 3 meters away from the interference-receiving antenna, which was mounted on the top of a variable-height antenna tower.
- c. The height of antenna is varied from one meter to four meters above the ground to determine the maximum value of the field strength. Both horizontal and vertical polarizations of the antenna are set to make the measurement.
- d. For each suspected emission, the EUT was arranged to its worst case and then the antenna was tuned to heights from 1 meter to 4 meters and the rotatable table was turned from 0 degrees to 360 degrees to find the maximum reading.
- e. The test-receiver system was set to quasi-peak detect function and specified bandwidth with maximum hold mode when the test frequency is below 1 GHz.
- f. The test-receiver system was set to peak and average detect function and specified bandwidth with maximum hold mode when the test frequency is above 1 GHz. If the peak reading value also meets average limit, measurement with the average detector is unnecessary.

**NOTE:**

1. The resolution bandwidth and video bandwidth of test receiver/spectrum analyzer is 120kHz for Quasi-peak detection (QP) at frequency below 1GHz.
2. The resolution bandwidth of test receiver/spectrum analyzer is 1 MHz and the video bandwidth is 3 MHz for Peak detection (PK) at frequency above 1GHz.
3. The resolution bandwidth of test receiver/spectrum analyzer is 1 MHz and the video bandwidth is 10 Hz for Average detection (AV) at frequency above 1GHz.

### 4.2.4 DEVIATION FROM TEST STANDARD

No deviation

### 4.2.5 TEST SETUP

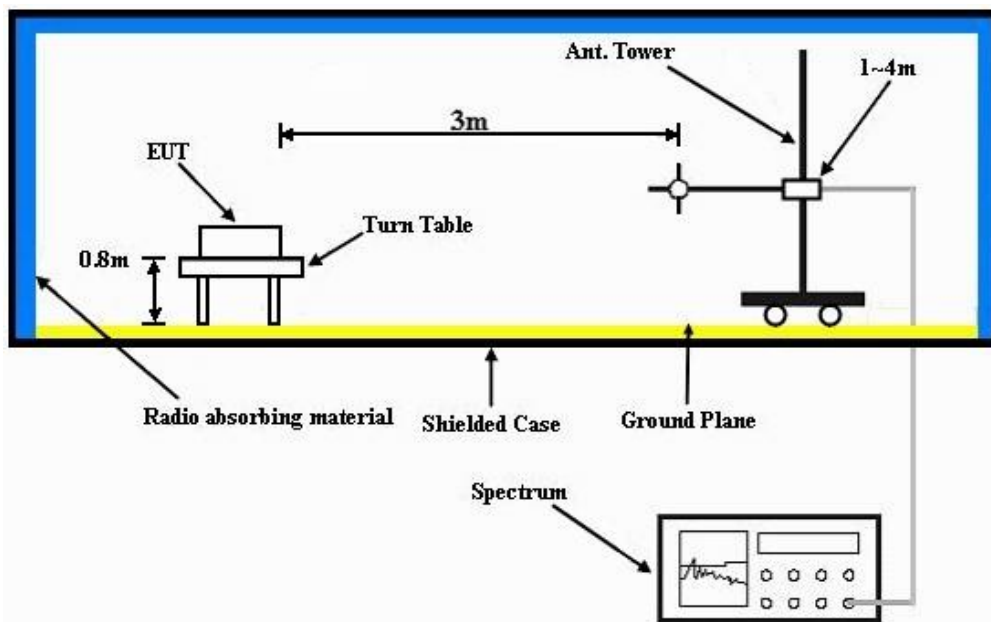

For the actual test configuration, please refer to the related item – Photographs of the Test Configuration.

### 4.2.6 EUT OPERATING CONDITIONS

Same as 4.1.6





A D T

## 4.2.7 TEST RESULTS

## BELOW 1GHz WORST-CASE DATA : 802.11g OFDM MODULATION

EUT TEST CONDITION		MEASUREMENT DETAIL	
CHANNEL	Channel 6	FREQUENCY RANGE	Below 1000MHz
INPUT POWER	120Vac, 60 Hz	DETECTOR FUNCTION	Quasi-Peak
ENVIRONMENTAL CONDITIONS	22deg. C, 61%RH 1023 hPa	TESTED BY	Kent Liu

ANTENNA POLARITY & TEST DISTANCE: HORIZONTAL AT 3 M								
NO.	FREQ. (MHz)	EMISSION LEVEL (dBuV/m)	LIMIT (dBuV/m)	MARGIN (dB)	ANTENNA HEIGHT (m)	TABLE ANGLE (Degree)	RAW VALUE (dBuV)	CORRECTION FACTOR (dB/m)
1	108.60	27.3 QP	43.5	-16.2	1.50 H	221	16.70	10.63
2	151.20	31.0 QP	43.5	-12.5	1.50 H	314	16.56	14.48
3	189.50	30.7 QP	43.5	-12.8	1.50 H	118	18.65	12.01
4	250.00	31.2 QP	46.0	-14.8	1.25 H	169	18.20	13.04
5	530.00	31.4 QP	46.0	-14.7	1.25 H	29	11.17	20.18
6	940.60	29.1 QP	46.0	-16.9	2.00 H	198	2.85	26.26
ANTENNA POLARITY & TEST DISTANCE: VERTICAL AT 3 M								
NO.	FREQ. (MHz)	EMISSION LEVEL (dBuV/m)	LIMIT (dBuV/m)	MARGIN (dB)	ANTENNA HEIGHT (m)	TABLE ANGLE (Degree)	RAW VALUE (dBuV)	CORRECTION FACTOR (dB/m)
1	51.08	35.0 QP	40.0	-5.1	1.00 V	169	20.82	14.13
2	59.96	34.5 QP	40.0	-5.5	1.00 V	310	21.06	13.46
3	191.65	28.8 QP	43.5	-14.8	1.00 V	301	16.91	11.84
4	250.03	24.4 QP	46.0	-21.6	2.00 V	48	11.40	13.04
5	529.98	32.7 QP	46.0	-13.3	1.00 V	303	12.54	20.18
6	941.03	24.2 QP	46.0	-21.8	1.00 V	321	-2.05	26.26

- REMARKS:**
1. Emission level (dBuV/m) = Raw Value (dBuV) + Correction Factor (dB/m).
  2. Correction Factor (dB/m) = Antenna Factor (dB/m) + Cable Factor (dB).
  3. The other emission levels were very low against the limit.
  4. Margin value = Emission level – Limit value.



## ABOVE 1GHz WORST-CASE DATA

### 802.11b DSSS MODULATION

EUT TEST CONDITION		MEASUREMENT DETAIL	
CHANNEL	Channel 1	FREQUENCY RANGE	1 ~ 25GHz
INPUT POWER	120Vac, 60 Hz	DETECTOR FUNCTION	Peak (PK) Average (AV)
ENVIRONMENTAL CONDITIONS	12deg. C, 64%RH 1023 hPa	TESTED BY	Frank Liu

ANTENNA POLARITY & TEST DISTANCE: HORIZONTAL AT 3 M								
NO.	FREQ. (MHz)	EMISSION LEVEL (dBuV/m)	LIMIT (dBuV/m)	MARGIN (dB)	ANTENNA HEIGHT (m)	TABLE ANGLE (Degree)	RAW VALUE (dBuV)	CORRECTION FACTOR (dB/m)
1	2387.07	58.1 PK	74.0	-15.9	1.00 H	6	26.52	31.58
2	2387.07	47.0 AV	54.0	-7.0	1.00 H	6	15.42	31.58
3	*2412.00	106.9 PK			1.00 H	60	75.24	31.66
4	*2412.00	104.3 AV			1.00 H	60	72.64	31.66
5	4824.00	55.3 PK	74.0	-18.7	1.00 H	280	16.23	39.07
6	4824.00	52.1 AV	54.0	-1.9	1.00 H	280	13.03	39.07
ANTENNA POLARITY & TEST DISTANCE: VERTICAL AT 3 M								
NO.	FREQ. (MHz)	EMISSION LEVEL (dBuV/m)	LIMIT (dBuV/m)	MARGIN (dB)	ANTENNA HEIGHT (m)	TABLE ANGLE (Degree)	RAW VALUE (dBuV)	CORRECTION FACTOR (dB/m)
1	2386.96	62.1 PK	74.0	-11.9	1.00 V	186	30.52	31.58
2	2386.96	52.6 AV	54.0	-1.4	1.00 V	186	21.02	31.58
3	*2412.00	110.9 PK			1.00 V	186	79.24	31.66
4	*2412.00	108.7 AV			1.00 V	186	77.04	31.66
5	4824.00	56.0 PK	74.0	-18.0	1.12 V	37	16.93	39.07
6	4824.00	52.5 AV	54.0	-1.5	1.12 V	37	13.43	39.07

- REMARKS:**
1. Emission level (dBuV/m) = Raw Value (dBuV) + Correction Factor (dB/m).
  2. Correction Factor (dB/m) = Antenna Factor (dB/m) + Cable Factor (dB).
  3. The other emission levels were very low against the limit.
  4. Margin value = Emission level – Limit value.
  5. “ \* “: Fundamental frequency.



A D T

EUT TEST CONDITION		MEASUREMENT DETAIL	
CHANNEL	Channel 6	FREQUENCY RANGE	1 ~ 25GHz
INPUT POWER	120Vac, 60 Hz	DETECTOR FUNCTION	Peak (PK) Average (AV)
ENVIRONMENTAL CONDITIONS	12deg. C, 64%RH 1023 hPa	TESTED BY	Frank Liu

ANTENNA POLARITY & TEST DISTANCE: HORIZONTAL AT 3 M								
NO.	FREQ. (MHz)	EMISSION LEVEL (dBuV/m)	LIMIT (dBuV/m)	MARGIN (dB)	ANTENNA HEIGHT (m)	TABLE ANGLE (Degree)	RAW VALUE (dBuV)	CORRECTION FACTOR (dB/m)
1	2356.00	62.2 PK	74.0	-11.8	1.00 H	62	30.72	31.48
2	2356.00	52.0 AV	54.0	-2.0	1.00 H	62	20.52	31.48
3	*2437.00	107.4 PK			1.00 H	62	75.65	31.75
4	*2437.00	105.4 AV			1.00 H	62	73.65	31.75
5	4874.00	55.8 PK	74.0	-18.2	1.14 H	47	16.57	39.23
6	4874.00	53.2 AV	54.0	-0.8	1.14 H	47	13.97	39.23
7	7311.00	55.4 PK	74.0	-18.6	1.00 H	277	8.83	46.57
8	7311.00	49.4 AV	54.0	-4.6	1.00 H	277	2.83	46.57
ANTENNA POLARITY & TEST DISTANCE: VERTICAL AT 3 M								
NO.	FREQ. (MHz)	EMISSION LEVEL (dBuV/m)	LIMIT (dBuV/m)	MARGIN (dB)	ANTENNA HEIGHT (m)	TABLE ANGLE (Degree)	RAW VALUE (dBuV)	CORRECTION FACTOR (dB/m)
1	2354.10	62.4 PK	74.0	-11.6	1.00 V	157	30.93	31.47
2	2354.10	51.0 AV	54.0	-3.0	1.00 V	157	19.53	31.47
3	*2437.00	111.6 PK			1.00 V	205	79.85	31.75
4	*2437.00	109.6 AV			1.00 V	205	77.85	31.75
5	4874.00	54.1 PK	74.0	-19.9	1.14 V	281	14.87	39.23
6	4874.00	50.8 AV	54.0	-3.2	1.14 V	281	11.57	39.23
7	7311.00	55.4 PK	74.0	-18.6	1.23 V	112	8.83	46.57
8	7311.00	50.1 AV	54.0	-3.9	1.23 V	112	3.53	46.57

- REMARKS:**
1. Emission level (dBuV/m) = Raw Value (dBuV) + Correction Factor (dB/m).
  2. Correction Factor (dB/m) = Antenna Factor (dB/m) + Cable Factor (dB).
  3. The other emission levels were very low against the limit.
  4. Margin value = Emission level – Limit value.
  5. “ \* “: Fundamental frequency.



A D T

EUT TEST CONDITION		MEASUREMENT DETAIL	
CHANNEL	Channel 11	FREQUENCY RANGE	1 ~ 25GHz
INPUT POWER	120Vac, 60 Hz	DETECTOR FUNCTION	Peak (PK) Average (AV)
ENVIRONMENTAL CONDITIONS	12deg. C, 64%RH 1023 hPa	TESTED BY	Frank Liu

**ANTENNA POLARITY & TEST DISTANCE: HORIZONTAL AT 3 M**

NO.	FREQ. (MHz)	EMISSION LEVEL (dBuV/m)	LIMIT (dBuV/m)	MARGIN (dB)	ANTENNA HEIGHT (m)	TABLE ANGLE (Degree)	RAW VALUE (dBuV)	CORRECTION FACTOR (dB/m)
1	*2462.00	105.4 PK			1.00 H	72	73.57	31.83
2	*2462.00	103.1 AV			1.00 H	72	71.27	31.83
3	2483.50	56.6 PK	74.0	-17.4	1.00 H	72	24.70	31.90
4	2483.50	46.1 AV	54.0	-7.9	1.00 H	72	14.20	31.90
5	4924.00	55.2 PK	74.0	-18.8	1.42 H	54	15.81	39.39
6	4924.00	52.1 AV	54.0	-1.9	1.42 H	54	12.71	39.39
7	7386.00	53.4 PK	74.0	-20.6	1.14 H	254	6.93	46.47
8	7386.00	45.3 AV	54.0	-8.7	1.14 H	254	-1.17	46.47

**ANTENNA POLARITY & TEST DISTANCE: VERTICAL AT 3 M**

NO.	FREQ. (MHz)	EMISSION LEVEL (dBuV/m)	LIMIT (dBuV/m)	MARGIN (dB)	ANTENNA HEIGHT (m)	TABLE ANGLE (Degree)	RAW VALUE (dBuV)	CORRECTION FACTOR (dB/m)
1	*2462.00	109.7 PK			1.00 V	174	77.87	31.83
2	*2462.00	107.2 AV			1.00 V	174	75.37	31.83
3	2483.53	60.2 PK	74.0	-13.8	1.00 V	174	28.30	31.90
4	2483.53	50.0 AV	54.0	-4.0	1.00 V	174	18.10	31.90
5	4924.00	52.1 PK	74.0	-21.9	1.11 V	258	12.71	39.39
6	4924.00	47.1 AV	54.0	-6.9	1.11 V	258	7.71	39.39
7	7386.00	55.1 PK	74.0	-18.9	1.25 V	97	8.63	46.47
8	7386.00	48.0 AV	54.0	-6.0	1.25 V	97	1.53	46.47

- REMARKS:**
1. Emission level (dBuV/m) = Raw Value (dBuV) + Correction Factor (dB/m).
  2. Correction Factor (dB/m) = Antenna Factor (dB/m) + Cable Factor (dB).
  3. The other emission levels were very low against the limit.
  4. Margin value = Emission level – Limit value.
  5. “ \* “: Fundamental frequency.



A D T

RESTRICTED BANDEDGE (802.11b MODE, CH1, HORIZONTAL )

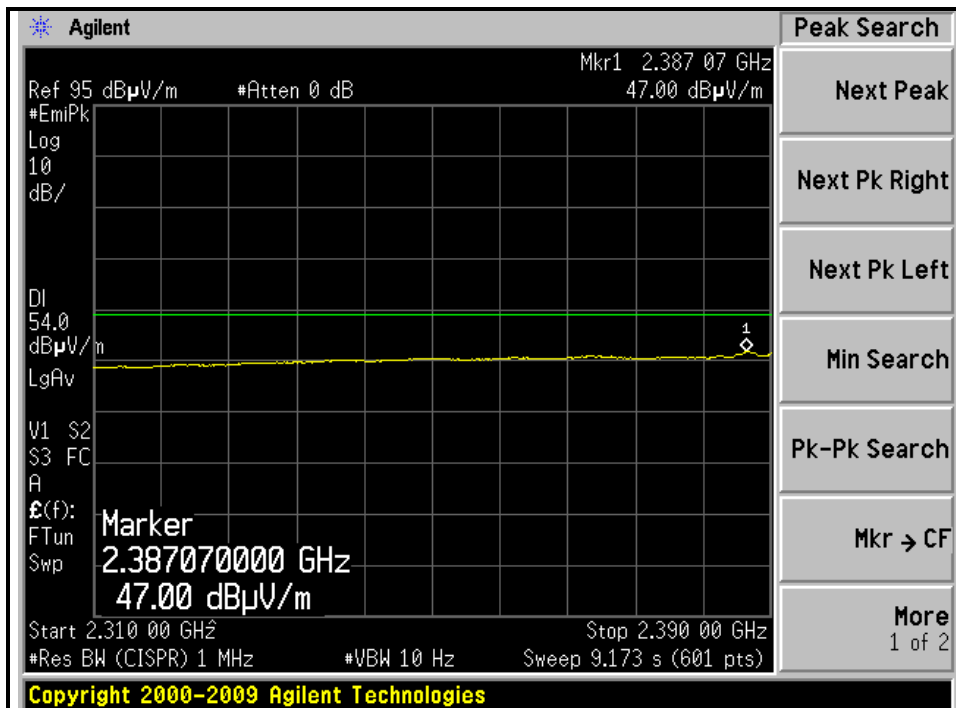
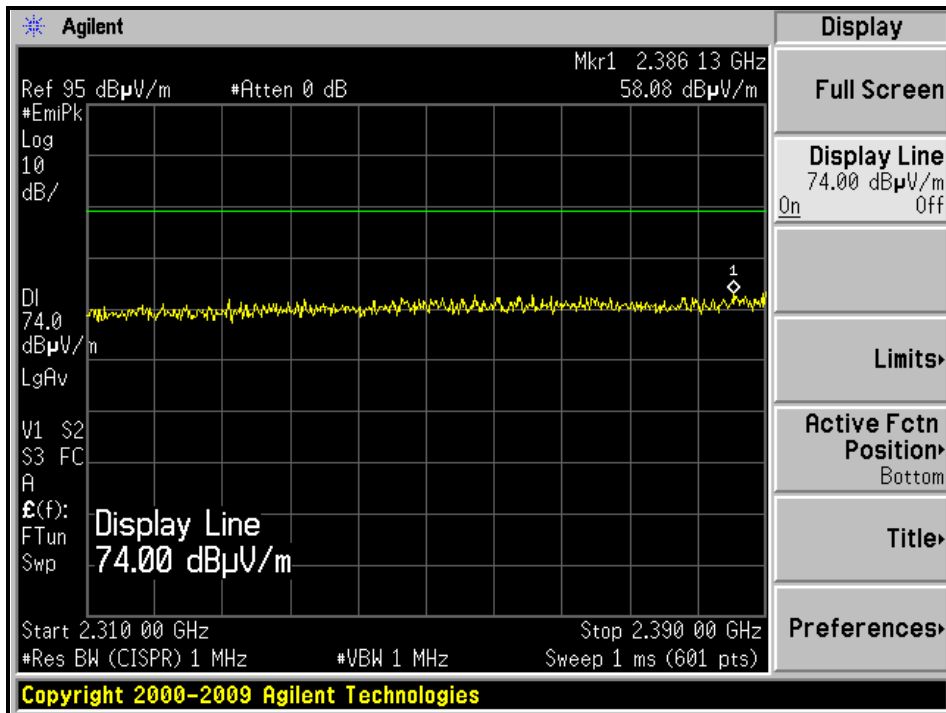



A D T

RESTRICTED BANDEDGE (802.11b MODE, CH1, VERTICAL )

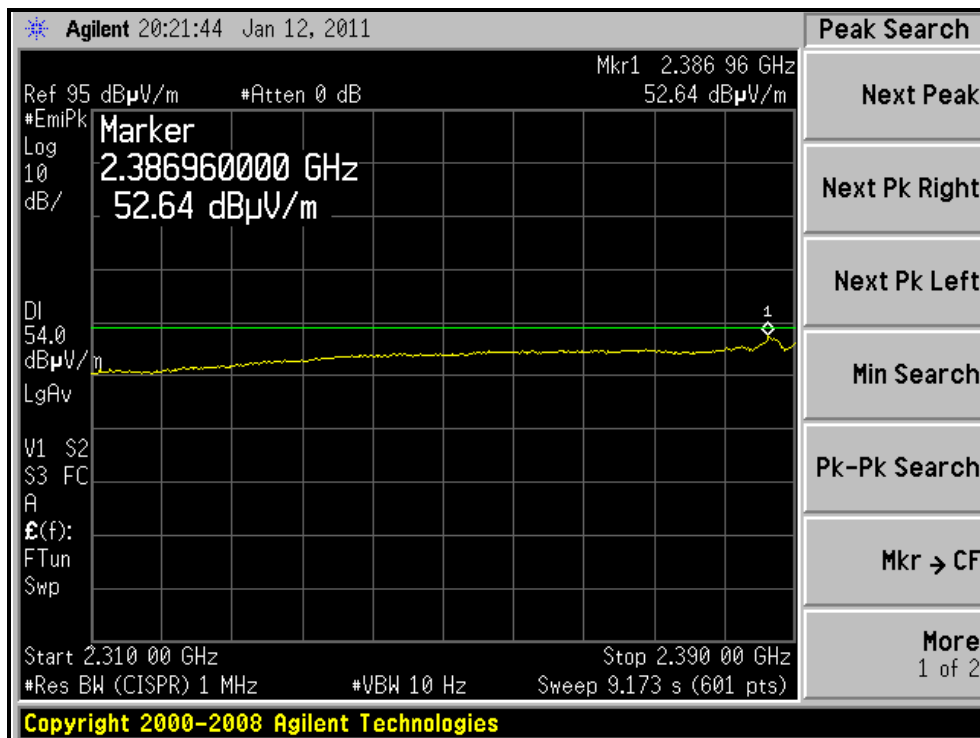
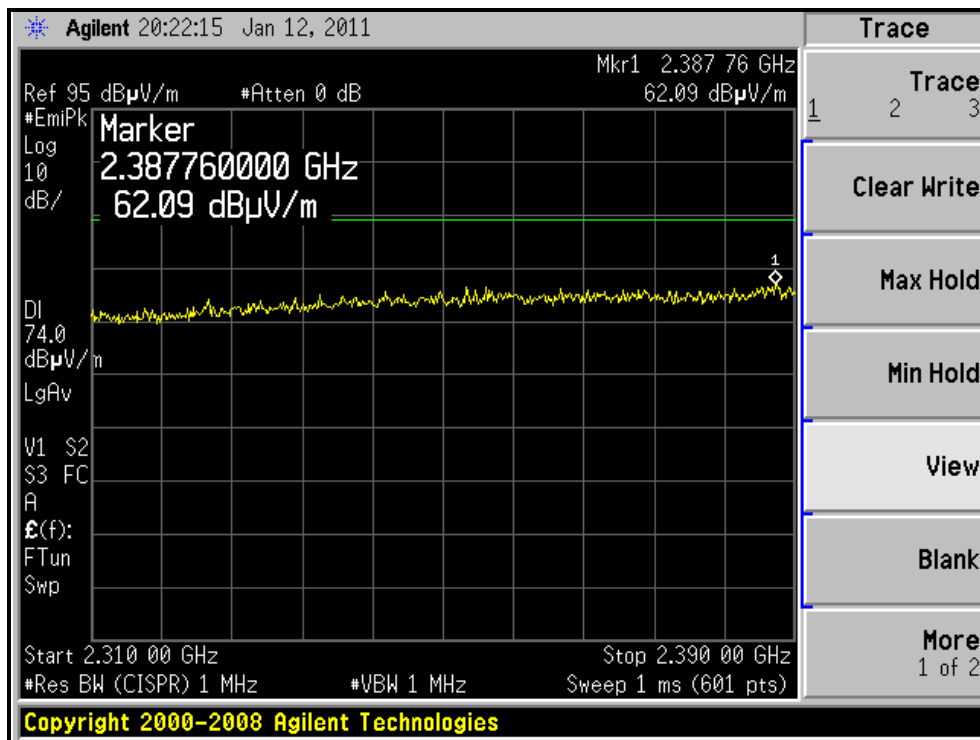

RESTRICTED BANDEDGE (802.11b MODE, CH11, HORIZONTAL )

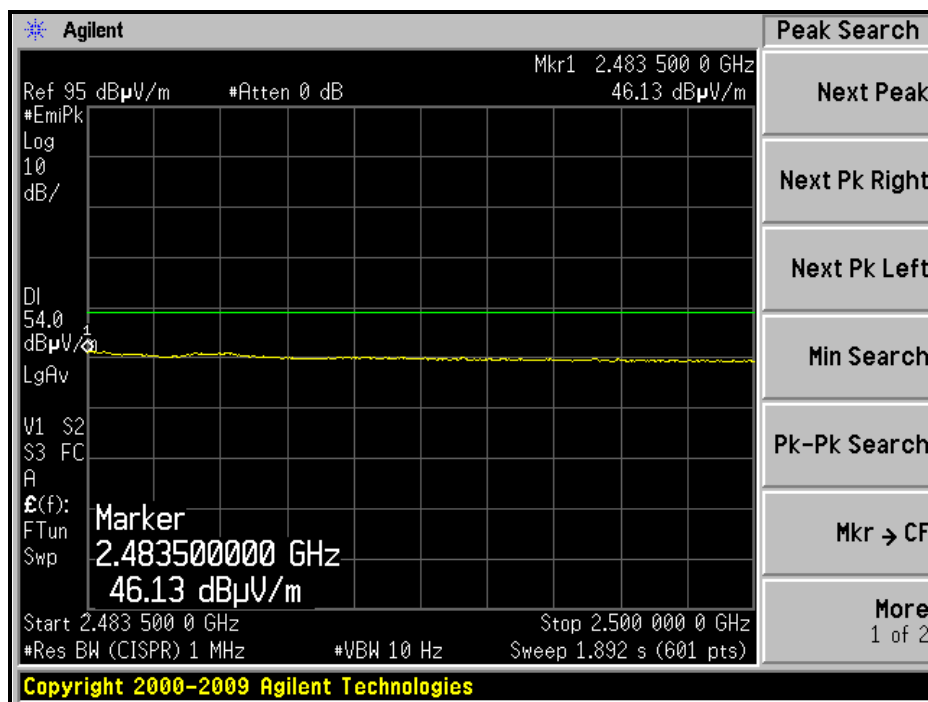
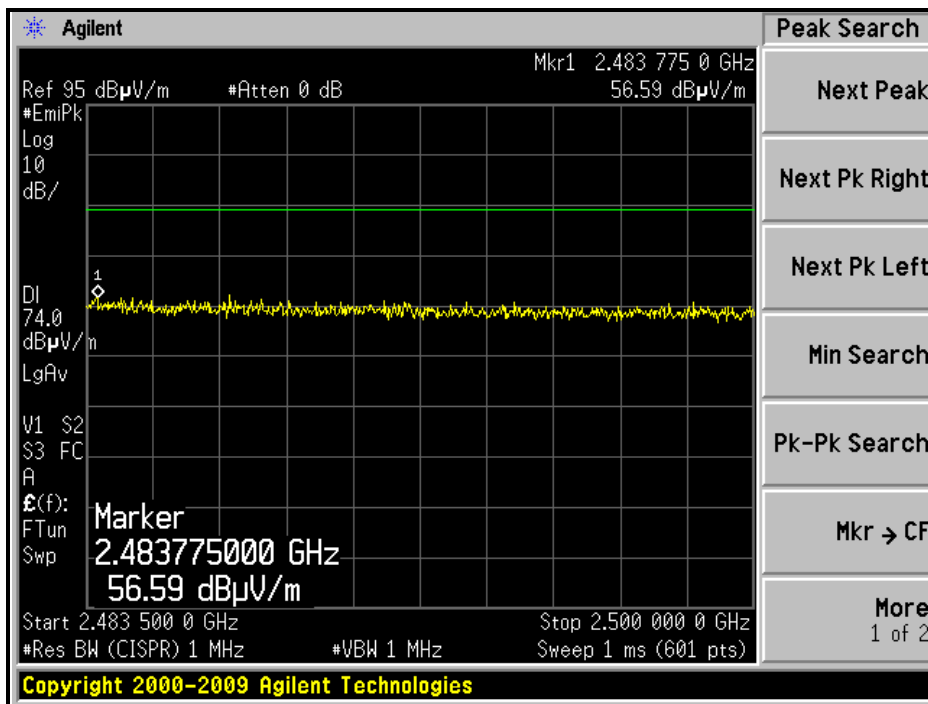



A D T

### RESTRICTED BANDEDGE (802.11b MODE, CH11, VERTICAL)

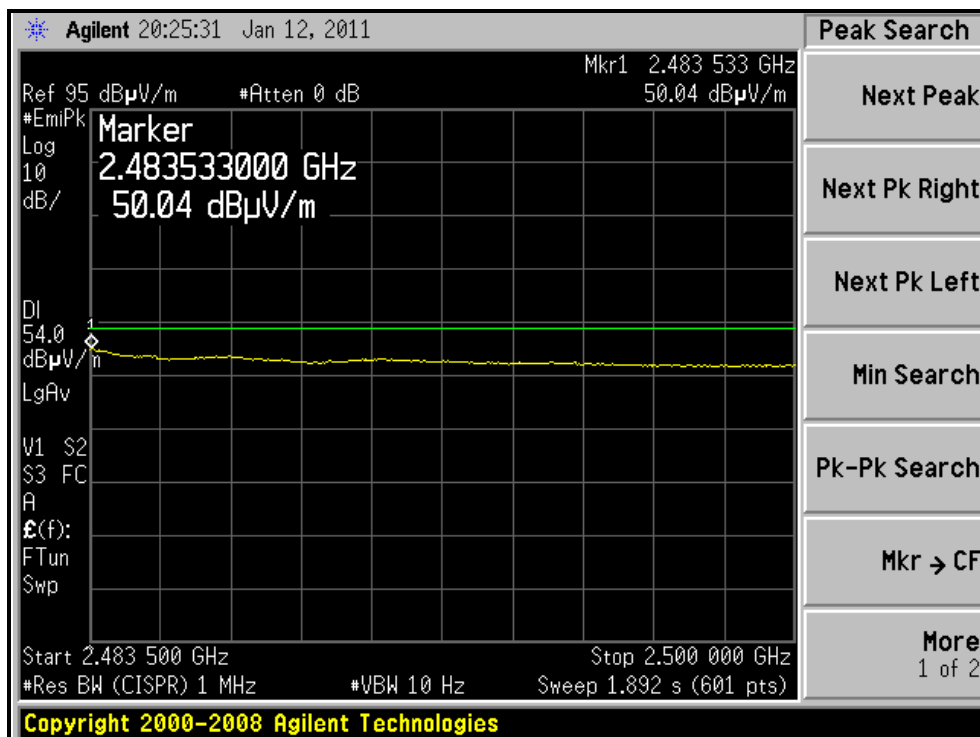
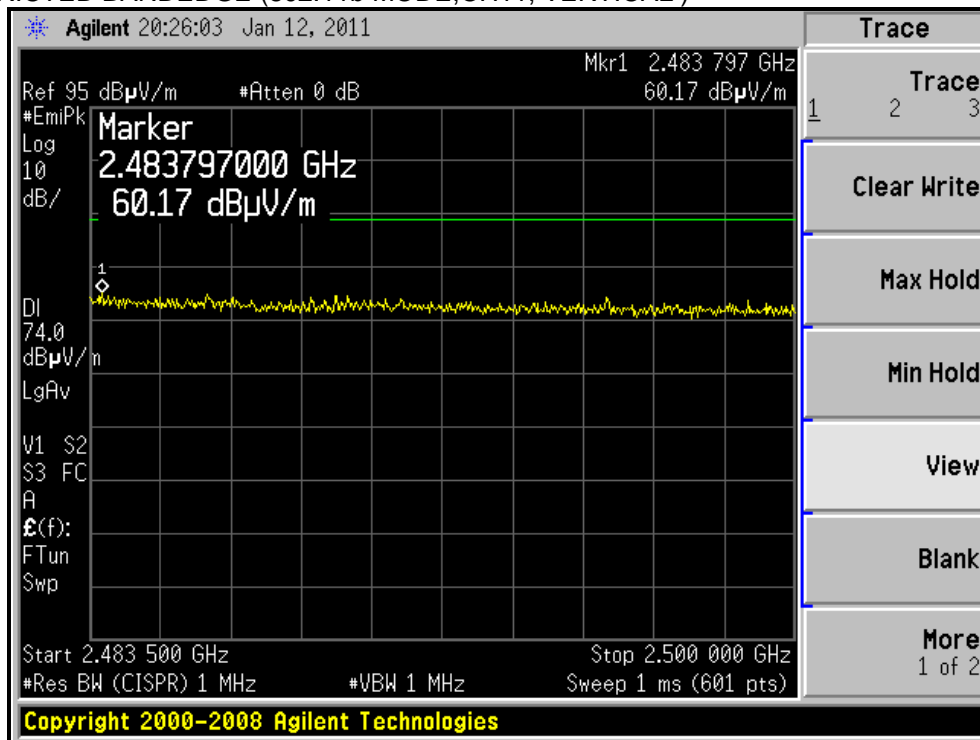





A D T

### 802.11g OFDM MODULATION

EUT TEST CONDITION		MEASUREMENT DETAIL	
CHANNEL	Channel 1	FREQUENCY RANGE	1 ~ 25GHz
INPUT POWER	120Vac, 60 Hz	DETECTOR FUNCTION	Peak (PK) Average (AV)
ENVIRONMENTAL CONDITIONS	12deg. C, 64%RH 1023 hPa	TESTED BY	Frank Liu

#### ANTENNA POLARITY & TEST DISTANCE: HORIZONTAL AT 3 M

NO.	FREQ. (MHz)	EMISSION LEVEL (dBuV/m)	LIMIT (dBuV/m)	MARGIN (dB)	ANTENNA HEIGHT (m)	TABLE ANGLE (Degree)	RAW VALUE (dBuV)	CORRECTION FACTOR (dB/m)
1	2390.00	63.5 PK	74.0	-10.5	1.00 H	62	31.91	31.59
2	2390.00	46.7 AV	54.0	-7.3	1.00 H	62	15.11	31.59
3	*2412.00	109.7 PK			1.00 H	60	78.04	31.66
4	*2412.00	99.9 AV			1.00 H	60	68.24	31.66
5	4824.00	49.4 PK	74.0	-24.6	1.00 H	279	10.33	39.07
6	4824.00	39.6 AV	54.0	-14.4	1.00 H	279	0.53	39.07

#### ANTENNA POLARITY & TEST DISTANCE: VERTICAL AT 3 M

NO.	FREQ. (MHz)	EMISSION LEVEL (dBuV/m)	LIMIT (dBuV/m)	MARGIN (dB)	ANTENNA HEIGHT (m)	TABLE ANGLE (Degree)	RAW VALUE (dBuV)	CORRECTION FACTOR (dB/m)
1	2390.00	69.5 PK	74.0	-4.5	1.16 V	184	37.91	31.59
2	2390.00	53.0 AV	54.0	-1.0	1.16 V	184	21.41	31.59
3	*2412.00	108.0 PK			1.00 V	186	76.34	31.66
4	*2412.00	98.3 AV			1.00 V	186	66.64	31.66
5	4824.00	49.8 PK	74.0	-24.2	1.14 V	47	10.73	39.07
6	4824.00	39.3 AV	54.0	-14.7	1.14 V	47	0.23	39.07

- REMARKS:**
1. Emission level (dBuV/m) = Raw Value (dBuV) + Correction Factor (dB/m).
  2. Correction Factor (dB/m) = Antenna Factor (dB/m) + Cable Factor (dB).
  3. The other emission levels were very low against the limit.
  4. Margin value = Emission level – Limit value.
  5. “ \* “: Fundamental frequency.



A D T

EUT TEST CONDITION		MEASUREMENT DETAIL	
CHANNEL	Channel 6	FREQUENCY RANGE	1 ~ 25GHz
INPUT POWER	120Vac, 60 Hz	DETECTOR FUNCTION	Peak (PK) Average (AV)
ENVIRONMENTAL CONDITIONS	12deg. C, 64%RH 1023 hPa	TESTED BY	Frank Liu

ANTENNA POLARITY & TEST DISTANCE: HORIZONTAL AT 3 M								
NO.	FREQ. (MHz)	EMISSION LEVEL (dBuV/m)	LIMIT (dBuV/m)	MARGIN (dB)	ANTENNA HEIGHT (m)	TABLE ANGLE (Degree)	RAW VALUE (dBuV)	CORRECTION FACTOR (dB/m)
1	*2437.00	115.1 PK			1.01 H	62	83.35	31.75
2	*2437.00	104.7 AV			1.01 H	62	72.95	31.75
3	4874.00	51.3 PK	74.0	-22.7	1.00 H	273	12.07	39.23
4	4874.00	41.4 AV	54.0	-12.6	1.00 H	273	2.17	39.23
5	7311.00	55.1 PK	74.0	-18.9	1.14 H	283	8.53	46.57
6	7311.00	49.3 AV	54.0	-4.7	1.14 H	283	2.73	46.57

ANTENNA POLARITY & TEST DISTANCE: VERTICAL AT 3 M								
NO.	FREQ. (MHz)	EMISSION LEVEL (dBuV/m)	LIMIT (dBuV/m)	MARGIN (dB)	ANTENNA HEIGHT (m)	TABLE ANGLE (Degree)	RAW VALUE (dBuV)	CORRECTION FACTOR (dB/m)
1	2390.00	67.5 PK	74.0	-6.5	1.00 V	181	35.91	31.59
2	2390.00	53.0 AV	54.0	-1.0	1.00 V	181	21.41	31.59
3	*2437.00	113.6 PK			1.00 V	192	81.85	31.75
4	*2437.00	103.8 AV			1.00 V	192	72.05	31.75
5	4874.00	51.6 PK	74.0	-22.4	1.13 V	54	12.37	39.23
6	4874.00	41.7 AV	54.0	-12.3	1.13 V	54	2.47	39.23
7	7311.00	55.2 PK	74.0	-18.8	1.21 V	143	8.63	46.57
8	7311.00	49.4 AV	54.0	-4.6	1.21 V	143	2.83	46.57

- REMARKS:**
1. Emission level (dBuV/m) = Raw Value (dBuV) + Correction Factor (dB/m).
  2. Correction Factor (dB/m) = Antenna Factor (dB/m) + Cable Factor (dB).
  3. The other emission levels were very low against the limit.
  4. Margin value = Emission level – Limit value.
  5. “ \* “: Fundamental frequency.



A D T

EUT TEST CONDITION		MEASUREMENT DETAIL	
CHANNEL	Channel 11	FREQUENCY RANGE	1 ~ 25GHz
INPUT POWER	120Vac, 60 Hz	DETECTOR FUNCTION	Peak (PK) Average (AV)
ENVIRONMENTAL CONDITIONS	12deg. C, 64%RH 1023 hPa	TESTED BY	Frank Liu

**ANTENNA POLARITY & TEST DISTANCE: HORIZONTAL AT 3 M**

NO.	FREQ. (MHz)	EMISSION LEVEL (dBuV/m)	LIMIT (dBuV/m)	MARGIN (dB)	ANTENNA HEIGHT (m)	TABLE ANGLE (Degree)	RAW VALUE (dBuV)	CORRECTION FACTOR (dB/m)
1	*2462.00	110.3 PK			1.01 H	63	78.47	31.83
2	*2462.00	100.4 AV			1.01 H	63	68.57	31.83
3	2483.50	69.3 PK	74.0	-4.7	1.00 H	65	37.40	31.90
4	2483.50	49.3 AV	54.0	-4.7	1.00 H	65	17.40	31.90
5	4924.00	50.4 PK	74.0	-23.6	1.00 H	243	11.01	39.39
6	4924.00	40.2 AV	54.0	-13.8	1.00 H	243	0.81	39.39
7	7386.00	55.2 PK	74.0	-18.8	1.13 H	279	8.73	46.47
8	7386.00	49.4 AV	54.0	-4.6	1.13 H	279	2.93	46.47

**ANTENNA POLARITY & TEST DISTANCE: VERTICAL AT 3 M**

NO.	FREQ. (MHz)	EMISSION LEVEL (dBuV/m)	LIMIT (dBuV/m)	MARGIN (dB)	ANTENNA HEIGHT (m)	TABLE ANGLE (Degree)	RAW VALUE (dBuV)	CORRECTION FACTOR (dB/m)
1	*2462.00	109.1 PK			1.00 V	169	77.27	31.83
2	*2462.00	99.4 AV			1.00 V	169	67.57	31.83
3	2483.50	73.0 PK	74.0	-1.0	1.16 V	311	41.10	31.90
4	2483.50	52.1 AV	54.0	-1.9	1.16 V	311	20.20	31.90
5	4924.00	50.6 PK	74.0	-23.4	1.14 V	69	11.21	39.39
6	4924.00	40.4 AV	54.0	-13.6	1.14 V	69	1.01	39.39
7	7386.00	55.3 PK	74.0	-18.7	1.00 V	162	8.83	46.47
8	7386.00	48.7 AV	54.0	-5.3	1.00 V	162	2.23	46.47

- REMARKS:**
1. Emission level (dBuV/m) = Raw Value (dBuV) + Correction Factor (dB/m).
  2. Correction Factor (dB/m) = Antenna Factor (dB/m) + Cable Factor (dB).
  3. The other emission levels were very low against the limit.
  4. Margin value = Emission level – Limit value.
  5. “ \* “: Fundamental frequency.



A D T

RESTRICTED BANDEDGE (802.11g MODE, CH1, HORIZONTAL )

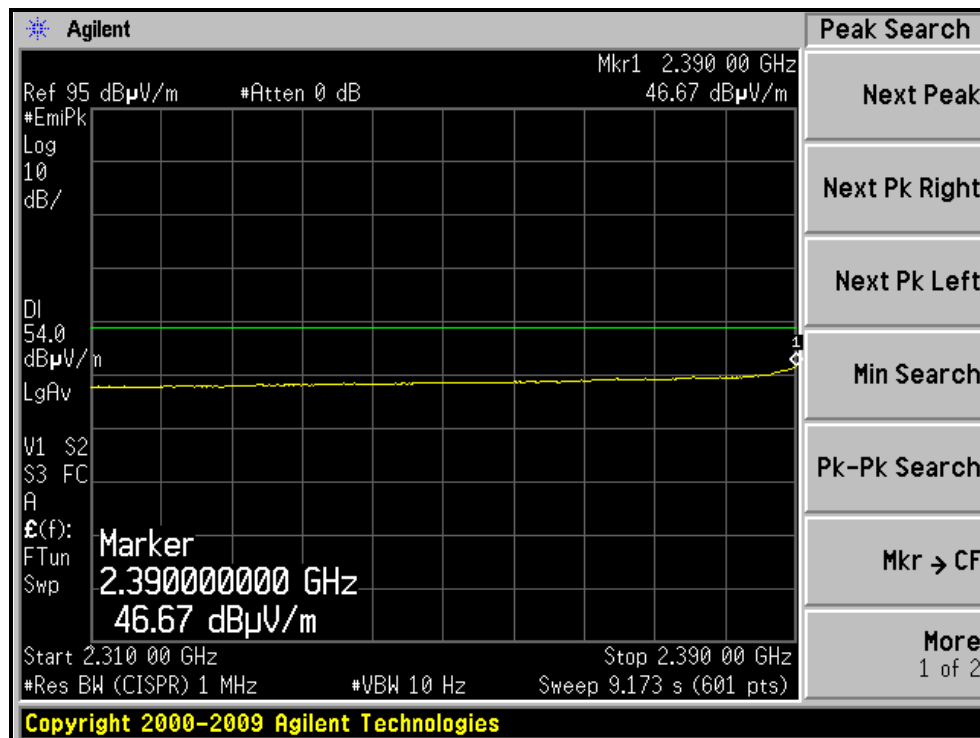
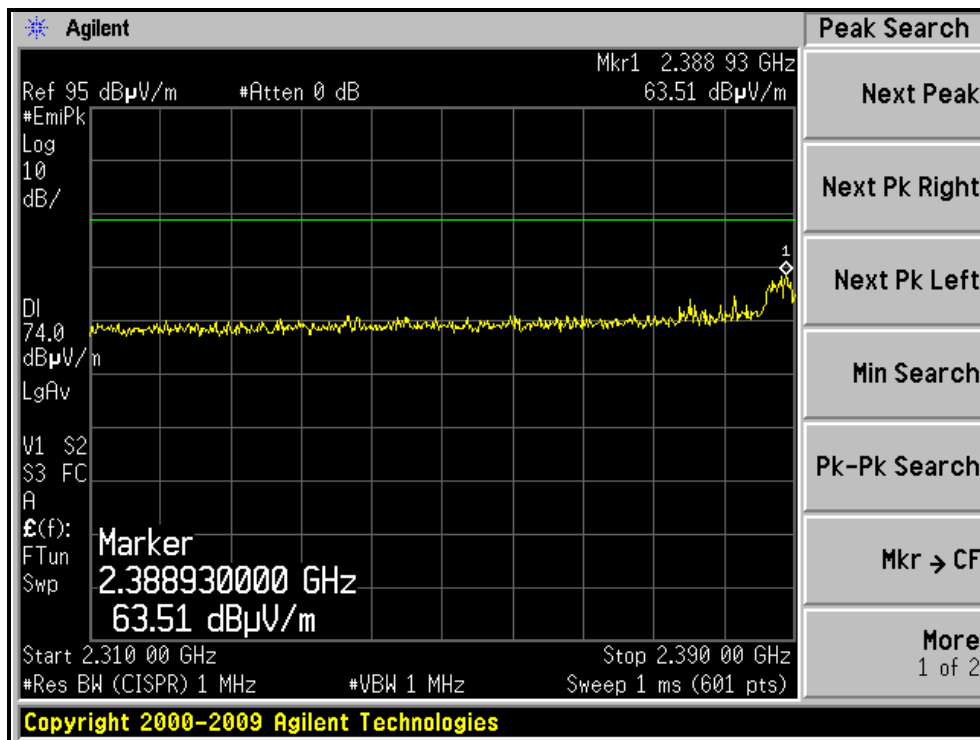



A D T

### RESTRICTED BANDEDGE (802.11g MODE,CH1, VERTICAL )

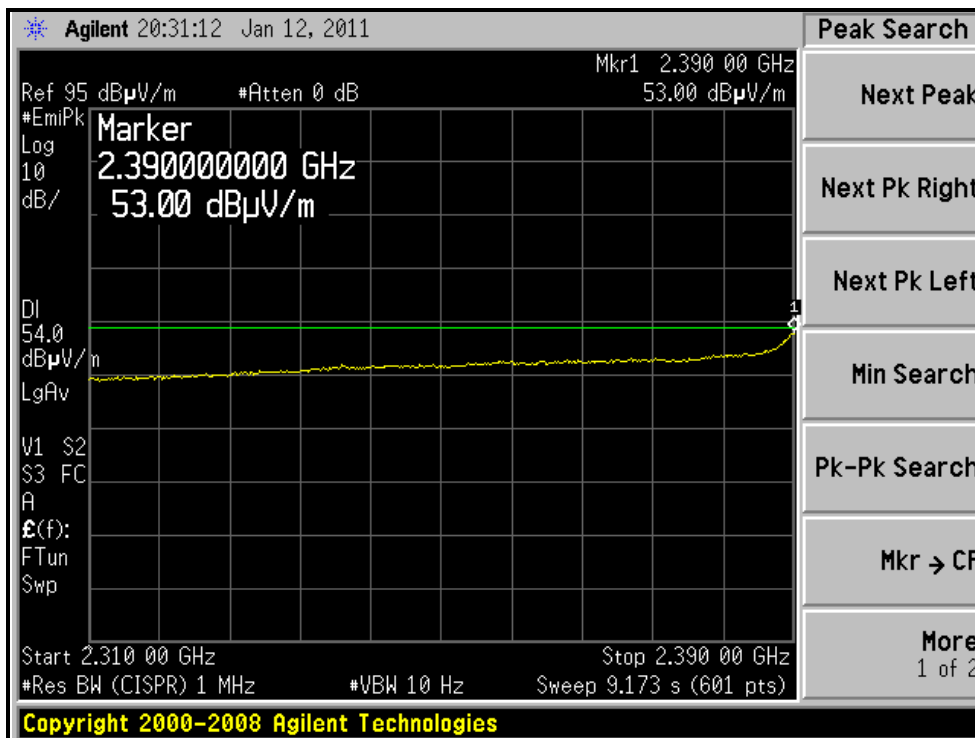
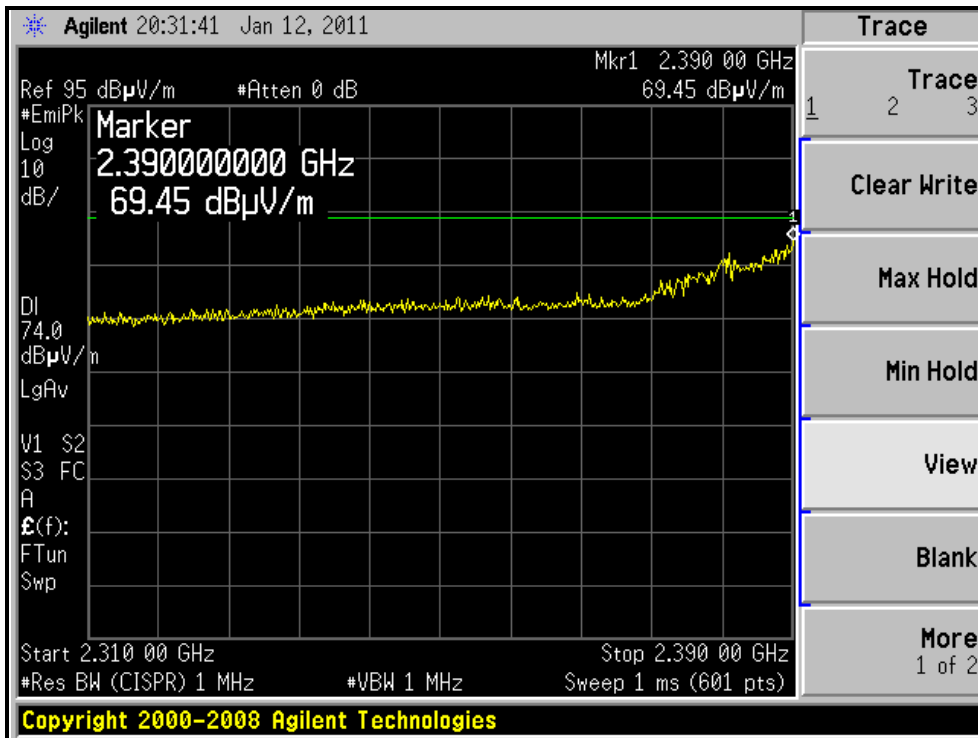



A D T

RESTRICTED BANDEDGE (802.11g MODE, CH11, HORIZONTAL )

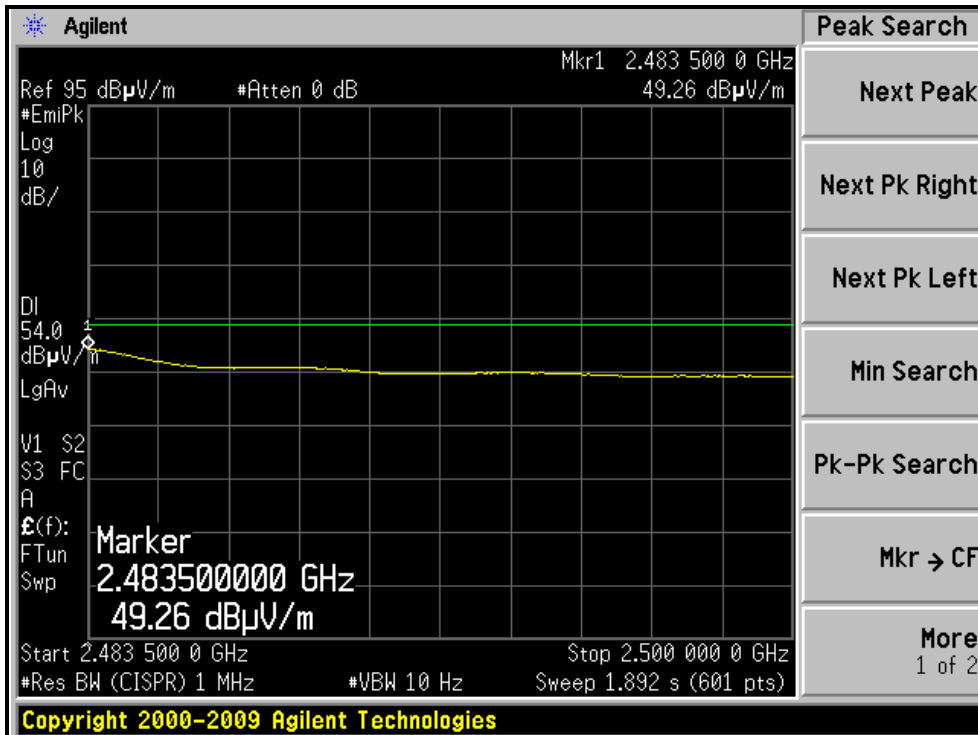
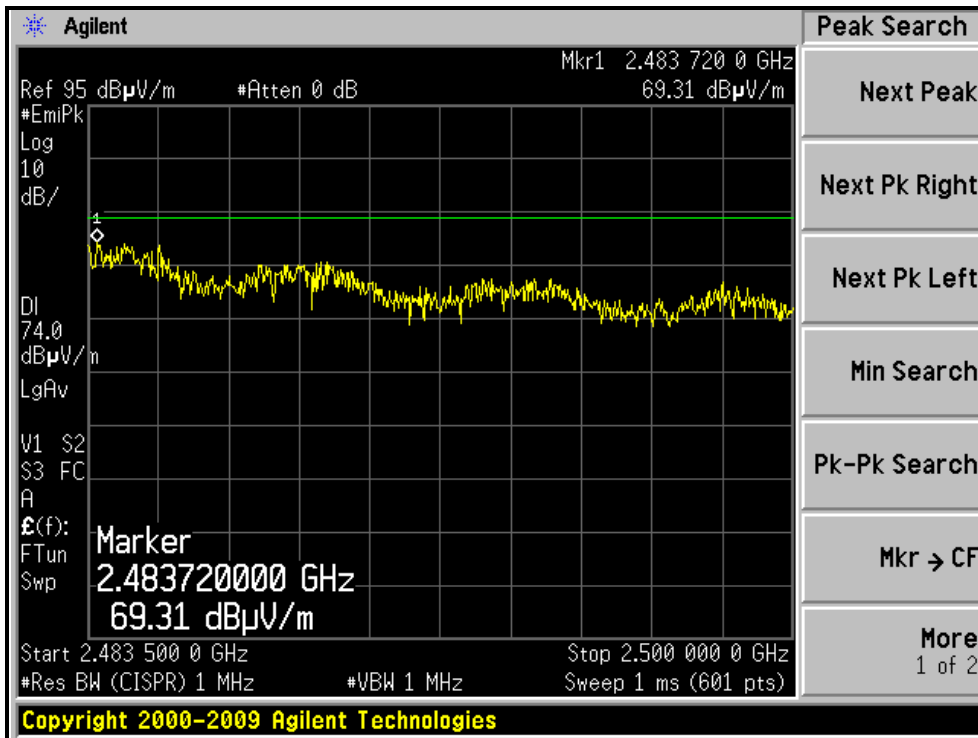



A D T

RESTRICTED BANDEDGE (802.11g MODE, CH11, VERTICAL )

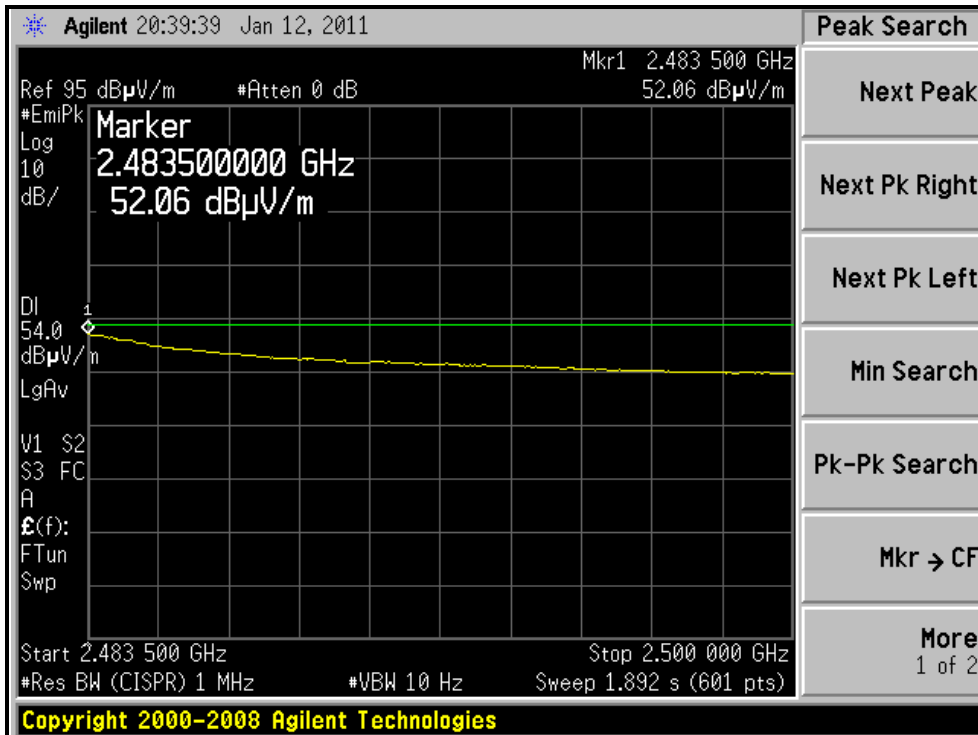
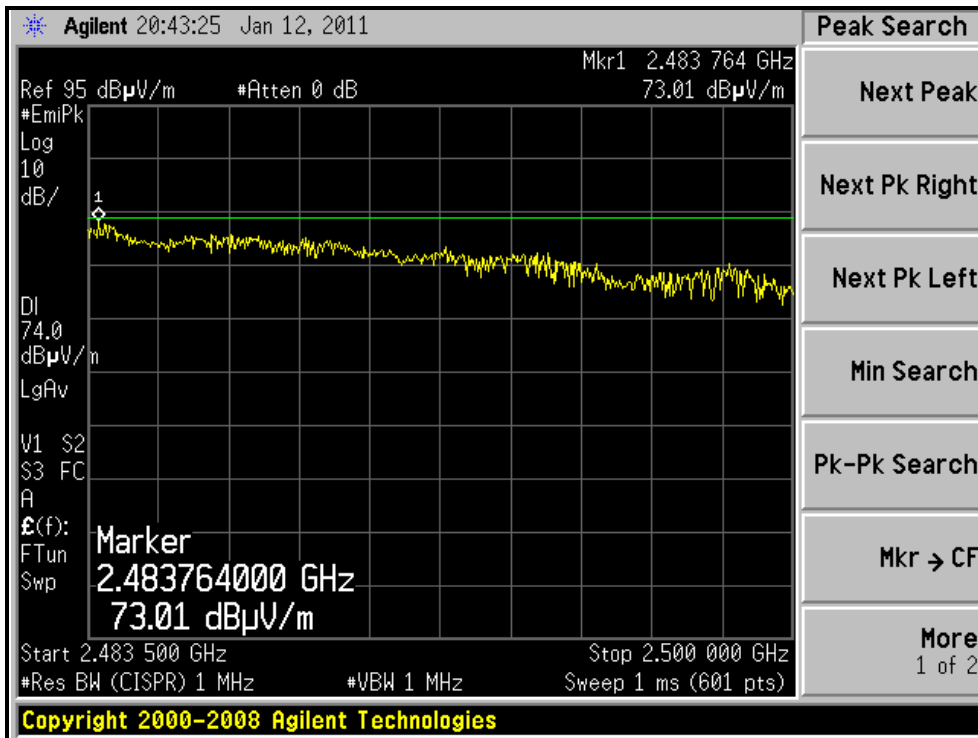



A D T

## 802.11n (20MHz) OFDM MODULATION

EUT TEST CONDITION		MEASUREMENT DETAIL	
CHANNEL	Channel 1	FREQUENCY RANGE	1 ~ 25GHz
INPUT POWER	120Vac, 60 Hz	DETECTOR FUNCTION	Peak (PK) Average (AV)
ENVIRONMENTAL CONDITIONS	12deg. C, 64%RH 1023 hPa	TESTED BY	Frank Liu

ANTENNA POLARITY & TEST DISTANCE: HORIZONTAL AT 3 M								
NO.	FREQ. (MHz)	EMISSION LEVEL (dBuV/m)	LIMIT (dBuV/m)	MARGIN (dB)	ANTENNA HEIGHT (m)	TABLE ANGLE (Degree)	RAW VALUE (dBuV)	CORRECTION FACTOR (dB/m)
1	2390.00	62.3 PK	74.0	-11.7	1.54 H	92	30.71	31.59
2	2390.00	47.1 AV	54.0	-6.9	1.54 H	92	15.51	31.59
3	*2412.00	109.0 PK			1.54 H	92	77.34	31.66
4	*2412.00	98.8 AV			1.54 H	92	67.14	31.66
5	4824.00	49.1 PK	74.0	-24.9	1.00 H	281	10.03	39.07
6	4824.00	38.4 AV	54.0	-15.6	1.00 H	281	-0.67	39.07
ANTENNA POLARITY & TEST DISTANCE: VERTICAL AT 3 M								
NO.	FREQ. (MHz)	EMISSION LEVEL (dBuV/m)	LIMIT (dBuV/m)	MARGIN (dB)	ANTENNA HEIGHT (m)	TABLE ANGLE (Degree)	RAW VALUE (dBuV)	CORRECTION FACTOR (dB/m)
1	2390.00	69.6 PK	74.0	-4.4	1.00 V	159	38.01	31.59
2	2390.00	52.8 AV	54.0	-1.2	1.00 V	159	21.21	31.59
3	*2412.00	105.3 PK			1.00 V	159	73.64	31.66
4	*2412.00	96.8 AV			1.00 V	159	65.14	31.66
5	4824.00	49.6 PK	74.0	-24.4	1.12 V	53	10.53	39.07
6	4824.00	39.2 AV	54.0	-14.8	1.12 V	53	0.13	39.07

- REMARKS:**
1. Emission level (dBuV/m) = Raw Value (dBuV) + Correction Factor (dB/m).
  2. Correction Factor (dB/m) = Antenna Factor (dB/m) + Cable Factor (dB).
  3. The other emission levels were very low against the limit.
  4. Margin value = Emission level – Limit value.
  5. “ \* “: Fundamental frequency.





A D T

EUT TEST CONDITION		MEASUREMENT DETAIL	
CHANNEL	Channel 6	FREQUENCY RANGE	1 ~ 25GHz
INPUT POWER	120Vac, 60 Hz	DETECTOR FUNCTION	Peak (PK) Average (AV)
ENVIRONMENTAL CONDITIONS	12deg. C, 64%RH 1023 hPa	TESTED BY	Frank Liu

**ANTENNA POLARITY & TEST DISTANCE: HORIZONTAL AT 3 M**

NO.	FREQ. (MHz)	EMISSION LEVEL (dBuV/m)	LIMIT (dBuV/m)	MARGIN (dB)	ANTENNA HEIGHT (m)	TABLE ANGLE (Degree)	RAW VALUE (dBuV)	CORRECTION FACTOR (dB/m)
1	2390.00	70.4 PK	74.0	-3.6	1.50 H	93	38.81	31.59
2	2390.00	53.0 AV	54.0	-1.0	1.50 H	93	21.41	31.59
3	*2437.00	116.4 PK			1.50 H	93	84.65	31.75
4	*2437.00	105.6 AV			1.50 H	93	73.85	31.75
5	4874.00	51.6 PK	74.0	-22.4	1.00 H	269	12.37	39.23
6	4874.00	41.7 AV	54.0	-12.3	1.00 H	269	2.47	39.23
7	7311.00	55.4 PK	74.0	-18.6	1.13 H	279	8.83	46.57
8	7311.00	49.7 AV	54.0	-4.3	1.13 H	279	3.13	46.57

**ANTENNA POLARITY & TEST DISTANCE: VERTICAL AT 3 M**

NO.	FREQ. (MHz)	EMISSION LEVEL (dBuV/m)	LIMIT (dBuV/m)	MARGIN (dB)	ANTENNA HEIGHT (m)	TABLE ANGLE (Degree)	RAW VALUE (dBuV)	CORRECTION FACTOR (dB/m)
1	2390.00	70.2 PK	74.0	-3.8	1.00 V	177	38.61	31.59
2	2390.00	53.5 AV	54.0	-0.5	1.00 V	177	21.91	31.59
3	*2437.00	112.3 PK			1.00 V	197	80.55	31.75
4	*2437.00	103.5 AV			1.00 V	197	71.75	31.75
5	4874.00	51.9 PK	74.0	-22.1	1.00 V	64	12.67	39.23
6	4874.00	41.3 AV	54.0	-12.7	1.00 V	64	2.07	39.23
7	7311.00	55.1 PK	74.0	-18.9	1.00 V	241	8.53	46.57
8	7311.00	49.4 AV	54.0	-4.6	1.00 V	241	2.83	46.57

- REMARKS:**
1. Emission level (dBuV/m) = Raw Value (dBuV) + Correction Factor (dB/m).
  2. Correction Factor (dB/m) = Antenna Factor (dB/m) + Cable Factor (dB).
  3. The other emission levels were very low against the limit.
  4. Margin value = Emission level – Limit value.
  5. “ \* “: Fundamental frequency.



A D T

EUT TEST CONDITION		MEASUREMENT DETAIL	
CHANNEL	Channel 11	FREQUENCY RANGE	1 ~ 25GHz
INPUT POWER	120Vac, 60 Hz	DETECTOR FUNCTION	Peak (PK) Average (AV)
ENVIRONMENTAL CONDITIONS	12deg. C, 64%RH 1023 hPa	TESTED BY	Frank Liu

**ANTENNA POLARITY & TEST DISTANCE: HORIZONTAL AT 3 M**

NO.	FREQ. (MHz)	EMISSION LEVEL (dBuV/m)	LIMIT (dBuV/m)	MARGIN (dB)	ANTENNA HEIGHT (m)	TABLE ANGLE (Degree)	RAW VALUE (dBuV)	CORRECTION FACTOR (dB/m)
1	*2462.00	112.7 PK			1.50 H	96	80.87	31.83
2	*2462.00	101.4 AV			1.50 H	96	69.57	31.83
3	2483.50	64.0 PK	74.0	-10.0	1.50 H	94	32.10	31.90
4	2483.50	47.4 AV	54.0	-6.6	1.50 H	94	15.50	31.90
5	4924.00	51.4 PK	74.0	-22.6	1.00 H	283	12.01	39.39
6	4924.00	41.3 AV	54.0	-12.7	1.00 H	283	1.91	39.39
7	7386.00	55.2 PK	74.0	-18.8	1.07 H	264	8.73	46.47
8	7386.00	49.1 AV	54.0	-4.9	1.07 H	264	2.63	46.47

**ANTENNA POLARITY & TEST DISTANCE: VERTICAL AT 3 M**

NO.	FREQ. (MHz)	EMISSION LEVEL (dBuV/m)	LIMIT (dBuV/m)	MARGIN (dB)	ANTENNA HEIGHT (m)	TABLE ANGLE (Degree)	RAW VALUE (dBuV)	CORRECTION FACTOR (dB/m)
1	*2462.00	108.9 PK			1.00 V	186	77.07	31.83
2	*2462.00	99.1 AV			1.00 V	186	67.27	31.83
3	2483.50	73.0 PK	74.0	-1.0	1.16 V	186	41.10	31.90
4	2483.50	52.9 AV	54.0	-1.1	1.16 V	186	21.00	31.90
5	4924.00	51.3 PK	74.0	-22.7	1.00 V	72	11.91	39.39
6	4924.00	40.2 AV	54.0	-13.8	1.00 V	72	0.81	39.39
7	7386.00	55.4 PK	74.0	-18.6	1.00 V	257	8.93	46.47
8	7386.00	49.2 AV	54.0	-4.8	1.00 V	257	2.73	46.47

- REMARKS:**
1. Emission level (dBuV/m) = Raw Value (dBuV) + Correction Factor (dB/m).
  2. Correction Factor (dB/m) = Antenna Factor (dB/m) + Cable Factor (dB).
  3. The other emission levels were very low against the limit.
  4. Margin value = Emission level – Limit value.
  5. “ \* “: Fundamental frequency.



A D T

RESTRICTED BANDEDGE (802.11n (20MHz) MODE,CH1, HORIZONTAL )

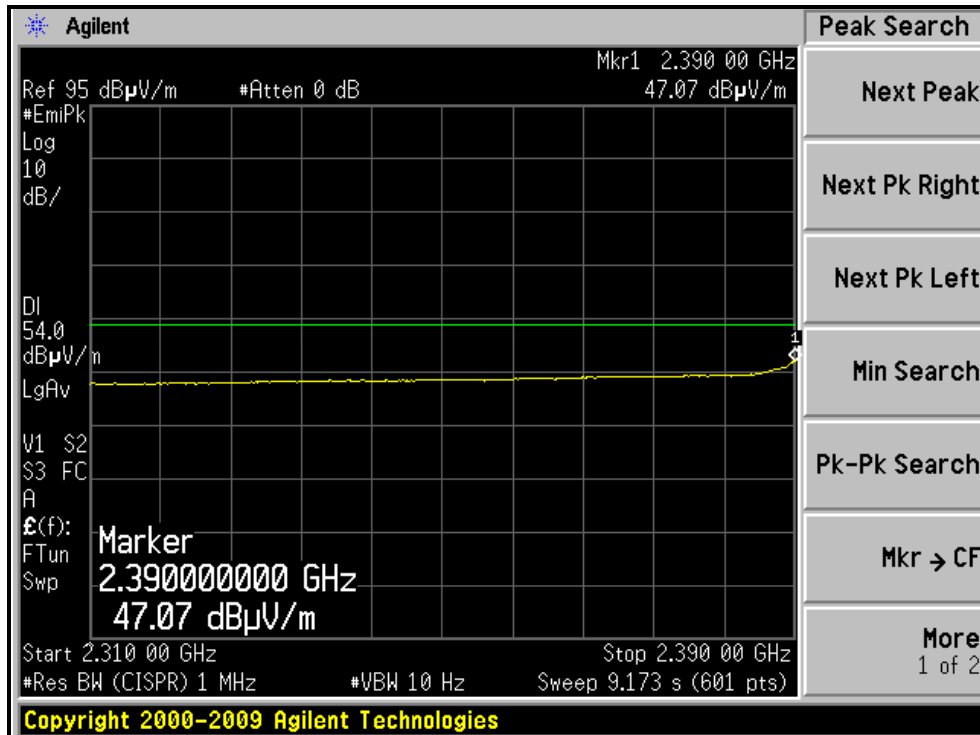
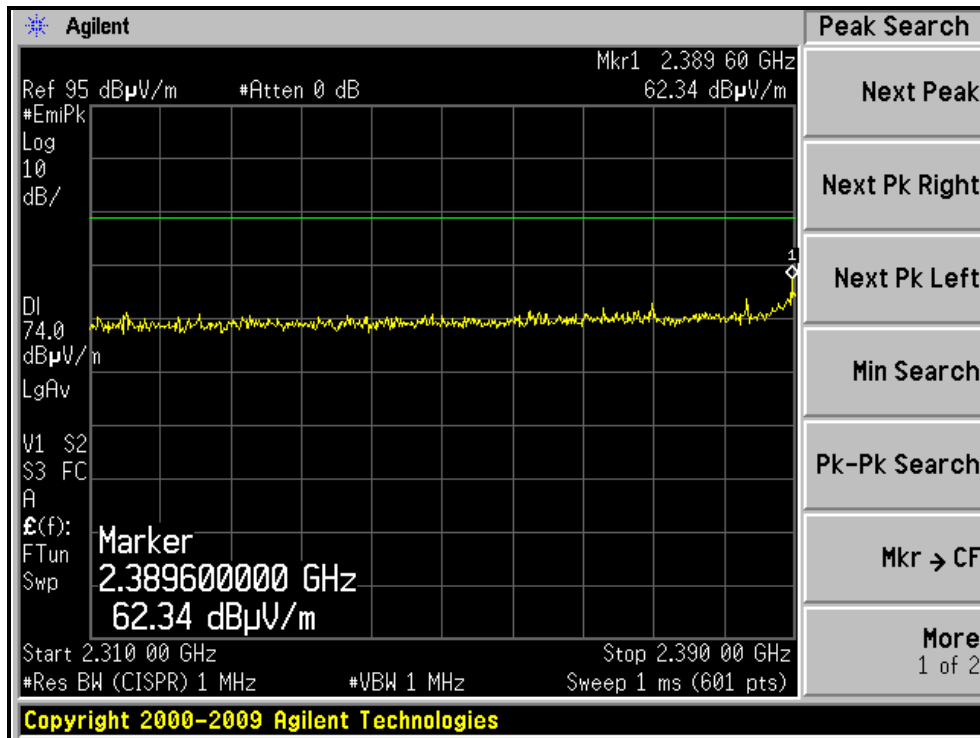



A D T

RESTRICTED BANDEDGE (802.11n (20MHz) MODE,CH1, VERTICAL )

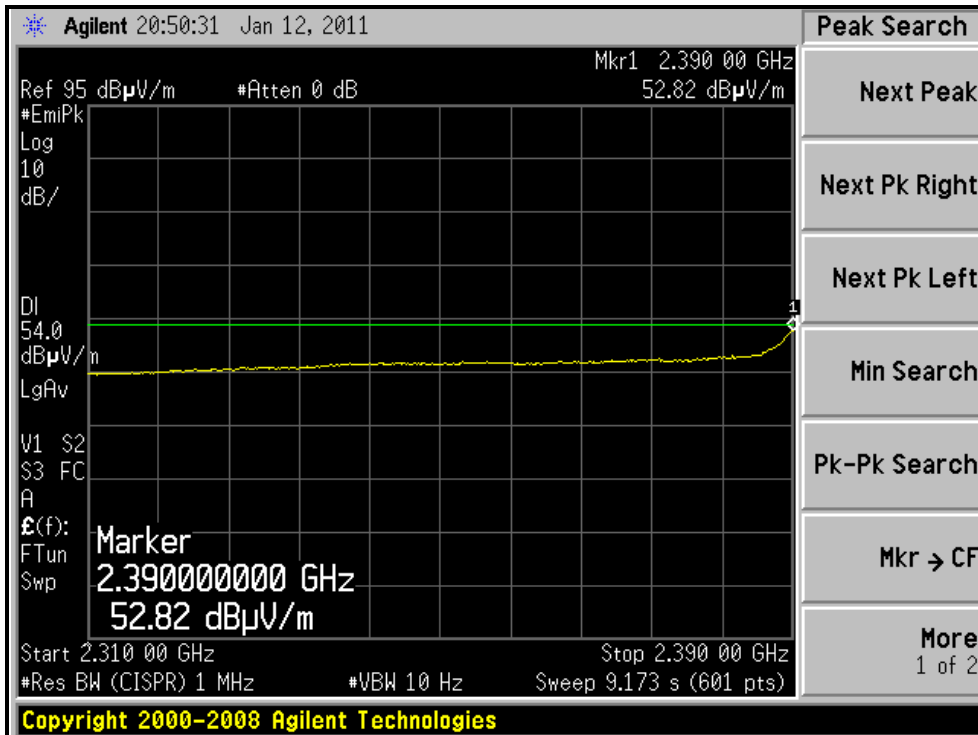
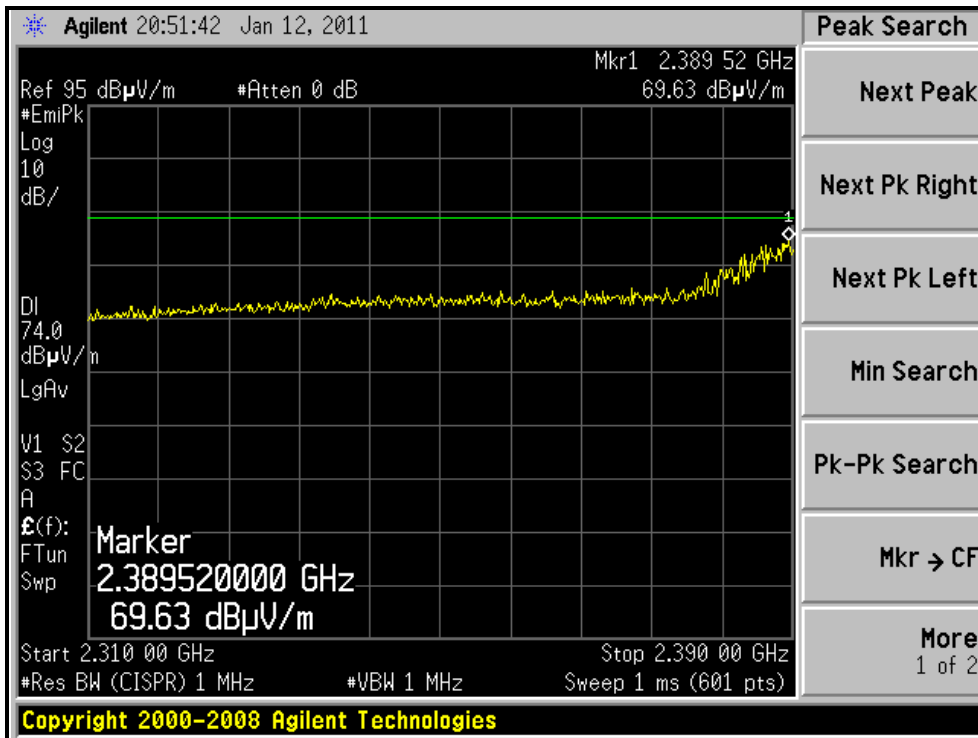



A D T

RESTRICTED BANDEDGE (802.11n (20MHz) MODE,CH11, HORIZONTAL )

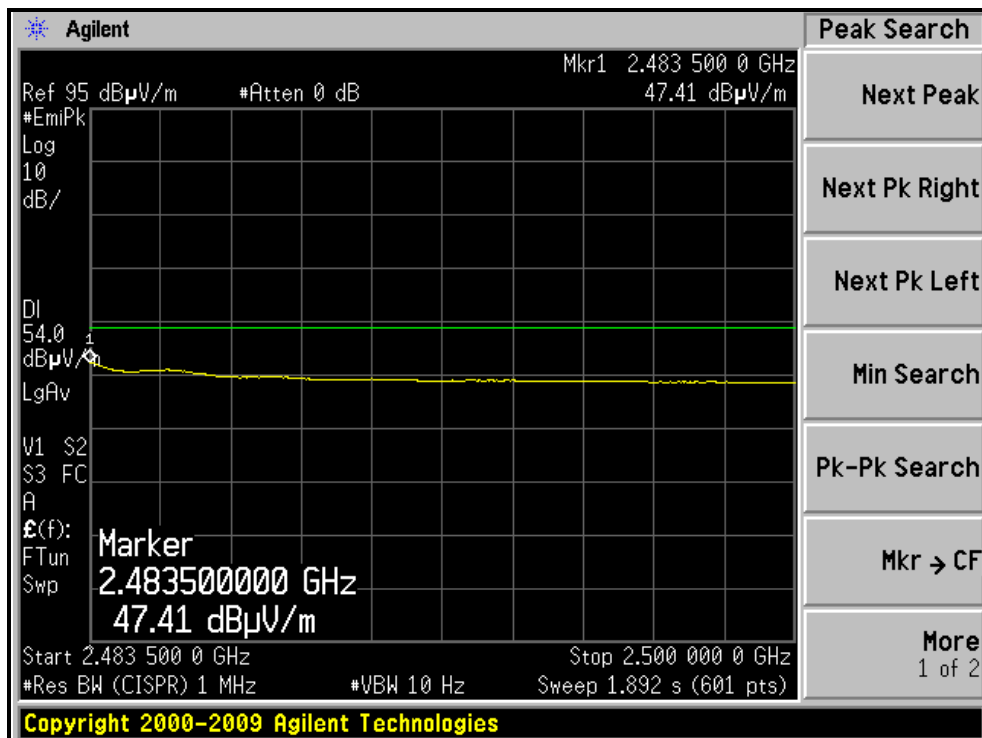
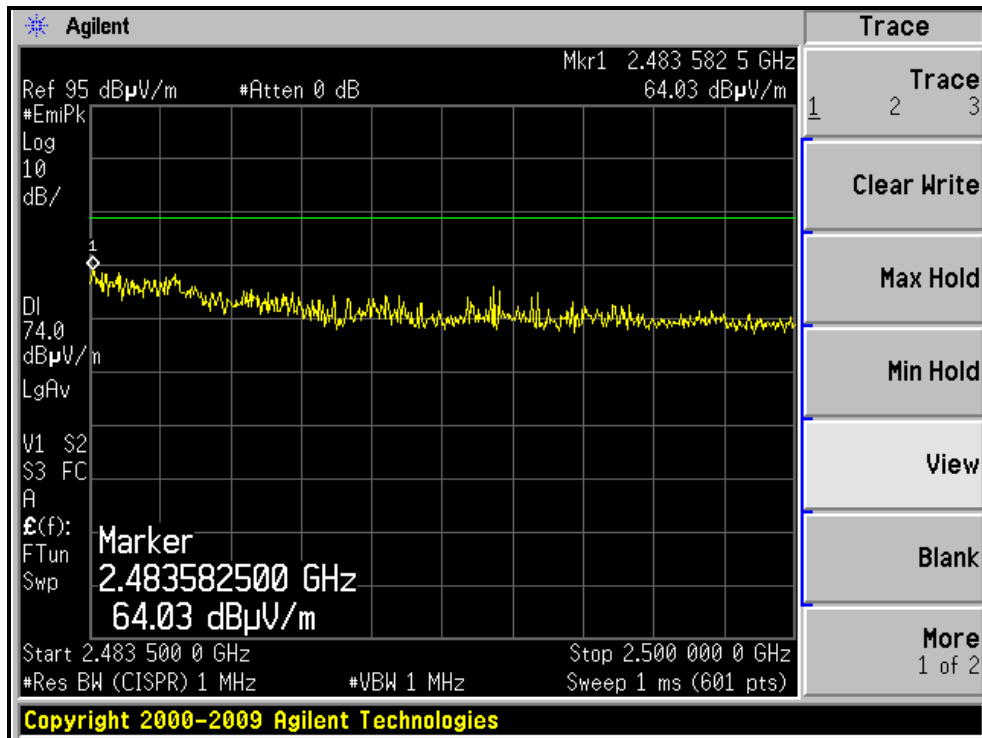



A D T

RESTRICTED BANDEDGE (802.11n (20MHz) MODE,CH11, VERTICAL )

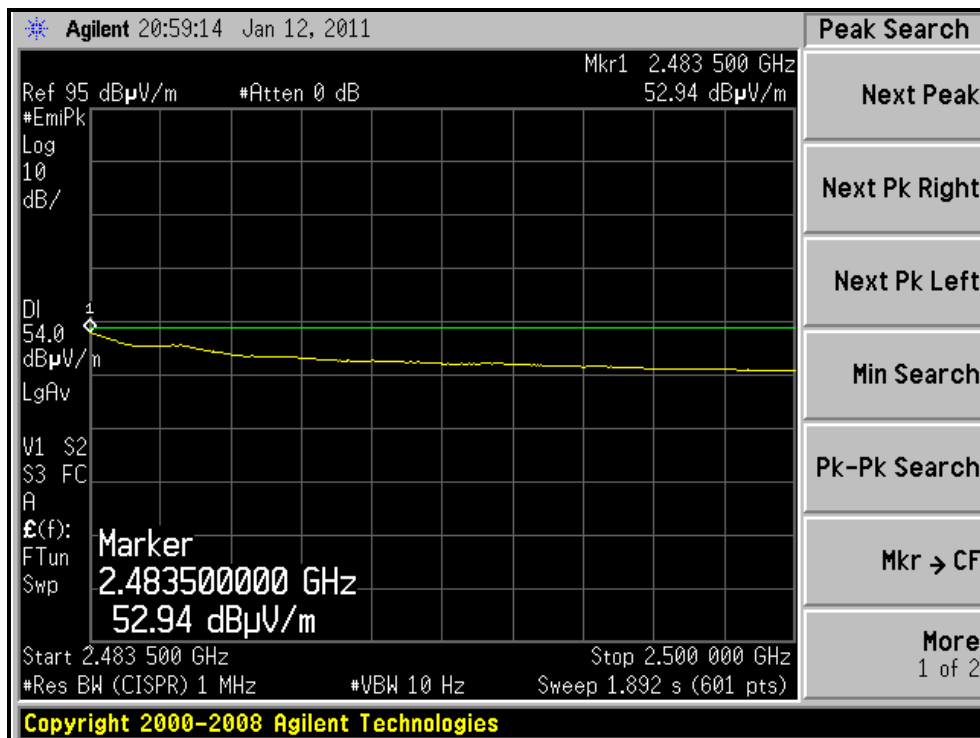
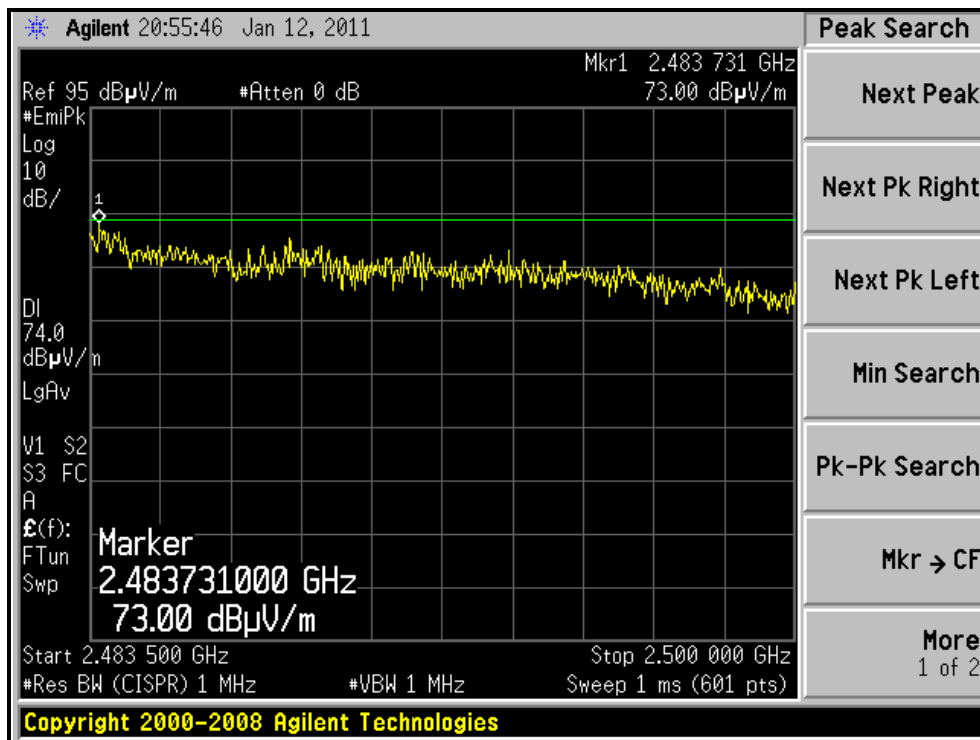

### 4.3 6dB BANDWIDTH MEASUREMENT

#### 4.3.1 LIMITS OF 6dB BANDWIDTH MEASUREMENT

The minimum of 6dB Bandwidth Measurement is 0.5 MHz.

#### 4.3.2 TEST INSTRUMENTS

DESCRIPTION & MANUFACTURER	MODEL NO.	SERIAL NO.	CALIBRATED DATE	CALIBRATED UNTIL
Spectrum Analyzer	FSP 40	100060	May 17, 2010	May 16, 2011

**NOTE:** The calibration interval of the above test instruments is 12 months and the calibrations are traceable to NML/ROC and NIST/USA.

#### 4.3.3 TEST PROCEDURE

The transmitter output was connected to the spectrum analyzer through an attenuator. The bandwidth of the fundamental frequency was measured by spectrum analyzer with 100kHz RBW and 100kHz VBW. The 6dB bandwidth is defined as the total spectrum the power of which is higher than peak power minus 6dB.

#### 4.3.4 DEVIATION FROM TEST STANDARD

No deviation

#### 4.3.5 TEST SETUP



#### 4.3.6 EUT OPERATING CONDITIONS

The software provided by client to enable the EUT under transmission condition continuously at lowest, middle and highest channel frequencies individually.

### 4.3.7 TEST RESULTS

#### 802.11b DSSS MODULATION:

CHANNEL	CHANNEL FREQUENCY (MHz)	6dB BANDWIDTH (MHz)	MINIMUM LIMIT (MHz)	PASS / FAIL
1	2412	7.80	0.5	PASS
6	2437	7.80	0.5	PASS
11	2462	7.79	0.5	PASS

#### CH6

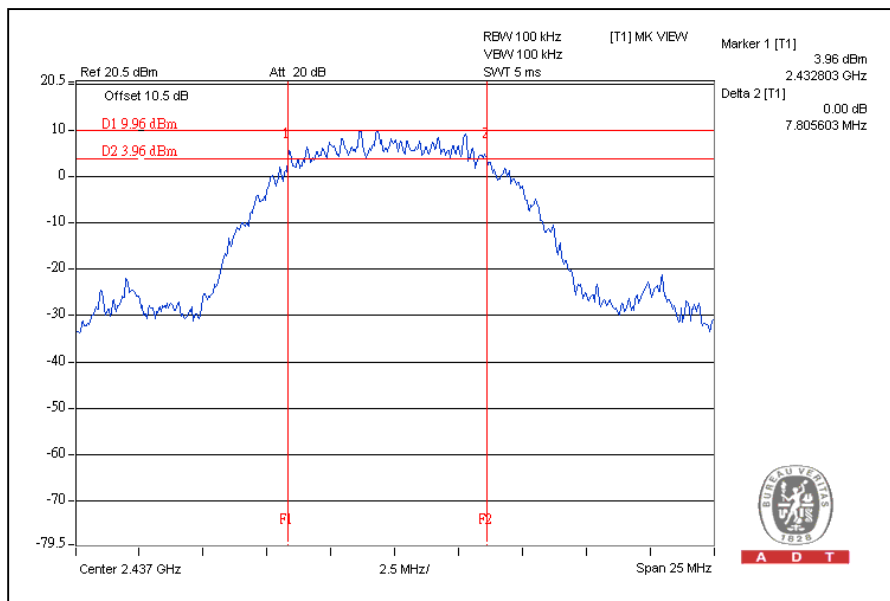



**802.11g OFDM MODULATION:**

CHANNEL	CHANNEL FREQUENCY (MHz)	6dB BANDWIDTH (MHz)	MINIMUM LIMIT (MHz)	PASS / FAIL
1	2412	15.05	0.5	PASS
6	2437	15.11	0.5	PASS
11	2462	14.22	0.5	PASS

**CH6**

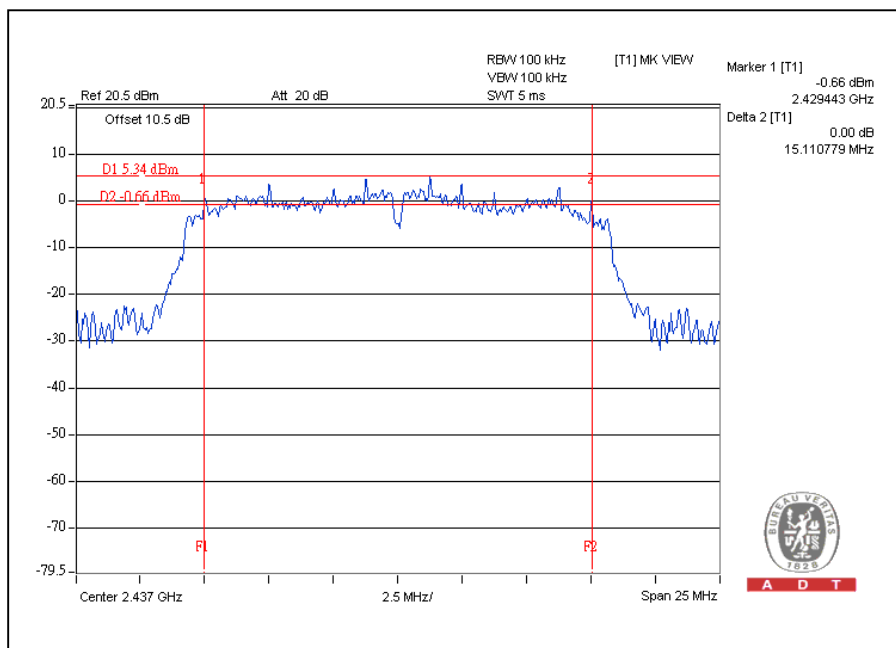



A D T

**802.11n (20MHz) OFDM MODULATION:**

CHANNEL	CHANNEL FREQUENCY (MHz)	6dB BANDWIDTH (MHz)	MINIMUM LIMIT (MHz)	PASS / FAIL
1	2412	15.12	0.5	PASS
6	2437	13.84	0.5	PASS
11	2462	14.04	0.5	PASS

CH1



#### 4.4 MAXIMUM PEAK OUTPUT POWER

##### 4.4.1 LIMITS OF MAXIMUM PEAK OUTPUT POWER MEASUREMENT

The Maximum Peak Output Power Measurement is 30dBm.

##### 4.4.2 INSTRUMENTS

DESCRIPTION & MANUFACTURER	MODEL NO.	SERIAL NO.	CALIBRATED DATE	CALIBRATED UNTIL
Peak Power Meter	ML2495A	0824006	May 04, 2010	May 03, 2011
Power Sensor	MA2411B	0738172	May 04, 2010	May 03, 2011

**NOTE:** The calibration interval of the above test instruments is 12 months and the calibrations are traceable to NML/ROC and NIST/USA.

##### 4.4.3 TEST PROCEDURES

1. The transmitter output was connected to the power meter through an attenuator; the bandwidth of the fundamental frequency was measured with the power meter.
2. Record the power level.

##### 4.4.4 DEVIATION FROM TEST STANDARD

No deviation

##### 4.4.5 TEST SETUP

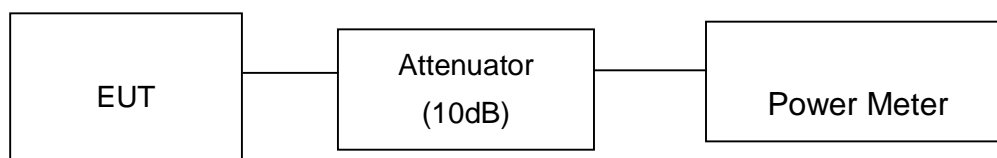

##### 4.4.6 EUT OPERATING CONDITIONS

Same as Item 4.3.6

#### 4.4.7 TEST RESULTS

##### 802.11b DSSS MODULATION:

CHANNEL	CHANNEL FREQUENCY (MHz)	PEAK POWER OUTPUT (mW)	PEAK POWER OUTPUT (dBm)	PEAK POWER LIMIT (dBm)	PASS / FAIL
1	2412	144.5	21.6	30	PASS
6	2437	162.2	22.1	30	PASS
11	2462	125.9	21.0	30	PASS

##### 802.11g OFDM MODULATION:

CHANNEL	CHANNEL FREQUENCY (MHz)	PEAK POWER OUTPUT (dBm)		TOTAL PEAK POWER (mW)	TOTAL PEAK POWER (dBm)	PEAK POWER LIMIT (dBm)	PASS / FAIL
		CHAIN(0)	CHAIN(1)				
1	2412	23.1	22.4	378.0	25.8	28.7	PASS
6	2437	25.3	24.3	608.0	27.8	28.7	PASS
11	2462	24.1	22.9	452.0	26.6	28.7	PASS

Directional gain =  $10 \log \left[ \left( 10^{G1/20} + 10^{G2/20} \right)^2 / 2 \right]$

Effective Legacy Gain (dBi) = 7.3

The effective legacy gain is 7.3dBi, therefore the limit needs to reduce.

##### 802.11n (20MHz) OFDM MODULATION:

CHANNEL	CHANNEL FREQUENCY (MHz)	PEAK POWER OUTPUT (dBm)		TOTAL PEAK POWER (mW)	TOTAL PEAK POWER (dBm)	PEAK POWER LIMIT (dBm)	PASS / FAIL
		CHAIN(0)	CHAIN(1)				
1	2412	17.0	20.3	157.3	22.0	30	PASS
6	2437	21.0	25.4	472.6	26.7	30	PASS
11	2462	18.9	23.7	312.0	24.9	30	PASS

## 4.5 POWER SPECTRAL DENSITY MEASUREMENT

### 4.5.1 LIMITS OF POWER SPECTRAL DENSITY MEASUREMENT

The Maximum of Power Spectral Density Measurement is 8dBm.

### 4.5.2 TEST INSTRUMENTS

DESCRIPTION & MANUFACTURER	MODEL NO.	SERIAL NO.	CALIBRATED DATE	CALIBRATED UNTIL
Spectrum Analyzer	FSP 40	100060	May 17, 2010	May 16, 2011

**NOTE:** The calibration interval of the above test instruments is 12 months and the calibrations are traceable to NML/ROC and NIST/USA.

### 4.5.3 TEST PROCEDURE

The transmitter output was connected to the spectrum analyzer through an attenuator, the bandwidth of the fundamental frequency was measured with the spectrum analyzer using 3kHz RBW and 30kHz VBW, set sweep time = span/3kHz. The power spectral density was measured and recorded.

The sweep time is allowed to be longer than span/3kHz for a full response of the mixer in the spectrum analyzer.

### 4.5.4 DEVIATION FROM TEST STANDARD

No deviation

### 4.5.5 TEST SETUP

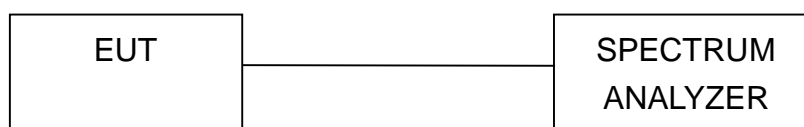

### 4.5.6 EUT OPERATING CONDITION

Same as Item 4.3.6



A D T

### 4.5.7 TEST RESULTS

#### 802.11b DSSS MODULATION:

CHANNEL	CHANNEL FREQUENCY (MHz )	RF POWER LEVEL IN 3kHz BW (dBm)	MAXIMUM LIMIT (dBm)	PASS / FAIL
1	2412	-4.5	8	PASS
6	2437	-4.7	8	PASS
11	2462	-4.5	8	PASS

CH1

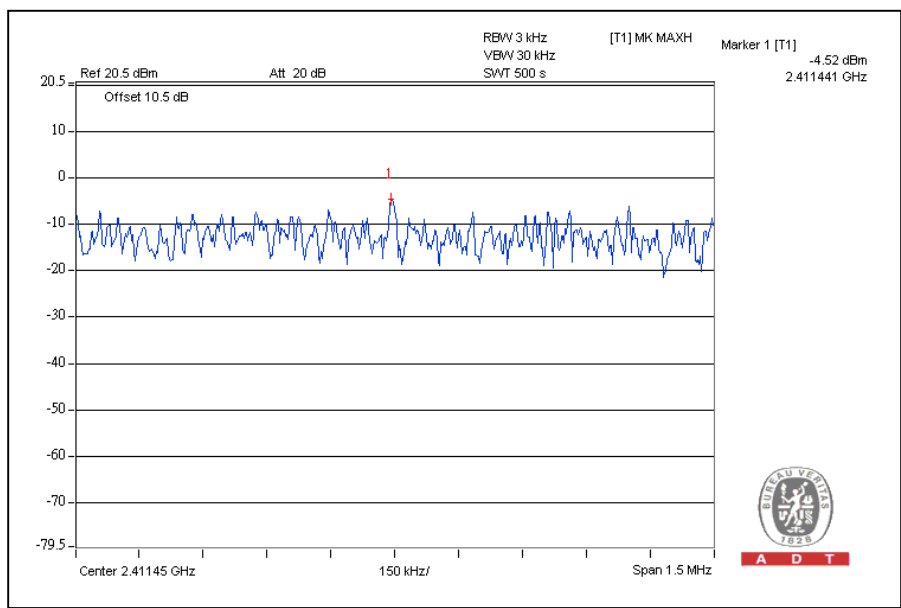

A D T



A D T

### 802.11g OFDM MODULATION:

CHANNEL	CHANNEL FREQUENCY (MHz)	RF POWER LEVEL IN 3kHz BW (dBm)		TOTAL POWER DENSITY (dBm)	MAXIMUM LIMIT (dBm)	PASS / FAIL
		CHAIN(0)	CHAIN(1)			
1	2412	-14.2	-14.3	-11.2	8	PASS
6	2437	-10.0	-10.5	-7.2	8	PASS
11	2462	-12.9	-12.0	-9.4	8	PASS

For Chain(0): CH6

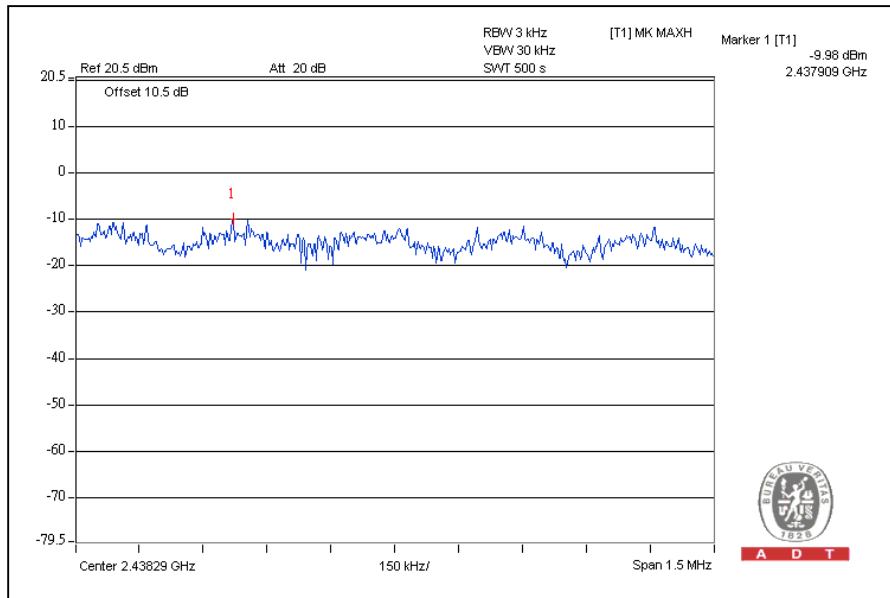

**802.11n (20MHz) OFDM MODULATION:**

CHANNEL	CHANNEL FREQUENCY (MHz)	RF POWER LEVEL IN 3kHz BW (dBm)		TOTAL POWER DENSITY (dBm)	MAXIMUM LIMIT (dBm)	PASS / FAIL
		CHAIN(0)	CHAIN(1)			
1	2412	-16.3	-16.0	-13.1	8	PASS
6	2437	-8.7	-8.8	-5.7	8	PASS
11	2462	-13.5	-12.3	-9.8	8	PASS

For Chain(0): CH6

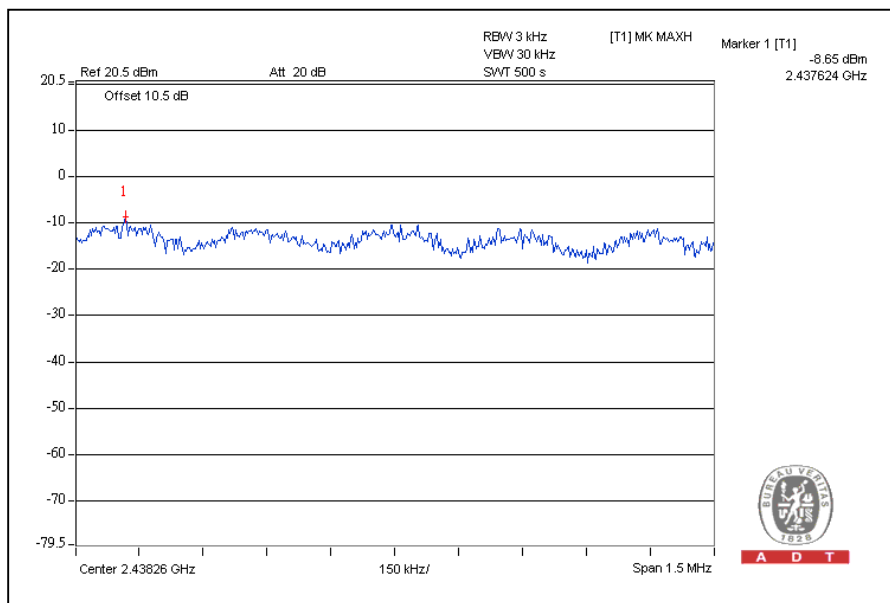



## 4.6 CONDUCTED OUT-BAND EMISSION MEASUREMENT

### 4.6.1 LIMITS OF CONDUCTED OUT-BAND EMISSION MEASUREMENT

Below  $-20\text{dB}$  of the highest emission level of operating band (in 100kHz Resolution Bandwidth).

### 4.6.2 TEST INSTRUMENTS

DESCRIPTION & MANUFACTURER	MODEL NO.	SERIAL NO.	CALIBRATED DATE	CALIBRATED UNTIL
Spectrum Analyzer	FSP 40	100060	May 17, 2010	May 16, 2011

**NOTE:** The calibration interval of the above test instruments is 12 months and the calibrations are traceable to NML/ROC and NIST/USA.

### 4.6.3 TEST PROCEDURE

The transmitter output was connected to the spectrum analyzer via a low loss cable. Set RBW of spectrum analyzer to 100kHz and VBW of spectrum analyzer to 300kHz with suitable frequency span including 100MHz or 200MHz bandwidth from band edge. The band edges was measured and recorded.

The spectrum plots (RBW = 100kHz, VBW = 300kHz) are attached on the following pages.

### 4.6.4 DEVIATION FROM TEST STANDARD

No deviation

### 4.6.5 EUT OPERATING CONDITION

Same as Item 4.3.6

### 4.6.6 TEST RESULTS

The spectrum plots are attached on the following images. D1 line indicates the highest level, and D2 line indicates the 20dB offset below D1. It shows compliance with the requirement in part 15.247(d).

### 802.11b DSSS MODULATION:

#### CH1

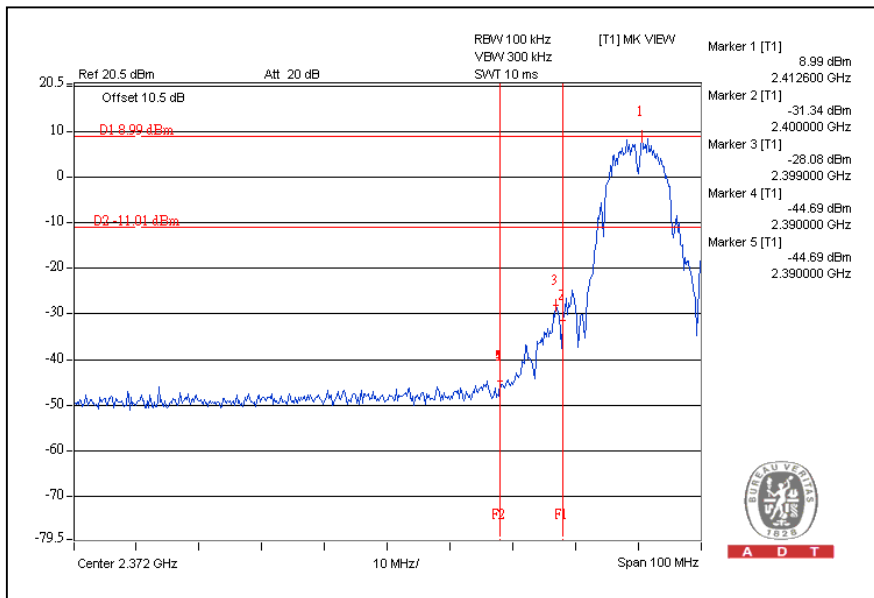

#### CH11

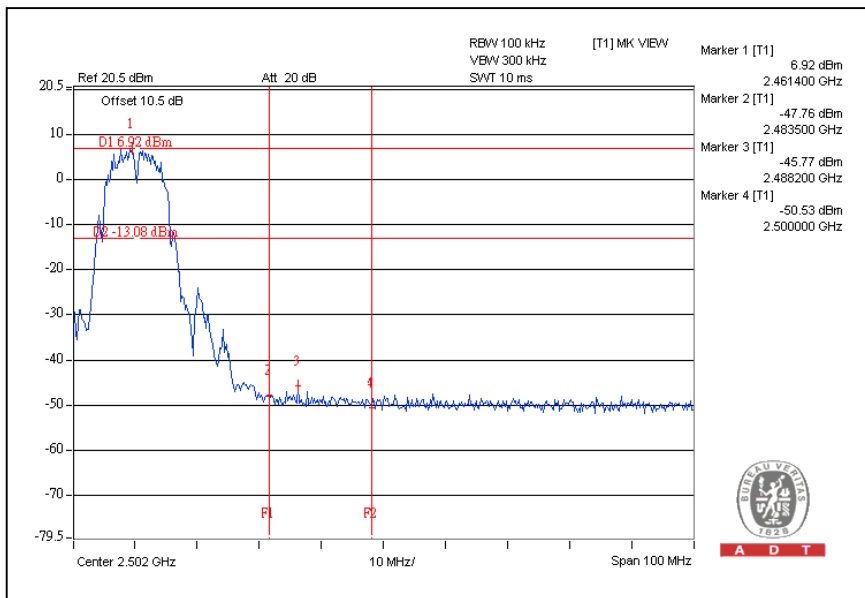



A D T

### CH1

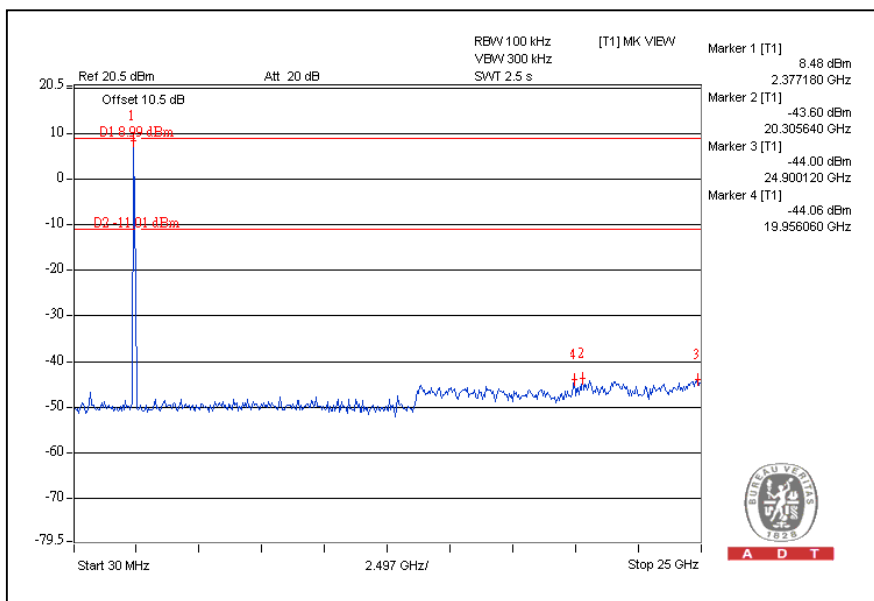

### CH11

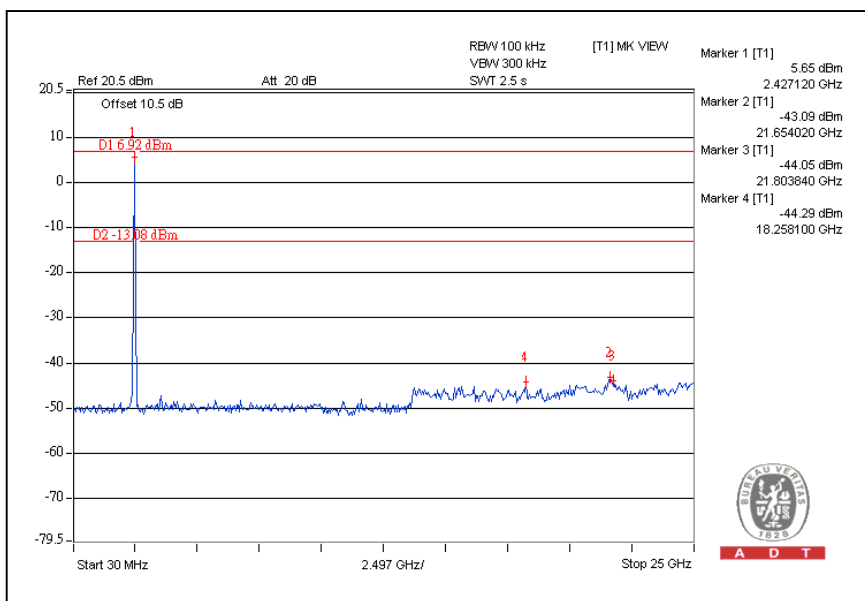



A D T

## 802.11g OFDM MODULATION:

### CH1

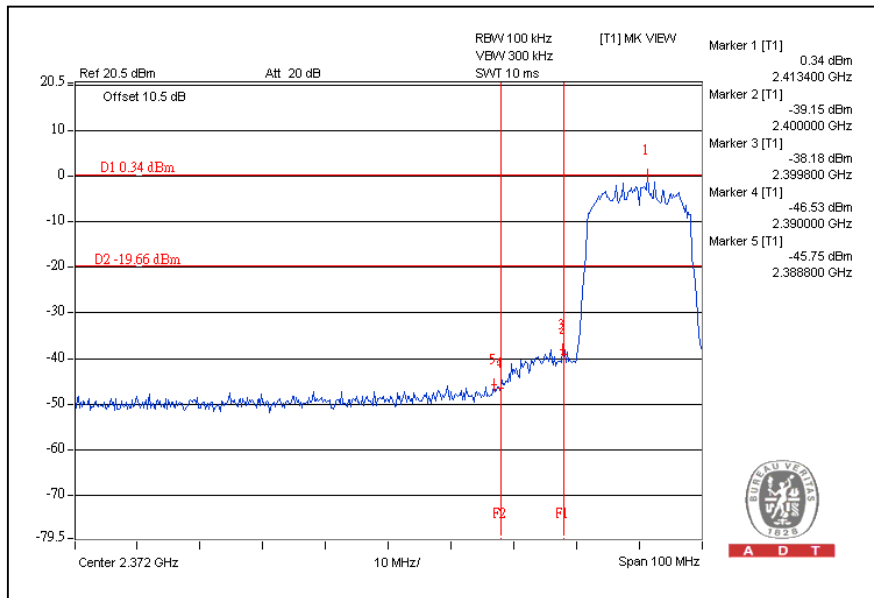

### CH11

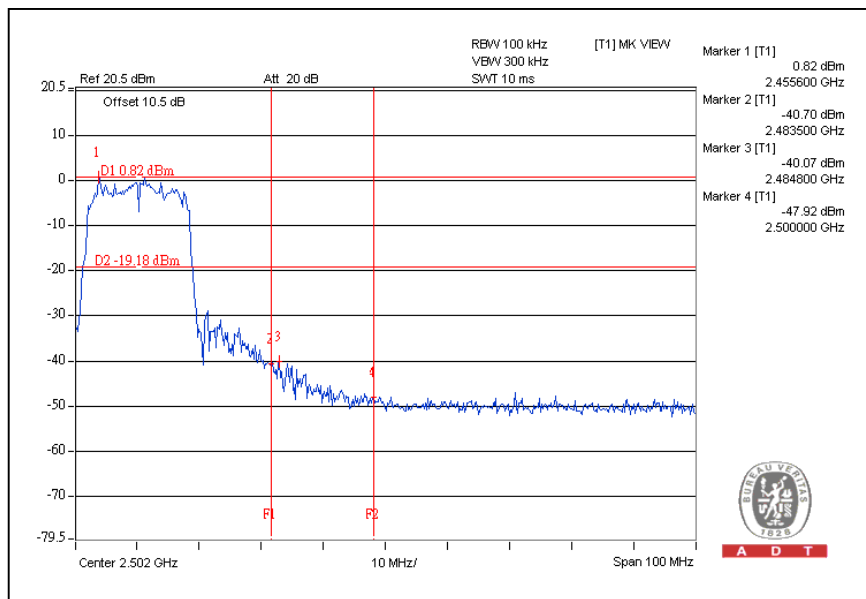



A D T

### CH1

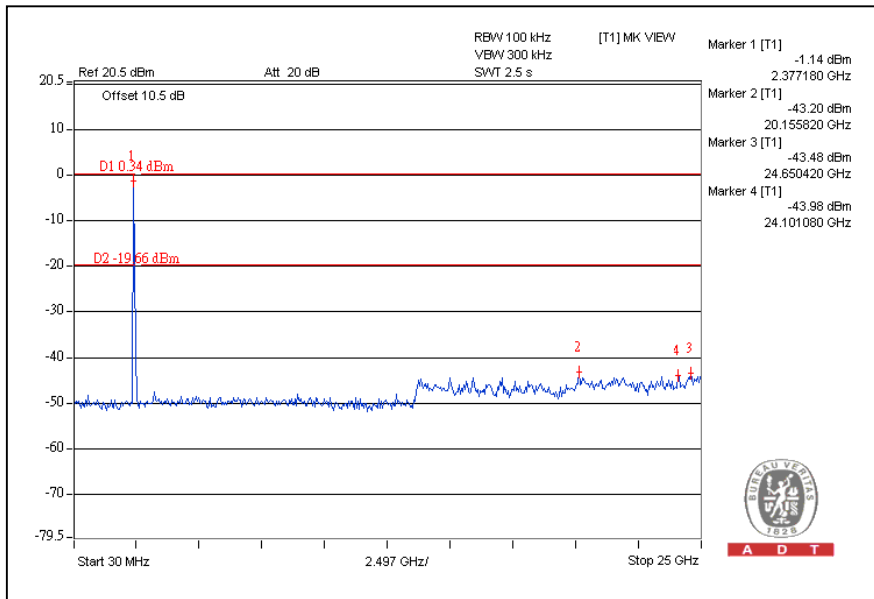

### CH11

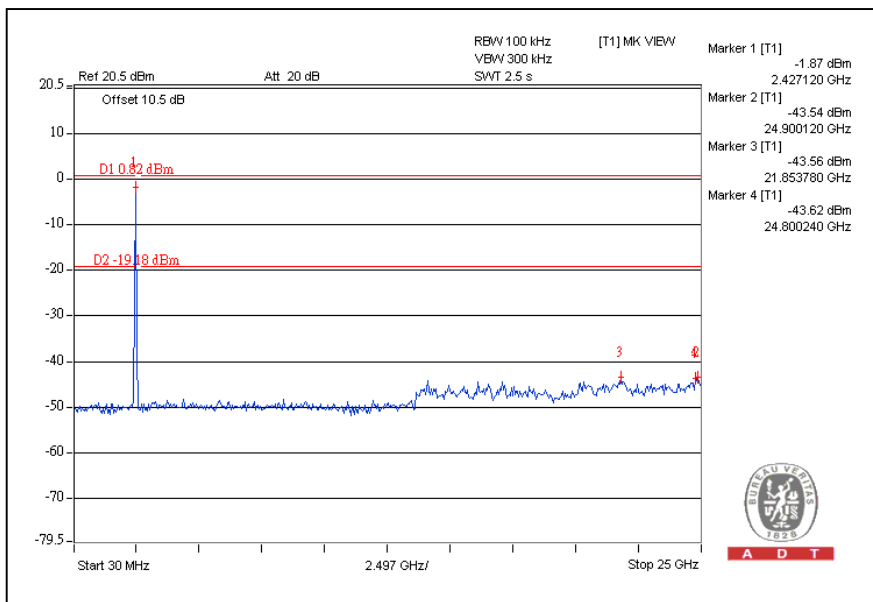

### 802.11n (20MHz) OFDM MODULATION:

#### CH1

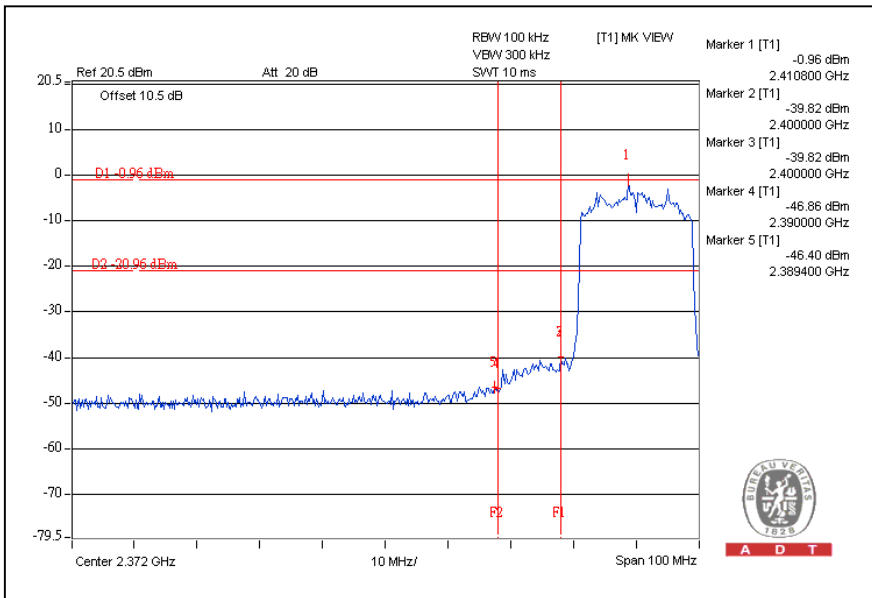

#### CH11

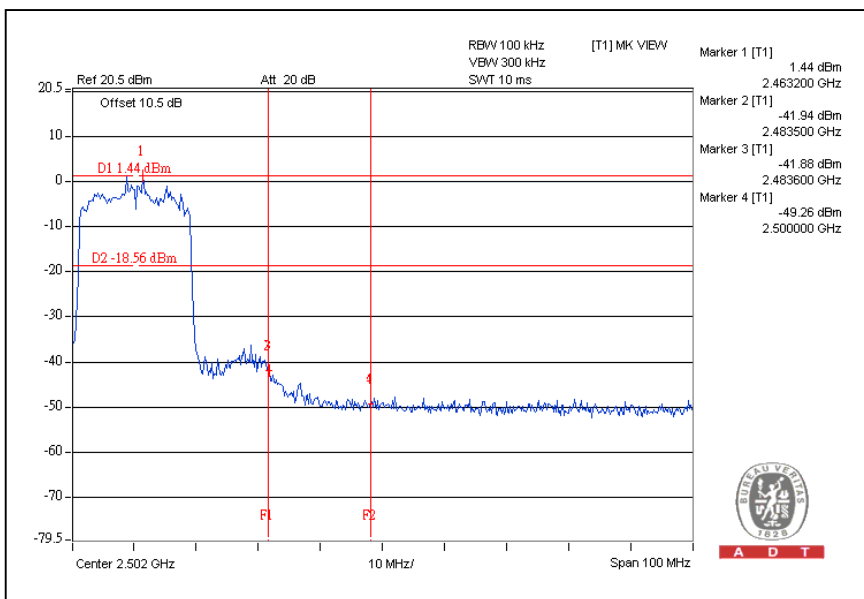



A D T

### CH1

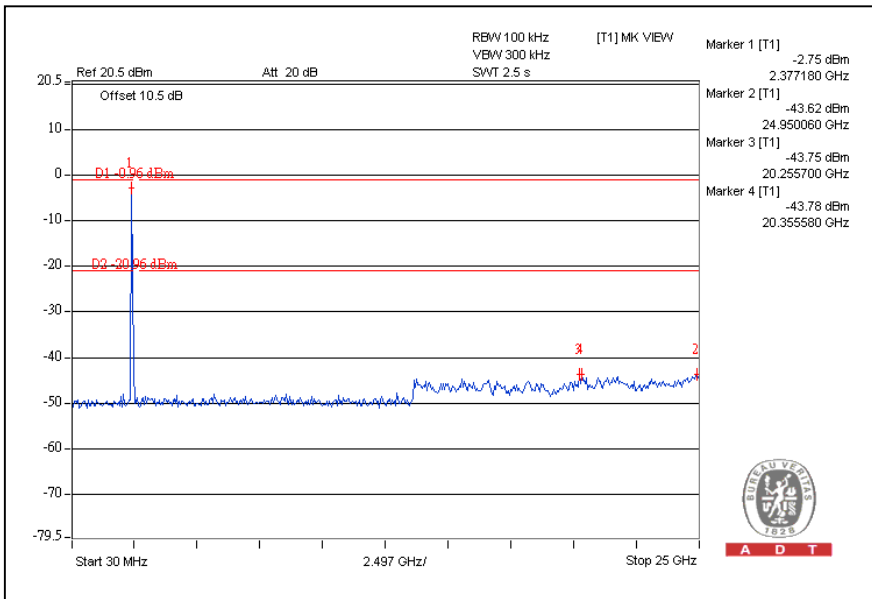

### CH11

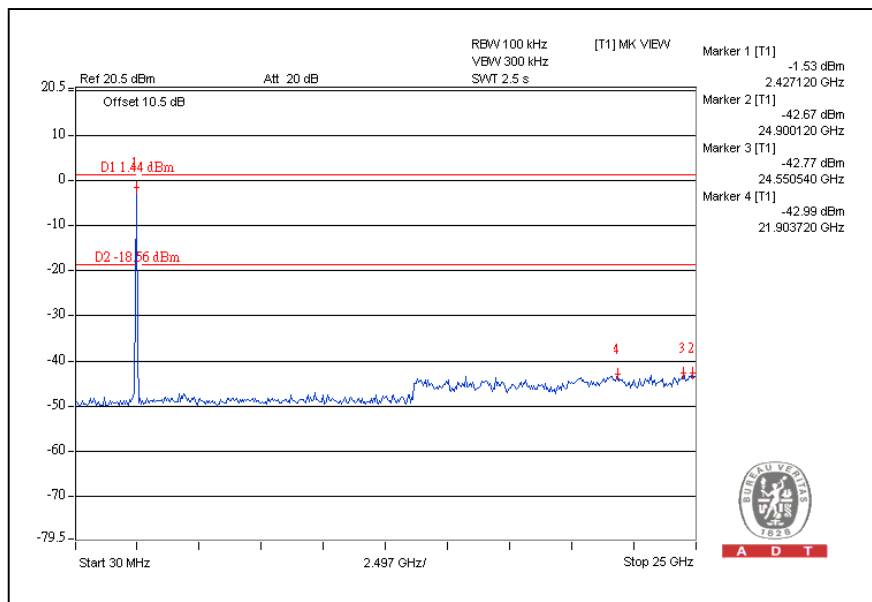

## 5. TEST TYPES AND RESULTS (802.11a, 5725~5850MHz Band)

### 5.1 CONDUCTED EMISSION MEASUREMENT

#### 5.1.1 LIMITS OF CONDUCTED EMISSION MEASUREMENT

FREQUENCY OF EMISSION (MHz)	CONDUCTED LIMIT (dB $\mu$ V)	
	Quasi-peak	Average
0.15-0.5	66 to 56	56 to 46
0.5-5	56	46
5-30	60	50

- NOTE:**
1. The lower limit shall apply at the transition frequencies.
  2. The limit decreases in line with the logarithm of the frequency in the range of 0.15 to 0.50 MHz.
  3. All emanations from a class A/B digital device or system, including any network of conductors and apparatus connected thereto, shall not exceed the level of field strengths specified above.

#### 5.1.2 TEST INSTRUMENTS

DESCRIPTION & MANUFACTURER	MODEL NO.	SERIAL NO.	CALIBRATED DATE	CALIBRATED UNTIL
ROHDE & SCHWARZ Test Receiver	ESCS 30	100287	Mar. 01, 2010	Feb. 28, 2011
Line-Impedance Stabilization Network (for EUT)	NSLK 8127	8127-523	Sep. 17, 2010	Sep. 16, 2011
Line-Impedance Stabilization Network (for Peripheral)	ENV-216	100072	June 11, 2010	June 10, 2011
50 ohms Terminator	50	3	Nov. 03, 2010	Nov. 02, 2011
Software	BV ADT_Cond_V7.3.7	NA	NA	NA

**Note:**

1. The calibration interval of the above test instruments is 12 months and the calibrations are traceable to NML/ROC and NIST/USA.
2. The test was performed in Shielded Room No. A.
3. The VCCI Con A Registration No. is C-817.





A D T

### 5.1.3 TEST PROCEDURES

- a. The EUT was placed 0.4 meters from the conducting wall of the shielded room with EUT being connected to the power mains through a line impedance stabilization network (LISN). Other support units were connected to the power mains through another LISN. The two LISNs provide 50 ohm/ 50uH of coupling impedance for the measuring instrument.
- b. Both lines of the power mains connected to the EUT were checked for maximum conducted interference.
- c. The frequency range from 150kHz to 30MHz was searched. Emission levels under (Limit – 20dB) were not recorded.

### 5.1.4 DEVIATION FROM TEST STANDARD

No deviation

### 5.1.5 TEST SETUP

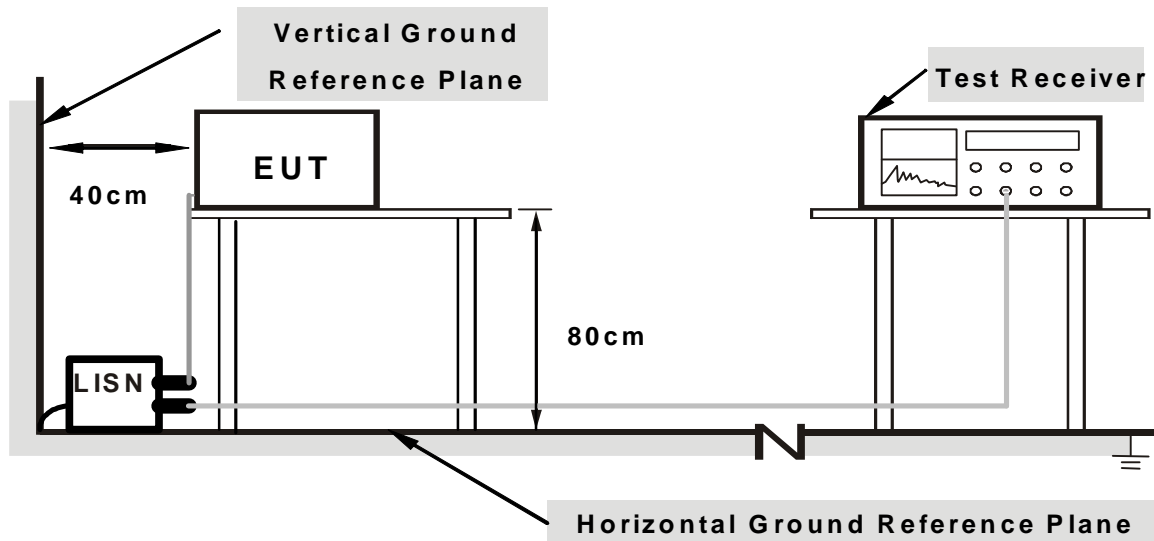

**Note: 1.Support units were connected to second LISN.**

**2.Both of LISNs (AMN) are 80 cm from EUT and at least 80 from other units and other metal planes**

For the actual test configuration, please refer to the related item – Photographs of the Test Configuration.

### 5.1.6 EUT OPERATING CONDITIONS

Same as the 4.1.6

### 5.1.7 TEST RESULTS (With adapter 1)

<b>PHASE</b>	Line (L)	<b>6dB BANDWIDTH</b>	9 kHz
--------------	----------	----------------------	-------

No	Freq.	Corr.	Reading Value		Emission Level		Limit		Margin	
	[MHz]	Factor	[dB (uV)]		[dB (uV)]		[dB (uV)]		(dB)	
		(dB)	Q.P.	AV.	Q.P.	AV.	Q.P.	AV.	Q.P.	AV.
1	0.185	0.36	43.56	-	43.92	-	64.24	54.24	-20.32	-
2	0.314	0.36	44.25	-	44.61	-	59.86	49.86	-15.25	-
3	0.388	0.36	46.89	-	47.25	-	58.11	48.11	-10.86	-
<b>4</b>	<b>0.775</b>	<b>0.39</b>	<b>45.98</b>	<b>38.46</b>	<b>46.37</b>	<b>38.85</b>	<b>56.00</b>	<b>46.00</b>	<b>-9.63</b>	<b>-7.15</b>
5	3.961	0.51	45.09	-	45.60	-	56.00	46.00	-10.40	-
6	18.305	1.03	38.88	-	39.91	-	60.00	50.00	-20.09	-

- REMARKS:**
1. Q.P. and AV. are abbreviations of quasi-peak and average individually.
  2. "-": The Quasi-peak reading value also meets average limit and measurement with the average detector is unnecessary.
  3. The emission levels of other frequencies were very low against the limit.
  4. Margin value = Emission level - Limit value
  5. Correction factor = Insertion loss + Cable loss
  6. Emission Level = Correction Factor + Reading Value.

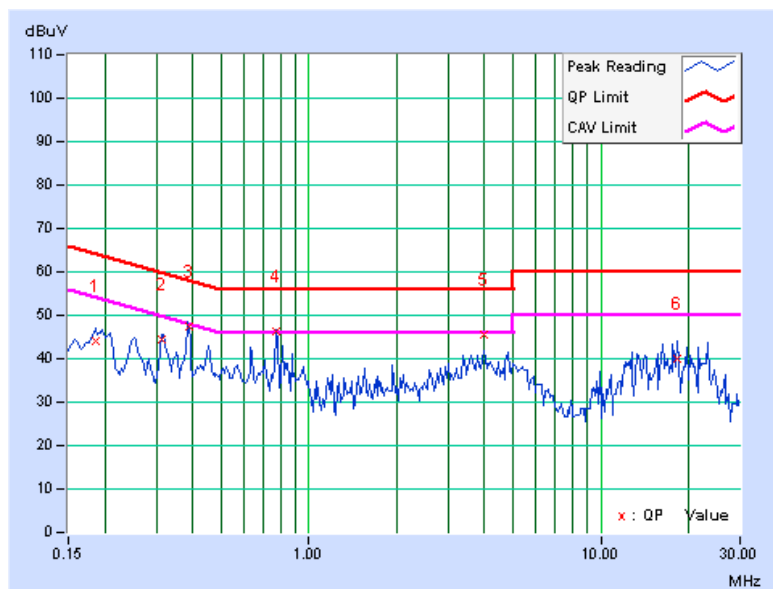

<b>PHASE</b>	Neutral (N)	<b>6dB BANDWIDTH</b>	9 kHz
--------------	-------------	----------------------	-------

No	Freq. [MHz]	Corr. Factor (dB)	Reading Value		Emission Level		Limit		Margin	
			[dB (uV)]		[dB (uV)]		[dB (uV)]		(dB)	
			Q.P.	AV.	Q.P.	AV.	Q.P.	AV.	Q.P.	AV.
1	0.177	0.10	39.67	-	39.77	-	64.61	54.61	-24.84	-
2	0.318	0.11	42.54	-	42.65	-	59.76	49.76	-17.11	-
3	0.388	0.11	43.86	-	43.97	-	58.10	48.10	-14.13	-
4	0.634	0.13	37.42	-	37.55	-	56.00	46.00	-18.45	-
5	0.775	0.14	42.15	-	42.29	-	56.00	46.00	-13.71	-
6	3.234	0.22	37.40	-	37.62	-	56.00	46.00	-18.38	-

- REMARKS:**
1. Q.P. and AV. are abbreviations of quasi-peak and average individually.
  2. "-": The Quasi-peak reading value also meets average limit and measurement with the average detector is unnecessary.
  3. The emission levels of other frequencies were very low against the limit.
  4. Margin value = Emission level - Limit value
  5. Correction factor = Insertion loss + Cable loss
  6. Emission Level = Correction Factor + Reading Value.

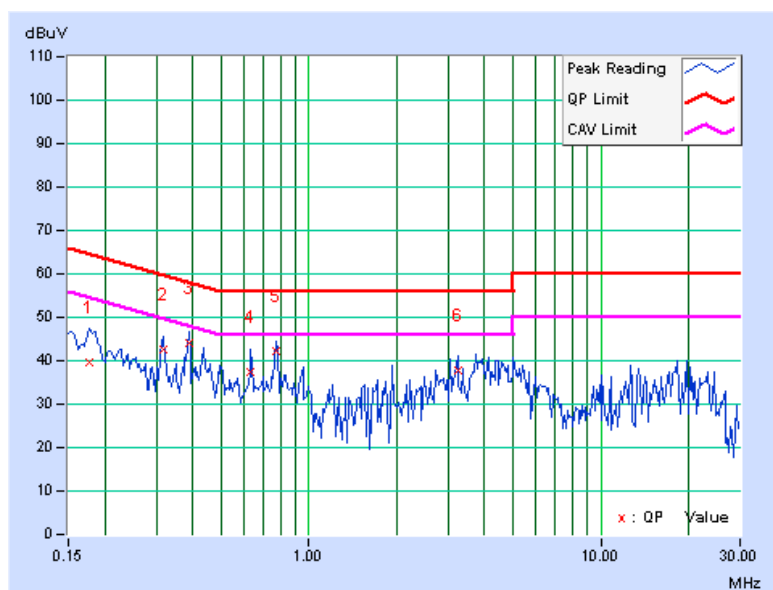

### 5.1.8 TEST RESULTS (With adapter 2)

PHASE	Line (L)	6dB BANDWIDTH	9 kHz
-------	----------	---------------	-------

No	Freq.	Corr.	Reading Value		Emission Level		Limit		Margin	
	[MHz]	Factor	[dB (uV)]		[dB (uV)]		[dB (uV)]		(dB)	
		(dB)	Q.P.	AV.	Q.P.	AV.	Q.P.	AV.	Q.P.	AV.
1	0.155	0.36	42.51	-	42.87	-	65.75	55.75	-22.88	-
2	0.314	0.36	44.20	-	44.56	-	59.86	49.86	-15.30	-
3	0.775	0.39	33.86	-	34.25	-	56.00	46.00	-21.75	-
4	11.949	0.81	33.95	-	34.76	-	60.00	50.00	-25.24	-
5	18.305	1.03	38.95	-	39.98	-	60.00	50.00	-20.02	-
6	26.485	1.39	35.84	-	37.23	-	60.00	50.00	-22.77	-

- REMARKS:**
1. Q.P. and AV. are abbreviations of quasi-peak and average individually.
  2. "-": The Quasi-peak reading value also meets average limit and measurement with the average detector is unnecessary.
  3. The emission levels of other frequencies were very low against the limit.
  4. Margin value = Emission level - Limit value
  5. Correction factor = Insertion loss + Cable loss
  6. Emission Level = Correction Factor + Reading Value.

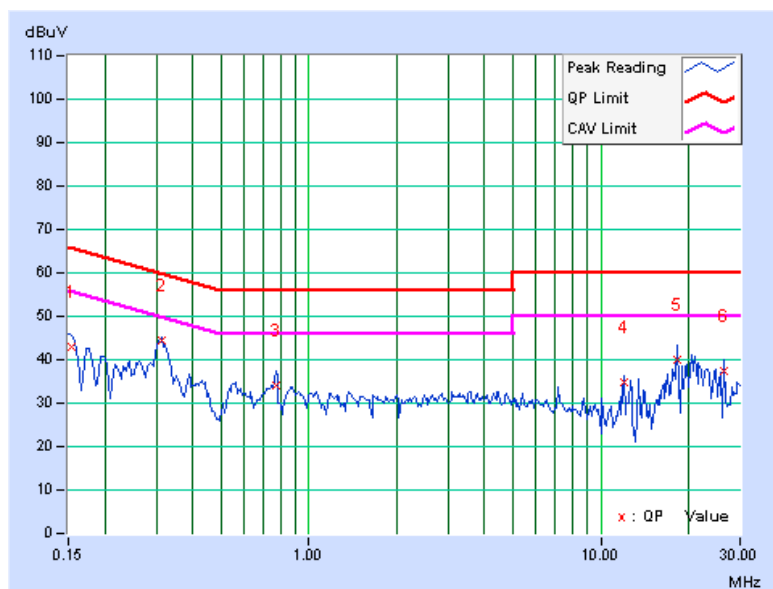

<b>PHASE</b>	Neutral (N)	<b>6dB BANDWIDTH</b>	9 kHz
--------------	-------------	----------------------	-------

No	Freq. [MHz]	Corr. Factor (dB)	Reading Value [dB (uV)]		Emission Level [dB (uV)]		Limit [dB (uV)]		Margin (dB)	
			Q.P.	AV.	Q.P.	AV.	Q.P.	AV.	Q.P.	AV.
			1	0.150	0.10	40.21	-	40.31	-	66.00
2	0.310	0.11	39.84	-	39.95	-	59.96	49.96	-20.02	-
3	0.775	0.14	32.54	-	32.68	-	56.00	46.00	-23.32	-
4	18.242	1.06	39.25	-	40.31	-	60.00	50.00	-19.69	-
5	19.586	1.11	36.23	-	37.34	-	60.00	50.00	-22.66	-
6	23.133	1.40	35.48	-	36.88	-	60.00	50.00	-23.12	-

- REMARKS:**
1. Q.P. and AV. are abbreviations of quasi-peak and average individually.
  2. "-": The Quasi-peak reading value also meets average limit and measurement with the average detector is unnecessary.
  3. The emission levels of other frequencies were very low against the limit.
  4. Margin value = Emission level - Limit value
  5. Correction factor = Insertion loss + Cable loss
  6. Emission Level = Correction Factor + Reading Value.

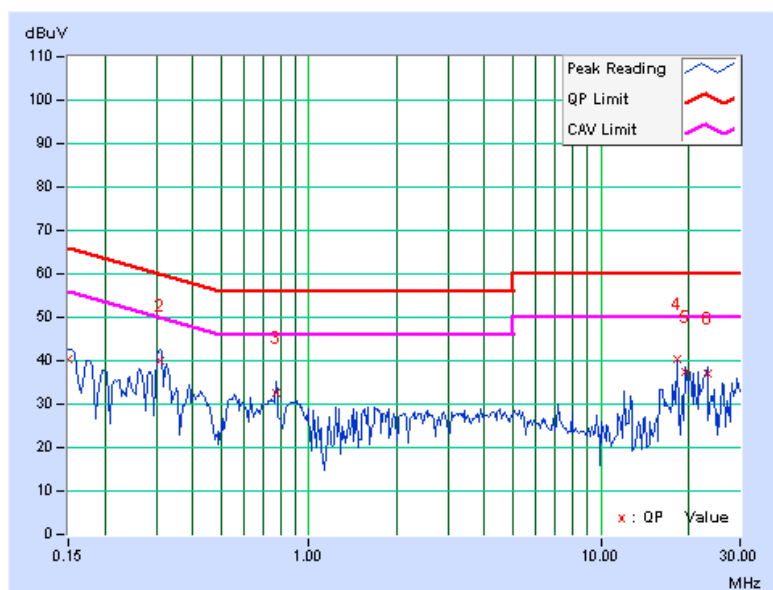

## 5.2 RADIATED EMISSION MEASUREMENT

### 5.2.1 LIMITS OF RADIATED EMISSION MEASUREMENT

Emissions radiated outside of the specified bands, shall be according to the general radiated limits in 15.209 as following:

Frequencies (MHz)	Field strength (microvolts/meter)	Measurement distance (meters)
0.009-0.490	2400/F(kHz)	300
0.490-1.705	24000/F(kHz)	30
1.705-30.0	30	30
30-88	100	3
88-216	150	3
216-960	200	3
Above 960	500	3

**NOTE:**

1. The lower limit shall apply at the transition frequencies.
2. Emission level (dBuV/m) = 20 log Emission level (uV/m).
3. As shown in 15.35(b), for frequencies above 1000MHz, the field strength limits are based on average detector, however, the peak field strength of any emission shall not exceed the maximum permitted average limits, specified above by more than 20dB under any condition of modulation.
4. Section 15.205 restricted bands of operation shall compliance with the limits in Section 15.209.



A D T

## 5.2.2 TEST INSTRUMENTS

### Below 1GHz test:

DESCRIPTION & MANUFACTURER	MODEL NO.	SERIAL NO.	CALIBRATED DATE	CALIBRATED UNTIL
Agilent Spectrum Analyzer	E4446A	MY48250253	Aug. 23, 2010	Aug. 22, 2011
Agilent Pre-Selector	N9039A	MY46520310	Aug. 23, 2010	Aug. 22, 2011
Agilent Signal Generator	N5181A	MY49060347	July 30, 2010	July 29, 2011
LIG NEX1 Test Receiver	ER-265	L09068005	Oct. 25, 2010	Oct. 24, 2011
Mini-Circuits Pre-Amplifier	ZFL-1000VH2B	AMP-ZFL-04	Nov. 16, 2010	Nov. 15, 2011
Agilent Pre-Amplifier	8449B	3008A02465	Feb. 28, 2011	Feb. 27, 2012
Miteq Pre-Amplifier	AFS33-1800265 0-30-8P-44	881786	NA	NA
SCHWARZBECK Trilog Broadband Antenna	VULB 9168	9168-361	Apr. 14, 2011	Apr. 13, 2012
AISI Horn_Antenna	AIH.8018	0000220091110	Nov. 22, 2010	Nov. 21, 2011
SCHWARZBECK Horn_Antenna	BBHA 9170	9170-424	Oct. 08, 2010	Oct. 07, 2011
RF CABLE	NA	RF104-205 RF104-207 RF104-202	Dec. 28, 2010	Dec. 27, 2011
RF Cable	NA	CHHCAB_001	NA	NA
Software	ADT_Radiated_V8.7.05	NA	NA	NA
CT Antenna Tower & Turn Table	NA	NA	NA	NA

- Note: 1. The calibration interval of the above test instruments is 12 months and the calibrations are traceable to NML/ROC and NIST/USA.  
2. The horn antenna, preamplifier (model: 8449B) are used only for the measurement of emission frequency above 1GHz if tested.  
3. The test was performed in 966 Chamber No. H.  
4. The FCC Site Registration No. is 797305.  
5. The CANADA Site Registration No. is IC 7450H-3.





A D T

**Above 1GHz test:**

DESCRIPTION & MANUFACTURER	MODEL NO.	SERIAL NO.	CALIBRATED DATE	CALIBRATED UNTIL
Agilent Spectrum Analyzer	E4446A	MY48250254	July 14, 2010	July 13, 2011
Agilent Pre-Selector	N9039A	MY46520311	July 14, 2010	July 13, 2011
Agilent Signal Generator	N5181A	MY49060517	July 14, 2010	July 13, 2011
Mini-Circuits Pre-Amplifier	ZFL-1000VH2B	AMP-ZFL-03	Nov. 16, 2010	Nov. 15, 2011
Agilent Pre-Amplifier	8449B	3008A02578	July 05, 2010	July 04, 2011
Miteq Pre-Amplifier	AFS33-1800265 0-30-8P-44	881786	NA	NA
SCHWARZBECK Trilog Broadband Antenna	VULB 9168	9168-360	Apr. 29, 2010	Apr. 28, 2011
AISI Horn_Antenna	AIH.8018	0000320091110	Nov. 12, 2010	Nov. 11, 2011
SCHWARZBECK Horn_Antenna	BBHA 9170	9170-424	Oct. 08, 2010	Oct. 07, 2011
RF CABLE	NA	RF104-201 RF104-203 RF104-204	Dec. 27, 2010	Dec. 26, 2011
RF Cable	NA	CHGCAB_001	NA	NA
Software	ADT_Radiated_V8.7.05	NA	NA	NA
CT Antenna Tower & Turn Table	NA	NA	NA	NA

Note: 1. The calibration interval of the above test instruments is 12 months and the calibrations are traceable to NML/ROC and NIST/USA.

2. The horn antenna, preamplifier (model: 8449B) are used only for the measurement of emission frequency above 1GHz if tested.
3. The test was performed in 966 Chamber No. G.
4. The FCC Site Registration No. is 966073.
5. The VCCI Site Registration No. is G-137.
6. The CANADA Site Registration No. is IC 7450H-2.

### 5.2.3 TEST PROCEDURES

- a. The EUT was placed on the top of a rotating table 0.8 meters above the ground at a 3 meter chamber room. The table was rotated 360 degrees to determine the position of the highest radiation.
- b. The EUT was set 3 meters away from the interference-receiving antenna, which was mounted on the top of a variable-height antenna tower.
- c. The height of antenna is varied from one meter to four meters above the ground to determine the maximum value of the field strength. Both horizontal and vertical polarizations of the antenna are set to make the measurement.
- d. For each suspected emission, the EUT was arranged to its worst case and then the antenna was tuned to heights from 1 meter to 4 meters and the rotatable table was turned from 0 degrees to 360 degrees to find the maximum reading.
- e. The test-receiver system was set to quasi-peak detect function and specified bandwidth with maximum hold mode when the test frequency is below 1 GHz.
- f. The test-receiver system was set to peak and average detect function and specified bandwidth with maximum hold mode when the test frequency is above 1 GHz. If the peak reading value also meets average limit, measurement with the average detector is unnecessary.

**NOTE:**

1. The resolution bandwidth and video bandwidth of test receiver/spectrum analyzer is 120kHz for Quasi-peak detection (QP) at frequency below 1GHz.
2. The resolution bandwidth of test receiver/spectrum analyzer is 1 MHz and the video bandwidth is 3 MHz for Peak detection (PK) at frequency above 1GHz.
3. The resolution bandwidth of test receiver/spectrum analyzer is 1 MHz and the video bandwidth is 10 Hz for Average detection (AV) at frequency above 1GHz.

### 5.2.4 DEVIATION FROM TEST STANDARD

No deviation

### 5.2.5 TEST SETUP

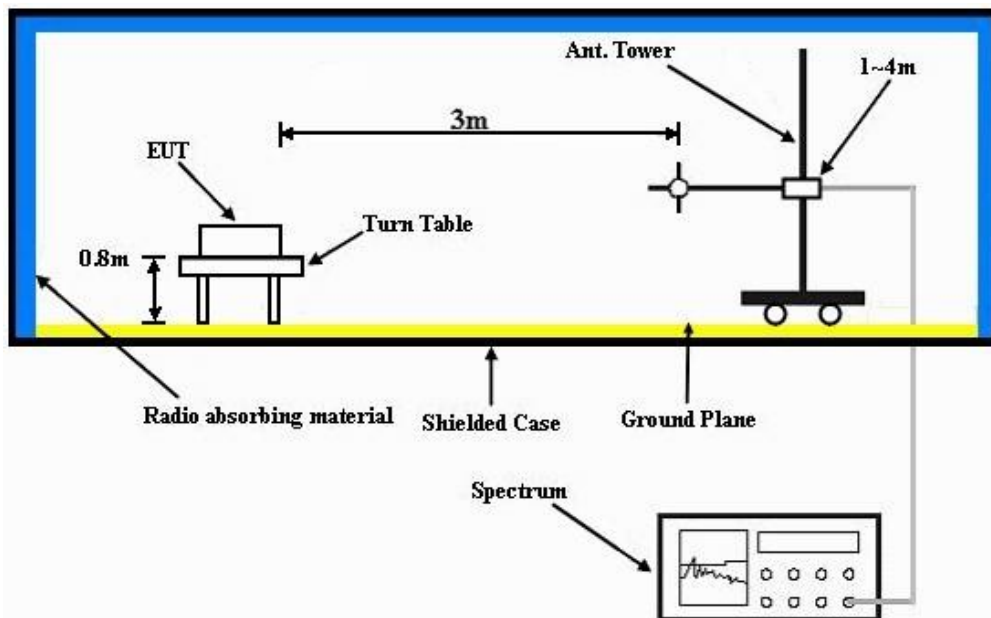

For the actual test configuration, please refer to the related item – Photographs of the Test Configuration.

### 5.2.6 EUT OPERATING CONDITIONS

Same as the 4.1.6

## 5.2.7 TEST RESULTS

### BELOW 1GHz WORST-CASE DATA : 802.11a OFDM MODULATION

EUT TEST CONDITION		MEASUREMENT DETAIL	
CHANNEL	Channel 149	FREQUENCY RANGE	Below 1000MHz
INPUT POWER	120Vac, 60 Hz	DETECTOR FUNCTION	Quasi-Peak
ENVIRONMENTAL CONDITIONS	22deg. C, 61%RH 1023 hPa	TESTED BY	Kent Liu

ANTENNA POLARITY & TEST DISTANCE: HORIZONTAL AT 3 M								
NO.	FREQ. (MHz)	EMISSION LEVEL (dBuV/m)	LIMIT (dBuV/m)	MARGIN (dB)	ANTENNA HEIGHT (m)	TABLE ANGLE (Degree)	RAW VALUE (dBuV)	CORRECTION FACTOR (dB/m)
1	108.72	27.4 QP	43.5	-16.1	1.25 H	225	16.74	10.65
2	151.00	31.3 QP	43.5	-12.3	1.25 H	228	16.77	14.48
3	189.70	30.3 QP	43.5	-13.3	1.75 H	255	18.26	11.99
4	250.01	30.2 QP	46.0	-15.8	1.25 H	136	17.18	13.04
5	530.00	31.7 QP	46.0	-14.4	1.25 H	25	11.47	20.18
6	940.65	28.5 QP	46.0	-17.5	2.00 H	227	2.28	26.26
ANTENNA POLARITY & TEST DISTANCE: VERTICAL AT 3 M								
NO.	FREQ. (MHz)	EMISSION LEVEL (dBuV/m)	LIMIT (dBuV/m)	MARGIN (dB)	ANTENNA HEIGHT (m)	TABLE ANGLE (Degree)	RAW VALUE (dBuV)	CORRECTION FACTOR (dB/m)
1	51.11	35.2 QP	40.0	-4.8	1.00 V	145	21.07	14.13
2	60.00	34.2 QP	40.0	-5.8	1.21 V	115	20.76	13.46
3	191.68	29.7 QP	43.5	-13.8	1.00 V	333	17.82	11.84
4	250.00	26.3 QP	46.0	-19.7	2.00 V	115	13.29	13.04
5	530.00	32.8 QP	46.0	-13.2	1.00 V	158	12.62	20.18
6	941.01	24.6 QP	46.0	-21.5	1.25 V	225	-1.71	26.26

- REMARKS:**
1. Emission level (dBuV/m) = Raw Value (dBuV) + Correction Factor (dB/m).
  2. Correction Factor (dB/m) = Antenna Factor (dB/m) + Cable Factor (dB).
  3. The other emission levels were very low against the limit.
  4. Margin value = Emission level – Limit value.



A D T

## ABOVE 1GHz DATA

## 802.11a OFDM MODULATION

EUT TEST CONDITION		MEASUREMENT DETAIL	
CHANNEL	Channel 149	FREQUENCY RANGE	1 ~ 40GHz
INPUT POWER	120Vac, 60 Hz	DETECTOR FUNCTION	Peak (PK) Average (AV)
ENVIRONMENTAL CONDITIONS	12deg. C, 64%RH 1023 hPa	TESTED BY	Frank Liu

ANTENNA POLARITY & TEST DISTANCE: HORIZONTAL AT 3 M								
NO.	FREQ. (MHz)	EMISSION LEVEL (dBuV/m)	LIMIT (dBuV/m)	MARGIN (dB)	ANTENNA HEIGHT (m)	TABLE ANGLE (Degree)	RAW VALUE (dBuV)	CORRECTION FACTOR (dB/m)
1	3830.00	54.3 PK	74.0	-19.7	1.27 H	85	18.86	35.44
2	3830.00	43.7 AV	54.0	-10.3	1.27 H	85	8.26	35.44
3	*5745.00	119.1 PK			1.52 H	88	77.40	41.70
4	*5745.00	107.8 AV			1.52 H	88	66.10	41.70
5	11490.00	64.2 PK	74.0	-9.8	1.10 H	142	16.48	47.72
6	11490.00	53.1 AV	54.0	-0.9	1.10 H	142	5.38	47.72
ANTENNA POLARITY & TEST DISTANCE: VERTICAL AT 3 M								
NO.	FREQ. (MHz)	EMISSION LEVEL (dBuV/m)	LIMIT (dBuV/m)	MARGIN (dB)	ANTENNA HEIGHT (m)	TABLE ANGLE (Degree)	RAW VALUE (dBuV)	CORRECTION FACTOR (dB/m)
1	3830.00	57.6 PK	74.0	-16.4	1.25 V	99	22.16	35.44
2	3830.00	49.8 AV	54.0	-4.2	1.25 V	99	14.36	35.44
3	*5745.00	118.4 PK			1.12 V	87	76.70	41.70
4	*5745.00	107.6 AV			1.12 V	87	65.90	41.70
5	11490.00	61.9 PK	74.0	-12.1	1.11 V	95	14.18	47.72
6	11490.00	49.8 AV	54.0	-4.2	1.11 V	95	2.08	47.72

- REMARKS:**
1. Emission level (dBuV/m) = Raw Value (dBuV) + Correction Factor (dB/m).
  2. Correction Factor (dB/m) = Antenna Factor (dB/m) + Cable Factor (dB).
  3. The other emission levels were very low against the limit.
  4. Margin value = Emission level – Limit value.
  5. “ \* “: Fundamental frequency.
  6. The limit value is defined as per 15.247.



A D T

EUT TEST CONDITION		MEASUREMENT DETAIL	
CHANNEL	Channel 157	FREQUENCY RANGE	1 ~ 40GHz
INPUT POWER	120Vac, 60 Hz	DETECTOR FUNCTION	Peak (PK) Average (AV)
ENVIRONMENTAL CONDITIONS	12deg. C, 64%RH 1023 hPa	TESTED BY	Frank Liu

ANTENNA POLARITY & TEST DISTANCE: HORIZONTAL AT 3 M								
NO.	FREQ. (MHz)	EMISSION LEVEL (dBuV/m)	LIMIT (dBuV/m)	MARGIN (dB)	ANTENNA HEIGHT (m)	TABLE ANGLE (Degree)	RAW VALUE (dBuV)	CORRECTION FACTOR (dB/m)
1	3856.60	55.2 PK	74.0	-18.8	1.28 H	87	19.65	35.55
2	<b>3856.60</b>	<b>53.4 AV</b>	<b>54.0</b>	<b>-0.6</b>	<b>1.28 H</b>	<b>87</b>	<b>17.85</b>	<b>35.55</b>
3	*5785.00	119.3 PK			1.53 H	88	77.48	41.82
4	*5785.00	107.9 AV			1.53 H	88	66.08	41.82
5	11570.00	64.1 PK	74.0	-9.9	1.07 H	149	16.33	47.77
6	11570.00	52.9 AV	54.0	-1.1	1.07 H	149	5.13	47.77
ANTENNA POLARITY & TEST DISTANCE: VERTICAL AT 3 M								
NO.	FREQ. (MHz)	EMISSION LEVEL (dBuV/m)	LIMIT (dBuV/m)	MARGIN (dB)	ANTENNA HEIGHT (m)	TABLE ANGLE (Degree)	RAW VALUE (dBuV)	CORRECTION FACTOR (dB/m)
1	3856.70	57.4 PK	74.0	-16.6	1.27 V	97	21.85	35.55
2	3856.70	49.6 AV	54.0	-4.4	1.27 V	97	14.05	35.55
3	*5785.00	117.9 PK			1.11 V	89	76.08	41.82
4	*5785.00	107.5 AV			1.11 V	89	65.68	41.82
5	11570.00	61.3 PK	74.0	-12.7	1.11 V	101	13.53	47.77
6	11570.00	49.1 AV	54.0	-4.9	1.11 V	101	1.33	47.77

- REMARKS:**
1. Emission level (dBuV/m) = Raw Value (dBuV) + Correction Factor (dB/m).
  2. Correction Factor (dB/m) = Antenna Factor (dB/m) + Cable Factor (dB).
  3. The other emission levels were very low against the limit.
  4. Margin value = Emission level – Limit value.
  5. “ \* “: Fundamental frequency.
  6. The limit value is defined as per 15.247.



A D T

EUT TEST CONDITION		MEASUREMENT DETAIL	
CHANNEL	Channel 165	FREQUENCY RANGE	1 ~ 40GHz
INPUT POWER	120Vac, 60 Hz	DETECTOR FUNCTION	Peak (PK) Average (AV)
ENVIRONMENTAL CONDITIONS	12deg. C, 64%RH 1023 hPa	TESTED BY	Frank Liu

ANTENNA POLARITY & TEST DISTANCE: HORIZONTAL AT 3 M								
NO.	FREQ. (MHz)	EMISSION LEVEL (dBuV/m)	LIMIT (dBuV/m)	MARGIN (dB)	ANTENNA HEIGHT (m)	TABLE ANGLE (Degree)	RAW VALUE (dBuV)	CORRECTION FACTOR (dB/m)
1	3883.30	55.1 PK	74.0	-18.9	1.29 H	84	19.43	35.67
2	<b>3883.30</b>	<b>53.4 AV</b>	<b>54.0</b>	<b>-0.6</b>	<b>1.29 H</b>	<b>84</b>	<b>17.73</b>	<b>35.67</b>
3	*5825.00	119.3 PK			1.53 H	88	77.38	41.92
4	*5825.00	108.4 AV			1.53 H	88	66.48	41.92
5	11650.00	63.5 PK	74.0	-10.5	1.14 H	103	15.61	47.89
6	11650.00	52.7 AV	54.0	-1.3	1.14 H	103	4.81	47.89
ANTENNA POLARITY & TEST DISTANCE: VERTICAL AT 3 M								
NO.	FREQ. (MHz)	EMISSION LEVEL (dBuV/m)	LIMIT (dBuV/m)	MARGIN (dB)	ANTENNA HEIGHT (m)	TABLE ANGLE (Degree)	RAW VALUE (dBuV)	CORRECTION FACTOR (dB/m)
1	3883.30	57.1 PK	74.0	-16.9	1.29 V	94	21.43	35.67
2	3883.30	48.9 AV	54.0	-5.1	1.29 V	94	13.23	35.67
3	*5825.00	118.8 PK			1.14 V	91	76.88	41.92
4	*5825.00	108.9 AV			1.14 V	91	66.98	41.92
5	11650.00	60.1 PK	74.0	-13.9	1.09 V	101	12.21	47.89
6	11650.00	48.6 AV	54.0	-5.4	1.09 V	101	0.71	47.89

- REMARKS:**
1. Emission level (dBuV/m) = Raw Value (dBuV) + Correction Factor (dB/m).
  2. Correction Factor (dB/m) = Antenna Factor (dB/m) + Cable Factor (dB).
  3. The other emission levels were very low against the limit.
  4. Margin value = Emission level – Limit value.
  5. “ \* “: Fundamental frequency.
  6. The limit value is defined as per 15.247.



A D T

## 802.11n (20MHz) OFDM MODULATION

EUT TEST CONDITION		MEASUREMENT DETAIL	
CHANNEL	Channel 149	FREQUENCY RANGE	1 ~ 40GHz
INPUT POWER	120Vac, 60 Hz	DETECTOR FUNCTION	Peak (PK) Average (AV)
ENVIRONMENTAL CONDITIONS	12deg. C, 64%RH 1023 hPa	TESTED BY	Frank Liu

ANTENNA POLARITY & TEST DISTANCE: HORIZONTAL AT 3 M								
NO.	FREQ. (MHz)	EMISSION LEVEL (dBuV/m)	LIMIT (dBuV/m)	MARGIN (dB)	ANTENNA HEIGHT (m)	TABLE ANGLE (Degree)	RAW VALUE (dBuV)	CORRECTION FACTOR (dB/m)
1	3830.00	54.7 PK	74.0	-19.3	1.29 H	89	19.26	35.44
2	3830.00	43.4 AV	54.0	-10.6	1.29 H	89	7.96	35.44
3	*5745.00	119.3 PK			1.52 H	89	77.60	41.70
4	*5745.00	107.7 AV			1.52 H	89	66.00	41.70
5	11490.00	62.1 PK	74.0	-11.9	1.27 H	155	14.38	47.72
6	11490.00	52.7 AV	54.0	-1.3	1.27 H	155	4.98	47.72
ANTENNA POLARITY & TEST DISTANCE: VERTICAL AT 3 M								
NO.	FREQ. (MHz)	EMISSION LEVEL (dBuV/m)	LIMIT (dBuV/m)	MARGIN (dB)	ANTENNA HEIGHT (m)	TABLE ANGLE (Degree)	RAW VALUE (dBuV)	CORRECTION FACTOR (dB/m)
1	3830.00	57.7 PK	74.0	-16.3	1.27 V	195	22.26	35.44
2	3830.00	50.2 AV	54.0	-3.8	1.27 V	195	14.76	35.44
3	*5745.00	117.2 PK			1.12 V	85	75.50	41.70
4	*5745.00	107.5 AV			1.12 V	85	65.80	41.70
5	11490.00	61.3 PK	74.0	-12.7	1.13 V	101	13.58	47.72
6	11490.00	50.7 AV	54.0	-3.3	1.13 V	101	2.98	47.72

- REMARKS:**
1. Emission level (dBuV/m) = Raw Value (dBuV) + Correction Factor (dB/m).
  2. Correction Factor (dB/m) = Antenna Factor (dB/m) + Cable Factor (dB).
  3. The other emission levels were very low against the limit.
  4. Margin value = Emission level – Limit value.
  5. “ \* “: Fundamental frequency.
  6. The limit value is defined as per 15.247.





A D T

EUT TEST CONDITION		MEASUREMENT DETAIL	
CHANNEL	Channel 157	FREQUENCY RANGE	1 ~ 40GHz
INPUT POWER	120Vac, 60 Hz	DETECTOR FUNCTION	Peak (PK) Average (AV)
ENVIRONMENTAL CONDITIONS	12deg. C, 64%RH 1023 hPa	TESTED BY	Frank Liu

ANTENNA POLARITY & TEST DISTANCE: HORIZONTAL AT 3 M								
NO.	FREQ. (MHz)	EMISSION LEVEL (dBuV/m)	LIMIT (dBuV/m)	MARGIN (dB)	ANTENNA HEIGHT (m)	TABLE ANGLE (Degree)	RAW VALUE (dBuV)	CORRECTION FACTOR (dB/m)
1	3856.60	55.1 PK	74.0	-18.9	1.27 H	84	19.55	35.55
2	3856.60	44.0 AV	54.0	-10.0	1.27 H	84	8.45	35.55
3	*5785.00	119.4 PK			1.52 H	88	77.58	41.82
4	*5785.00	107.6 AV			1.52 H	88	65.78	41.82
5	11570.00	61.7 PK	74.0	-12.3	1.09 H	147	13.93	47.77
6	11570.00	52.9 AV	54.0	-1.1	1.09 H	147	5.13	47.77
ANTENNA POLARITY & TEST DISTANCE: VERTICAL AT 3 M								
NO.	FREQ. (MHz)	EMISSION LEVEL (dBuV/m)	LIMIT (dBuV/m)	MARGIN (dB)	ANTENNA HEIGHT (m)	TABLE ANGLE (Degree)	RAW VALUE (dBuV)	CORRECTION FACTOR (dB/m)
1	3856.60	57.8 PK	74.0	-16.2	1.24 V	98	22.25	35.55
2	3856.60	49.8 AV	54.0	-4.2	1.24 V	98	14.25	35.55
3	*5785.00	117.4 PK			1.10 V	85	75.58	41.82
4	*5785.00	107.8 AV			1.10 V	85	65.98	41.82
5	11570.00	61.1 PK	74.0	-12.9	1.11 V	100	13.33	47.77
6	11570.00	48.9 AV	54.0	-5.1	1.11 V	100	1.13	47.77

- REMARKS:**
1. Emission level (dBuV/m) = Raw Value (dBuV) + Correction Factor (dB/m).
  2. Correction Factor (dB/m) = Antenna Factor (dB/m) + Cable Factor (dB).
  3. The other emission levels were very low against the limit.
  4. Margin value = Emission level – Limit value.
  5. “ \* “: Fundamental frequency.
  6. The limit value is defined as per 15.247.



A D T

EUT TEST CONDITION		MEASUREMENT DETAIL	
CHANNEL	Channel 165	FREQUENCY RANGE	1 ~ 40GHz
INPUT POWER	120Vac, 60 Hz	DETECTOR FUNCTION	Peak (PK) Average (AV)
ENVIRONMENTAL CONDITIONS	12deg. C, 64%RH 1023 hPa	TESTED BY	Frank Liu

ANTENNA POLARITY & TEST DISTANCE: HORIZONTAL AT 3 M								
NO.	FREQ. (MHz)	EMISSION LEVEL (dBuV/m)	LIMIT (dBuV/m)	MARGIN (dB)	ANTENNA HEIGHT (m)	TABLE ANGLE (Degree)	RAW VALUE (dBuV)	CORRECTION FACTOR (dB/m)
1	3883.30	55.4 PK	74.0	-18.6	1.25 H	86	19.73	35.67
2	3883.30	44.2 AV	54.0	-9.8	1.25 H	86	8.53	35.67
3	*5825.00	119.7 PK			1.53 H	89	77.78	41.92
4	*5825.00	108.0 AV			1.53 H	89	66.08	41.92
5	11650.00	62.1 PK	74.0	-11.9	1.10 H	146	14.21	47.89
6	11650.00	52.7 AV	54.0	-1.3	1.10 H	146	4.81	47.89
ANTENNA POLARITY & TEST DISTANCE: VERTICAL AT 3 M								
NO.	FREQ. (MHz)	EMISSION LEVEL (dBuV/m)	LIMIT (dBuV/m)	MARGIN (dB)	ANTENNA HEIGHT (m)	TABLE ANGLE (Degree)	RAW VALUE (dBuV)	CORRECTION FACTOR (dB/m)
1	3883.30	57.4 PK	74.0	-16.6	1.23 V	97	21.69	35.67
2	3883.30	49.1 AV	54.0	-4.9	1.23 V	97	13.43	35.67
3	*5825.00	117.3 PK			1.13 V	91	75.38	41.92
4	*5825.00	107.7 AV			1.13 V	91	65.78	41.92
5	11650.00	60.6 PK	74.0	-13.4	1.10 V	96	12.71	47.89
6	11650.00	48.7 AV	54.0	-5.3	1.10 V	96	0.81	47.89

- REMARKS:**
1. Emission level (dBuV/m) = Raw Value (dBuV) + Correction Factor (dB/m).
  2. Correction Factor (dB/m) = Antenna Factor (dB/m) + Cable Factor (dB).
  3. The other emission levels were very low against the limit.
  4. Margin value = Emission level – Limit value.
  5. “ \* “: Fundamental frequency.
  6. The limit value is defined as per 15.247.



A D T

**802.11n (40MHz) OFDM MODULATION**

EUT TEST CONDITION		MEASUREMENT DETAIL	
CHANNEL	Channel 151	FREQUENCY RANGE	1 ~ 40GHz
INPUT POWER	120Vac, 60 Hz	DETECTOR FUNCTION	Peak (PK) Average (AV)
ENVIRONMENTAL CONDITIONS	12deg. C, 64%RH 1023 hPa	TESTED BY	Frank Liu

**ANTENNA POLARITY & TEST DISTANCE: HORIZONTAL AT 3 M**

NO.	FREQ. (MHz)	EMISSION LEVEL (dBuV/m)	LIMIT (dBuV/m)	MARGIN (dB)	ANTENNA HEIGHT (m)	TABLE ANGLE (Degree)	RAW VALUE (dBuV)	CORRECTION FACTOR (dB/m)
1	3836.60	54.8 PK	74.0	-19.2	1.30 H	86	19.33	35.47
2	3836.60	43.6 AV	54.0	-10.4	1.30 H	86	8.13	35.47
3	*5755.00	116.2 PK			1.53 H	88	74.47	41.73
4	*5755.00	103.3 AV			1.53 H	88	61.57	41.73
5	11510.00	62.1 PK	74.0	-11.9	1.08 H	147	14.36	47.74
6	11510.00	50.7 AV	54.0	-3.3	1.08 H	147	2.96	47.74

**ANTENNA POLARITY & TEST DISTANCE: VERTICAL AT 3 M**

NO.	FREQ. (MHz)	EMISSION LEVEL (dBuV/m)	LIMIT (dBuV/m)	MARGIN (dB)	ANTENNA HEIGHT (m)	TABLE ANGLE (Degree)	RAW VALUE (dBuV)	CORRECTION FACTOR (dB/m)
1	3836.60	57.4 PK	74.0	-16.6	1.26 V	93	21.93	35.47
2	3836.60	49.6 AV	54.0	-4.4	1.26 V	93	14.13	35.47
3	*5755.00	113.9 PK			1.10 V	83	72.17	41.73
4	*5755.00	102.8 AV			1.10 V	83	61.07	41.73
5	11510.00	59.6 PK	74.0	-14.4	1.12 V	97	11.86	47.74
6	11510.00	48.0 AV	54.0	-6.0	1.12 V	97	0.26	47.74

- REMARKS:**
1. Emission level (dBuV/m) = Raw Value (dBuV) + Correction Factor (dB/m).
  2. Correction Factor (dB/m) = Antenna Factor (dB/m) + Cable Factor (dB).
  3. The other emission levels were very low against the limit.
  4. Margin value = Emission level – Limit value.
  5. “ \* “: Fundamental frequency.
  6. The limit value is defined as per 15.247.



A D T

EUT TEST CONDITION		MEASUREMENT DETAIL	
CHANNEL	Channel 159	FREQUENCY RANGE	1 ~ 40GHz
INPUT POWER	120Vac, 60 Hz	DETECTOR FUNCTION	Peak (PK) Average (AV)
ENVIRONMENTAL CONDITIONS	12deg. C, 64%RH 1023 hPa	TESTED BY	Frank Liu

ANTENNA POLARITY & TEST DISTANCE: HORIZONTAL AT 3 M								
NO.	FREQ. (MHz)	EMISSION LEVEL (dBuV/m)	LIMIT (dBuV/m)	MARGIN (dB)	ANTENNA HEIGHT (m)	TABLE ANGLE (Degree)	RAW VALUE (dBuV)	CORRECTION FACTOR (dB/m)
1	3863.30	53.9 PK	74.0	-20.1	1.27 H	87	18.32	35.58
2	3863.30	43.0 AV	54.0	-11.0	1.27 H	87	7.42	35.58
3	*5795.00	116.9 PK			1.52 H	89	75.05	41.85
4	*5795.00	104.4 AV			1.52 H	89	62.55	41.85
5	11590.00	61.8 PK	74.0	-12.2	1.08 H	146	14.02	47.78
6	11590.00	50.4 AV	54.0	-3.6	1.08 H	146	2.62	47.78
ANTENNA POLARITY & TEST DISTANCE: VERTICAL AT 3 M								
NO.	FREQ. (MHz)	EMISSION LEVEL (dBuV/m)	LIMIT (dBuV/m)	MARGIN (dB)	ANTENNA HEIGHT (m)	TABLE ANGLE (Degree)	RAW VALUE (dBuV)	CORRECTION FACTOR (dB/m)
1	3863.30	56.7 PK	74.0	-17.3	1.25 V	94	21.12	35.58
2	3863.30	48.1 AV	54.0	-5.9	1.25 V	94	12.52	35.58
3	*5795.00	115.0 PK			1.09 V	86	73.15	41.85
4	*5795.00	103.6 AV			1.09 V	86	61.75	41.85
5	11590.00	59.7 PK	74.0	-14.3	1.10 V	99	11.92	47.78
6	11590.00	47.8 AV	54.0	-6.2	1.10 V	99	0.02	47.78

- REMARKS:**
1. Emission level (dBuV/m) = Raw Value (dBuV) + Correction Factor (dB/m).
  2. Correction Factor (dB/m) = Antenna Factor (dB/m) + Cable Factor (dB).
  3. The other emission levels were very low against the limit.
  4. Margin value = Emission level – Limit value.
  5. “ \* “: Fundamental frequency.
  6. The limit value is defined as per 15.247.

### 5.3 6dB BANDWIDTH MEASUREMENT

#### 5.3.1 LIMITS OF 6dB BANDWIDTH MEASUREMENT

The minimum of 6dB Bandwidth Measurement is 0.5 MHz.

#### 5.3.2 TEST INSTRUMENTS

DESCRIPTION & MANUFACTURER	MODEL NO.	SERIAL NO.	CALIBRATED DATE	CALIBRATED UNTIL
Spectrum Analyzer	FSP 40	100060	May 17, 2010	May 16, 2011

**NOTE:** The calibration interval of the above test instruments is 12 months and the calibrations are traceable to NML/ROC and NIST/USA.

#### 5.3.3 TEST PROCEDURE

The transmitter output was connected to the spectrum analyzer through an attenuator. The bandwidth of the fundamental frequency was measured by spectrum analyzer with 100kHz RBW and 100kHz VBW. The 6dB bandwidth is defined as the total spectrum the power of which is higher than peak power minus 6dB.

#### 5.3.4 DEVIATION FROM TEST STANDARD

No deviation

#### 5.3.5 TEST SETUP

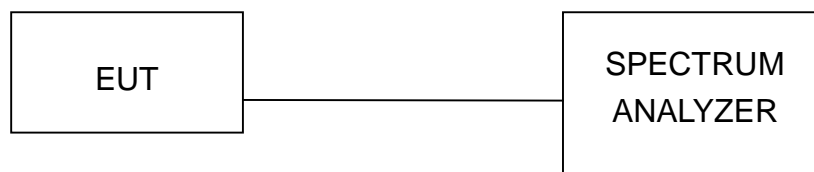

#### 5.3.6 EUT OPERATING CONDITIONS

The software provided by client to enable the EUT under transmission condition continuously at lowest, middle and highest channel frequencies individually.

### 5.3.7 TEST RESULTS

#### 802.11a OFDM MODULATION:

CHANNEL	CHANNEL FREQUENCY (MHz)	6dB BANDWIDTH (MHz)	MINIMUM LIMIT (MHz)	PASS / FAIL
149	5745	15.18	0.5	PASS
157	5785	15.34	0.5	PASS
165	5825	15.19	0.5	PASS

#### CH157

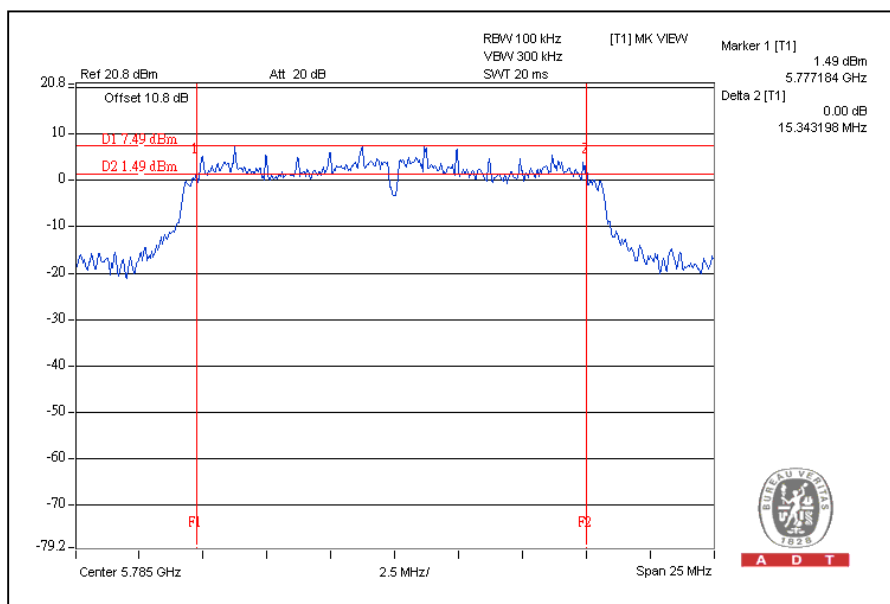



A D T

**802.11n (20MHz) OFDM MODULATION:**

CHANNEL	CHANNEL FREQUENCY (MHz)	6dB BANDWIDTH (MHz)	MINIMUM LIMIT (MHz)	PASS / FAIL
149	5745	15.11	0.5	PASS
157	5785	15.17	0.5	PASS
165	5825	15.16	0.5	PASS

**CH157**

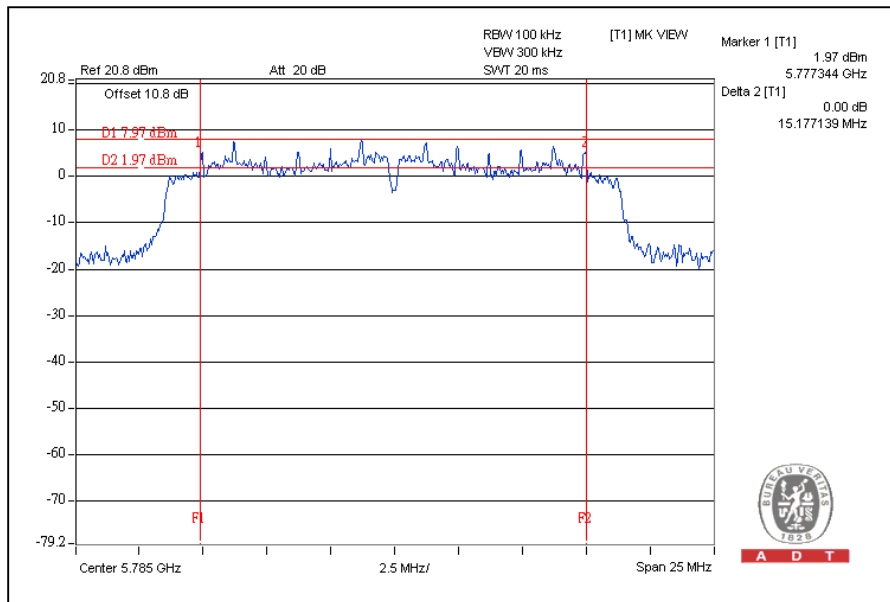



A D T

### 802.11n (40MHz) OFDM MODULATION:

CHANNEL	CHANNEL FREQUENCY (MHz)	6dB BANDWIDTH (MHz)	MINIMUM LIMIT (MHz)	PASS / FAIL
151	5755	35.76	0.5	PASS
159	5795	35.76	0.5	PASS

### CH159

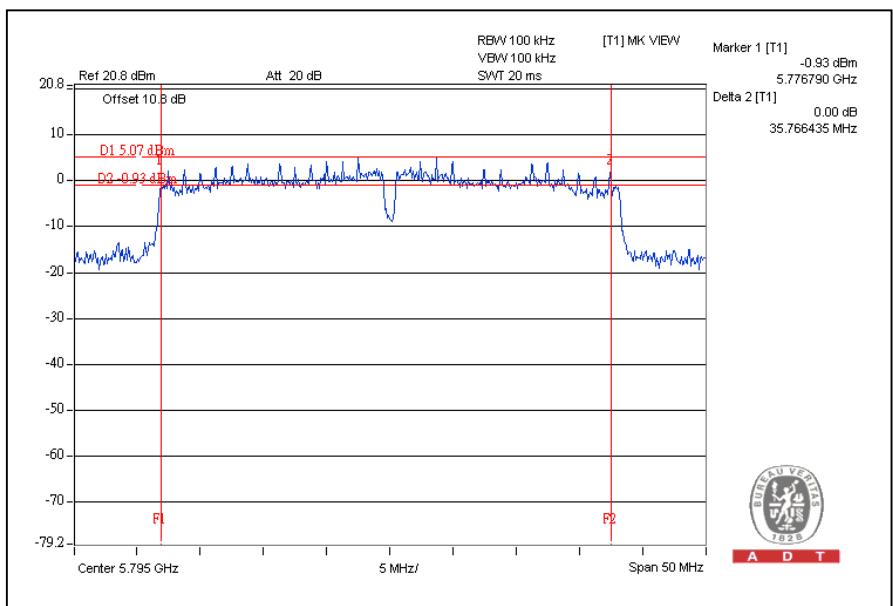



## 5.4 MAXIMUM PEAK OUTPUT POWER

### 5.4.1 LIMITS OF MAXIMUM PEAK OUTPUT POWER MEASUREMENT

The Maximum Peak Output Power Measurement is 30dBm.

### 5.4.2 INSTRUMENTS

DESCRIPTION & MANUFACTURER	MODEL NO.	SERIAL NO.	CALIBRATED DATE	CALIBRATED UNTIL
Peak Power Meter	ML2495A	0824006	May 04, 2010	May 03, 2011
Power Sensor	MA2411B	0738172	May 04, 2010	May 03, 2011

**NOTE:** The calibration interval of the above test instruments is 12 months and the calibrations are traceable to NML/ROC and NIST/USA.

### 5.4.3 TEST PROCEDURES

1. The transmitter output was connected to the power meter through an attenuator; the bandwidth of the fundamental frequency was measured with the power meter.
2. Record the power level.

### 5.4.4 DEVIATION FROM TEST STANDARD

No deviation

### 5.4.5 TEST SETUP

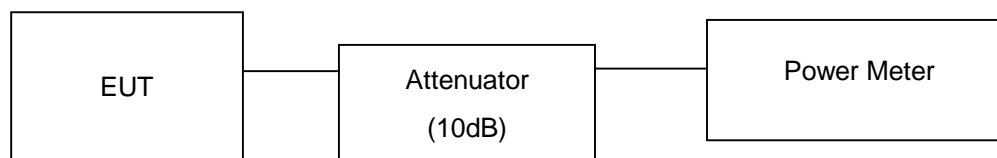

### 5.4.6 EUT OPERATING CONDITIONS

Same as Item 4.3.6

## 5.4.7 TEST RESULTS

### 802.11a OFDM MODULATION:

CHANNEL	CHANNEL FREQUENCY (MHz)	PEAK POWER OUTPUT (dBm)		TOTAL PEAK POWER (mW)	TOTAL PEAK POWER (dBm)	PEAK POWER LIMIT (dBm)	PASS / FAIL
		CHAIN(0)	CHAIN(1)				
149	5745	22.6	22.9	377.0	25.8	28.3	PASS
157	5785	22.4	22.8	364.3	25.6	28.3	PASS
165	5825	22.2	22.6	347.9	25.4	28.3	PASS

Directional gain = Directional gain =  $10 \log \left[ \left( 10^{G1/20} + 10^{G2/20} \right)^2 / 2 \right]$

Effective Legacy Gain (dBi) = 7.7

The effective legacy gain is 7.7dBi, therefore the limit needs to reduce.

### 802.11n (20MHz) OFDM MODULATION:

CHANNEL	CHANNEL FREQUENCY (MHz)	PEAK POWER OUTPUT (dBm)		TOTAL PEAK POWER (mW)	TOTAL PEAK POWER (dBm)	PEAK POWER LIMIT (dBm)	PASS / FAIL
		CHAIN(0)	CHAIN(1)				
149	5745	22.6	22.7	368.2	25.7	30	PASS
157	5785	22.3	22.6	351.8	25.5	30	PASS
165	5825	22.2	22.4	339.7	25.3	30	PASS

### 802.11n (40MHz) OFDM MODULATION:

CHANNEL	CHANNEL FREQUENCY (MHz)	PEAK POWER OUTPUT (dBm)		TOTAL PEAK POWER (mW)	TOTAL PEAK POWER (dBm)	PEAK POWER LIMIT (dBm)	PASS / FAIL
		CHAIN(0)	CHAIN(1)				
151	5755	22.1	22.2	328.1	25.2	30	PASS
159	5795	22.3	22.6	351.8	25.5	30	PASS

## 5.5 POWER SPECTRAL DENSITY MEASUREMENT

### 5.5.1 LIMITS OF POWER SPECTRAL DENSITY MEASUREMENT

The Maximum of Power Spectral Density Measurement is 8dBm.

### 5.5.2 TEST INSTRUMENTS

DESCRIPTION & MANUFACTURER	MODEL NO.	SERIAL NO.	CALIBRATED DATE	CALIBRATED UNTIL
Spectrum Analyzer	FSP 40	100060	May 17, 2010	May 16, 2011

**NOTE:** The calibration interval of the above test instruments is 12 months and the calibrations are traceable to NML/ROC and NIST/USA.

### 5.5.3 TEST PROCEDURE

The transmitter output was connected to the spectrum analyzer through an attenuator, the bandwidth of the fundamental frequency was measured with the spectrum analyzer using 3 kHz RBW and 30 kHz VBW, set sweep time = span/3 kHz. The power spectral density was measured and recorded.

The sweep time is allowed to be longer than span/3 kHz for a full response of the mixer in the spectrum analyzer.

### 5.5.4 DEVIATION FROM TEST STANDARD

No deviation

### 5.5.5 TEST SETUP

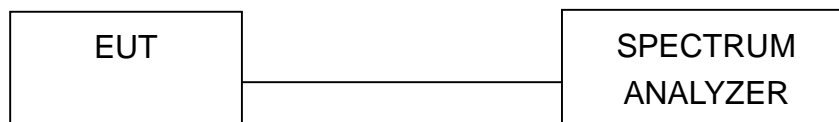

### 5.5.6 EUT OPERATING CONDITION

Same as Item 4.3.6

## 5.5.7 TEST RESULTS

### 802.11a OFDM MODULATION:

CHANNEL	CHANNEL FREQUENCY (MHz)	RF POWER LEVEL IN 3kHz BW (dBm)		TOTAL POWER DENSITY (dBm)	MAXIMUM LIMIT (dBm)	PASS / FAIL
		CHAIN(0)	CHAIN(1)			
149	5745	-7.5	-6.1	-3.7	8	PASS
157	5785	-9.0	-6.0	-4.2	8	PASS
165	5825	-7.8	-8.2	-5.0	8	PASS

For Chain(1): CH157

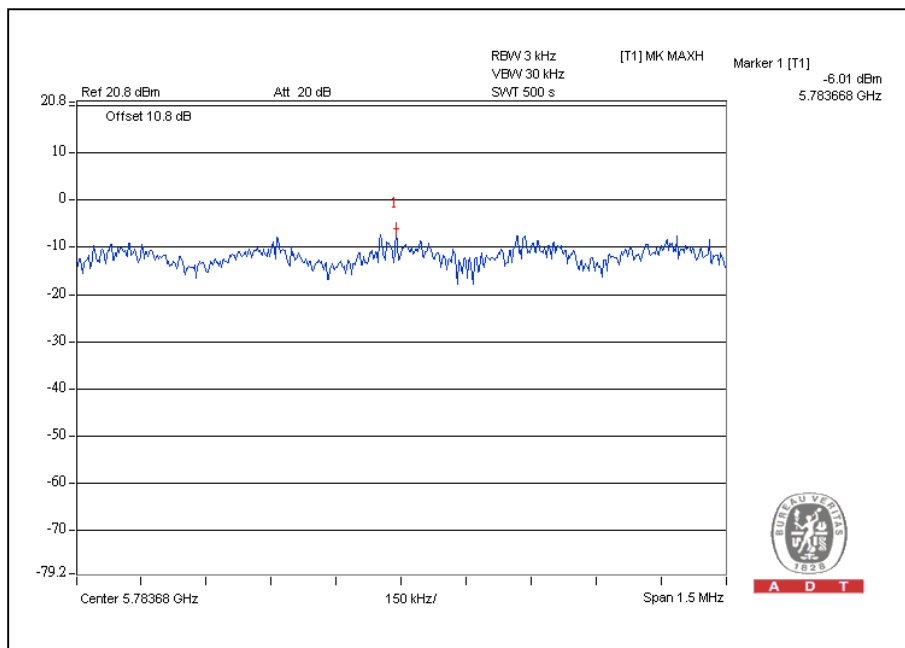



A D T

### 802.11n (20MHz) OFDM MODULATION:

CHANNEL	CHANNEL FREQUENCY (MHz)	RF POWER LEVEL IN 3kHz BW (dBm)		TOTAL POWER DENSITY (dBm)	MAXIMUM LIMIT (dBm)	PASS / FAIL
		CHAIN(0)	CHAIN(1)			
149	5745	-7.9	-7.8	-4.8	8	PASS
157	5785	-7.5	-6.0	-3.7	8	PASS
165	5825	-7.1	-6.7	-3.9	8	PASS

For Chain(1): CH157

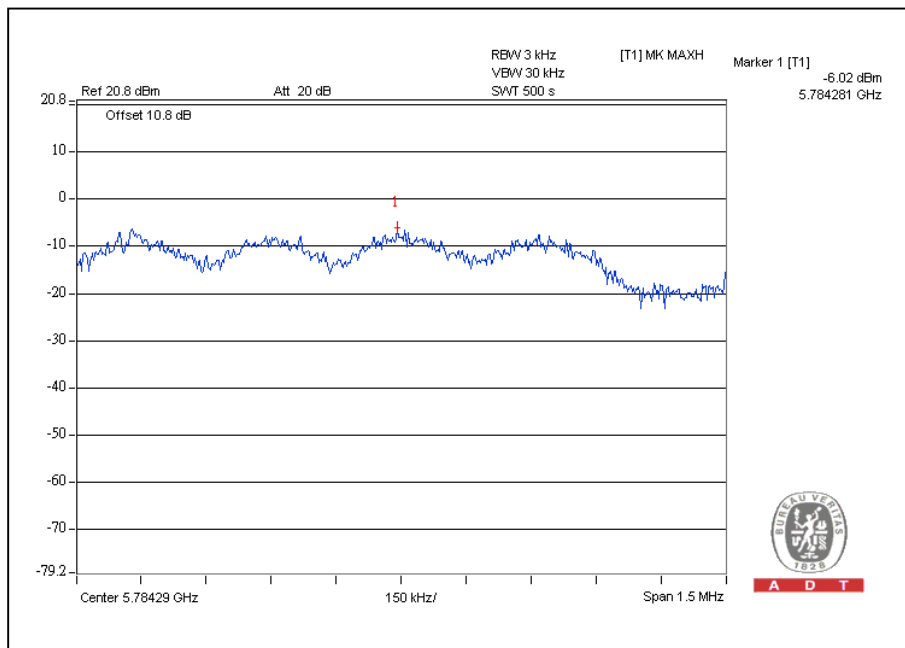



A D T

### 802.11n (40MHz) OFDM MODULATION:

CHANNEL	CHANNEL FREQUENCY (MHz)	RF POWER LEVEL IN 3kHz BW (dBm)		TOTAL POWER DENSITY (dBm)	MAXIMUM LIMIT (dBm)	PASS / FAIL
		CHAIN(0)	CHAIN(1)			
151	5755	-10.8	-11.9	-8.3	8	PASS
159	5795	-10.2	-9.5	-6.8	8	PASS

For Chain(1): CH159

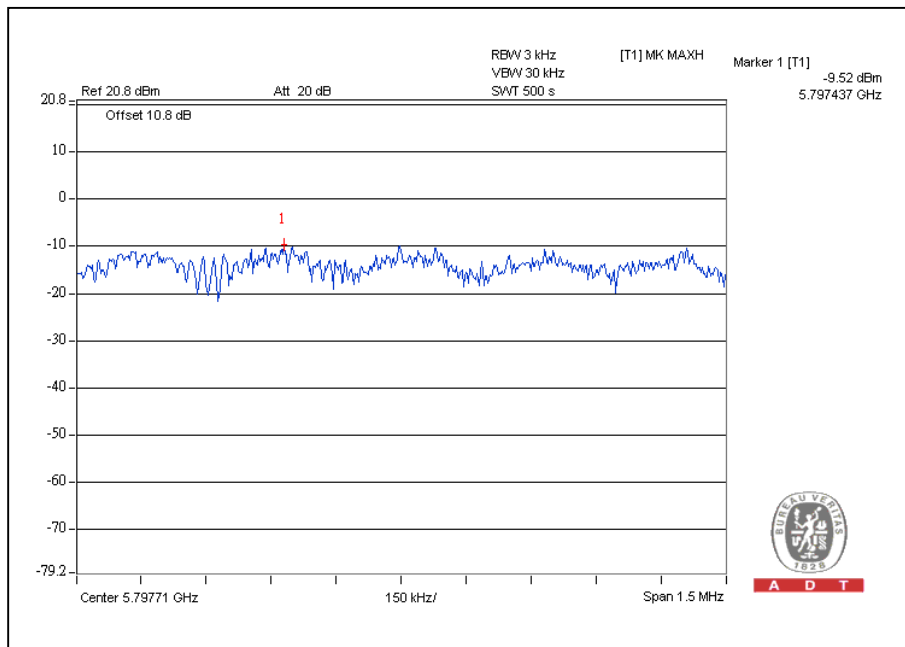

## 5.6 CONDUCTED OUT-BAND EMISSION MEASUREMENT

### 5.6.1 LIMITS OF CONDUCTED OUT-BAND EMISSION MEASUREMENT

Below  $-20\text{dB}$  of the highest emission level of operating band (in 100kHz Resolution Bandwidth).

### 5.6.2 TEST INSTRUMENTS

DESCRIPTION & MANUFACTURER	MODEL NO.	SERIAL NO.	CALIBRATED DATE	CALIBRATED UNTIL
Spectrum Analyzer	FSP 40	100060	May 17, 2010	May 16, 2011

**NOTE:** The calibration interval of the above test instruments is 12 months and the calibrations are traceable to NML/ROC and NIST/USA.

### 5.6.3 TEST PROCEDURE

The transmitter output was connected to the spectrum analyzer via a low loss cable. Set RBW of spectrum analyzer to 100 kHz with suitable frequency span including 100MHz or 200MHz bandwidth from band edge. The band edges was measured and recorded.

### 5.6.4 DEVIATION FROM TEST STANDARD

No deviation

### 5.6.5 EUT OPERATING CONDITION

Same as Item 4.3.6

### 5.6.6 TEST RESULTS

The spectrum plots are attached on the following pages. D2 line indicates the highest level, D1 line indicates the 20dB offset below D2. It shows compliance with the requirement in part 15.247(d).



A D T

## 802.11a OFDM modulation

### CH149

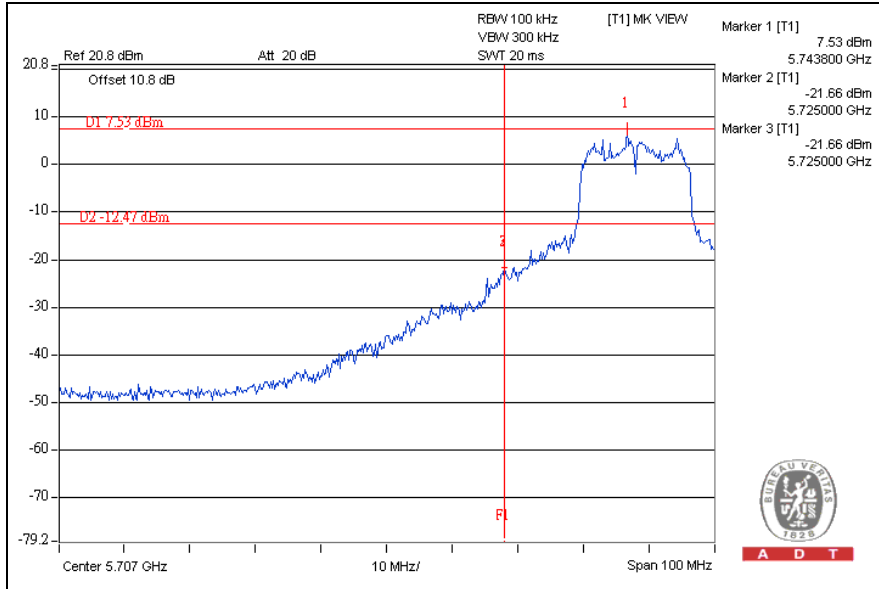

### CH165

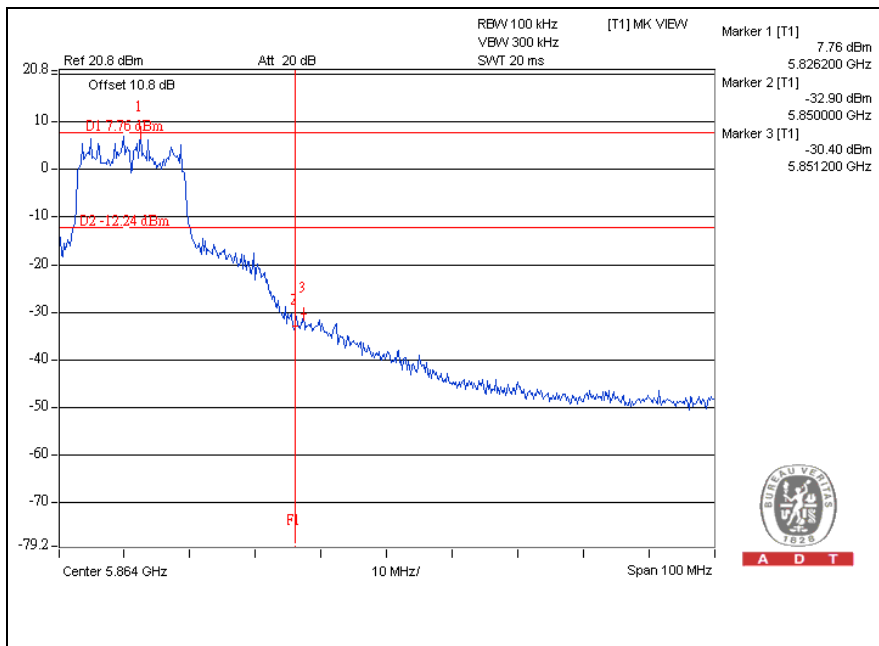





A D T

### CH149

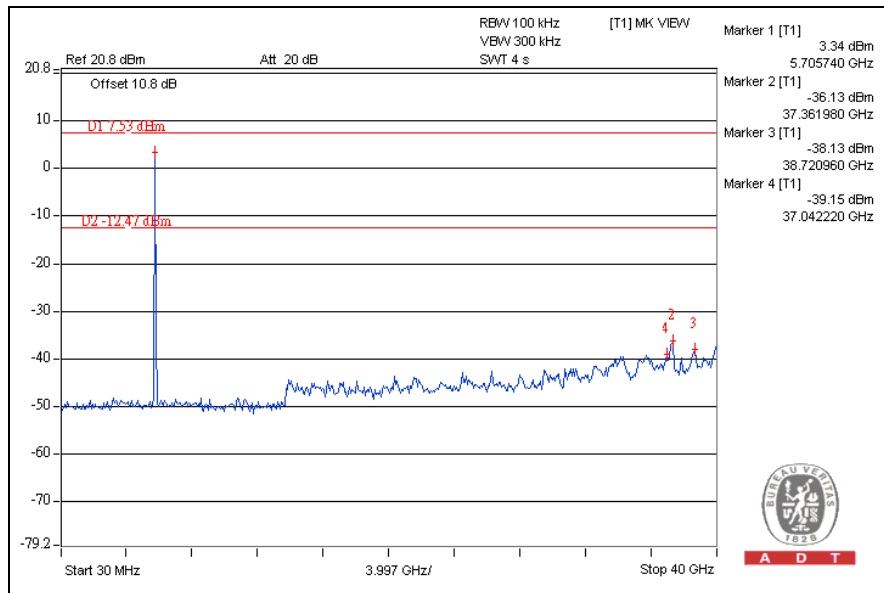

### CH165

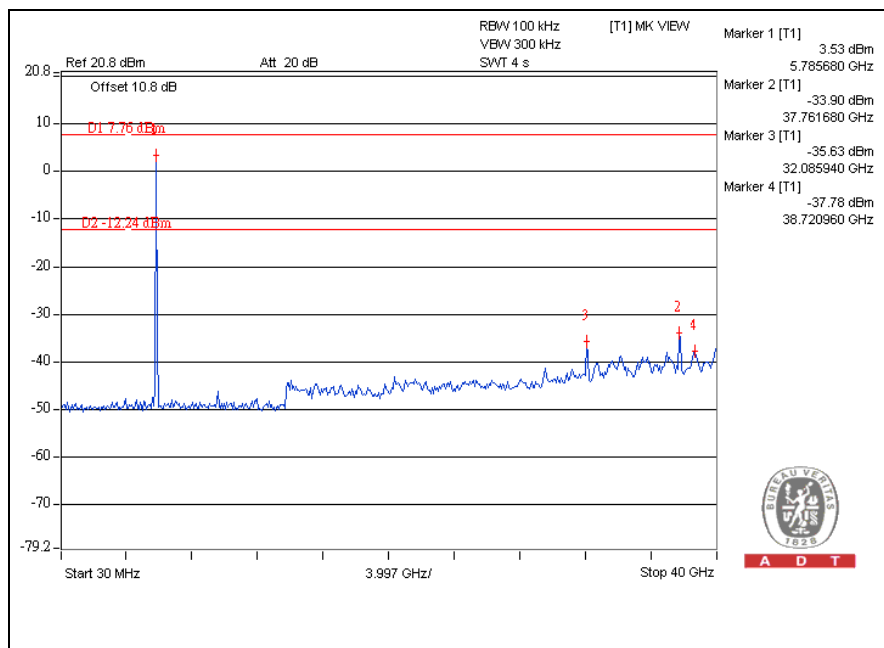



A D T

### 802.11n (20MHz) OFDM MODULATION:

#### CH149

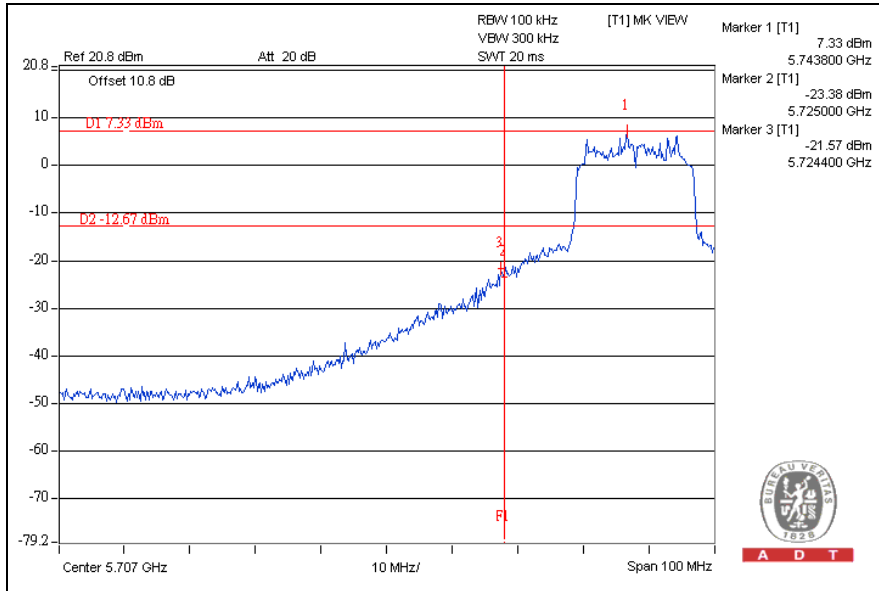

#### CH165

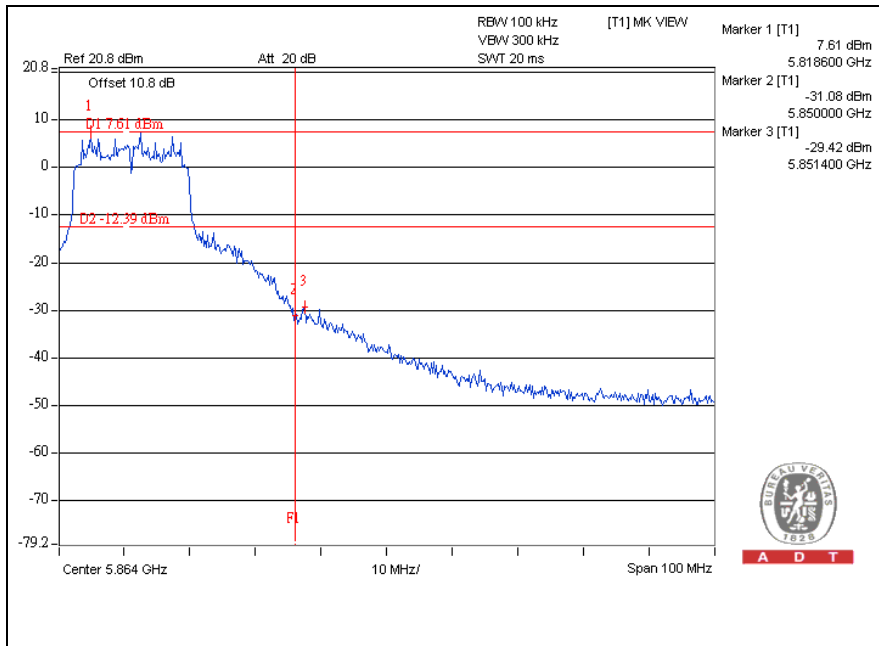



A D T

### CH149

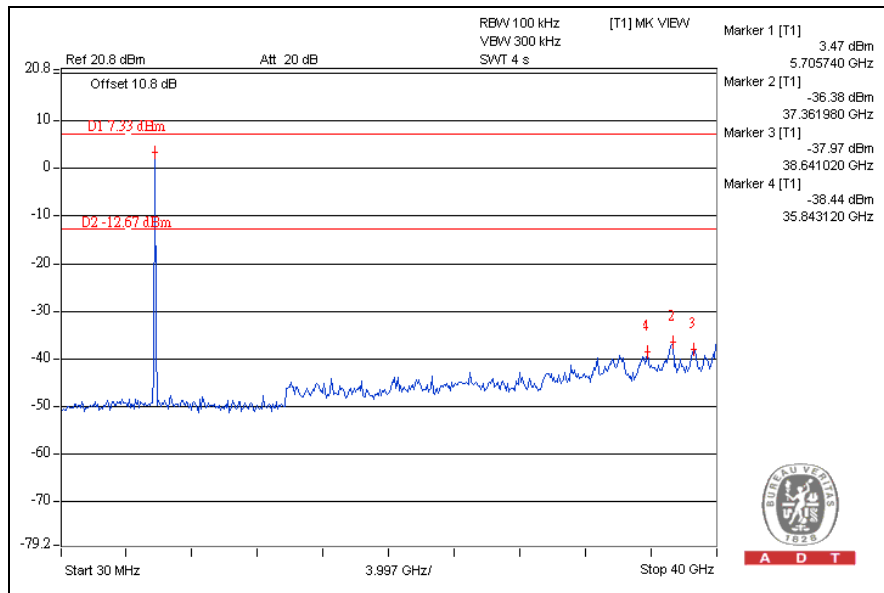

### CH165

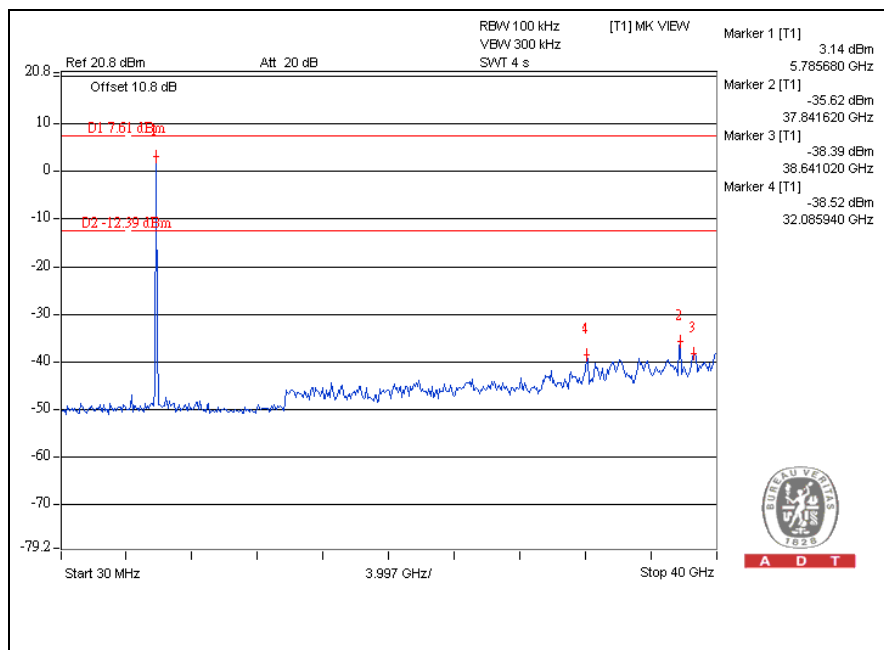



A D T

## 802.11n (40MHz) OFDM MODULATION:

### CH151

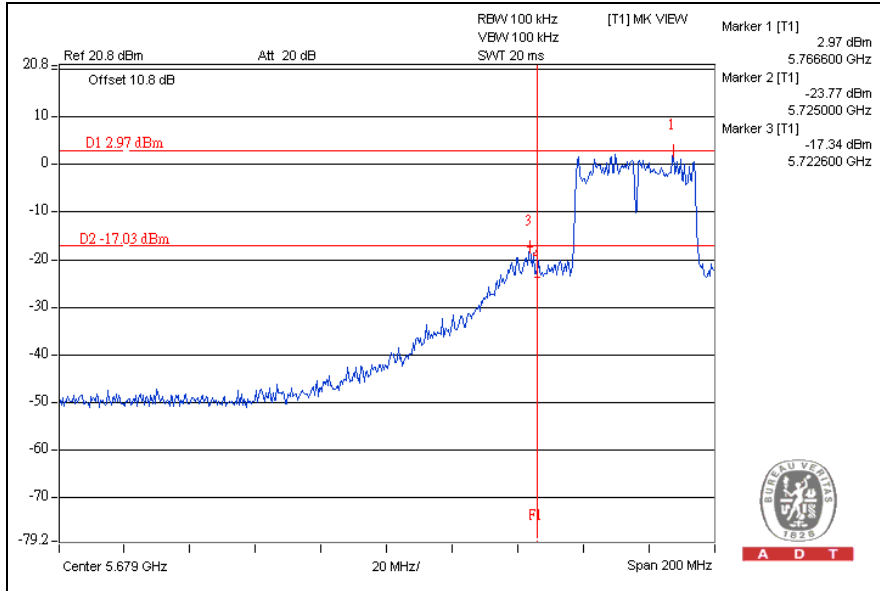

### CH159

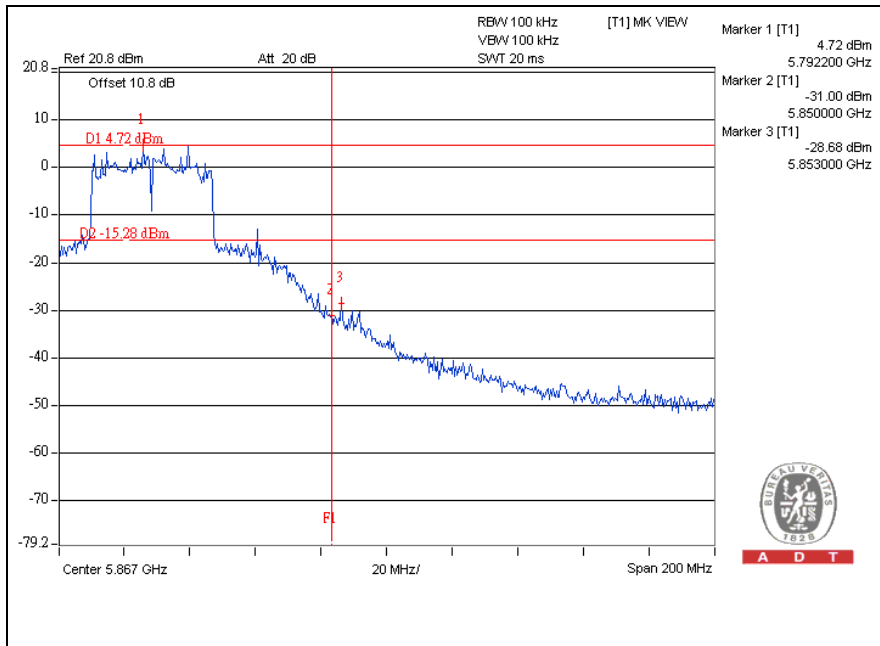



A D T

### CH151

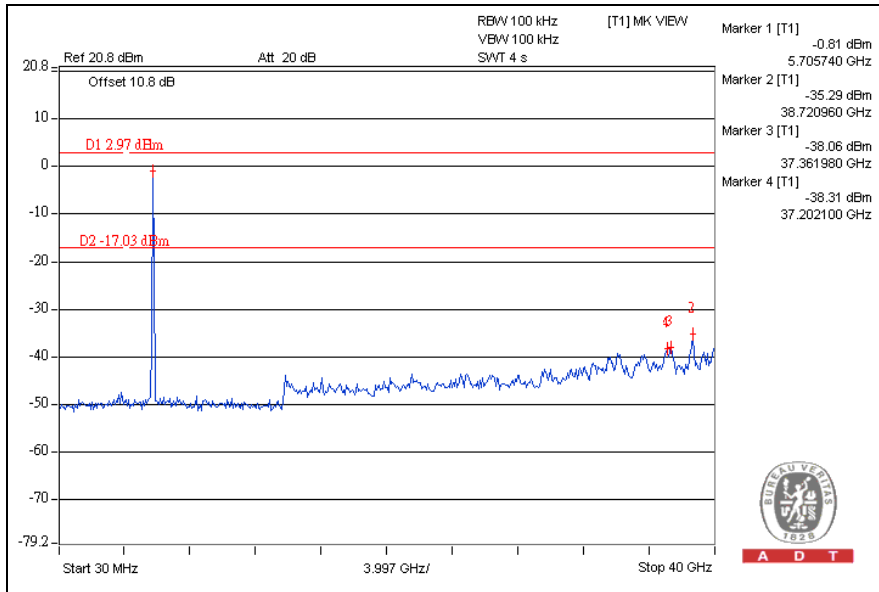

### CH159

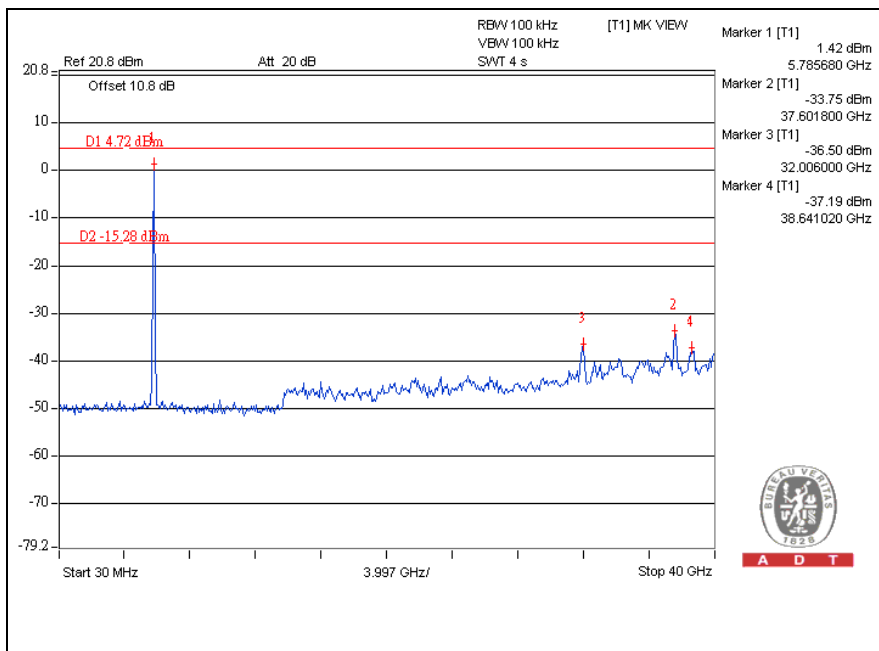



## 6. INFORMATION ON THE TESTING LABORATORIES

We, Bureau Veritas Consumer Products Services (H.K.) Ltd., Taoyuan Branch, were founded in 1988 to provide our best service in EMC, Radio, Telecom and Safety consultation. Our laboratories are accredited and approved according to ISO/IEC 17025.

Copies of accreditation certificates of our laboratories obtained from approval agencies can be downloaded from our web site: [www.adt.com.tw/index.5.phtml](http://www.adt.com.tw/index.5.phtml). If you have any comments, please feel free to contact us at the following:

**Linko EMC/RF Lab:**

Tel: 886-2-26052180

Fax: 886-2-26052943

**Hsin Chu EMC/RF Lab:**

Tel: 886-3-5935343

Fax: 886-3-5935342

**Hwa Ya EMC/RF/Safety/Telecom Lab:**

Tel: 886-3-3183232

Fax: 886-3-3185050

**Email:** [service.adt@tw.bureauveritas.com](mailto:service.adt@tw.bureauveritas.com)

**Web Site:** [www.adt.com.tw](http://www.adt.com.tw)

The address and road map of all our labs can be found in our web site also



A D T

## **7.APPENDIX A - MODIFICATIONS RECORDERS FOR ENGINEERING CHANGES TO THE EUT BY THE LAB**

No any modifications are made to the EUT by the lab during the test.

**--- END ---**