



FCC TEST REPORT (15.407)

REPORT NO.: RF110107E07G-1 R2

MODEL NO.: F9K1106v1

FCC ID: K7SF9K1106V1

RECEIVED: Jan. 05, 2011

TESTED: Jan. 12 to Feb. 15, 2011 and May 19, 2011

ISSUED: Aug. 19, 2011

APPLICANT: Belkin International, Inc.

ADDRESS: 12045 East Waterfront Drive, Playa Vista,
CA 90094

ISSUED BY: Bureau Veritas Consumer Products Services
(H.K.) Ltd., Taoyuan Branch Hsin Chu Laboratory

LAB ADDRESS : No. 81-1, Lu Liao Keng, 9th Ling,Wu Lung Tsuen,
Chiung Lin Hsiang, Hsin Chu Hsien 307, Taiwan

TEST LOCATION (1): No. 81-1, Lu Liao Keng, 9th Ling,Wu Lung Tsuen,
Chiung Lin Hsiang, Hsin Chu Hsien 307, Taiwan

TEST LOCATION (2): No. 49, Ln. 206, Wende Rd., Shangshan Tsuen,
Chiung Lin Hsiang, Hsin Chu Hsien 307, Taiwan

This test report consists of 81 pages in total. It may be duplicated completely for legal use with the approval of the applicant. It should not be reproduced except in full, without the written approval of our laboratory. The client should not use it to claim product certification, approval, or endorsement by TAF or any government agencies. The test results in the report only apply to the tested sample.





A D T

Table of Contents

RELEASE CONTROL RECORD	4
1. CERTIFICATION	5
2. SUMMARY OF TEST RESULTS	6
2.1 MEASUREMENT UNCERTAINTY	7
3. GENERAL INFORMATION	8
3.1 GENERAL DESCRIPTION OF EUT	8
3.2 DESCRIPTION OF TEST MODES	11
3.2.1 TEST MODE APPLICABILITY AND TESTED CHANNEL DETAIL:	12
3.3 GENERAL DESCRIPTION OF APPLIED STANDARDS	15
3.4 DESCRIPTION OF SUPPORT UNITS.....	16
3.5 CONFIGURATION OF SYSTEM UNDER TEST	17
4. TEST TYPES AND RESULTS	18
4.1 CONDUCTED EMISSION MEASUREMENT	18
4.1.1 LIMITS OF CONDUCTED EMISSION MEASUREMENT	18
4.1.2 TEST INSTRUMENTS.....	18
4.1.3 TEST PROCEDURES	19
4.1.4 DEVIATION FROM TEST STANDARD	19
4.1.5 TEST SETUP	20
4.1.6 EUT OPERATING CONDITIONS	20
4.1.7 TEST RESULTS (WITH ADAPTER 1)	21
4.1.8 TEST RESULTS (WITH ADAPTER 2)	23
4.2 RADIATED EMISSION MEASUREMENT	25
4.2.1 LIMITS OF RADIATED EMISSION MEASUREMENT	25
4.2.2 LIMITS OF UNWANTED EMISSION OUT OF THE RESTRICTED BANDS.....	26
4.2.3 TEST INSTRUMENTS.....	27
4.2.4 TEST PROCEDURES	29
4.2.5 DEVIATION FROM TEST STANDARD	29
4.2.6 TEST SETUP	30
4.2.7 EUT OPERATING CONDITION.....	30
4.2.8 TEST RESULTS	31
4.3 PEAK TRANSMIT POWER MEASUREMENT	52
4.3.1 LIMITS OF PEAK TRANSMIT POWER MEASUREMENT	52
4.3.2 TEST INSTRUMENTS.....	52
4.3.3 TEST PROCEDURE.....	53
4.3.4 DEVIATION FROM TEST STANDARD	53
4.3.5 TEST SETUP	53
4.3.6 EUT OPERATING CONDITIONS	53
4.3.7 TEST RESULTS	54
4.4 PEAK POWER EXCURSION MEASUREMENT	60
4.4.1 LIMITS OF PEAK POWER EXCURSION MEASUREMENT	60



A D T

4.4.2	TEST INSTRUMENTS.....	60
4.4.3	TEST PROCEDURE.....	60
4.4.4	DEVIATION FROM TEST STANDARD.....	60
4.4.5	TEST SETUP.....	61
4.4.6	EUT OPERATING CONDITIONS.....	61
4.4.7	TEST RESULTS.....	62
4.5	PEAK POWER SPECTRAL DENSITY MEASUREMENT.....	65
4.5.1	LIMITS OF PEAK POWER SPECTRAL DENSITY MEASUREMENT.....	65
4.5.2	TEST INSTRUMENTS.....	65
4.5.3	TEST PROCEDURES.....	66
4.5.4	DEVIATION FROM TEST STANDARD.....	66
4.5.5	TEST SETUP.....	66
4.5.6	EUT OPERATING CONDITIONS.....	66
4.5.7	TEST RESULTS.....	67
4.6	FREQUENCY STABILITY.....	70
4.6.1	LIMITS OF FREQUENCY STABILITY MEASUREMENT.....	70
4.6.2	TEST INSTRUMENTS.....	70
4.6.3	TEST PROCEDURE.....	70
4.6.4	DEVIATION FROM TEST STANDARD.....	71
4.6.5	TEST SETUP.....	71
4.6.6	EUT OPERATING CONDITION.....	71
4.6.7	TEST RESULTS.....	72
4.7	CONDUCTED OUT-BAND EMISSION MEASUREMENT.....	73
4.7.1	TEST INSTRUMENTS.....	73
4.7.2	TEST PROCEDURE.....	73
4.7.3	EUT OPERATING CONDITION.....	73
4.7.4	TEST RESULTS.....	73
5.	INFORMATION ON THE TESTING LABORATORIES.....	80
6.	APPENDIX A - MODIFICATIONS RECORDERS FOR ENGINEERING CHANGES TO THE EUT BY THE LAB.....	81



A D T

RELEASE CONTROL RECORD

ISSUE NO.	REASON FOR CHANGE	DATE ISSUED
RF110107E07G-1	Original release	July 25, 2011
RF110107E07G-1 R1	Modify the model name.	July 29, 2011
RF110107E07G-1 R2	Modify the section 3.1 note 4 and the PSD limit to be reduced.	Aug. 19, 2011



1. CERTIFICATION

PRODUCT: Dual-Band Wireless Range Extender
BRAND NAME: Belkin
MODEL NO.: F9K1106v1
TEST SAMPLE: R&D SAMPLE
TESTED: Jan. 12 to Feb. 15, 2011 and
May 19, 2011(Only for radiated test below 1GHz)
APPLICANT: Belkin International, Inc.
STANDARDS: FCC Part 15, Subpart E (Section 15.407)
ANSI C63.4-2003
ANSI C63.10-2009

The above equipment (Model: F9K1106v1) has been tested by **Bureau Veritas Consumer Products Services (H.K.) Ltd., Taoyuan Branch**, and found compliance with the requirement of the above standards. The test record, data evaluation & Equipment Under Test (EUT) configurations represented herein are true and accurate accounts of the measurements of the sample's EMC characteristics under the conditions specified in this report.

PREPARED BY :  , **DATE:** Aug. 19, 2011
(Claire Kuan, Specialist)

APPROVED BY :  , **DATE:** Aug. 19, 2011
(May Chen, Deputy Manager)

2. SUMMARY OF TEST RESULTS

The EUT has been tested according to the following specifications:

For 802.11a

APPLIED STANDARD: FCC Part 15, Subpart E (Section 15.407)			
Standard Section	Test Type	Result	Remark
15.407(b)(5)	AC Power Conducted Emission	PASS	Meet the requirement of limit. Minimum passing margin is -5.86dB at 0.775MHz
15.407(b)(1/2/3) (b)(5)	Electric Field Strength Spurious Emissions, 30MHz ~ 40000MHz	PASS	Meet the requirement of limit. Minimum passing margin is -1.0dB at 5150.00MHz
15.407(a)(1/2/3)	Peak Transmit Power	PASS	Meet the requirement of limit.
15.407(a)(6)	Peak Power Excursion	PASS	Meet the requirement of limit.
15.407(a)(1/2/3)	Peak Power Spectral Density	PASS	Meet the requirement of limit.
15.407(g)	Frequency Stability	PASS	Meet the requirement of limit.
15.203	Antenna Requirement	PASS	No antenna connector is used.

NOTE:

1. The EUT was operating in 2400 ~ 2483.5MHz, 5.15~5.25GHz and 5.725~5.850GHz frequencies band. This report was recorded the RF parameters including 5.15~5.25GHz. For the 2400 ~ 2483.5MHz and 5.725~5.850GHz RF parameters was recorded in another test report.



A D T

2.1 MEASUREMENT UNCERTAINTY

Where relevant, the following measurement uncertainty levels have been estimated for tests performed on the EUT as specified in CISPR 16-4-2:

This uncertainty represents an expanded uncertainty expressed at approximately the 95% confidence level using a coverage factor of $k=2$.

Measurement	Value
Conducted emissions	2.45 dB
Radiated emissions (30MHz-1GHz)	3.89 dB
Radiated emissions (1GHz -18GHz)	3.3 dB
Radiated emissions (18GHz -40GHz)	2.19 dB



A D T

3. GENERAL INFORMATION

3.1 GENERAL DESCRIPTION OF EUT

PRODUCT	Dual-Band Wireless Range Extender
MODEL NO.	F9K1106v1
FCC ID	K7SF9K1106V1
POWER SUPPLY	DC 12V from power adapter
MODULATION TYPE	CCK, DQPSK, DBPSK for DSSS 64QAM, 16QAM, QPSK, BPSK for OFDM
MODULATION TECHNOLOGY	DSSS, OFDM
TRANSFER RATE	802.11a/g : 54/48/36/24/18/12/9/6Mbps 802.11b :11/5.5/2/1Mbps 802.11n (20MHz, 400ns GI): 144.4/130/115.6/86.7/57.8/43.3/28.9/14.4/72.2 / 65 / 57.8 / 43.3 / 28.9 / 21.7 / 14.4 / 7.2Mbps 802.11n (40MHz, 400ns GI): 300/270/240/180/120/90/60/30/150 / 135 / 120 / 90 / 60 / 45 / 30 / 15Mbps
OPERATING FREQUENCY	For 15.407 802.11a: 5.18 ~ 5.24GHz For 15.247 802.11b & 802.11g: 2.412 ~ 2.462GHz 802.11a: 5.745 ~ 5.825GHz
NUMBER OF CHANNEL	For 15.407 4 for 802.11a, 802.11n (20MHz) 2 for 802.11n (40MHz) For 15.247(2.4GHz) 11 for 802.11b, 802.11g, 802.11n (20MHz) 7 for 802.11n (40MHz) For 15.247(5GHz) 5 for 802.11a, 802.11n (20MHz) 2 for 802.11n (40MHz)



A D T

MAXIMUM OUTPUT POWER	For 15.407 802.11a: 14.0mW 802.11n (20MHz): 25.2mW 802.11n (40MHz): 41.8mW For 15.247(2.4GHz) 802.11b: 162.2mW 802.11g: 608.0mW 802.11n (20MHz): 472.6mW 802.11n (40MHz): 212.4mW For 15.247(5GHz) 802.11a: 377.0mW 802.11n (20MHz): 368.2mW 802.11n (40MHz): 351.8mW
ANTENNA TYPE	Please see note 1
DATA CABLE	NA
I/O PORTS	LAN port (10, 100Mbps) x 4
ASSOCIATED DEVICES	Adapter x 1

NOTE:

1. There are two antennas provided to this EUT, please refer to the following table:

Transmitter Circuit	Antenna Type	2.4GHz Gain (dBi)	5 GHz Gain (dBi)
Chain (0)	PCB Printed	4.12	5.21
Chain (1)	PCB Printed	4.44	4.21

2. The EUT must be supplied with a power adapter and following two different model names could be chosen:

Adapter 1	
BRAND	LEI
MODEL	MT12-Y120100-A1
INPUT POWER	AC 120V, 60Hz, 0.3A
OUTPUT POWER	DC 12V, 1A DC Cable: 1.6m unshielded
Adapter 2	
BRAND	DVE
MODEL	DSA-12PFE-12 BUS 120100
INPUT POWER	AC 100-120V, 50-60Hz, 0.3A
OUTPUT POWER	DC 12V, 1A DC Cable: 1.6m unshielded

For radiated test, the EUT was pre-tested with above adapters, the worse case was found in adapter 1. Therefore only the test data of the adapter was recorded in this report.

3. The EUT incorporates a MIMO function with 802.11n.
4. The EUT incorporates CDD function with 802.11a, 802.11g.
5. 2.4GHz and 5GHz technology cannot transmit at same time.
6. The EUT is 2 * 2 spatial MIMO (2Tx & 2Rx) without beam forming function. The 11b legacy mode is limited to single transmitter only.
7. When the EUT operating in 802.11n, the software operation, which is defined by manufacturer, MCS (Modulation and Coding Schemes) from 0 to 15.
8. The EUT complies with 802.11n standards and backwards compatible with 802.11a, 802.11b, 802.11g products.
9. The above EUT information was declared by the manufacturer and for more detailed features description, please refer to the manufacturer's specifications or User's Manual.



A D T

3.2 DESCRIPTION OF TEST MODES

Operated in 5150MHz ~ 5250MHz bands:

Four channels are provided for 802.11a and 802.11n (20MHz):

CHANNEL	FREQUENCY
36	5180 MHz
40	5200 MHz
44	5220 MHz
48	5240 MHz

Two channels are provided for 802.11n (40MHz):

CHANNEL	FREQUENCY
38	5190 MHz
46	5230 MHz



A D T

3.2.1 TEST MODE APPLICABILITY AND TESTED CHANNEL DETAIL:

EUT CONFIGURE MODE	APPLICABLE TO				DESCRIPTION
	PLC	RE < 1G	RE ≥ 1G	APCM	
1	√	√	√	√	With Adapter 1
2	√	-	-	-	With Adapter 2

Where **PLC:** Power Line Conducted Emission **RE < 1G:** Radiated Emission below 1GHz
RE ≥ 1G: Radiated Emission above 1GHz **APCM:** Antenna Port Conducted Measurement

ANTENNA COMBINATION MODE:

COMBINATION MODE	OPERATION MODE	TX CHAIN(0)	TX CHAIN(1)
A	802.11 a	√	√
B	802.11n(20MHz) for MCS0~15	√	√
C	802.11n(40MHz) for MCS0~15	√	√

Note: The above information was declared by manufacturer and for more detailed features description, please refer to the manufacturer's specifications or user's manual.

POWER LINE CONDUCTED EMISSION TEST:

- Pre-Scan has been conducted to determine the worst-case mode from all possible combinations between available modulations, data rates and antenna ports (if EUT with antenna diversity architecture).
- Following channel(s) was (were) selected for the final test as listed below.

MODE	AVAILABLE CHANNEL	TESTED CHANNEL	MODULATION TECHNOLOGY	MODULATION TYPE	DATA RATE (MBPS)	COMBINATION MODE
802.11n (20MHz)	36 to 48	48	OFDM	BPSK	7.2	B

RADIATED EMISSION TEST (BELOW 1 GHz):

- Pre-Scan has been conducted to determine the worst-case mode from all possible combinations between available modulations, data rates and antenna ports (if EUT with antenna diversity architecture).
- Following channel(s) was (were) selected for the final test as listed below.

MODE	AVAILABLE CHANNEL	TESTED CHANNEL	MODULATION TECHNOLOGY	MODULATION TYPE	DATA RATE (Mbps)	COMBINATION MODE
802.11n (20MHz)	36 to 48	48	OFDM	BPSK	7.2	B

RADIATED EMISSION TEST (ABOVE 1 GHz):

- Pre-Scan has been conducted to determine the worst-case mode from all possible combinations between available modulations, data rates and antenna ports (if EUT with antenna diversity architecture).
- Following channel(s) was (were) selected for the final test as listed below.

MODE	AVAILABLE CHANNEL	TESTED CHANNEL	MODULATION TECHNOLOGY	MODULATION TYPE	DATA RATE (Mbps)	COMBINATION MODE
802.11a	36 to 48	36, 40, 48	OFDM	BPSK	6	A
802.11n (20MHz)	36 to 48	36, 40, 48	OFDM	BPSK	7.2	B
802.11n (40MHz)	38 to 46	38, 46	OFDM	BPSK	15	C

CONDUCTED OUT-BAND EMISSION MEASUREMENT:

- Pre-Scan has been conducted to determine the worst-case mode from all possible combinations between available modulations, data rates and antenna ports (if EUT with antenna diversity architecture).
- Following channel(s) was (were) selected for the final test as listed below.

MODE	AVAILABLE CHANNEL	TESTED CHANNEL	MODULATION TECHNOLOGY	MODULATION TYPE	DATA RATE (Mbps)	COMBINATION MODE
802.11a	36 to 48	36, 40, 48	OFDM	BPSK	6	A
802.11n (20MHz)	36 to 48	36, 40, 48	OFDM	BPSK	7.2	B
802.11n (40MHz)	38 to 46	38, 46	OFDM	BPSK	15	C

- ✧ After verification, conducted out band emission as show worst chain in report by investigations.



A D T

ANTENNA PORT CONDUCTED MEASUREMENT:

- This item includes all test value of each mode, but only includes spectrum plot of worst value of each mode.
- Pre-Scan has been conducted to determine the worst-case mode from all possible combinations between available modulations, data rates and antenna ports (if EUT with antenna diversity architecture).
- Following channel(s) was (were) selected for the final test as listed below.

MODE	AVAILABLE CHANNEL	TESTED CHANNEL	MODULATION TECHNOLOGY	MODULATION TYPE	DATA RATE (Mbps)	COMBINATION MODE
802.11a	36 to 48	36, 40, 48	OFDM	BPSK	6	A
802.11n (20MHz)	36 to 48	36, 40, 48	OFDM	BPSK	7.2	B
802.11n (40MHz)	38 to 46	38, 46	OFDM	BPSK	15	C

※ After verification, bandwidth as show worst chain in report by investigations.

TEST CONDITION:

APPLICABLE TO	ENVIRONMENTAL CONDITIONS	INPUT POWER	TESTED BY
RE ³ 1G	12deg. C, 64%RH, 1023 hPa	120Vac, 60Hz	Frank Liu
RE<1G	22deg. C, 61%RH, 1023 hPa	120Vac, 60Hz	Kent Liu
PLC	20deg. C, 70%RH, 1023 hPa	120Vac, 60Hz	Eric Lee
APCM	20deg. C, 60%RH, 1023 hPa	120Vac, 60Hz	Rex Huang



3.3 GENERAL DESCRIPTION OF APPLIED STANDARDS

The EUT is a RF product. According to the specifications of the manufacturer, it must comply with the requirements of the following standards:

FCC Part 15, Subpart E (15.407)

ANSI C63.4-2003

ANSI C63.10-2009

All test items have been performed and recorded as per the above standards.

NOTE: The EUT has been verified to comply with the requirements of FCC Part 15, Subpart B, Class B (DoC). The test report has been issued separately.



A D T

3.4 DESCRIPTION OF SUPPORT UNITS

The EUT has been tested as an independent unit together with other necessary accessories or support units. The following support units or accessories were used to form a representative test configuration during the tests.

No.	Product	Brand	Model No.	Serial No.	FCC ID
1	NOTEBOOK COMPUTER	DELL	PP32LA	HSLB32S	FCC DoC
2	HUB	ZyXEL	ES-116P	S060H02000215	FCC DoC

No.	Signal cable description
1	UTP Cable (10m)
2	UTP Cable (10m)

Note: The power cords of the above support units were unshielded (1.8m).

3.5 CONFIGURATION OF SYSTEM UNDER TEST

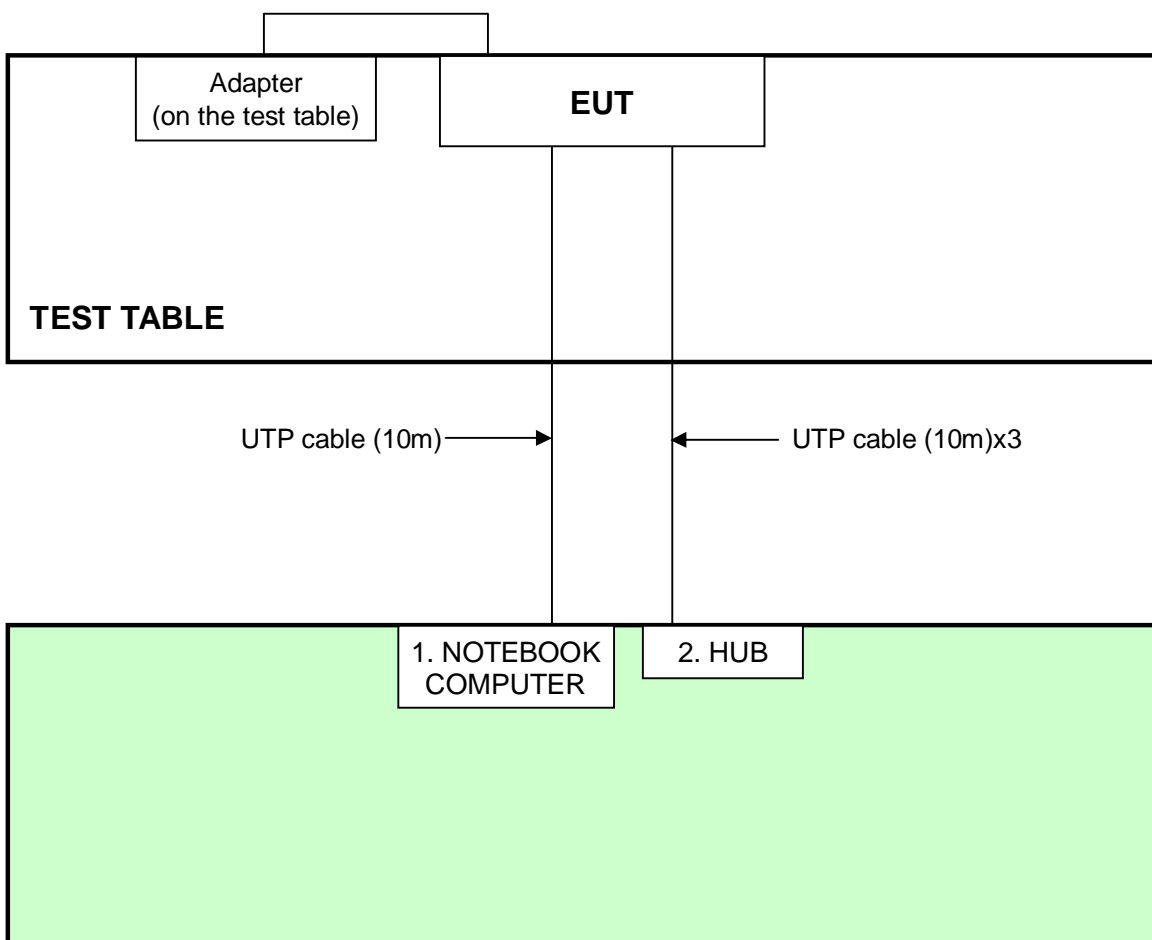

4. TEST TYPES AND RESULTS

4.1 CONDUCTED EMISSION MEASUREMENT

4.1.1 LIMITS OF CONDUCTED EMISSION MEASUREMENT

FREQUENCY OF EMISSION (MHz)	CONDUCTED LIMIT (dB μ V)	
	Quasi-peak	Average
0.15-0.5	66 to 56	56 to 46
0.5-5	56	46
5-30	60	50

- NOTE:**
1. The lower limit shall apply at the transition frequencies.
 2. The limit decreases in line with the logarithm of the frequency in the range of 0.15 to 0.50 MHz.
 3. All emanations from a class A/B digital device or system, including any network of conductors and apparatus connected thereto, shall not exceed the level of field strengths specified above.

4.1.2 TEST INSTRUMENTS

DESCRIPTION & MANUFACTURER	MODEL NO.	SERIAL NO.	CALIBRATED DATE	CALIBRATED UNTIL
ROHDE & SCHWARZ Test Receiver	ESCS 30	100287	Mar. 01, 2010	Feb. 28, 2011
Line-Impedance Stabilization Network (for EUT)	NSLK 8127	8127-523	Sep. 17, 2010	Sep. 16, 2011
Line-Impedance Stabilization Network (for Peripheral)	ENV-216	100072	June 11, 2010	June 10, 2011
RF Cable (JYBBAO)	5DFB	CONCAB-003	Aug. 06, 2010	Aug. 05, 2011
50 ohms Terminator	50	3	Nov. 03, 2010	Nov. 02, 2011
Software	BV ADT_Cond_V7.3.7	NA	NA	NA

Note:

1. The calibration interval of the above test instruments is 12 months and the calibrations are traceable to NML/ROC and NIST/USA.
2. The test was performed in Shielded Room No. A.
3. The VCCI Con A Registration No. is C-817.

4.1.3 TEST PROCEDURES

- a. The EUT was placed 0.4 meters from the conducting wall of the shielded room with EUT being connected to the power mains through a line impedance stabilization network (LISN). Other support units were connected to the power mains through another LISN. The two LISNs
- b. provide 50 ohm/ 50uH of coupling impedance for the measuring instrument.
- c. Both lines of the power mains connected to the EUT were checked for maximum conducted interference.
- d. The frequency range from 150kHz to 30MHz was searched. Emission level under (Limit – 20dB) was not recorded.

4.1.4 DEVIATION FROM TEST STANDARD

No deviation

4.1.5 TEST SETUP

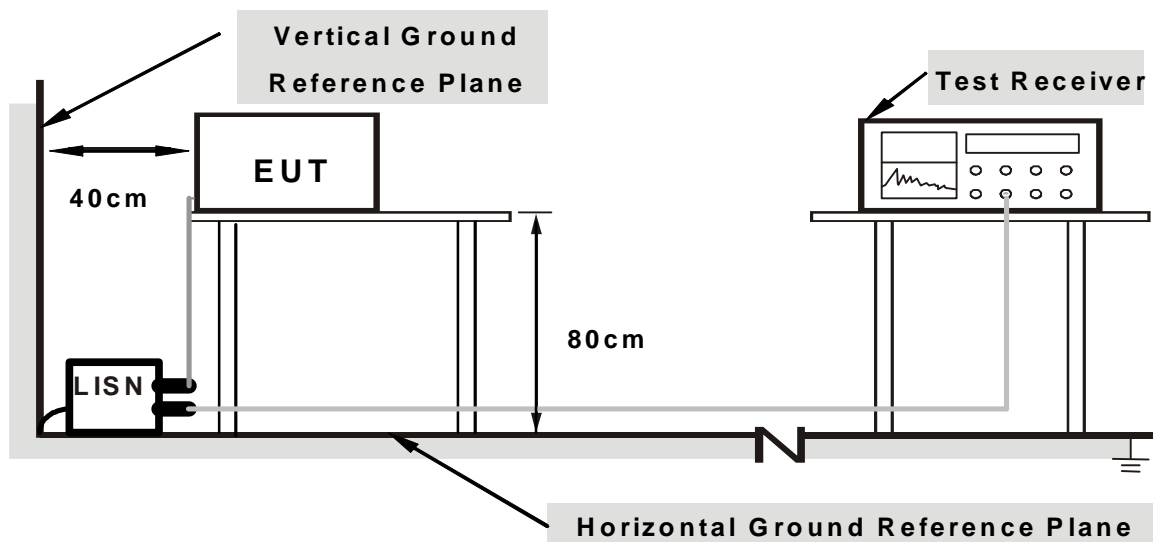

Note: 1.Support units were connected to second LISN.

2.Both of LISNs (AMN) are 80 cm from EUT and at least 80 from other units and other metal planes

For the actual test configuration, please refer to the related item – Photographs of the Test Configuration.

4.1.6 EUT OPERATING CONDITIONS

1. Placed the EUT on testing table.
2. Prepared other computer system (support unit 1) to act as communication partners and placed them outside of testing area.
3. The communication partners ran test program “2.4GHz WL COMMANDS.txt” to enable EUT under transmission/receiving condition continuously via one UTP cable transmission.

4.1.7 TEST RESULTS (With adapter 1)

PHASE	Line (L)	6dB BANDWIDTH	9 kHz
--------------	----------	----------------------	-------

No	Freq. [MHz]	Corr. Factor (dB)	Reading Value		Emission Level		Limit		Margin	
			[dB (uV)]		[dB (uV)]		[dB (uV)]		(dB)	
			Q.P.	AV.	Q.P.	AV.	Q.P.	AV.	Q.P.	AV.
1	0.185	0.36	42.81	-	43.17	-	64.25	54.25	-21.08	-
2	0.314	0.36	44.12	-	44.48	-	59.86	49.86	-15.38	-
3	0.388	0.36	46.75	-	47.11	-	58.11	48.11	-11.00	-
4	0.775	0.39	45.72	39.75	46.11	40.14	56.00	46.00	-9.89	-5.86
5	3.961	0.51	44.69	-	45.20	-	56.00	46.00	-10.80	-
6	18.305	1.03	38.69	-	39.72	-	60.00	50.00	-20.28	-

- REMARKS:**
1. Q.P. and AV. are abbreviations of quasi-peak and average individually.
 2. "-": The Quasi-peak reading value also meets average limit and measurement with the average detector is unnecessary.
 3. The emission levels of other frequencies were very low against the limit.
 4. Margin value = Emission level - Limit value
 5. Correction factor = Insertion loss + Cable loss
 6. Emission Level = Correction Factor + Reading Value.

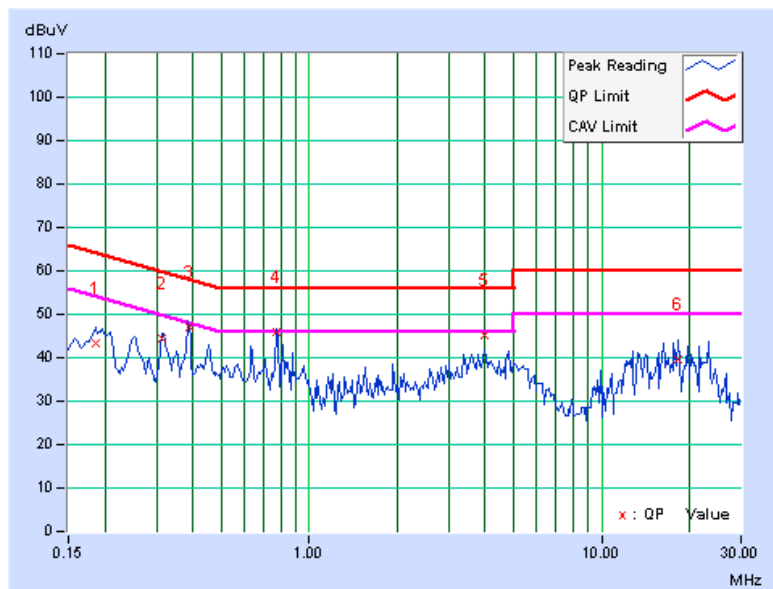



A D T

PHASE	Neutral (N)	6dB BANDWIDTH	9 kHz
-------	-------------	---------------	-------

No	Freq. [MHz]	Corr. Factor (dB)	Reading Value [dB (uV)]		Emission Level [dB (uV)]		Limit [dB (uV)]		Margin (dB)	
			Q.P.	AV.	Q.P.	AV.	Q.P.	AV.	Q.P.	AV.
			1	0.177	0.10	38.65	-	38.75	-	64.61
2	0.318	0.11	41.28	-	41.39	-	59.76	49.76	-18.37	-
3	0.388	0.11	43.71	-	43.82	-	58.10	48.10	-14.28	-
4	0.634	0.13	38.15	-	38.28	-	56.00	46.00	-17.72	-
5	0.775	0.14	42.57	-	42.71	-	56.00	46.00	-13.29	-
6	3.234	0.22	39.87	-	40.09	-	56.00	46.00	-15.91	-

- REMARKS:**
1. Q.P. and AV. are abbreviations of quasi-peak and average individually.
 2. "-": The Quasi-peak reading value also meets average limit and measurement with the average detector is unnecessary.
 3. The emission levels of other frequencies were very low against the limit.
 4. Margin value = Emission level - Limit value
 5. Correction factor = Insertion loss + Cable loss
 6. Emission Level = Correction Factor + Reading Value.

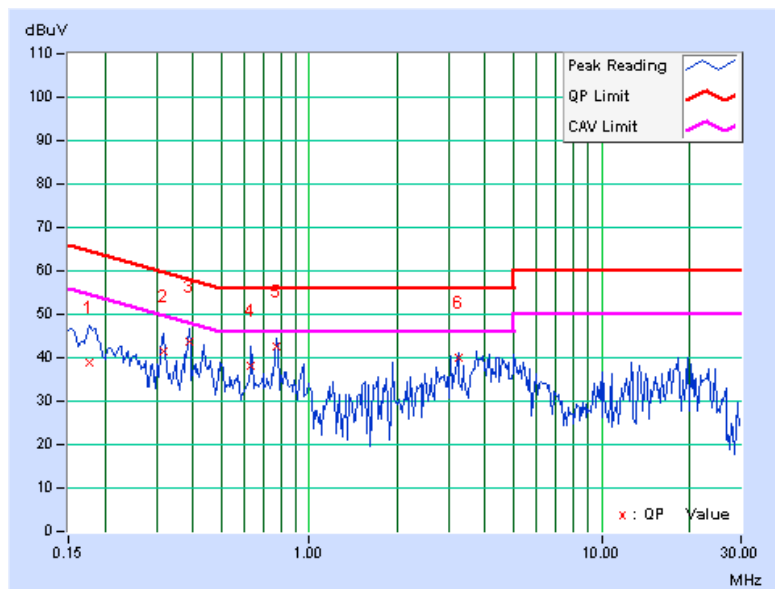



A D T

4.1.8 TEST RESULTS (With adapter 2)

PHASE	Line (L)	6dB BANDWIDTH	9 kHz
-------	----------	---------------	-------

No	Freq.	Corr.	Reading Value		Emission Level		Limit		Margin	
	[MHz]	Factor	[dB (uV)]		[dB (uV)]		[dB (uV)]		(dB)	
		(dB)	Q.P.	AV.	Q.P.	AV.	Q.P.	AV.	Q.P.	AV.
1	0.154	0.36	43.51	-	43.87	-	65.76	55.76	-21.88	-
2	0.314	0.36	43.55	-	43.91	-	59.86	49.86	-15.95	-
3	0.775	0.39	33.24	-	33.63	-	56.00	46.00	-22.37	-
4	11.949	0.81	33.73	-	34.54	-	60.00	50.00	-25.46	-
5	18.305	1.03	39.90	-	40.93	-	60.00	50.00	-19.07	-
6	26.484	1.39	35.26	-	36.65	-	60.00	50.00	-23.35	-

- REMARKS:**
1. Q.P. and AV. are abbreviations of quasi-peak and average individually.
 2. "-": The Quasi-peak reading value also meets average limit and measurement with the average detector is unnecessary.
 3. The emission levels of other frequencies were very low against the limit.
 4. Margin value = Emission level - Limit value
 5. Correction factor = Insertion loss + Cable loss
 6. Emission Level = Correction Factor + Reading Value.

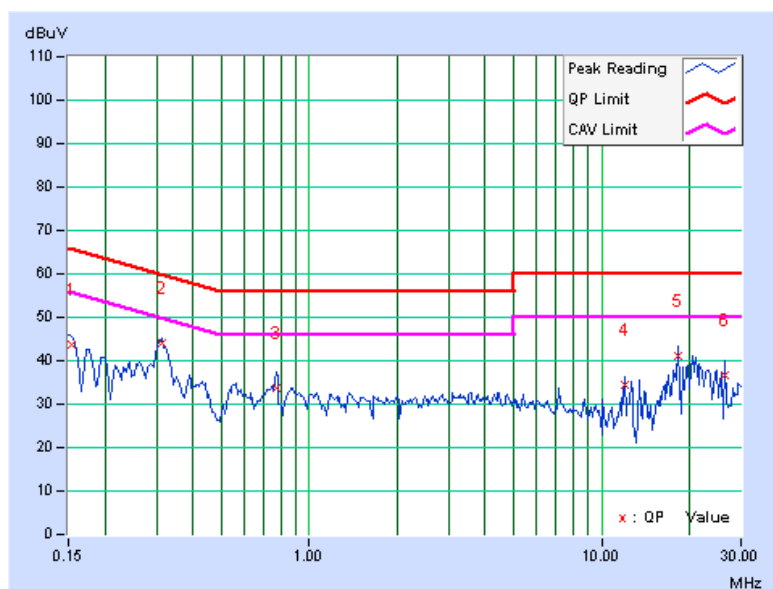



A D T

PHASE	Neutral (N)	6dB BANDWIDTH	9 kHz
-------	-------------	---------------	-------

No	Freq.	Corr.	Reading Value		Emission Level		Limit		Margin	
	[MHz]	Factor (dB)	Q.P.	AV.	Q.P.	AV.	Q.P.	AV.	Q.P.	AV.
			[dB (uV)]		[dB (uV)]		[dB (uV)]		(dB)	
1	0.150	0.10	39.60	-	39.70	-	66.00	56.00	-26.30	-
2	0.310	0.11	39.84	-	39.95	-	59.97	49.97	-20.02	-
3	0.775	0.14	32.54	-	32.68	-	56.00	46.00	-23.32	-
4	18.242	1.06	39.25	-	40.31	-	60.00	50.00	-19.69	-
5	19.586	1.11	35.18	-	36.29	-	60.00	50.00	-23.71	-
6	23.133	1.40	34.56	-	35.96	-	60.00	50.00	-24.04	-

- REMARKS:**
1. Q.P. and AV. are abbreviations of quasi-peak and average individually.
 2. "-": The Quasi-peak reading value also meets average limit and measurement with the average detector is unnecessary.
 3. The emission levels of other frequencies were very low against the limit.
 4. Margin value = Emission level - Limit value
 5. Correction factor = Insertion loss + Cable loss
 6. Emission Level = Correction Factor + Reading Value.

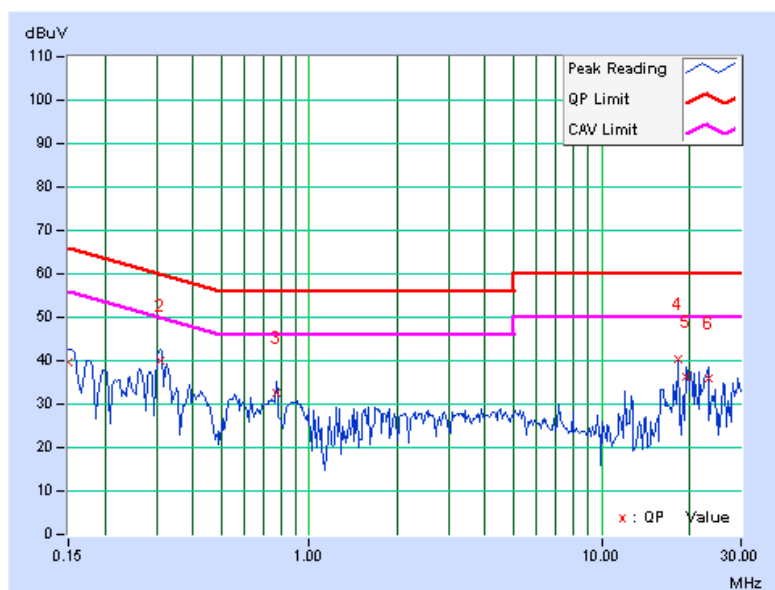

4.2 RADIATED EMISSION MEASUREMENT

4.2.1 LIMITS OF RADIATED EMISSION MEASUREMENT

Emissions radiated outside of the specified bands, shall be according to the general radiated limits in 15.209 as following:

Frequencies (MHz)	Field strength (microvolts/meter)	Measurement distance (meters)
0.009-0.490	2400/F(kHz)	300
0.490-1.705	24000/F(kHz)	30
1.705-30.0	30	30
30-88	100	3
88-216	150	3
216-960	200	3
Above 960	500	3

NOTE:

1. The lower limit shall apply at the transition frequencies.
2. Emission level (dBuV/m) = 20 log Emission level (uV/m).
3. As shown in 15.35(b), for frequencies above 1000MHz, the field strength limits are based on average detector, however, the peak field strength of any emission shall not exceed the maximum permitted average limits, specified above by more than 20dB under any condition of modulation.
4. Section 15.205 restricted bands of operation shall compliance with the limits in Section 15.209.



A D T

4.2.2 LIMITS OF UNWANTED EMISSION OUT OF THE RESTRICTED BANDS

Frequencies (MHz)	EIRP Limit (dBm)	Equivalent Field Strength at 3m (dB μ V/m) *note 3
5150~5250	-27	68.3
5250~5350	-27	68.3
5470~5725	-27	68.3
5725~5825	-27 *note 1	68.3
	-17 *note 2	78.3

NOTE:

1. For frequencies 10MHz or greater above or below the band edge.
2. All emissions within the frequency range from the band edge to 10MHz above or below the band edge.
3. The following formula is used to convert the equipment isotropic radiated power (eirp) to field strength

$$E = \frac{1000000\sqrt{30P}}{3} \mu\text{V/m, where P is the eirp (Watts)}$$



A D T

4.2.3 TEST INSTRUMENTS

Below 1GHz test:

DESCRIPTION & MANUFACTURER	MODEL NO.	SERIAL NO.	CALIBRATED DATE	CALIBRATED UNTIL
Agilent Spectrum Analyzer	E4446A	MY48250253	Aug. 23, 2010	Aug. 22, 2011
Agilent Pre-Selector	N9039A	MY46520310	Aug. 23, 2010	Aug. 22, 2011
Agilent Signal Generator	N5181A	MY49060347	July 30, 2010	July 29, 2011
LIG NEX1 Test Receiver	ER-265	L09068005	Oct. 25, 2010	Oct. 24, 2011
Mini-Circuits Pre-Amplifier	ZFL-1000VH2B	AMP-ZFL-04	Nov. 16, 2010	Nov. 15, 2011
Agilent Pre-Amplifier	8449B	3008A02465	Feb. 28, 2011	Feb. 27, 2012
Miteq Pre-Amplifier	AFS33-1800265 0-30-8P-44	881786	NA	NA
SCHWARZBECK Trilog Broadband Antenna	VULB 9168	9168-361	Apr. 14, 2011	Apr. 13, 2012
AISI Horn_Antenna	AIH.8018	0000220091110	Nov. 22, 2010	Nov. 21, 2011
SCHWARZBECK Horn_Antenna	BBHA 9170	9170-424	Oct. 08, 2010	Oct. 07, 2011
RF CABLE	NA	RF104-205 RF104-207 RF104-202	Dec. 28, 2010	Dec. 27, 2011
RF Cable	NA	CHHCAB_001	NA	NA
Software	ADT_Radiated_V8.7.05	NA	NA	NA
CT Antenna Tower & Turn Table	NA	NA	NA	NA

- Note: 1. The calibration interval of the above test instruments is 12 months and the calibrations are traceable to NML/ROC and NIST/USA.
2. The horn antenna, preamplifier (model: 8449B) are used only for the measurement of emission frequency above 1GHz if tested.
3. The test was performed in 966 Chamber No. H.
4. The FCC Site Registration No. is 797305.
5. The CANADA Site Registration No. is IC 7450H-3.



A D T

Above 1GHz test:

DESCRIPTION & MANUFACTURER	MODEL NO.	SERIAL NO.	CALIBRATED DATE	CALIBRATED UNTIL
Agilent Spectrum Analyzer	E4446A	MY48250254	July 14, 2010	July 13, 2011
Agilent Pre-Selector	N9039A	MY46520311	July 14, 2010	July 13, 2011
Agilent Signal Generator	N5181A	MY49060517	July 14, 2010	July 13, 2011
Mini-Circuits Pre-Amplifier	ZFL-1000VH2B	AMP-ZFL-03	Nov. 16, 2010	Nov. 15, 2011
Agilent Pre-Amplifier	8449B	3008A02578	July 05, 2010	July 04, 2011
Miteq Pre-Amplifier	AFS33-1800265 0-30-8P-44	881786	NA	NA
SCHWARZBECK Trilog Broadband Antenna	VULB 9168	9168-360	Apr. 29, 2010	Apr. 28, 2011
AISI Horn_Antenna	AIH.8018	0000320091110	Nov. 12, 2010	Nov. 11, 2011
SCHWARZBECK Horn_Antenna	BBHA 9170	9170-424	Oct. 08, 2010	Oct. 07, 2011
RF CABLE	NA	RF104-201 RF104-203 RF104-204	Dec. 27, 2010	Dec. 26, 2011
RF Cable	NA	CHGCAB_001	NA	NA
Software	ADT_Radiated_V8.7.05	NA	NA	NA
CT Antenna Tower & Turn Table	NA	NA	NA	NA

Note: 1. The calibration interval of the above test instruments is 12 months and the calibrations are traceable to NML/ROC and NIST/USA.

2. The horn antenna, preamplifier (model: 8449B) are used only for the measurement of emission frequency above 1GHz if tested.
3. The test was performed in 966 Chamber No. G.
4. The FCC Site Registration No. is 966073.
5. The VCCI Site Registration No. is G-137.
6. The CANADA Site Registration No. is IC 7450H-2.

4.2.4 TEST PROCEDURES

- a. The EUT was placed on the top of a rotating table 0.8 meters above the ground at a 3 meter chamber room. The table was rotated 360 degrees to determine the position of the highest radiation.
- b. The EUT was set 3 meters away from the interference-receiving antenna, which was mounted on the top of a variable-height antenna tower.
- c. The height of antenna is varied from one meter to four meters above the ground to determine the maximum value of the field strength. Both horizontal and vertical polarizations of the antenna are set to make the measurement.
- d. For each suspected emission, the EUT was arranged to its worst case and then the antenna was tuned to heights from 1 meter to 4 meters and the rotatable table was turned from 0 degrees to 360 degrees to find the maximum reading.
- e. The test-receiver system was set to quasi-peak detect function and specified bandwidth with maximum hold mode when the test frequency is below 1 GHz.
- f. The test-receiver system was set to peak and average detect function and specified bandwidth with maximum hold mode when the test frequency is above 1 GHz. If the peak reading value also meets average limit, measurement with the average detector is unnecessary.

NOTE:

1. The resolution bandwidth and video bandwidth of test receiver/spectrum analyzer is 120kHz for Quasi-peak detection (QP) at frequency below 1GHz.
2. The resolution bandwidth of test receiver/spectrum analyzer is 1 MHz and the video bandwidth is 3 MHz for Peak detection (PK) at frequency above 1GHz.
3. The resolution bandwidth of test receiver/spectrum analyzer is 1 MHz and the video bandwidth is 10 Hz for Average detection (AV) at frequency above 1GHz.

4.2.5 DEVIATION FROM TEST STANDARD

No deviation

4.2.6 TEST SETUP

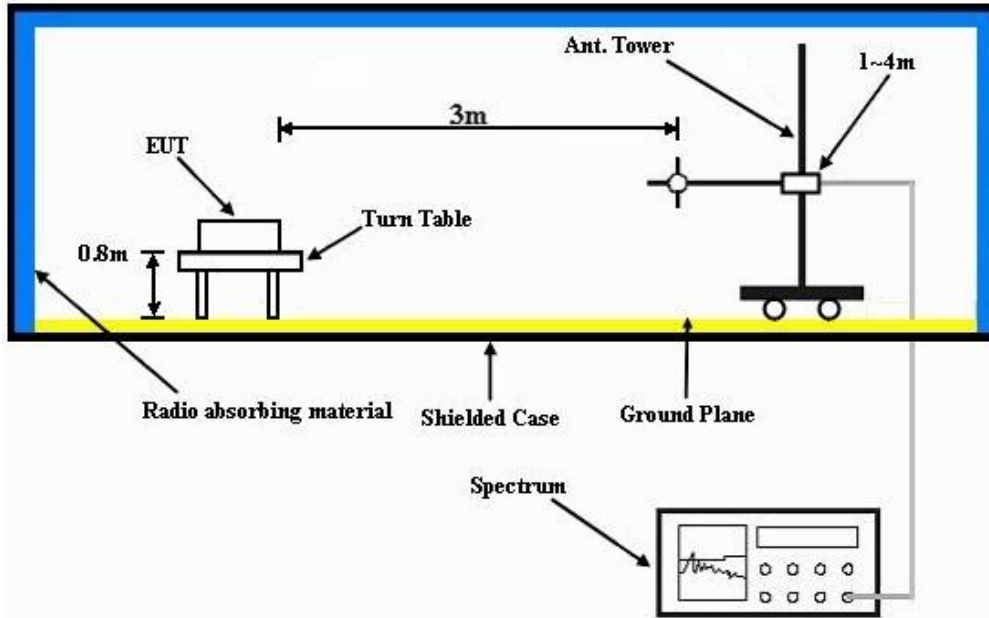

For the actual test configuration, please refer to the related item – Photographs of the Test Configuration.

4.2.7 EUT OPERATING CONDITION

Same as 4.1.6



A D T

4.2.8 TEST RESULTS

BELOW 1GHz WORST-CASE DATA : 802.11n (20MHz) OFDM MODULATION

EUT TEST CONDITION		MEASUREMENT DETAIL	
CHANNEL	Channel 48	FREQUENCY RANGE	Below 1000MHz
INPUT POWER	120Vac, 60 Hz	DETECTOR FUNCTION	Quasi-Peak
ENVIRONMENTAL CONDITIONS	22deg. C, 61%RH 1023 hPa	TESTED BY	Kent Liu

ANTENNA POLARITY & TEST DISTANCE: HORIZONTAL AT 3 M								
NO.	FREQ. (MHz)	EMISSION LEVEL (dBuV/m)	LIMIT (dBuV/m)	MARGIN (dB)	ANTENNA HEIGHT (m)	TABLE ANGLE (Degree)	RAW VALUE (dBuV)	CORRECTION FACTOR (dB/m)
1	106.90	27.2 QP	43.5	-16.3	1.25 H	223	16.85	10.37
2	125.00	28.4 QP	43.5	-15.1	1.00 H	0	15.55	12.81
3	149.70	32.9 QP	43.5	-10.6	1.25 H	339	18.41	14.48
4	189.90	34.1 QP	43.5	-9.4	1.25 H	301	22.13	11.98
5	250.00	37.0 QP	46.0	-9.0	1.00 H	32	23.96	13.04
6	530.00	29.1 QP	46.0	-16.9	1.00 H	224	8.93	20.18
ANTENNA POLARITY & TEST DISTANCE: VERTICAL AT 3 M								
NO.	FREQ. (MHz)	EMISSION LEVEL (dBuV/m)	LIMIT (dBuV/m)	MARGIN (dB)	ANTENNA HEIGHT (m)	TABLE ANGLE (Degree)	RAW VALUE (dBuV)	CORRECTION FACTOR (dB/m)
1	47.76	36.3 QP	40.0	-3.7	1.00 V	197	22.12	14.20
2	60.20	34.2 QP	40.0	-5.8	1.00 V	241	20.76	13.43
3	189.63	29.2 QP	43.5	-14.3	1.00 V	330	17.24	12.00
4	250.03	35.4 QP	46.0	-10.6	1.50 V	347	22.38	13.04
5	529.98	31.6 QP	46.0	-14.4	1.00 V	65	11.38	20.18
6	811.23	31.2 QP	46.0	-14.9	1.00 V	360	6.52	24.63

- REMARKS:**
1. Emission level (dBuV/m) = Raw Value (dBuV) + Correction Factor (dB/m).
 2. Correction Factor (dB/m) = Antenna Factor (dB/m) + Cable Factor (dB).
 3. The other emission levels were very low against the limit.
 4. Margin value = Emission level – Limit value.



A D T

ABOVE 1GHz WORST-CASE DATA

802.11a OFDM MODULATION

EUT TEST CONDITION		MEASUREMENT DETAIL	
CHANNEL	Channel 36	FREQUENCY RANGE	1 ~ 40GHz
INPUT POWER	120Vac, 60 Hz	DETECTOR FUNCTION	Peak (PK) Average (AV)
ENVIRONMENTAL CONDITIONS	12deg. C, 64%RH 1023 hPa	TESTED BY	Frank Liu

ANTENNA POLARITY & TEST DISTANCE: HORIZONTAL AT 3 M								
NO.	FREQ. (MHz)	EMISSION LEVEL (dBuV/m)	LIMIT (dBuV/m)	MARGIN (dB)	ANTENNA HEIGHT (m)	TABLE ANGLE (Degree)	RAW VALUE (dBuV)	CORRECTION FACTOR (dB/m)
1	5150.00	66.2 PK	74.0	-7.8	1.00 H	10	26.18	40.02
2	5150.00	52.5 AV	54.0	-1.5	1.00 H	10	12.48	40.02
3	*5180.00	110.4 PK			1.00 H	103	70.32	40.08
4	*5180.00	101.2 AV			1.00 H	103	61.12	40.08
5	#10360.00	57.4 PK	68.3	-10.9	1.00 H	127	10.94	46.46
6	15540.00	61.3 PK	74.0	-12.7	1.50 H	37	9.86	51.44
7	15540.00	50.4 AV	54.0	-3.6	1.50 H	37	-1.04	51.44
ANTENNA POLARITY & TEST DISTANCE: VERTICAL AT 3 M								
NO.	FREQ. (MHz)	EMISSION LEVEL (dBuV/m)	LIMIT (dBuV/m)	MARGIN (dB)	ANTENNA HEIGHT (m)	TABLE ANGLE (Degree)	RAW VALUE (dBuV)	CORRECTION FACTOR (dB/m)
1	5150.00	67.2 PK	74.0	-6.8	1.05 V	153	27.18	40.02
2	5150.00	53.0 AV	54.0	-1.0	1.05 V	153	12.98	40.02
3	*5180.00	111.0 PK			1.01 V	169	70.92	40.08
4	*5180.00	101.0 AV			1.01 V	169	60.92	40.08
5	#10360.00	56.0 PK	68.3	-12.3	1.16 V	244	9.54	46.46
6	15540.00	64.0 PK	74.0	-10.0	1.00 V	84	12.56	51.44
7	15540.00	49.2 AV	54.0	-4.8	1.00 V	84	-2.24	51.44

- REMARKS:**
1. Emission level (dBuV/m) = Raw Value (dBuV) + Correction Factor (dB/m).
 2. Correction Factor (dB/m) = Antenna Factor (dB/m) + Cable Factor (dB).
 3. The other emission levels were very low against the limit.
 4. Margin value = Emission level – Limit value.
 5. “ * “: Fundamental frequency.
 6. "#":The radiated frequency is out the restricted band.



A D T

EUT TEST CONDITION		MEASUREMENT DETAIL	
CHANNEL	Channel 40	FREQUENCY RANGE	1 ~ 40GHz
INPUT POWER	120Vac, 60 Hz	DETECTOR FUNCTION	Peak (PK) Average (AV)
ENVIRONMENTAL CONDITIONS	12deg. C, 64%RH 1023 hPa	TESTED BY	Frank Liu

ANTENNA POLARITY & TEST DISTANCE: HORIZONTAL AT 3 M								
NO.	FREQ. (MHz)	EMISSION LEVEL (dBuV/m)	LIMIT (dBuV/m)	MARGIN (dB)	ANTENNA HEIGHT (m)	TABLE ANGLE (Degree)	RAW VALUE (dBuV)	CORRECTION FACTOR (dB/m)
1	*5200.00	112.0 PK			1.11 H	103	71.88	40.12
2	*5200.00	102.1 AV			1.11 H	103	61.98	40.12
3	#10400.00	59.4 PK	68.3	-8.9	1.08 H	139	12.92	46.48
4	15600.00	62.2 PK	74.0	-11.8	1.02 H	43	10.80	51.40
5	15600.00	51.1 AV	54.0	-2.9	1.02 H	43	-0.30	51.40
ANTENNA POLARITY & TEST DISTANCE: VERTICAL AT 3 M								
NO.	FREQ. (MHz)	EMISSION LEVEL (dBuV/m)	LIMIT (dBuV/m)	MARGIN (dB)	ANTENNA HEIGHT (m)	TABLE ANGLE (Degree)	RAW VALUE (dBuV)	CORRECTION FACTOR (dB/m)
1	*5200.00	110.8 PK			1.00 V	85	70.68	40.12
2	*5200.00	101.7 AV			1.00 V	85	61.58	40.12
3	#10400.00	57.2 PK	68.3	-11.1	1.14 V	97	10.72	46.48
4	15600.00	61.1 PK	74.0	-12.9	1.00 V	76	9.70	51.40
5	15600.00	49.4 AV	54.0	-4.6	1.00 V	76	-2.00	51.40

- REMARKS:**
1. Emission level (dBuV/m) = Raw Value (dBuV) + Correction Factor (dB/m).
 2. Correction Factor (dB/m) = Antenna Factor (dB/m) + Cable Factor (dB).
 3. The other emission levels were very low against the limit.
 4. Margin value = Emission level – Limit value.
 5. “ * “: Fundamental frequency.
 6. “ # “: The radiated frequency is out the restricted band.



A D T

EUT TEST CONDITION		MEASUREMENT DETAIL	
CHANNEL	Channel 48	FREQUENCY RANGE	1 ~ 40GHz
INPUT POWER	120Vac, 60 Hz	DETECTOR FUNCTION	Peak (PK) Average (AV)
ENVIRONMENTAL CONDITIONS	12deg. C, 64%RH 1023 hPa	TESTED BY	Frank Liu

ANTENNA POLARITY & TEST DISTANCE: HORIZONTAL AT 3 M								
NO.	FREQ. (MHz)	EMISSION LEVEL (dBuV/m)	LIMIT (dBuV/m)	MARGIN (dB)	ANTENNA HEIGHT (m)	TABLE ANGLE (Degree)	RAW VALUE (dBuV)	CORRECTION FACTOR (dB/m)
1	*5240.00	111.8 PK			1.09 H	97	71.55	40.25
2	*5240.00	101.2 AV			1.09 H	97	60.95	40.25
3	5350.00	59.1 PK	74.0	-14.9	1.09 H	97	18.53	40.57
4	5350.00	45.2 AV	54.0	-8.8	1.09 H	97	4.63	40.57
5	#10480.00	60.6 PK	68.3	-7.7	1.10 H	48	14.08	46.52
6	15720.00	62.6 PK	74.0	-11.4	1.04 H	20	11.27	51.33
7	15720.00	51.8 AV	54.0	-2.2	1.04 H	20	0.47	51.33

ANTENNA POLARITY & TEST DISTANCE: VERTICAL AT 3 M								
NO.	FREQ. (MHz)	EMISSION LEVEL (dBuV/m)	LIMIT (dBuV/m)	MARGIN (dB)	ANTENNA HEIGHT (m)	TABLE ANGLE (Degree)	RAW VALUE (dBuV)	CORRECTION FACTOR (dB/m)
1	*5240.00	110.4 PK			1.00 V	88	70.15	40.25
2	*5240.00	100.6 AV			1.00 V	88	60.35	40.25
3	5350.00	59.8 PK	74.0	-14.2	1.00 V	88	19.23	40.57
4	5350.00	45.3 AV	54.0	-8.7	1.00 V	88	4.73	40.57
5	#10480.00	57.8 PK	68.3	-10.5	1.10 V	80	11.28	46.52
6	15720.00	61.3 PK	74.0	-12.7	1.02 V	38	9.97	51.33
7	15720.00	50.1 AV	54.0	-3.9	1.02 V	38	-1.23	51.33

- REMARKS:**
1. Emission level (dBuV/m) = Raw Value (dBuV) + Correction Factor (dB/m).
 2. Correction Factor (dB/m) = Antenna Factor (dB/m) + Cable Factor (dB).
 3. The other emission levels were very low against the limit.
 4. Margin value = Emission level – Limit value.
 5. “ * “: Fundamental frequency.
 6. "#":The radiated frequency is out the restricted band.



A D T

RESTRICTED BANDEDGE (802.11a MODE, CH36, HORIZONTAL)

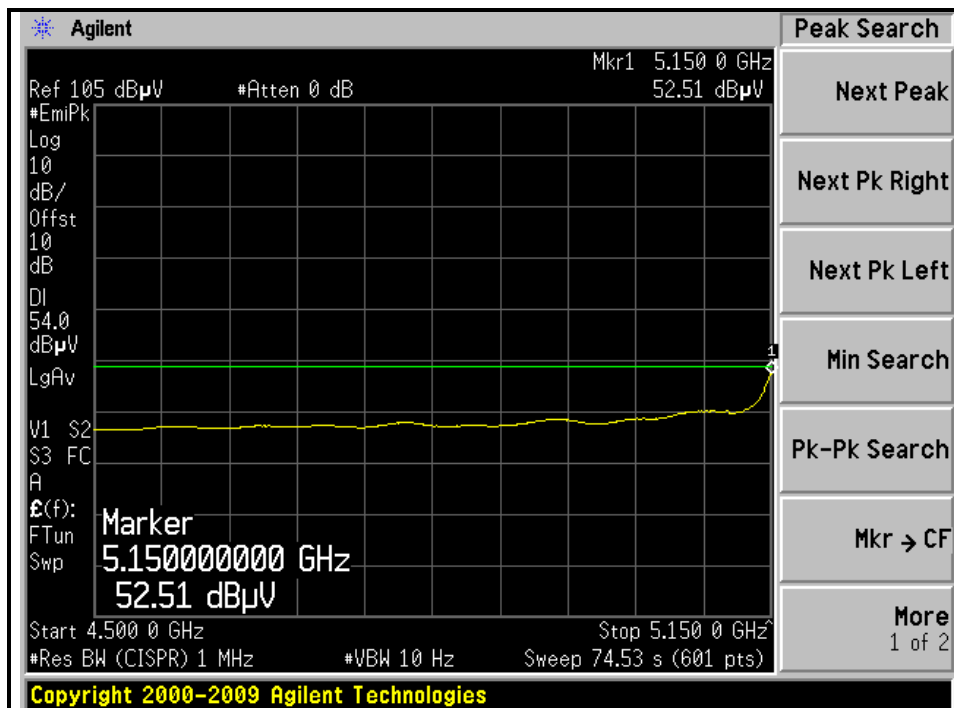
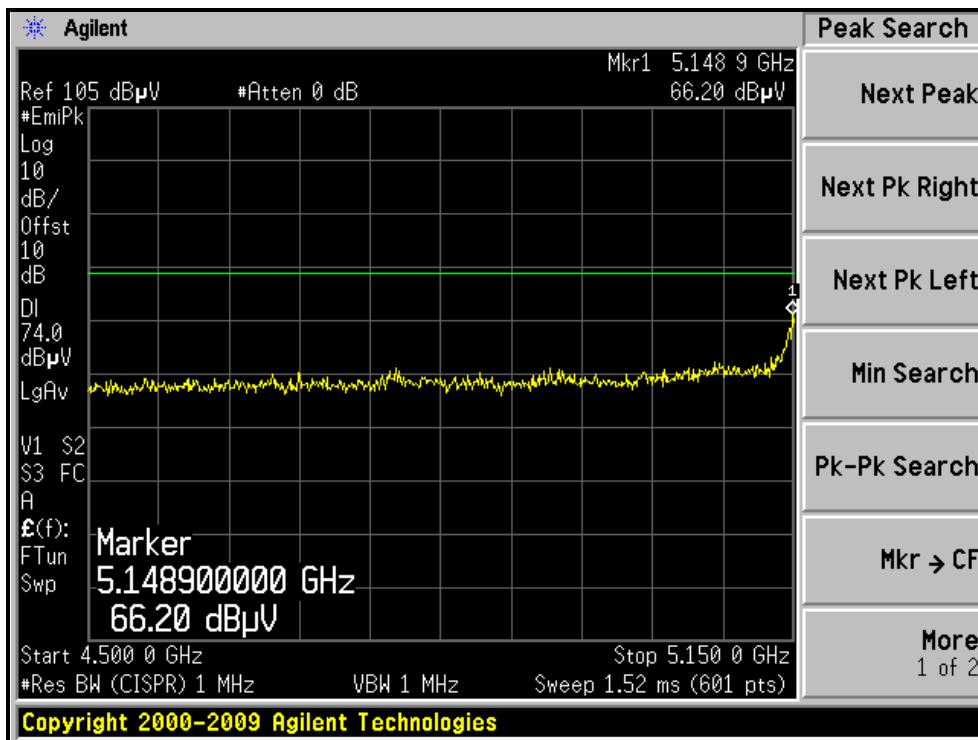



A D T

RESTRICTED BANDEDGE (802.11a MODE, CH36, VERTICAL)

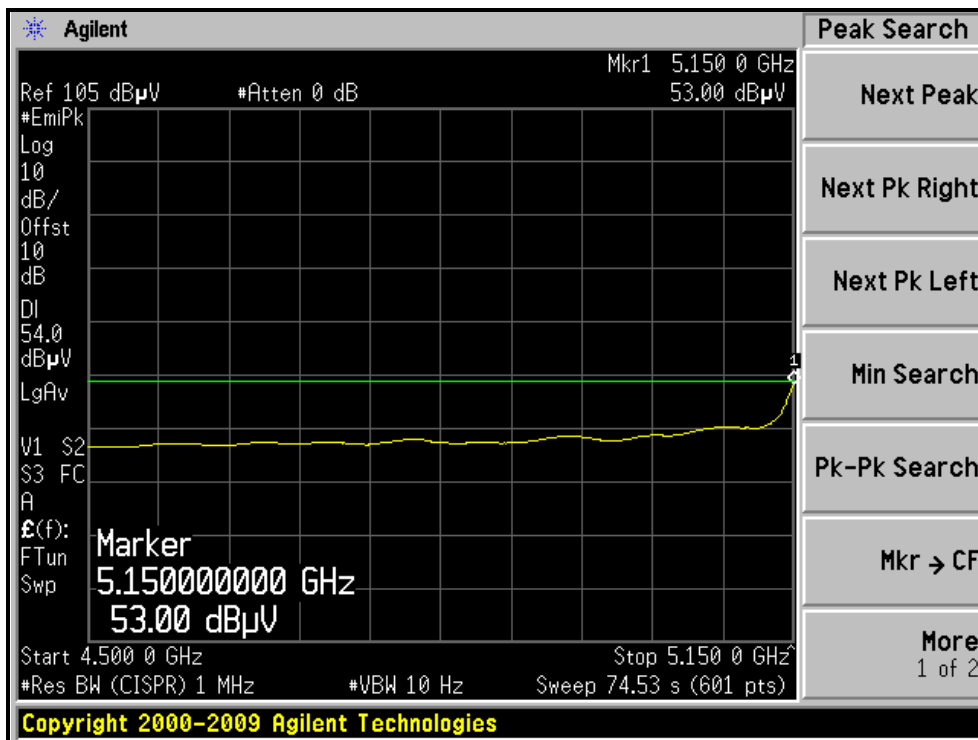
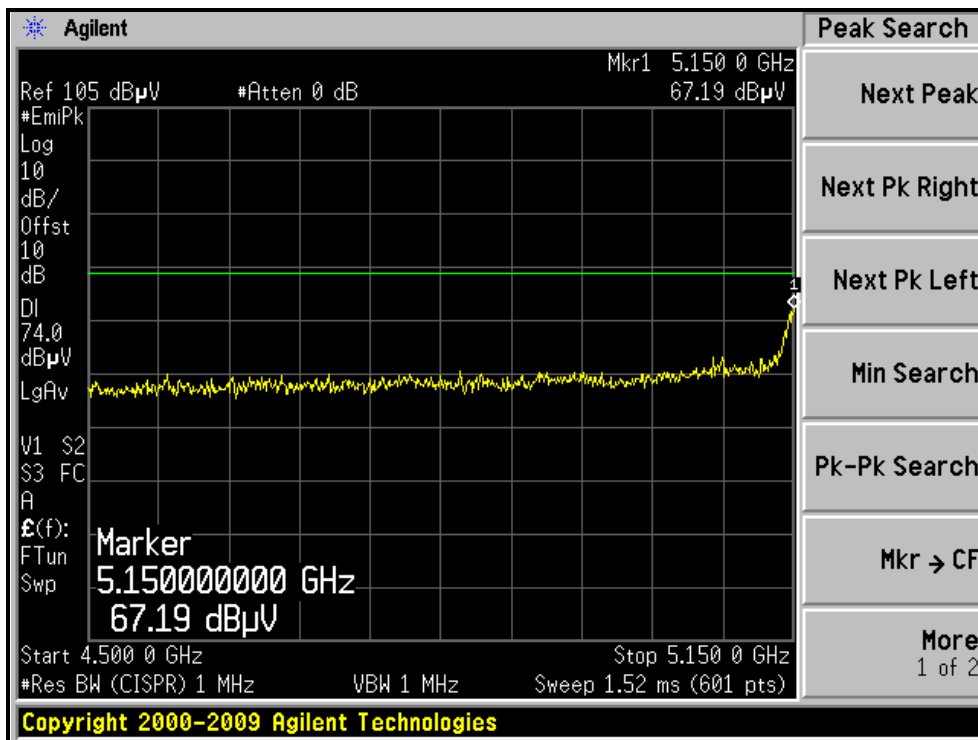



A D T

RESTRICTED BANDEDGE (802.11a MODE, CH48, HORIZONTAL)

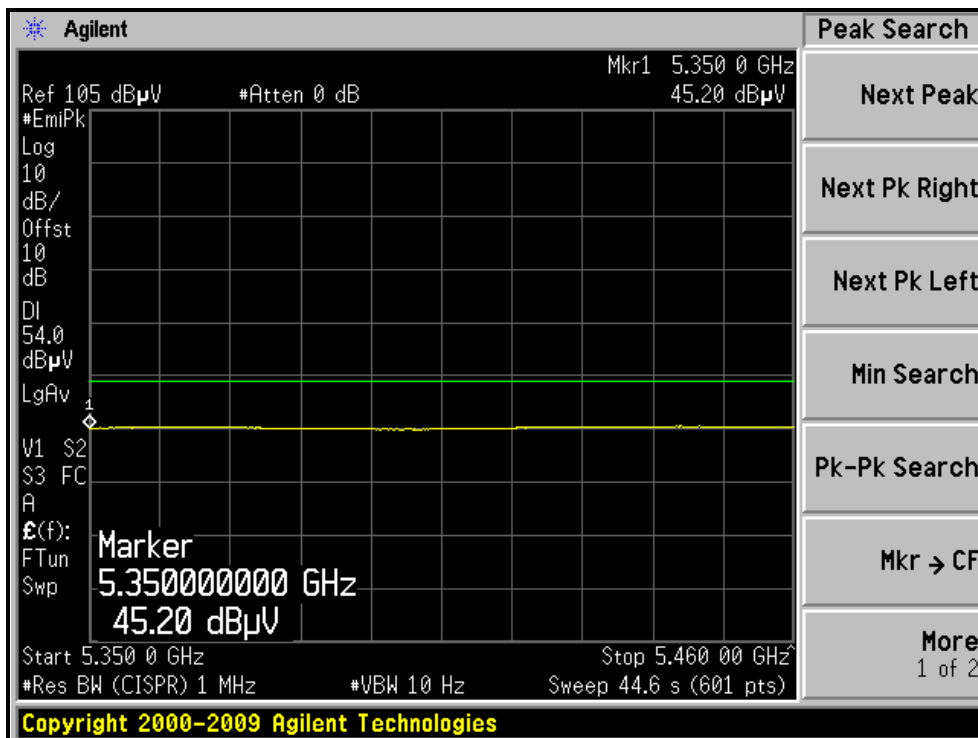
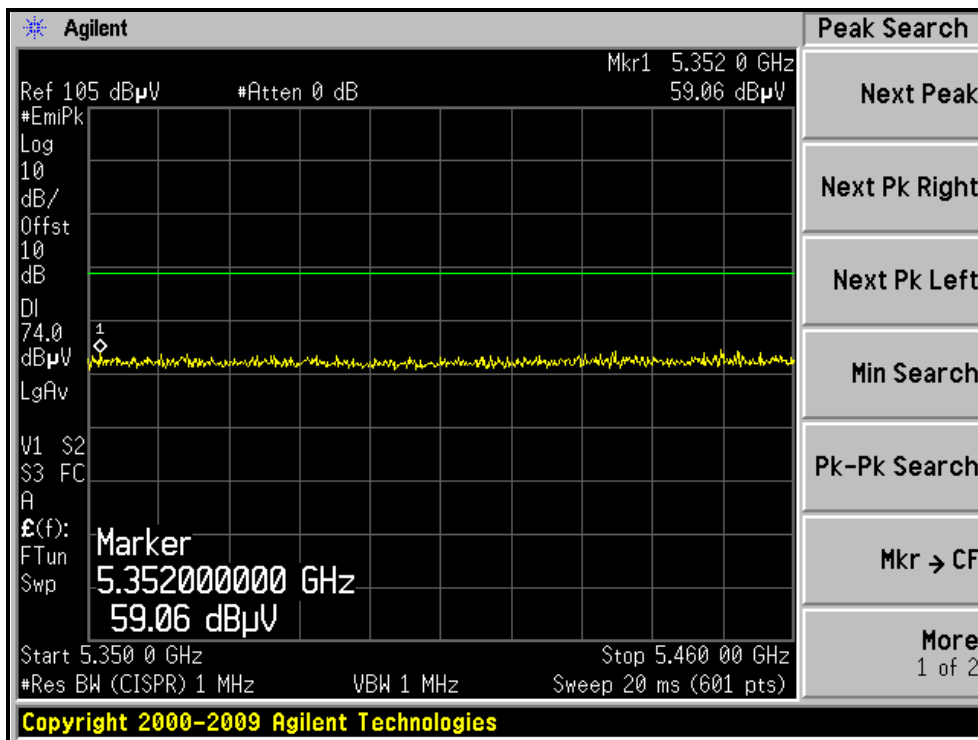



A D T

RESTRICTED BANDEDGE (802.11a MODE, CH48, VERTICAL)

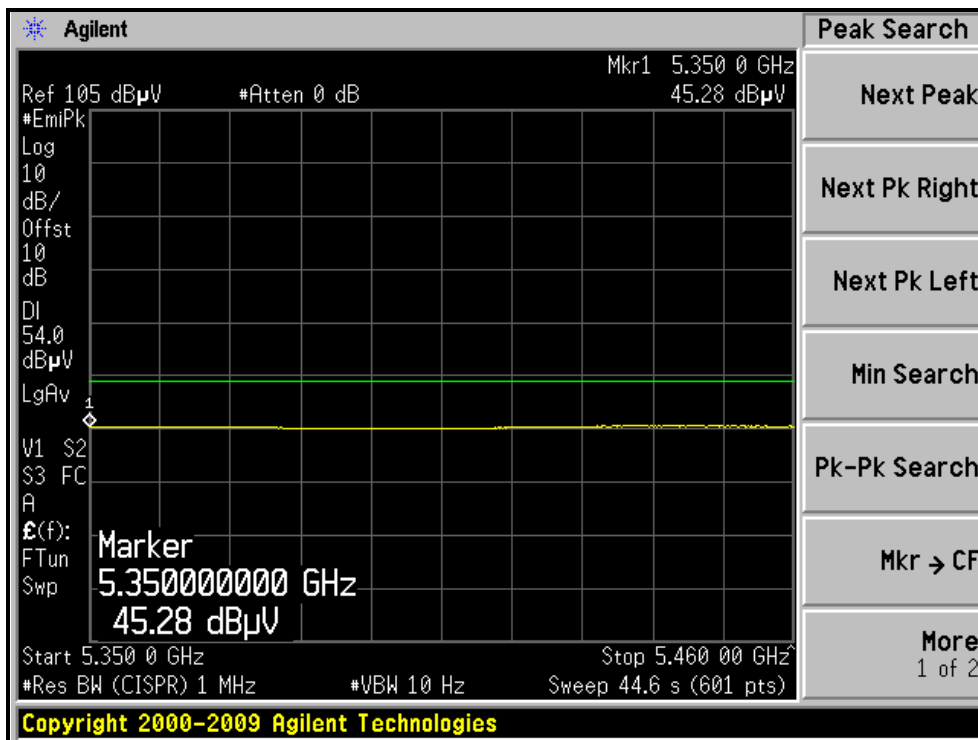
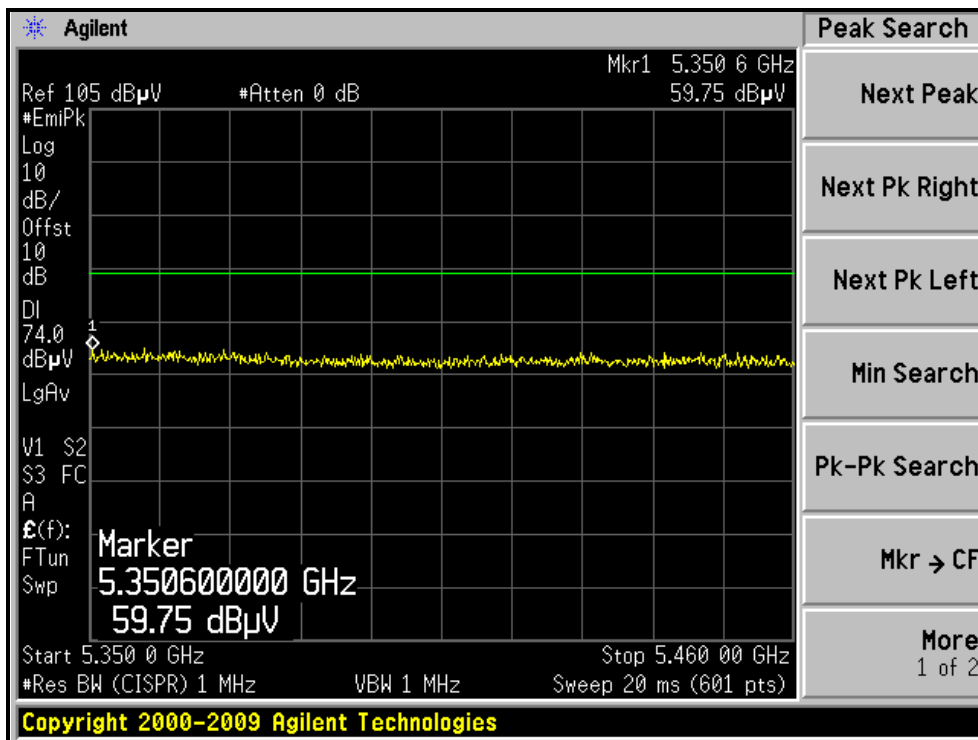



A D T

802.11n (20MHz) OFDM MODULATION

EUT TEST CONDITION		MEASUREMENT DETAIL	
CHANNEL	Channel 36	FREQUENCY RANGE	1 ~ 40GHz
INPUT POWER	120Vac, 60 Hz	DETECTOR FUNCTION	Peak (PK) Average (AV)
ENVIRONMENTAL CONDITIONS	12deg. C, 64%RH 1023 hPa	TESTED BY	Frank Liu

ANTENNA POLARITY & TEST DISTANCE: HORIZONTAL AT 3 M								
NO.	FREQ. (MHz)	EMISSION LEVEL (dBuV/m)	LIMIT (dBuV/m)	MARGIN (dB)	ANTENNA HEIGHT (m)	TABLE ANGLE (Degree)	RAW VALUE (dBuV)	CORRECTION FACTOR (dB/m)
1	5150.00	67.7 PK	74.0	-6.3	1.00 H	104	27.68	40.02
2	5150.00	52.4 AV	54.0	-1.6	1.00 H	104	12.38	40.02
3	*5180.00	109.8 PK			1.00 H	104	69.72	40.08
4	*5180.00	99.6 AV			1.00 H	104	59.52	40.08
5	#10360.00	56.2 PK	68.3	-12.1	1.00 H	126	9.74	46.46
6	15540.00	61.7 PK	74.0	-12.3	1.00 H	26	10.26	51.44
7	15540.00	50.2 AV	54.0	-3.8	1.00 H	26	-1.24	51.44

ANTENNA POLARITY & TEST DISTANCE: VERTICAL AT 3 M								
NO.	FREQ. (MHz)	EMISSION LEVEL (dBuV/m)	LIMIT (dBuV/m)	MARGIN (dB)	ANTENNA HEIGHT (m)	TABLE ANGLE (Degree)	RAW VALUE (dBuV)	CORRECTION FACTOR (dB/m)
1	5150.00	67.4 PK	74.0	-6.6	1.05 V	154	27.38	40.02
2	5150.00	53.0 AV	54.0	-1.0	1.05 V	154	12.98	40.02
3	*5180.00	109.4 PK			1.01 V	175	69.32	40.08
4	*5180.00	100.6 AV			1.01 V	175	60.52	40.08
5	#10360.00	54.3 PK	68.3	-14.0	1.16 V	241	7.84	46.46
6	15540.00	61.7 PK	74.0	-12.3	1.00 V	26	10.26	51.44
7	15540.00	49.7 AV	54.0	-4.3	1.00 V	26	-1.74	51.44

- REMARKS:**
1. Emission level (dBuV/m) = Raw Value (dBuV) + Correction Factor (dB/m).
 2. Correction Factor (dB/m) = Antenna Factor (dB/m) + Cable Factor (dB).
 3. The other emission levels were very low against the limit.
 4. Margin value = Emission level – Limit value.
 5. “ * “: Fundamental frequency.
 6. "#":The radiated frequency is out the restricted band.



A D T

EUT TEST CONDITION		MEASUREMENT DETAIL	
CHANNEL	Channel 40	FREQUENCY RANGE	1 ~ 40GHz
INPUT POWER	120Vac, 60 Hz	DETECTOR FUNCTION	Peak (PK) Average (AV)
ENVIRONMENTAL CONDITIONS	12deg. C, 64%RH 1023 hPa	TESTED BY	Frank Liu

ANTENNA POLARITY & TEST DISTANCE: HORIZONTAL AT 3 M								
NO.	FREQ. (MHz)	EMISSION LEVEL (dBuV/m)	LIMIT (dBuV/m)	MARGIN (dB)	ANTENNA HEIGHT (m)	TABLE ANGLE (Degree)	RAW VALUE (dBuV)	CORRECTION FACTOR (dB/m)
1	*5200.00	111.8 PK			1.00 H	103	71.68	40.12
2	*5200.00	101.5 AV			1.00 H	103	61.38	40.12
3	#10400.00	58.9 PK	68.3	-9.4	1.04 H	87	12.42	46.48
4	15600.00	62.4 PK	74.0	-11.6	1.05 H	42	11.00	51.40
5	15600.00	51.0 AV	54.0	-3.0	1.05 H	42	-0.40	51.40
ANTENNA POLARITY & TEST DISTANCE: VERTICAL AT 3 M								
NO.	FREQ. (MHz)	EMISSION LEVEL (dBuV/m)	LIMIT (dBuV/m)	MARGIN (dB)	ANTENNA HEIGHT (m)	TABLE ANGLE (Degree)	RAW VALUE (dBuV)	CORRECTION FACTOR (dB/m)
1	*5200.00	113.4 PK			1.14 V	174	73.28	40.12
2	*5200.00	102.0 AV			1.14 V	174	61.88	40.12
3	#10400.00	57.1 PK	68.3	-11.2	1.14 V	137	10.62	46.48
4	15600.00	61.2 PK	74.0	-12.8	1.00 V	32	9.80	51.40
5	15600.00	49.5 AV	54.0	-4.5	1.00 V	32	-1.90	51.40

- REMARKS:**
1. Emission level (dBuV/m) = Raw Value (dBuV) + Correction Factor (dB/m).
 2. Correction Factor (dB/m) = Antenna Factor (dB/m) + Cable Factor (dB).
 3. The other emission levels were very low against the limit.
 4. Margin value = Emission level – Limit value.
 5. “ * “: Fundamental frequency.
 6. “ # “: The radiated frequency is out the restricted band.



A D T

EUT TEST CONDITION		MEASUREMENT DETAIL	
CHANNEL	Channel 48	FREQUENCY RANGE	1 ~ 40GHz
INPUT POWER	120Vac, 60 Hz	DETECTOR FUNCTION	Peak (PK) Average (AV)
ENVIRONMENTAL CONDITIONS	12deg. C, 64%RH 1023 hPa	TESTED BY	Frank Liu

ANTENNA POLARITY & TEST DISTANCE: HORIZONTAL AT 3 M

NO.	FREQ. (MHz)	EMISSION LEVEL (dBuV/m)	LIMIT (dBuV/m)	MARGIN (dB)	ANTENNA HEIGHT (m)	TABLE ANGLE (Degree)	RAW VALUE (dBuV)	CORRECTION FACTOR (dB/m)
1	*5240.00	112.2 PK			1.00 H	102	71.95	40.25
2	*5240.00	101.6 AV			1.00 H	102	61.35	40.25
3	5350.00	58.9 PK	74.0	-15.1	1.00 H	102	18.33	40.57
4	5350.00	45.8 AV	54.0	-8.2	1.00 H	102	5.23	40.57
5	#10480.00	59.9 PK	68.3	-8.4	1.12 H	72	13.38	46.52
6	15720.00	62.8 PK	74.0	-11.2	1.06 H	22	11.47	51.33
7	15720.00	51.2 AV	54.0	-2.8	1.06 H	22	-0.13	51.33

ANTENNA POLARITY & TEST DISTANCE: VERTICAL AT 3 M

NO.	FREQ. (MHz)	EMISSION LEVEL (dBuV/m)	LIMIT (dBuV/m)	MARGIN (dB)	ANTENNA HEIGHT (m)	TABLE ANGLE (Degree)	RAW VALUE (dBuV)	CORRECTION FACTOR (dB/m)
1	*5240.00	114.0 PK			1.13 V	169	73.75	40.25
2	*5240.00	102.7 AV			1.13 V	169	62.45	40.25
3	5350.00	60.3 PK	74.0	-13.7	1.00 V	169	19.73	40.57
4	5350.00	46.9 AV	54.0	-7.1	1.00 V	169	6.33	40.57
5	#10480.00	57.8 PK	68.3	-10.5	1.12 V	84	11.28	46.52
6	15720.00	61.5 PK	74.0	-12.5	1.00 V	52	10.17	51.33
7	15720.00	50.2 AV	54.0	-3.8	1.00 V	52	-1.13	51.33

- REMARKS:**
1. Emission level (dBuV/m) = Raw Value (dBuV) + Correction Factor (dB/m).
 2. Correction Factor (dB/m) = Antenna Factor (dB/m) + Cable Factor (dB).
 3. The other emission levels were very low against the limit.
 4. Margin value = Emission level – Limit value.
 5. “ * “: Fundamental frequency.
 6. "#":The radiated frequency is out the restricted band.



A D T

RESTRICTED BANDEDGE (802.11n (20MHz) MODE,CH36, HORIZONTAL)

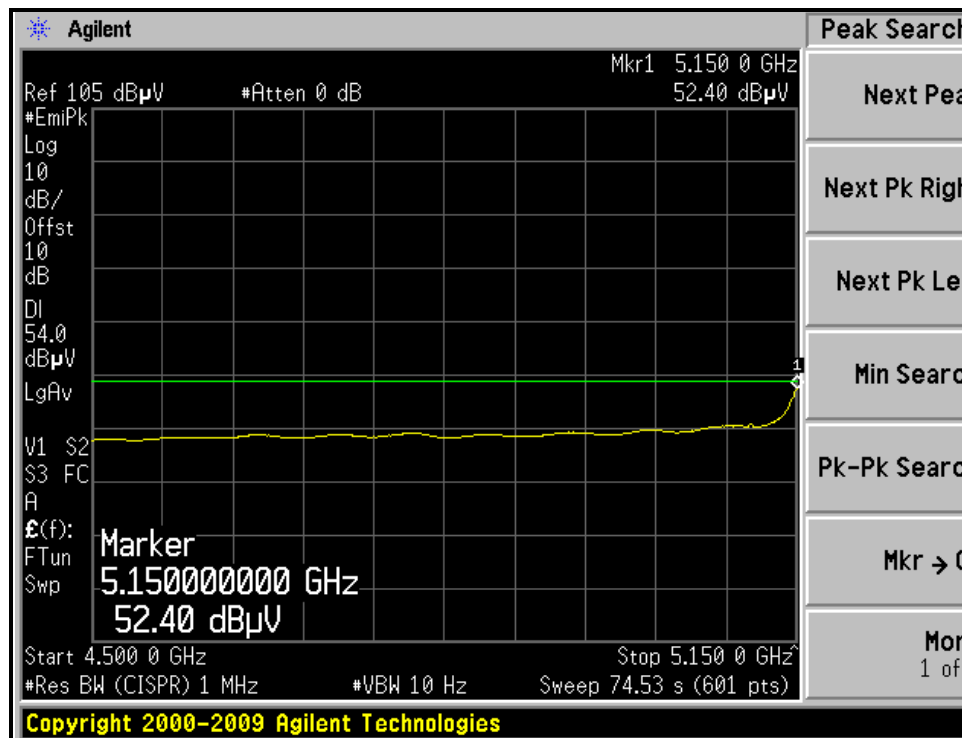
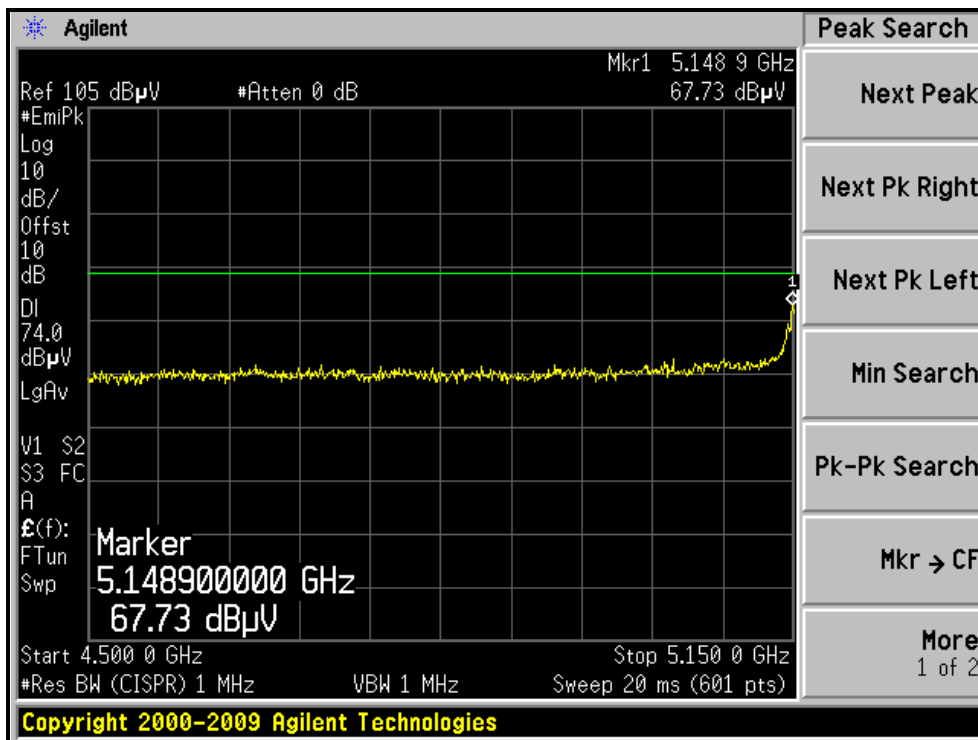



A D T

RESTRICTED BANDEDGE (802.11n (20MHz) MODE,CH36, VERTICAL)

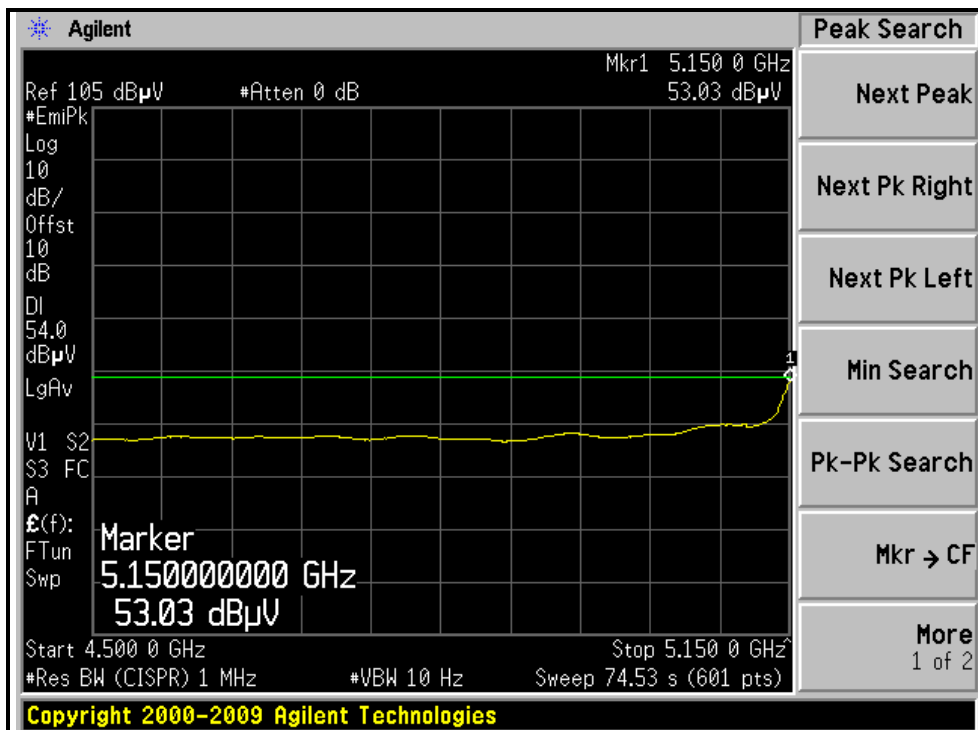
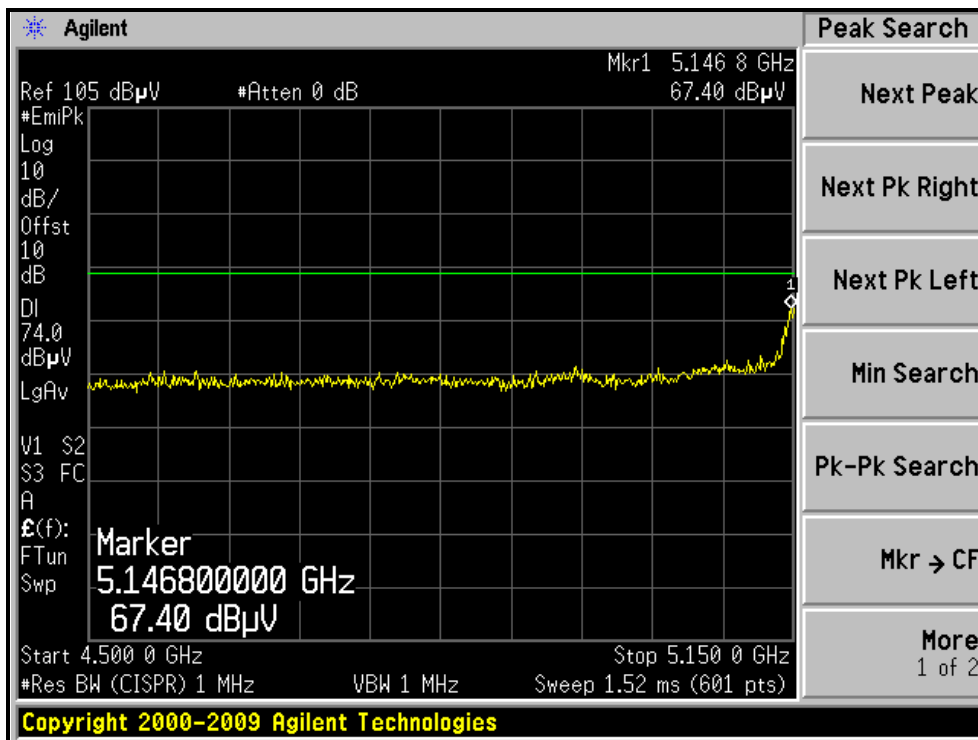



A D T

RESTRICTED BANDEDGE (802.11n (20MHz) MODE,CH48, HORIZONTAL)

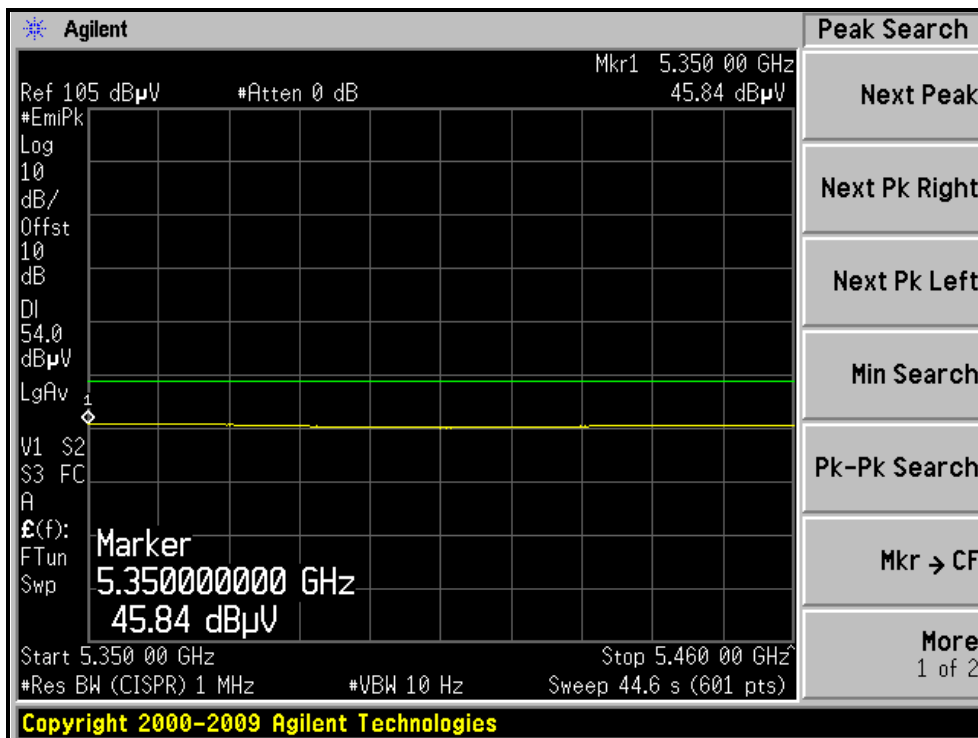
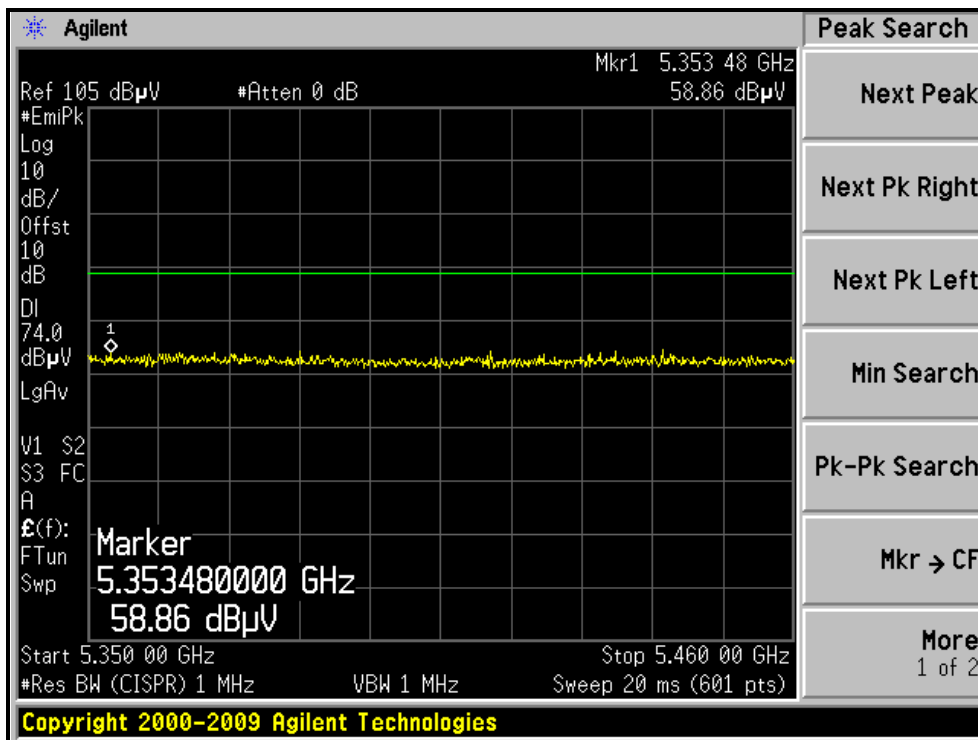



A D T

RESTRICTED BANDEDGE (802.11n (20MHz) MODE,CH48, VERTICAL)

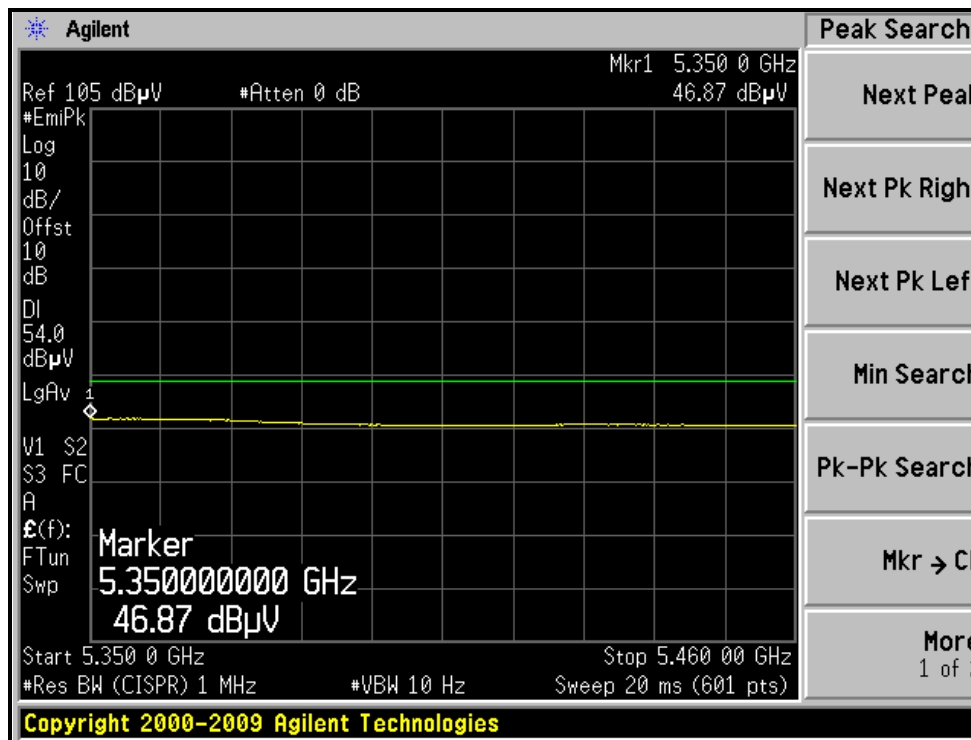
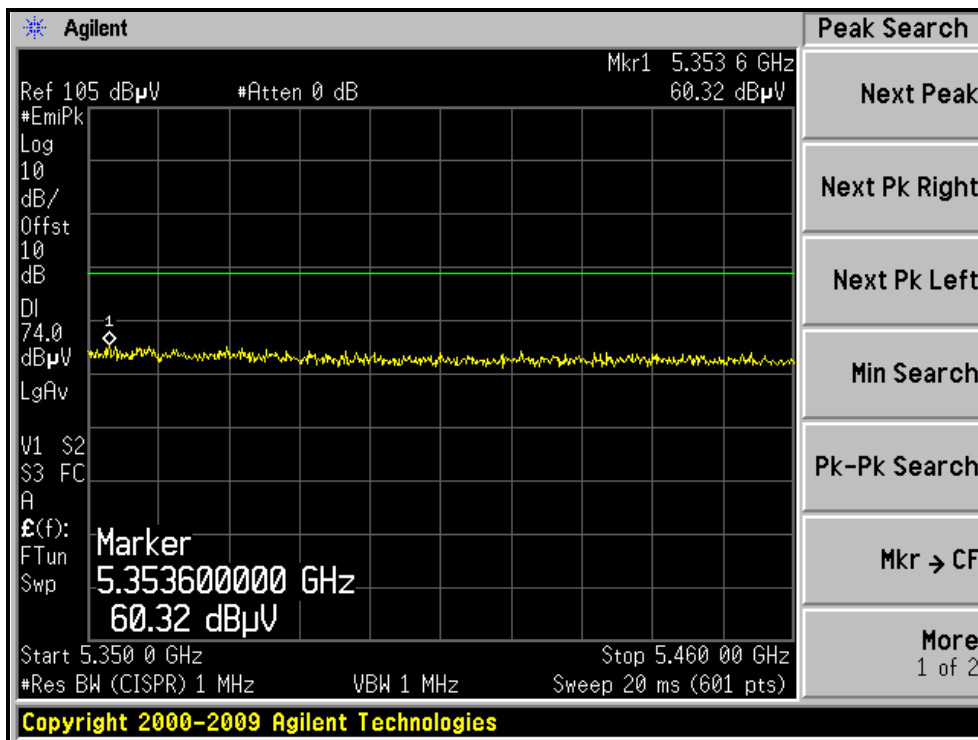



A D T

802.11n (40MHz) OFDM MODULATION

EUT TEST CONDITION		MEASUREMENT DETAIL	
CHANNEL	Channel 38	FREQUENCY RANGE	1 ~ 40GHz
INPUT POWER	120Vac, 60 Hz	DETECTOR FUNCTION	Peak (PK) Average (AV)
ENVIRONMENTAL CONDITIONS	12deg. C, 64%RH 1023 hPa	TESTED BY	Frank Liu

ANTENNA POLARITY & TEST DISTANCE: HORIZONTAL AT 3 M								
NO.	FREQ. (MHz)	EMISSION LEVEL (dBuV/m)	LIMIT (dBuV/m)	MARGIN (dB)	ANTENNA HEIGHT (m)	TABLE ANGLE (Degree)	RAW VALUE (dBuV)	CORRECTION FACTOR (dB/m)
1	5150.00	66.2 PK	74.0	-7.8	1.00 H	103	26.18	40.02
2	5150.00	52.4 AV	54.0	-1.6	1.00 H	103	12.38	40.02
3	*5190.00	104.6 PK			1.00 H	103	64.50	40.10
4	*5190.00	93.8 AV			1.00 H	103	53.70	40.10
5	#10380.00	56.1 PK	68.3	-12.2	1.09 H	143	9.63	46.47
6	15570.00	61.2 PK	74.0	-12.8	1.03 H	131	9.78	51.42
7	15570.00	49.3 AV	54.0	-4.7	1.03 H	131	-2.12	51.42

ANTENNA POLARITY & TEST DISTANCE: VERTICAL AT 3 M								
NO.	FREQ. (MHz)	EMISSION LEVEL (dBuV/m)	LIMIT (dBuV/m)	MARGIN (dB)	ANTENNA HEIGHT (m)	TABLE ANGLE (Degree)	RAW VALUE (dBuV)	CORRECTION FACTOR (dB/m)
1	5150.00	67.8 PK	74.0	-6.2	1.00 V	159	27.78	40.02
2	5150.00	53.0 AV	54.0	-1.0	1.00 V	159	12.98	40.02
3	*5190.00	104.4 PK			1.01 V	169	64.30	40.10
4	*5190.00	94.8 AV			1.01 V	169	54.70	40.10
5	#10380.00	55.4 PK	68.3	-12.9	1.11 V	85	8.93	46.47
6	15570.00	61.4 PK	74.0	-12.6	1.00 V	96	9.98	51.42
7	15570.00	49.2 AV	54.0	-4.8	1.00 V	96	-2.22	51.42

- REMARKS:**
1. Emission level (dBuV/m) = Raw Value (dBuV) + Correction Factor (dB/m).
 2. Correction Factor (dB/m) = Antenna Factor (dB/m) + Cable Factor (dB).
 3. The other emission levels were very low against the limit.
 4. Margin value = Emission level – Limit value.
 5. “ * “: Fundamental frequency.
 6. "#":The radiated frequency is out the restricted band.



A D T

EUT TEST CONDITION		MEASUREMENT DETAIL	
CHANNEL	Channel 46	FREQUENCY RANGE	1 ~ 40GHz
INPUT POWER	120Vac, 60 Hz	DETECTOR FUNCTION	Peak (PK) Average (AV)
ENVIRONMENTAL CONDITIONS	12deg. C, 64%RH 1023 hPa	TESTED BY	Frank Liu

ANTENNA POLARITY & TEST DISTANCE: HORIZONTAL AT 3 M								
NO.	FREQ. (MHz)	EMISSION LEVEL (dBuV/m)	LIMIT (dBuV/m)	MARGIN (dB)	ANTENNA HEIGHT (m)	TABLE ANGLE (Degree)	RAW VALUE (dBuV)	CORRECTION FACTOR (dB/m)
1	*5230.00	109.7 PK			1.00 H	102	69.48	40.22
2	*5230.00	98.6 AV			1.00 H	102	58.38	40.22
3	5350.00	59.2 PK	74.0	-14.8	1.00 H	102	18.63	40.57
4	5350.00	46.0 AV	54.0	-8.0	1.00 H	102	5.43	40.57
5	#10460.00	57.6 PK	68.3	-10.7	1.10 H	137	11.09	46.51
6	15690.00	61.7 PK	74.0	-12.3	1.05 H	142	10.43	51.27
7	15690.00	49.6 AV	54.0	-4.4	1.05 H	142	-1.67	51.27
ANTENNA POLARITY & TEST DISTANCE: VERTICAL AT 3 M								
NO.	FREQ. (MHz)	EMISSION LEVEL (dBuV/m)	LIMIT (dBuV/m)	MARGIN (dB)	ANTENNA HEIGHT (m)	TABLE ANGLE (Degree)	RAW VALUE (dBuV)	CORRECTION FACTOR (dB/m)
1	*5230.00	110.0 PK			1.13 V	180	69.78	40.22
2	*5230.00	99.4 AV			1.13 V	180	59.18	40.22
3	5350.00	60.8 PK	74.0	-13.2	1.13 V	180	20.23	40.57
4	5350.00	46.7 AV	54.0	-7.3	1.13 V	180	6.13	40.57
5	#10460.00	56.2 PK	68.3	-12.1	1.12 V	93	9.69	46.51
6	15690.00	61.1 PK	74.0	-12.9	1.00 V	74	9.83	51.27
7	15690.00	49.1 AV	54.0	-4.9	1.00 V	74	-2.17	51.27

- REMARKS:**
1. Emission level (dBuV/m) = Raw Value (dBuV) + Correction Factor (dB/m).
 2. Correction Factor (dB/m) = Antenna Factor (dB/m) + Cable Factor (dB).
 3. The other emission levels were very low against the limit.
 4. Margin value = Emission level – Limit value.
 5. “ * “: Fundamental frequency.
 6. “#“: The radiated frequency is out the restricted band.



A D T

RESTRICTED BANDEDGE (802.11n (40MHz) MODE, CH38, HORIZONTAL)

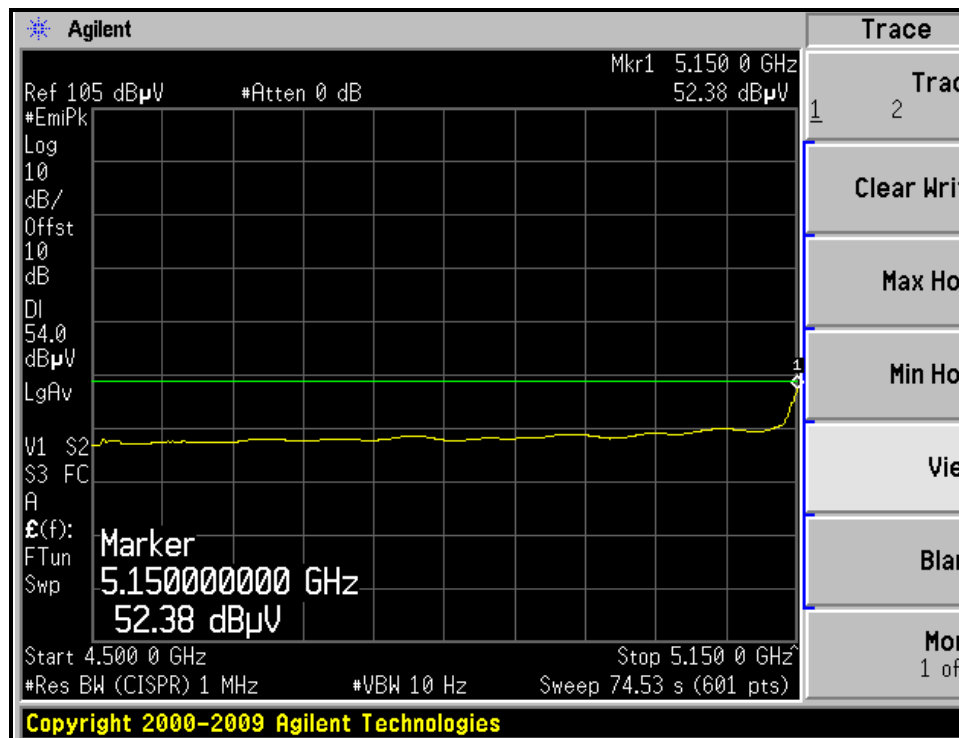
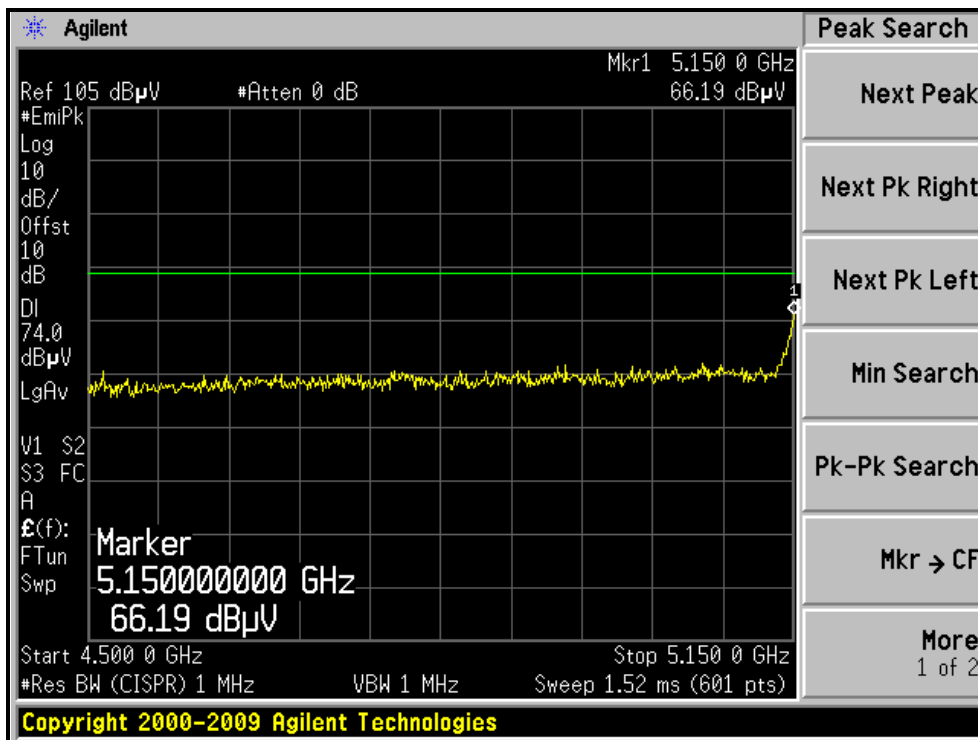



A D T

RESTRICTED BANDEDGE (802.11n (40MHz) MODE,CH38, VERTICAL)

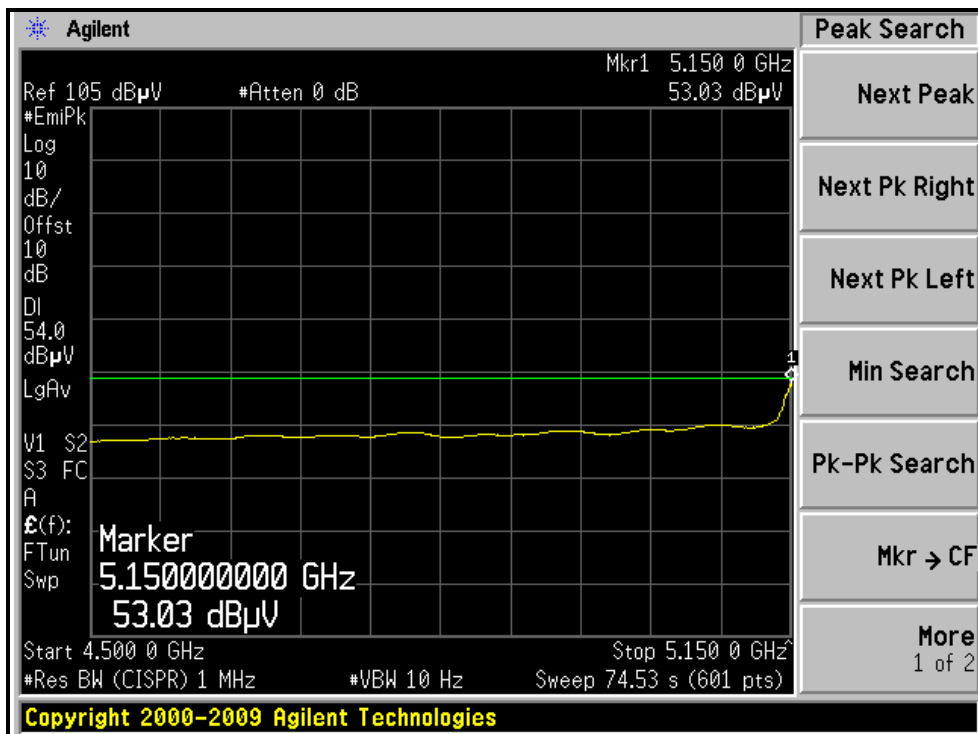
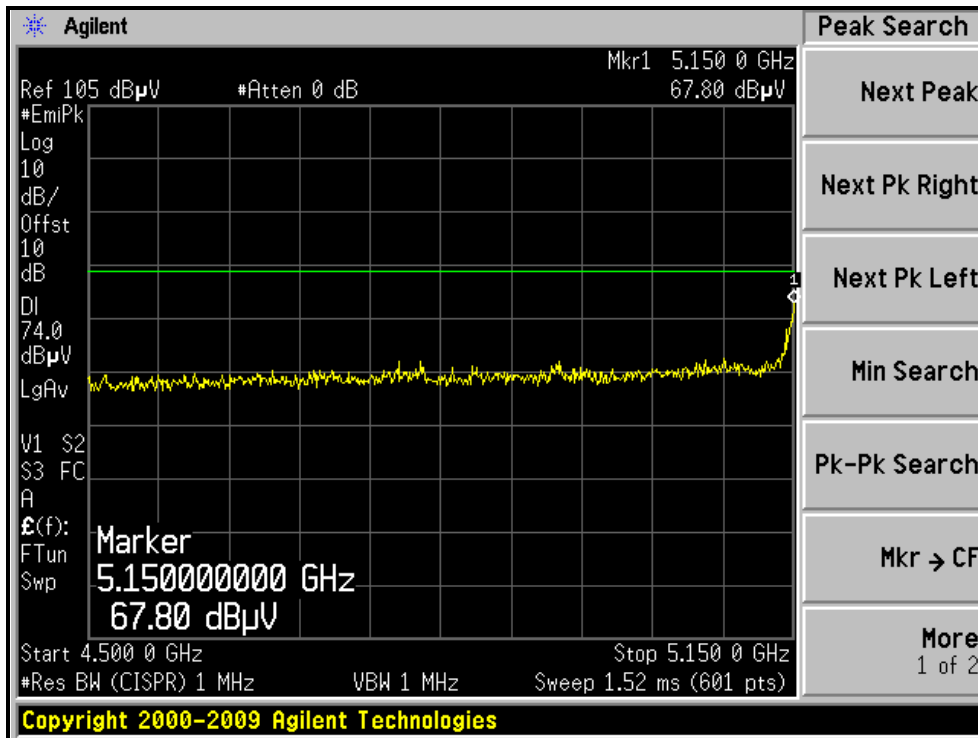



A D T

RESTRICTED BANDEDGE (802.11n (40MHz) MODE, CH46, HORIZONTAL)

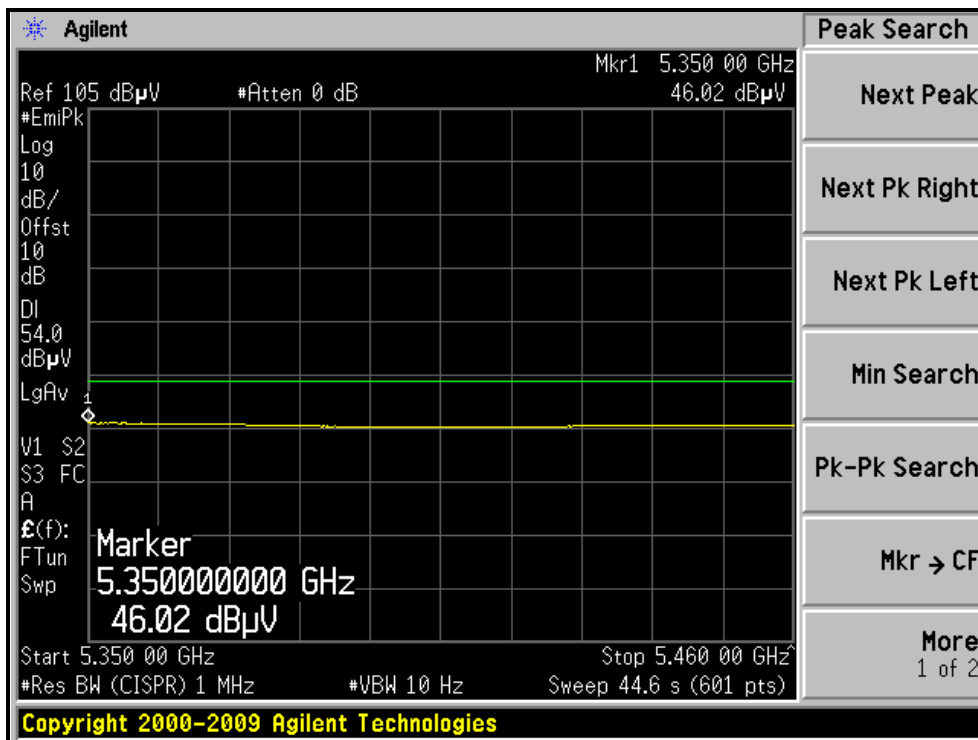
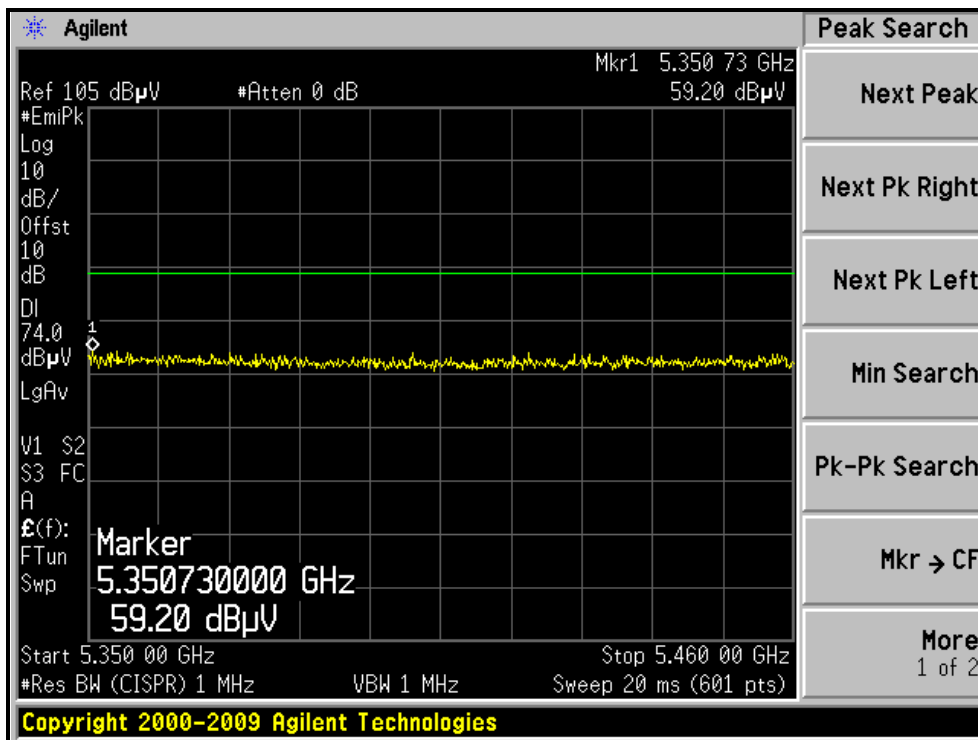



A D T

RESTRICTED BANDEDGE (802.11n (40MHz) MODE, CH46, VERTICAL)

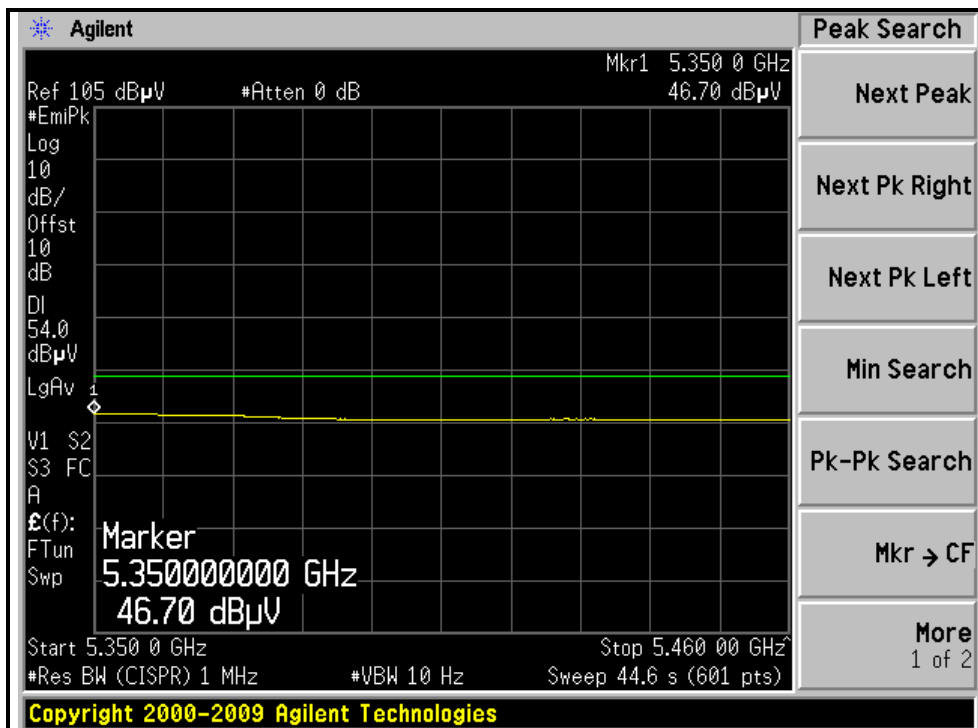
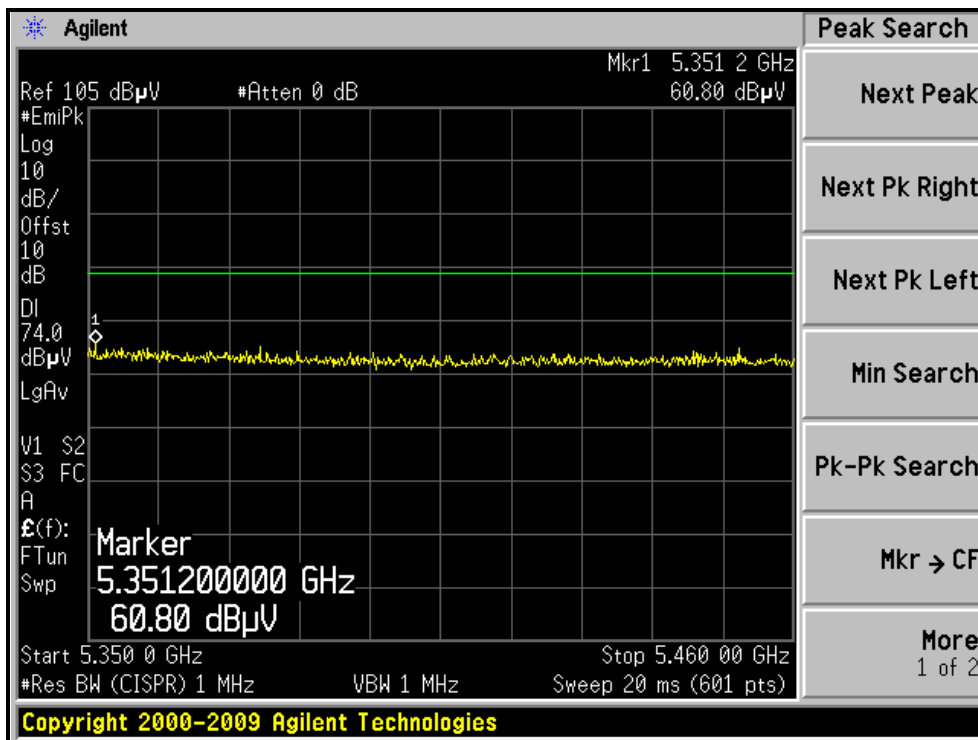

4.3 PEAK TRANSMIT POWER MEASUREMENT

4.3.1 LIMITS OF PEAK TRANSMIT POWER MEASUREMENT

Frequency Band	Limit
5.15 – 5.25GHz	The lesser of 50mW (17dBm) or 4dBm + 10logB
5.25 – 5.35GHz	The lesser of 250mW (24dBm) or 11dBm + 10logB
5.47 – 5.725GHz	The lesser of 250mW (24dBm) or 11dBm + 10logB
5.725 – 5.825GHz	The lesser of 1W (30dBm) or 17dBm + 10logB

NOTE: Where B is the 26dB emission bandwidth in MHz.

4.3.2 TEST INSTRUMENTS

DESCRIPTION & MANUFACTURER	MODEL NO.	SERIAL NO.	CALIBRATED DATE	CALIBRATED UNTIL
Spectrum Analyzer	E4446A	MY48250254	July 14, 2010	July 13, 2011

NOTE: The calibration interval of the above test instruments is 12 months and the calibrations are traceable to NML/ROC and NIST/USA.

4.3.3 TEST PROCEDURE

1. The transmitter output was connected to the spectrum analyzer.
2. Set span to encompass the entire emission bandwidth of the signal.
3. Set RBW to 1MHz, VBW to 300kHz.
4. Using the spectrum analyzer's channel power measurement function to measure the output power.

NOTE:

The test is performed in accordance with FCC Public Notice: APPENDIX A Guidelines for Assessing Unlicensed National Information Infrastructure (U-NII) Devices – Part 15, Subpart E, August 2002.

The transmitter output operates continuously therefore Method # 1 is used.

4.3.4 DEVIATION FROM TEST STANDARD

No deviation

4.3.5 TEST SETUP

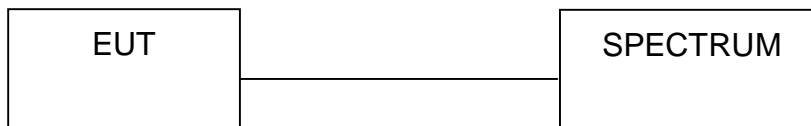

4.3.6 EUT OPERATING CONDITIONS

The software provided by client to enable the EUT under transmission condition continuously at specific channel frequencies individually.



A D T

4.3.7 TEST RESULTS

802.11a OFDM MODULATION:

CHANNEL	CHANNEL FREQUENCY (MHz)	PEAK POWER OUTPUT (dBm)		TOTAL PEAK POWER (mW)	TOTAL PEAK POWER (dBm)	PEAK POWER LIMIT (dBm)	26dBc Occupied Bandwidth (MHz)	PASS / FAIL
		CHAIN(0)	CHAIN(1)					
36	5180	8.1	8.4	13.4	11.3	15.3	19.58	PASS
40	5200	8.3	8.6	14.0	11.5	15.3	19.33	PASS
48	5240	8.2	8.7	14.0	11.5	15.3	19.42	PASS

NOTE: 1. The 26dBc Occupied Bandwidth plot, please refer to the following pages.

2. Directional gain = Directional gain = $10 \log \left[\left(10^{G1/20} + 10^{G2/20} \right)^2 / 2 \right]$

Effective Legacy Gain (dBi) = 7.7

The effective legacy gain is 7.7dBi, therefore the limit needs to reduce.

Peak Power Output:
For Chain(1) : CH48

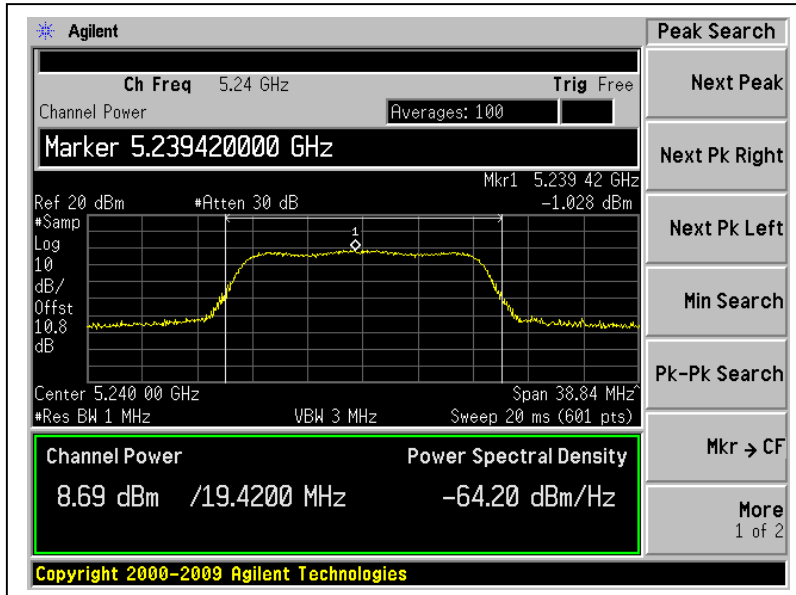

26dB Occupied Bandwidth:
CH48

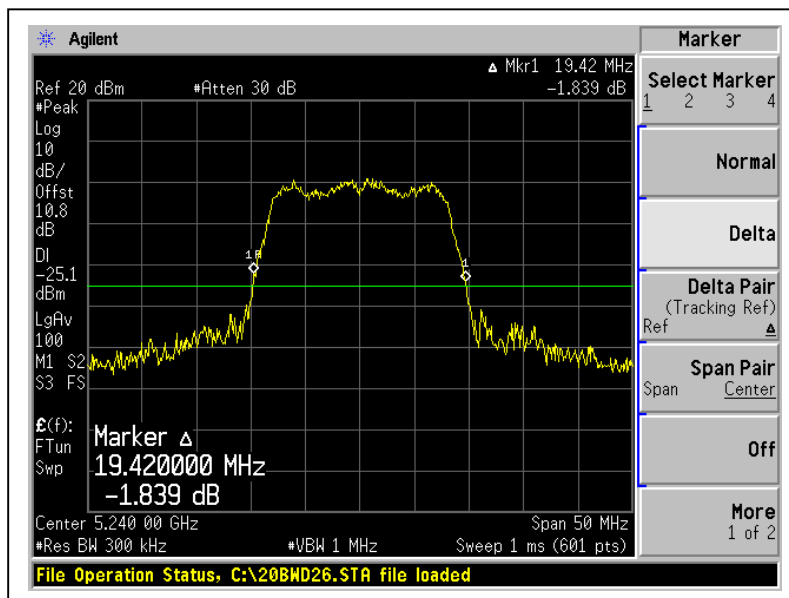



A D T

802.11n (20MHz) OFDM MODULATION:

CHANNEL	CHANNEL FREQUENCY (MHz)	PEAK POWER OUTPUT (dBm)		TOTAL PEAK POWER (mW)	TOTAL PEAK POWER (dBm)	PEAK POWER LIMIT (dBm)	26dBc Occupied Bandwidth (MHz)	PASS / FAIL
		CHAIN(0)	CHAIN(1)					
36	5180	10.1	10.6	21.7	13.4	17	19.5	PASS
40	5200	10.3	10.8	22.7	13.6	17	19.5	PASS
48	5240	10.9	11.1	25.2	14.0	17	19.5	PASS

NOTE: The 26dBc Occupied Bandwidth plot, please refer to the following pages.



A D T

Peak Power Output: For Chain(1) : CH48

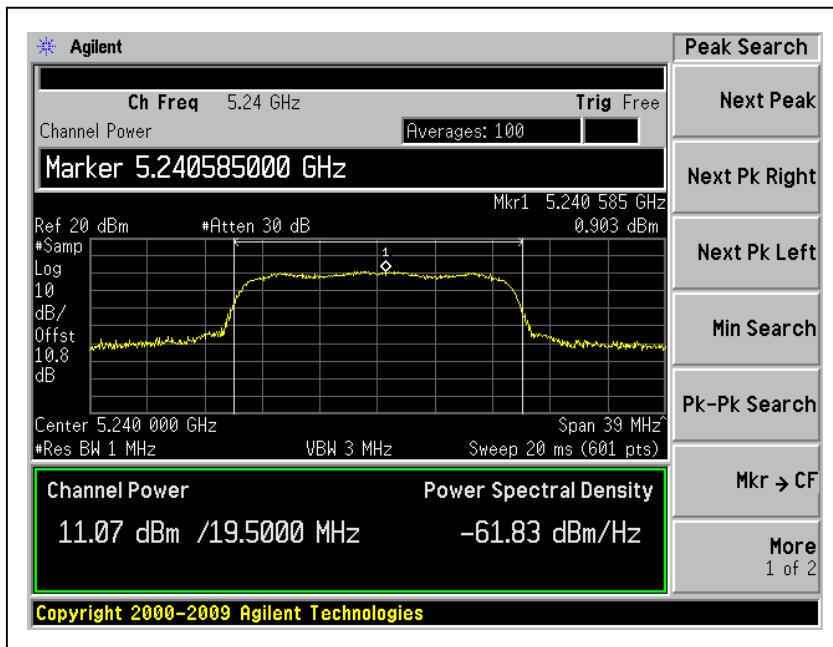

26dB Occupied Bandwidth: CH48

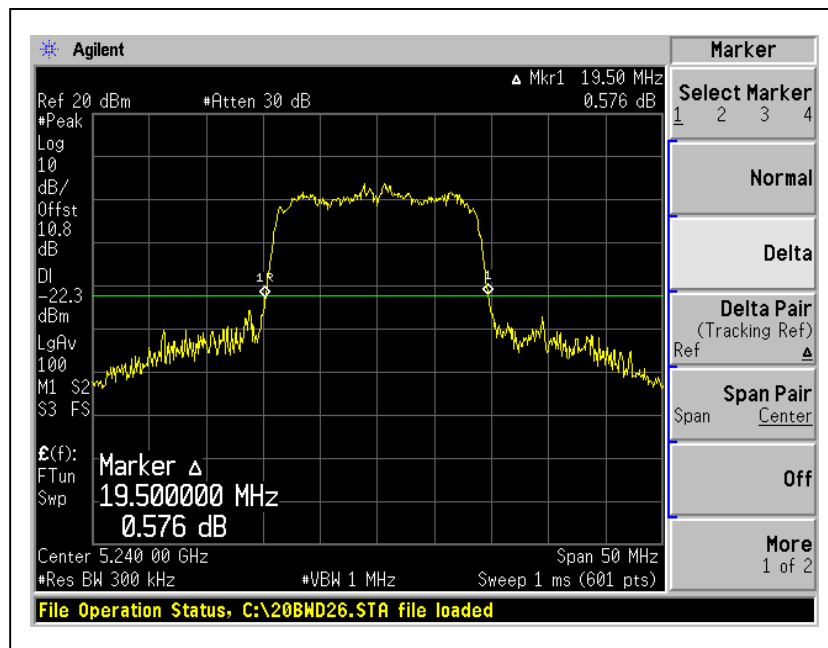



A D T

802.11n (40MHz) OFDM MODULATION:

CHANNEL	CHANNEL FREQUENCY (MHz)	PEAK POWER OUTPUT (dBm)		TOTAL PEAK POWER (mW)	TOTAL PEAK POWER (dBm)	PEAK POWER LIMIT (dBm)	26dBc Occupied Bandwidth (MHz)	PASS / FAIL
		CHAIN(0)	CHAIN(1)					
38	5190	7.8	7.9	12.2	10.9	17	39.0	PASS
46	5230	13.1	13.3	41.8	16.2	17	48.67	PASS

NOTE: The 26dBc Occupied Bandwidth plot, please refer to the following pages.



A D T

Peak Power Output: For Chain(1) :CH46

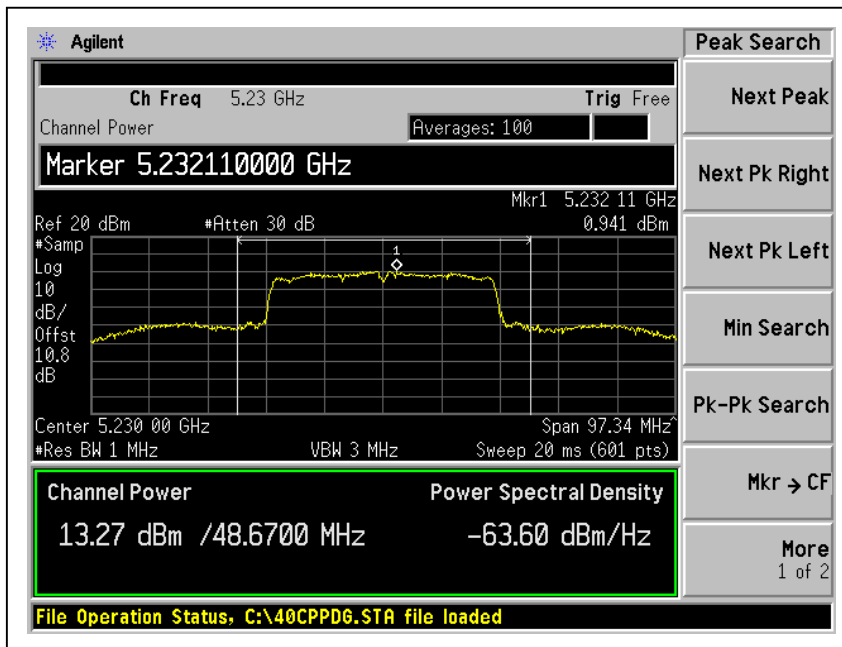

26dB Occupied Bandwidth: CH46

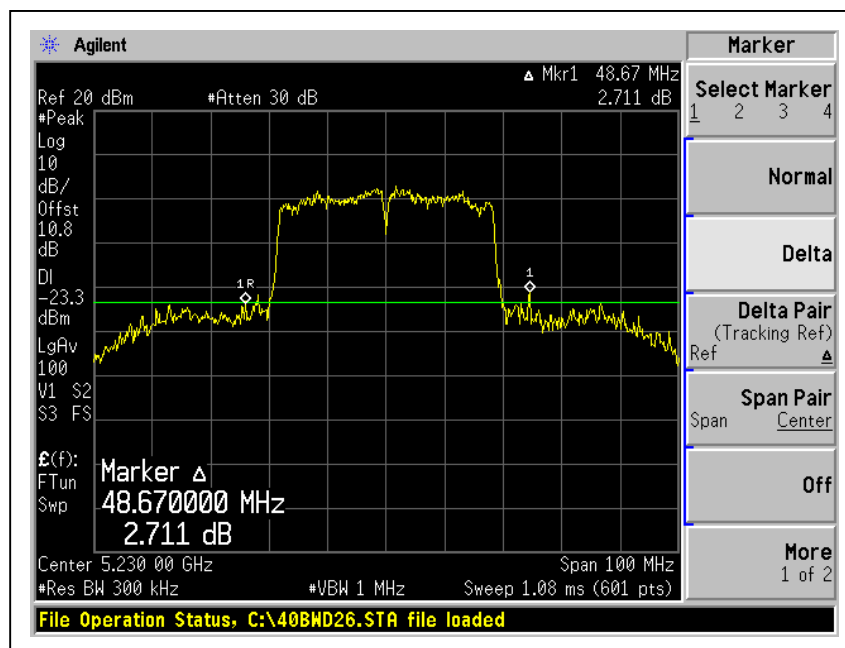



A D T

4.4 PEAK POWER EXCURSION MEASUREMENT

4.4.1 LIMITS OF PEAK POWER EXCURSION MEASUREMENT

Frequency Band	Limit
5.15 – 5.25 GHz	13dB
5.25 – 5.35 GHz	13dB
5.47 – 5.725GHz	13dB
5.725 – 5.825 GHz	13dB

4.4.2 TEST INSTRUMENTS

DESCRIPTION & MANUFACTURER	MODEL NO.	SERIAL NO.	CALIBRATED DATE	CALIBRATED UNTIL
Spectrum Analyzer	E4446A	MY48250254	July 14, 2010	July 13, 2011

NOTE: The calibration interval of the above test instruments is 12 months and the calibrations are traceable to NML/ROC and NIST/USA.

4.4.3 TEST PROCEDURE

1. Connect the cable from the spectrum analyzer to the EUT antenna port using an appropriate RF attenuator.
2. Verify the antenna port selected is the active one if the system has more than one antenna.
3. Verify the unlicensed wireless device is set to operate at 100 % duty cycle at the maximum allowed power for operation.
4. Testing shall be done on the center frequency of each U-NII band.
5. Set the spectrum analyzer span to view the entire emission bandwidth. The largest difference between the following two traces must be 13 dB for all frequencies across the emission bandwidth.
 - a. First trace: set RBW = 1 MHz, VBW = 3 MHz with peak detector and max hold settings.
 - b. Second trace: set RBW = 1 MHz, VBW = 3 MHz with sample detector and trace average across 100 traces in power averaging mode.

4.4.4 DEVIATION FROM TEST STANDARD

No deviation

4.4.5 TEST SETUP

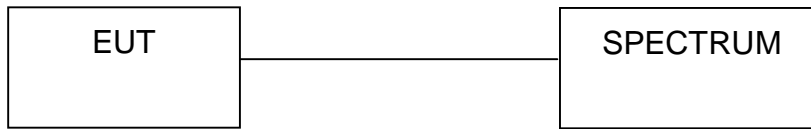

4.4.6 EUT OPERATING CONDITIONS

The software provided by client to enable the EUT under transmission condition continuously at specific channel frequencies individually.

4.4.7 TEST RESULTS

802.11a OFDM MODULATION

CHANNEL	CHANNEL FREQUENCY (MHz)	PEAK POWER EXCURSION (dB)	PEAK to AVERAGE EXCURSION LIMIT (dB)	PASS/FAIL
36	5180	8.8	13	PASS
40	5200	8.7	13	PASS
48	5240	8.7	13	PASS

CH36

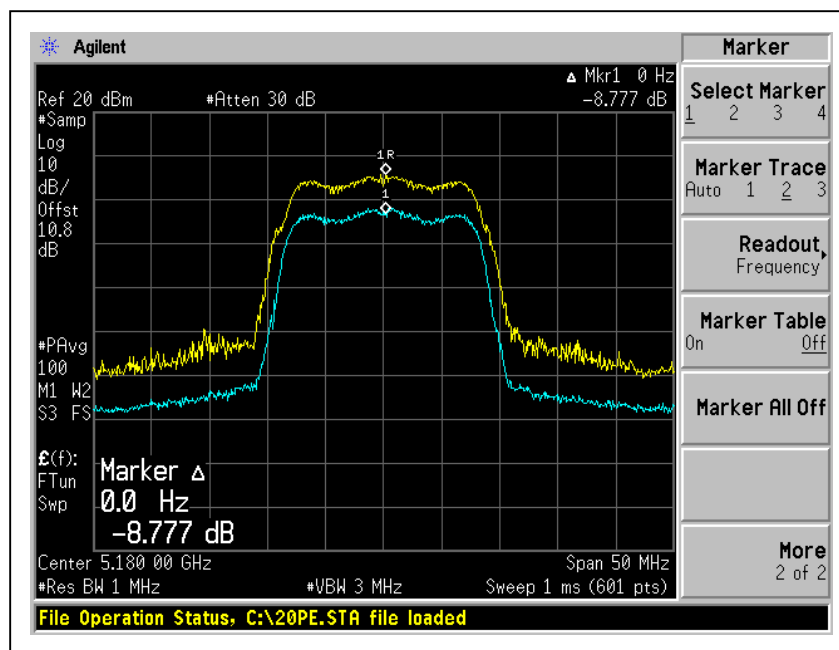



A D T

802.11n (20MHz) OFDM MODULATION:

CHANNEL	CHANNEL FREQUENCY (MHz)	PEAK POWER EXCURSION (dB)	PEAK to AVERAGE EXCURSION LIMIT (dB)	PASS/FAIL
36	5180	8.7	13	PASS
40	5200	8.5	13	PASS
48	5240	7.9	13	PASS

CH36

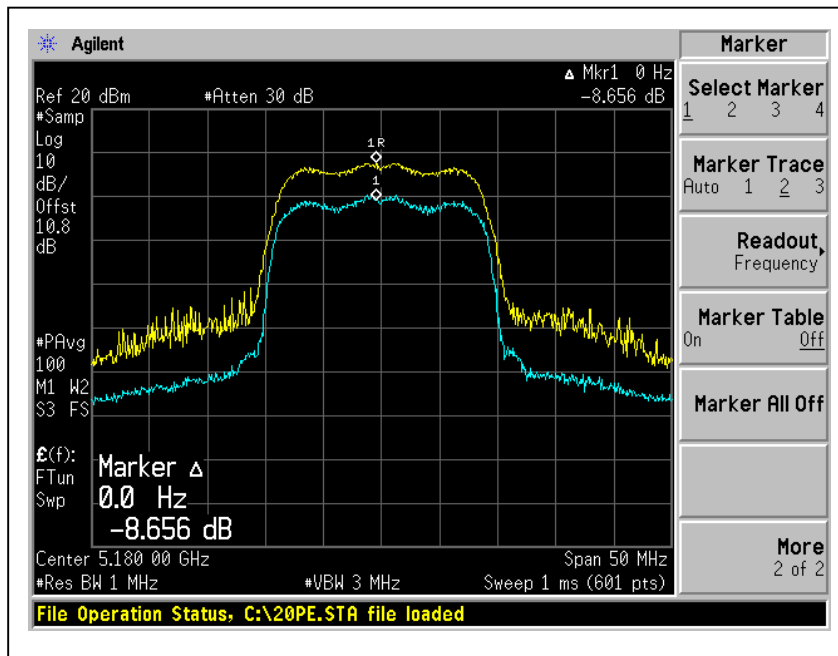



A D T

802.11n (40MHz) OFDM MODULATION:

CHANNEL	CHANNEL FREQUENCY (MHz)	PEAK POWER EXCURSION (dB)	PEAK to AVERAGE EXCURSION LIMIT (dB)	PASS/FAIL
38	5190	8.8	13	PASS
46	5230	8.3	13	PASS

CH38

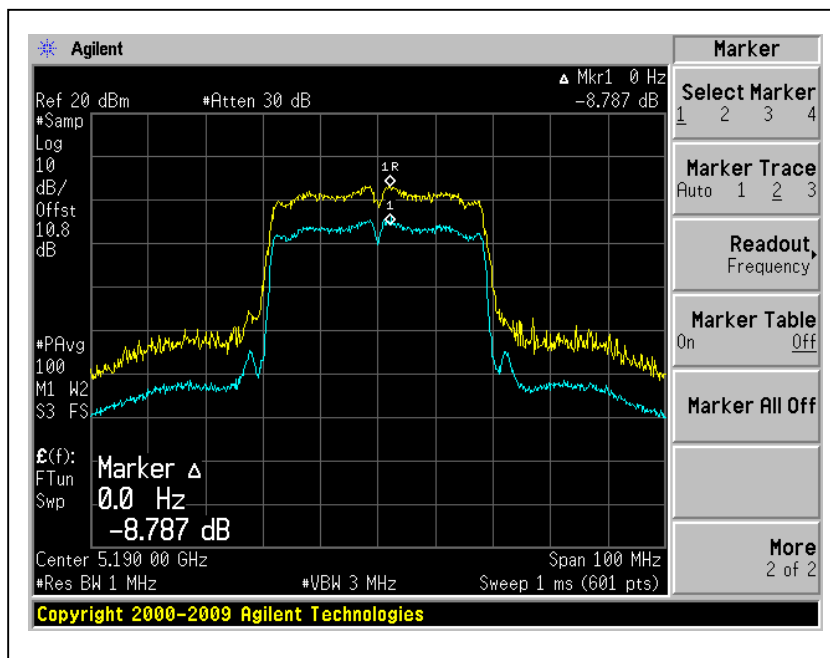

4.5 PEAK POWER SPECTRAL DENSITY MEASUREMENT

4.5.1 LIMITS OF PEAK POWER SPECTRAL DENSITY MEASUREMENT

Frequency Band	Limit
5.15 ~ 5.25GHz	4dBm
5.25 ~ 5.35GHz	11dBm
5.47 – 5.725GHz	11dBm
5.725 ~ 5.825GHz	17dBm

4.5.2 TEST INSTRUMENTS

DESCRIPTION & MANUFACTURER	MODEL NO.	SERIAL NO.	CALIBRATED DATE	CALIBRATED UNTIL
Spectrum Analyzer	E4446A	MY48250254	July 14, 2010	July 13, 2011

NOTE: The calibration interval of the above test instruments is 12 months and the calibrations are traceable to NML/ROC and NIST/USA.

4.5.3 TEST PROCEDURES

1. The transmitter output was connected to the spectrum analyzer.
2. Set RBW=1MHz, VBW=3MHz. The PPSD is the highest level found across the emission in any 1MHz band.

4.5.4 DEVIATION FROM TEST STANDARD

No deviation

4.5.5 TEST SETUP

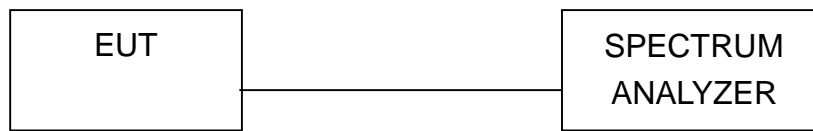

4.5.6 EUT OPERATING CONDITIONS

Same as 4.3.6



A D T

4.5.7 TEST RESULTS

802.11a OFDM MODULATION

CHANNEL	CHANNEL FREQUENCY (MHz)	RF POWER LEVEL IN 3kHz BW (dBm)		TOTAL POWER DENSITY (dBm)	MAXIMUM LIMIT (dBm)	PASS / FAIL
		CHAIN(0)	CHAIN(1)			
36	5180	-1.7	-1.3	1.5	2.3	PASS
40	5200	-1.4	-1.3	1.7	2.3	PASS
48	5240	-1.7	-1.0	1.7	2.3	PASS

NOTE: Directional gain = $10 \log(10^{G1/20} + 10^{G2/20})^2 / 2$

Effective Legacy Gain (dBi) = 7.7

The effective legacy gain is 7.7dBi, therefore the limit needs to reduce.

For Chain (1) : CH48

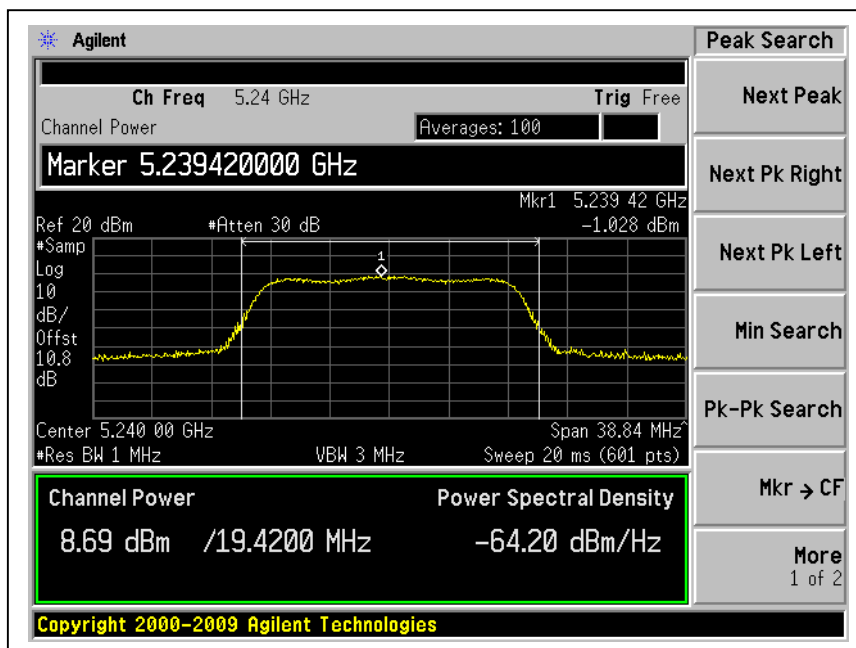



A D T

802.11n (20MHz) OFDM MODULATION:

CHANNEL	CHANNEL FREQUENCY (MHz)	RF POWER LEVEL IN 3kHz BW (dBm)		TOTAL POWER DENSITY (dBm)	MAXIMUM LIMIT (dBm)	PASS / FAIL
		CHAIN(0)	CHAIN(1)			
36	5180	0.1	0.7	3.4	4	PASS
40	5200	0.2	1.0	3.6	4	PASS
48	5240	0.8	0.9	3.9	4	PASS

For Chain (1) : CH40

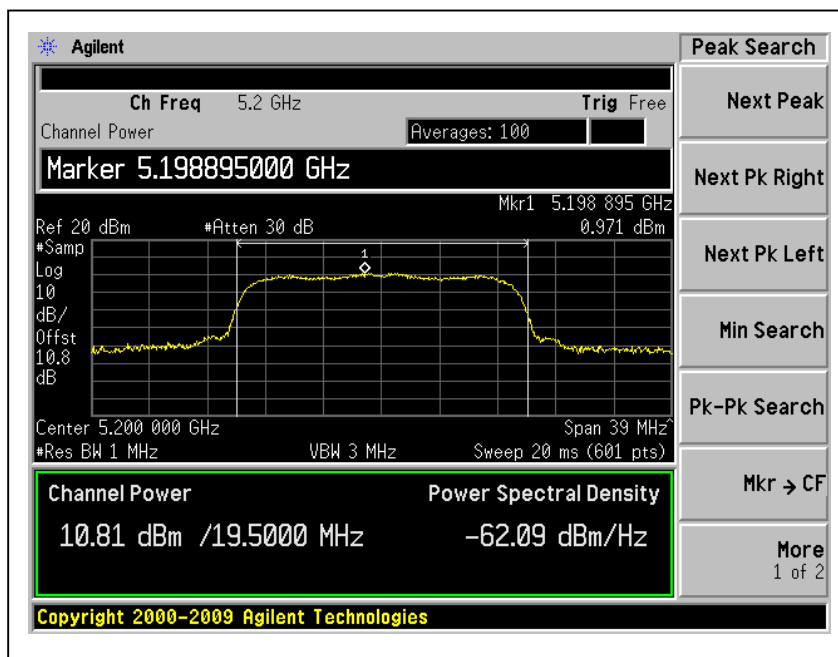



A D T

802.11n (40MHz) OFDM MODULATION:

CHANNEL	CHANNEL FREQUENCY (MHz)	RF POWER LEVEL IN 3kHz BW (dBm)		TOTAL POWER DENSITY (dBm)	MAXIMUM LIMIT (dBm)	PASS / FAIL
		CHAIN(0)	CHAIN(1)			
38	5190	-4.9	-5.4	-2.1	4	PASS
46	5230	0.1	0.9	3.5	4	PASS

For Chain (1) : CH46

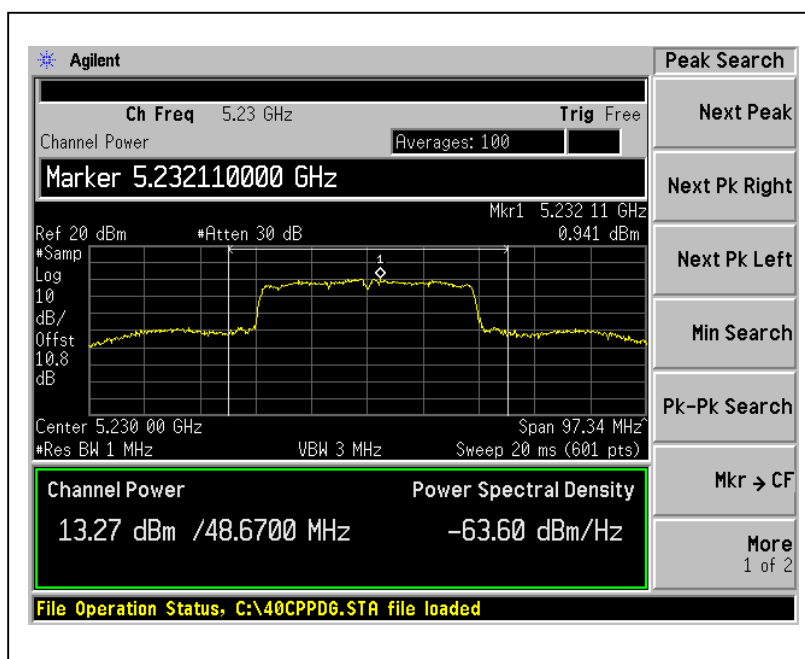

4.6 FREQUENCY STABILITY

4.6.1 LIMITS OF FREQUENCY STABILITY MEASUREMENT

The frequency tolerance of the carrier signal shall be maintained within of the operating frequency over a temperature variation of –30 degrees to 50 degrees C at normal supply voltage, and for a variation in the primary supply voltage from 85% to 115% of the rated supply voltage at a temperature of 20 degrees C.

4.6.2 TEST INSTRUMENTS

DESCRIPTION & MANUFACTURER	MODEL NO.	SERIAL NO.	CALIBRATED DATE	CALIBRATED UNTIL
Spectrum Analyzer	FSP 40	100060	May 17, 2010	May 16, 2011

NOTE: The calibration interval of the above test instruments is 12 months and the calibrations are traceable to NML/ROC and NIST/USA.

4.6.3 TEST PROCEDURE

1. The EUT was placed inside the environmental test chamber and powered by nominal AC voltage.
2. Turn the EUT on and couple its output to a spectrum analyzer.
3. Turn the EUT off and set the chamber to the highest temperature specified.
4. Allow sufficient time (approximately 30 min) for the temperature of the chamber to stabilize, turn the EUT on and measure the operating frequency after 2, 5, and 10 minutes.
5. Repeat step 2 and 3 with the temperature chamber set to the lowest temperature.
6. The test chamber was allowed to stabilize at +20 degree C for a minimum of 30 minutes. The supply voltage was then adjusted on the EUT from 85% to 115% and the frequency record.

4.6.4 DEVIATION FROM TEST STANDARD

No deviation

4.6.5 TEST SETUP

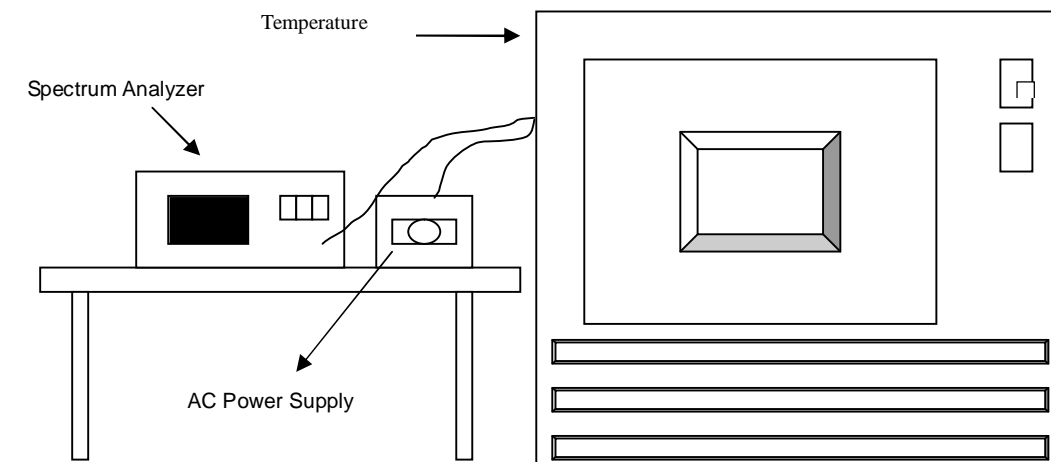

4.6.6 EUT OPERATING CONDITION

The software provided by client to enable the EUT under transmission condition continuously at specific channel frequencies individually.



A D T

4.6.7 TEST RESULTS

Operating frequency: 5180MHz									
Temp. (°C)	Power supply (VAC)	0 minute		2 minute		5 minute		10 minute	
		(MHz)	(%)	(MHz)	(%)	(MHz)	(%)	(MHz)	(%)
50	138	5180.0058	1.1197	5180.0077	1.4865	5180.0124	2.3938	5180.0114	2.2008
	120	5180.0059	1.1390	5180.0085	1.6409	5180.012	2.3166	5180.0123	2.3745
	102	5180.0046	0.8880	5180.0074	1.4286	5180.013	2.5097	5180.0115	2.2201
40	138	5180.0086	1.6602	5180.0046	0.8880	5180.0052	1.0039	5180.0036	0.6950
	120	5180.0079	1.5251	5180.0056	1.0811	5180.0052	1.0039	5180.0033	0.6371
	102	5180.0096	1.8533	5180.0037	0.7143	5180.0049	0.9459	5180.0017	0.3282
30	138	5179.9899	-1.9498	5179.993	-1.3514	5179.9923	-1.4865	5179.9943	-1.1004
	120	5179.9892	-2.0849	5179.9923	-1.4865	5179.9937	-1.2162	5179.9938	-1.1969
	102	5179.9892	-2.0849	5179.9928	-1.3900	5179.9942	-1.1197	5179.994	-1.1583
20	138	5179.9996	-0.0772	5179.9979	-0.4054	5179.9999	-0.0193	5180.0055	1.0618
	120	5180.0012	0.2317	5179.9984	-0.3089	5179.9994	-0.1158	5180.0047	0.9073
	102	5180.0004	0.0772	5179.9971	-0.5598	5179.9991	-0.1737	5180.0047	0.9073
10	138	5180.0024	0.4633	5179.9988	-0.2317	5179.9964	-0.6950	5179.9977	-0.4440
	120	5180.0034	0.6564	5180.0004	0.0772	5179.9955	-0.8687	5179.9966	-0.6564
	102	5180.0041	0.7915	5179.9995	-0.0965	5179.9958	-0.8108	5179.9983	-0.3282
0	138	5179.9986	-0.2703	5180.0009	0.1737	5180.0023	0.4440	5179.9991	-0.1737
	120	5179.9992	-0.1544	5180.0009	0.1737	5180.0028	0.5405	5179.9993	-0.1351
	102	5179.9986	-0.2703	5180.0005	0.0965	5180.0022	0.4247	5179.999	-0.1931
-10	138	5179.9987	-0.2510	5179.9985	-0.2896	5180.0012	0.2317	5180.003	0.5792
	120	5179.9982	-0.3475	5179.9981	-0.3668	5180.0008	0.1544	5180.0029	0.5598
	102	5179.9974	-0.5019	5179.9969	-0.5985	5180.0011	0.2124	5180.0026	0.5019
-20	138	5180.0131	2.5290	5180.015	2.8958	5180.0156	3.0116	5180.0167	3.2239
	120	5180.0141	2.7220	5180.0147	2.8378	5180.0163	3.1467	5180.0162	3.1274
	102	5180.013	2.5097	5180.015	2.8958	5180.015	2.8958	5180.0167	3.2239
-30	138	5180.0202	3.8996	5180.023	4.4402	5180.0225	4.3436	5180.0264	5.0965
	120	5180.0194	3.7452	5180.0242	4.6718	5180.0232	4.4788	5180.0259	5.0000
	102	5180.0197	3.8031	5180.0237	4.5753	5180.0225	4.3436	5180.0262	5.0579

4.7 CONDUCTED OUT-BAND EMISSION MEASUREMENT

4.7.1 TEST INSTRUMENTS

DESCRIPTION & MANUFACTURER	MODEL NO.	SERIAL NO.	CALIBRATED DATE	CALIBRATED UNTIL
Spectrum Analyzer	FSP 40	100060	May 17, 2010	May 16, 2011

NOTE: The calibration interval of the above test instruments is 12 months and the calibrations are traceable to NML/ROC and NIST/USA.

4.7.2 TEST PROCEDURE

The transmitter output was connected to the spectrum analyzer via a low loss cable. Set RBW of spectrum analyzer to 1MHz with suitable frequency span including 100MHz or 200MHz bandwidth from band edge. The band edges was measured and recorded.

4.7.3 EUT OPERATING CONDITION

The software provided by client to enable the EUT under transmission condition continuously at specific channel frequencies individually.

4.7.4 TEST RESULTS

For 5.15 to 5.25GHz band:

The spectrum plots (Peak RBW=1MHz, VBW=3MHz) are attached on the following pages.



A D T

802.11a OFDM modulation

CH 36

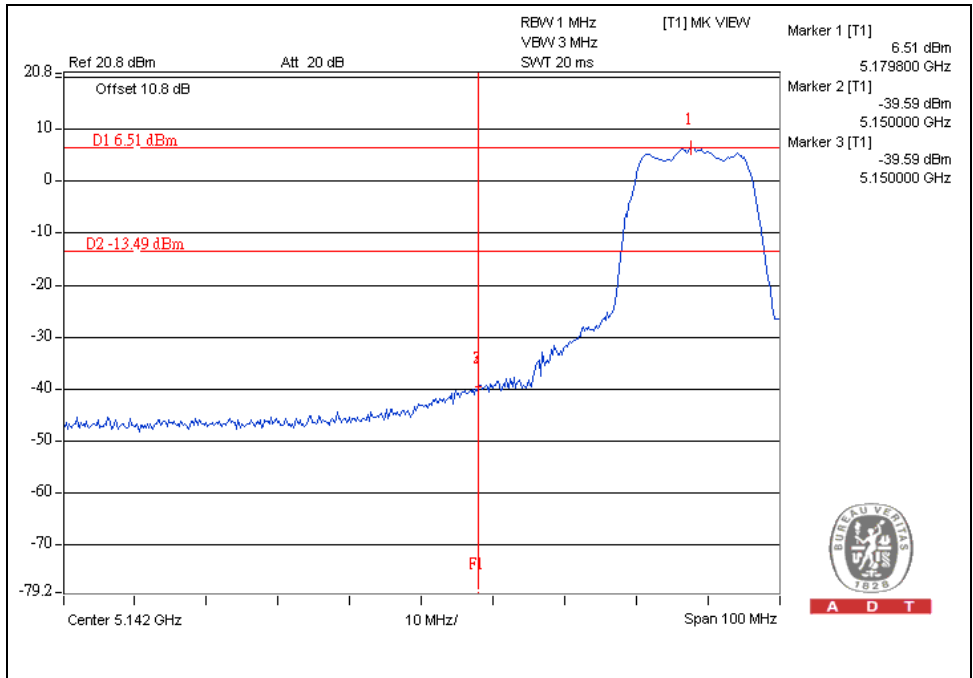

CH 48

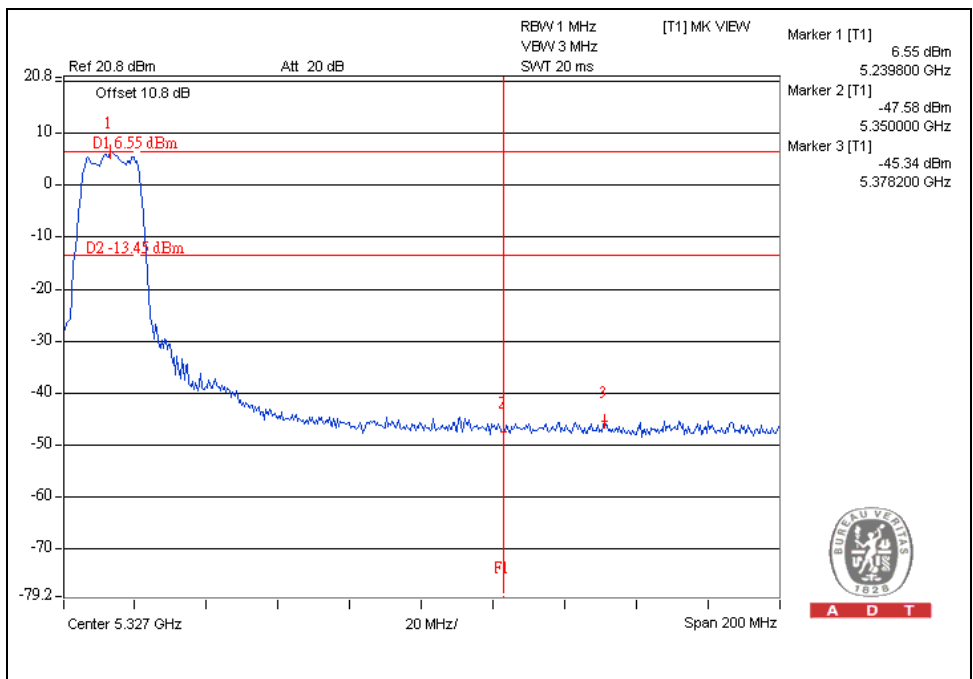



A D T

CH 36

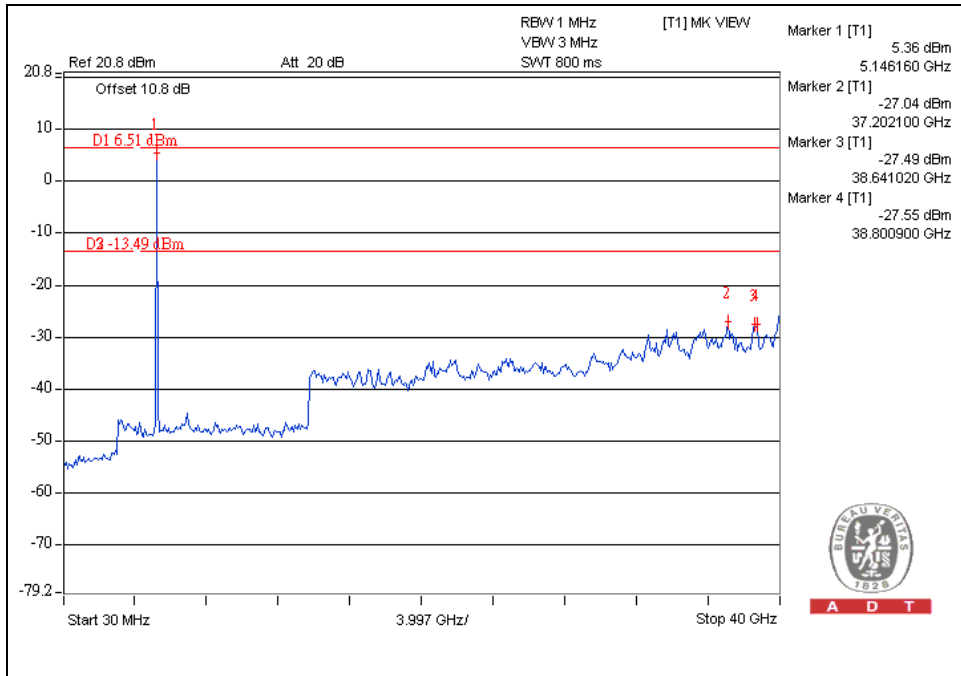

CH 48

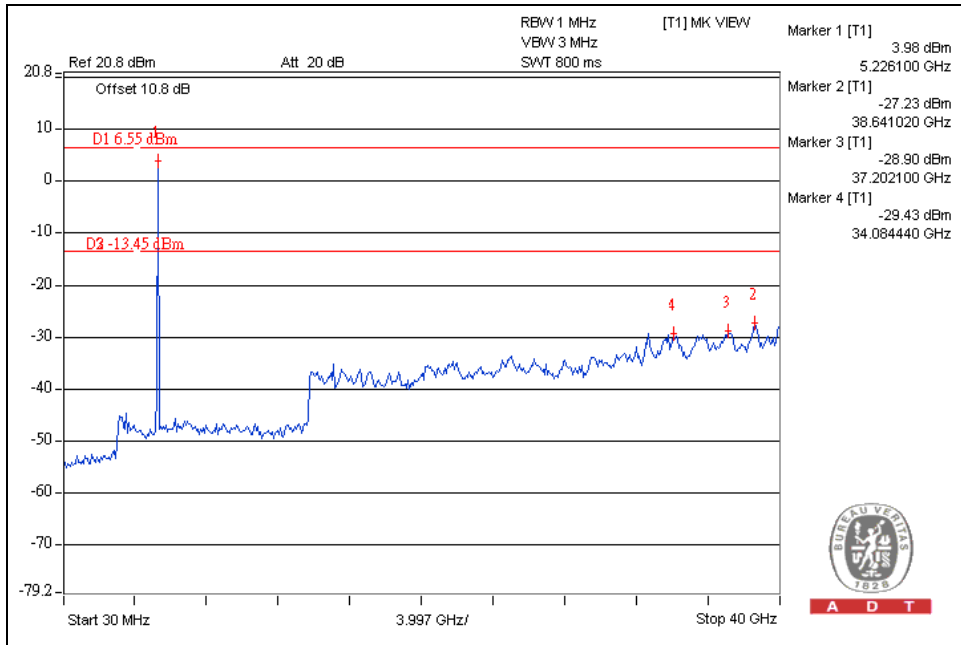



A D T

802.11n (20MHz) OFDM MODULATION:

CH36

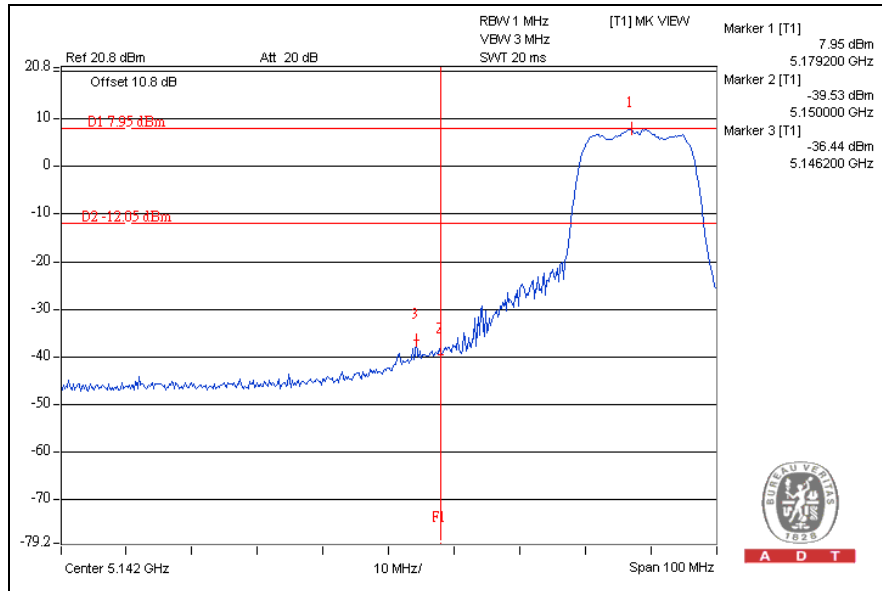

CH48

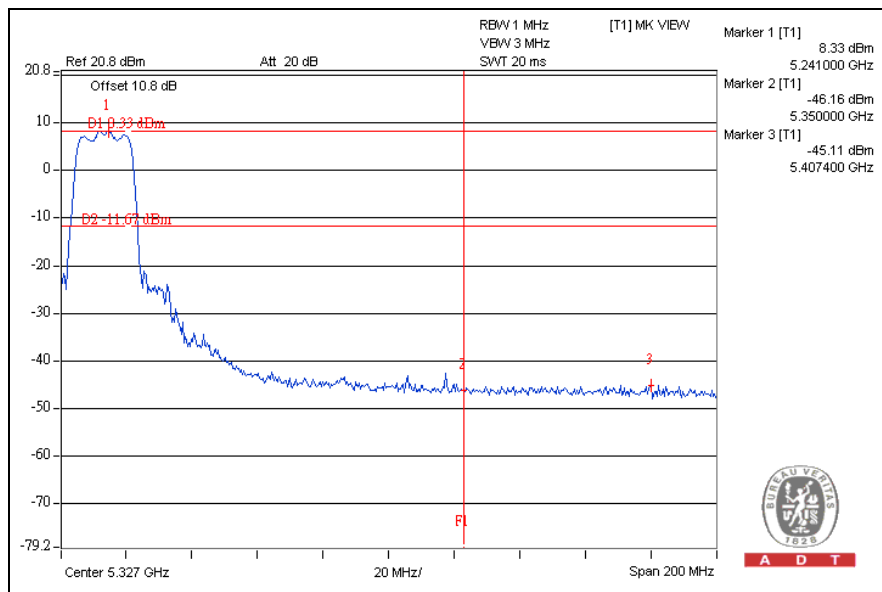



A D T

CH36

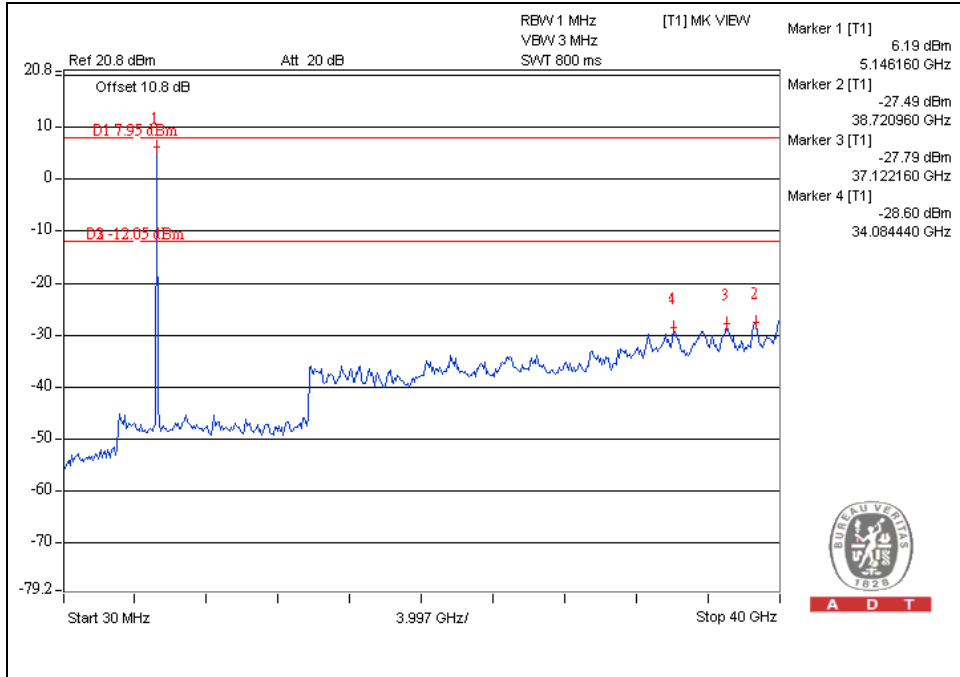

CH48

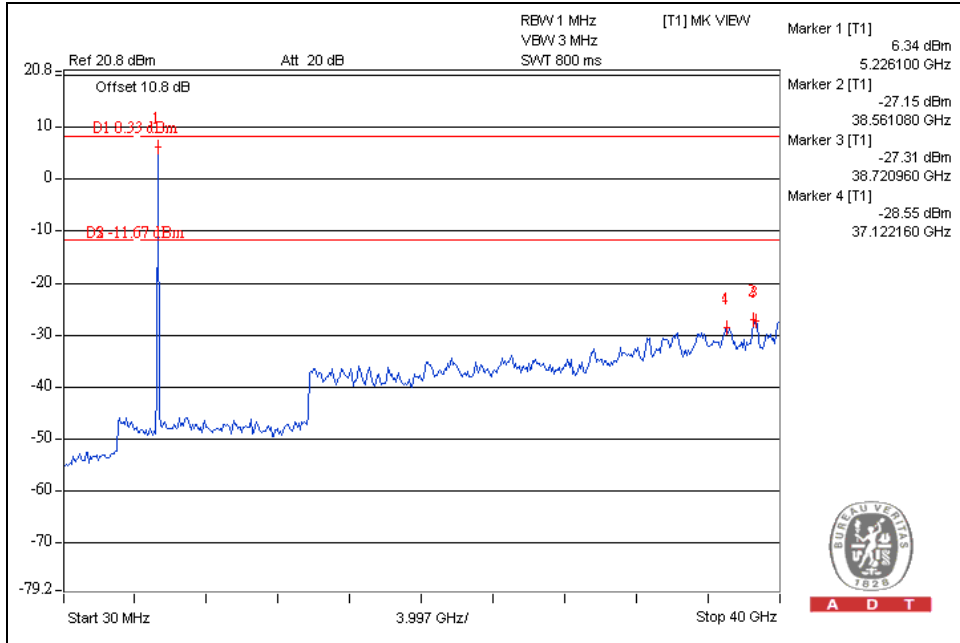



A D T

802.11n (40MHz) OFDM MODULATION:

CH38

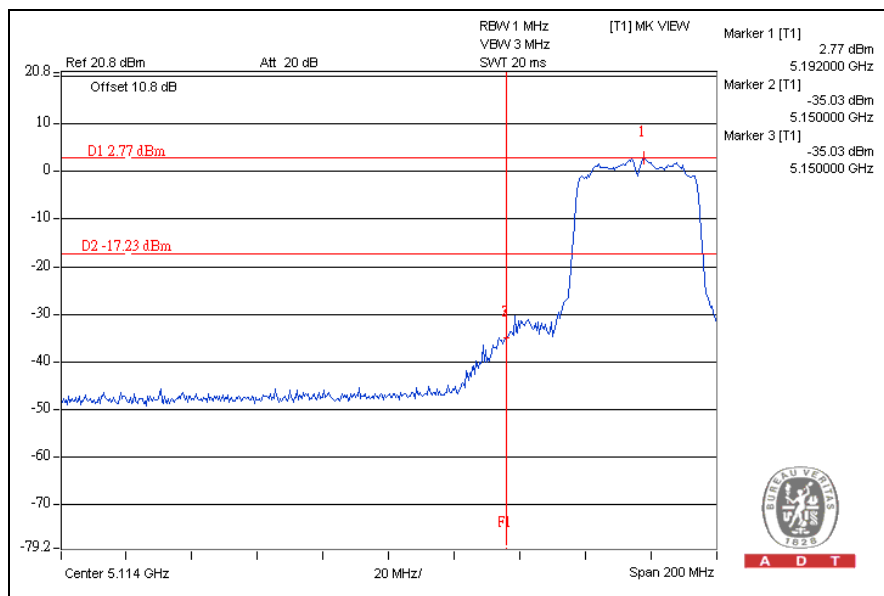

CH46

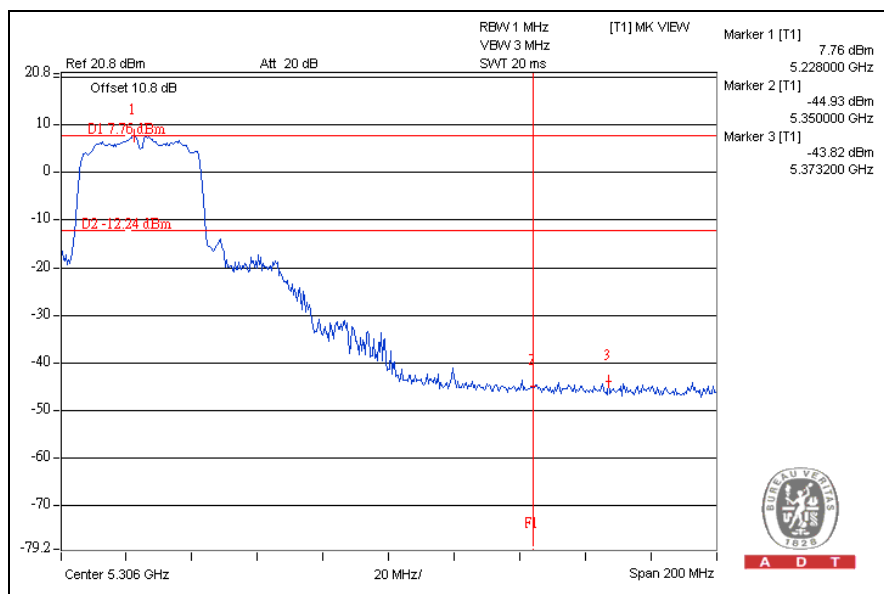



A D T

CH38

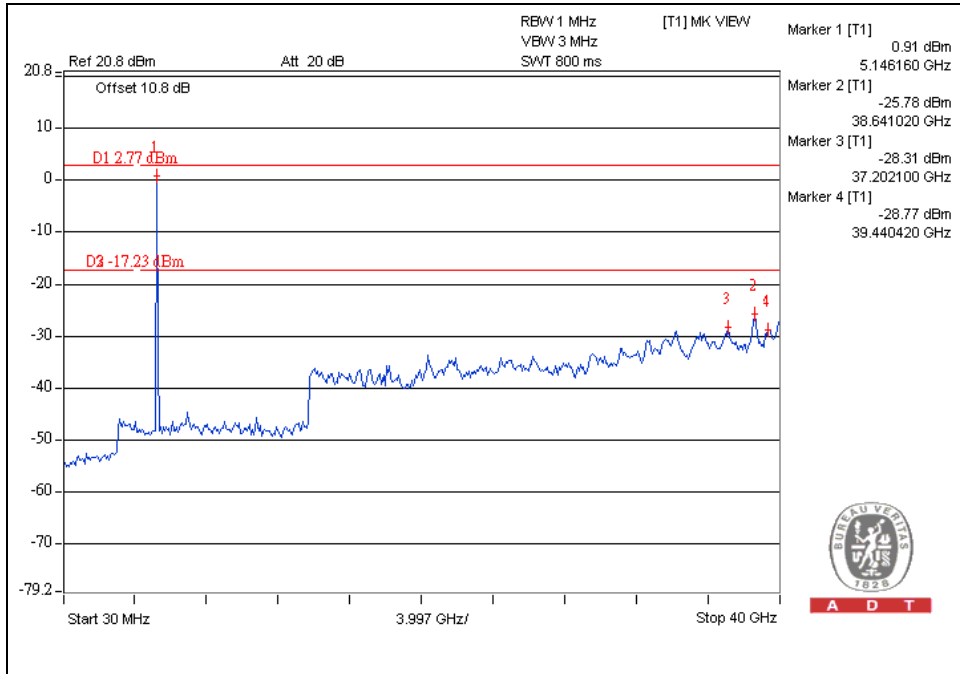

CH46

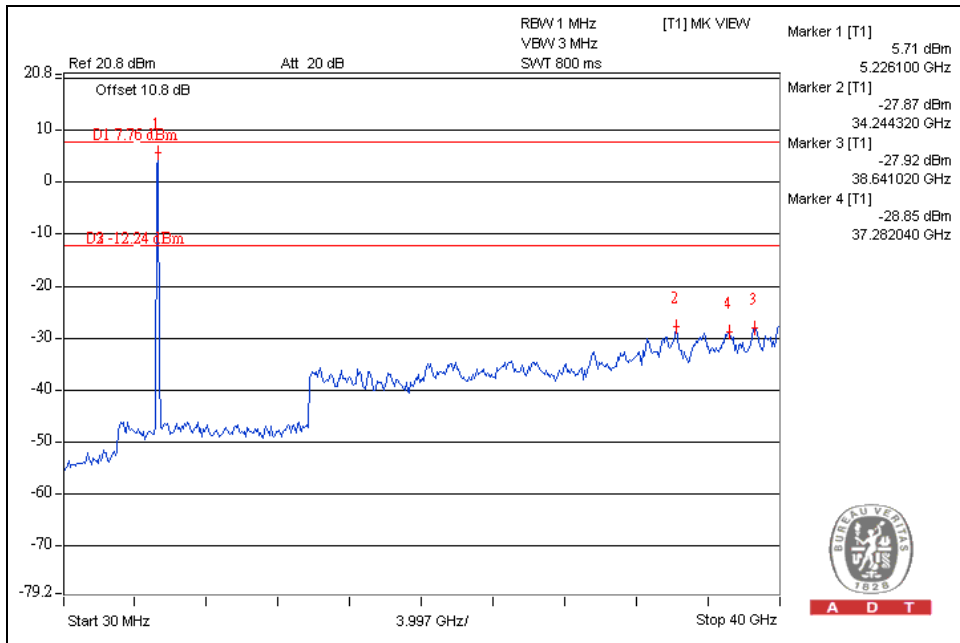



A D T

5. INFORMATION ON THE TESTING LABORATORIES

We, Bureau Veritas Consumer Products Services (H.K.) Ltd., Taoyuan Branch, were founded in 1988 to provide our best service in EMC, Radio, Telecom and Safety consultation. Our laboratories are accredited and approved according to ISO/IEC 17025.

Copies of accreditation certificates of our laboratories obtained from approval agencies can be downloaded from our web site: www.adt.com.tw/index.5.phtml.

If you have any comments, please feel free to contact us at the following:

Linko EMC/RF Lab:

Tel: 886-2-26052180

Fax: 886-2-26052943

Hsin Chu EMC/RF Lab:

Tel: 886-3-5935343

Fax: 886-3-5935342

Hwa Ya EMC/RF/Safety/Telecom Lab:

Tel: 886-3-3183232

Fax: 886-3-3185050

Email: service@adt.com.tw

Web Site: www.adt.com.tw

The address and road map of all our labs can be found in our web site also.



A D T

6.APPENDIX A - MODIFICATIONS RECORDERS FOR ENGINEERING CHANGES TO THE EUT BY THE LAB

No any modifications are made to the EUT by the lab during the test.