

MEASUREMENT REPORT of *Wireless Keyboard*

Applicant : Belkin Corporation
FCC ID : K7SF8E838-KBD
EUT : Wireless Keyboard
Model : F8E838-KBD
Report No. : B1515440

Test by :

Training Research Co., Ltd.

TEL : 886-2-26461146

FAX : 886-2-26461778

No. 15, Lane 530, Pa-Lian RD., Sec. 1, Hsichih City, Taipei Hsien, Taiwan, R.O.C.

CERTIFICATION

We here by verify that:

The test data, data evaluation, test procedures and equipment configurations shown in this report were made mainly in accordance with the procedures given in ANSI C63.4 (1992) as a reference. All tests were conducted by *Training Research Co., Ltd.*, No. 255, Nan-yang Street, Shijr, Taipei Hsien 221, Taiwan. Also, we attest to the accuracy of each.

We further submit that the energy emitted by the sample EUT tested as described in the report is **in compliance with** the technical requirements set forth in the FCC Rules Part 15 Subpart C Section 15.249.

Applicant : Belkin Corporation
Applicant address : 501 West Walnut Street Compton, CA 90220-5221, USA
Granted FCC ID : K7SF8E838-KBD
Test Date : December 29, 2004

Prepared by: _____

Jason Yeh

Approved by: _____

Jacob Lin

Conditions of issue :

- (1) **This test report shall not be reproduced except in full, without written approval of TRC. And the test result contained within this report only relate to the sample submitted for testing.**
- (2) **This report must not be used by the client to claim product endorsement by NVLAP or any agency of U.S. Government.**
- (3) **This test report, measurements made by TRC are traceable to the NIST only Conducted and Radiated Method.**

★ NVLAP LAB CODE: 200174-0

Report No.: B1515440

Training Research Co., Ltd. TEL: 886-2-26461146, Fax: 886-2-26461778

Tables of Contents

CHAPTER 1	GENERAL	4
1.1	INTRODUCTION	4
1.2	DESCRIPTION OF EUT	4
1.3	TEST METHOD	4
1.4	LIST OF SUPPORT EQUIPMENT.....	5
1.5	CONFIGURATION OF TEST SETUP	7
1.6	TEST PROCEDURE.....	9
1.7	LOCATION OF THE TEST SITE	9
1.8	GENERAL TEST CONDITION	9
CHAPTER 2	CONDUCTED EMISSIONS MEASUREMENTS	10
2.1	TEST CONDITION & SETUP.....	10
2.2	LIST OF TEST INSTRUMENTS	10
2.3	TEST RESULT OF CONDUCTED EMISSIONS.....	12
CHAPTER 3	TRANSMITTER DUTY CYCLE MEASUREMENTS	12
3.1	TEST CONDITION AND SETUP	12
3.2	LIST OF TEST INSTRUMENTS	12
3.3	TEST INSTRUMENTS CONFIGURATION	13
3.4	TEST RESULT	13
CHAPTER 4	RADIATED EMISSIONS MEASUREMENTS.....	15
4.1	TEST CONDITION & SETUP.....	15
4.2	LIST OF TEST INSTRUMENTS	17
4.3	TEST RESULT OF RADIATED EMISSIONS	18
	Fundamental Emissions	18
4.4	TEST RESULT OF SPURIOUS RADIATED EMISSIONS	19
	Radiated Emissions of Horizontal for 30MHz to 25GHz.....	19
	Radiated Emissions of Vertical for 30MHz to 25GHz.....	19
4.5	TEST RESULT OF THE BANDEDGE.....	20
	Test Result	21

Chapter 1 General

1.1 Introduction

The following measurement report is submitted on behalf of Applicant in support of a Cordless Telephone certification in accordance with Part 2 Subpart J and Part 15 Subpart C of the Commission's Rules and Regulations.

1.2 Description of EUT:

EUT : Wireless Keyboard
Model No. : F8E838-KBD
Product name : Media Pilot Keyboard
Frequency : 2425MHz
Power Type : Powered by three 1.5VDC AAA batteries

1.3 Test method:

Pretest was found that the emission of operating mode is worse than standby mode. So, The final test is made at the operating mode.

The radiation data record the lowest, middle and highest frequency in this report.

During testing, the EUT was sending a letter "H" continuously to the PC.

During the measurement, the following mode were tested:

#1 Stand-alone Transmitting

#2 Charging by Receiver

The conduction pretest was found out "**#2 Charging by Receiver**" was the worst case.

The radiation pretest was found out "**#1 Stand-alone transmitting**" was the worst case.

We only recorded this data in this report.

While testing, the EUT was made to transmit continuously and adjusted at a position, which transmitted the maximum emission.

The test placement as the photographs showed is the worst case emission placed. (If the emission is close to the ambient, the resolution BW and view resolution will be reduced and the data will be recorded by detection of maximum hold peak mode.)

The testing configuration of test setup is showing in the next page.

1.4 List of Support Equipment

Conducted (Radiated) test:

PC	:	HP Pavilion w1064d
Model No.	:	HP Pavilion w1000
Serial No.	:	THT 42610VZ
FCC ID	:	Doc Approved
Power type	:	AC 100 –127 4.0A, 200-240 2.0A, 50 ~ 60Hz
Power cord	:	Non-shielded, 2.33m long, Plastic, No ferrite core
PC	:	HP Pavilion t123d
Model No.	:	DD281A-AB0
Serial No.	:	TW31720157
FCC ID	:	Doc Approved
Power type	:	AC 100 –127 4.0A, 200-240 2.0A, 50 ~ 60Hz
Power cord	:	Non-shielded, 2.33m length, Plastic, No ferrite core
Monitor	:	HP pavilion mx70
Model No.	:	P1283A
Serial No.	:	THTBR00257
FCC ID	:	DOC Approved
Power type	:	100 ~ 240V AC 15A 50/60Hz
Power cord	:	Shielded, 1.83m long, No ferrite core
Data cable	:	Shielded, 1.46m (1.80m) length, No ferrite core
Keyboard	:	HP
Model No.	:	5219
Serial No.	:	BN31206351
FCC ID	:	E5XKB5209
Power type	:	By PC
Data cable	:	Shielded, 1.60m length
Mouse	:	HP
Model No.	:	MO42KOA
Serial No.	:	0306044011
FCC ID	:	DOC Approved
Power type	:	By PC
Power cord	:	Non-shielded, 1.88m length, No ferrite core

Printer : **HP**
Model No. : C2642A
Serial No. : SG69A196GV
FCC ID : B94C2642X
Power type : 230 VAC, 50Hz
Power cord : Non-shielded, 2m long, no ferrite core
Data cable : Shielded, 1.84m long, no ferrite core

Modem : **ACEEX**
Model No. : DM-1414V
FCC ID : IFAXDM1414
Power type : 120VAC, 60Hz/ 9VAC, 1A
Power cord : Non-shielded, 1.9m long, no ferrite cord
Data cable : RS232, Shielded, 1.2m long, no ferrite core
RJ11C x 2, 7' length, non-shielded, no ferrite core

USB Joystick : **Rockfire**
Model No. : QF-337uv
Serial No. : 10600545
FCC ID : CE Approval
Power type : Powered by PC
Power cable : Shielded, 1.8m length, No ferrite bead data cable

Receiver : **Belkin**
Model No. : F8E838-REX
Serial No. : N/A
FCC ID : CE Approval
Power type : Powered by PC.

1.5 Configuration of Test Setup (Test mode: "#1")

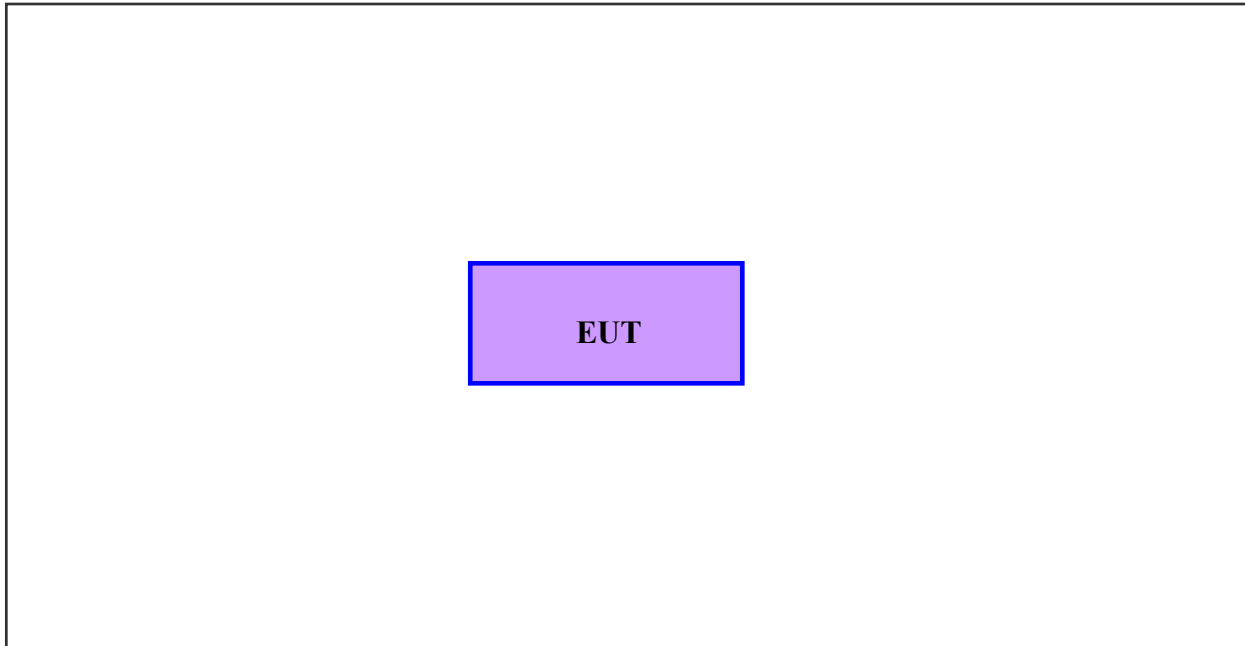

EUT:

Put three AAA size, 1.5V battery into the battery cell of EUT, powers the subject device.
The EUT does not be connected with any product.

Configuration of Test Setup (Test Mode: #2)

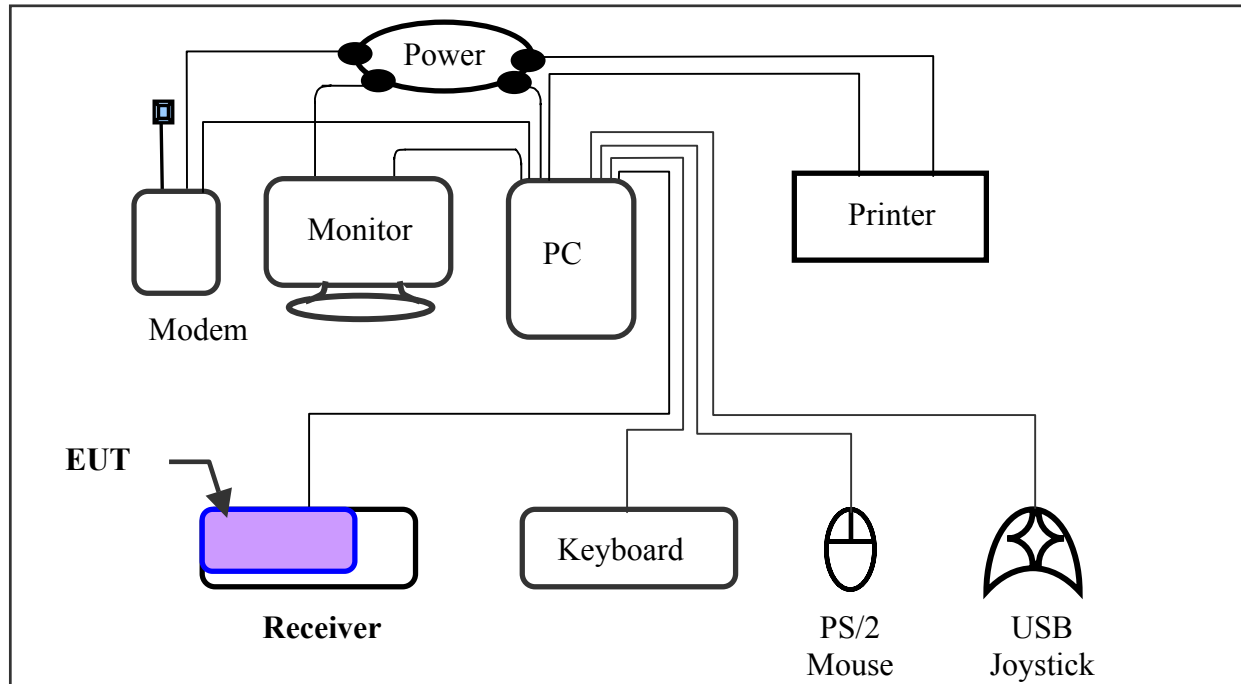

Connections:

PC:

- *Serial Port --- via a 110cm shielded RS-232 cable to an external modem.
- *Monitor Port --- a monitor with 1.5m length data cable.
- *Keyboard port --- a keyboard with 1.5m length data cable.
- *Mouse port --- a mouse with 1.9m length data cable.
- *USB port A --- an USB joystick with 1.8m long, shielded, no ferrite bead data cable.
- *USB port B --- to Receiver
- *Printer port --- a printer with 1.8m length data cable
- (Each port on PC is connected with suitable device)

Receiver:

- *USB Jack --- via a 1.86m length data cable connect to the USB Port B of the PC.

EUT:

- *Put three AAA size, 1.5V battery into the battery cell of EUT and put the EUT on the Receiver.
- The EUT does not be connected with any product.

1.6 Test Procedure

All measurements contained in this report were performed mainly according to the techniques described in Measurement procedure ANSI C63.4.

1.7 Location of the Test Site

The radiated emissions measurements required by the rules were performed on the **three-meter, Anechoic Chamber (FCC Registration Number: 93906)** maintained by *Training Research Co., Ltd.* 1F, No. 255, Nan-yang Street, Shijr, Taipei Hsien 221, Taiwan, R.O.C. Complete description and measurement data have been placed on file with the commission. The conducted power line emissions tests and other test items were performed in an anechoic chamber also located at Training Research Co., Ltd. 1F, No. 255, Nan-yang Street, Shijr, Taipei Hsien 221, Taiwan, R.O.C. *Training Research Co., Ltd.* is listed by the FCC as a facility available to do measurement work for others on a contract basis.

1.8 General Test Condition

The conditions under which the EUT operates were varied to determine their effect on the equipment's emission characteristics. The final configuration of the test system and the mode of operation used during these tests was chosen as that which produced the highest emission levels. However, only those conditions which the EUT was considered likely to encounter in normal use were investigated.

In test, they were set in high power and continuously transmitting mode. The Highest, Middle and Lowest of EUT were all tested. The setting up procedure is recorded on 1.3 Test Method.

Chapter 2 Conducted Emissions Measurements

2.1 Test Condition & Setup

The power line conducted emission measurements were performed in an anechoic chamber. The EUT was assembled on a wooden table, which is 80 centimeters high, was placed 40 centimeters from the backwall and at least 1 meter from the sidewall.

Power was fed to the EUT from the public utility power grid through a line filter and Line Impedance Stabilization Networks (LISNs). The LISN housing, measuring instrumentation case, ground plane, etc., were electrically bonded together at the same RF potential. The Spectrum analyzer (or EMI receiver) was connected to the AC line through an isolation transformer. The 50-ohm output of the LISN was connected to the spectrum analyzer directly. Conducted emission levels were in the CISPR quasi-peak and average detection mode. The analyzer's 6 dB bandwidth was set to 9 KHz. No post-detector video filter was used.

The spectrum was scanned from 150KHz to 30MHz. The physical arrangement of the test system and associated cabling was varied (within the scope of arrangements likely to be encountered in actual use) to determine the effect on the unit's emanations in amplitude and frequency. All spurious emission frequencies were observed.

The highest emission amplitudes relative to the appropriate limit were measured and have been recorded in 2.3.

2.2 List of Test Instruments

Instrument Name	Model	Brand	Serial No.	Calibration Date	
				Last time	Next time
EMI Receiver	8591EM	HP	3710A01203	05/13/04	05/13/05
LISN (EUT)	3825/2	EMCO	9411-2284	07/21/04	07/21/05
LISN (Support E.)	3825/2	EMCO	9210-2007	07/21/04	07/21/05
Preamplifier	CB-001	TRC	98-02	05/29/04	05/29/05
FTB-1-6 Attenuator	15542	mini-circuits	9620 03	05/29/04	05/29/05
20dB Attenuator	CAT-20	mini-circuits	9620 13	05/29/04	05/29/05
Coixal Cable	BNC3200B-0058	Jyebao	CL-05	05/29/04	05/29/05
Coixal Cable	BNC31VB-0316	Jyebao	IF-01ca0069-036	05/29/04	05/29/05
50ohm terminator	370BNM	NARDA	PWR5W	07/21/04	07/21/05
50ohm terminator	370BNM	NARDA	PWR5W	07/21/04	07/21/05
50ohm terminator	370BNM	NARDA	PWR5W	09/03/04	09/03/05
50ohm terminator	370BNM	NARDA	PWR5W	09/03/04	09/03/05

2.3 Test Result of Conducted Emissions

Conducted Emission Test Result: (Test mode: #2)

Testing room : Temperature : 25 ° C Humidity : 70 % RH

Line 1

Frequency (KHz)	READING AMPLITUDE			LIMIT		Margin (dB)
	Peak (dBμV)	Quasi-Peak (dBμV)	Average (dBμV)	Quasi-Peak (dBμV)	Average (dBμV)	
645.00	39.80	*** **	*** **	56.00	46.00	-6.20
1292.00	37.13	*** **	*** **	56.00	46.00	-8.87
1866.00	37.91	*** **	*** **	56.00	46.00	-8.09
2220.00	38.40	*** **	*** **	56.00	46.00	-7.60
2460.00	38.62	*** **	*** **	56.00	46.00	-7.38
2780.00	37.92	*** **	*** **	56.00	46.00	-8.08
3100.00	37.85	*** **	*** **	56.00	46.00	-8.15
4080.00	37.21	*** **	*** **	56.00	46.00	-8.79
11450.00	39.77	*** **	*** **	60.00	50.00	-10.23
17330.00	41.62	*** **	*** **	60.00	50.00	-8.38

Line 2

Frequency (KHz)	READING AMPLITUDE			LIMIT		Margin (dB)
	Peak (dBμV)	Quasi-Peak (dBμV)	Average (dBμV)	Quasi-Peak (dBμV)	Average (dBμV)	
645.00	43.83	*** **	*** **	56.00	46.00	-2.17
724.00	41.24	*** **	*** **	56.00	46.00	-4.76
969.00	39.86	*** **	*** **	56.00	46.00	-6.14
1292.00	39.67	*** **	*** **	56.00	46.00	-6.33
1616.00	40.19	*** **	*** **	56.00	46.00	-5.81
1935.00	41.15	*** **	*** **	56.00	46.00	-4.85
2460.00	42.28	*** **	*** **	56.00	46.00	-3.72
3120.00	43.36	*** **	*** **	56.00	46.00	-2.64
3440.00	41.55	*** **	*** **	56.00	46.00	-4.45
17650.00	43.54	*** **	*** **	60.00	50.00	-6.46

***The reading amplitudes are all under limit.**

Chapter 3 Transmitter Duty Cycle Measurements

3.1 Test Condition and Setup

The duty cycle measurements were performed in a shielded enclosure. The EUT was placed on a wooded table which is 0.8 meters height and a bi-log periodic antenna was used distance about 3 meters for receiving. While testing EUT was set to transmit continuously. Various key configurations were also investigated to find the maximum duty cycle.

The resolution bandwidth and video bandwidth of the spectrum analyzer was all set to 1MHz to encompass all significant spectral components during the test. The analyzer operated in linear scale and zero span mode after tuning to the transmitter carrier frequency. The spectrum analyzer measured pules width. The pulse width was determined by the difference between the two half voltage points on a pulse.

The duty cycle was determined by the following equation:

$$\text{Duty Cycle (\%)} = \frac{\text{Total on interval in a complete pulse train}}{\text{Length of a complete pulse train}} \times 100\%$$

To calculate the actual field intensity, the duty cycle correction factor in decibel is needed for later use and be obtained from following conversion:

$$\text{Duty Cycle Correction Factor (dB)} = 20 \times \text{Log}_{10} \text{Duty Cycle}$$

3.2 List of Test Instruments

Instrument Name	Model No.	Brand	Serial No.	Calibration Date	
				Last time	Next time
EMI Receiver	8546A	H P	3520A00242	07/28/04	07/28/05
RF Filter Section	85460A	H P	3448A00217	07/28/04	07/28/05
Spectrum Analyzer	MS2665C	ANRITSU	6200175476	09/30/04	09/30/05
Bi-log Antenna	CBL 6141A	CHASE	4206	05/27/04	05/27/05

3.3 Test Instruments Configuration

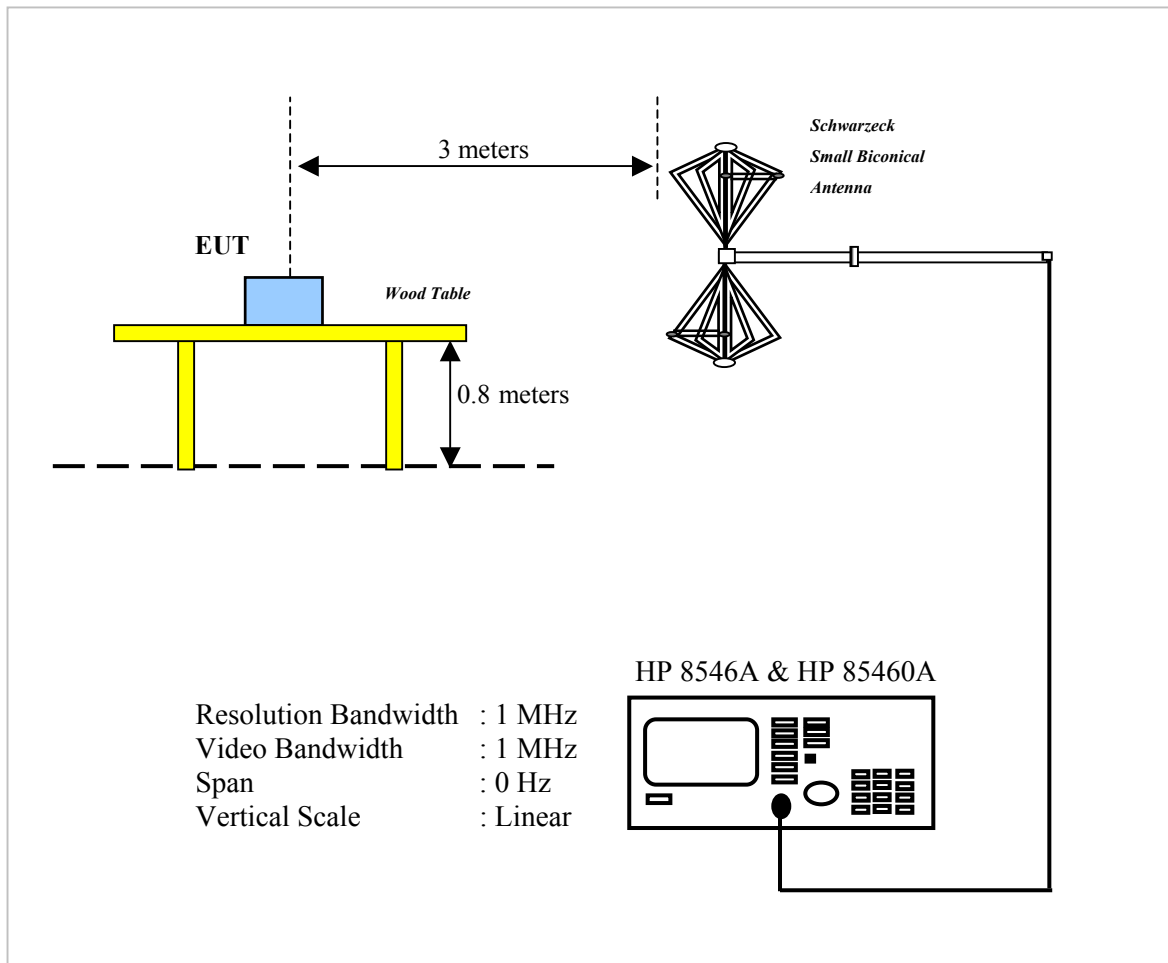

3.4 Test Result

Following is the test result, which produce maximum duty cycle:

Total on interval in a complete pulse train

$$= 710 \mu s$$

Length of a complete pulse train

$$= 2.640 ms$$

$$\text{Duty Cycle (\%)} = 710 \mu s / 2640 \mu s * 100\% = 26.89\%$$

$$\text{Duty Cycle Correction Factor (dB)} = 20 * \text{Log} (0.2689) = -11.41 \text{ dB}$$

A plot is attached on the following page.

Duty Cycle Test Picture

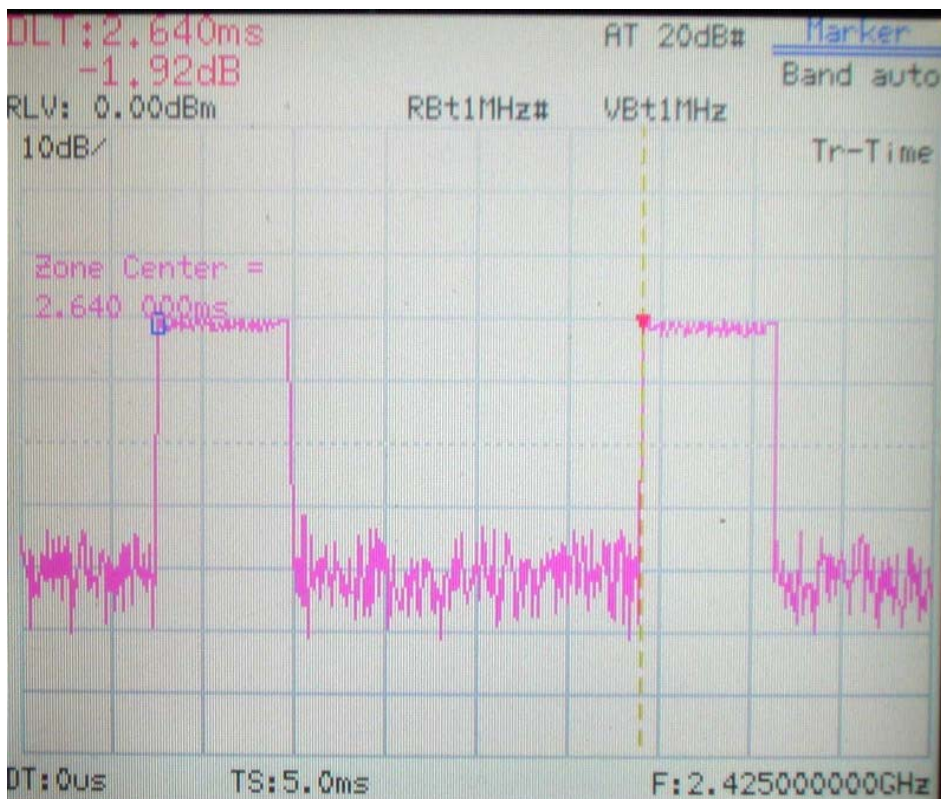
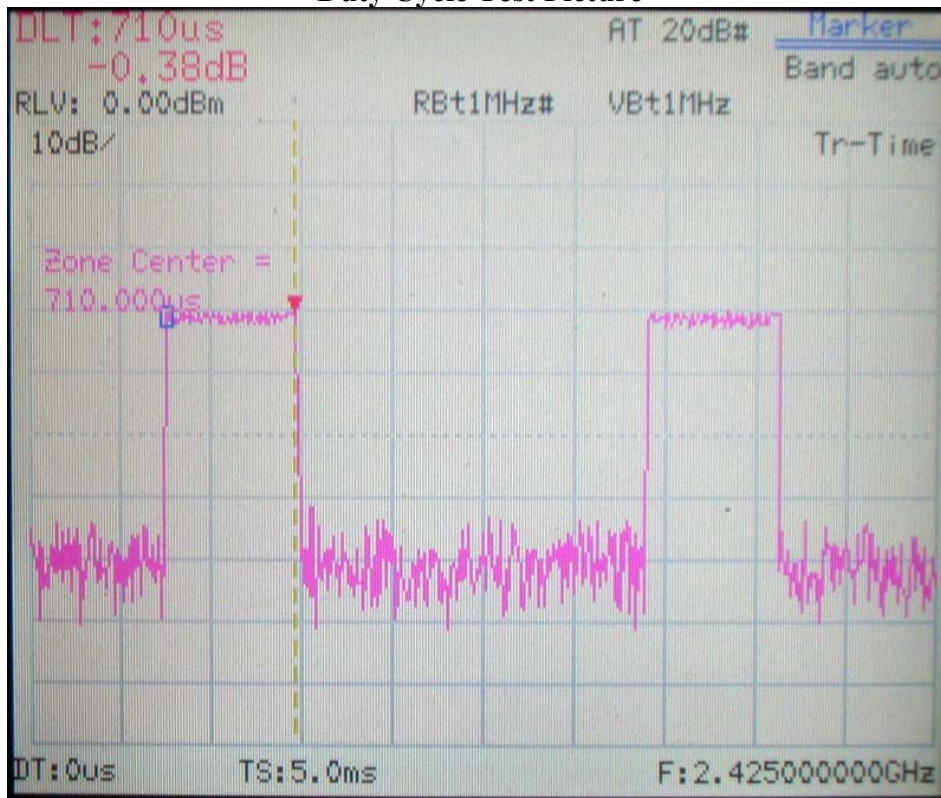

Chapter 4 Radiated Emissions Measurements

4.1 Test Condition & Setup

We'd performed the test by the radiated emission skill: The EUT was placed in an anechoic chamber, and set the EUT transmitting continuously and scanned at 3-meter distance to determine its emission characteristics. The physical arrangement of the EUT was varied (within the scope of arrangements likely to be encountered in actual use) to determine the effect on the unit's emanations in amplitude, directivity, and frequency. The exact system configuration, which produced the highest emissions was noted so it could be reproduced later during the final tests. For the measurement above 1GHz, according to the guidance we'd set the spectrum analyzer's 6dB bandwidth RBW to 1MHz.

This was done to ensure that the final measurements would demonstrate the worst-case interference potential of the EUT.

Final radiation measurements were made on a three-meter, anechoic chamber. The EUT system was placed on a nonconductive turntable, which is 0.8 meters height, top surface 1.0 x 1.5 meter.

The spectrum was examined from 30 MHz to 1000 MHz using an Hewlett Packard 85460A EMI Receiver, SCHWARZECK whole range Small Biconical Antenna (Model No.: UBAA9114 & BBVU9135) is used to measure frequency from 30 MHz to 1GHz. The final test is used the HP 85460A spectrum and 8564E spectrum was examined from 1GHz to 25GHz using an Hewlett Packard Spectrum Analyzer, EMCO/HP Horn Antenna (Model 3115 / 84125-80008) for 1G - 25GHz.

A nonconductive material surrounded the EUT to supporting the EUT for standing on three orthogonal planes. At each frequency, the EUT was rotated 360 degrees, and the antenna was raised and lowered from one to four meters to find the maximum emission levels. Measurements were taken using both horizontal and vertical antenna polarization.

Appropriate preamplifiers were used for improving sensitivity and precautions were taken to avoid overloading or desensitizing the spectrum analyzer. There are two spectrum analyzers use on this testing, HP 85460A for frequency 30MHz to 1000MHz, and 8564E for frequency 1GHz to 25GHz. No post-detector video filters were used in the test. The spectrum analyzer's 6dB bandwidth was set to 120KHz (spectrum was examined from 30 MHz to 1000 MHz), the spectrum analyzer's 6 dB bandwidth was set to 1 MHz (spectrum was examined from 1GHz to 25GHz) and the analyzer was operated in the maximum hold mode. There is a test condition applies in this test item, the test procedure description as the following:

Three channels were tested, one in the top, one in the middle and the other in bottom. The setting up procedure is recorded on <1.3>

With the transmitter operating from a AC source and using the internal of EUT, radiates spurious emissions falling within the restricted bands of 15.209 were measured at operating frequencies corresponding to upper, middle and bottom channels in the 2400 ~ 2483.5 MHz band.

The actual field intensity in decibels referenced to 1 microvolt per meter (dB μ V/m) is determined by algebraically adding the measured reading in dB μ V, the antenna factor (dB), and cable loss (dB) at the appropriate frequency. Since the EUT was set to transmit continuously, with *duty cycle* is present.

The radiation

For frequency between 30MHz to 1000MHz

$$F_{Ia} \text{ (dB}\mu\text{V/m)} = F_{Ir} \text{ (dB}\mu\text{V)} + \text{Correction Factors} + \text{Duty Cycle}$$

F_{Ia} : Actual Field Intensity

F_{Ir} : Reading of the Field Intensity

$$\text{Correction Factors} = \text{Antenna Factor} + \text{Cable Loss} - \text{Amplifier Gain}$$

For frequency between 1GHz to 25GHz

$$F_{Ia} \text{ (dB}\mu\text{V/m)} = F_{Ir} \text{ (dB}\mu\text{V)} + \text{Correction Factor} + \text{Duty Cycle}$$

F_{Ia} : Actual Field Intensity

F_{Ir} : Reading of the Field Intensity

$$\text{Correction Factors} = \text{Antenna Factor} + \text{Cable Loss} - \text{Amplifier Gain}$$

4.2 List of Test Instruments

Instrument Name	Model	Brand	Serial No.	Calibration Date	
				Last time	Next time
EMI Receiver	8546A	HP	3520A00242	07/28/04	07/28/05
RF Filter Section	85460A	HP	3448A00217	07/28/04	07/28/05
Small Biconical Antenna	UBAA9114 & BBVU9135	SCHWARZECK	127	06/21/04	06/21/05
Pre-amplifier	PA1F	TRC	1FAC	05/20/04	05/20/05
Auto Switch Box (>30MHz)	ASB-01	TRC	9904-01	05/20/04	05/20/05
Coaxial Cable (Double shielded, 15 meter)	A30A30-0058-50FS-15M	JYEBAO	SMA-01	05/20/04	05/20/05
Coaxial Cable (1.1 meter)	A30A30-0058-50FS-1M	JYEBAO	SMA-02	05/20/04	05/20/05
Spectrum Analyzer	8564E	HP	3720A00840	07/23/04	07/23/05
Microwave Preamplifier	84125C	HP	US36433002	07/30/04	07/30/05
Horn Antenna	3115	EMCO	9104-3668	12/18/04	12/18/05
Standard Guide Horn Antenna	84125-80008	HP	18-26.5GHz	09/18/04	09/18/05
Standard Guide Horn Antenna	84125-80001	HP	26.5-40GHz	09/18/04	09/18/05
Pre-amplifier	84125C	HP	US36433002	11/19/04	11/19/05
Horn Antenna	1196E (3115)	HP (EMCO)	9704-5178	12/12/04	12/12/05
Pre-amplifier	PA2F	TRC	2F1GZ	05/20/04	05/20/05
Coaxial Cable (3 miter)	A30A30-0058-50FS T118	JYEBAO	MSA-05	05/20/04	05/20/05
Coaxial Cable (1 meter)	A30A30-0058-50FS T118	JYEBAO	MSA-04	05/20/04	05/20/05

4.3 Test Result of Radiated Emissions

The peak values of fundamental emissions from the EUT at various antenna heights, antenna polarization, EUT orientation, etc. are recorded on the following.

Testing room : Temperature : 25 ° C Humidity : 73 % RH

Fundamental Emissions

Frequency (MHz)	A. P. (H/V)	A.H. (m)	Table (degree)	Peak (dB μ V/m)	Duty Cycle (dB)	True Value (dB μ V/m)	Limit (dB μ V)	Margin (dB μ V)
2425	H	1.00	338	84.11	-11.41	72.70	94.00	-21.30
	V	1.00	284	69.61	-11.41	58.20	94.00	-35.80

Note:

1. A. P. means antenna polarization, horizontal and vertical.
2. A. H. means antenna height.
3. Table means turntable turning position.
4. Amplitude means the fundamental emission measured.
5. Margin = Amplitude – limit

4.4 Test Result of Spurious Radiated Emissions

The highest peak values of radiated emissions from the EUT at various antenna heights, antenna polarization, EUT orientation, etc. are recorded on the following.

Testing room : Temperature : 25 ° C Humidity : 73 % RH

Radiated Emissions of Horizontal for 30MHz to 25GHz

Radiated Emission				CF	Peak Value	Duty Cycle	True Value	FCC Class B	
Frequency (MHz)	Amplitude (dBμV)	Ant. H. (m)	Angle	(dB)	(dBμV/m)	(dB)	(dBμV/m)	Limit (dBμV/m)	Margin (dB)
903.61	11.68	1.00	78	16.02	27.70	---	27.70	46.02	-18.32
956.35	12.90	1.00	150	17.64	30.54	---	30.54	46.02	-15.48
1643.75	35.16	1.00	210	13.65	48.81	-11.41	37.40	53.96	-16.56
1820.83	37.33	1.00	191	10.89	48.22	-11.41	36.81	53.96	-17.15
2514.58	36.00	1.00	34	9.52	45.52	-11.41	34.11	53.96	-19.85
*4853.33	26.40	1.00	265	14.90	41.30	-11.41	29.89	53.96	-24.07
7276.04	27.24	1.00	255	21.56	48.80	-11.41	37.39	53.96	-16.57
9704.79	23.90	1.00	19	23.13	47.03	-11.41	35.62	53.96	-18.34
*12127.50	28.57	1.00	243	20.52	49.09	-11.41	37.68	53.96	-16.28
14550.21	31.91	1.00	101	19.21	51.12	-11.41	39.71	53.96	-14.25

Radiated Emissions of Vertical for 30MHz to 25GHz

Radiated Emission				CF	Peak Value	Duty Cycle	True Value	FCC Class B	
Frequency (MHz)	Amplitude (dBμV)	Ant. H. (m)	Angle	(dB)	(dBμV/m)	(dB)	(dBμV/m)	Limit (dBμV/m)	Margin (dB)
530.47	19.18	1.05	0	7.59	26.77	---	26.77	46.02	-19.25
557.08	16.96	1.36	94	8.34	25.30	---	25.30	46.02	-20.72
*1437.50	33.83	1.00	169	16.11	49.94	-11.41	38.53	53.96	-15.43
1820.83	41.16	1.00	217	10.89	52.05	-11.41	40.64	53.96	-13.32
2152.08	35.66	1.00	250	8.52	44.18	-11.41	32.77	53.96	-21.19
*4853.33	27.24	1.00	247	14.90	42.14	-11.41	30.73	53.96	-23.23
*7270.00	27.74	1.00	100	21.55	49.29	-11.41	37.88	53.96	-16.08
9704.79	24.07	1.00	148	23.13	47.20	-11.41	35.79	53.96	-18.17
*12127.50	27.74	1.00	0	20.52	48.26	-11.41	36.85	53.96	-17.11
14550.21	31.24	1.00	108	19.21	50.45	-11.41	39.04	53.96	-14.92

4.5 Test Result of the Bandedge

§ 15.249 (c) Emissions radiated outside of the specified frequency bands, except for harmonics, shall be attenuated by at least 50dB below the level of the fundamental or to the general radiated emission limits in §15.209, whichever is the lesser attenuation.

We perform this section by the *radiated manner*, the RBW is set to 100kHz and VBW>RBW. We'd made the observation *up to 10th harmonics and the criterion is all the harmonic/spurious emissions must be 50dB below the highest emission level measured*. If the emissions fall in the restricted bands stated in the Part15.205(a) must also *comply with the radiated emission limits specified in Part15.209(a)*. (*Peak mode: RBW=VBW=1MHz, Average mode: RBW=1MHz; VBW=10Hz*)

The following pages show our observations referring to the lowest channel and highest channel respectively. Test Condition & Setup: same as 4.1 to 4.2.

Test Result

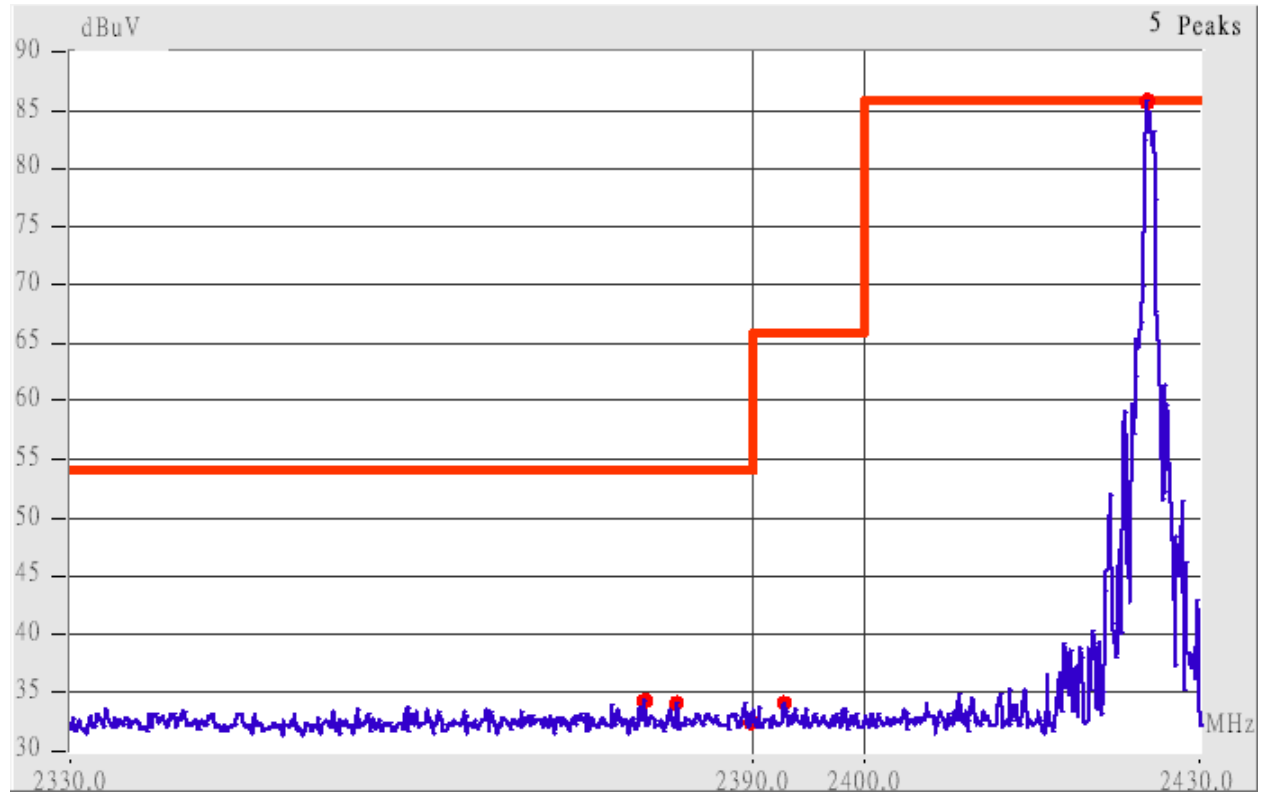

This is the hard copy of our bandedge measurement generated by our bandedge testing program. The plot shown above is the bandedge of lowest channel.

1. The lobe left by the fundamental side is already 50dB below the highest emission level.
2. The emissions recorded in the restricted band is do comply with the Part 15.209(a) – as below.



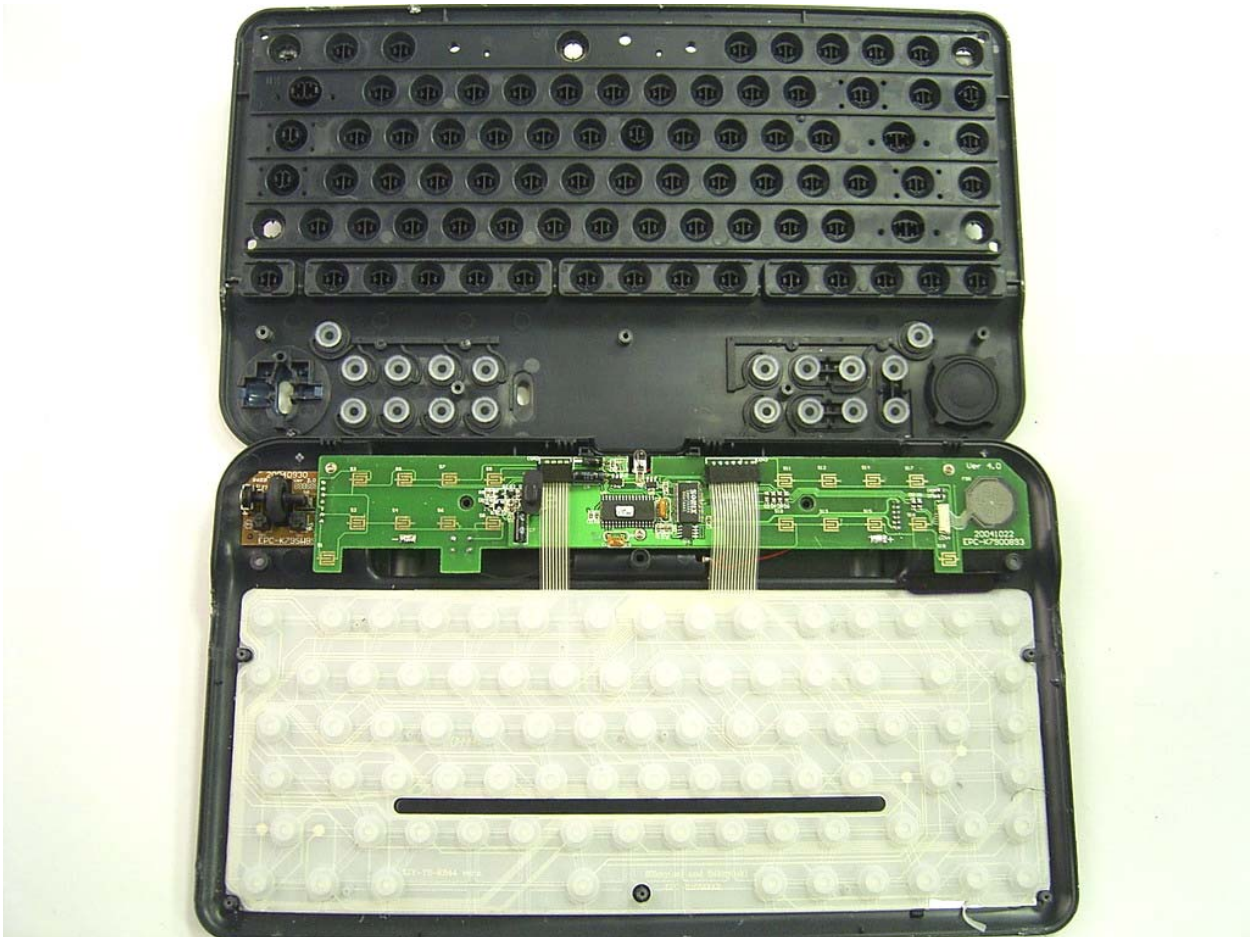

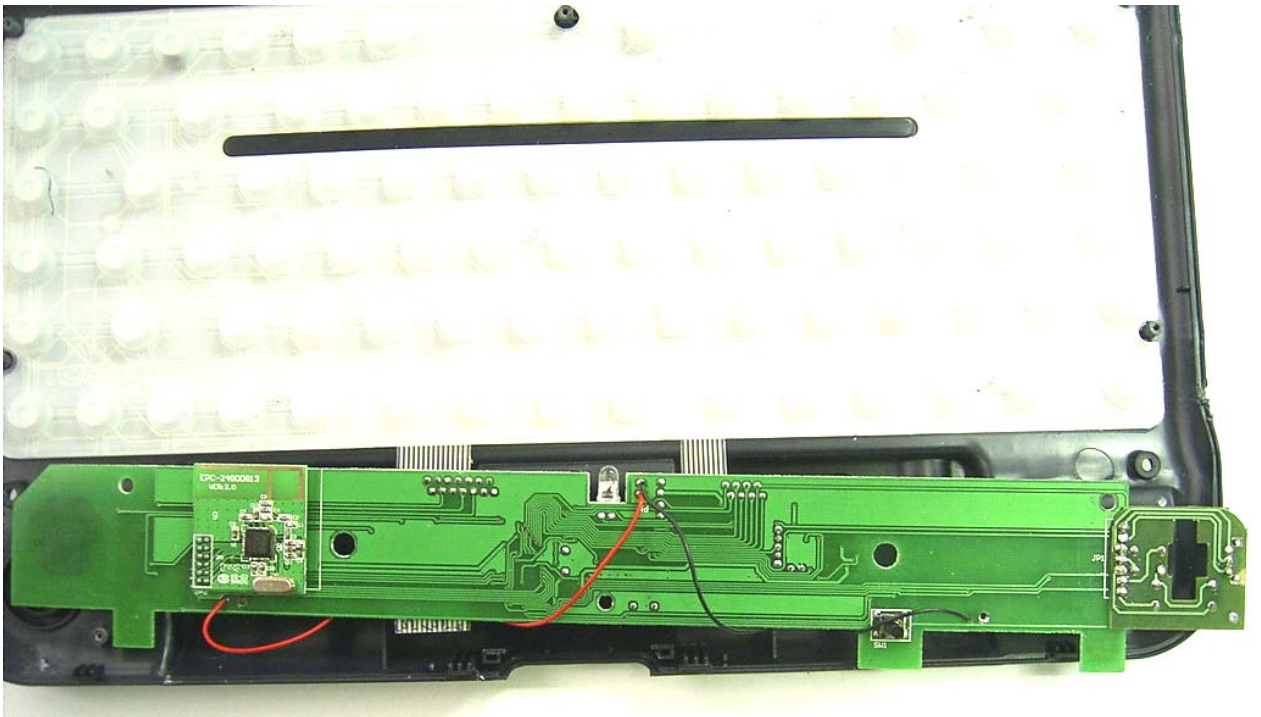
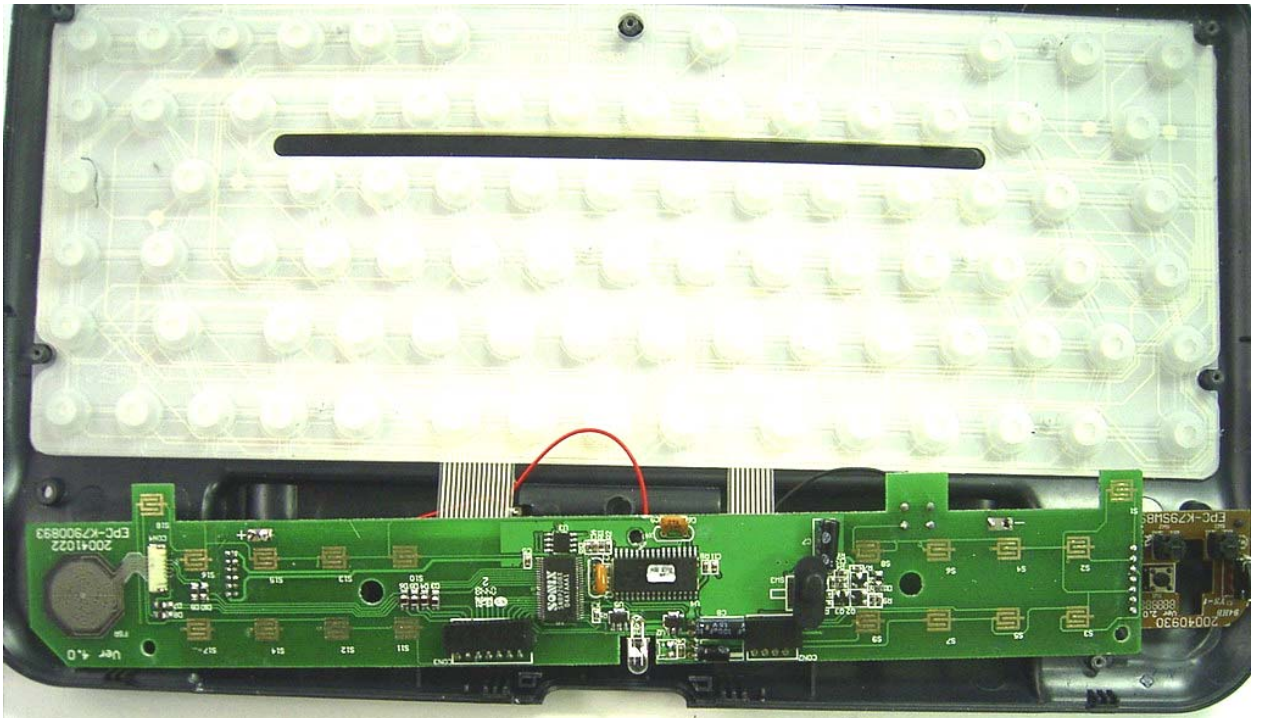

LABEL Format:



LABEL Size: 55.4 x 33.09 mm

LABEL Position:

