



SPORTON International Inc.

No. 52, Hwa Ya 1st Rd., Hwa Ya Technology Park, Kwei-Shan Hsiang, Tao Yuan Hsien, Taiwan, R.O.C.
Ph: 886-3-327-3456 / FAX: 886-3-327-0973 / www.sporton.com.tw

FCC RADIO TEST REPORT

Applicant's company	Belkin International, Inc.
Applicant Address	12045 East Waterfront Drive, Playa Vista, CA 90094
FCC ID	K7SF7D7501V1

Product Name	Miracast Video Adapter
Brand Name	belkin
Model No.	F7D7501v1
Test Rule Part(s)	47 CFR FCC Part 15 Subpart E § 15.407
Test Freq. Range	5150 ~ 5250 MHz / 5725 ~ 5850 MHz
Received Date	May 05, 2016
Final Test Date	May 10, 2016
Submission Type	Class II Change

Statement

Test result included is for the IEEE 802.11n and IEEE 802.11a of the product.

The test result in this report refers exclusively to the presented test model / sample.

Without written approval of SPORTON International Inc., the test report shall not be reproduced except in full.

The measurements and test results shown in this test report were made in accordance with the procedures and found in compliance with the limit given in **ANSI C63.10-2013, 47 CFR FCC Part 15 Subpart E, KDB789033 D02 v01r02, KDB662911 D01 v02r01, ET Docket No. 13-49; FCC 16-24.**

The test equipment used to perform the test is calibrated and traceable to NML/ROC.



Table of Contents

1. VERIFICATION OF COMPLIANCE	1
2. SUMMARY OF THE TEST RESULT	2
3. GENERAL INFORMATION	3
3.1. Product Details.....	3
3.2. Accessories.....	4
3.3. Table for Filed Antenna.....	5
3.4. Table for Carrier Frequencies	5
3.5. Table for Test Modes	6
3.6. Table for Testing Locations.....	7
3.7. Table for Class II Change	7
3.8. Table for Supporting Units	8
3.9. Table for Parameters of Test Software Setting	8
3.10. EUT Operation during Test	8
3.11. Duty Cycle	8
3.12. Test Configurations	9
4. TEST RESULT	10
4.1. 26dB Bandwidth and 99% Occupied Bandwidth Measurement.....	10
4.2. 6dB Spectrum Bandwidth Measurement	20
4.3. Maximum Conducted Output Power Measurement.....	24
4.4. Power Spectral Density Measurement	27
4.5. Radiated Emissions Measurement	34
4.6. Band Edge Emissions Measurement	53
4.7. Frequency Stability Measurement	61
4.8. Antenna Requirements	66
5. LIST OF MEASURING EQUIPMENTS	67
6. MEASUREMENT UNCERTAINTY	68
APPENDIX A. TEST PHOTOS	A1 ~ A2



History of This Test Report

REPORT NO.	VERSION	DESCRIPTION	ISSUED DATE
FR4N1172-40	Rev. 01	Initial issue of report	Jun. 24, 2016

1. VERIFICATION OF COMPLIANCE

Product Name : Miracast Video Adapter
Brand Name : belkin
Model No. : F7D7501v1
Applicant : Belkin International, Inc.
Test Rule Part(s) : 47 CFR FCC Part 15 Subpart E § 15.407

Sporton International as requested by the applicant to evaluate the EMC performance of the product sample received on May 05, 2016 would like to declare that the tested sample has been evaluated and found to be in compliance with the tested rule parts. The data recorded as well as the test configuration specified is true and accurate for showing the sample's EMC nature.



Sam Chen

SPORTON INTERNATIONAL INC.

2. SUMMARY OF THE TEST RESULT

Applied Standard: 47 CFR FCC Part 15 Subpart E				
Part	Rule Section	Description of Test	Result	Under Limit
4.1	15.407(a)	26dB Spectrum Bandwidth and 99% Occupied Bandwidth	Complies	-
4.2	15.407(e)	6dB Spectrum Bandwidth	Complies	-
4.3	15.407(a)	Maximum Conducted Output Power	Complies	7.84 dB
4.4	15.407(a)	Power Spectral Density	Complies	7.88 dB
4.5	15.407(b)	Radiated Emissions	Complies	0.27 dB
4.6	15.407(b)	Band Edge Emissions	Complies	1.48 dB
4.7	15.407(g)	Frequency Stability	Complies	-
4.8	15.203	Antenna Requirements	Complies	-

3. GENERAL INFORMATION

3.1. Product Details

Items	Description
Product Type	IEEE 802.11a: WLAN (1TX, 1RX) IEEE 802.11n: WLAN (2TX, 2RX)
Radio Type	Intentional Transceiver
Power Type	5V from USB power input
Modulation	IEEE 802.11a: OFDM IEEE 802.11n: see the below table
Data Modulation	IEEE 802.11a/n: OFDM (BPSK / QPSK / 16QAM / 64QAM)
Data Rate (Mbps)	IEEE 802.11a: OFDM (6/9/12/18/24/36/48/54) IEEE 802.11n: see the below table
Frequency Range	5150 ~ 5250 MHz / 5725 ~ 5850 MHz
Channel Number	9 for 20MHz bandwidth ; 4 for 40MHz bandwidth
Channel Band Width (99%)	Band 1: IEEE 802.11a: 17.02 MHz IEEE 802.11ac MCS0 (VHT20): 18.15 MHz IEEE 802.11ac MCS0 (VHT40): 37.05 MHz Band 4: IEEE 802.11a: 17.11 MHz IEEE 802.11ac MCS0 (VHT20): 17.97 MHz IEEE 802.11ac MCS0 (VHT40): 36.90 MHz
Maximum Conducted Output Power	Band 1: IEEE 802.11a: 13.15 dBm IEEE 802.11ac MCS0 (VHT20): 16.14 dBm IEEE 802.11ac MCS0 (VHT40): 10.24 dBm Band 4: IEEE 802.11a: 22.05 dBm IEEE 802.11ac MCS0 (VHT20): 21.86 dBm IEEE 802.11ac MCS0 (VHT40): 17.76 dBm
Carrier Frequencies	Please refer to section 3.4
Antenna	Please refer to section 3.3

Items	Description	
Communication Mode	<input checked="" type="checkbox"/> IP Based (Load Based)	<input type="checkbox"/> Frame Based
Beamforming Function	<input type="checkbox"/> With beamforming	<input checked="" type="checkbox"/> Without beamforming
Operate Condition	<input checked="" type="checkbox"/> Indoor	<input type="checkbox"/> Outdoor

Antenna and Band width

Antenna	Single (TX)		Two (TX)	
	20 MHz	40 MHz	20 MHz	40 MHz
IEEE 802.11a	V	X	X	X
IEEE 802.11n	X	X	V	V

IEEE 11n Spec.

Protocol	Number of Transmit Chains (NTX)	Data Rate / MCS
802.11n (HT20)	2	MCS0-15
802.11n (HT40)	2	MCS0-15

Note 1: IEEE Std. 802.11n modulation consists of HT20 and HT40 (HT: High Throughput).
Then EUT supports HT20 and HT40.

Note 2: Modulation modes consist of below configuration: HT20/HT40: IEEE 802.11n

3.2. Accessories

N/A

3.3. Table for Filed Antenna

Ant.	Brand	Part Number	Antenna Type	Connector	Gain (dBi)	
					2.4G	5G
1	ACX	AT3216-B2R7HAA	Multilayer chip antenna	N/A	0.5	-
2	ACX	AT3216-B5R5HAA	Multilayer chip antenna	N/A	-	2

Note: The EUT has two antennas.

<For 5GHz Function>

For IEEE 802.11a mode (1TX, 1RX):

Only chain 1 could transmit/receive simultaneously.

For IEEE 802.11n mode (2TX, 2RX):

Chain 1 and chain 2 could transmit/receive simultaneously.

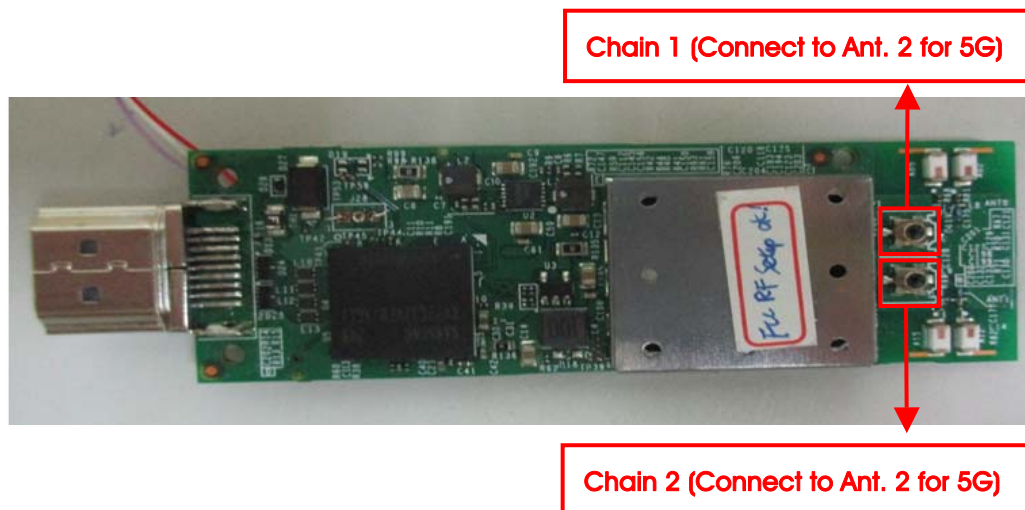

3.4. Table for Carrier Frequencies

There are three bandwidth systems.

For 20MHz bandwidth systems, use Channel 36, 40, 44, 48, 149, 153, 157, 161, 165.

For 40MHz bandwidth systems, use Channel 38, 46, 151, 159.

Frequency Band	Channel No.	Frequency	Channel No.	Frequency
5150~5250 MHz Band 1	36	5180 MHz	44	5220 MHz
	38	5190 MHz	46	5230 MHz
	40	5200 MHz	48	5240 MHz
5725~5850 MHz Band 4	149	5745 MHz	159	5795 MHz
	151	5755 MHz	161	5805 MHz
	153	5765 MHz	165	5825 MHz
	157	5785 MHz	-	-

3.5. Table for Test Modes

Preliminary tests were performed in different data rate to find the worst radiated emission. The data rate shown in the table below is the worst-case rate with respect to the specific test item. Investigation has been done on all the possible configurations for searching the worst cases. The following table is a list of the test modes shown in this test report.

Test Items	Mode		Data Rate	Channel	Chain
Max. Conducted Output Power	11a/BPSK	Band 1&4	6Mbps	36/40/48/149/ 157/165	1
	11n HT20	Band 1&4	MCS0	36/40/48/149/ 157/165	1+2
	11n HT40	Band 1&4	MCS0	38/46/151/159	1+2
Power Spectral Density	11a/BPSK	Band 1&4	6Mbps	36/40/48/149/ 157/165	1
	11n HT20	Band 1&4	MCS0	36/40/48/149/ 157/165	1+2
	11n HT40	Band 1&4	MCS0	38/46/151/159	1+2
26dB Spectrum Bandwidth & 99% Occupied Bandwidth Measurement	11a/BPSK	Band 1&4	6Mbps	36/40/48/149/ 157/165	1
	11n HT20	Band 1&4	MCS0	36/40/48/149/ 157/165	1+2
	11n HT40	Band 1&4	MCS0	38/46/151/159	1+2
6dB Spectrum Bandwidth Measurement	11a/BPSK	Band 4	6Mbps	149/157/165	1
	11n HT20	Band 4	MCS0	149/157/165	1+2
	11n HT40	Band 4	MCS0	151/159	1+2
Radiated Emission Above 1GHz	11a/BPSK	Band 1&4	6Mbps	36/40/48/149/ 157/165	1
	11n HT20	Band 1&4	MCS0	36/40/48/149/ 157/165	1+2
	11n HT40	Band 1&4	MCS0	38/46/151/159	1+2
Band Edge Emission	11a/BPSK	Band 1&4	6Mbps	36/40/48/149/ 157/165	1
	11n HT20	Band 1&4	MCS0	36/40/48/149/ 157/165	1+2
	11n HT40	Band 1&4	MCS0	38/46/151/159	1+2
Frequency Stability	20 MHz	Band 1&4	-	40/157	2
	40 MHz	Band 1&4	-	38/151	2

The following test modes were performed for all tests:

For Radiated Emission above 1GHz test:

The EUT was performed at X axis, Y axis and Z axis position for Radiated emission above 1GHz test, and the worst case was found at X axis. So the measurement will follow this same test configuration.

3.6. Table for Testing Locations

Test Site Location					
Address:	No.8, Lane 724, Bo-ai St., Jhubei City, Hsinchu County 302, Taiwan, R.O.C.				
TEL:	886-3-656-9065				
FAX:	886-3-656-9085				
Test Site No.	Site Category	Location	FCC Designation No.	IC File No.	VCCI Reg. No
03CH01-CB	SAC	Hsin Chu	TW0006	IC 4086D	-
TH01-CB	OVEN Room	Hsin Chu	-	-	-

Open Area Test Site (OATS); Semi Anechoic Chamber (SAC).

3.7. Table for Class II Change

Below is the table for the change of the product with respect to the original one.

Modifications	Performance Checking
1. Updating Band 1 to "New Rules " from "Old Rules".	1. Maximum Conducted Output Power 2. 26dB Bandwidth and 99% Occupied Bandwidth 3. Power Spectral Density 4. Radiated Emissions (above 1GHz) 5. Band Edge Emissions 6. Frequency Stability
2. Updating Band 4 to "15.407 (b)(4)(i) of New Rules (ET Docket No. 13-49; FCC 16-24)" from "Old Rules".	1. 26dB Bandwidth and 99% Occupied Bandwidth 2. 6dB Spectrum Bandwidth 3. Maximum Conducted Output Power 4. Power Spectral Density 5. Radiated Emissions (above 1GHz) 6. Band Edge Emissions 7. Frequency Stability

3.8. Table for Supporting Units

Support Unit	Brand	Model	FCC ID
Notebook	DELL	E4300	DoC

3.9. Table for Parameters of Test Software Setting

During testing, Channel and Power Controlling Software provided by the customer was used to control the operating channel as well as the output power level. The RF output power selection is for the setting of RF output power expected by the customer and is going to be fixed on the firmware of the final end product.

Test Software Version	Mtool2.0.1.0					
Mode	Test Frequency (MHz)					
	NCB: 20MHz					
	5180 MHz	5200 MHz	5240 MHz	5745 MHz	5785 MHz	5825 MHz
802.11a	56	55	55	68	68	68
802.11n MCS0 HT20	55	55	55	50	50	50
Mode	NCB: 40MHz					
802.11n MCS0 HT40	5190 MHz		5230 MHz		5755 MHz	
	31		31		30	

3.10. EUT Operation during Test

The EUT was programmed to be in continuously transmitting mode.

3.11. Duty Cycle

Mode	On Time (ms)	On+Off Time (ms)	Duty Cycle (%)	Duty Factor (dB)	1/T Minimum VBW (kHz)
802.11a	2.027	2.083	97.31	0.12	0.49
802.11n MCS0 HT20	1.875	1.931	97.10	0.13	0.53
802.11n MCS0 HT40	2.400	2.480	96.77	0.14	0.42

3.12. Test Configurations

3.12.1. Radiation Emissions Test Configuration

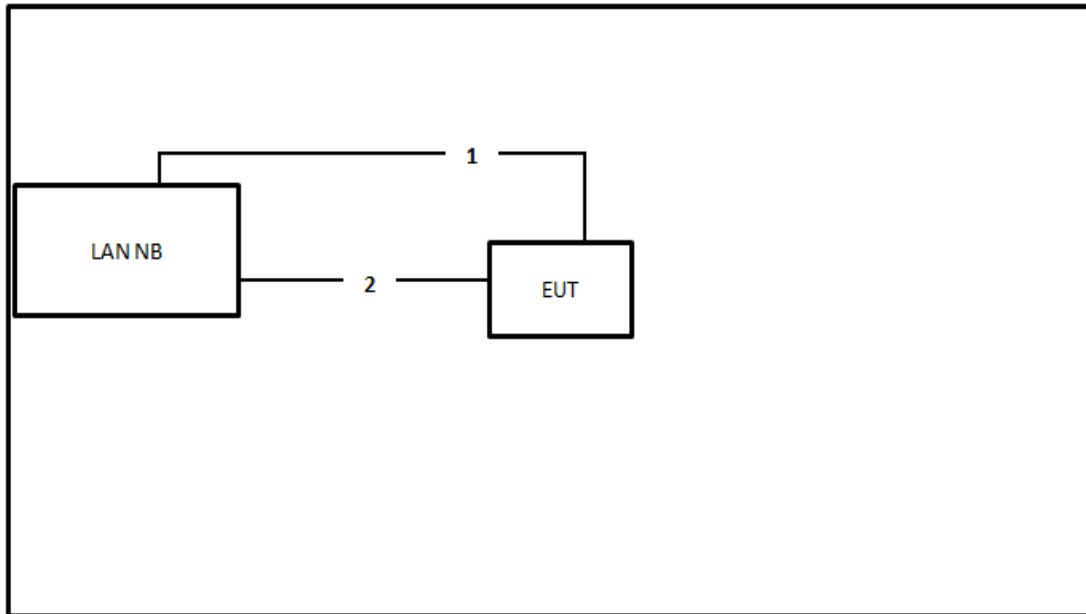

Item	Connection	Shielded	Length
1	console cable	No	0.15m
2	Micro USB	No	0.5m

4. TEST RESULT

4.1. 26dB Bandwidth and 99% Occupied Bandwidth Measurement

4.1.1. Limit

No restriction limits.

4.1.2. Measuring Instruments and Setting

Please refer to section 5 of equipments list in this report. The following table is the setting of the spectrum analyzer.

26dB Bandwidth	
Spectrum Parameters	Setting
Attenuation	Auto
Span Frequency	> 26dB Bandwidth
RBW	Approximately 1% of the emission bandwidth
VBW	VBW > RBW
Detector	Peak
Trace	Max Hold
Sweep Time	Auto
99% Occupied Bandwidth	
Spectrum Parameters	Setting
Span	1.5 times to 5.0 times the OBW
RBW	1 % to 5 % of the OBW
VBW	$\geq 3 \times \text{RBW}$
Detector	Peak
Trace	Max Hold

4.1.3. Test Procedures

For Radiated 26dB Bandwidth and 99% Occupied Bandwidth Measurement:

1. The transmitter was radiated to the spectrum analyzer in peak hold mode.
2. Measure the maximum width of the emission that is 26 dB down from the peak of the emission. Compare this with the RBW setting of the analyzer. Readjust RBW and repeat measurement as needed until the RBW/EBW ratio is approximately 1%.

4.1.4. Test Setup Layout

For Radiated 26dB Bandwidth and 99% Occupied Bandwidth Measurement:

This test setup layout is the same as that shown in section 4.5.4.

4.1.5. Test Deviation

There is no deviation with the original standard.

4.1.6. EUT Operation during Test

The EUT was programmed to be in continuously transmitting mode.

4.1.7. Test Result of 26dB Bandwidth and 99% Occupied Bandwidth

Temperature	24°C	Humidity	60%
Test Engineer	Clemens Fang		

Mode	Frequency	26dB Bandwidth (MHz)	99% Occupied Bandwidth (MHz)
802.11a	5180 MHz	21.22	17.02
	5200 MHz	21.39	16.93
	5240 MHz	21.48	17.02
	5745 MHz	21.57	17.11
	5785 MHz	21.39	17.11
	5825 MHz	21.57	17.02
802.11n MCS0 HT20	5180 MHz	21.39	18.06
	5200 MHz	21.65	17.97
	5240 MHz	21.57	18.15
	5745 MHz	21.57	17.97
	5785 MHz	21.48	17.71
	5825 MHz	21.48	17.97
802.11n MCS0 HT40	5190 MHz	40.58	37.05
	5230 MHz	40.58	37.05
	5755 MHz	40.29	36.90
	5795 MHz	40.58	36.90

26dB Bandwidth and 99% Occupied Bandwidth Plot on Configuration IEEE 802.11a / Chain 1 / 5180 MHz

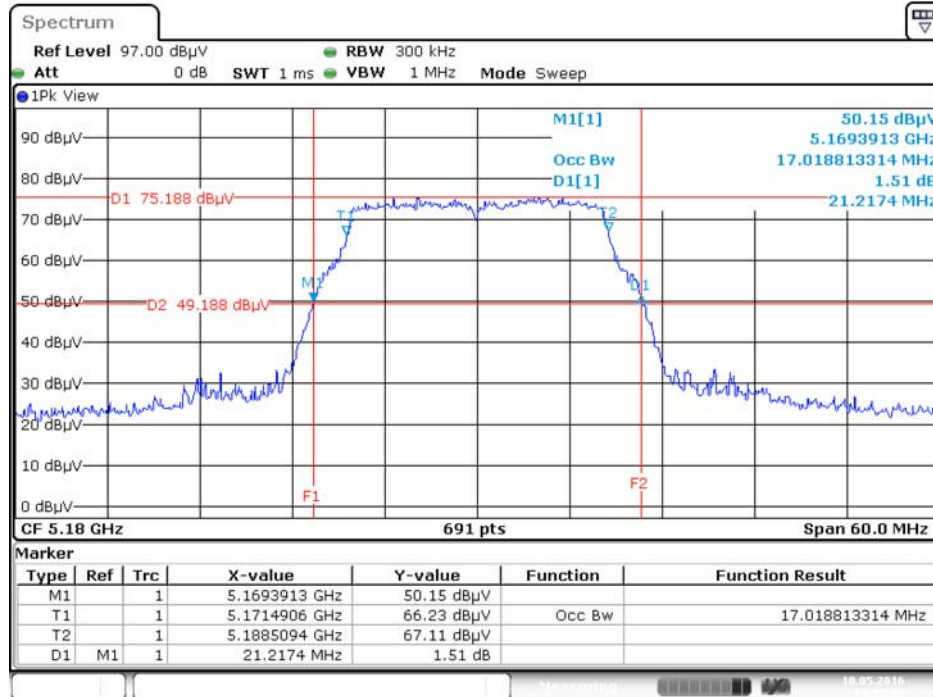

Date: 10.MAY.2016 14:33:04

26dB Bandwidth and 99% Occupied Bandwidth Plot on Configuration IEEE 802.11a / Chain 1 / 5200 MHz

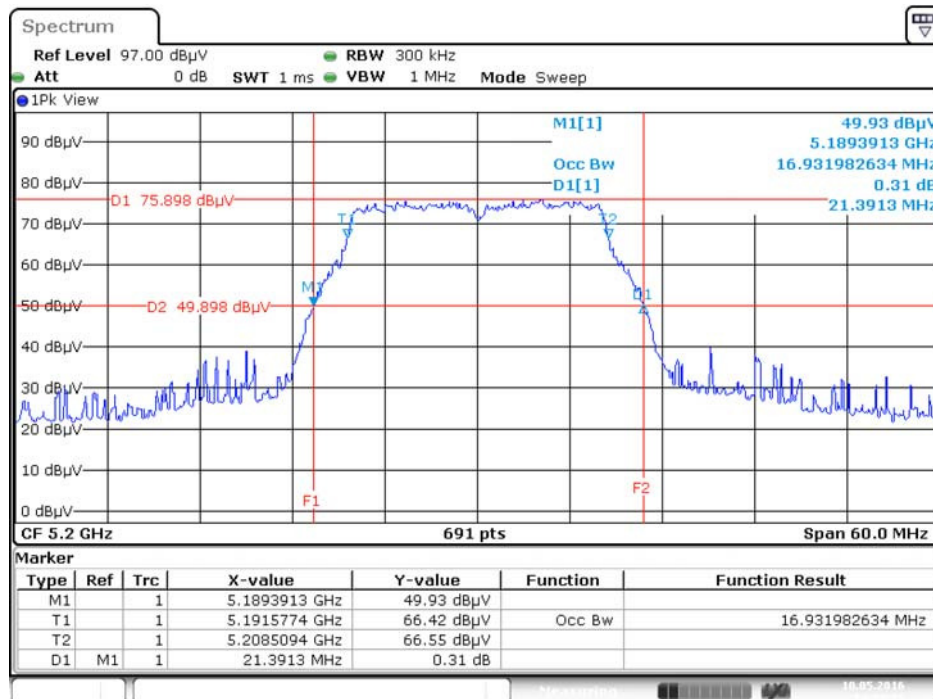

Date: 10.MAY.2016 14:33:52

26dB Bandwidth and 99% Occupied Bandwidth Plot on Configuration IEEE 802.11a / Chain 1 / 5240 MHz

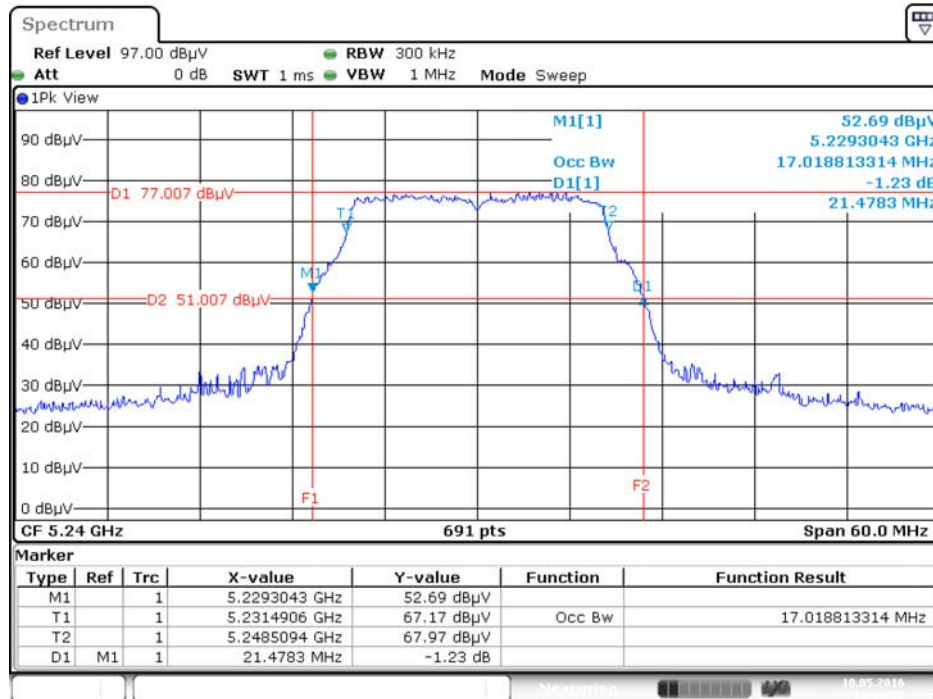

Date: 10.MAY.2016 14:34:32

26dB Bandwidth and 99% Occupied Bandwidth Plot on Configuration IEEE 802.11a / Chain 1 / 5745 MHz

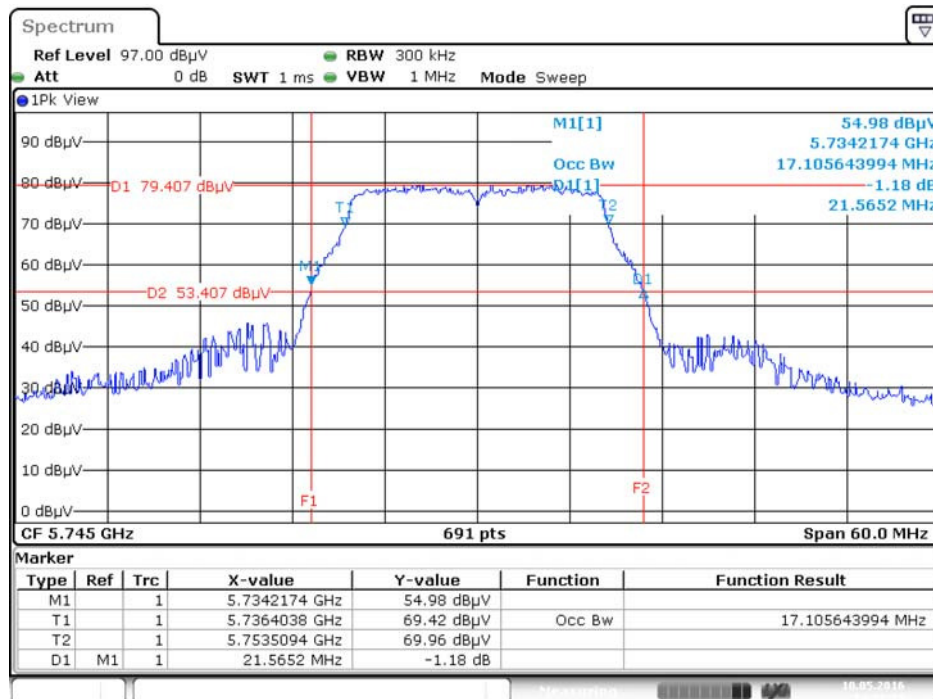

Date: 10.MAY.2016 14:32:34

26dB Bandwidth and 99% Occupied Bandwidth Plot on Configuration IEEE 802.11a / Chain 1 / 5785 MHz

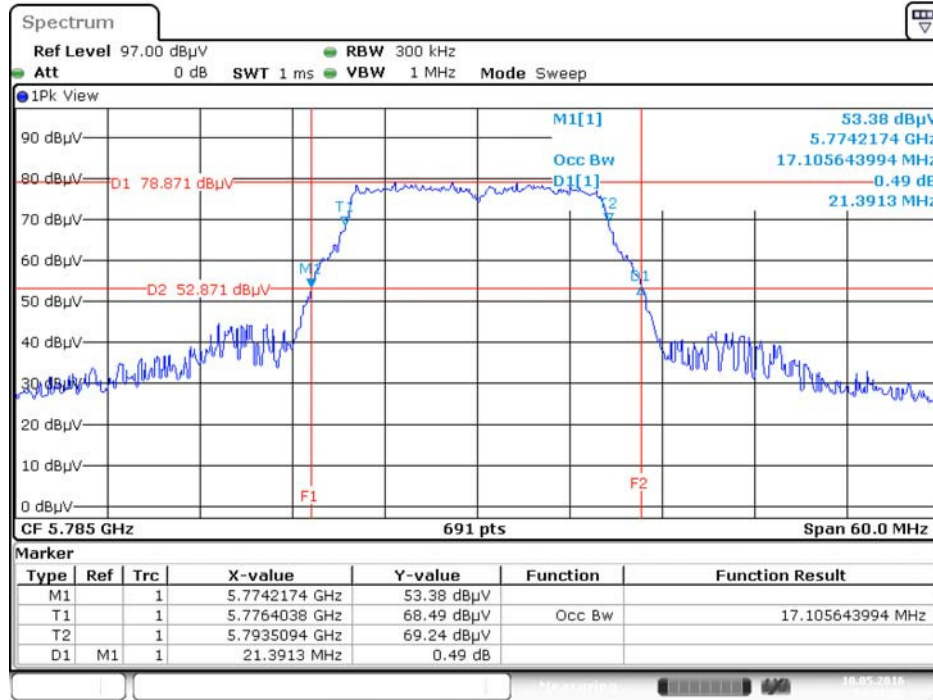

Date: 10.MAY.2016 14:32:07

26dB Bandwidth and 99% Occupied Bandwidth Plot on Configuration IEEE 802.11a / Chain 1 / 5825 MHz

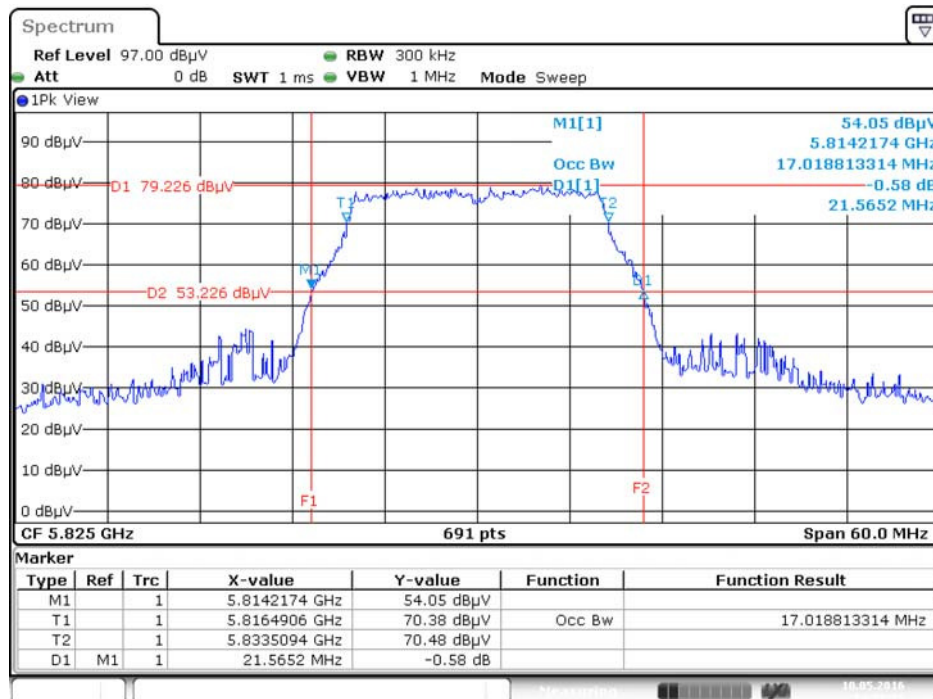

Date: 10.MAY.2016 14:31:32

26dB Bandwidth and 99% Occupied Bandwidth Plot on Configuration IEEE 802.11n MCS0 HT20 / Chain 1 + Chain 2 / 5180 MHz

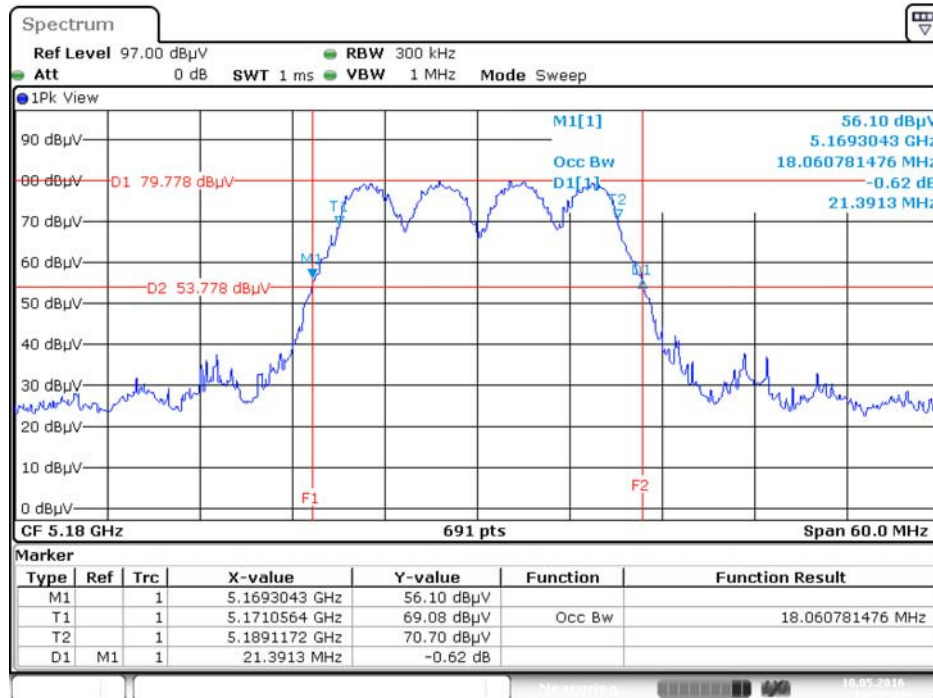

Date: 10.MAY.2016 14:27:44

26dB Bandwidth and 99% Occupied Bandwidth Plot on Configuration IEEE 802.11n MCS0 HT20 / Chain 1 + Chain 2 / 5200 MHz

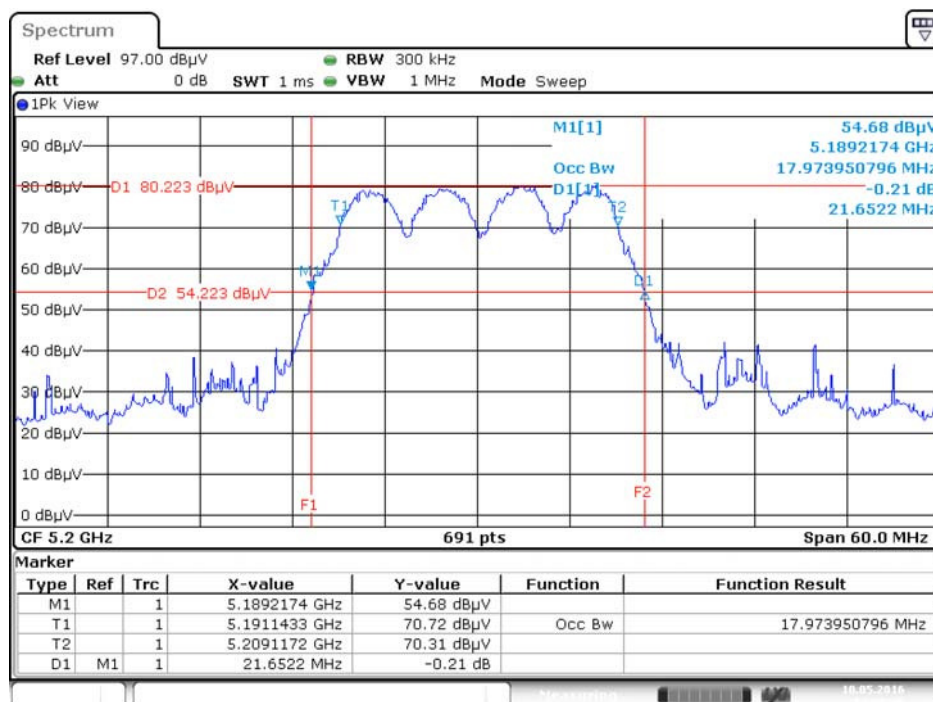

Date: 10.MAY.2016 14:28:47

26dB Bandwidth and 99% Occupied Bandwidth Plot on Configuration IEEE 802.11n MCS0 HT20 / Chain 1 + Chain 2 / 5240 MHz

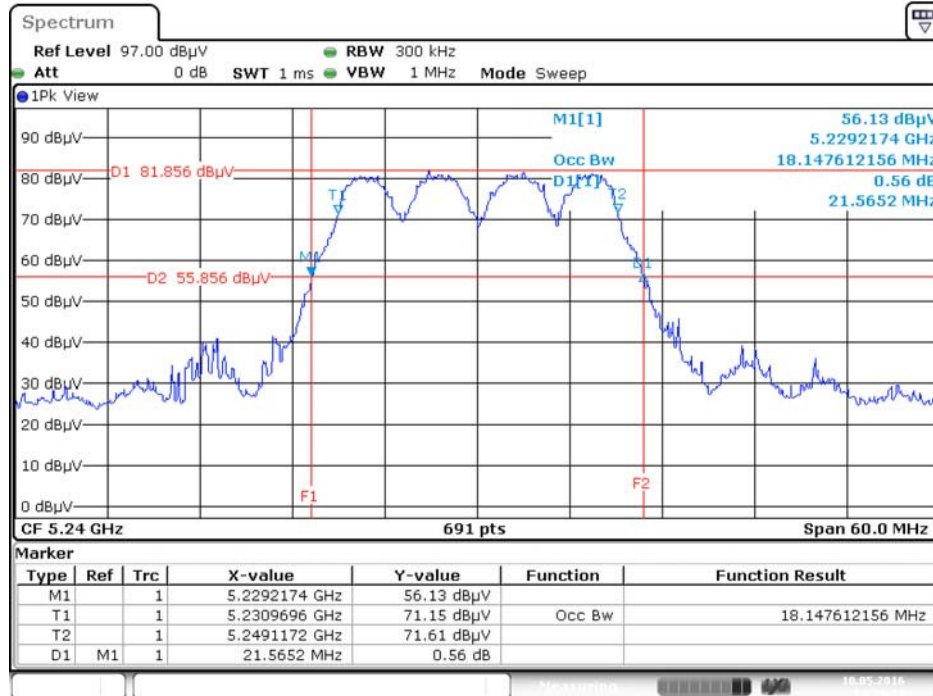

Date: 10.MAY.2016 14:29:11

26dB Bandwidth and 99% Occupied Bandwidth Plot on Configuration IEEE 802.11n MCS0 HT20 / Chain 1 + Chain 2 / 5745 MHz

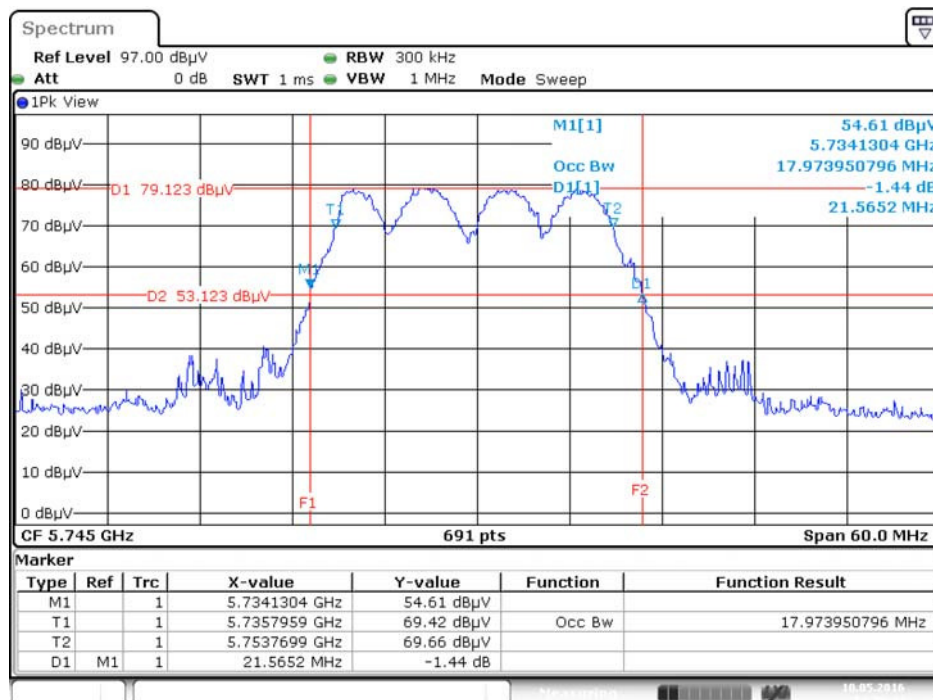

Date: 10.MAY.2016 14:29:43

26dB Bandwidth and 99% Occupied Bandwidth Plot on Configuration IEEE 802.11n MCS0 HT20 / Chain 1 + Chain 2 / 5785 MHz

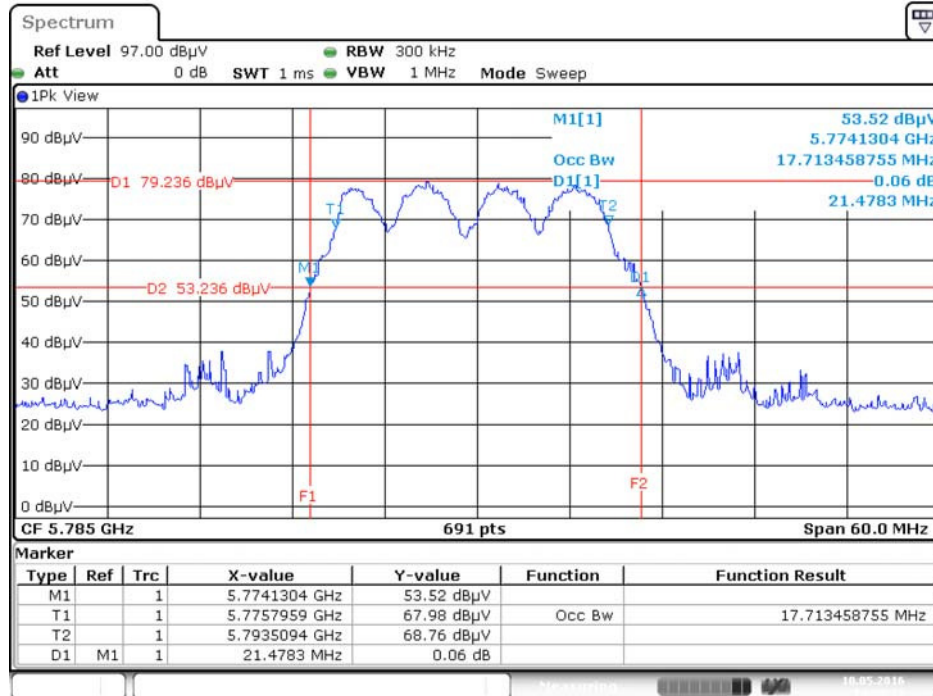

Date: 10.MAY.2016 14:30:17

26dB Bandwidth and 99% Occupied Bandwidth Plot on Configuration IEEE 802.11n MCS0 HT20 / Chain 1 + Chain 2 / 5825 MHz

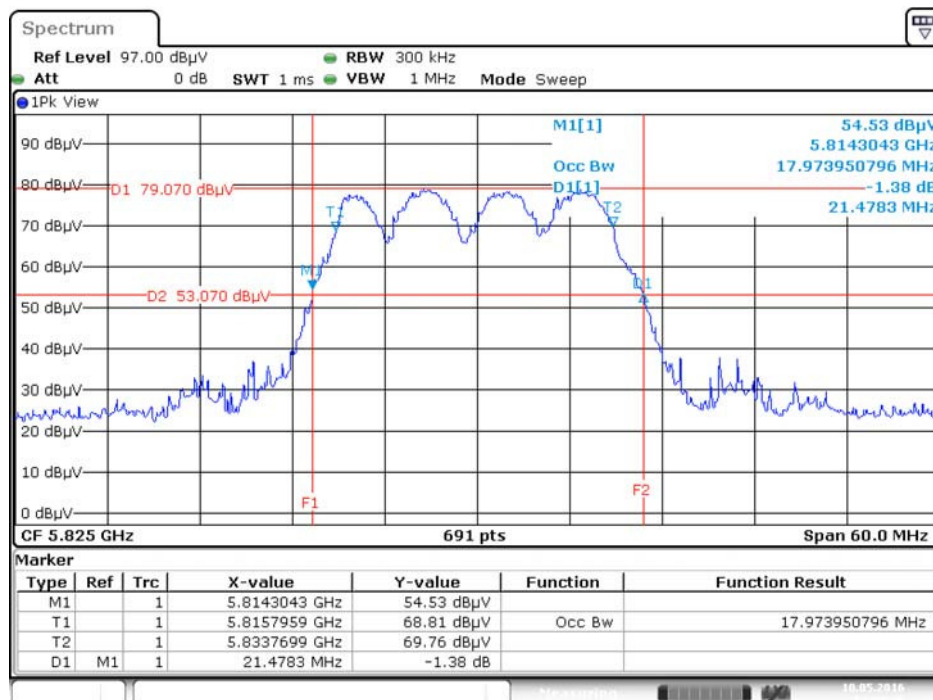

Date: 10.MAY.2016 14:30:46

26dB Bandwidth and 99% Occupied Bandwidth Plot on Configuration IEEE 802.11n MCS0 HT40 / Chain 1 + Chain 2 / 5190 MHz

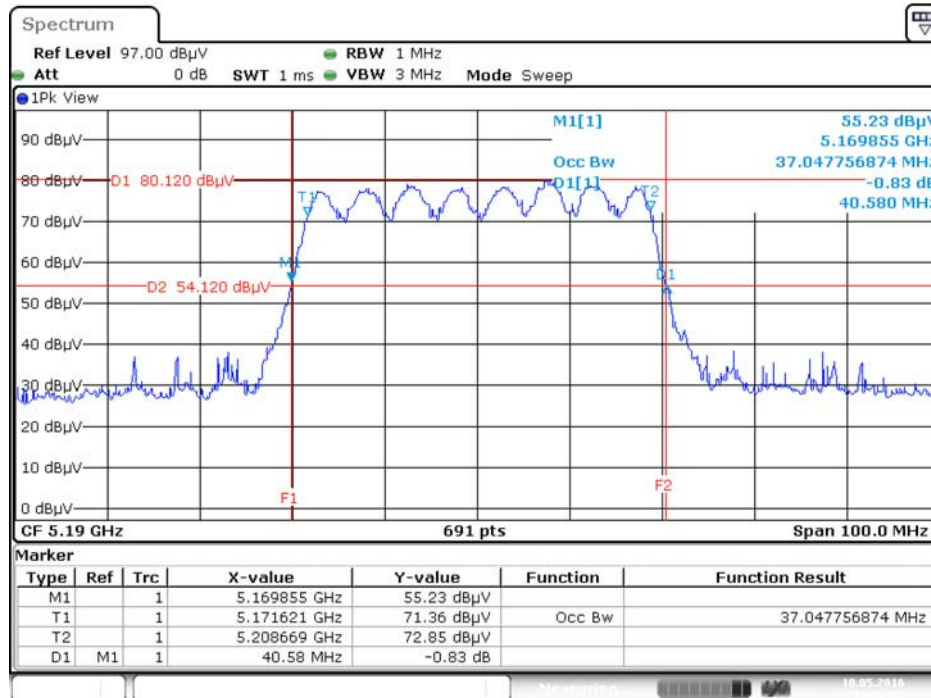

Date: 10.MAY.2016 14:26:55

26dB Bandwidth and 99% Occupied Bandwidth Plot on Configuration IEEE 802.11n MCS0 HT40 / Chain 1 + Chain 2 / 5230 MHz

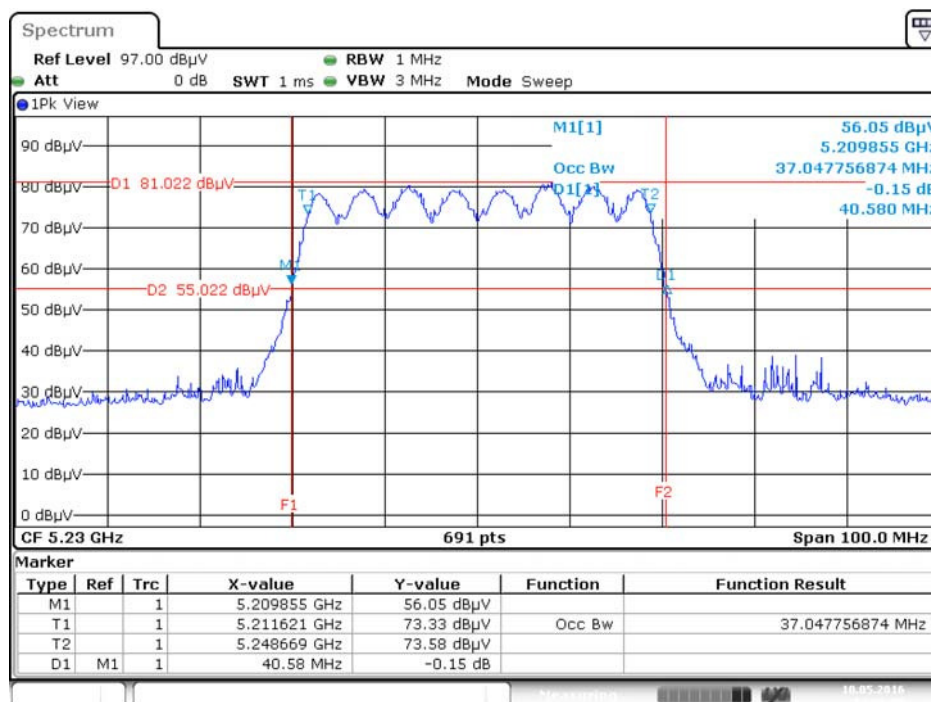

Date: 10.MAY.2016 14:26:28

26dB Bandwidth and 99% Occupied Bandwidth Plot on Configuration IEEE 802.11n MCS0 HT40 / Chain 1 + Chain 2 / 5755 MHz

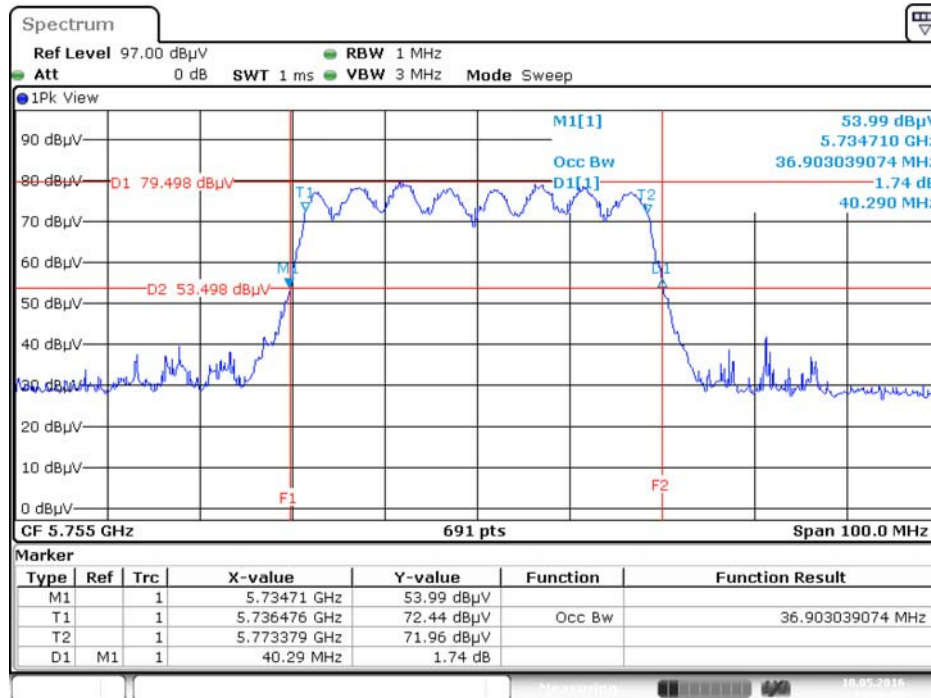

Date: 10.MAY.2016 14:26:00

26dB Bandwidth and 99% Occupied Bandwidth Plot on Configuration IEEE 802.11n MCS0 HT40 / Chain 1 + Chain 2 / 5795 MHz

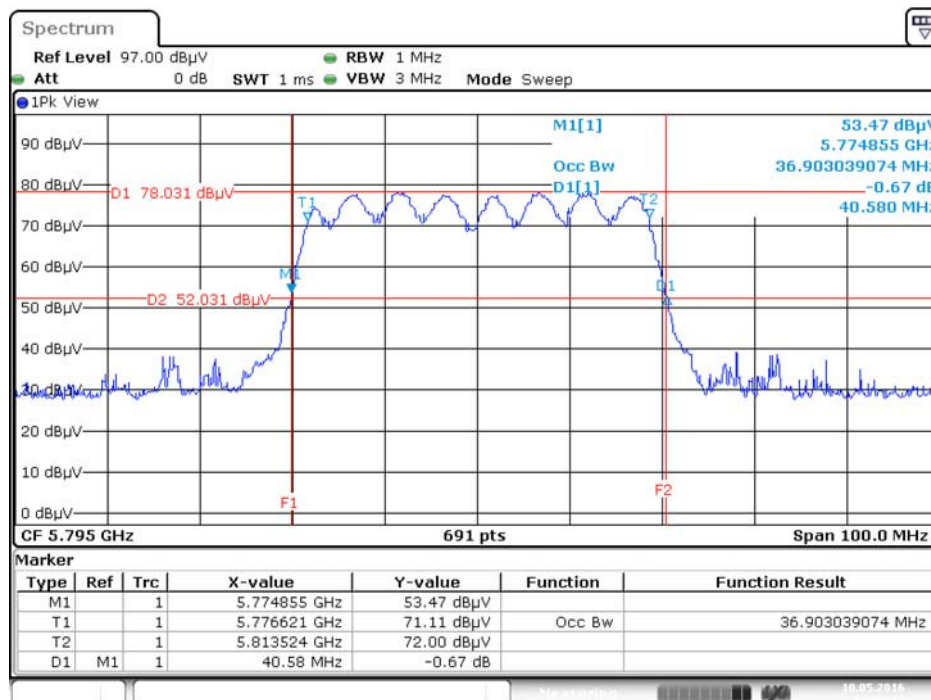

Date: 10.MAY.2016 14:25:22

4.2. 6dB Spectrum Bandwidth Measurement

4.2.1. Limit

For digital modulation systems, the minimum 6dB bandwidth shall be at least 500 kHz.

4.2.2. Measuring Instruments and Setting

Please refer to section 5 of equipments list in this report. The following table is the setting of spectrum analyzer.

6dB Spectrum Bandwidth	
Spectrum Parameters	Setting
Attenuation	Auto
Span Frequency	> 6dB Bandwidth
RBW	100kHz
VBW	$\geq 3 \times \text{RBW}$
Detector	Peak
Trace	Max Hold
Sweep Time	Auto

4.2.3. Test Procedures

For Radiated 6dB Bandwidth Measurement:

1. The transmitter was radiated to the spectrum analyzer in peak hold mode.
2. Test was performed in accordance with KDB789033 D02 v01r02 for Compliance Testing of Unlicensed National Information Infrastructure (U-NII) Devices - section (C) Emission Bandwidth.
3. Multiple antenna system was performed in accordance with KDB662911 D01 v02r01 Emissions Testing of Transmitters with Multiple Outputs in the Same Band.
4. Measured the spectrum width with power higher than 6dB below carrier.

4.2.4. Test Setup Layout

For Radiated 6dB Bandwidth Measurement:

This test setup layout is the same as that shown in section 4.5.4.

4.2.5. Test Deviation

There is no deviation with the original standard.

4.2.6. EUT Operation during Test

The EUT was programmed to be in continuously transmitting mode.

4.2.7. Test Result of 6dB Spectrum Bandwidth

Temperature	24°C	Humidity	60%
Test Engineer	Clemens Fang		

Mode	Frequency	6dB Bandwidth (MHz)	Min. Limit (kHz)	Test Result
802.11a	5745 MHz	16.29	500	Complies
	5785 MHz	16.41	500	Complies
	5825 MHz	16.35	500	Complies
802.11n MCS0 HT20	5745 MHz	16.81	500	Complies
	5785 MHz	17.04	500	Complies
	5825 MHz	16.70	500	Complies
802.11n MCS0 HT40	5755 MHz	36.17	500	Complies
	5795 MHz	36.17	500	Complies

Note: All the test values were listed in the report.

For plots, only the channel with worse result was shown.

6 dB Bandwidth Plot on Configuration IEEE 802.11a / Chain 1 / 5745 MHz

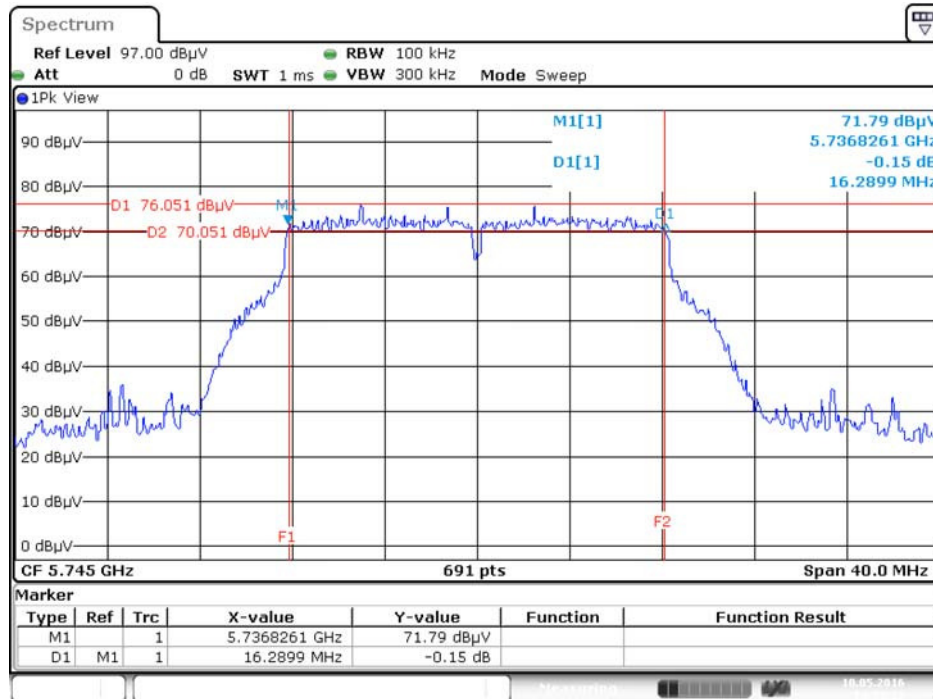

Date: 10.MAY.2016 14:35:32

6 dB Bandwidth Plot on Configuration IEEE 802.11n MCS0 HT20 / Chain 1 + Chain 2 / 5825 MHz

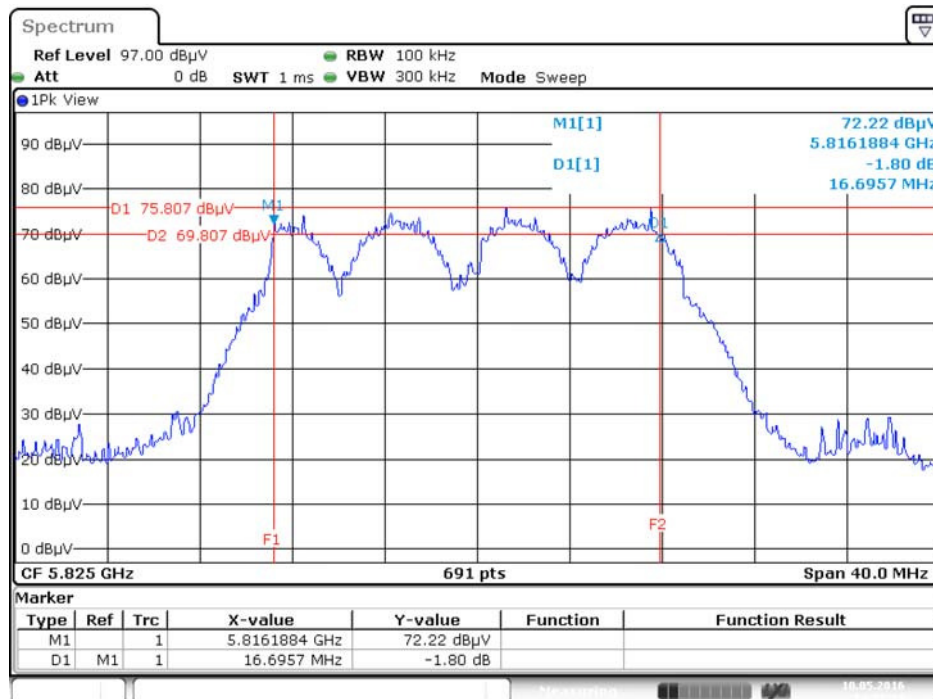

Date: 10.MAY.2016 14:37:10

6 dB Bandwidth Plot on Configuration IEEE 802.11n MCS0 HT40 / Chain 1 + Chain 2 / 5755 MHz

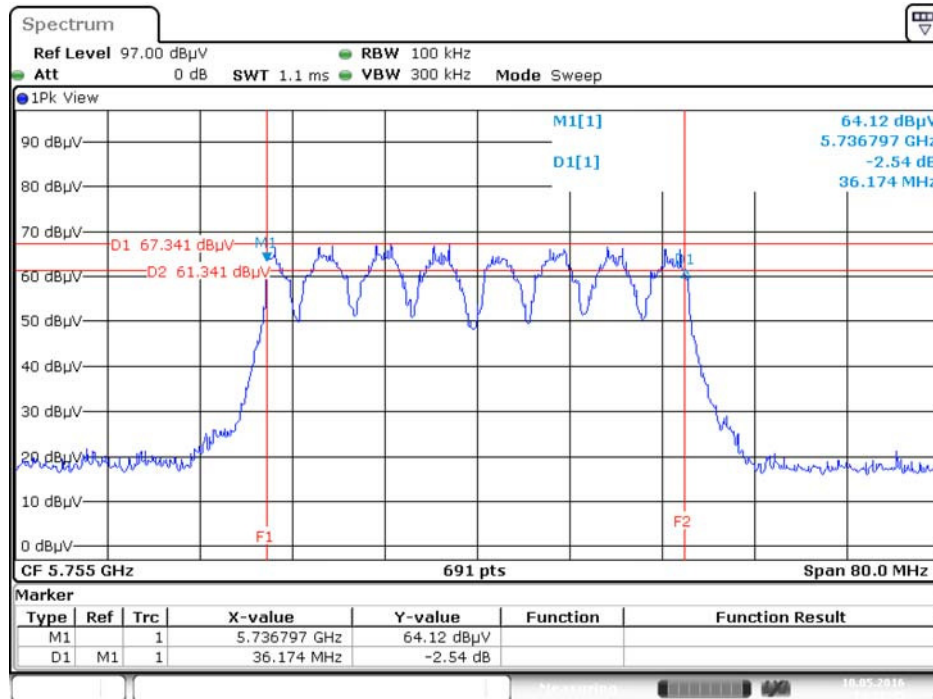

Date: 10.MAY.2016 14:38:46

4.3. Maximum Conducted Output Power Measurement

4.3.1. Limit

Frequency Band	Limit
<input checked="" type="checkbox"/> 5.15~5.25 GHz	
Operating Mode	
<input type="checkbox"/> Outdoor access point	<p>The maximum conducted output power over the frequency band of operation shall not exceed 1 W (30dBm) provided the maximum antenna gain does not exceed 6 dBi. If transmitting antennas of directional gain greater than 6 dBi are used, both the maximum conducted output power and the maximum power spectral density shall be reduced by the amount in dB that the directional gain of the antenna exceeds 6 dBi. The maximum e.i.r.p. at any elevation angle above 30 degrees as measured from the horizon must not exceed 125 mW (21 dBm).</p>
<input type="checkbox"/> Indoor access point	<p>The maximum conducted output power over the frequency band of operation shall not exceed 1 W (30dBm) provided the maximum antenna gain does not exceed 6 dBi. If transmitting antennas of directional gain greater than 6 dBi are used, both the maximum conducted output power and the maximum power spectral density shall be reduced by the amount in dB that the directional gain of the antenna exceeds 6 dBi.</p>
<input type="checkbox"/> Fixed point-to-point access points	<p>The maximum conducted output power over the frequency band of operation shall not exceed 1 W (30dBm). Fixed point-to-point U-NII devices may employ antennas with directional gain up to 23 dBi without any corresponding reduction in the maximum conducted output power or maximum power spectral density. For fixed point-to-point transmitters that employ a directional antenna gain greater than 23 dBi, a 1 dB reduction in maximum conducted output power and maximum power spectral density is required for each 1 dB of antenna gain in excess of 23 dBi.</p>
<input checked="" type="checkbox"/> Client devices	<p>The maximum conducted output power over the frequency band of operation shall not exceed 250 mW (24dBm) provided the maximum antenna gain does not exceed 6 dBi. If transmitting antennas of directional gain greater than 6 dBi are used, both the maximum conducted output power and the maximum power spectral density shall be reduced by the amount in dB that the directional gain of the antenna exceeds 6 dBi.</p>

<input checked="" type="checkbox"/>	5.725~5.85 GHz	The maximum conducted output power over the frequency band of operation shall not exceed 1 W (30dBm). If transmitting antennas of directional gain greater than 6 dBi are used, both the maximum conducted output power and the maximum power spectral density shall be reduced by the amount in dB that the directional gain of the antenna exceeds 6 dBi. However, fixed point-to-point U-NII devices operating in this band may employ transmitting antennas with directional gain greater than 6 dBi without any corresponding reduction in transmitter conducted power.
-------------------------------------	----------------	--

4.3.2. Measuring Instruments and Setting

Please refer to section 5 of equipments list in this report. The following table is the setting of the power meter.

Power Meter Parameter	Setting
Detector	AVERAGE

4.3.3. Test Procedures

1. The transmitter output (antenna port) was connected to the power meter.
2. Test was performed in accordance with KDB789033 D02 v01r02 for Compliance Testing of Unlicensed National Information Infrastructure (U-NII) Devices - section (E) Maximum conducted output power =>3. Measurement using a Power Meter (PM) =>b) Method PM-G (Measurement using a gated RF average power meter).
3. Multiple antenna systems was performed in accordance with KDB662911 D01 v02r01 Emissions Testing of Transmitters with Multiple Outputs in the Same Band.
4. When measuring maximum conducted output power with multiple antenna systems, add every result of the values by mathematic formula.

4.3.4. Test Setup Layout

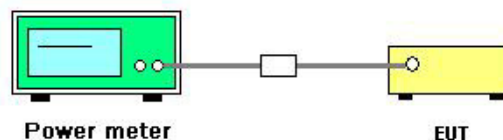

4.3.5. Test Deviation

There is no deviation with the original standard.

4.3.6. EUT Operation during Test

The EUT was programmed to be in continuously transmitting mode.

4.3.7. Test Result of Maximum Conducted Output Power

Temperature	24°C	Humidity	60%
Test Engineer	Clemens Fang	Test Date	May 10 2016

Mode	Frequency	Conducted Power (dBm)			Max. Limit (dBm)	Result
		Chain 1				
802.11a	5180 MHz	13.15			23.98	Complies
	5200 MHz	13.02			23.98	Complies
	5240 MHz	12.78			23.98	Complies
	5745 MHz	21.87			30.00	Complies
	5785 MHz	22.05			30.00	Complies
	5825 MHz	22.02			30.00	Complies

Mode	Frequency	Conducted Power (dBm)			Max. Limit (dBm)	Result
		Chain 1	Chain 2	Total		
802.11n MCS0 HT20	5180 MHz	13.46	12.61	16.07	23.98	Complies
	5200 MHz	13.95	12.12	16.14	23.98	Complies
	5240 MHz	13.59	12.56	16.12	23.98	Complies
	5745 MHz	18.68	19.02	21.86	30.00	Complies
	5785 MHz	18.31	19.04	21.70	30.00	Complies
	5825 MHz	18.54	19.13	21.86	30.00	Complies
802.11n MCS0 HT40	5190 MHz	7.77	6.61	10.24	23.98	Complies
	5230 MHz	7.64	6.57	10.15	23.98	Complies
	5755 MHz	14.05	15.35	17.76	30.00	Complies
	5795 MHz	14.06	15.04	17.59	30.00	Complies

4.4. Power Spectral Density Measurement

4.4.1. Limit

The following table is power spectral density limits and decrease power density limit rule refer to section 4.3.1.

Frequency Band		Limit
<input checked="" type="checkbox"/>	5.15~5.25 GHz	
	Operating Mode	
<input type="checkbox"/>	Outdoor access point	17 dBm/MHz
<input type="checkbox"/>	Indoor access point	17 dBm/MHz
<input type="checkbox"/>	Fixed point-to-point access points	17 dBm/MHz
<input checked="" type="checkbox"/>	Client devices	11 dBm/MHz
<input checked="" type="checkbox"/>	5.725~5.85 GHz	30 dBm/500kHz

4.4.2. Measuring Instruments and Setting

Please refer to section 5 of equipments list in this report. The following table is the setting of the spectrum analyzer.

Spectrum Parameter	Setting
Attenuation	Auto
Span Frequency	Encompass the entire emissions bandwidth (EBW) of the signal
RBW	1000 kHz
VBW	3000 kHz
Detector	RMS
Trace	AVERAGE
Sweep Time	Auto
Trace Average	100 times
Note: If measurement bandwidth of Maximum PSD is specified in 500 kHz, add $10\log(500\text{kHz}/\text{RBW})$ to the measured result, whereas RBW (< 500 kHz) is the reduced resolution bandwidth of the spectrum analyzer set during measurement.	

4.4.3. Test Procedures

1. The transmitter output (antenna port) was connected RF switch to the spectrum analyzer.
2. Test was performed in accordance with KDB789033 D02 v01r02 for Compliance Testing of Unlicensed National Information Infrastructure (U-NII) Devices - section (F) Maximum Power Spectral Density (PSD).
3. Multiple antenna systems was performed in accordance KDB662911 D01 v02r01 in-Band Power Spectral Density (PSD) Measurements and sum the spectra across the outputs.
4. For 5.725~5.85 GHz, the measured result of PSD level must add $10\log(500\text{kHz}/\text{RBW})$ and the final result should ≤ 30 dBm.

4.4.4. Test Setup Layout

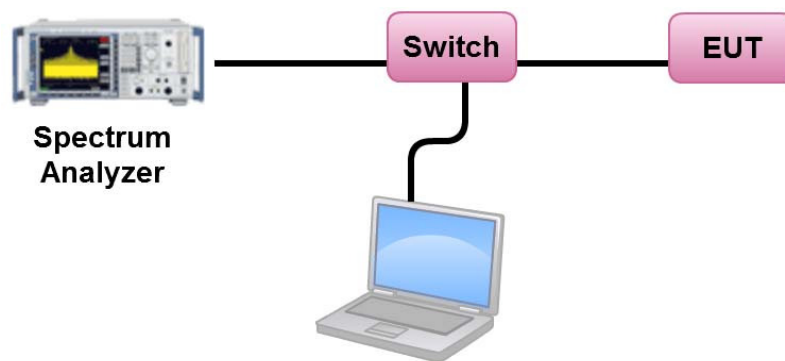

4.4.5. Test Deviation

There is no deviation with the original standard.

4.4.6. EUT Operation during Test

The EUT was programmed to be in continuously transmitting mode.

4.4.7. Test Result of Power Spectral Density

Temperature	24°C	Humidity	60%
Test Engineer	Clemens Fang		

Configuration IEEE 802.11a / Chain 1

Channel	Frequency	Power Density (dBm/MHz)	Max. Limit (dBm/MHz)	Result
36	5180 MHz	0.03	11.00	Complies
40	5200 MHz	-0.01	11.00	Complies
48	5240 MHz	-0.27	11.00	Complies

Channel	Frequency	Power Density (dBm/MHz)	10log(500kHz/RBW) Factor (dB)	Power Density (dBm/500kHz)	Power Density Limit (dBm/500kHz)	Result
149	5745 MHz	8.71	-3.01	5.70	30.00	Complies
157	5785 MHz	8.89	-3.01	5.88	30.00	Complies
165	5825 MHz	8.85	-3.01	5.84	30.00	Complies

Configuration IEEE 802.11n MCS0 HT20 / Chain 1 + Chain 2

Channel	Frequency	Power Density (dBm/MHz)	Max. Limit (dBm/MHz)	Result
36	5180 MHz	2.89	11.00	Complies
40	5200 MHz	3.12	11.00	Complies
48	5240 MHz	2.93	11.00	Complies

Note: $DirectionalGain = 10 \cdot \log \left[\frac{\sum_{j=1}^{N_{SS}} \left\{ \sum_{k=1}^{N_{ANT}} g_{j,k} \right\}^2}{N_{ANT}} \right] = 5.01 \text{ dBi} < 6 \text{ dBi}$, so the limit doesn't reduce.

Channel	Frequency	Power Density (dBm/MHz)	10log(500kHz/RBW) Factor (dB)	Power Density (dBm/500kHz)	Power Density Limit (dBm/500kHz)	Result
149	5745 MHz	8.81	-3.01	5.80	30.00	Complies
157	5785 MHz	8.60	-3.01	5.59	30.00	Complies
165	5825 MHz	8.71	-3.01	5.70	30.00	Complies

Note: $DirectionalGain = 10 \cdot \log \left[\frac{\sum_{j=1}^{N_{SS}} \left\{ \sum_{k=1}^{N_{ANT}} g_{j,k} \right\}^2}{N_{ANT}} \right] = 5.01 \text{ dBi} < 6 \text{ dBi}$, so the limit doesn't reduce.

Configuration IEEE 802.11n MCS0 HT40 / Chain 1 + Chain 2

Channel	Frequency	Power Density (dBm/MHz)	Max. Limit (dBm/MHz)	Result
38	5190 MHz	-5.86	11.00	Complies
46	5230 MHz	-5.91	11.00	Complies

Note: $DirectionalGain = 10 \cdot \log \left[\frac{\sum_{j=1}^{N_{SS}} \left\{ \sum_{k=1}^{N_{ANT}} g_{j,k} \right\}^2}{N_{ANT}} \right] = 5.01 \text{ dBi} < 6 \text{ dBi}$, so the limit doesn't reduce.

Channel	Frequency	Power Density (dBm/MHz)	10log(500kHz/RBW) Factor (dB)	Power Density (dBm/500kHz)	Power Density Limit (dBm/500kHz)	Result
151	5755 MHz	1.74	-3.01	-1.27	30.00	Complies
159	5795 MHz	1.47	-3.01	-1.54	30.00	Complies

Note: $DirectionalGain = 10 \cdot \log \left[\frac{\sum_{j=1}^{N_{SS}} \left\{ \sum_{k=1}^{N_{ANT}} g_{j,k} \right\}^2}{N_{ANT}} \right] = 5.01 \text{ dBi} < 6 \text{ dBi}$, so the limit doesn't reduce.

Note: All the test values were listed in the report.

For plots, only the channel with worse result was shown.

Power Density Plot on Configuration IEEE 802.11a / Chain 1 / 5180 MHz

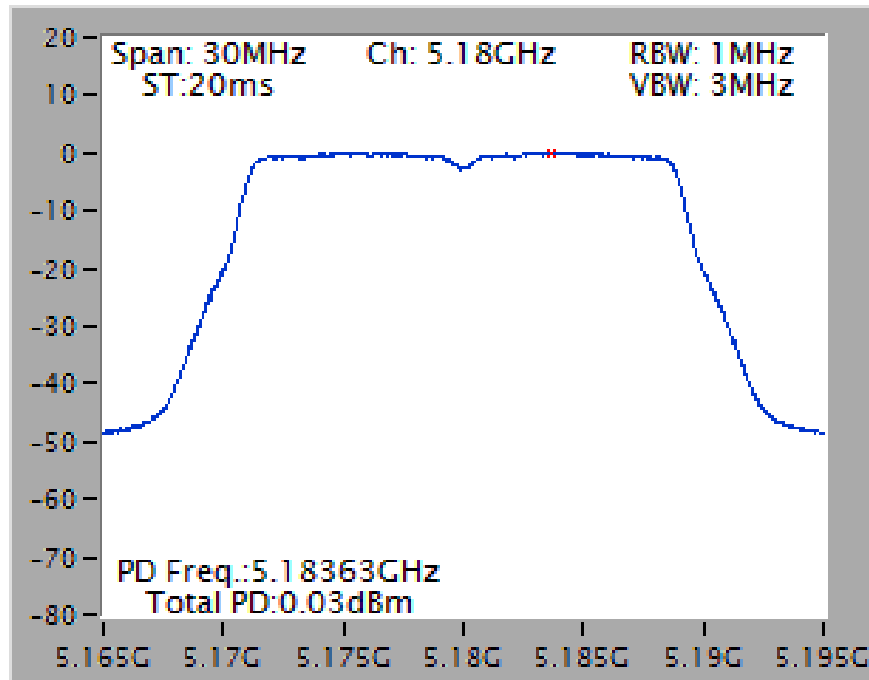

Power Density Plot on Configuration IEEE 802.11a / Chain 1 / 5785 MHz

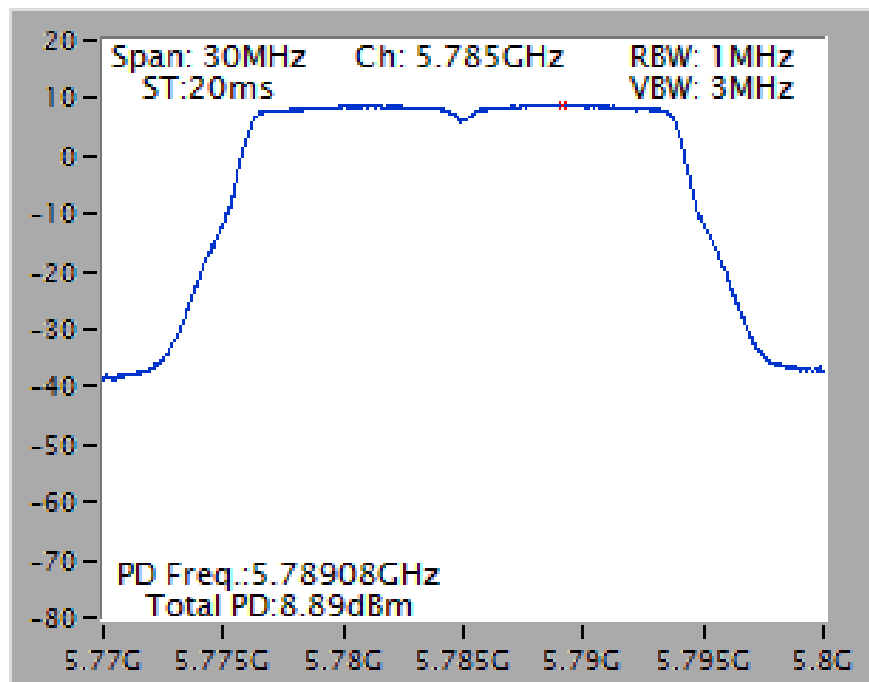

Power Density Plot on Configuration IEEE 802.11n MCS0 HT20 / Chain 1 + Chain 2 / 5200 MHz

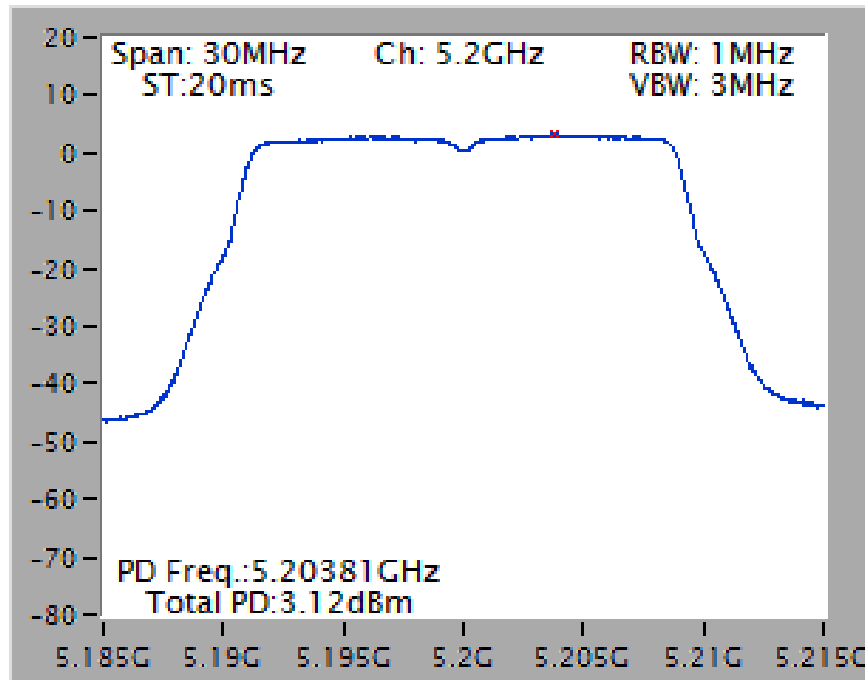

Power Density Plot on Configuration IEEE 802.11n MCS0 HT20 / Chain 1 + Chain 2 / 5745 MHz

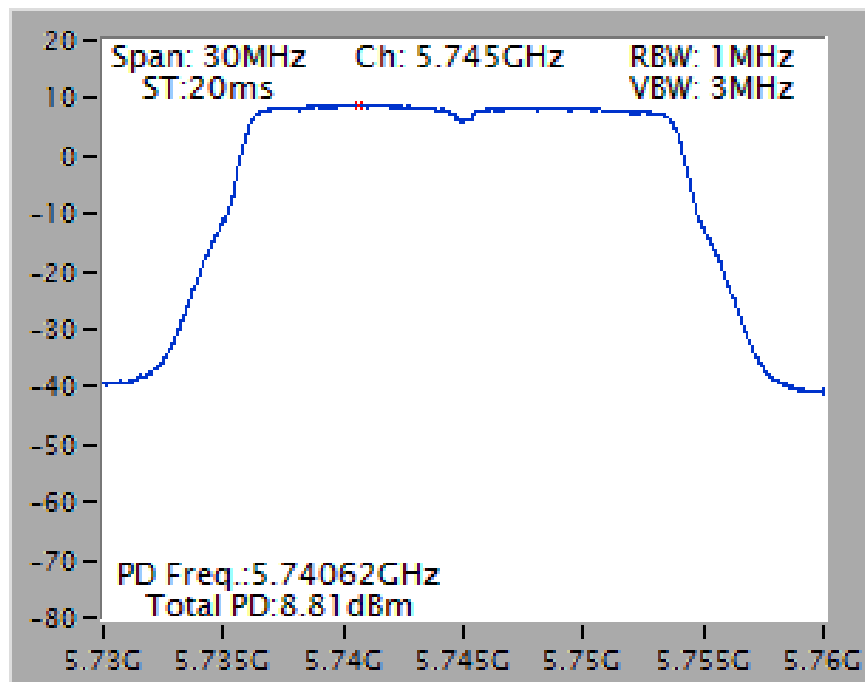

Power Density Plot on Configuration IEEE 802.11n MCS0 HT40 / Chain 1 + Chain 2 / 5190 MHz

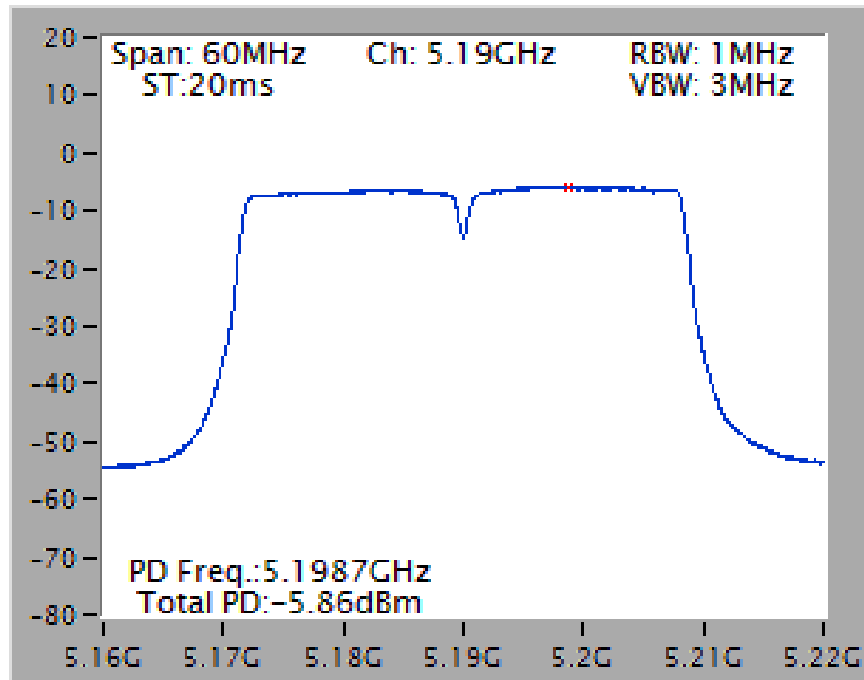

Power Density Plot on Configuration IEEE 802.11n MCS0 HT40 / Chain 1 + Chain 2 / 5755 MHz

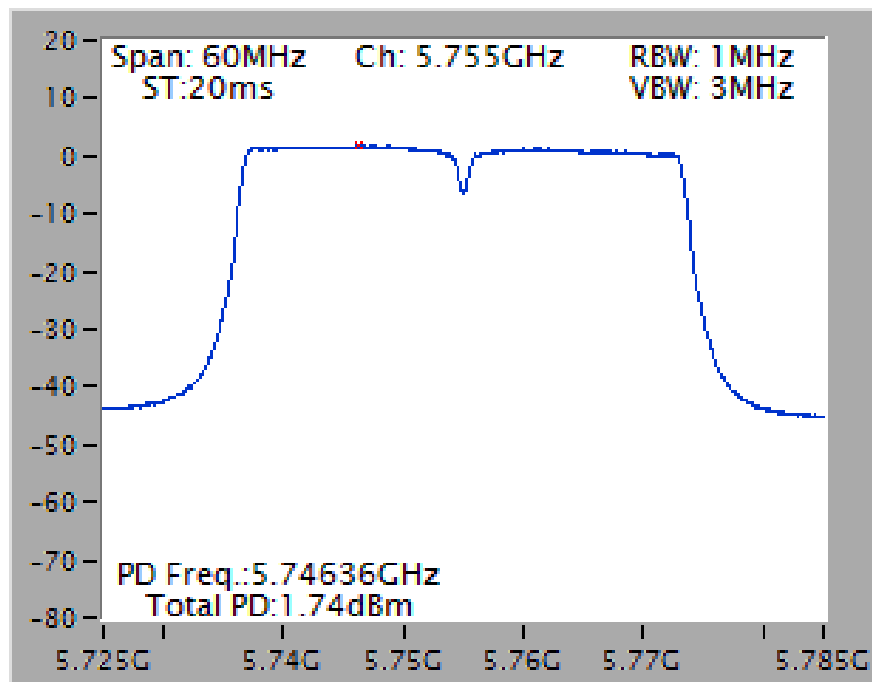

4.5. Radiated Emissions Measurement

4.5.1. Limit

For transmitters operating in the 5.15-5.25 GHz band: all emissions outside of the 5.15-5.35 GHz band shall not exceed an e.i.r.p. of -27 dBm/MHz.

For transmitters operating in the 5.725-5.85 GHz band: all emissions shall be limited to a level of -27 dBm/MHz at 75 MHz or more above or below the band edge increasing linearly to 10 dBm/MHz at 25 MHz above or below the band edge, and from 25 MHz above or below the band edge increasing linearly to a level of 15.6 dBm/MHz at 5 MHz above or below the band edge, and from 5 MHz above or below the band edge increasing linearly to a level of 27 dBm/MHz at the band edge.

In addition, In case the emission fall within the restricted band specified on 15.205(a), then the 15.209(a) limit in the table below has to be followed.

Frequencies (MHz)	Field Strength (micovolts/meter)	Measurement Distance (meters)
0.009~0.490	2400/F(kHz)	300
0.490~1.705	24000/F(kHz)	30
1.705~30.0	30	30
30~88	100	3
88~216	150	3
216~960	200	3
Above 960	500	3

4.5.2. Measuring Instruments and Setting

Please refer to section 5 of equipments list in this report. The following table is the setting of spectrum analyzer and receiver.

Spectrum Parameter	Setting
Attenuation	Auto
Start Frequency	1000 MHz
Stop Frequency	40 GHz
RBW / VBW (Emission in restricted band)	1 MHz / 3MHz for Peak, 1 MHz / 1/T for Average
RBW / VBW (Emission in non-restricted band)	1 MHz / 3MHz for peak

Receiver Parameter	Setting
Attenuation	Auto
Start ~ Stop Frequency	9kHz~150kHz / RBW 200Hz for QP
Start ~ Stop Frequency	150kHz~30MHz / RBW 9kHz for QP
Start ~ Stop Frequency	30MHz~1000MHz / RBW 120kHz for QP

4.5.3. Test Procedures

1. Configure the EUT according to ANSI C63.10. The EUT was placed on the top of the turntable 1.5 meter above ground. The phase center of the receiving antenna mounted on the top of a height-variable antenna tower was placed 1m & 3m far away from the turntable.
2. Power on the EUT and all the supporting units. The turntable was rotated by 360 degrees to determine the position of the highest radiation.
3. The height of the broadband receiving antenna was varied between one meter and four meters above ground to find the maximum emissions field strength of both horizontal and vertical polarization.
4. For each suspected emissions, the antenna tower was scan (from 1 M to 4 M) and then the turntable was rotated (from 0 degree to 360 degrees) to find the maximum reading.
5. Set the test-receiver system to Peak or CISPR quasi-peak Detect Function with specified bandwidth under Maximum Hold Mode.
6. For emissions above 1GHz, use 1MHz VBW and 3MHz RBW for peak reading. Then 1MHz RBW and 1/T VBW for average reading in spectrum analyzer.
7. If the emissions level of the EUT in peak mode was 3 dB lower than the average limit specified, then testing will be stopped and peak values of EUT will be reported, otherwise, the emissions which do not have 3 dB margin will be repeated one by one using the quasi-peak method for below 1GHz.
8. For testing above 1GHz, the emissions level of the EUT in peak mode was lower than average limit (that means the emissions level in peak mode also complies with the limit in average mode), then testing will be stopped and peak values of EUT will be reported, otherwise, the emissions will be measured in average mode again and reported.
9. In case the emission is lower than 30MHz, loop antenna has to be used for measurement and the recorded data should be QP measured by receiver. High – Low scan is not required in this case.

4.5.4. Test Setup Layout

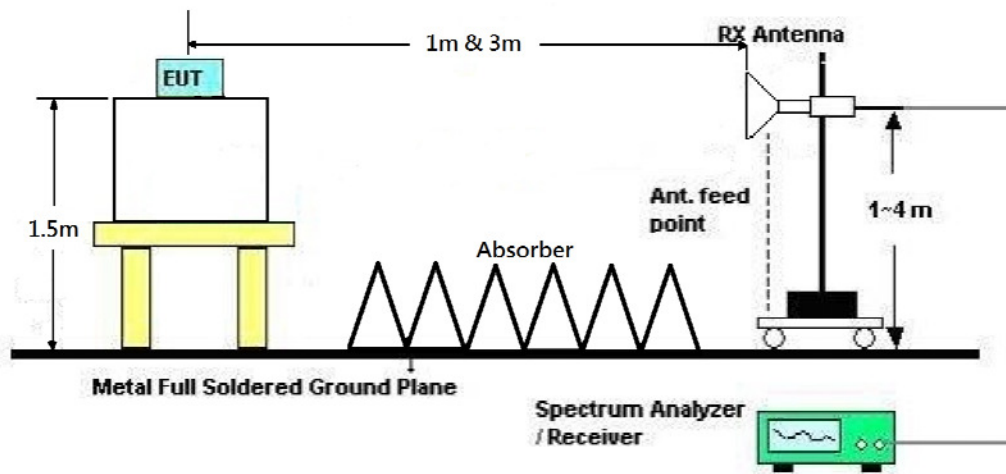

4.5.5. Test Deviation

There is no deviation with the original standard.

4.5.6. EUT Operation during Test

The EUT was programmed to be in continuously transmitting mode.

4.5.7. Results for Radiated Emissions (1GHz~40GHz)

Temperature	24°C	Humidity	54%
Test Engineer	John Tong	Configurations	IEEE 802.11a CH 36 / Chain 1
Test Date	May 07, 2016		

Horizontal

	Freq	Level	Limit Line	Over Limit	Read Level	CableAntenna Loss	Antenna Factor	Preamp Factor	A/Pos	T/Pos	Remark	Pol/Phase
	MHz	dBuV/m	dBuV/m	dB	dBuV	dB	dB/m	dB	cm	deg		
1	15535.08	55.43	74.00	-18.57	41.89	11.01	38.39	35.86	125	269	Peak	HORIZONTAL
2	15536.68	42.06	54.00	-11.94	28.52	11.01	38.39	35.86	125	269	Average	HORIZONTAL

Vertical

	Freq	Level	Limit Line	Over Limit	Read Level	CableAntenna Loss	Antenna Factor	Preamp Factor	A/Pos	T/Pos	Remark	Pol/Phase
	MHz	dBuV/m	dBuV/m	dB	dBuV	dB	dB/m	dB	cm	deg		
1	15536.20	42.07	54.00	-11.93	28.53	11.01	38.39	35.86	142	214	Average	VERTICAL
2	15537.44	55.72	74.00	-18.28	42.18	11.01	38.39	35.86	142	214	Peak	VERTICAL



Temperature	24°C	Humidity	54%
Test Engineer	John Tong	Configurations	IEEE 802.11a CH 40 / Chain 1
Test Date	May 07, 2016		

Horizontal

	Freq	Level	Limit	Over	Read	CableAntenna	Preamp	A/Pos	T/Pos	Remark	Pol/Phase	
	MHz	dBuV/m	dBuV/m	dB	dBuV	dB	dB/m	dB	cm	deg		
1	15601.59	41.70	54.00	-12.30	28.18	11.01	38.37	35.86	126	196	Average	HORIZONTAL
2	15601.63	55.54	74.00	-18.46	42.02	11.01	38.37	35.86	126	196	Peak	HORIZONTAL

Vertical

	Freq	Level	Limit	Over	Read	CableAntenna	Preamp	A/Pos	T/Pos	Remark	Pol/Phase	
	MHz	dBuV/m	dBuV/m	dB	dBuV	dB	dB/m	dB	cm	deg		
1	15600.59	42.94	54.00	-11.06	29.42	11.01	38.37	35.86	147	80	Average	VERTICAL
2	15604.23	55.34	74.00	-18.66	41.82	11.01	38.37	35.86	147	80	Peak	VERTICAL



Temperature	24°C	Humidity	54%
Test Engineer	John Tong	Configurations	IEEE 802.11a CH 48 / Chain 1
Test Date	May 07, 2016		

Horizontal

	Freq	Level	Limit Line	Over Limit	Read Level	CableAntenna Loss	Antenna Factor	Preamp Factor	A/Pos	T/Pos	Remark	Pol/Phase
	MHz	dBuV/m	dBuV/m	dB	dBuV	dB	dB/m	dB	cm	deg		
1	15699.25	55.71	74.00	-18.29	42.21	11.01	38.35	35.86	117	207	Peak	HORIZONTAL
2	15709.18	42.67	54.00	-11.33	29.17	11.01	38.35	35.86	117	207	Average	HORIZONTAL

Vertical

	Freq	Level	Limit Line	Over Limit	Read Level	CableAntenna Loss	Antenna Factor	Preamp Factor	A/Pos	T/Pos	Remark	Pol/Phase
	MHz	dBuV/m	dBuV/m	dB	dBuV	dB	dB/m	dB	cm	deg		
1	15711.59	42.84	54.00	-11.16	29.34	11.01	38.35	35.86	125	193	Average	VERTICAL
2	15717.12	56.46	74.00	-17.54	42.96	11.01	38.35	35.86	125	193	Peak	VERTICAL



Temperature	24°C	Humidity	54%
Test Engineer	John Tong	Configurations	IEEE 802.11a CH 149 / Chain 1
Test Date	May 07, 2016		

Horizontal

	Freq	Level	Limit Line	Over Limit	Read Level	CableAntenna Loss	Antenna Factor	Preamp Factor	A/Pos	T/Pos	Remark	Pol/Phase
	MHz	dBuV/m	dBuV/m	dB	dBuV	dB	dB/m	dB	cm	deg		
1	11489.52	50.53	54.00	-3.47	36.75	10.51	39.20	35.93	100	166	Average	HORIZONTAL
2	11489.60	64.94	74.00	-9.06	51.16	10.51	39.20	35.93	100	166	Peak	HORIZONTAL

Vertical

	Freq	Level	Limit Line	Over Limit	Read Level	CableAntenna Loss	Antenna Factor	Preamp Factor	A/Pos	T/Pos	Remark	Pol/Phase
	MHz	dBuV/m	dBuV/m	dB	dBuV	dB	dB/m	dB	cm	deg		
1	11482.47	68.81	74.00	-5.19	55.02	10.51	39.21	35.93	100	181	Peak	VERTICAL
2	11487.84	53.37	54.00	-0.63	39.59	10.51	39.20	35.93	100	181	Average	VERTICAL



Temperature	24°C	Humidity	54%
Test Engineer	John Tong	Configurations	IEEE 802.11a CH 157 / Chain 1
Test Date	May 07, 2016		

Horizontal

	Freq	Level	Limit Line	Over Limit	Read Level	CableAntenna Loss	Antenna Factor	Preamp Factor	A/Pos	T/Pos	Remark	Pol/Phase
	MHz	dBuV/m	dBuV/m	dB	dBuV	dB	dB/m	dB	cm	deg		
1	11568.72	53.71	54.00	-0.29	39.97	10.51	39.15	35.92	216	323	Average	HORIZONTAL
2	11569.84	68.55	74.00	-5.45	54.81	10.51	39.15	35.92	216	323	Peak	HORIZONTAL

Vertical

	Freq	Level	Limit Line	Over Limit	Read Level	CableAntenna Loss	Antenna Factor	Preamp Factor	A/Pos	T/Pos	Remark	Pol/Phase
	MHz	dBuV/m	dBuV/m	dB	dBuV	dB	dB/m	dB	cm	deg		
1	11566.96	67.07	74.00	-6.93	53.33	10.51	39.15	35.92	221	280	Peak	VERTICAL
2	11568.88	52.20	54.00	-1.80	38.46	10.51	39.15	35.92	221	280	Average	VERTICAL



Temperature	24°C	Humidity	54%
Test Engineer	John Tong	Configurations	IEEE 802.11a CH 165 / Chain 1
Test Date	May 07, 2016		

Horizontal

	Freq	Level	Limit	Over	Read	CableAntenna	Preamp	A/Pos	T/Pos	Remark	Pol/Phase	
	MHz	dBuV/m	dBuV/m	dB	dBuV	dB	dB/m	dB	cm	deg		
1	11649.60	53.73	54.00	-0.27	40.04	10.51	39.09	35.91	216	333	Average	HORIZONTAL
2	11651.92	68.46	74.00	-5.54	54.79	10.51	39.07	35.91	216	333	Peak	HORIZONTAL

Vertical

	Freq	Level	Limit	Over	Read	CableAntenna	Preamp	A/Pos	T/Pos	Remark	Pol/Phase	
	MHz	dBuV/m	dBuV/m	dB	dBuV	dB	dB/m	dB	cm	deg		
1	11648.64	69.25	74.00	-4.75	55.56	10.51	39.09	35.91	104	181	Peak	VERTICAL
2	11649.60	53.27	54.00	-0.73	39.58	10.51	39.09	35.91	104	181	Average	VERTICAL



Temperature	24°C	Humidity	54%
Test Engineer	John Tong	Configurations	IEEE 802.11n MCS0 HT20 CH 36 / Chain 1 + Chain 2
Test Date	May 07, 2016		

Horizontal

	Freq	Level	Limit	Over	Read	CableAntenna	Preamp	A/Pos	T/Pos	Remark	Pol/Phase	
	MHz	dBuV/m	dBuV/m	dB	dBuV	dB	dB/m	dB	cm	deg		
1	15539.13	42.04	54.00	-11.96	28.50	11.01	38.39	35.86	155	131	Average	HORIZONTAL
2	15541.39	55.32	74.00	-18.68	41.78	11.01	38.39	35.86	155	131	Peak	HORIZONTAL

Vertical

	Freq	Level	Limit	Over	Read	CableAntenna	Preamp	A/Pos	T/Pos	Remark	Pol/Phase	
	MHz	dBuV/m	dBuV/m	dB	dBuV	dB	dB/m	dB	cm	deg		
1	15535.90	55.55	74.00	-18.45	42.01	11.01	38.39	35.86	160	212	Peak	VERTICAL
2	15540.61	42.34	54.00	-11.66	28.80	11.01	38.39	35.86	160	212	Average	VERTICAL



Temperature	24°C	Humidity	54%
Test Engineer	John Tong	Configurations	IEEE 802.11n MCS0 HT20 CH 40 / Chain 1 + Chain 2
Test Date	May 07, 2016		

Horizontal

	Freq	Level	Limit	Over	Read	CableAntenna	Preamp	A/Pos	T/Pos	Remark	Pol/Phase
	MHz	dBuV/m	dBuV/m	dB	dBuV	dB	dB/m	dB	cm	deg	
1	15598.56	42.18	54.00	-11.82	28.65	11.01	38.38	35.86	148	124 Average	HORIZONTAL
2	15601.54	55.72	74.00	-18.28	42.20	11.01	38.37	35.86	148	124 Peak	HORIZONTAL

Vertical

	Freq	Level	Limit	Over	Read	CableAntenna	Preamp	A/Pos	T/Pos	Remark	Pol/Phase
	MHz	dBuV/m	dBuV/m	dB	dBuV	dB	dB/m	dB	cm	deg	
1	15600.88	55.67	74.00	-18.33	42.15	11.01	38.37	35.86	154	83 Peak	VERTICAL
2	15603.48	41.87	54.00	-12.13	28.35	11.01	38.37	35.86	154	83 Average	VERTICAL



Temperature	24°C	Humidity	54%
Test Engineer	John Tong	Configurations	IEEE 802.11n MCS0 HT20 CH 48 / Chain 1 + Chain 2
Test Date	May 07, 2016		

Horizontal

	Freq	Level	Limit	Over	Read	CableAntenna	Preamp	A/Pos	T/Pos	Remark	Pol/Phase
	MHz	dBuV/m	dBuV/m	dB	dBuV	dB	dB/m	dB	cm	deg	
1	15715.61	42.39	54.00	-11.61	28.89	11.01	38.35	35.86	194	111 Average	HORIZONTAL
2	15718.94	55.97	74.00	-18.03	42.47	11.01	38.35	35.86	194	111 Peak	HORIZONTAL

Vertical

	Freq	Level	Limit	Over	Read	CableAntenna	Preamp	A/Pos	T/Pos	Remark	Pol/Phase
	MHz	dBuV/m	dBuV/m	dB	dBuV	dB	dB/m	dB	cm	deg	
1	15715.05	42.38	54.00	-11.62	28.88	11.01	38.35	35.86	300	79 Average	VERTICAL
2	15717.63	55.86	74.00	-18.14	42.36	11.01	38.35	35.86	300	79 Peak	VERTICAL



Temperature	24°C	Humidity	54%
Test Engineer	John Tong	Configurations	IEEE 802.11n MCS0 HT20 CH 149 / Chain 1 + Chain 2
Test Date	May 07, 2016		

Horizontal

	Freq	Level	Limit Line	Over Limit	Read Level	CableAntenna Loss	Antenna Factor	Preamp Factor	A/Pos	T/Pos	Remark	Pol/Phase
	MHz	dBuV/m	dBuV/m	dB	dBuV	dB	dB/m	dB	cm	deg		
1	11489.20	51.59	54.00	-2.41	37.81	10.51	39.20	35.93	107	17	Average	HORIZONTAL
2	11494.25	64.48	74.00	-9.52	50.70	10.51	39.20	35.93	107	17	Peak	HORIZONTAL

Vertical

	Freq	Level	Limit Line	Over Limit	Read Level	CableAntenna Loss	Antenna Factor	Preamp Factor	A/Pos	T/Pos	Remark	Pol/Phase
	MHz	dBuV/m	dBuV/m	dB	dBuV	dB	dB/m	dB	cm	deg		
1	11488.32	66.40	74.00	-7.60	52.62	10.51	39.20	35.93	100	183	Peak	VERTICAL
2	11491.36	52.26	54.00	-1.74	38.48	10.51	39.20	35.93	100	183	Average	VERTICAL



Temperature	24°C	Humidity	54%
Test Engineer	John Tong	Configurations	IEEE 802.11n MCS0 HT20 CH 157 / Chain 1 + Chain 2
Test Date	May 07, 2016		

Horizontal

	Freq	Level	Limit Line	Over Limit	Read Level	Cable Loss	Antenna Factor	Preamp Factor	A/Pos	T/Pos	Remark	Pol/Phase
	MHz	dBuV/m	dBuV/m	dB	dBuV	dB	dB/m	dB	cm	deg		
1	11568.88	65.57	74.00	-8.43	51.83	10.51	39.15	35.92	218	330	Peak	HORIZONTAL
2	11568.96	50.03	54.00	-3.97	36.29	10.51	39.15	35.92	218	330	Average	HORIZONTAL

Vertical

	Freq	Level	Limit Line	Over Limit	Read Level	Cable Loss	Antenna Factor	Preamp Factor	A/Pos	T/Pos	Remark	Pol/Phase
	MHz	dBuV/m	dBuV/m	dB	dBuV	dB	dB/m	dB	cm	deg		
1	11566.63	51.15	54.00	-2.85	37.41	10.51	39.15	35.92	100	182	Average	VERTICAL
2	11569.04	66.71	74.00	-7.29	52.97	10.51	39.15	35.92	100	182	Peak	VERTICAL



Temperature	24°C	Humidity	54%
Test Engineer	John Tong	Configurations	IEEE 802.11n MCS0 HT20 CH 165 / Chain 1 + Chain 2
Test Date	May 07, 2016		

Horizontal

	Freq	Level	Limit Line	Over Limit	Read Level	CableAntenna Loss	Antenna Factor	Preamp Factor	A/Pos	T/Pos	Remark	Pol/Phase
	MHz	dBuV/m	dBuV/m	dB	dBuV	dB	dB/m	dB	cm	deg		
1	11010.42	42.08	54.00	-11.92	28.24	10.51	39.30	35.97	122	252	Average	HORIZONTAL
2	11019.73	55.34	74.00	-18.66	41.50	10.51	39.30	35.97	122	252	Peak	HORIZONTAL

Vertical

	Freq	Level	Limit Line	Over Limit	Read Level	CableAntenna Loss	Antenna Factor	Preamp Factor	A/Pos	T/Pos	Remark	Pol/Phase
	MHz	dBuV/m	dBuV/m	dB	dBuV	dB	dB/m	dB	cm	deg		
1	11011.79	55.04	74.00	-18.96	41.20	10.51	39.30	35.97	189	168	Peak	VERTICAL
2	11011.81	42.14	54.00	-11.86	28.30	10.51	39.30	35.97	189	168	Average	VERTICAL



Temperature	24°C	Humidity	54%
Test Engineer	John Tong	Configurations	IEEE 802.11n MCS0 HT40 CH 38 / Chain 1 + Chain 2
Test Date	May 07, 2016		

Horizontal

	Freq	Level	Limit Line	Over Limit	Read Level	CableAntenna Loss	Antenna Factor	Preamp Factor	A/Pos	T/Pos	Remark	Pol/Phase
	MHz	dBuV/m	dBuV/m	dB	dBuV	dB	dB/m	dB	cm	deg		
1	15566.81	55.27	74.00	-18.73	41.74	11.01	38.38	35.86	157	113	Peak	HORIZONTAL
2	15574.21	41.65	54.00	-12.35	28.12	11.01	38.38	35.86	157	113	Average	HORIZONTAL

Vertical

	Freq	Level	Limit Line	Over Limit	Read Level	CableAntenna Loss	Antenna Factor	Preamp Factor	A/Pos	T/Pos	Remark	Pol/Phase
	MHz	dBuV/m	dBuV/m	dB	dBuV	dB	dB/m	dB	cm	deg		
1	15572.40	55.41	74.00	-18.59	41.88	11.01	38.38	35.86	162	215	Peak	VERTICAL
2	15574.09	41.70	54.00	-12.30	28.17	11.01	38.38	35.86	162	215	Average	VERTICAL



Temperature	24°C	Humidity	54%
Test Engineer	John Tong	Configurations	IEEE 802.11n MCS0 HT40 CH 46 / Chain 1 + Chain 2
Test Date	May 07, 2016		

Horizontal

	Freq	Level	Limit Line	Over Limit	Read Level	CableAntenna Loss	Antenna Factor	Preamp Factor	A/Pos	T/Pos	Remark	Pol/Phase
	MHz	dBuV/m	dBuV/m	dB	dBuV	dB	dB/m	dB	cm	deg		
1	16801.70	44.97	54.00	-9.03	28.37	12.23	40.18	35.81	183	45	Average	HORIZONTAL
2	16802.26	58.08	74.00	-15.92	41.48	12.23	40.18	35.81	183	45	Peak	HORIZONTAL

Vertical

	Freq	Level	Limit Line	Over Limit	Read Level	CableAntenna Loss	Antenna Factor	Preamp Factor	A/Pos	T/Pos	Remark	Pol/Phase
	MHz	dBuV/m	dBuV/m	dB	dBuV	dB	dB/m	dB	cm	deg		
1	16795.74	58.14	74.00	-15.86	41.54	12.23	40.18	35.81	196	122	Peak	VERTICAL
2	16801.46	45.05	54.00	-8.95	28.45	12.23	40.18	35.81	196	122	Average	VERTICAL



Temperature	24°C	Humidity	54%
Test Engineer	John Tong	Configurations	IEEE 802.11n MCS0 HT40 CH 151 / Chain 1 + Chain 2
Test Date	May 07, 2016		

Horizontal

	Freq	Level	Limit Line	Over Limit	Read Level	CableAntenna Loss	Antenna Factor	Preamp Factor	A/Pos	T/Pos	Remark	Pol/Phase
	MHz	dBuV/m	dBuV/m	dB	dBuV	dB	dB/m	dB	cm	deg		
1	11508.72	55.34	74.00	-18.66	41.56	10.51	39.20	35.93	158	166	Peak	HORIZONTAL
2	11514.49	41.69	54.00	-12.31	27.90	10.51	39.20	35.92	158	166	Average	HORIZONTAL

Vertical

	Freq	Level	Limit Line	Over Limit	Read Level	CableAntenna Loss	Antenna Factor	Preamp Factor	A/Pos	T/Pos	Remark	Pol/Phase
	MHz	dBuV/m	dBuV/m	dB	dBuV	dB	dB/m	dB	cm	deg		
1	11510.24	55.15	74.00	-18.85	41.36	10.51	39.20	35.92	169	64	Peak	VERTICAL
2	11512.28	41.54	54.00	-12.46	27.75	10.51	39.20	35.92	169	64	Average	VERTICAL



Temperature	24°C	Humidity	54%
Test Engineer	John Tong	Configurations	IEEE 802.11n MCS0 HT40 CH 159 / Chain 1 + Chain 2
Test Date	May 07, 2016		

Horizontal

	Freq	Level	Limit Line	Over Limit	Read Level	Cable Loss	Antenna Factor	Preamp Factor	A/Pos	T/Pos	Remark	Pol/Phase
	MHz	dBuV/m	dBuV/m	dB	dBuV	dB	dB/m	dB	cm	deg		
1	11545.66	55.86	74.00	-18.14	42.10	10.51	39.17	35.92	122	149	Peak	HORIZONTAL
2	11546.15	42.18	54.00	-11.82	28.42	10.51	39.17	35.92	122	149	Average	HORIZONTAL

Vertical

	Freq	Level	Limit Line	Over Limit	Read Level	Cable Loss	Antenna Factor	Preamp Factor	A/Pos	T/Pos	Remark	Pol/Phase
	MHz	dBuV/m	dBuV/m	dB	dBuV	dB	dB/m	dB	cm	deg		
1	11545.90	42.12	54.00	-11.88	28.36	10.51	39.17	35.92	155	106	Average	VERTICAL
2	11550.51	55.67	74.00	-18.33	41.93	10.51	39.15	35.92	155	106	Peak	VERTICAL

Note:

The amplitude of spurious emissions that are attenuated by more than 20dB below the permissible value has no need to be reported.

Emission level (dBuV/m) = 20 log Emission level (uV/m).

Corrected Reading: Antenna Factor + Cable Loss + Read Level - Preamp Factor = Level.

4.6. Band Edge Emissions Measurement

4.6.1. Limit

For transmitters operating in the 5.15-5.25 GHz band: all emissions outside of the 5.15-5.35 GHz band shall not exceed an e.i.r.p. of -27 dBm/MHz.

For transmitters operating in the 5.725-5.85 GHz band: all emissions shall be limited to a level of -27 dBm/MHz at 75 MHz or more above or below the band edge increasing linearly to 10 dBm/MHz at 25 MHz above or below the band edge, and from 25 MHz above or below the band edge increasing linearly to a level of 15.6 dBm/MHz at 5 MHz above or below the band edge, and from 5 MHz above or below the band edge increasing linearly to a level of 27 dBm/MHz at the band edge.

In addition, In case the emission fall within the restricted band specified on 15.205(a), then the 15.209(a) limit in the table below has to be followed.

Frequencies (MHz)	Field Strength (microrvolts/meter)	Measurement Distance (meters)
0.009~0.490	2400/F(kHz)	300
0.490~1.705	24000/F(kHz)	30
1.705~30.0	30	30
30~88	100	3
88~216	150	3
216~960	200	3
Above 960	500	3

4.6.2. Measuring Instruments and Setting

Please refer to section 5 of equipments list in this report. The following table is the setting of the spectrum analyzer.

Spectrum Parameter	Setting
Attenuation	Auto
Span Frequency	100 MHz
RBW / VBW (Emission in restricted band)	1 MHz / 3MHz for Peak, 1 MHz / 1/T for Average
RBW / VBW (Emission in non-restricted band)	1 MHz / 3MHz for Peak

4.6.3. Test Procedures

1. The test procedure is the same as section 4.5.3.

4.6.4. Test Setup Layout

This test setup layout is the same as that shown in section 4.5.4.

4.6.5. Test Deviation

There is no deviation with the original standard.

4.6.6. EUT Operation during Test

The EUT was programmed to be in continuously transmitting mode.

4.6.7. Test Result of Band Edge and Fundamental Emissions

Temperature	24°C	Humidity	54%
Test Engineer	John Tong	Configurations	IEEE 802.11a CH 36, 40, 48 / Chain 1
Test Date	May 07, 2016		

Channel 36

	Freq	Level	Limit	Over	Read	CableAntenna	Preamp	A/Pos	T/Pos	Remark	Pol/Phase
	MHz	dBuV/m	dBuV/m	dB	dBuV	dB	dB/m	dB	cm	deg	
1	5142.82	62.77	74.00	-11.23	58.22	7.88	33.17	36.50	121	90 Peak	VERTICAL
2	5149.55	50.29	54.00	-3.71	45.74	7.88	33.17	36.50	121	90 Average	VERTICAL
3	5179.68	106.29			101.64	7.91	33.23	36.49	121	90 Peak	VERTICAL
4	5180.64	97.02			92.37	7.91	33.23	36.49	121	90 Average	VERTICAL

Item 3, 4 are the fundamental frequency at 5180 MHz.

Channel 40

	Freq	Level	Limit	Over	Read	CableAntenna	Preamp	A/Pos	T/Pos	Remark	Pol/Phase
	MHz	dBuV/m	dBuV/m	dB	dBuV	dB	dB/m	dB	cm	deg	
1	5145.19	58.58	74.00	-15.42	54.03	7.88	33.17	36.50	102	111 Peak	HORIZONTAL
2	5150.00	45.43	54.00	-8.57	40.88	7.88	33.17	36.50	102	111 Average	HORIZONTAL
3	5200.64	96.90			92.22	7.92	33.25	36.49	102	111 Average	HORIZONTAL
4	5200.64	106.76			102.08	7.92	33.25	36.49	102	111 Peak	HORIZONTAL

Item 3, 4 are the fundamental frequency at 5200 MHz.

Channel 48

	Freq	Level	Limit	Over	Read	CableAntenna	Preamp	A/Pos	T/Pos	Remark	Pol/Phase
	MHz	dBuV/m	dBuV/m	dB	dBuV	dB	dB/m	dB	cm	deg	
1	5105.87	44.87	54.00	-9.13	40.45	7.84	33.09	36.51	108	117 Average	VERTICAL
2	5107.79	57.87	74.00	-16.13	53.45	7.84	33.09	36.51	108	117 Peak	VERTICAL
3	5239.52	106.31			101.54	7.91	33.34	36.48	108	117 Peak	VERTICAL
4	5240.96	96.31			91.54	7.91	33.34	36.48	108	117 Average	VERTICAL
5	5350.00	45.52	54.00	-8.48	40.57	7.88	33.53	36.46	108	117 Average	VERTICAL
6	5369.33	58.36	74.00	-15.64	53.39	7.88	33.55	36.46	108	117 Peak	VERTICAL

Item 3, 4 are the fundamental frequency at 5240 MHz.

Temperature	24°C	Humidity	54%
Test Engineer	John Tong	Configurations	IEEE 802.11a CH 149, 157, 165 / Chain 1
Test Date	May 07, 2016		

Channel 149

	Freq	Level	Limit Line	Over Limit	Read Level	CableAntenna Loss	Antenna Factor	Preamp Factor	A/Pos	T/Pos	Remark	Pol/Phase
	MHz	dBuV/m	dBuV/m	dB	dBuV	dB	dB/m	dB	cm	deg		
1	5620.00	59.70	68.20	-8.50	53.51	8.46	34.13	36.40	298	277	Peak	VERTICAL
2	5744.00	112.56			106.01	8.42	34.50	36.37	298	277	Peak	VERTICAL
3	5744.14	102.50			95.95	8.42	34.50	36.37	298	277	Average	VERTICAL
4	5952.50	60.02	68.20	-8.18	52.91	8.37	35.06	36.32	298	277	Peak	VERTICAL

Item 2, 3 are the fundamental frequency at 5745 MHz.

Channel 157

	Freq	Level	Limit Line	Over Limit	Read Level	CableAntenna Loss	Antenna Factor	Preamp Factor	A/Pos	T/Pos	Remark	Pol/Phase
	MHz	dBuV/m	dBuV/m	dB	dBuV	dB	dB/m	dB	cm	deg		
1	5639.00	59.92	68.20	-8.28	53.68	8.46	34.17	36.39	140	276	Peak	VERTICAL
2	5785.96	101.55			94.90	8.41	34.59	36.35	140	276	Average	VERTICAL
3	5786.50	111.49			104.84	8.41	34.59	36.35	140	276	Peak	VERTICAL
4	6011.00	61.00	68.20	-7.20	53.67	8.42	35.22	36.31	140	276	Peak	VERTICAL

Item 2, 3 are the fundamental frequency at 5785 MHz.

Channel 165

	Freq	Level	Limit Line	Over Limit	Read Level	CableAntenna Loss	Antenna Factor	Preamp Factor	A/Pos	T/Pos	Remark	Pol/Phase
	MHz	dBuV/m	dBuV/m	dB	dBuV	dB	dB/m	dB	cm	deg		
1	5642.50	60.07	68.20	-8.13	53.79	8.45	34.22	36.39	112	71	Peak	VERTICAL
2	5824.30	100.13			93.35	8.39	34.73	36.34	112	71	Average	VERTICAL
3	5825.00	109.58			102.80	8.39	34.73	36.34	112	71	Peak	VERTICAL
4	6007.00	60.59	68.20	-7.61	53.34	8.36	35.20	36.31	112	71	Peak	VERTICAL

Item 2, 3 are the fundamental frequency at 5825 MHz.

Temperature	24°C	Humidity	54%
Test Engineer	John Tong	Configurations	IEEE 802.11n MCS0 HT20 CH 36, 40, 48 / Chain 1 + Chain 2
Test Date	May 07, 2016		

Channel 36

	Freq	Level	Limit Line	Over Limit	Read Level	Cable Loss	Antenna Factor	Preamp Factor	A/Pos	T/Pos	Remark	Pol/Phase
	MHz	dBuV/m	dBuV/m	dB	dBuV	dB	dB/m	dB	cm	deg		
1	5141.54	69.69	74.00	-4.31	65.17	7.87	33.15	36.50	116	110	Peak	VERTICAL
2	5149.23	52.52	54.00	-1.48	47.97	7.88	33.17	36.50	116	110	Average	VERTICAL
3	5179.04	101.11			96.46	7.91	33.23	36.49	116	110	Average	VERTICAL
4	5181.28	111.37			106.72	7.91	33.23	36.49	116	110	Peak	VERTICAL

Item 3, 4 are the fundamental frequency at 5180 MHz.

Channel 40

	Freq	Level	Limit Line	Over Limit	Read Level	Cable Loss	Antenna Factor	Preamp Factor	A/Pos	T/Pos	Remark	Pol/Phase
	MHz	dBuV/m	dBuV/m	dB	dBuV	dB	dB/m	dB	cm	deg		
1	5110.58	59.04	74.00	-14.96	54.62	7.84	33.09	36.51	100	111	Peak	VERTICAL
2	5126.28	46.51	54.00	-7.49	42.04	7.85	33.12	36.50	100	111	Average	VERTICAL
3	5199.04	101.10			96.42	7.92	33.25	36.49	100	111	Average	VERTICAL
4	5199.04	111.30			106.62	7.92	33.25	36.49	100	111	Peak	VERTICAL

Item 3, 4 are the fundamental frequency at 5200 MHz.

Channel 48

	Freq	Level	Limit Line	Over Limit	Read Level	Cable Loss	Antenna Factor	Preamp Factor	A/Pos	T/Pos	Remark	Pol/Phase
	MHz	dBuV/m	dBuV/m	dB	dBuV	dB	dB/m	dB	cm	deg		
1	5116.92	57.36	74.00	-16.64	52.90	7.85	33.12	36.51	100	112	Peak	VERTICAL
2	5148.17	45.10	54.00	-8.90	40.55	7.88	33.17	36.50	100	112	Average	VERTICAL
3	5239.04	101.17			96.40	7.91	33.34	36.48	100	112	Average	VERTICAL
4	5239.04	110.57			105.80	7.91	33.34	36.48	100	112	Peak	VERTICAL
5	5368.37	45.76	54.00	-8.24	40.79	7.88	33.55	36.46	100	112	Average	VERTICAL
6	5374.62	57.87	74.00	-16.13	52.88	7.87	33.58	36.46	100	112	Peak	VERTICAL

Item 3, 4 are the fundamental frequency at 5240 MHz.

Temperature	24°C	Humidity	54%
Test Engineer	John Tong	Configurations	IEEE 802.11n MCS0 HT20 CH 149, 157, 165 / Chain 1 + Chain 2
Test Date	May 07, 2016		

Channel 149

	Freq	Level	Limit Line	Over Limit	Read Level	CableAntenna Loss	Antenna Factor	Preamp Factor	A/Pos	T/Pos	Remark	Pol/Phase
	MHz	dBuV/m	dBuV/m	dB	dBuV	dB	dB/m	dB	cm	deg		
1	5644.00	61.34	68.20	-6.86	55.06	8.45	34.22	36.39	100	274	Peak	VERTICAL
2	5745.80	107.97			101.41	8.42	34.50	36.36	100	274	Average	VERTICAL
3	5746.00	117.32			110.76	8.42	34.50	36.36	100	274	Peak	VERTICAL
4	5931.50	59.95	68.20	-8.25	52.90	8.37	35.01	36.33	100	274	Peak	VERTICAL

Item 2, 3 are the fundamental frequency at 5745 MHz.

Channel 157

	Freq	Level	Limit Line	Over Limit	Read Level	CableAntenna Loss	Antenna Factor	Preamp Factor	A/Pos	T/Pos	Remark	Pol/Phase
	MHz	dBuV/m	dBuV/m	dB	dBuV	dB	dB/m	dB	cm	deg		
1	5540.50	60.35	68.20	-7.85	54.59	8.29	33.89	36.42	100	259	Peak	VERTICAL
2	5786.25	107.25			100.60	8.41	34.59	36.35	100	259	Average	VERTICAL
3	5786.50	117.03			110.38	8.41	34.59	36.35	100	259	Peak	VERTICAL
4	5959.50	61.18	68.20	-7.02	54.02	8.37	35.11	36.32	100	259	Peak	VERTICAL

Item 2, 3 are the fundamental frequency at 5785 MHz.

Channel 165

	Freq	Level	Limit Line	Over Limit	Read Level	CableAntenna Loss	Antenna Factor	Preamp Factor	A/Pos	T/Pos	Remark	Pol/Phase
	MHz	dBuV/m	dBuV/m	dB	dBuV	dB	dB/m	dB	cm	deg		
1	5645.50	59.88	68.20	-8.32	53.60	8.45	34.22	36.39	100	274	Peak	VERTICAL
2	5824.00	115.61			108.83	8.39	34.73	36.34	100	274	Peak	VERTICAL
3	5826.09	106.55			99.77	8.39	34.73	36.34	100	274	Average	VERTICAL
4	5971.00	59.92	68.20	-8.28	52.76	8.37	35.11	36.32	100	274	Peak	VERTICAL

Item 2, 3 are the fundamental frequency at 5825 MHz.

Temperature	24°C	Humidity	54%
Test Engineer	John Tong	Configurations	IEEE 802.11n MCS0 HT40 CH 38, 46 / Chain 1 + Chain 2
Test Date	May 07, 2016		

Channel 38

	Freq	Level	Limit Line	Over Limit	Read Level	Cable Loss	Antenna Factor	Preamp Factor	A/Pos	T/Pos	Remark	Pol/Phase
	MHz	dBuV/m	dBuV/m	dB	dBuV	dB	dB/m	dB	cm	deg		
1	5148.65	50.16	54.00	-3.84	45.61	7.88	33.17	36.50	114	106	Average	VERTICAL
2	5148.97	66.09	74.00	-7.91	61.54	7.88	33.17	36.50	114	106	Peak	VERTICAL
3	5189.04	93.67			88.99	7.92	33.25	36.49	114	106	Average	VERTICAL
4	5191.60	102.77			98.09	7.92	33.25	36.49	114	106	Peak	VERTICAL

Item 3, 4 are the fundamental frequency at 5190 MHz.

Channel 46

	Freq	Level	Limit Line	Over Limit	Read Level	Cable Loss	Antenna Factor	Preamp Factor	A/Pos	T/Pos	Remark	Pol/Phase
	MHz	dBuV/m	dBuV/m	dB	dBuV	dB	dB/m	dB	cm	deg		
1	5137.05	56.92	74.00	-17.08	52.40	7.87	33.15	36.50	108	104	Peak	VERTICAL
2	5141.54	44.96	54.00	-9.04	40.44	7.87	33.15	36.50	108	104	Average	VERTICAL
3	5231.28	92.94			88.20	7.91	33.31	36.48	108	104	Average	VERTICAL
4	5231.28	102.66			97.92	7.91	33.31	36.48	108	104	Peak	VERTICAL

Item 3, 4 are the fundamental frequency at 5230 MHz.



Temperature	24°C	Humidity	54%
Test Engineer	John Tong	Configurations	IEEE 802.11n MCS0 HT40 CH 151, 159 / Chain 1 + Chain 2
Test Date	May 07, 2016		

Channel 151

	Freq	Level	Limit Line	Over Limit	Read Level	Cable Loss	Antenna Factor	Preamp Factor	A/Pos	T/Pos	Remark	Pol/Phase
	MHz	dBuV/m	dBuV/m	dB	dBuV	dB	dB/m	dB	cm	deg		
1	5642.00	63.56	68.20	-4.64	57.28	8.45	34.22	36.39	104	170	Peak	HORIZONTAL
2	5757.24	97.20			90.60	8.41	34.55	36.36	104	170	Average	HORIZONTAL
3	5757.50	107.52			100.92	8.41	34.55	36.36	104	170	Peak	HORIZONTAL
4	5985.00	64.28	68.20	-3.92	57.08	8.36	35.15	36.31	104	170	Peak	HORIZONTAL

Item 2, 3 are the fundamental frequency at 5755 MHz.

Channel 159

	Freq	Level	Limit Line	Over Limit	Read Level	Cable Loss	Antenna Factor	Preamp Factor	A/Pos	T/Pos	Remark	Pol/Phase
	MHz	dBuV/m	dBuV/m	dB	dBuV	dB	dB/m	dB	cm	deg		
1	5573.00	62.71	68.20	-5.49	56.75	8.38	33.99	36.41	100	288	Peak	VERTICAL
2	5793.85	102.71			96.02	8.40	34.64	36.35	100	288	Average	VERTICAL
3	5794.00	112.89			106.20	8.40	34.64	36.35	100	288	Peak	VERTICAL
4	5980.00	63.88	68.20	-4.32	56.68	8.36	35.15	36.31	100	288	Peak	VERTICAL

Item 2, 3 are the fundamental frequency at 5795 MHz.

Note:

Emission level (dBuV/m) = 20 log Emission level (uV/m)

Corrected Reading: Antenna Factor + Cable Loss + Read Level - Preamp Factor = Level

4.7. Frequency Stability Measurement

4.7.1. Limit

In-band emission is maintained within the band of operation under all conditions of normal operation as specified in the user's manual.

The transmitter center frequency tolerance shall be ± 20 ppm maximum for the 5 GHz band (IEEE 802.11n specification).

4.7.2. Measuring Instruments and Setting

Please refer to section 5 of equipments list in this report. The following table is the setting of the spectrum analyzer.

Spectrum Parameter	Setting
Attenuation	Auto
Span Frequency	Entire absence of modulation emissions bandwidth
RBW	10 kHz
VBW	10 kHz
Sweep Time	Auto

4.7.3. Test Procedures

1. The transmitter output (antenna port) was connected to the spectrum analyzer.
2. EUT have transmitted absence of modulation signal and fixed channelize.
3. Set the spectrum analyzer span to view the entire absence of modulation emissions bandwidth.
4. Set RBW = 10 kHz, VBW = 10 kHz with peak detector and maxhold settings.
5. f_c is declaring of channel frequency. Then the frequency error formula is $(f_c - f) / f_c \times 10^6$ ppm and the limit is less than ± 20 ppm (IEEE 802.11n specification).
6. Allow sufficient time (approximately 30 min) for the temperature of the chamber to stabilize, turn the EUT on and measure the operating frequency after 2, 5, and 10 minutes.
7. The test extreme voltage is to change the primary supply voltage from 85 to 115 percent of the nominal value
8. Extreme temperature is $-30^\circ\text{C} \sim 50^\circ\text{C}$.

4.7.4. Test Setup Layout

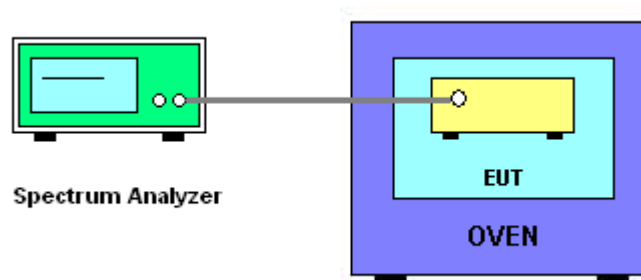

4.7.5. Test Deviation

There is no deviation with the original standard.

4.7.6. EUT Operation during Test

The EUT was programmed to be in continuously un-modulation transmitting mode.

4.7.7. Test Result of Frequency Stability

Temperature	24°C	Humidity	60%
Test Engineer	Clemens Fang	Test Date	May 10, 2016

Mode: 20 MHz / Chain 2

Voltage vs. Frequency Stability

Voltage (V)	Measurement Frequency (MHz)			
	5200 MHz			
	0 Minute	2 Minute	5 Minute	10 Minute
126.50	5199.9717	5199.9706	5199.9691	5199.9671
110.00	5199.9705	5199.9692	5199.9676	5199.9657
93.50	5199.9691	5199.9682	5199.9668	5199.9650
Max. Deviation (MHz)	0.0309	0.0318	0.0332	0.0350
Max. Deviation (ppm)	5.95	6.12	6.39	6.73
Result	Complies			

Temperature vs. Frequency Stability

Temperature (°C)	Measurement Frequency (MHz)			
	5200 MHz			
	0 Minute	2 Minute	5 Minute	10 Minute
-30	5199.9777	5199.9761	5199.9746	5199.9722
-20	5199.9759	5199.9746	5199.9729	5199.9708
-10	5199.9744	5199.9732	5199.9716	5199.9697
0	5199.9730	5199.9716	5199.9697	5199.9675
10	5199.9717	5199.9704	5199.9689	5199.9671
20	5199.9705	5199.9692	5199.9676	5199.9657
30	5199.9691	5199.9680	5199.9666	5199.9650
40	5199.9676	5199.9663	5199.9647	5199.9628
50	5199.9659	5199.9647	5199.9632	5199.9609
Max. Deviation (MHz)	0.0341	0.0353	0.0368	0.0391
Max. Deviation (ppm)	6.56	6.79	7.08	7.52
Result	Complies			

Voltage vs. Frequency Stability

Voltage	Measurement Frequency (MHz)			
(V)	5785 MHz			
	0 Minute	2 Minute	5 Minute	10 Minute
126.50	5784.9682	5784.9671	5784.9656	5784.9636
110.00	5784.9670	5784.9657	5784.9641	5784.9622
93.50	5784.9656	5784.9647	5784.9633	5784.9615
Max. Deviation (MHz)	0.0344	0.0353	0.0367	0.0385
Max. Deviation (ppm)	5.95	6.10	6.34	6.66
Result	Complies			

Temperature vs. Frequency Stability

Temperature	Measurement Frequency (MHz)			
(°C)	5785 MHz			
	0 Minute	2 Minute	5 Minute	10 Minute
-30	5784.9742	5784.9726	5784.9711	5784.9687
-20	5784.9724	5784.9711	5784.9694	5784.9673
-10	5784.9709	5784.9697	5784.9681	5784.9662
0	5784.9695	5784.9681	5784.9662	5784.9640
10	5784.9682	5784.9669	5784.9654	5784.9636
20	5784.9670	5784.9657	5784.9641	5784.9622
30	5784.9656	5784.9645	5784.9631	5784.9615
40	5784.9641	5784.9628	5784.9612	5784.9593
50	5784.9624	5784.9612	5784.9597	5784.9574
Max. Deviation (MHz)	0.0376	0.0388	0.0403	0.0426
Max. Deviation (ppm)	6.50	6.71	6.97	7.36
Result	Complies			

Mode: 40 MHz / Chain 2

Voltage vs. Frequency Stability

Voltage	Measurement Frequency (MHz)			
(V)	5190 MHz			
	0 Minute	2 Minute	5 Minute	10 Minute
126.50	5189.9721	5189.9710	5189.9695	5189.9675
110.00	5189.9709	5189.9696	5189.9680	5189.9661
93.50	5189.9695	5189.9686	5189.9672	5189.9654
Max. Deviation (MHz)	0.0305	0.0314	0.0328	0.0346
Max. Deviation (ppm)	5.87	6.05	6.32	6.66
Result	Complies			

Temperature vs. Frequency Stability

Temperature	Measurement Frequency (MHz)			
(°C)	5190 MHz			
	0 Minute	2 Minute	5 Minute	10 Minute
-30	5189.9781	5189.9765	5189.9750	5189.9726
-20	5189.9763	5189.9750	5189.9733	5189.9712
-10	5189.9748	5189.9736	5189.9720	5189.9701
0	5189.9734	5189.9720	5189.9701	5189.9679
10	5189.9721	5189.9708	5189.9693	5189.9675
20	5189.9709	5189.9696	5189.9680	5189.9661
30	5189.9695	5189.9684	5189.9670	5189.9654
40	5189.9680	5189.9667	5189.9651	5189.9632
50	5189.9663	5189.9651	5189.9636	5189.9613
Max. Deviation (MHz)	0.0337	0.0349	0.0364	0.0387
Max. Deviation (ppm)	6.49	6.72	7.01	7.45
Result	Complies			

Voltage vs. Frequency Stability

Voltage	Measurement Frequency (MHz)			
(V)	5755 MHz			
	0 Minute	2 Minute	5 Minute	10 Minute
126.50	5754.9682	5754.9671	5754.9656	5754.9636
110.00	5754.9670	5754.9657	5754.9641	5754.9622
93.50	5754.9656	5754.9647	5754.9633	5754.9615
Max. Deviation (MHz)	0.0344	0.0353	0.0367	0.0385
Max. Deviation (ppm)	5.98	6.13	6.38	6.69
Result	Complies			

Temperature vs. Frequency Stability

Temperature	Measurement Frequency (MHz)			
(°C)	5755 MHz			
	0 Minute	2 Minute	5 Minute	10 Minute
-30	5754.9742	5754.9726	5754.9711	5754.9687
-20	5754.9724	5754.9711	5754.9694	5754.9673
-10	5754.9709	5754.9697	5754.9681	5754.9662
0	5754.9695	5754.9681	5754.9662	5754.9640
10	5754.9682	5754.9669	5754.9654	5754.9636
20	5754.9670	5754.9657	5754.9641	5754.9622
30	5754.9656	5754.9645	5754.9631	5754.9615
40	5754.9641	5754.9628	5754.9612	5754.9593
50	5754.9624	5754.9612	5754.9597	5754.9574
Max. Deviation (MHz)	0.0376	0.0388	0.0403	0.0426
Max. Deviation (ppm)	6.53	6.74	7.00	7.40
Result	Complies			

4.8. Antenna Requirements

4.8.1. Limit

Except for special regulations, the Low-power Radio-frequency Devices must not be equipped with any jacket for installing an antenna with extension cable. An intentional radiator shall be designed to ensure that no antenna other than that furnished by the responsible party shall be used with the device. The use of a permanently attached antenna or of an antenna that uses a unique coupling to the intentional radiator shall be considered sufficient to comply with the provisions of this Section. The manufacturer may design the unit so that the user can replace a broken antenna, but the use of a standard antenna jack or electrical connector is prohibited. Further, this requirement does not apply to intentional radiators that must be professionally installed.

4.8.2. Antenna Connector Construction

Please refer to section 3.3 in this test report; antenna connector complied with the requirements.

5. LIST OF MEASURING EQUIPMENTS

Instrument	Manufacturer	Model No.	Serial No.	Characteristics	Calibration Date	Remark
Horn Antenna	EMCO	3115	00075790	750MHz ~ 18GHz	Oct. 22, 2015	Radiation (03CH01-CB)
Horn Antenna	Schwarzbeck	BBHA 9170	BBHA9170252	15GHz ~ 40GHz	Jul. 21, 2015	Radiation (03CH01-CB)
Pre-Amplifier	Agilent	8449B	3008A02310	1GHz ~ 26.5GHz	Jan. 18, 2016	Radiation (03CH01-CB)
Pre-Amplifier	WM	TF-130N-R1	923365	26GHz ~ 40GHz	Nov. 13, 2015	Radiation (03CH01-CB)
Spectrum Analyzer	R&S	FSP40	100056	9kHz ~ 40GHz	Oct. 27, 2015	Radiation (03CH01-CB)
RF Cable-high	Woken	High Cable-16	N/A	1 GHz ~ 18 GHz	Nov. 02, 2015	Radiation (03CH01-CB)
RF Cable-high	Woken	High Cable-17	N/A	1 GHz ~ 18 GHz	Nov. 02, 2015	Radiation (03CH01-CB)
RF Cable-high	Woken	High Cable-40G-1	N/A	18GHz ~ 40 GHz	Nov. 02, 2015	Radiation (03CH01-CB)
RF Cable-high	Woken	High Cable-40G-2	N/A	18GHz ~ 40 GHz	Nov. 02, 2015	Radiation (03CH01-CB)
Test Software	Audix	E3	6.2009-10-7	N/A	N/A	Radiation (03CH01-CB)
Spectrum analyzer	R&S	FSV40	100979	9kHz~40GHz	Dec. 09, 2015	Conducted (TH01-CB)
Temp. and Humidity Chamber	Ten Billion	TTH-D3SP	TBN-931011	-30~100 degree	Jun. 02, 2015	Conducted (TH01-CB)
RF Cable-high	Woken	RG402	High Cable-6	1 GHz – 26.5 GHz	Nov. 02, 2015	Conducted (TH01-CB)
RF Cable-high	Woken	RG402	High Cable-7	1 GHz – 26.5 GHz	Nov. 02, 2015	Conducted (TH01-CB)
RF Cable-high	Woken	RG402	High Cable-8	1 GHz – 26.5 GHz	Nov. 02, 2015	Conducted (TH01-CB)
RF Cable-high	Woken	RG402	High Cable-9	1 GHz – 26.5 GHz	Nov. 02, 2015	Conducted (TH01-CB)
RF Cable-high	Woken	RG402	High Cable-10	1 GHz – 26.5 GHz	Nov. 02, 2015	Conducted (TH01-CB)
Power Sensor	Agilent	U2021XA	MY53410001	50MHz~18GHz	Nov. 02, 2015	Conducted (TH01-CB)

Note: Calibration Interval of instruments listed above is one year.

6. MEASUREMENT UNCERTAINTY

Test Items	Uncertainty	Remark
Radiated Emission (1GHz ~ 18GHz)	3.7 dB	Confidence levels of 95%
Radiated Emission (18GHz ~ 40GHz)	3.5 dB	Confidence levels of 95%
Conducted Emission	1.7 dB	Confidence levels of 95%