



A D T

FCC TEST REPORT

REPORT NO.: RF981204H03A

MODEL NO.: F7D1401 v1

RECEIVED: Dec. 16, 2009

TESTED: Jan. 05 to 28, 2010

ISSUED: Feb. 01, 2010

APPLICANT: Belkin International, Inc.

ADDRESS: 501 West Walnut Street, Compton, CA
90220-5221, USA

ISSUED BY: Bureau Veritas Consumer Products Services (H.K.)
Ltd., Taoyuan Branch Hsin Chu Laboratory

ADDRESS: No. 81-1, Lu Liao Keng, 9th Ling, Wu Lung Tsuen,
Chiung Lin Hsiang, Hsin Chu Hsien 307, Taiwan

This test report consists of 81 pages in total. It may be duplicated completely for legal use with the approval of the applicant. It should not be reproduced except in full, without the written approval of our laboratory. The client should not use it to claim product endorsement by TAF or any government agencies. The test results in the report only apply to the tested sample.





A D T

Table of Contents

1.	CERTIFICATION	4
2.	SUMMARY OF TEST RESULTS	5
2.1	MEASUREMENT UNCERTAINTY	6
3.	GENERAL INFORMATION	7
3.1	GENERAL DESCRIPTION OF EUT	7
3.2	DESCRIPTION OF TEST MODES	9
3.2.1	TEST MODE APPLICABILITY AND TESTED CHANNEL DETAIL	10
3.3	GENERAL DESCRIPTION OF APPLIED STANDARDS	12
3.4	DESCRIPTION OF SUPPORT UNITS	13
3.5	CONFIGURATION OF SYSTEM UNDER TEST	14
4.	TEST TYPES AND RESULTS	15
4.1	CONDUCTED EMISSION MEASUREMENT	15
4.1.1	LIMITS OF CONDUCTED EMISSION MEASUREMENT	15
4.1.2	TEST INSTRUMENTS	15
4.1.3	TEST PROCEDURES	16
4.1.4	DEVIATION FROM TEST STANDARD	16
4.1.5	TEST SETUP	17
4.1.6	EUT OPERATING CONDITIONS	17
4.1.7	TEST RESULTS	18
4.2	RADIATED EMISSION MEASUREMENT	20
4.2.1	LIMITS OF RADIATED EMISSION MEASUREMENT	20
4.2.2	TEST INSTRUMENTS	21
4.2.3	TEST PROCEDURES	23
4.2.4	DEVIATION FROM TEST STANDARD	23
4.2.5	TEST SETUP	24
4.2.6	EUT OPERATING CONDITIONS	24
4.2.7	TEST RESULTS	25
4.3	6dB BANDWIDTH MEASUREMENT	54
4.3.1	LIMITS OF 6dB BANDWIDTH MEASUREMENT	54
4.3.2	TEST INSTRUMENTS	54
4.3.3	TEST PROCEDURE	55
4.3.4	DEVIATION FROM TEST STANDARD	55
4.3.5	TEST SETUP	55
4.3.6	EUT OPERATING CONDITIONS	55
4.3.7	TEST RESULTS	56
4.4	MAXIMUM PEAK OUTPUT POWER	60
4.4.1	LIMITS OF MAXIMUM PEAK OUTPUT POWER MEASUREMENT	60



A D T

4.4.2	INSTRUMENTS	60
4.4.3	TEST PROCEDURES.....	60
4.4.4	DEVIATION FROM TEST STANDARD	60
4.4.5	TEST SETUP	60
4.4.6	EUT OPERATING CONDITIONS.....	61
4.4.7	TEST RESULTS.....	62
4.5	POWER SPECTRAL DENSITY MEASUREMENT.....	64
4.5.1	LIMITS OF POWER SPECTRAL DENSITY MEASUREMENT	64
4.5.2	TEST INSTRUMENTS	64
4.5.3	TEST PROCEDURE	65
4.5.4	DEVIATION FROM TEST STANDARD	65
4.5.5	TEST SETUP	65
4.5.6	EUT OPERATING CONDITION	65
4.5.7	TEST RESULTS.....	66
4.6	CONDUCTED OUT-BAND EMISSION MEASUREMENT.....	70
4.6.1	LIMITS OF CONDUCTED OUT-BAND EMISSION MEASUREMENT	70
4.6.2	TEST INSTRUMENTS	70
4.6.3	TEST PROCEDURE	70
4.6.4	DEVIATION FROM TEST STANDARD	71
4.6.5	EUT OPERATING CONDITION	71
4.6.6	TEST RESULTS.....	71
5.	INFORMATION ON THE TESTING LABORATORIES	80
6.	APPENDIX-A- MODIFICATIONS RECORDERS FOR ENGINEERING CHANGES TO THE EUT BY THE LAB	81



1. CERTIFICATION

PRODUCT: Belkin Modem Router
BRAND NAME: Belkin
MODEL NO.: F7D1401 v1
TEST SAMPLE: R&D SAMPLE
TESTED: Jan. 05 to 28, 2010
APPLICANT: Belkin International, Inc.
STANDARDS: FCC Part 15, Subpart C (Section 15.247),
ANSI C63.4-2003

The above equipment (Model: F7D1401 v1) has been tested by **Bureau Veritas Consumer Products Services (H.K.) Ltd., Taoyuan Branch**, and found compliance with the requirement of the above standards. The test record, data evaluation & Equipment Under Test (EUT) configurations represented herein are true and accurate accounts of the measurements of the sample's EMC characteristics under the conditions specified in this report.

PREPARED BY : Midoli Peng , **DATE:** Feb. 01, 2010
(Midoli Peng, Specialist)

TECHNICAL ACCEPTANCE : Hank Chung , **DATE:** Feb. 01, 2010
(Hank Chung, Deputy Manager)

APPROVED BY : May Chen , **DATE:** Feb. 01, 2010
(May Chen, Deputy Manager)

2. SUMMARY OF TEST RESULTS

The EUT has been tested according to the following specifications:

For 802.11b & g, 2412~2462MHz Band

APPLIED STANDARD: FCC Part 15, Subpart C (Section 15.247)			
Standard Section	Test Type and Limit	Result	Remark
15.207	AC Power Conducted Emission	PASS	Meet the requirement of limit. Minimum passing margin is -14.76dB at 17.691MHz
15.247(a)(2)	Spectrum Bandwidth of a Direct Sequence Spread Spectrum System Limit: min. 500kHz	PASS	Meet the requirement of limit.
15.247(b)	Maximum Peak Output Power Limit: max. 30dBm	PASS	Meet the requirement of limit.
15.247(d)	Radiated Emissions Limit: Table 15.209	PASS	Meet the requirement of limit. Minimum passing margin is -0.6dB at 2390.0MHz
15.247(e)	Power Spectral Density Limit: max. 8dBm	PASS	Meet the requirement of limit.
15.247(d)	Conducted Out-Band Emission Measurement Limit: 20dB less than the peak value of fundamental frequency	PASS	Meet the requirement of limit.
15.203	Antenna Requirement	PASS	No antenna connector is used.



A D T

2.1 MEASUREMENT UNCERTAINTY

Where relevant, the following measurement uncertainty levels have been estimated for tests performed on the EUT as specified in CISPR 16-4-2:

This uncertainty represents an expanded uncertainty expressed at approximately the 95% confidence level using a coverage factor of $k=2$.

Measurement	Value
Conducted emissions	2.45 dB
Radiated emissions (30MHz-1GHz)	3.69 dB
Radiated emissions (1GHz -18GHz)	2.49 dB
Radiated emissions (18GHz -40GHz)	2.70 dB



A D T

3. GENERAL INFORMATION

3.1 GENERAL DESCRIPTION OF EUT

PRODUCT	Belkin Modem Router
MODEL NO.	F7D1401 v1
FCC ID	K7SF7D1401V1
POWER SUPPLY	DC 12V from power adapter
MODULATION TYPE	CCK, DQPSK, DBPSK for DSSS 64QAM, 16QAM, QPSK, BPSK for OFDM
MODULATION TECHNOLOGY	DSSS, OFDM
TRANSFER RATE	802.11b: 11 / 5.5 / 2 / 1Mbps 802.11g: 54 / 48 / 36 / 24 / 18 / 12 / 9 / 6Mbps 802.11n (20MHz, 400ns GI): 72.2 / 65 / 57.8 / 43.3 / 28.9 / 21.7 / 14.4 / 7.2Mbps 802.11n (40MHz, 400ns GI): 150 / 135 / 120 / 90 / 60 / 45 / 30 / 15Mbps
OPRTAING FREQUENCY	2412 ~ 2462MHz
NUMBER OF CHANNEL	11 for 802.11b, 802.11g, 802.11n (20MHz) 7 for 802.11n (40MHz)
MAXIMUM OUTPUT POWER	802.11b: 93.3mW 802.11g: 389.0mW 802.11n (20MHz): 407.4mW 802.11n (40MHz): 346.7mW
ANTENNA TYPE	PIFA antenna , antenna gain : 2dBi
ANTENNA CONNECTOR	NA
DATA CABLE	NA
I/O PORTS	RJ-11 Port x 1 RJ-45 Port x 4
ASSOCIATED DEVICES	Adapter x1

NOTE:

1. The EUT incorporates a SISO function with 802.11b, 802.11g, 802.11n. Physically, the EUT provides one completed transmitter and receiver.
2. The EUT is 1 * 1 spatial SISO without beam forming function. The antenna configuration is one transmitter antenna and one receiver antenna, as there is 1 PIFA antenna.
3. The EUT complies with 802.11n standards and backwards compatible with 802.11b, 802.11g products.
4. The EUT, operates in the 2.4GHz frequency range, lets you connect IEEE 802.11g or IEEE 802.11b and 802.11n technique devices to the network.

5. The EUT must be supplied with a power adapter as following information:

Brand:	LEI
Model No.:	481210003CT
Input power :	AC 120V, 0.25A, 60Hz
Output power :	DC 12V, 1A DC output cable (Unshielded, 1.8m)

6. The above EUT information was declared by manufacturer and for more detailed features description, please refer to the manufacturer's specifications or user's manual.



A D T

3.2 DESCRIPTION OF TEST MODES

Operated in 2400 ~ 2483.5MHz band:

Eleven channels are provided for 802.11b, 802.11g, 802.11n (20MHz):

CHANNEL	FREQUENCY	CHANNEL	FREQUENCY
1	2412MHz	7	2442MHz
2	2417MHz	8	2447MHz
3	2422MHz	9	2452MHz
4	2427MHz	10	2457MHz
5	2432MHz	11	2462MHz
6	2437MHz		

Seven channels are provided for 802.11n (40MHz):

CHANNEL	FREQUENCY	CHANNEL	FREQUENCY
1	2422MHz	5	2442MHz
2	2427MHz	6	2447MHz
3	2432MHz	7	2452MHz
4	2437MHz		



A D T

3.2.1 TEST MODE APPLICABILITY AND TESTED CHANNEL DETAIL

EUT CONFIGURE MODE	APPLICABLE TO				DESCRIPTION
	PLC	RE < 1G	RE ≥ 1G	APCM	
-	√	√	√	√	-

Where **PLC**: Power Line Conducted Emission **RE < 1G**: Radiated Emission below 1GHz
RE ≥ 1G: Radiated Emission above 1GHz **APCM**: Antenna Port Conducted Measurement

POWER LINE CONDUCTED EMISSION TEST:

- Pre-Scan has been conducted to determine the worst-case mode from all possible combinations between available modulations, data rates and antenna ports (if EUT with antenna diversity architecture).
- Following channel(s) was (were) selected for the final test as listed below.

MODE	AVAILABLE CHANNEL	TESTED CHANNEL	MODULATION TECHNOLOGY	MODULATION TYPE	DATA RATE (Mbps)
802.11n (20MHz)	1 to 11	1, 6, 11	OFDM	BPSK	7.2

RADIATED EMISSION TEST (BELOW 1 GHz):

- Pre-Scan has been conducted to determine the worst-case mode from all possible combinations between available modulations, data rates and antenna ports (if EUT with antenna diversity architecture).
- Following channel(s) was (were) selected for the final test as listed below.

MODE	AVAILABLE CHANNEL	TESTED CHANNEL	MODULATION TECHNOLOGY	MODULATION TYPE	DATA RATE (Mbps)
802.11n (20MHz)	1 to 11	1, 6, 11	OFDM	BPSK	7.2

RADIATED EMISSION TEST (ABOVE 1 GHz):

- Pre-Scan has been conducted to determine the worst-case mode from all possible combinations between available modulations, data rates and antenna ports (if EUT with antenna diversity architecture).
- Following channel(s) was (were) selected for the final test as listed below.

MODE	AVAILABLE CHANNEL	TESTED CHANNEL	MODULATION TECHNOLOGY	MODULATION TYPE	DATA RATE (Mbps)
802.11b	1 to 11	1, 6, 11	DSSS	DBPSK	1
802.11g	1 to 11	1, 6, 11	OFDM	BPSK	6
802.11n (20MHz)	1 to 11	1, 6, 11	OFDM	BPSK	7.2
802.11n (40MHz)	1 to 7	1, 4, 7	OFDM	BPSK	15

CONDUCTED OUT-BAND EMISSION MEASUREMENT:

- Pre-Scan has been conducted to determine the worst-case mode from all possible combinations between available modulations, data rates and antenna ports (if EUT with antenna diversity architecture).
- Following channel(s) was (were) selected for the final test as listed below.

MODE	AVAILABLE CHANNEL	TESTED CHANNEL	MODULATION TECHNOLOGY	MODULATION TYPE	DATA RATE (Mbps)
802.11b	1 to 11	1, 11	DSSS	DBPSK	1
802.11g	1 to 11	1, 11	OFDM	BPSK	6
802.11n (20MHz)	1 to 11	1, 11	OFDM	BPSK	7.2
802.11n (40MHz)	1 to 7	1, 7	OFDM	BPSK	15

ANTENNA PORT CONDUCTED MEASUREMENT:

- This item includes all test value of each mode, but only includes spectrum plot of worst value of each mode.
- Pre-Scan has been conducted to determine the worst-case mode from all possible combinations between available modulations, data rates and antenna ports (if EUT with antenna diversity architecture).
- Following channel(s) was (were) selected for the final test as listed below.

MODE	AVAILABLE CHANNEL	TESTED CHANNEL	MODULATION TECHNOLOGY	MODULATION TYPE	DATA RATE (Mbps)
802.11b	1 to 11	1, 6, 11	DSSS	DBPSK	1
802.11g	1 to 11	1, 6, 11	OFDM	BPSK	6
802.11n (20MHz)	1 to 11	1, 6, 11	OFDM	BPSK	7.2
802.11n (40MHz)	1 to 7	1, 4, 7	OFDM	BPSK	15

TEST CONDITION:

APPLICABLE TO	ENVIRONMENTAL CONDITIONS	INPUT POWER (SYSTEM)	TESTED BY
RE≥1G	14deg. C, 70%RH, 1015 hPa	120Vac, 60Hz	Frank Liu
RE<1G	25deg. C, 60%RH, 1015 hPa	120Vac, 60Hz	Andy Ho
PLC	23deg. C, 58%RH, 1015 hPa	120Vac, 60Hz	Leo Peng
APCM	25deg. C, 60%RH, 1015 hPa	120Vac, 60Hz	Kent Liu

3.3 GENERAL DESCRIPTION OF APPLIED STANDARDS

The EUT is a Belkin Modem Router. According to the specifications of the manufacturer, it must comply with the requirements of the following standards:

FCC Part 15, Subpart C. (15.247)

ANSI C63.4-2003

All test items have been performed and recorded as per the above standards.

NOTE: The EUT is also considered as a kind of computer peripheral, because the connection to computer is necessary for typical use. It has been verified to comply with the requirements of FCC Part 15, Subpart B, Class B (DoC). The test report has been issued separately.



A D T

3.4 DESCRIPTION OF SUPPORT UNITS

The EUT has been tested as an independent unit together with other necessary accessories or support units. The following support units or accessories were used to form a representative test configuration during the tests.

NO.	PRODUCT	BRAND	MODEL NO.	SERIAL NO.	FCC ID
1	NOTEBOOK COMPUTER	DELL	PP18L	12252644560	FCC DoC
2	NOTEBOOK COMPUTER	DELL	PPT	17044664176	E2K24GBRL
3	CO-ROUTER	ZyXEL	IES-1000	S08024701597	FCC DoC
4	HUB	ZyXEL	ES-116P	S060H02000215	FCC DoC

NO.	SIGNAL CABLE DESCRIPTION OF THE ABOVE SUPPORT UNITS
1	UTP Cable (10m)
2	UTP Cable (3m)
3	RJ-11 Cable (10m)
4	UTP Cable (10m)

NOTE: All power cords of the above support units are non shielded (1.8m).

3.5 CONFIGURATION OF SYSTEM UNDER TEST

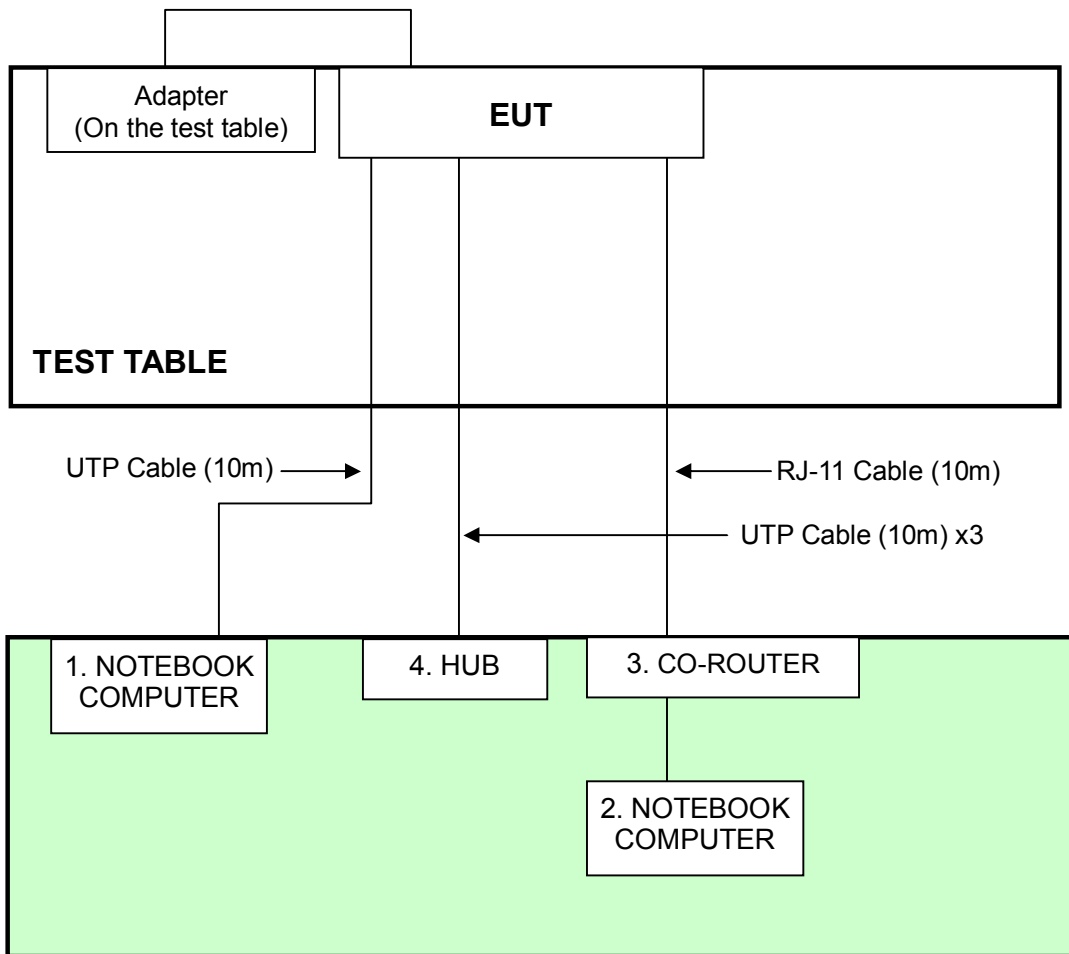

4. TEST TYPES AND RESULTS

4.1 CONDUCTED EMISSION MEASUREMENT

4.1.1 LIMITS OF CONDUCTED EMISSION MEASUREMENT

FREQUENCY OF EMISSION (MHz)	CONDUCTED LIMIT (dB μ V)	
0.15-0.5	Quasi-peak	Average
0.5-5	66 to 56	56 to 46
5-30	56	46
	60	50

- NOTE:**
1. The lower limit shall apply at the transition frequencies.
 2. The limit decreases in line with the logarithm of the frequency in the range of 0.15 to 0.50 MHz.
 3. All emanations from a class A/B digital device or system, including any network of conductors and apparatus connected thereto, shall not exceed the level of field strengths specified above.

4.1.2 TEST INSTRUMENTS

DESCRIPTION & MANUFACTURER	MODEL NO.	SERIAL NO.	CALIBRATED DATE	CALIBRATED UNTIL
ROHDE & SCHWARZ Test Receiver	ESCS 30	100287	Mar. 05, 2009	Mar. 04, 2010
Line-Impedance Stabilization Network (for EUT)	NSLK 8127	8127-523	Sep. 23, 2009	Sep. 22, 2010
Line-Impedance Stabilization Network (for Peripheral)	KNW-407	8-1395-12	May 04, 2009	May 03, 2010
RF Cable (JYBAO)	5DFB	COACAB-001	Dec. 14, 2009	Dec. 13, 2010
50 ohms Terminator	50	3	Oct. 28, 2009	Oct. 27, 2010
Software	BV ADT_Cond_V7.3.7	NA	NA	NA

Note:

1. The calibration interval of the above test instruments is 12 months and the calibrations are traceable to NML/ROC and NIST/USA.
2. The test was performed in Shielded Room No. A.
3. The VCCI Con A Registration No. is C-817.

4.1.3 TEST PROCEDURES

- a. The EUT was placed 0.4 meters from the conducting wall of the shielded room with EUT being connected to the power mains through a line impedance stabilization network (LISN). Other support units were connected to the power mains through another LISN. The two LISNs provide 50 ohm/ 50uH of coupling impedance for the measuring instrument.
- b. Both lines of the power mains connected to the EUT were checked for maximum conducted interference.
- c. The frequency range from F7D1401 v1kHz to 30MHz was searched. Emission levels under (Limit - 20dB) were not recorded.

4.1.4 DEVIATION FROM TEST STANDARD

No deviation

4.1.5 TEST SETUP

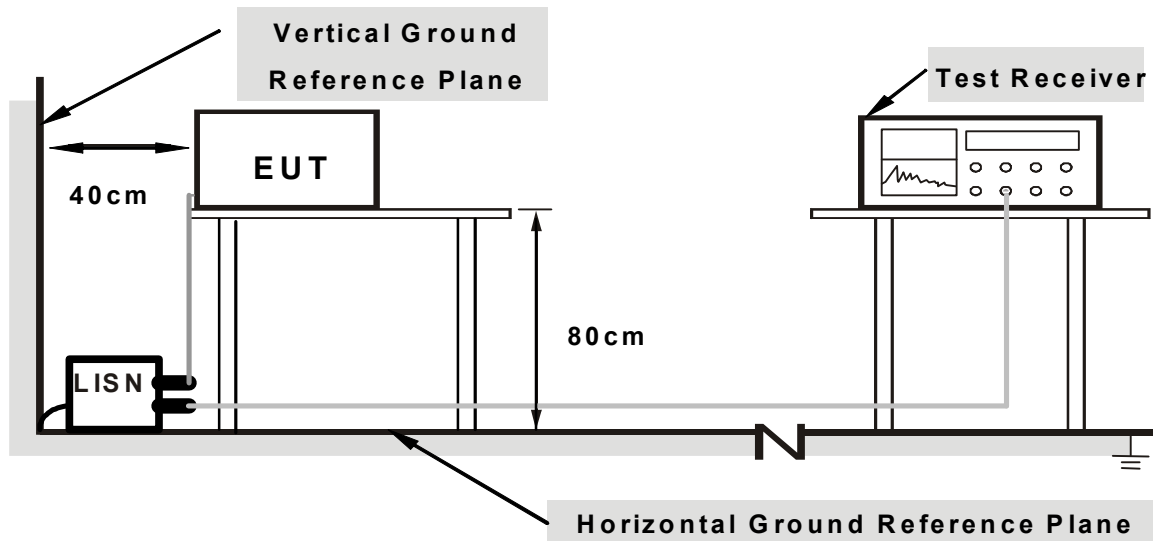

Note: 1. Support units were connected to second LISN.

2. Both of LISNs (AMN) are 80 cm from EUT and at least 80 from other units and other metal planes

For the actual test configuration, please refer to the related item – Photographs of the Test Configuration.

4.1.6 EUT OPERATING CONDITIONS

- a. Placed the EUT on testing table.
- b. Prepared other computer systems to act as communication partners and placed them outside of testing area.
- c. The communication partners run test program “QA_RT3052_V1.0.0.2” to enable EUT under transmission/receiving condition continuously via one UTP cable and one RJ-11 cable transmission.

4.1.7 TEST RESULTS

802.11n (20MHz) OFDM MODULATION:

PHASE	Line (L)	6dB BANDWIDTH	9 kHz
--------------	----------	----------------------	-------

No	Freq. [MHz]	Corr. Factor (dB)	Reading Value [dB (uV)]		Emission Level [dB (uV)]		Limit [dB (uV)]		Margin (dB)	
			Q.P.	AV.	Q.P.	AV.	Q.P.	AV.	Q.P.	AV.
			1	0.162	0.04	23.17	-	23.21	-	65.38
2	0.353	0.06	18.05	-	18.11	-	58.89	48.89	-40.78	-
3	0.693	0.07	17.42	-	17.49	-	56.00	46.00	-38.51	-
4	2.133	0.13	20.60	-	20.73	-	56.00	46.00	-35.27	-
5	10.059	0.36	30.94	-	31.30	-	60.00	50.00	-28.70	-
6	17.691	0.51	44.73	-	45.24	-	60.00	50.00	-14.76	-

- REMARKS:**
1. Q.P. and AV. are abbreviations of quasi-peak and average individually.
 2. "-": The Quasi-peak reading value also meets average limit and measurement with the average detector is unnecessary.
 3. The emission levels of other frequencies were very low against the limit.
 4. Margin value = Emission level - Limit value
 5. Correction factor = Insertion loss + Cable loss
 6. Emission Level = Correction Factor + Reading Value.

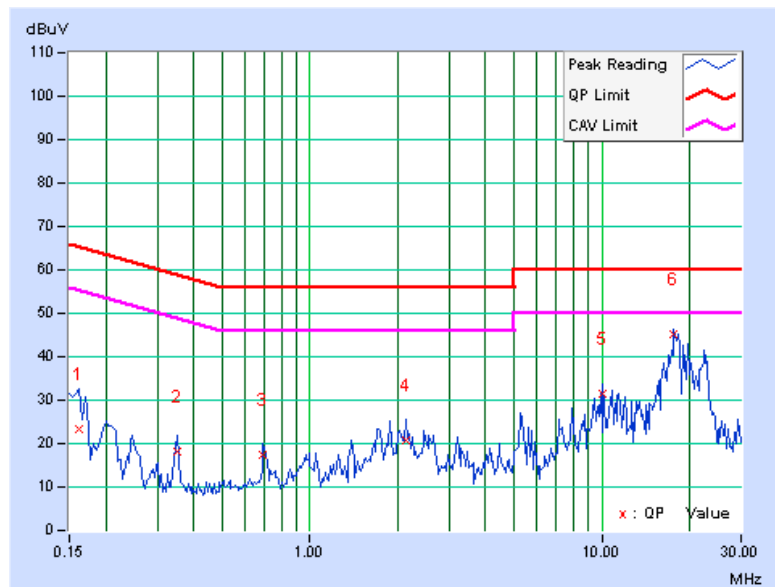

PHASE	Neutral (N)	6dB BANDWIDTH	9 kHz
--------------	-------------	----------------------	-------

No	Freq. [MHz]	Corr. Factor (dB)	Reading Value		Emission Level		Limit		Margin	
			[dB (uV)]		[dB (uV)]		[dB (uV)]		(dB)	
			Q.P.	AV.	Q.P.	AV.	Q.P.	AV.	Q.P.	AV.
1	0.170	0.05	22.52	-	22.57	-	64.98	54.98	-42.41	-
2	1.391	0.11	17.72	-	17.83	-	56.00	46.00	-38.17	-
3	1.879	0.13	22.11	-	22.24	-	56.00	46.00	-33.76	-
4	11.465	0.40	32.25	-	32.65	-	60.00	50.00	-27.35	-
5	18.363	0.53	40.48	-	41.01	-	60.00	50.00	-18.99	-
6	22.457	0.65	39.18	-	39.83	-	60.00	50.00	-20.17	-

- REMARKS:**
1. Q.P. and AV. are abbreviations of quasi-peak and average individually.
 2. "-": The Quasi-peak reading value also meets average limit and measurement with the average detector is unnecessary.
 3. The emission levels of other frequencies were very low against the limit.
 4. Margin value = Emission level - Limit value
 5. Correction factor = Insertion loss + Cable loss
 6. Emission Level = Correction Factor + Reading Value.

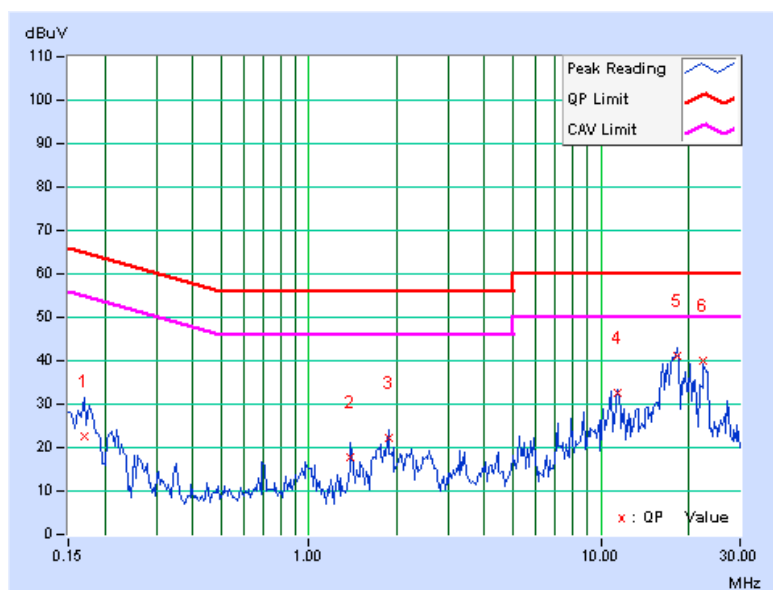

4.2 RADIATED EMISSION MEASUREMENT

4.2.1 LIMITS OF RADIATED EMISSION MEASUREMENT

Emissions radiated outside of the specified bands, shall be according to the general radiated limits in 15.209 as following:

Frequencies (MHz)	Field strength (microvolts/meter)	Measurement distance (meters)
0.009-0.490	2400/F(kHz)	300
0.490-1.705	24000/F(kHz)	30
1.705-30.0	30	30
30-88	100	3
88-216	F7D1401 v1	3
216-960	200	3
Above 960	500	3

NOTE:

1. The lower limit shall apply at the transition frequencies.
2. Emission level (dBuV/m) = 20 log Emission level (uV/m).
3. As shown in 15.35(b), for frequencies above 1000MHz, the field strength limits are based on average detector, however, the peak field strength of any emission shall not exceed the maximum permitted average limits, specified above by more than 20dB under any condition of modulation.



A D T

4.2.2 TEST INSTRUMENTS

Below 1GHz test:

DESCRIPTION & MANUFACTURER	MODEL NO.	SERIAL NO.	CALIBRATED DATE	CALIBRATED UNTIL
ADVANTEST Spectrum Analyzer	U3751	170100022	Nov. 18, 2009	Nov. 17, 2010
ADVANTEST Spectrum Analyzer	U3772	160100280	Sep. 21, 2009	Sep. 20, 2010
HP Pre_Amplifier	8449B	3008A01922	Sep. 25, 2009	Sep. 24, 2010
ROHDE & SCHWARZ Test Receiver	ESCS 30	100027	May 05, 2009	May 04, 2010
SCHWARZBECK Broadband Antenna	VULB-9168	263	April 29, 2009	April 28, 2010
Schwarzbeck Horn_Antenna	BBHA9120	D123	Sep. 21, 2009	Sep. 20, 2010
Schwarzbeck Horn_Antenna	BBHA 9170	BBHA9170153	Jan. 23, 2009	Jan. 22, 2010
RF Switches	EM-H-01-1	1009	Aug. 10, 2009	Aug. 09, 2010
RF Cable	8DFB	STACAB-30M-1GHz-091	Feb. 19, 2009	Feb. 18, 2010
Software	ADT_Radiated_V7.6.15.9.2	NA	NA	NA
CT Antenna Tower & Turn Table	TT100	ADT01	NA	NA
CORCOM AC Filter	MRI2030	107/108	NA	NA

Note: 1. The calibration interval of the above test instruments is 12 months and the calibrations are traceable to NML/ROC and NIST/USA.

2. The horn antenna, HP preamplifier (model: 8449B) and Spectrum Analyzer (model: U3772) are used only for the measurement of emission frequency above 1GHz if tested.

3. The test was performed in Open Site No. A.

4. The VCCI Site Registration No. is R-782.

5. The FCC Site Registration No. is 91097.

6. The CANADA Site Registration No. is IC 7450G-1.



A D T

Above 1GHz test:

DESCRIPTION & MANUFACTURER	MODEL NO.	SERIAL NO.	CALIBRATED DATE	CALIBRATED UNTIL
ROHDE & SCHWARZ Spectrum Analyzer	FSP40	100036	Dec. 18, 2009	Dec. 17, 2010
Agilent PSA Spectrum Analyzer	E4446A	MY46180622	Apr. 24 , 2009	Apr. 23 , 2010
HP Pre_Amplifier	8449B	300801923	Nov. 02, 2009	Nov. 01, 2010
ROHDE & SCHWARZ Test Receiver	ESCS30	847124/029	Aug. 28, 2009	Aug. 27, 2010
SCHWARZBECK TRILOG Broadband Antenna	VULB 9168	138	April 29, 2009	April 28, 2010
Schwarzbeck Horn_Antenna	BBHA9120	D124	Dec. 18, 2009	Dec. 17, 2010
Schwarzbeck Horn_Antenna	BBHA 9170	BBHA9170153	Jan. 22, 2009	Jan. 21, 2010
RF Switches	EMH-011	1001	NA	NA
RF CABLE (Chaintek)	Sucoflex 106	28077	Aug. 14, 2009	Aug. 13, 2010
RF Cable	8DFB	STCCAB-30M-1GHz	NA	NA
Software	ADT_Radiated_V7.6.15.9.2	NA	NA	NA
CT Antenna Tower & Turn Table	NA	NA	NA	NA

- Note: 1. The calibration interval of the above test instruments is 12 months and the calibrations are traceable to NML/ROC and NIST/USA.
2. The horn antenna, HP preamplifier (model: 8449B) and Spectrum Analyzer (model: FSP40) are used only for the measurement of emission frequency above 1GHz if tested.
3. The test was performed in Open Site No. C.
4. The FCC Site Registration No. is 656396.
5. The VCCI Site Registration No. is R-1626.
6. The CANADA Site Registration No. is IC 7450G-3.



A D T

4.2.3 TEST PROCEDURES

- a. The EUT was placed on the top of a rotating table 0.8 meters above the ground at a 10 meter open area test site. The table was rotated 360 degrees to determine the position of the highest radiation.
- b. The EUT was set 3 meters away from the interference-receiving antenna, which was mounted on the top of a variable-height antenna tower.
- c. The antenna is a broadband antenna, and its height is varied from one meter to four meters above the ground to determine the maximum value of the field strength. Both horizontal and vertical polarizations of the antenna are set to make the measurement.
- d. For each suspected emission, the EUT was arranged to its worst case and then the antenna was tuned to heights from 1 meter to 4 meters and the rotatable table was turned from 0 degrees to 360 degrees to find the maximum reading.
- e. The test-receiver system was set to Peak Detect Function and Specified Bandwidth with Maximum Hold Mode.
- f. If the emission level of the EUT in peak mode was 10dB lower than the limit specified, then testing could be stopped and the peak values of the EUT would be reported. Otherwise the emissions that did not have 10dB margin would be re-tested one by one using peak, quasi-peak or average method as specified and then reported in a data sheet.

NOTE:

1. The resolution bandwidth and video bandwidth of test receiver/spectrum analyzer is 120kHz for Peak detection (PK) and Quasi-peak detection (QP) at frequency below 1GHz.
2. The resolution bandwidth of test receiver/spectrum analyzer is 1 MHz and the video bandwidth is 3 MHz for Peak detection (PK) at frequency above 1GHz.
3. The resolution bandwidth of test receiver/spectrum analyzer is 1 MHz and the video bandwidth is 10 Hz for Average detection (AV) at frequency above 1GHz.

4.2.4 DEVIATION FROM TEST STANDARD

No deviation

4.2.5 TEST SETUP

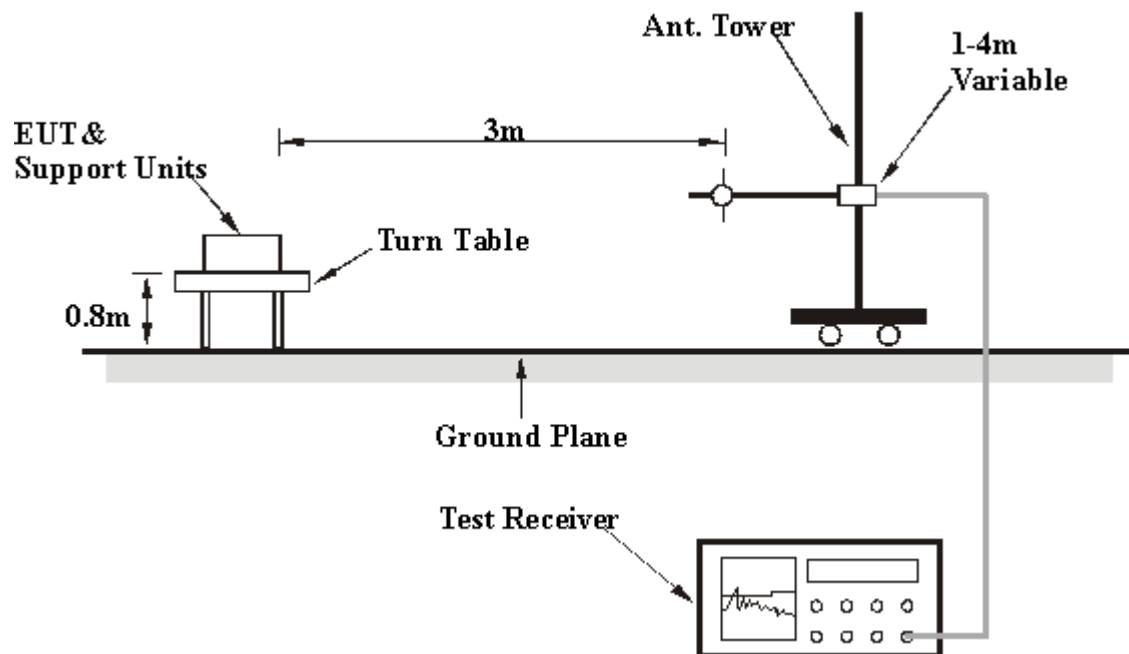

For the actual test configuration, please refer to the related item – Photographs of the Test Configuration.

4.2.6 EUT OPERATING CONDITIONS

Same as 4.1.6



A D T

4.2.7 TEST RESULTS

BELOW 1GHz WORST-CASE DATA : DRAFT 802.11n (20MHz) OFDM MODULATION

EUT TEST CONDITION		MEASUREMENT DETAIL	
CHANNEL	Channel 6	FREQUENCY RANGE	Below 1000MHz
INPUT POWER	120Vac, 60 Hz	DETECTOR FUNCTION	Quasi-Peak
ENVIRONMENTAL CONDITIONS	25deg. C, 60%RH 1025 hPa	TESTED BY	Andy Ho

ANTENNA POLARITY & TEST DISTANCE: HORIZONTAL AT 3 M								
NO.	FREQ. (MHz)	EMISSION LEVEL (dBuV/m)	LIMIT (dBuV/m)	MARGIN (dB)	ANTENNA HEIGHT (m)	TABLE ANGLE (Degree)	RAW VALUE (dBuV)	CORRECTION FACTOR (dB/m)
1	250.00	39.5 QP	46.0	-6.5	1.00 H	19	25.80	13.67
2	399.99	35.7 QP	46.0	-10.3	1.00 H	17	17.20	18.46
3	500.00	33.8 QP	46.0	-12.2	1.52 H	19	12.50	21.31
4	625.04	32.9 QP	46.0	-13.2	1.13 H	19	9.00	23.85
5	800.00	37.1 QP	46.0	-8.9	1.00 H	233	10.50	26.56
6	875.00	35.0 QP	46.0	-11.0	1.21 H	71	7.17	27.80
7	896.00	36.2 QP	46.0	-9.8	1.00 H	255	8.10	28.11
8	1000.00	35.5 QP	54.0	-18.5	1.00 H	279	6.29	29.21
ANTENNA POLARITY & TEST DISTANCE: VERTICAL AT 3 M								
NO.	FREQ. (MHz)	EMISSION LEVEL (dBuV/m)	LIMIT (dBuV/m)	MARGIN (dB)	ANTENNA HEIGHT (m)	TABLE ANGLE (Degree)	RAW VALUE (dBuV)	CORRECTION FACTOR (dB/m)
1	125.00	30.3 QP	43.5	-13.2	1.00 V	9	17.51	12.83
2	250.00	38.4 QP	46.0	-7.6	1.00 V	11	24.70	13.67
3	375.00	35.8 QP	46.0	-10.3	1.53 V	19	17.90	17.85
4	500.00	35.4 QP	46.0	-10.6	1.31 V	19	14.10	21.31
5	875.00	33.2 QP	46.0	-12.8	1.16 V	163	5.40	27.80
6	896.00	35.6 QP	46.0	-10.4	1.00 V	105	7.50	28.11
7	1000.00	38.9 QP	54.0	-15.1	1.09 V	358	9.70	29.21

- REMARKS:**
1. Emission level (dBuV/m) = Raw Value (dBuV) + Correction Factor (dB/m).
 2. Correction Factor (dB/m) = Antenna Factor (dB/m) + Cable Factor (dB).
 3. The other emission levels were very low against the limit.
 4. Margin value = Emission level – Limit value.



A D T

ABOVE 1GHz WORST-CASE DATA

802.11b DSSS MODULATION

EUT TEST CONDITION		MEASUREMENT DETAIL	
CHANNEL	Channel 1	FREQUENCY RANGE	1 ~ 25GHz
INPUT POWER	120Vac, 60 Hz	DETECTOR FUNCTION	Peak (PK) Average (AV)
ENVIRONMENTAL CONDITIONS	14deg. C, 70%RH 1025 hPa	TESTED BY	Frank Liu

ANTENNA POLARITY & TEST DISTANCE: HORIZONTAL AT 3 M								
NO.	FREQ. (MHz)	EMISSION LEVEL (dBuV/m)	LIMIT (dBuV/m)	MARGIN (dB)	ANTENNA HEIGHT (m)	TABLE ANGLE (Degree)	RAW VALUE (dBuV)	CORRECTION FACTOR (dB/m)
1	2386.13	55.4 PK	74.0	-18.6	1.29 H	81	25.39	30.05
2	2386.13	42.2 AV	54.0	-11.8	1.29 H	81	12.19	30.05
3	*2412.00	99.2 PK			1.29 H	80	69.05	30.15
4	*2412.00	96.0 AV			1.29 H	80	65.89	30.15
5	4824.00	55.5 PK	74.0	-18.5	1.55 H	234	20.07	35.43
6	4824.00	53.3 AV	54.0	-0.7	1.55 H	234	17.87	35.43

ANTENNA POLARITY & TEST DISTANCE: VERTICAL AT 3 M								
NO.	FREQ. (MHz)	EMISSION LEVEL (dBuV/m)	LIMIT (dBuV/m)	MARGIN (dB)	ANTENNA HEIGHT (m)	TABLE ANGLE (Degree)	RAW VALUE (dBuV)	CORRECTION FACTOR (dB/m)
1	2390.00	59.6 PK	74.0	-14.4	1.15 V	174	29.53	30.06
2	2390.00	44.8 AV	54.0	-9.2	1.15 V	174	14.72	30.06
3	*2412.00	103.4 PK			1.15 V	164	73.25	30.15
4	*2412.00	100.0 AV			1.15 V	164	69.83	30.15
5	4824.00	53.5 PK	74.0	-20.5	1.48 V	264	18.07	35.43
6	4824.00	50.8 AV	54.0	-3.2	1.48 V	264	15.37	35.43

- REMARKS:**
1. Emission level (dBuV/m) = Raw Value (dBuV) + Correction Factor (dB/m).
 2. Correction Factor (dB/m) = Antenna Factor (dB/m) + Cable Factor (dB).
 3. The other emission levels were very low against the limit.
 4. Margin value = Emission level – Limit value.
 5. “ * “: Fundamental frequency.



A D T

EUT TEST CONDITION		MEASUREMENT DETAIL	
CHANNEL	Channel 6	FREQUENCY RANGE	1 ~ 25GHz
INPUT POWER	120Vac, 60 Hz	DETECTOR FUNCTION	Peak (PK) Average (AV)
ENVIRONMENTAL CONDITIONS	14deg. C, 70%RH 1025 hPa	TESTED BY	Frank Liu

ANTENNA POLARITY & TEST DISTANCE: HORIZONTAL AT 3 M								
NO.	FREQ. (MHz)	EMISSION LEVEL (dBuV/m)	LIMIT (dBuV/m)	MARGIN (dB)	ANTENNA HEIGHT (m)	TABLE ANGLE (Degree)	RAW VALUE (dBuV)	CORRECTION FACTOR (dB/m)
1	*2437.00	99.7 PK			1.55 H	82	69.46	30.24
2	*2437.00	96.7 AV			1.55 H	82	66.42	30.24
3	4874.00	55.7 PK	74.0	-18.3	1.40 H	237	20.18	35.52
4	4874.00	53.1 AV	54.0	-0.9	1.40 H	237	17.58	35.52
5	7311.00	54.0 PK	74.0	-20.0	1.37 H	210	12.04	41.96
6	7311.00	45.0 AV	54.0	-9.0	1.37 H	210	3.04	41.96
ANTENNA POLARITY & TEST DISTANCE: VERTICAL AT 3 M								
NO.	FREQ. (MHz)	EMISSION LEVEL (dBuV/m)	LIMIT (dBuV/m)	MARGIN (dB)	ANTENNA HEIGHT (m)	TABLE ANGLE (Degree)	RAW VALUE (dBuV)	CORRECTION FACTOR (dB/m)
1	*2437.00	103.1 PK			1.04 V	152	72.86	30.24
2	*2437.00	99.5 AV			1.04 V	152	69.26	30.24
3	4874.00	53.0 PK	74.0	-21.0	1.40 V	244	17.46	35.52
4	4874.00	48.7 AV	54.0	-5.3	1.40 V	244	13.15	35.52
5	7311.00	53.2 PK	74.0	-20.8	1.47 V	243	11.22	41.96
6	7311.00	40.4 AV	54.0	-13.6	1.47 V	243	-1.59	41.96

- REMARKS:**
1. Emission level (dBuV/m) = Raw Value (dBuV) + Correction Factor (dB/m).
 2. Correction Factor (dB/m) = Antenna Factor (dB/m) + Cable Factor (dB).
 3. The other emission levels were very low against the limit.
 4. Margin value = Emission level – Limit value.
 5. “ * “: Fundamental frequency.



A D T

EUT TEST CONDITION		MEASUREMENT DETAIL	
CHANNEL	Channel 11	FREQUENCY RANGE	1 ~ 25GHz
INPUT POWER	120Vac, 60 Hz	DETECTOR FUNCTION	Peak (PK) Average (AV)
ENVIRONMENTAL CONDITIONS	14deg. C, 70%RH 1025 hPa	TESTED BY	Frank Liu

ANTENNA POLARITY & TEST DISTANCE: HORIZONTAL AT 3 M

NO.	FREQ. (MHz)	EMISSION LEVEL (dBuV/m)	LIMIT (dBuV/m)	MARGIN (dB)	ANTENNA HEIGHT (m)	TABLE ANGLE (Degree)	RAW VALUE (dBuV)	CORRECTION FACTOR (dB/m)
1	*2462.00	102.1 PK			1.53 H	140	71.76	30.34
2	*2462.00	99.0 AV			1.53 H	140	68.66	30.34
3	2483.50	58.5 PK	74.0	-15.5	1.52 H	143	28.10	30.43
4	2483.50	43.5 AV	54.0	-10.6	1.52 H	143	13.02	30.43
5	4924.00	55.4 PK	74.0	-18.6	1.37 H	263	19.78	35.62
6	4924.00	53.2 AV	54.0	-0.8	1.37 H	263	17.58	35.62
7	7386.00	53.4 PK	74.0	-20.6	1.52 H	250	11.34	42.10
8	7386.00	41.2 AV	54.0	-12.9	1.52 H	250	-0.95	42.10

ANTENNA POLARITY & TEST DISTANCE: VERTICAL AT 3 M

NO.	FREQ. (MHz)	EMISSION LEVEL (dBuV/m)	LIMIT (dBuV/m)	MARGIN (dB)	ANTENNA HEIGHT (m)	TABLE ANGLE (Degree)	RAW VALUE (dBuV)	CORRECTION FACTOR (dB/m)
1	*2462.00	103.5 PK			1.03 V	162	73.16	30.34
2	*2462.00	99.8 AV			1.03 V	162	69.46	30.34
3	2483.50	58.4 PK	74.0	-15.6	1.29 V	179	28.00	30.43
4	2483.50	43.7 AV	54.0	-10.3	1.29 V	179	13.31	30.43
5	4924.00	52.3 PK	74.0	-21.7	1.31 V	296	16.71	35.62
6	4924.00	48.5 AV	54.0	-5.5	1.31 V	296	12.86	35.62
7	7386.00	52.9 PK	74.0	-21.1	1.32 V	315	10.82	42.10
8	7386.00	39.1 AV	54.0	-14.9	1.32 V	315	-2.98	42.10

- REMARKS:**
1. Emission level (dBuV/m) = Raw Value (dBuV) + Correction Factor (dB/m).
 2. Correction Factor (dB/m) = Antenna Factor (dB/m) + Cable Factor (dB).
 3. The other emission levels were very low against the limit.
 4. Margin value = Emission level – Limit value.
 5. “ * “: Fundamental frequency.

RESTRICTED BANDEDGE (802.11b MODE, CH1, HORIZONTAL)

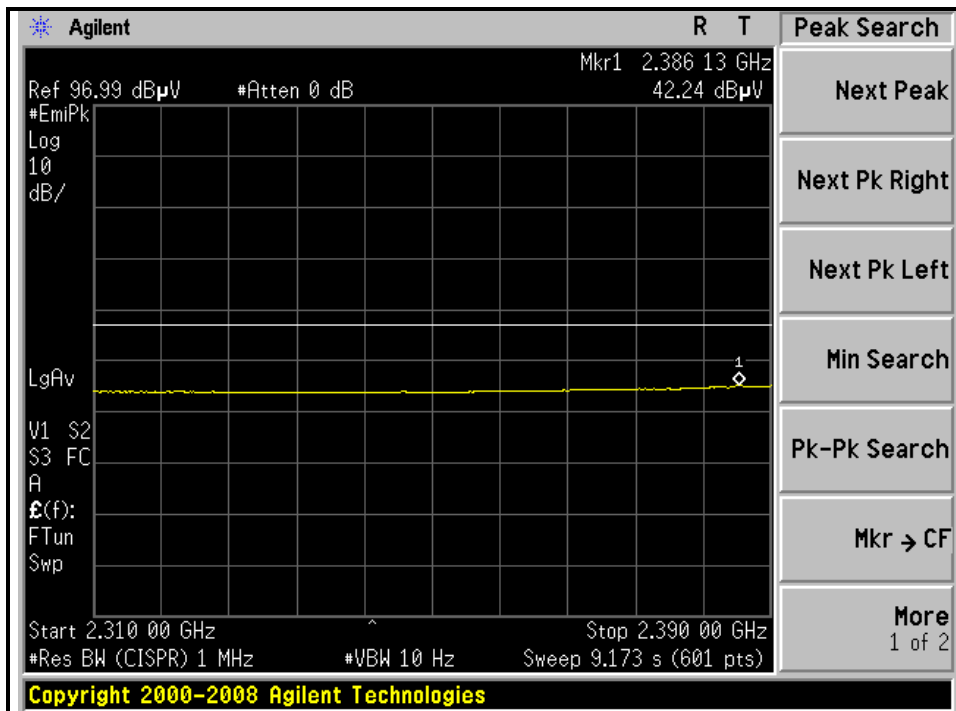
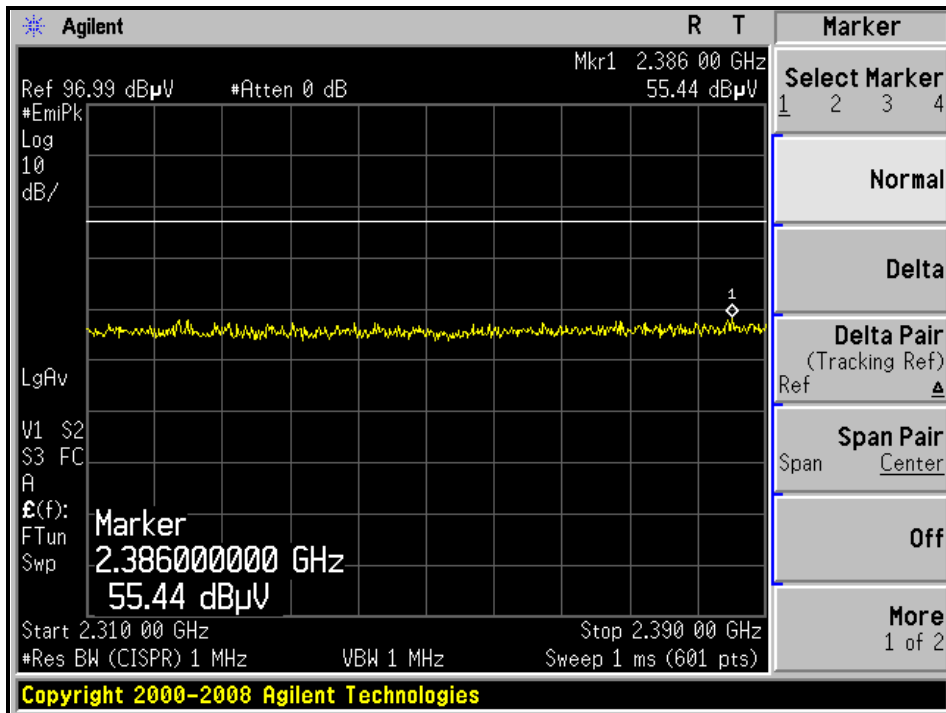



A D T

RESTRICTED BANDEDGE (802.11b MODE, CH1, VERTICAL)

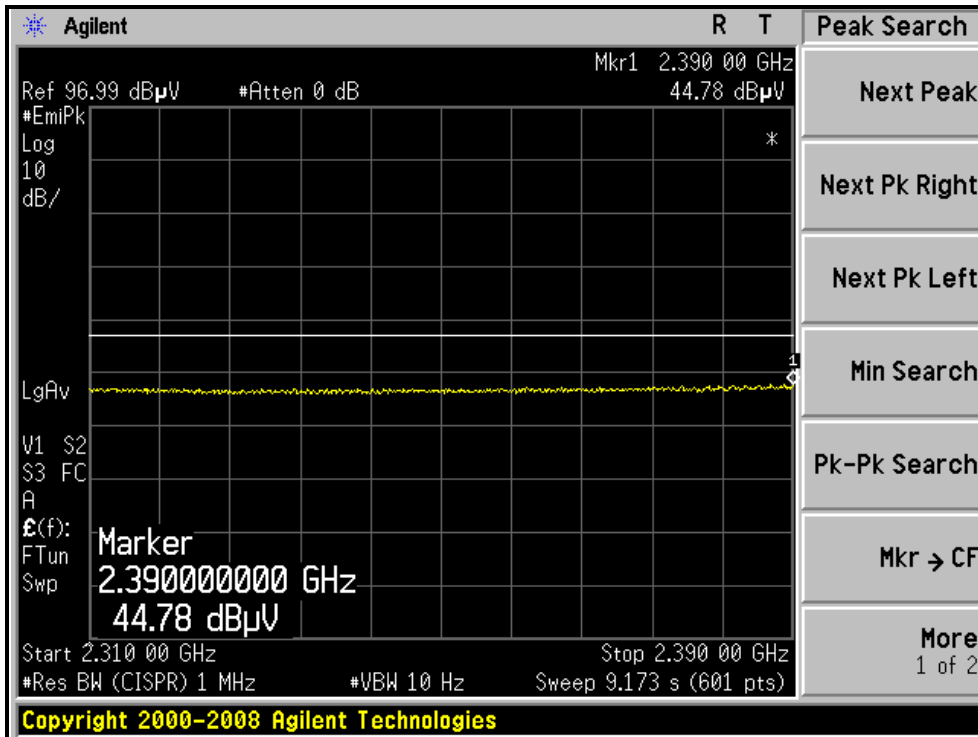
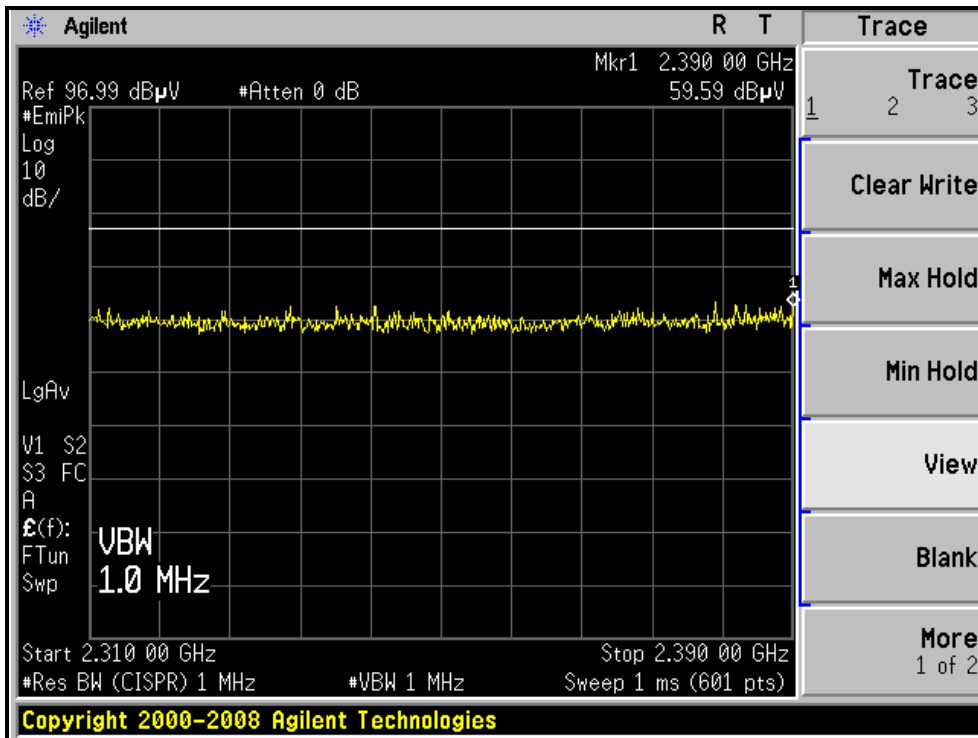



A D T

RESTRICTED BANDEDGE (802.11b MODE, CH11, HORIZONTAL)

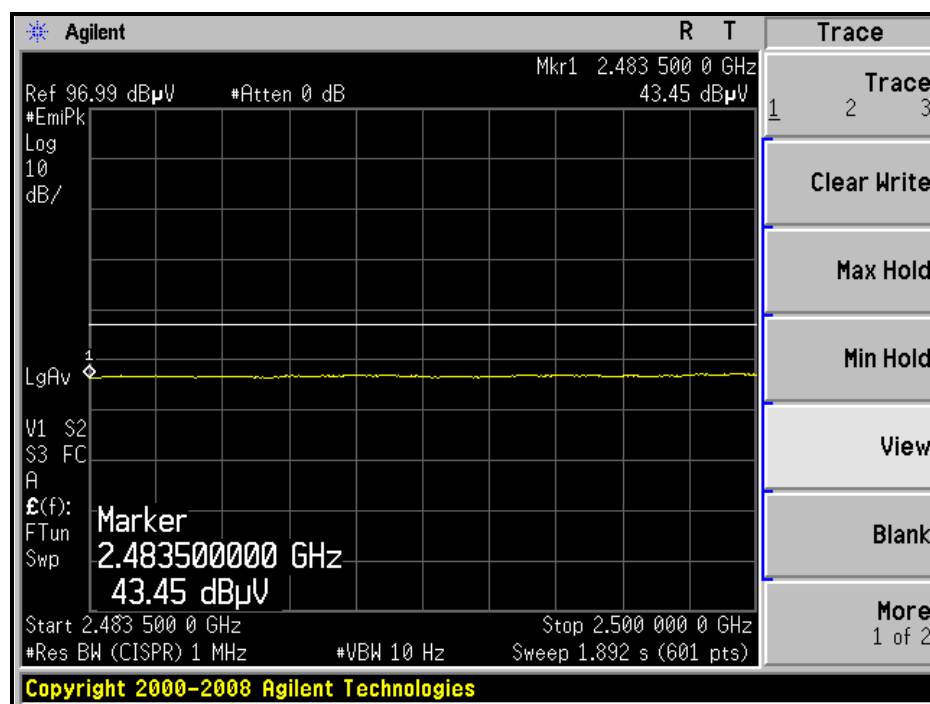
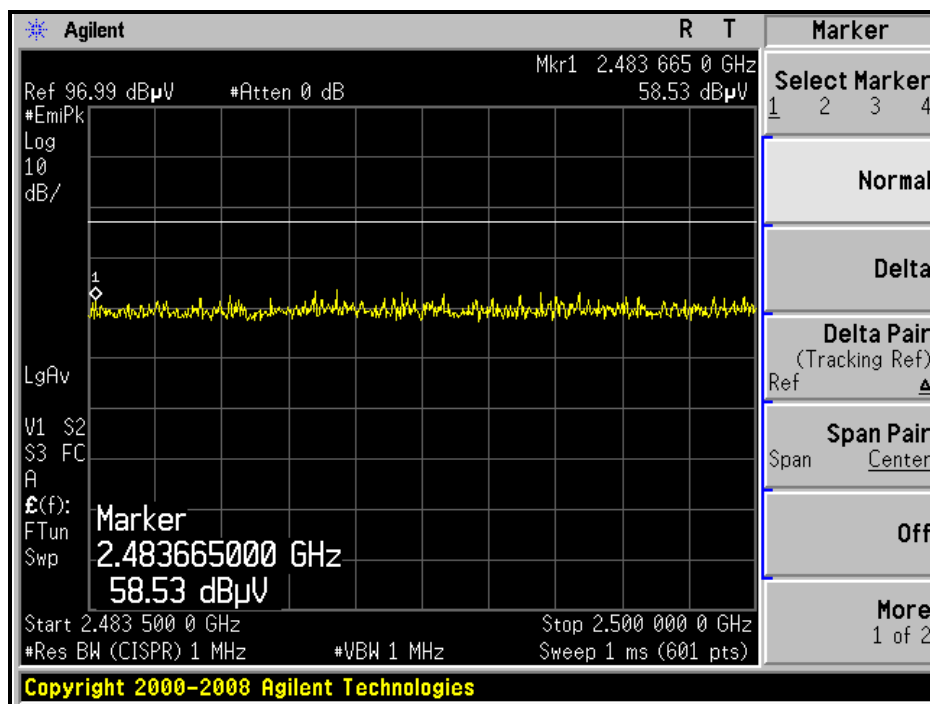



A D T

RESTRICTED BANDEDGE (802.11b MODE, CH11, VERTICAL)

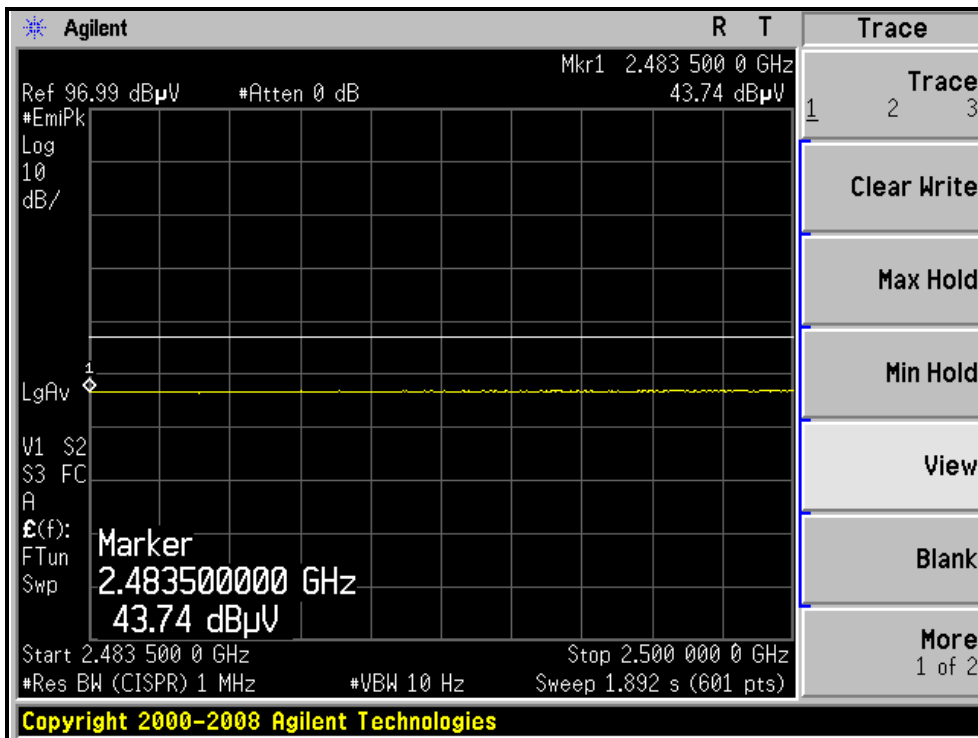
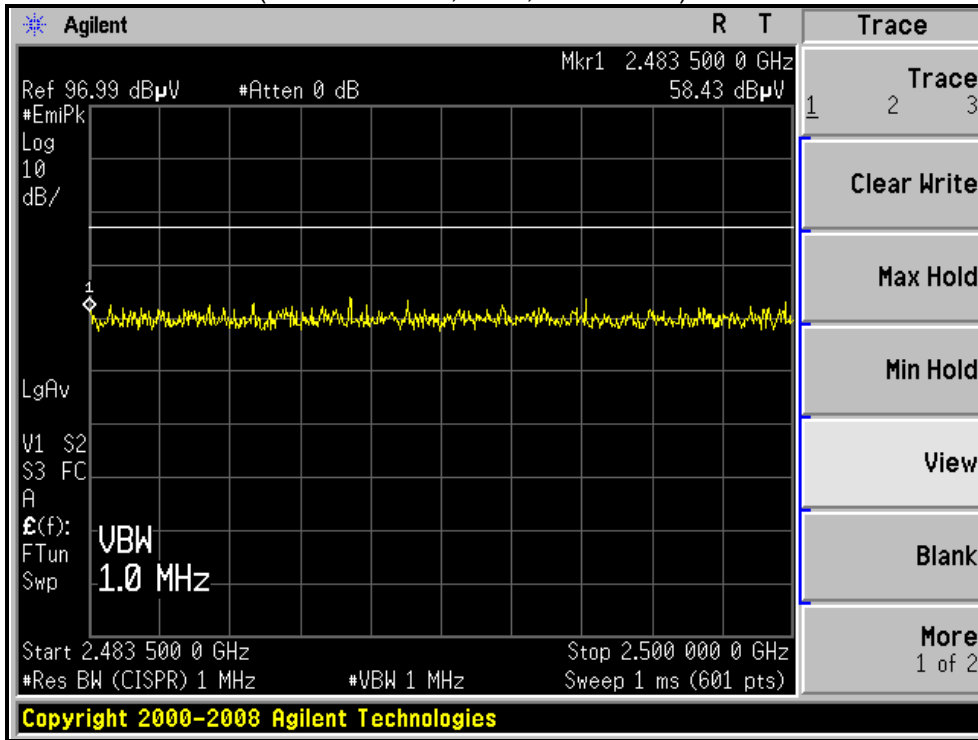



A D T

802.11g OFDM MODULATION

EUT TEST CONDITION		MEASUREMENT DETAIL	
CHANNEL	Channel 1	FREQUENCY RANGE	1 ~ 25GHz
INPUT POWER	120Vac, 60 Hz	DETECTOR FUNCTION	Peak (PK) Average (AV)
ENVIRONMENTAL CONDITIONS	14deg. C, 70%RH 1025 hPa	TESTED BY	Frank Liu

ANTENNA POLARITY & TEST DISTANCE: HORIZONTAL AT 3 M

NO.	FREQ. (MHz)	EMISSION LEVEL (dBuV/m)	LIMIT (dBuV/m)	MARGIN (dB)	ANTENNA HEIGHT (m)	TABLE ANGLE (Degree)	RAW VALUE (dBuV)	CORRECTION FACTOR (dB/m)
1	2390.00	69.4 PK	74.0	-4.6	1.54 H	135	39.30	30.06
2	2390.00	53.0 AV	54.0	-1.0	1.54 H	135	22.92	30.06
3	*2412.00	103.0 PK			1.51 H	138	72.85	30.15
4	*2412.00	94.3 AV			1.51 H	138	64.15	30.15
5	4824.00	48.3 PK	74.0	-25.7	1.36 H	224	12.87	35.43
6	4824.00	36.6 AV	54.0	-17.4	1.36 H	224	1.17	35.43

ANTENNA POLARITY & TEST DISTANCE: VERTICAL AT 3 M

NO.	FREQ. (MHz)	EMISSION LEVEL (dBuV/m)	LIMIT (dBuV/m)	MARGIN (dB)	ANTENNA HEIGHT (m)	TABLE ANGLE (Degree)	RAW VALUE (dBuV)	CORRECTION FACTOR (dB/m)
1	2390.00	70.5 PK	74.0	-3.5	1.10 V	166	40.41	30.06
2	2390.00	53.4 AV	54.0	-0.6	1.10 V	166	23.37	30.06
3	*2412.00	104.3 PK			1.10 V	166	74.15	30.15
4	*2412.00	95.5 AV			1.10 V	166	65.35	30.15
5	4824.00	44.2 PK	74.0	-29.8	1.35 V	240	8.77	35.43
6	4824.00	32.5 AV	54.0	-21.5	1.35 V	240	-2.93	35.43

- REMARKS:**
1. Emission level (dBuV/m) = Raw Value (dBuV) + Correction Factor (dB/m).
 2. Correction Factor (dB/m) = Antenna Factor (dB/m) + Cable Factor (dB).
 3. The other emission levels were very low against the limit.
 4. Margin value = Emission level – Limit value.
 5. “ * “: Fundamental frequency.



A D T

EUT TEST CONDITION		MEASUREMENT DETAIL	
CHANNEL	Channel 6	FREQUENCY RANGE	1 ~ 25GHz
INPUT POWER	120Vac, 60 Hz	DETECTOR FUNCTION	Peak (PK) Average (AV)
ENVIRONMENTAL CONDITIONS	14deg. C, 70%RH 1025 hPa	TESTED BY	Frank Liu

ANTENNA POLARITY & TEST DISTANCE: HORIZONTAL AT 3 M								
NO.	FREQ. (MHz)	EMISSION LEVEL (dBuV/m)	LIMIT (dBuV/m)	MARGIN (dB)	ANTENNA HEIGHT (m)	TABLE ANGLE (Degree)	RAW VALUE (dBuV)	CORRECTION FACTOR (dB/m)
1	*2437.00	104.3 PK			1.51 H	219	74.06	30.24
2	*2437.00	95.4 AV			1.51 H	219	65.16	30.24
3	4874.00	58.2 PK	74.0	-15.8	1.41 H	238	22.68	35.52
4	4874.00	45.6 AV	54.0	-8.4	1.41 H	238	10.08	35.52
5	7311.00	65.5 PK	74.0	-8.5	1.37 H	211	23.54	41.96
6	7311.00	53.2 AV	54.0	-0.8	1.37 H	211	11.24	41.96

ANTENNA POLARITY & TEST DISTANCE: VERTICAL AT 3 M								
NO.	FREQ. (MHz)	EMISSION LEVEL (dBuV/m)	LIMIT (dBuV/m)	MARGIN (dB)	ANTENNA HEIGHT (m)	TABLE ANGLE (Degree)	RAW VALUE (dBuV)	CORRECTION FACTOR (dB/m)
1	2390.00	62.2 PK	74.0	-11.8	1.29 V	164	32.14	30.06
2	2390.00	48.2 AV	54.0	-5.8	1.29 V	164	18.14	30.06
3	*2437.00	107.7 PK			1.07 V	162	77.46	30.24
4	*2437.00	99.1 AV			1.07 V	162	68.86	30.24
5	2483.50	62.6 PK	74.0	-11.4	1.30 V	163	32.17	30.43
6	2483.50	49.3 AV	54.0	-4.7	1.30 V	163	18.87	30.43
7	4874.00	55.3 PK	74.0	-18.7	1.32 V	277	19.78	35.52
8	4874.00	43.6 AV	54.0	-10.4	1.32 V	277	8.08	35.52
9	7311.00	57.6 PK	74.0	-16.4	1.00 V	312	15.64	41.96
10	7311.00	47.2 AV	54.0	-6.8	1.00 V	312	5.24	41.96

- REMARKS:**
1. Emission level (dBuV/m) = Raw Value (dBuV) + Correction Factor (dB/m).
 2. Correction Factor (dB/m) = Antenna Factor (dB/m) + Cable Factor (dB).
 3. The other emission levels were very low against the limit.
 4. Margin value = Emission level – Limit value.
 5. “ * “: Fundamental frequency.



A D T

EUT TEST CONDITION		MEASUREMENT DETAIL	
CHANNEL	Channel 11	FREQUENCY RANGE	1 ~ 25GHz
INPUT POWER	120Vac, 60 Hz	DETECTOR FUNCTION	Peak (PK) Average (AV)
ENVIRONMENTAL CONDITIONS	14deg. C, 70%RH 1025 hPa	TESTED BY	Frank Liu

ANTENNA POLARITY & TEST DISTANCE: HORIZONTAL AT 3 M

NO.	FREQ. (MHz)	EMISSION LEVEL (dBuV/m)	LIMIT (dBuV/m)	MARGIN (dB)	ANTENNA HEIGHT (m)	TABLE ANGLE (Degree)	RAW VALUE (dBuV)	CORRECTION FACTOR (dB/m)
1	*2462.00	100.6 PK			1.56 H	136	70.26	30.34
2	*2462.00	91.6 AV			1.56 H	136	61.26	30.34
3	2483.50	64.0 PK	74.0	-10.0	1.51 H	228	33.58	30.43
4	2483.50	45.1 AV	54.0	-8.9	1.51 H	228	14.63	30.43
5	4924.00	47.1 PK	74.0	-26.9	1.35 H	225	11.48	35.62
6	4924.00	36.6 AV	54.0	-17.4	1.35 H	225	0.98	35.62
7	7386.00	50.0 PK	74.0	-24.0	1.43 H	213	7.90	42.10
8	7386.00	38.7 AV	54.0	-15.3	1.43 H	213	-3.40	42.10

ANTENNA POLARITY & TEST DISTANCE: VERTICAL AT 3 M

NO.	FREQ. (MHz)	EMISSION LEVEL (dBuV/m)	LIMIT (dBuV/m)	MARGIN (dB)	ANTENNA HEIGHT (m)	TABLE ANGLE (Degree)	RAW VALUE (dBuV)	CORRECTION FACTOR (dB/m)
1	*2462.00	104.7 PK			1.06 V	160	74.36	30.34
2	*2462.00	96.3 AV			1.06 V	160	65.96	30.34
3	2483.50	67.7 PK	74.0	-6.3	1.04 V	249	37.29	30.43
4	2483.50	52.6 AV	54.0	-1.5	1.04 V	249	22.12	30.43
5	4924.00	43.1 PK	74.0	-30.9	1.46 V	231	7.48	35.62
6	4924.00	31.9 AV	54.0	-22.2	1.46 V	231	-3.77	35.62
7	7386.00	49.8 PK	74.0	-24.2	1.28 V	224	7.70	42.10
8	7386.00	37.6 AV	54.0	-16.4	1.28 V	224	-4.50	42.10

- REMARKS:**
1. Emission level (dBuV/m) = Raw Value (dBuV) + Correction Factor (dB/m).
 2. Correction Factor (dB/m) = Antenna Factor (dB/m) + Cable Factor (dB).
 3. The other emission levels were very low against the limit.
 4. Margin value = Emission level – Limit value.
 5. “ * “: Fundamental frequency.



A D T

RESTRICTED BANDEDGE (802.11g MODE, CH1, HORIZONTAL)

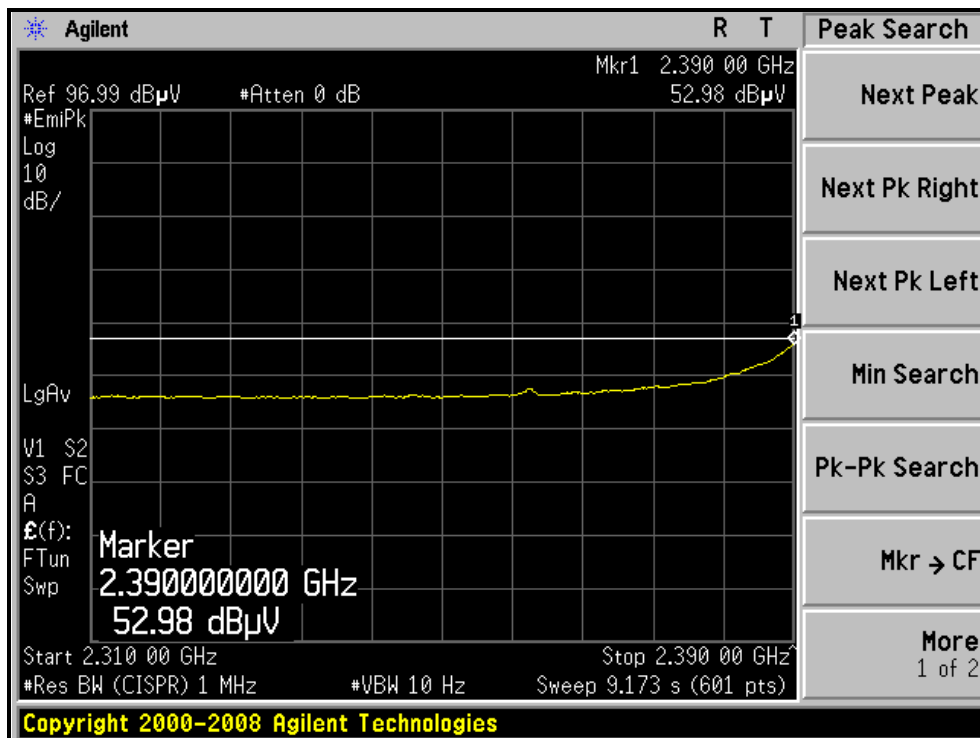
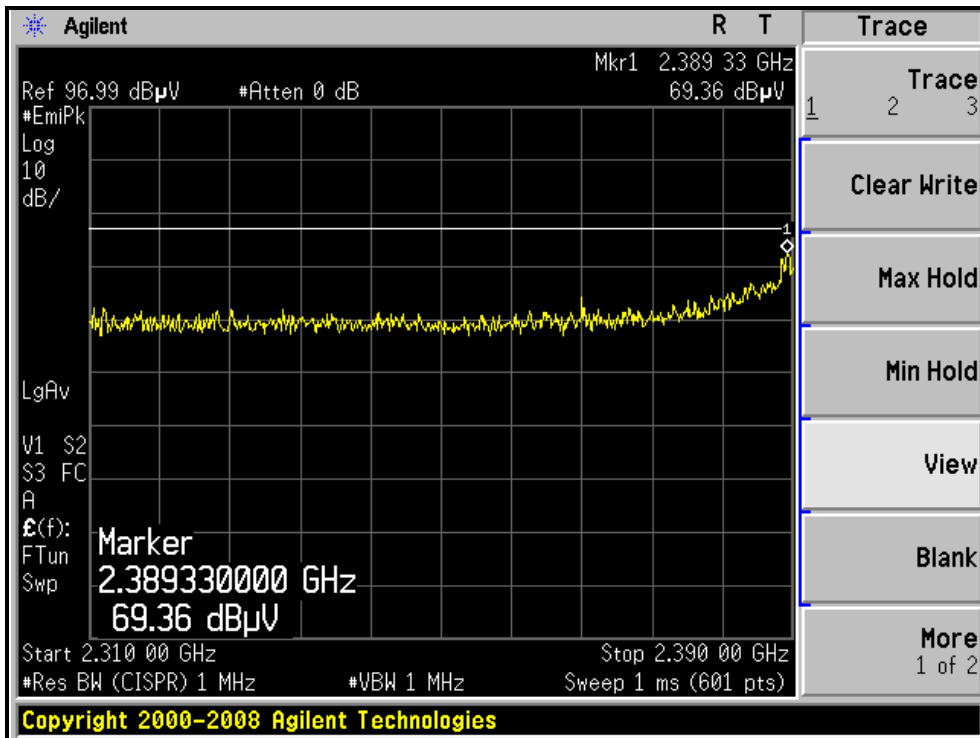



A D T

RESTRICTED BANDEDGE (802.11g MODE, CH1, VERTICAL)

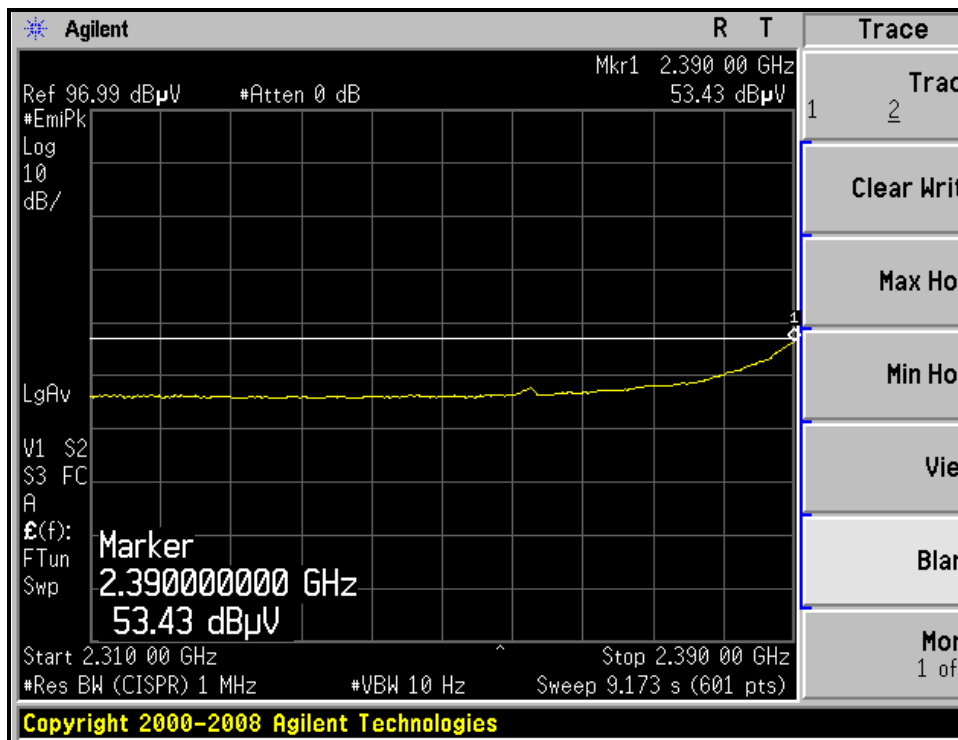
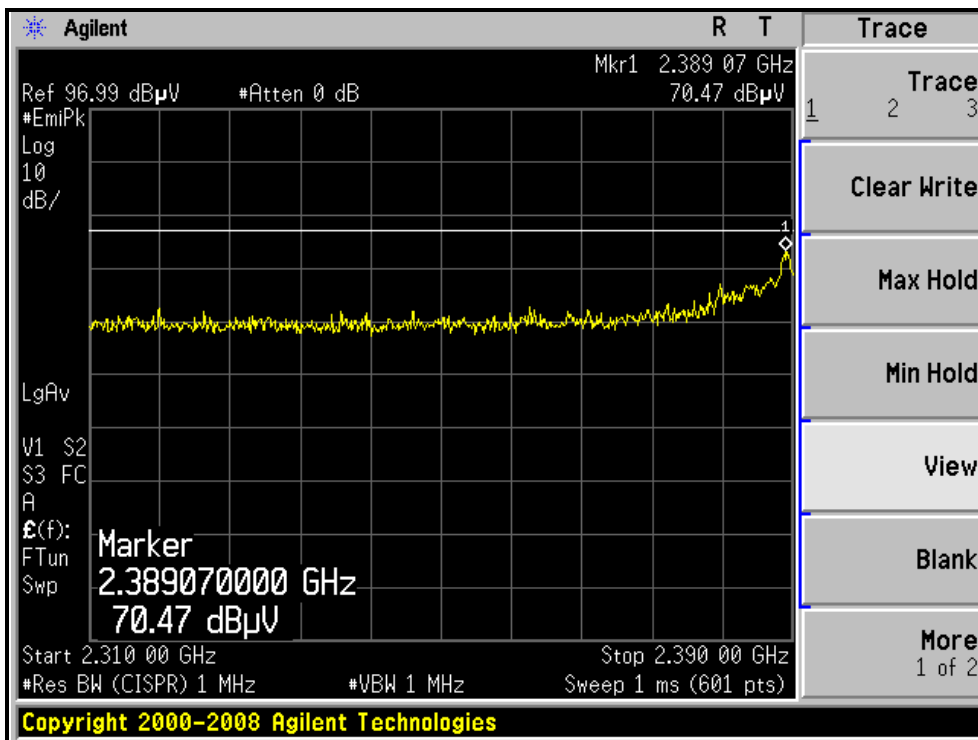



A D T

RESTRICTED BANDEDGE (802.11g MODE, CH11, HORIZONTAL)

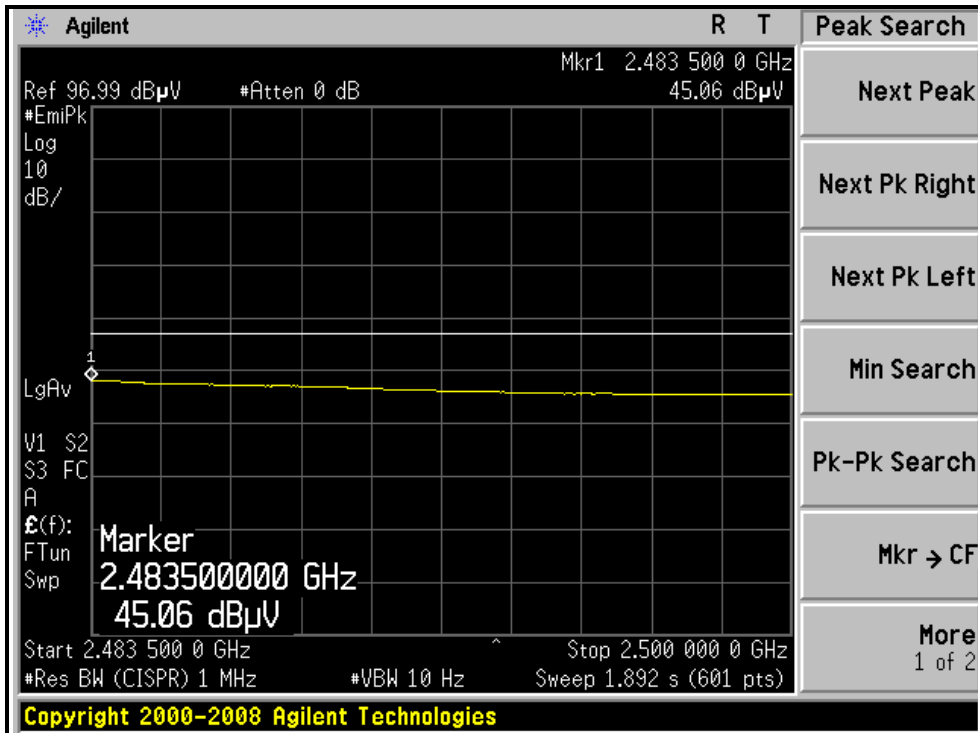
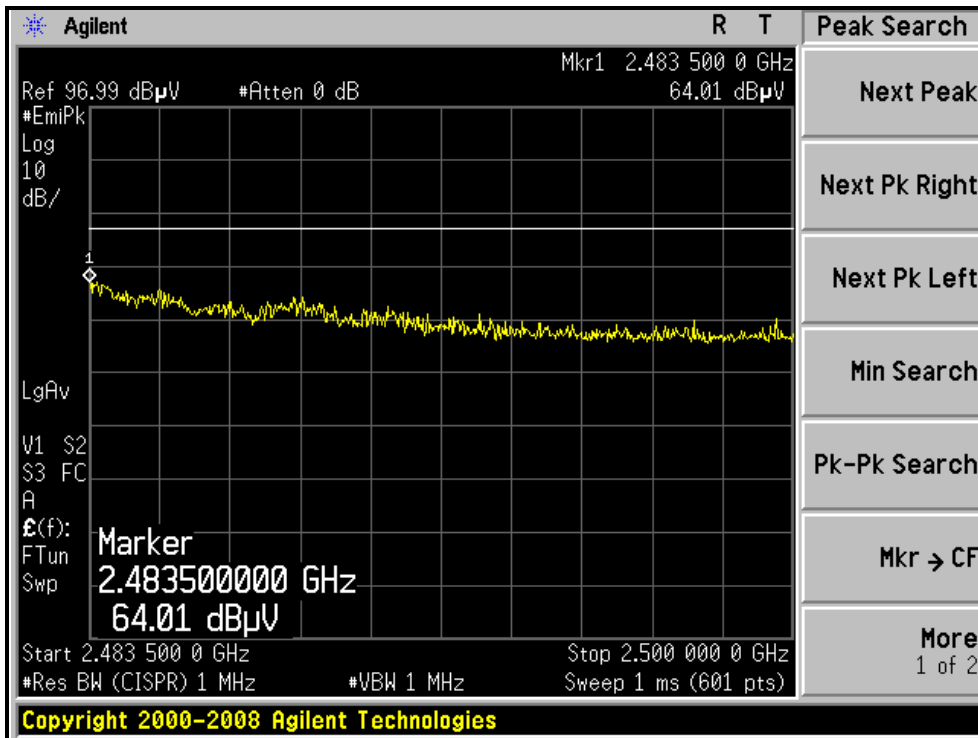



A D T

RESTRICTED BANDEDGE (802.11g MODE, CH11, VERTICAL)

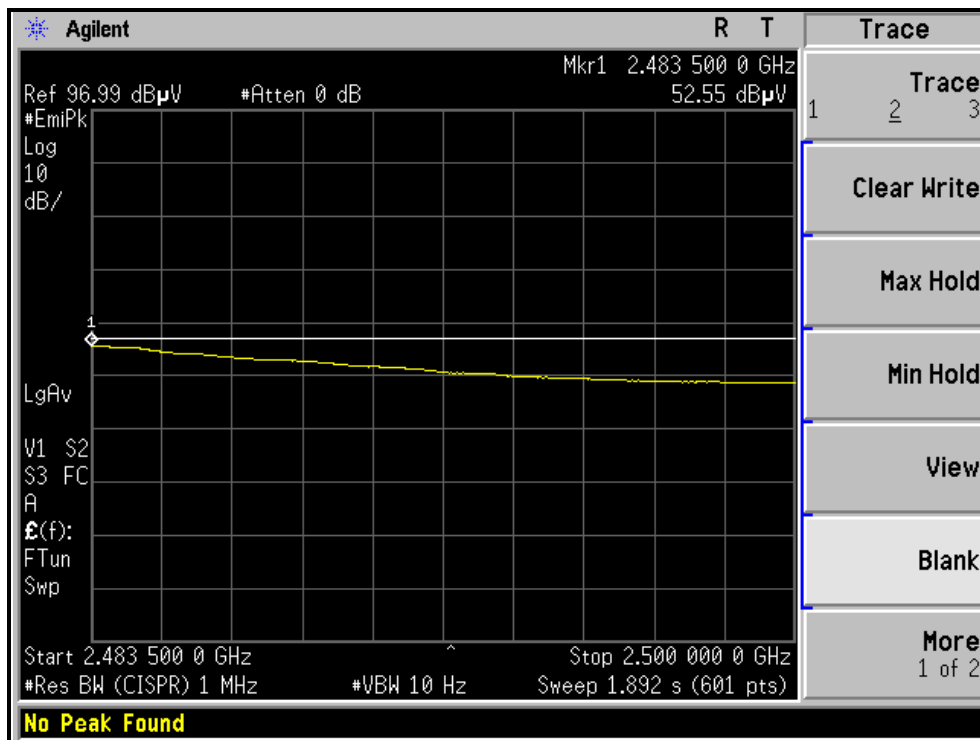
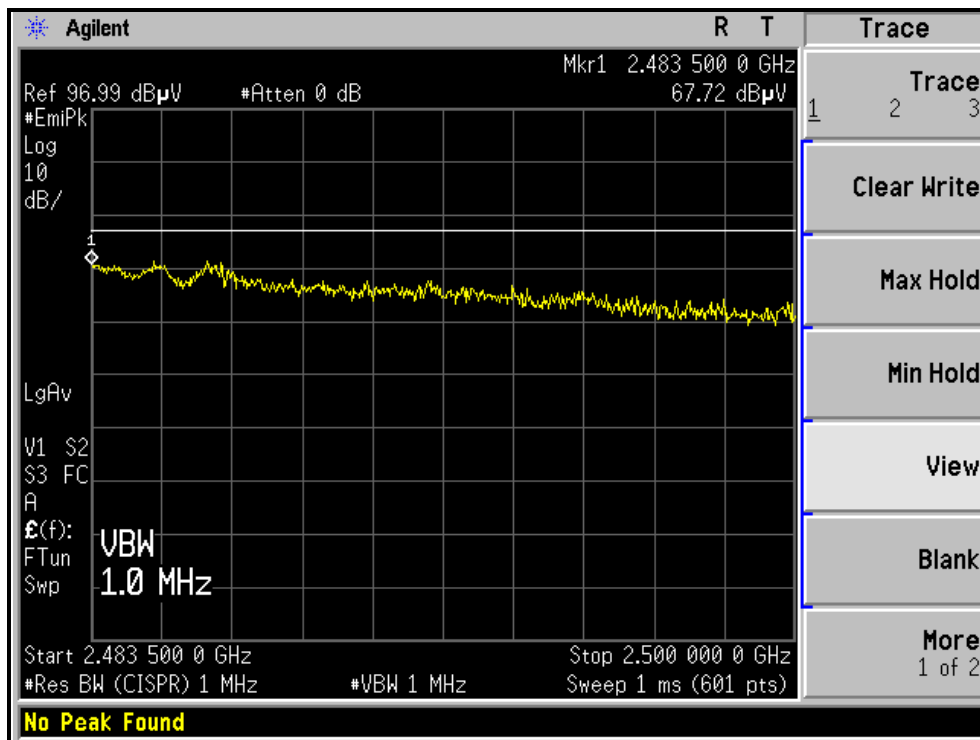



A D T

DRAFT 802.11n (20MHz) OFDM MODULATION

EUT TEST CONDITION		MEASUREMENT DETAIL	
CHANNEL	Channel 1	FREQUENCY RANGE	1 ~ 25GHz
INPUT POWER	120Vac, 60 Hz	DETECTOR FUNCTION	Peak (PK) Average (AV)
ENVIRONMENTAL CONDITIONS	14deg. C, 70%RH 1025 hPa	TESTED BY	Frank Liu

ANTENNA POLARITY & TEST DISTANCE: HORIZONTAL AT 3 M								
NO.	FREQ. (MHz)	EMISSION LEVEL (dBuV/m)	LIMIT (dBuV/m)	MARGIN (dB)	ANTENNA HEIGHT (m)	TABLE ANGLE (Degree)	RAW VALUE (dBuV)	CORRECTION FACTOR (dB/m)
1	2390.00	66.1 PK	74.0	-7.9	1.52 H	221	36.04	30.06
2	2390.00	48.7 AV	54.0	-5.3	1.52 H	221	18.61	30.06
3	*2412.00	101.2 PK			1.97 H	222	71.05	30.15
4	*2412.00	91.7 AV			1.97 H	222	61.55	30.15
5	4824.00	48.1 PK	74.0	-25.9	1.34 H	231	12.67	35.43
6	4824.00	36.4 AV	54.0	-17.6	1.34 H	231	0.97	35.43
ANTENNA POLARITY & TEST DISTANCE: VERTICAL AT 3 M								
NO.	FREQ. (MHz)	EMISSION LEVEL (dBuV/m)	LIMIT (dBuV/m)	MARGIN (dB)	ANTENNA HEIGHT (m)	TABLE ANGLE (Degree)	RAW VALUE (dBuV)	CORRECTION FACTOR (dB/m)
1	2390.00	71.0 PK	74.0	-3.0	1.10 V	164	40.97	30.06
2	2390.00	53.4 AV	54.0	-0.6	1.10 V	164	23.33	30.06
3	*2412.00	104.2 PK			1.10 V	167	74.05	30.15
4	*2412.00	95.3 AV			1.10 V	167	65.15	30.15
5	4824.00	44.6 PK	74.0	-29.4	1.32 V	243	9.17	35.43
6	4824.00	33.1 AV	54.0	-20.9	1.32 V	243	-2.33	35.43

- REMARKS:**
1. Emission level (dBuV/m) = Raw Value (dBuV) + Correction Factor (dB/m).
 2. Correction Factor (dB/m) = Antenna Factor (dB/m) + Cable Factor (dB).
 3. The other emission levels were very low against the limit.
 4. Margin value = Emission level – Limit value.
 5. “ * “: Fundamental frequency.



A D T

EUT TEST CONDITION		MEASUREMENT DETAIL	
CHANNEL	Channel 6	FREQUENCY RANGE	1 ~ 25GHz
INPUT POWER	120Vac, 60 Hz	DETECTOR FUNCTION	Peak (PK) Average (AV)
ENVIRONMENTAL CONDITIONS	14deg. C, 70%RH 1025 hPa	TESTED BY	Frank Liu

ANTENNA POLARITY & TEST DISTANCE: HORIZONTAL AT 3 M

NO.	FREQ. (MHz)	EMISSION LEVEL (dBuV/m)	LIMIT (dBuV/m)	MARGIN (dB)	ANTENNA HEIGHT (m)	TABLE ANGLE (Degree)	RAW VALUE (dBuV)	CORRECTION FACTOR (dB/m)
1	2385.33	56.5 PK	74.0	-17.5	1.50 H	22	26.46	30.04
2	2385.33	43.7 AV	54.0	-10.3	1.50 H	22	13.70	30.04
3	*2437.00	104.4 PK			1.52 H	219	74.16	30.24
4	*2437.00	95.3 AV			1.52 H	219	65.06	30.24
5	2488.95	57.6 PK	74.0	-16.4	1.51 H	218	27.15	30.45
6	2488.95	44.7 AV	54.0	-9.3	1.51 H	218	14.24	30.45
7	4874.00	58.1 PK	74.0	-15.9	1.42 H	237	22.58	35.52
8	4874.00	45.2 AV	54.0	-8.8	1.42 H	237	9.68	35.52
9	7311.00	64.3 PK	74.0	-9.7	1.37 H	206	22.34	41.96
10	7311.00	52.6 AV	54.0	-1.4	1.37 H	206	10.64	41.96

ANTENNA POLARITY & TEST DISTANCE: VERTICAL AT 3 M

NO.	FREQ. (MHz)	EMISSION LEVEL (dBuV/m)	LIMIT (dBuV/m)	MARGIN (dB)	ANTENNA HEIGHT (m)	TABLE ANGLE (Degree)	RAW VALUE (dBuV)	CORRECTION FACTOR (dB/m)
1	2390.00	62.3 PK	74.0	-11.7	1.29 V	157	32.24	30.06
2	2390.00	48.5 AV	54.0	-5.5	1.29 V	157	18.44	30.06
3	*2437.00	107.3 PK			1.04 V	161	77.06	30.24
4	*2437.00	99.4 AV			1.04 V	161	69.16	30.24
5	2483.50	62.9 PK	74.0	-11.1	1.27 V	166	32.47	30.43
6	2483.50	49.4 AV	54.0	-4.6	1.27 V	166	18.97	30.43
7	4874.00	55.7 PK	74.0	-18.3	1.31 V	279	20.18	35.52
8	4874.00	43.2 AV	54.0	-10.8	1.31 V	279	7.68	35.52
9	7311.00	57.9 PK	74.0	-16.1	1.00 V	320	15.94	41.96
10	7311.00	47.4 AV	54.0	-6.6	1.00 V	320	5.44	41.96

- REMARKS:**
1. Emission level (dBuV/m) = Raw Value (dBuV) + Correction Factor (dB/m).
 2. Correction Factor (dB/m) = Antenna Factor (dB/m) + Cable Factor (dB).
 3. The other emission levels were very low against the limit.
 4. Margin value = Emission level – Limit value.
 5. “ * “: Fundamental frequency.



A D T

EUT TEST CONDITION		MEASUREMENT DETAIL	
CHANNEL	Channel 11	FREQUENCY RANGE	1 ~ 25GHz
INPUT POWER	120Vac, 60 Hz	DETECTOR FUNCTION	Peak (PK) Average (AV)
ENVIRONMENTAL CONDITIONS	14deg. C, 70%RH 1025 hPa	TESTED BY	Frank Liu

ANTENNA POLARITY & TEST DISTANCE: HORIZONTAL AT 3 M								
NO.	FREQ. (MHz)	EMISSION LEVEL (dBuV/m)	LIMIT (dBuV/m)	MARGIN (dB)	ANTENNA HEIGHT (m)	TABLE ANGLE (Degree)	RAW VALUE (dBuV)	CORRECTION FACTOR (dB/m)
1	*2462.00	100.7 PK			1.51 H	232	70.36	30.34
2	*2462.00	91.3 AV			1.51 H	232	60.99	30.34
3	2483.50	67.1 PK	74.0	-6.9	1.50 H	217	36.70	30.43
4	2483.50	44.9 AV	54.0	-9.1	1.50 H	217	14.46	30.43
5	4924.00	47.2 PK	74.0	-26.8	1.34 H	326	11.58	35.62
6	4924.00	36.4 AV	54.0	-17.6	1.34 H	326	0.78	35.62
7	7386.00	50.6 PK	74.0	-23.4	1.42 H	219	8.50	42.10
8	7386.00	38.9 AV	54.0	-15.1	1.42 H	219	-3.20	42.10
ANTENNA POLARITY & TEST DISTANCE: VERTICAL AT 3 M								
NO.	FREQ. (MHz)	EMISSION LEVEL (dBuV/m)	LIMIT (dBuV/m)	MARGIN (dB)	ANTENNA HEIGHT (m)	TABLE ANGLE (Degree)	RAW VALUE (dBuV)	CORRECTION FACTOR (dB/m)
1	*2462.00	105.3 PK			1.05 V	163	74.96	30.34
2	*2462.00	95.6 AV			1.05 V	163	65.26	30.34
3	2483.50	69.9 PK	74.0	-4.2	1.03 V	249	39.42	30.43
4	2483.50	52.0 AV	54.0	-2.0	1.03 V	249	21.61	30.43
5	4924.00	47.3 PK	74.0	-26.7	1.44 V	360	11.68	35.62
6	4924.00	36.2 AV	54.0	-17.8	1.44 V	360	0.58	35.62
7	7386.00	50.8 PK	74.0	-23.2	1.20 V	221	8.70	42.10
8	7386.00	38.7 AV	54.0	-15.3	1.20 V	221	-3.40	42.10

- REMARKS:**
1. Emission level (dBuV/m) = Raw Value (dBuV) + Correction Factor (dB/m).
 2. Correction Factor (dB/m) = Antenna Factor (dB/m) + Cable Factor (dB).
 3. The other emission levels were very low against the limit.
 4. Margin value = Emission level – Limit value.
 5. “ * “: Fundamental frequency.



A D T

RESTRICTED BANDEDGE (802.11n (20MHz) MODE,CH1, HORIZONTAL)

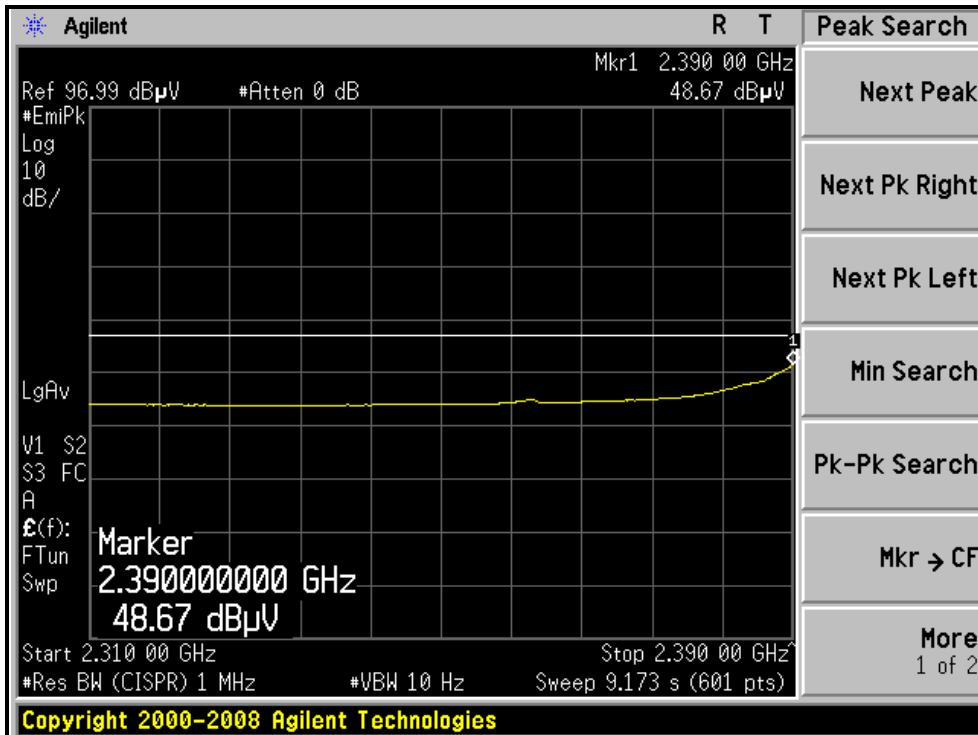
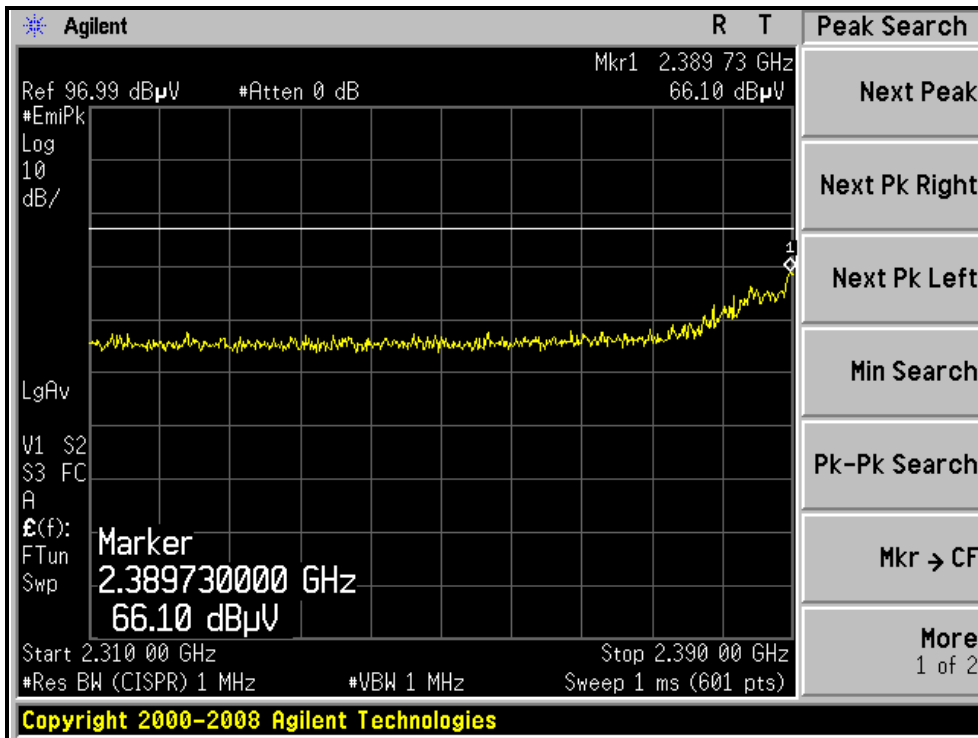



A D T

RESTRICTED BANDEDGE (802.11n (20MHz) MODE,CH1, VERTICAL)

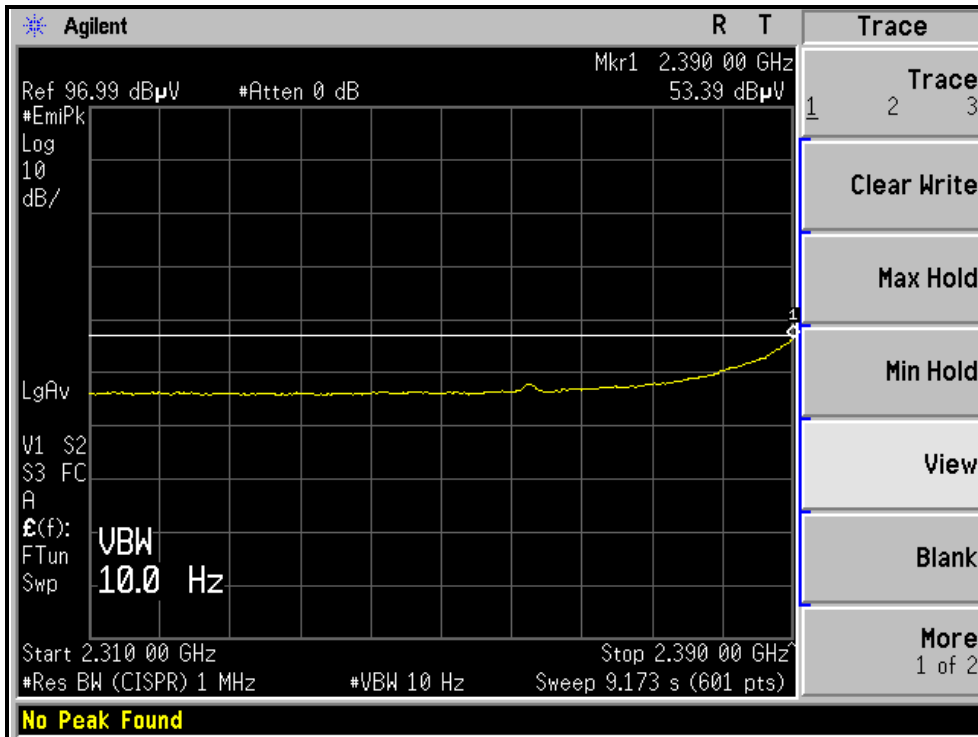
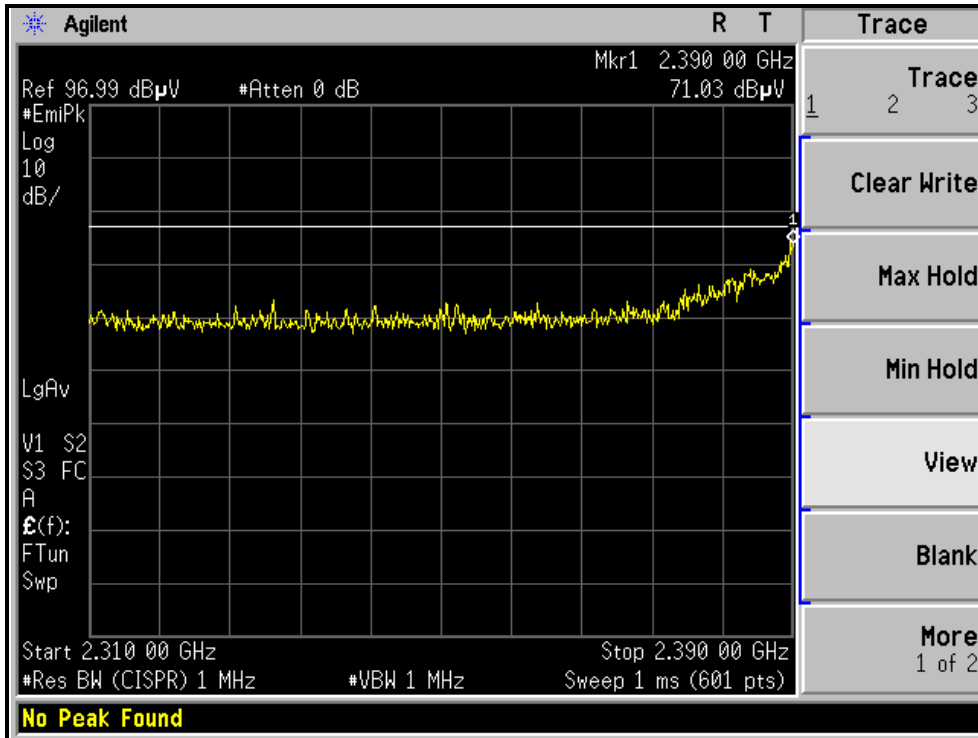



A D T

RESTRICTED BANDEDGE (802.11n (20MHz) MODE,CH11, HORIZONTAL)

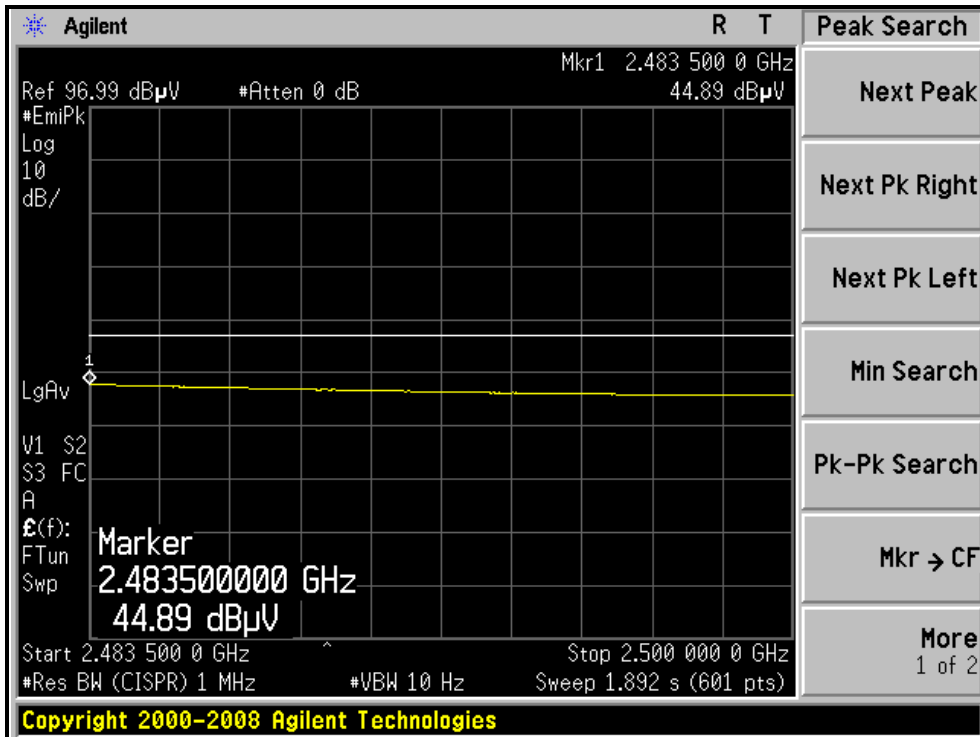
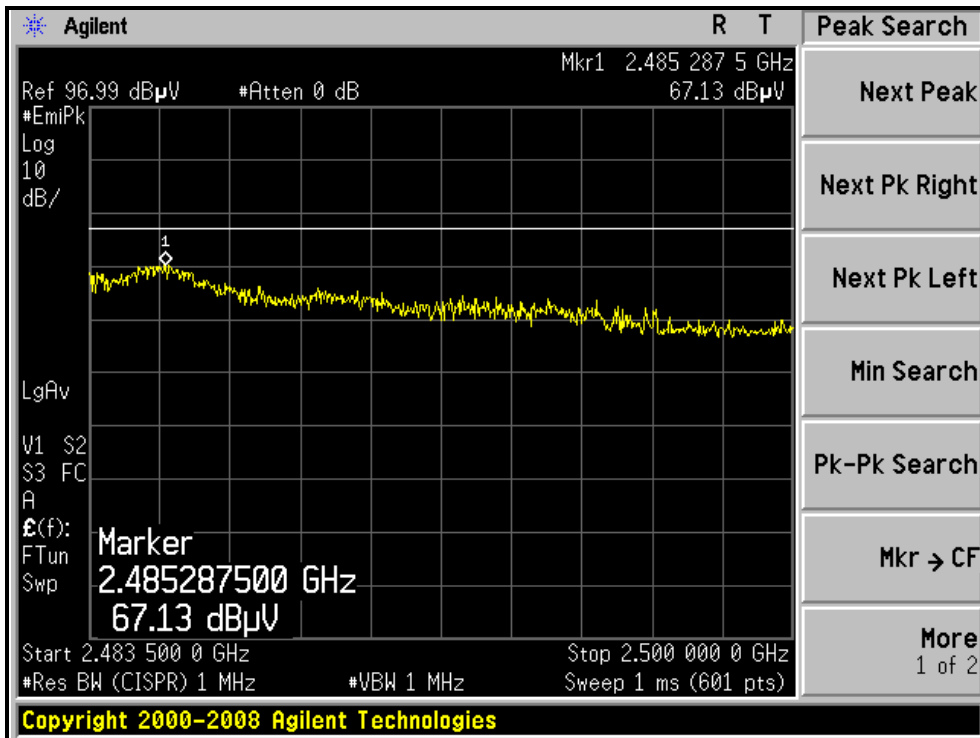



A D T

RESTRICTED BANDEDGE (802.11n (20MHz) MODE,CH11, VERTICAL)

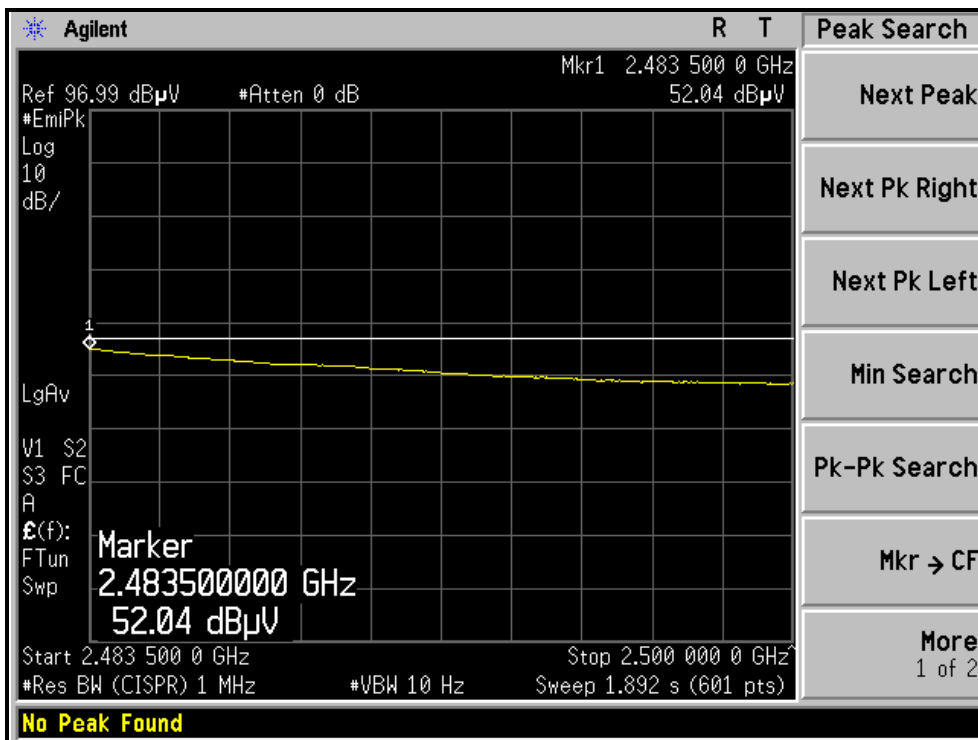
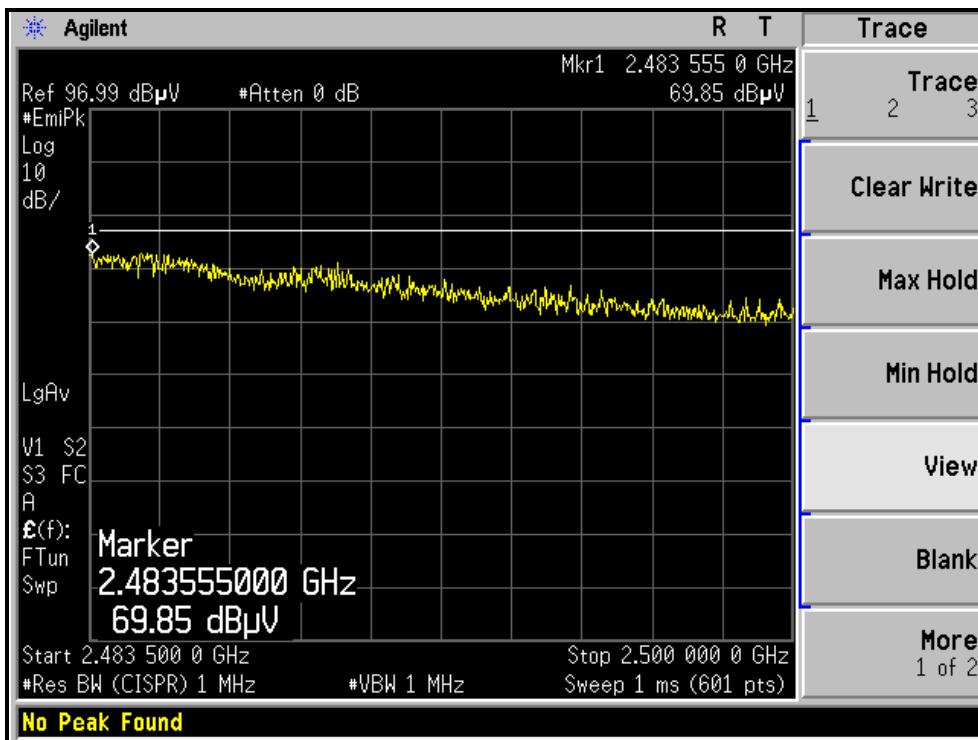



A D T

DRAFT 802.11n (40MHz) OFDM MODULATION

EUT TEST CONDITION		MEASUREMENT DETAIL	
CHANNEL	Channel 1	FREQUENCY RANGE	1 ~ 25GHz
INPUT POWER	120Vac, 60 Hz	DETECTOR FUNCTION	Peak (PK) Average (AV)
ENVIRONMENTAL CONDITIONS	14deg. C, 70%RH 1025 hPa	TESTED BY	Frank Liu

ANTENNA POLARITY & TEST DISTANCE: HORIZONTAL AT 3 M

NO.	FREQ. (MHz)	EMISSION LEVEL (dBuV/m)	LIMIT (dBuV/m)	MARGIN (dB)	ANTENNA HEIGHT (m)	TABLE ANGLE (Degree)	RAW VALUE (dBuV)	CORRECTION FACTOR (dB/m)
1	2390.00	68.0 PK	74.0	-6.0	1.52 H	222	37.98	30.06
2	2390.00	51.4 AV	54.0	-2.6	1.52 H	222	21.36	30.06
3	*2422.00	98.0 PK			1.52 H	218	67.81	30.19
4	*2422.00	89.0 AV			1.52 H	218	58.81	30.19
5	4844.00	44.9 PK	74.0	-29.1	1.32 H	219	9.43	35.47
6	4844.00	33.7 AV	54.0	-20.3	1.32 H	219	-1.77	35.47
7	7266.00	50.3 PK	74.0	-23.7	1.43 H	214	8.43	41.87
8	7266.00	38.4 AV	54.0	-15.6	1.43 H	214	-3.47	41.87

ANTENNA POLARITY & TEST DISTANCE: VERTICAL AT 3 M

NO.	FREQ. (MHz)	EMISSION LEVEL (dBuV/m)	LIMIT (dBuV/m)	MARGIN (dB)	ANTENNA HEIGHT (m)	TABLE ANGLE (Degree)	RAW VALUE (dBuV)	CORRECTION FACTOR (dB/m)
1	2390.00	70.9 PK	74.0	-3.1	1.06 V	214	40.88	30.06
2	2390.00	53.4 AV	54.0	-0.6	1.06 V	214	23.33	30.06
3	*2422.00	99.7 PK			1.06 V	195	69.51	30.19
4	*2422.00	90.8 AV			1.06 V	195	60.56	30.19
5	4844.00	44.3 PK	74.0	-29.7	1.42 V	203	8.83	35.47
6	4844.00	33.2 AV	54.0	-20.8	1.42 V	203	-2.27	35.47
7	7266.00	50.8 PK	74.0	-23.2	1.22 V	255	8.93	41.87
8	7266.00	38.9 AV	54.0	-15.1	1.22 V	255	-2.97	41.87

- REMARKS:**
1. Emission level (dBuV/m) = Raw Value (dBuV) + Correction Factor (dB/m).
 2. Correction Factor (dB/m) = Antenna Factor (dB/m) + Cable Factor (dB).
 3. The other emission levels were very low against the limit.
 4. Margin value = Emission level – Limit value.
 5. “ * “: Fundamental frequency.



A D T

EUT TEST CONDITION		MEASUREMENT DETAIL	
CHANNEL	Channel 4	FREQUENCY RANGE	1 ~ 25GHz
INPUT POWER	120Vac, 60 Hz	DETECTOR FUNCTION	Peak (PK) Average (AV)
ENVIRONMENTAL CONDITIONS	14deg. C, 70%RH 1025 hPa	TESTED BY	Frank Liu

ANTENNA POLARITY & TEST DISTANCE: HORIZONTAL AT 3 M								
NO.	FREQ. (MHz)	EMISSION LEVEL (dBuV/m)	LIMIT (dBuV/m)	MARGIN (dB)	ANTENNA HEIGHT (m)	TABLE ANGLE (Degree)	RAW VALUE (dBuV)	CORRECTION FACTOR (dB/m)
1	2390.00	60.8 PK	74.0	-13.2	1.53 H	222	30.70	30.06
2	2390.00	48.1 AV	54.0	-5.9	1.53 H	222	18.04	30.06
3	*2437.00	100.3 PK			1.52 H	221	70.06	30.24
4	*2437.00	90.7 AV			1.52 H	221	60.46	30.24
5	2483.50	63.5 PK	74.0	-10.5	1.51 H	221	33.08	30.43
6	2483.50	47.6 AV	54.0	-6.5	1.51 H	221	17.12	30.43
7	4874.00	46.3 PK	74.0	-27.7	1.34 H	211	10.78	35.52
8	4874.00	35.2 AV	54.0	-18.8	1.34 H	211	-0.32	35.52
9	7311.00	52.3 PK	74.0	-21.7	1.44 H	219	10.34	41.96
10	7311.00	40.2 AV	54.0	-13.8	1.44 H	219	-1.76	41.96
ANTENNA POLARITY & TEST DISTANCE: VERTICAL AT 3 M								
NO.	FREQ. (MHz)	EMISSION LEVEL (dBuV/m)	LIMIT (dBuV/m)	MARGIN (dB)	ANTENNA HEIGHT (m)	TABLE ANGLE (Degree)	RAW VALUE (dBuV)	CORRECTION FACTOR (dB/m)
1	2390.00	65.6 PK	74.0	-8.4	1.11 V	163	35.54	30.06
2	2390.00	53.4 AV	54.0	-0.6	1.11 V	163	23.34	30.06
3	*2437.00	101.5 PK			1.04 V	162	71.26	30.24
4	*2437.00	93.1 AV			1.04 V	162	62.86	30.24
5	2483.50	71.2 PK	74.0	-2.8	1.04 V	241	40.77	30.43
6	2483.50	53.3 AV	54.0	-0.7	1.04 V	241	22.87	30.43
7	4874.00	44.7 PK	74.0	-29.3	1.40 V	215	9.18	35.52
8	4874.00	33.4 AV	54.0	-20.6	1.40 V	215	-2.12	35.52
9	7311.00	50.6 PK	74.0	-23.4	1.26 V	208	8.64	41.96
10	7311.00	38.7 AV	54.0	-15.3	1.26 V	208	-3.26	41.96

- REMARKS:**
1. Emission level (dBuV/m) = Raw Value (dBuV) + Correction Factor (dB/m).
 2. Correction Factor (dB/m) = Antenna Factor (dB/m) + Cable Factor (dB).
 3. The other emission levels were very low against the limit.
 4. Margin value = Emission level – Limit value.
 5. “ * “: Fundamental frequency.



A D T

EUT TEST CONDITION		MEASUREMENT DETAIL	
CHANNEL	Channel 7	FREQUENCY RANGE	1 ~ 25GHz
INPUT POWER	120Vac, 60 Hz	DETECTOR FUNCTION	Peak (PK) Average (AV)
ENVIRONMENTAL CONDITIONS	14deg. C, 70%RH 1025 hPa	TESTED BY	Frank Liu

ANTENNA POLARITY & TEST DISTANCE: HORIZONTAL AT 3 M

NO.	FREQ. (MHz)	EMISSION LEVEL (dBuV/m)	LIMIT (dBuV/m)	MARGIN (dB)	ANTENNA HEIGHT (m)	TABLE ANGLE (Degree)	RAW VALUE (dBuV)	CORRECTION FACTOR (dB/m)
1	*2452.00	98.7 PK			1.50 H	218	68.40	30.30
2	*2452.00	89.1 AV			1.50 H	218	58.82	30.30
3	2483.80	64.7 PK	74.0	-9.3	1.52 H	138	34.25	30.43
4	2483.80	45.5 AV	54.0	-8.5	1.52 H	138	15.03	30.43
5	4904.00	44.3 PK	74.0	-29.7	1.31 H	218	8.72	35.58
6	4904.00	33.4 AV	54.0	-20.6	1.31 H	218	-2.18	35.58
7	7356.00	50.1 PK	74.0	-23.9	1.41 H	203	8.06	42.04
8	7356.00	38.2 AV	54.0	-15.8	1.41 H	203	-3.84	42.04

ANTENNA POLARITY & TEST DISTANCE: VERTICAL AT 3 M

NO.	FREQ. (MHz)	EMISSION LEVEL (dBuV/m)	LIMIT (dBuV/m)	MARGIN (dB)	ANTENNA HEIGHT (m)	TABLE ANGLE (Degree)	RAW VALUE (dBuV)	CORRECTION FACTOR (dB/m)
1	*2452.00	101.0 PK			1.03 V	182	70.70	30.30
2	*2452.00	92.1 AV			1.03 V	182	61.80	30.30
3	2483.50	71.4 PK	74.0	-2.6	1.03 V	249	40.93	30.43
4	2483.50	52.9 AV	54.0	-1.2	1.03 V	249	22.42	30.43
5	4904.00	44.6 PK	74.0	-29.4	1.41 V	231	9.02	35.58
6	4904.00	33.1 AV	54.0	-20.9	1.41 V	231	-2.48	35.58
7	7356.00	50.3 PK	74.0	-23.7	1.24 V	218	8.26	42.04
8	7356.00	38.4 AV	54.0	-15.6	1.24 V	218	-3.64	42.04

- REMARKS:**
1. Emission level (dBuV/m) = Raw Value (dBuV) + Correction Factor (dB/m).
 2. Correction Factor (dB/m) = Antenna Factor (dB/m) + Cable Factor (dB).
 3. The other emission levels were very low against the limit.
 4. Margin value = Emission level – Limit value.
 5. “ * “: Fundamental frequency.



A D T

RESTRICTED BANDEDGE (802.11n (40MHz) MODE,CH1, HORIZONTAL)

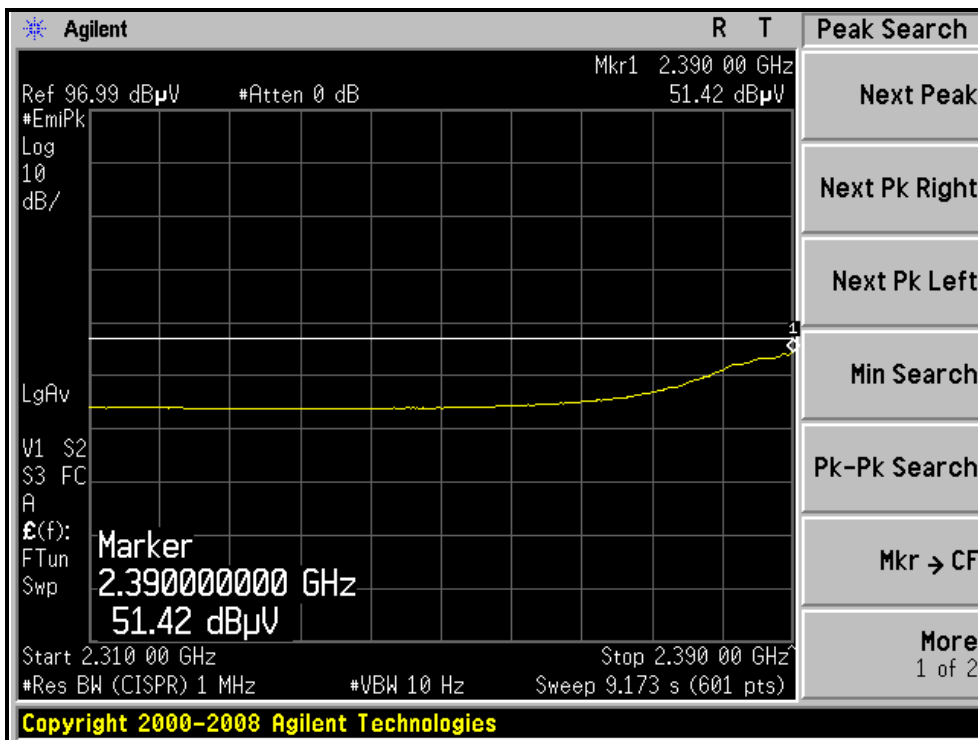
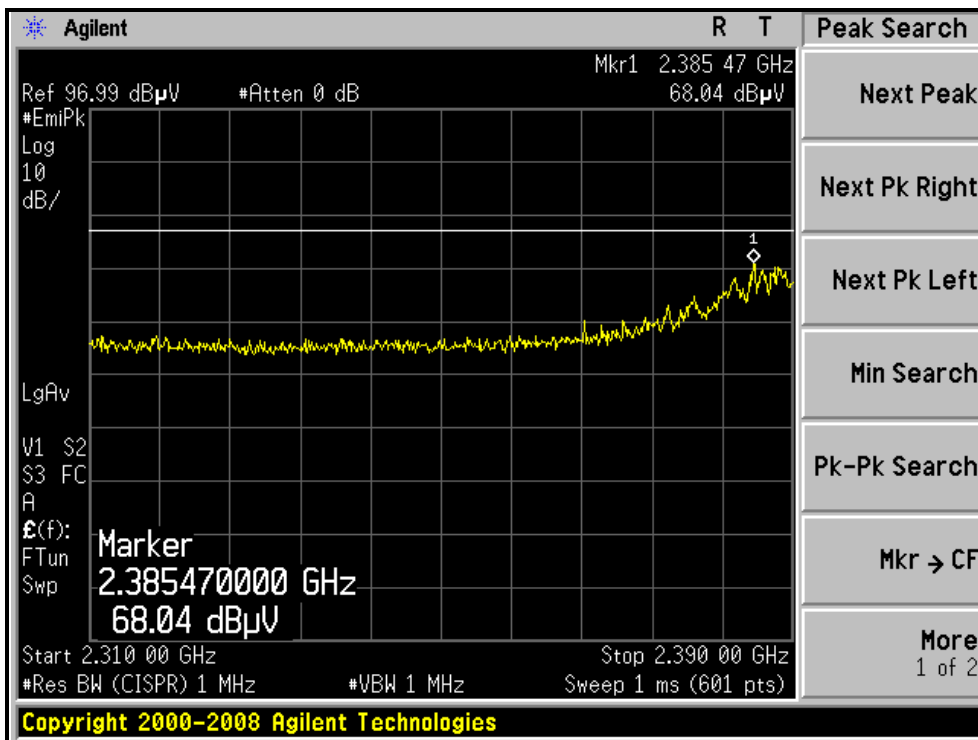



A D T

RESTRICTED BANDEDGE (802.11n (40MHz) MODE,CH1, VERTICAL)

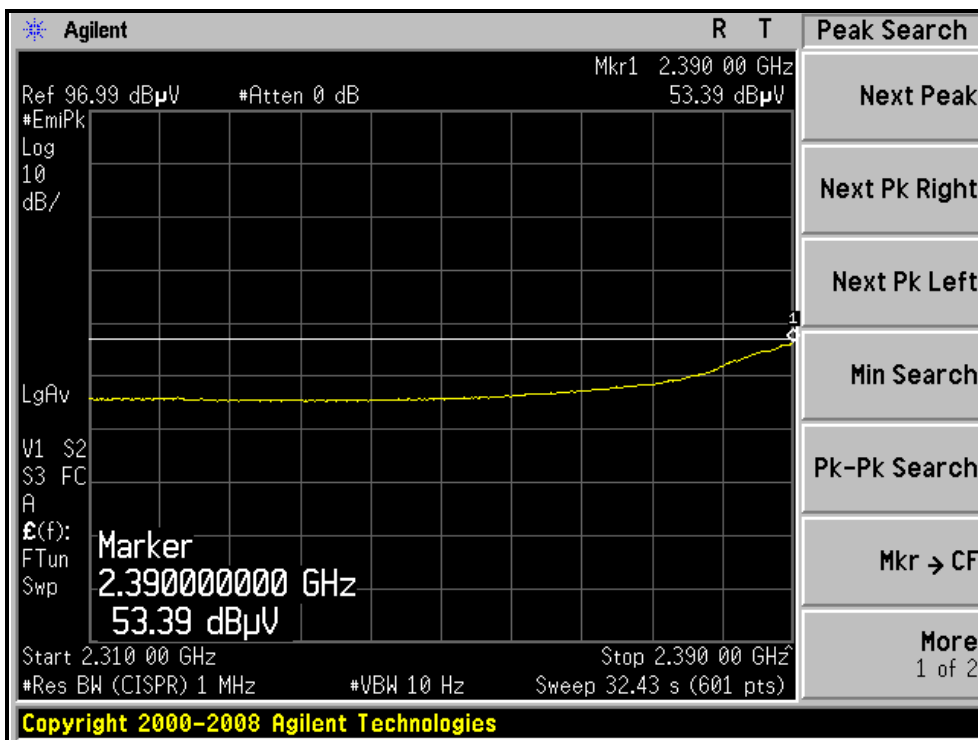
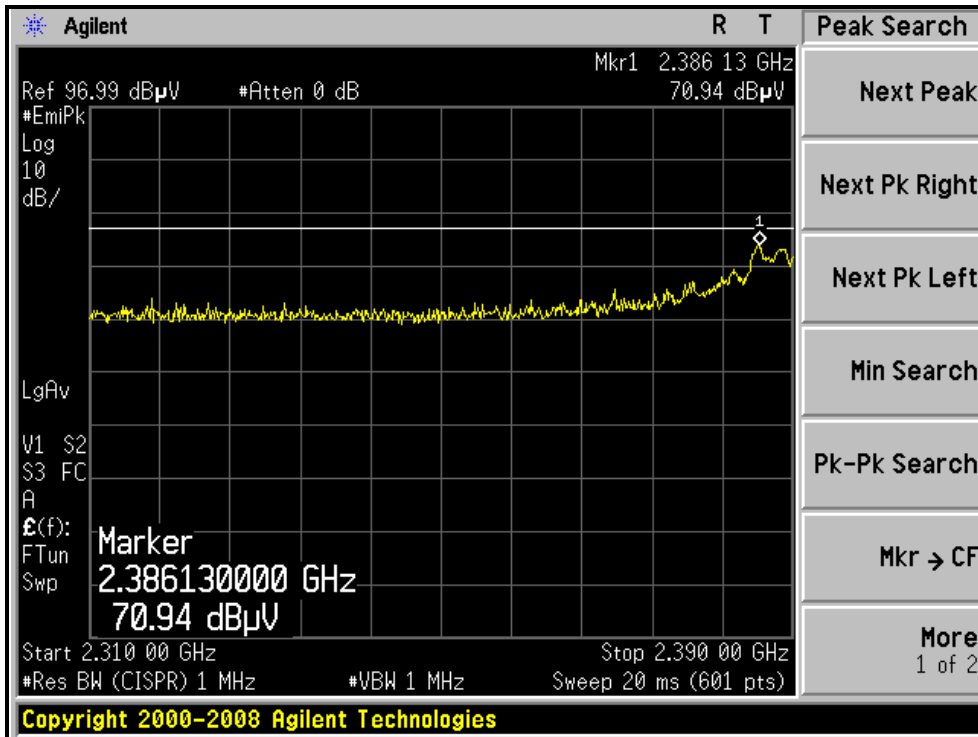



A D T

RESTRICTED BANDEDGE (802.11n (40MHz) MODE,CH7, HORIZONTAL)

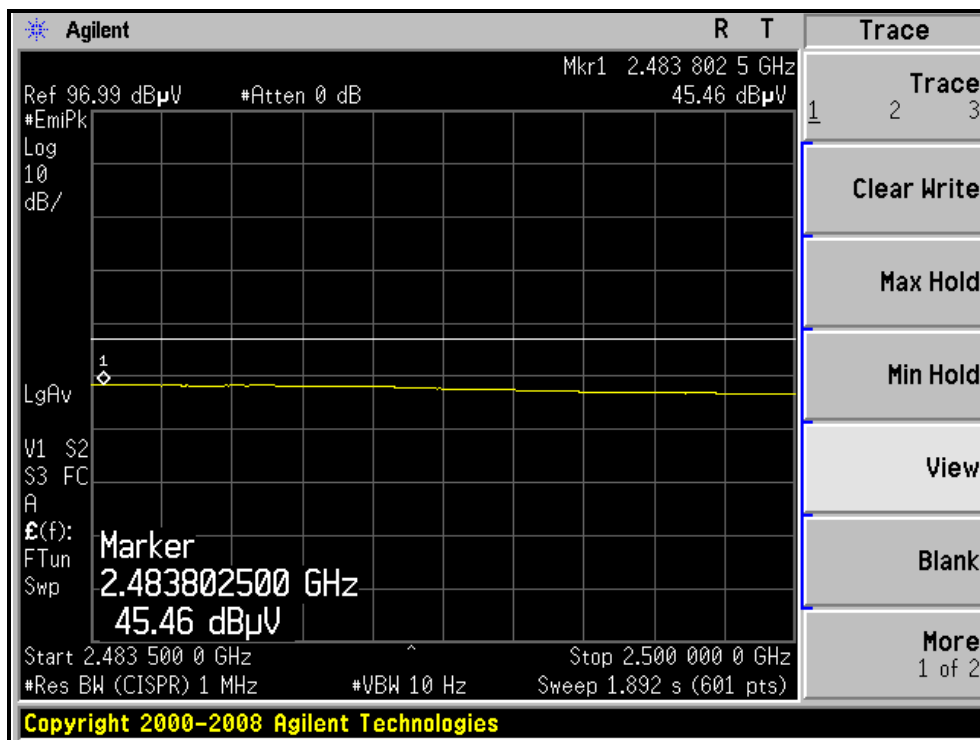
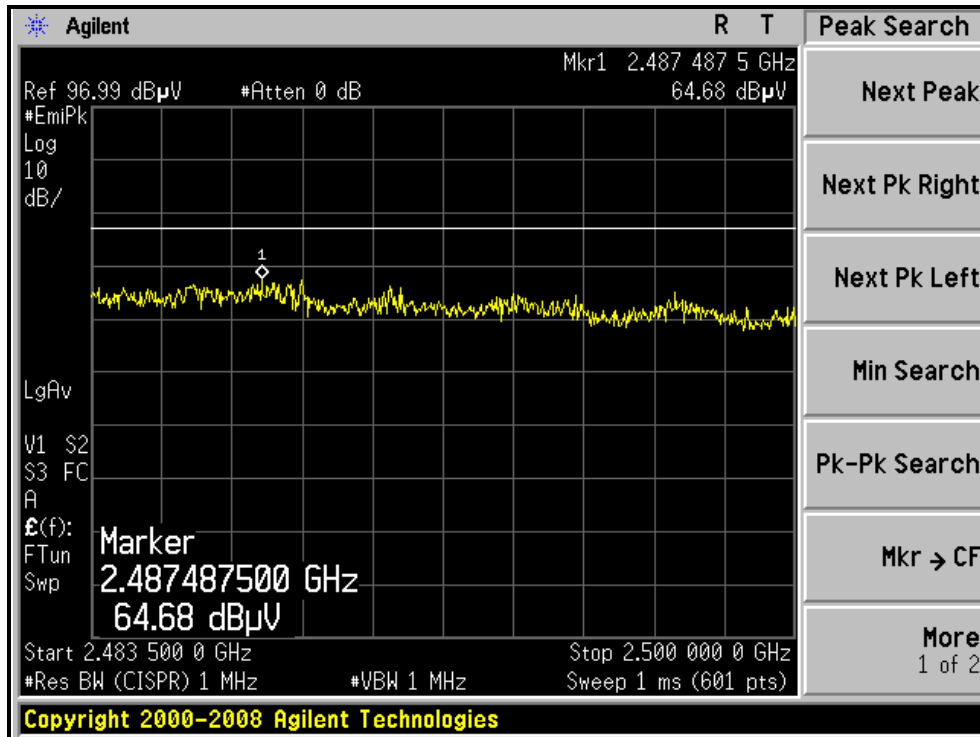



A D T

RESTRICTED BANDEDGE (802.11n (40MHz) MODE,CH7, VERTICAL)

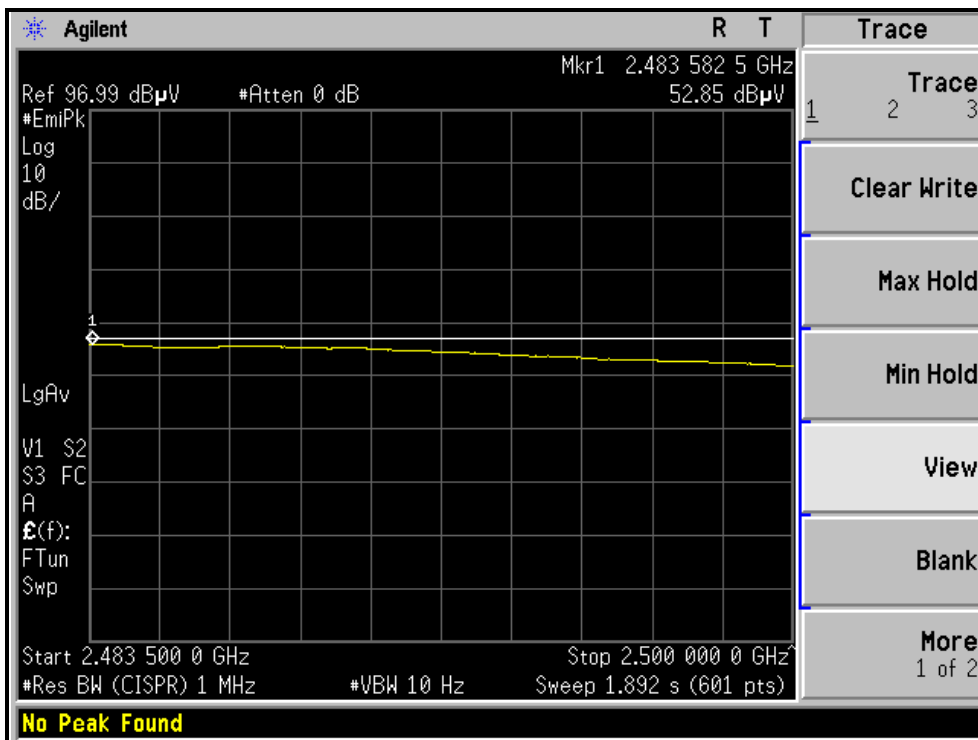
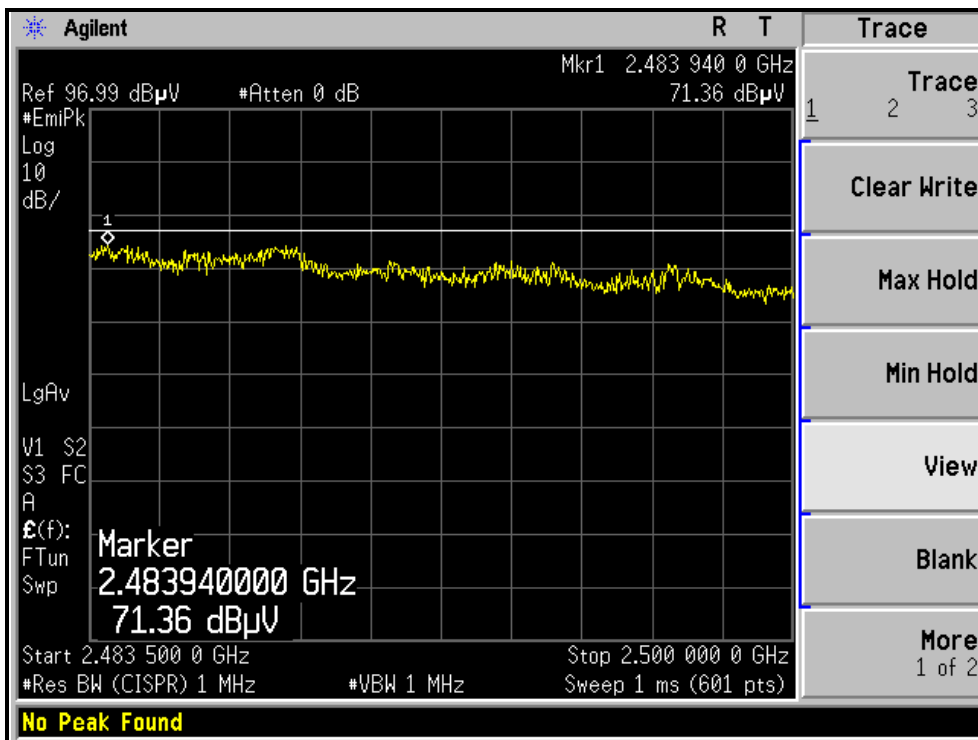



4.3 6dB BANDWIDTH MEASUREMENT

4.3.1 LIMITS OF 6dB BANDWIDTH MEASUREMENT

The minimum of 6dB Bandwidth Measurement is 0.5 MHz.

4.3.2 TEST INSTRUMENTS

DESCRIPTION & MANUFACTURER	MODEL NO.	SERIAL NO.	CALIBRATED DATE	CALIBRATED UNTIL
R&S SPECTRUM ANALYZER	FSP40	100037	Aug. 03, 2009	Aug. 02, 2010

NOTE:

- 1.The calibration interval of the above test instruments is 12 months and the calibrations are traceable to NML/ROC and NIST/USA.

4.3.3 TEST PROCEDURE

The transmitter output was connected to the spectrum analyzer through an attenuator. The bandwidth of the fundamental frequency was measured by spectrum analyzer with 100kHz RBW and 100kHz VBW. The 6dB bandwidth is defined as the total spectrum the power of which is higher than peak power minus 6dB.

4.3.4 DEVIATION FROM TEST STANDARD

No deviation

4.3.5 TEST SETUP



4.3.6 EUT OPERATING CONDITIONS

The software provided by client to enable the EUT under transmission condition continuously at lowest, middle and highest channel frequencies individually.

4.3.7 TEST RESULTS

802.11b DSSS MODULATION:

CHANNEL	CHANNEL FREQUENCY (MHz)	6dB BANDWIDTH (MHz)	MINIMUM LIMIT (MHz)	PASS / FAIL
1	2412	11.59	0.5	PASS
6	2437	11.59	0.5	PASS
11	2462	11.58	0.5	PASS

CH1

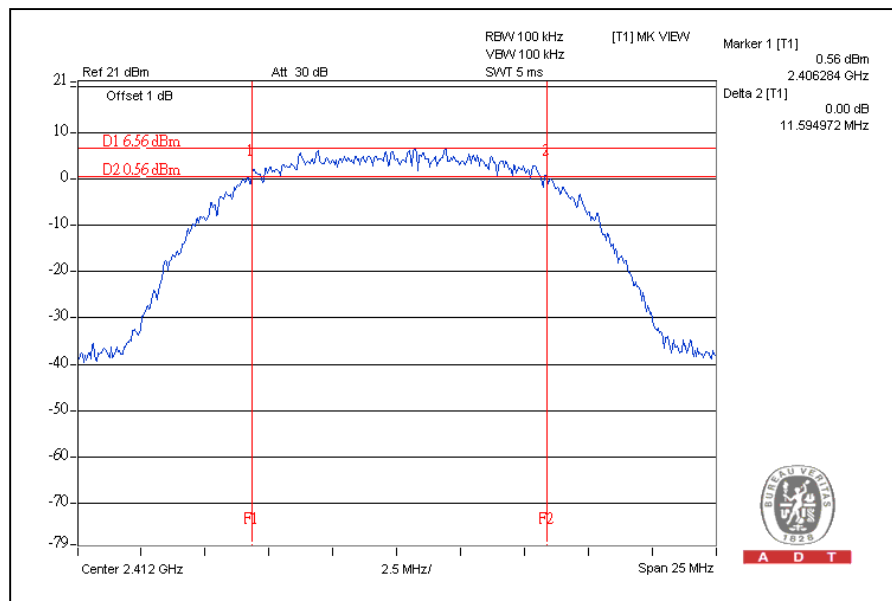

802.11g OFDM MODULATION:

CHANNEL	CHANNEL FREQUENCY (MHz)	6dB BANDWIDTH (MHz)	MINIMUM LIMIT (MHz)	PASS / FAIL
1	2412	16.45	0.5	PASS
6	2437	16.45	0.5	PASS
11	2462	16.45	0.5	PASS

CH6

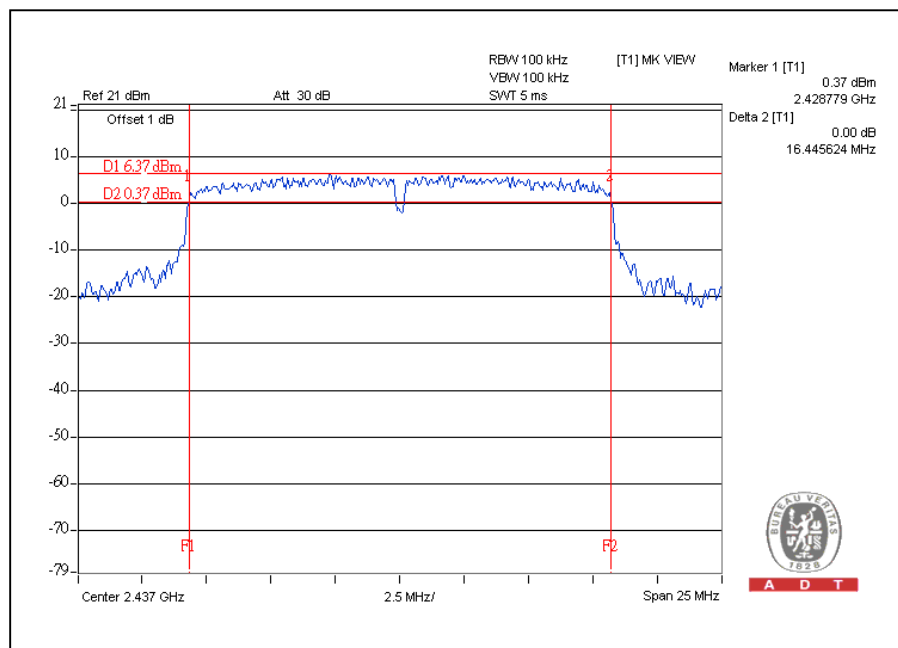



A D T

802.11n (20MHz) OFDM MODULATION:

CHANNEL	CHANNEL FREQUENCY (MHz)	6dB BANDWIDTH (MHz)	MINIMUM LIMIT (MHz)	PASS / FAIL
1	2412	17.26	0.5	PASS
6	2437	17.38	0.5	PASS
11	2462	17.19	0.5	PASS

CH6

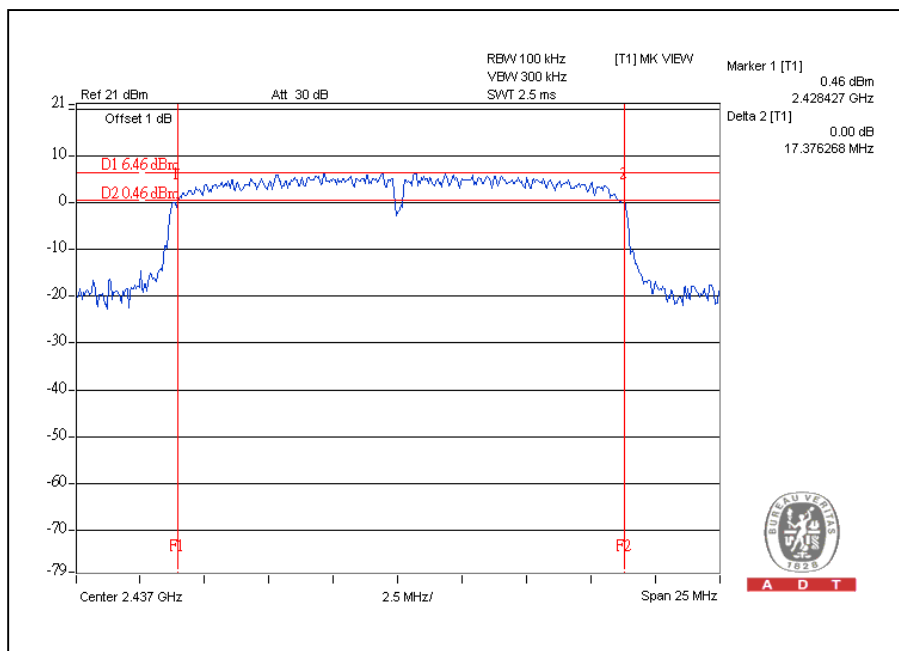

802.11n (40MHz) OFDM MODULATION:

CHANNEL	CHANNEL FREQUENCY (MHz)	6dB BANDWIDTH (MHz)	MINIMUM LIMIT (MHz)	PASS / FAIL
1	2422	35.47	0.5	PASS
4	2437	35.80	0.5	PASS
7	2452	35.92	0.5	PASS

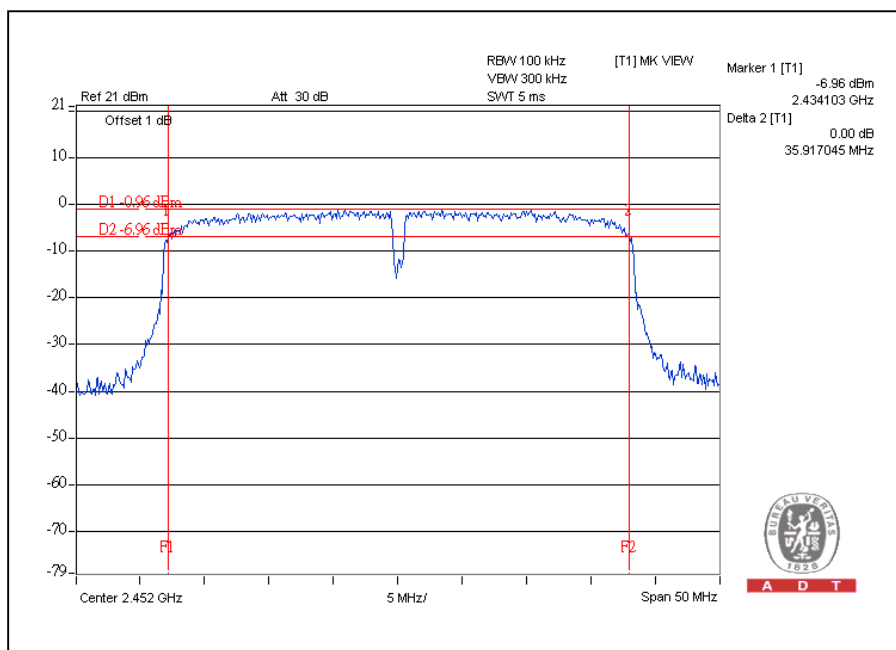
CH7

4.4 MAXIMUM PEAK OUTPUT POWER

4.4.1 LIMITS OF MAXIMUM PEAK OUTPUT POWER MEASUREMENT

The Maximum Peak Output Power Measurement is 30dBm.

4.4.2 INSTRUMENTS

DESCRIPTION & MANUFACTURER	MODEL NO.	SERIAL NO.	CALIBRATED DATE	CALIBRATED UNTIL
Anritsu Power Meter	ML2495A	0824006	April 25, 2009	April 24, 2010
Pulse Power Sensor	MA2411B	0738172	April 25, 2009	April 24, 2010

NOTE:

The calibration interval of the above test instruments is 12 months and the calibrations are traceable to NML/ROC and NIST/USA.

4.4.3 TEST PROCEDURES

1. The transmitter output was connected to the power meter through an attenuator; the bandwidth of the fundamental frequency was measured with the power meter.
2. Record the power level.

4.4.4 DEVIATION FROM TEST STANDARD

No deviation

4.4.5 TEST SETUP

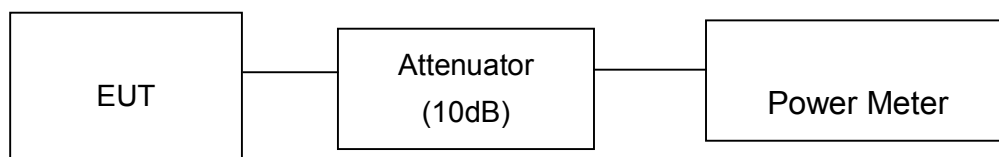

4.4.6 EUT OPERATING CONDITIONS

Same as Item 4.3.6



A D T

4.4.7 TEST RESULTS

802.11b DSSS MODULATION:

CHANNEL	CHANNEL FREQUENCY (MHz)	PEAK POWER OUTPUT (dBm)	PEAK POWER OUTPUT (mW)	PEAK POWER LIMIT (dBm)	PASS / FAIL
1	2412	19.7	93.3	30	PASS
6	2437	19.7	93.3	30	PASS
11	2462	19.1	81.3	30	PASS

802.11g OFDM MODULATION:

CHANNEL	CHANNEL FREQUENCY (MHz)	PEAK POWER OUTPUT (dBm)	PEAK POWER OUTPUT (mW)	PEAK POWER LIMIT (dBm)	PASS / FAIL
1	2412	25.8	380.2	30	PASS
6	2437	25.9	389.0	30	PASS
11	2462	25.6	363.1	30	PASS

802.11n (20MHz) OFDM MODULATION:

CHANNEL	CHANNEL FREQUENCY (MHz)	PEAK POWER OUTPUT (dBm)	PEAK POWER OUTPUT (mW)	PEAK POWER LIMIT (dBm)	PASS / FAIL
1	2412	25.1	323.6	30	PASS
6	2437	26.1	407.4	30	PASS
11	2462	25.7	371.5	30	PASS



A D T

802.11n (40MHz) OFDM MODULATION:

CHANNEL	CHANNEL FREQUENCY (MHz)	PEAK POWER OUTPUT (dBm)	PEAK POWER OUTPUT (mW)	PEAK POWER LIMIT (dBm)	PASS / FAIL
1	2422	24.2	263.0	30	PASS
4	2437	25.4	346.7	30	PASS
7	2452	24.2	263.0	30	PASS



4.5 POWER SPECTRAL DENSITY MEASUREMENT

4.5.1 LIMITS OF POWER SPECTRAL DENSITY MEASUREMENT

The Maximum of Power Spectral Density Measurement is 8dBm.

4.5.2 TEST INSTRUMENTS

DESCRIPTION & MANUFACTURER	MODEL NO.	SERIAL NO.	CALIBRATED DATE	CALIBRATED UNTIL
R&S SPECTRUM ANALYZER	FSP40	100037	Aug. 03, 2009	Aug. 02, 2010

NOTE:

- 1.The calibration interval of the above test instruments is 12 months and the calibrations are traceable to NML/ROC and NIST/USA.

4.5.3 TEST PROCEDURE

The transmitter output was connected to the spectrum analyzer through an attenuator, the bandwidth of the fundamental frequency was measured with the spectrum analyzer using 3kHz RBW and 30kHz VBW, set sweep time = span/3kHz. The power spectral density was measured and recorded. The sweep time is allowed to be longer than span/3kHz for a full response of the mixer in the spectrum analyzer.

4.5.4 DEVIATION FROM TEST STANDARD

No deviation

4.5.5 TEST SETUP

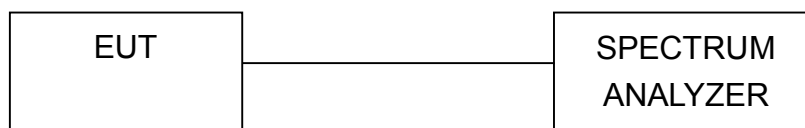

4.5.6 EUT OPERATING CONDITION

Same as Item 4.3.6



A D T

4.5.7 TEST RESULTS

802.11b DSSS MODULATION:

CHANNEL	CHANNEL FREQUENCY (MHz)	RF POWER LEVEL IN 3kHz BW (dBm)	MAXIMUM LIMIT (dBm)	PASS / FAIL
1	2412	-6.3	8	PASS
6	2437	-6.2	8	PASS
11	2462	-6.2	8	PASS

CH6

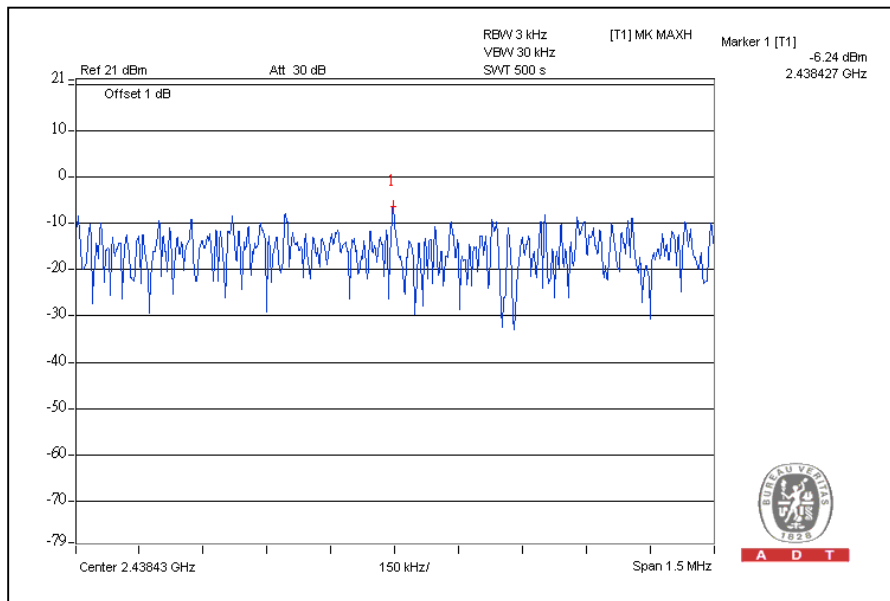



A D T

802.11g OFDM MODULATION:

CHANNEL	CHANNEL FREQUENCY (MHz)	RF POWER LEVEL IN 3kHz BW (dBm)	MAXIMUM LIMIT (dBm)	PASS / FAIL
1	2412	-11.5	8	PASS
6	2437	-7.8	8	PASS
11	2462	-10.7	8	PASS

CH6

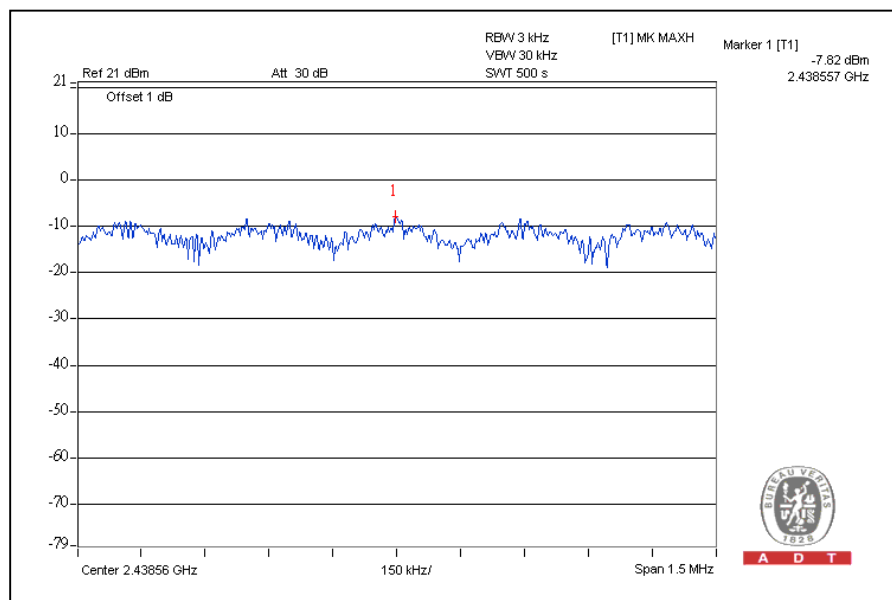



A D T

802.11n (20MHz) OFDM MODULATION:

CHANNEL	CHANNEL FREQUENCY (MHz)	RF POWER LEVEL IN 3kHz BW (dBm)	MAXIMUM LIMIT (dBm)	PASS / FAIL
1	2412	-11.7	8	PASS
6	2437	-7.1	8	PASS
11	2462	-10.9	8	PASS

CH6

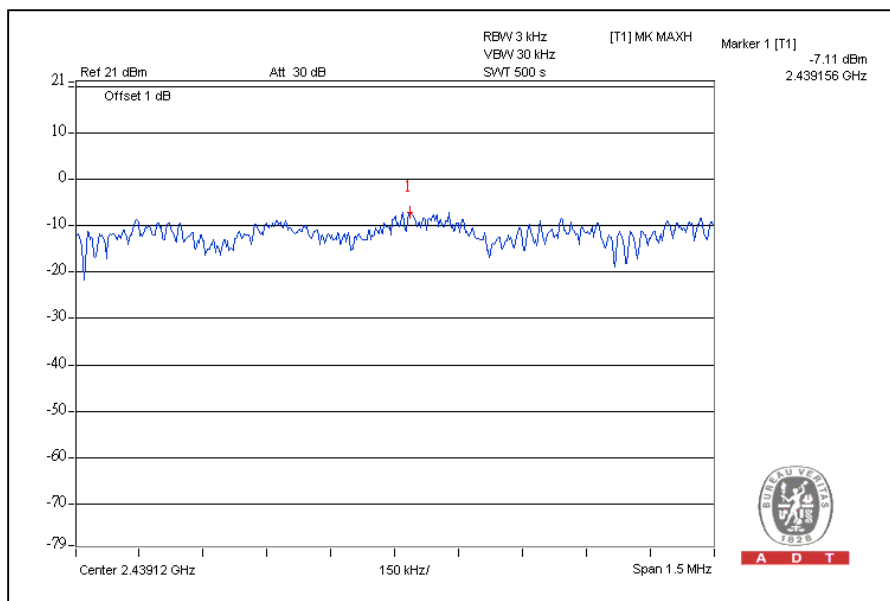



A D T

802.11n (40MHz) OFDM MODULATION:

CHANNEL	CHANNEL FREQUENCY (MHz)	RF POWER LEVEL IN 3kHz BW (dBm)	MAXIMUM LIMIT (dBm)	PASS / FAIL
1	2422	-15.4	8	PASS
4	2437	-12.0	8	PASS
7	2452	-13.7	8	PASS

CH4

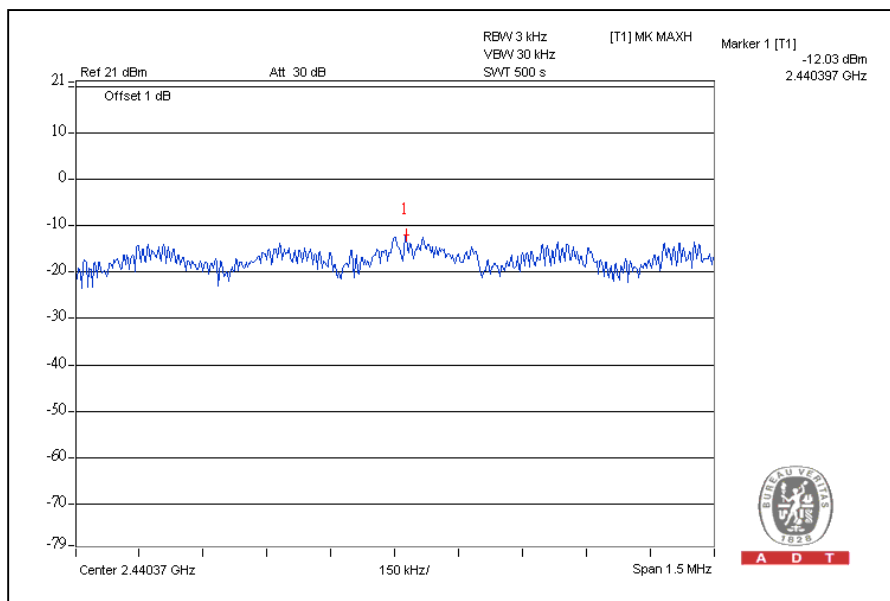

4.6 CONDUCTED OUT-BAND EMISSION MEASUREMENT

4.6.1 LIMITS OF CONDUCTED OUT-BAND EMISSION MEASUREMENT

Below -20dB of the highest emission level of operating band (in 100KHz Resolution Bandwidth).

4.6.2 TEST INSTRUMENTS

DESCRIPTION & MANUFACTURER	MODEL NO.	SERIAL NO.	CALIBRATED DATE	CALIBRATED UNTIL
R&S SPECTRUM ANALYZER	FSP40	100037	Aug. 03, 2009	Aug. 02, 2010

NOTE:

- 1.The calibration interval of the above test instruments is 12 months and the calibrations are traceable to NML/ROC and NIST/USA.

4.6.3 TEST PROCEDURE

The transmitter output was connected to the spectrum analyzer via a low lose cable. Set RBW of spectrum analyzer to 100kHz and VBW of spectrum analyzer to 300kHz with suitable frequency span including 100 MHz bandwidth from band edge. The band edges was measured and recorded.

The spectrum plots (RBW = 100kHz, VBW = 300kHz) are attached on the following pages.

4.6.4 DEVIATION FROM TEST STANDARD

No deviation

4.6.5 EUT OPERATING CONDITION

Same as Item 4.3.6

4.6.6 TEST RESULTS

The spectrum plots are attached on the following images. D1 line indicates the highest level, and D2 line indicates the 20dB offset below D1. It shows compliance with the requirement in part 15.247(d).

802.11b DSSS MODULATION:

CH1

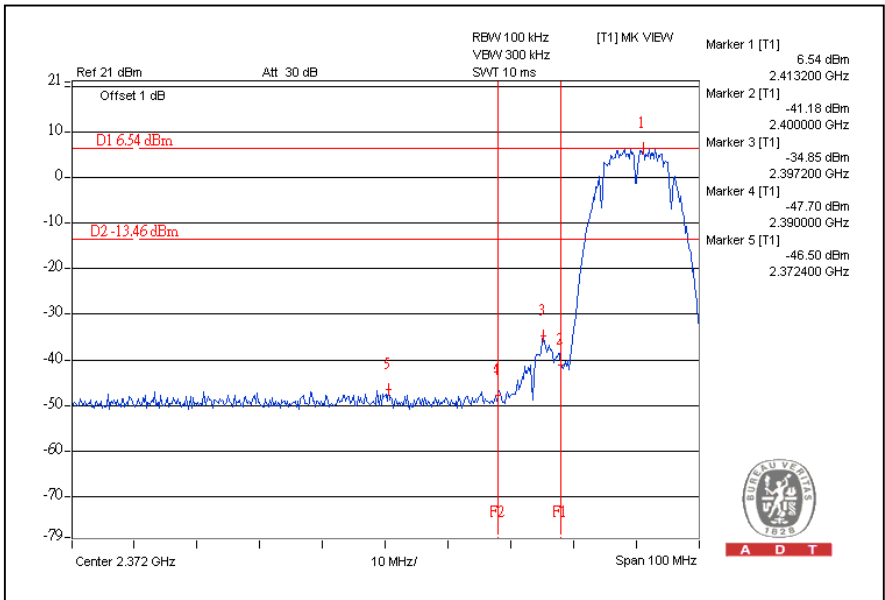

CH11

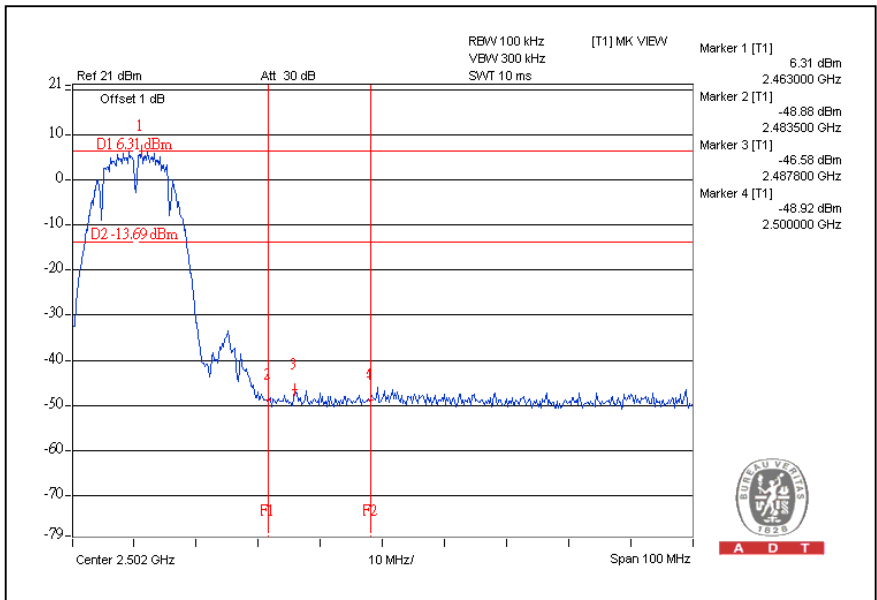

CH1

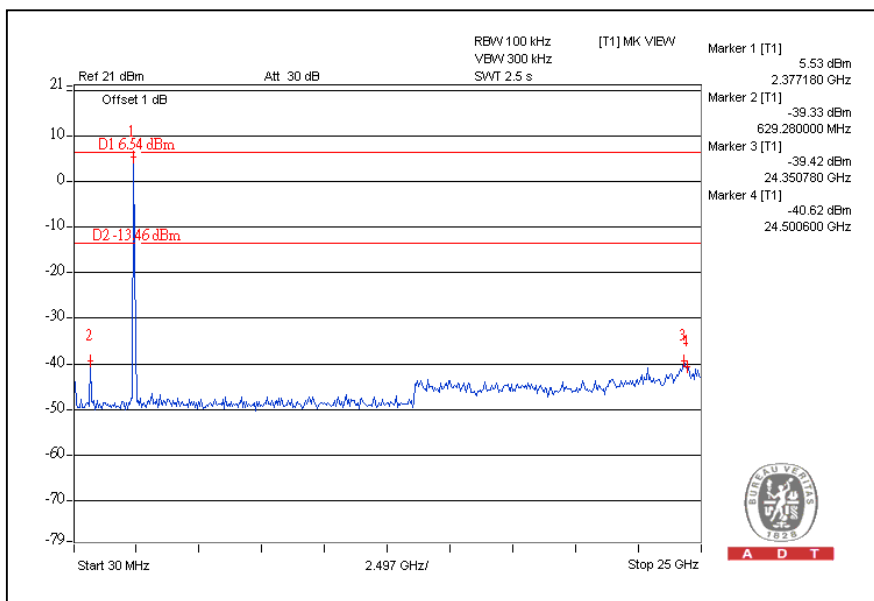

CH11

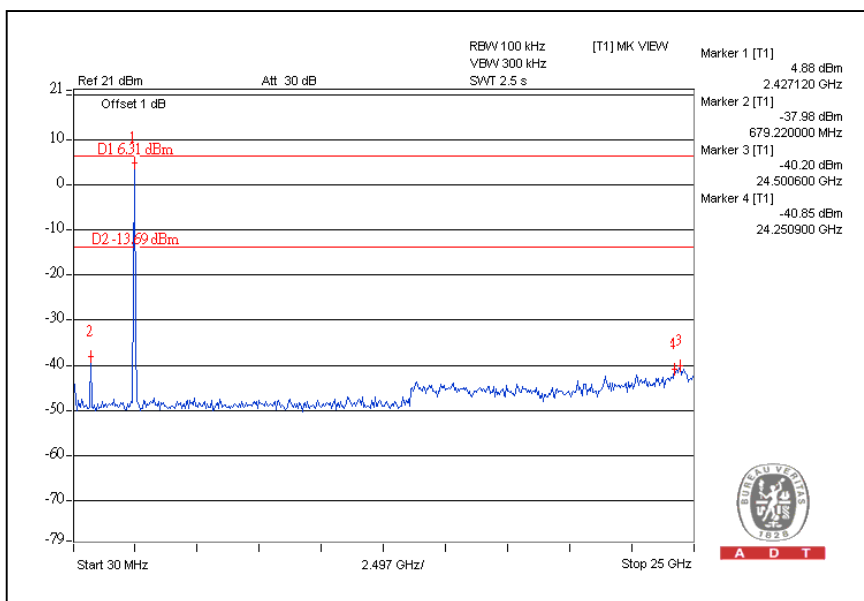

802.11g OFDM MODULATION:

CH1

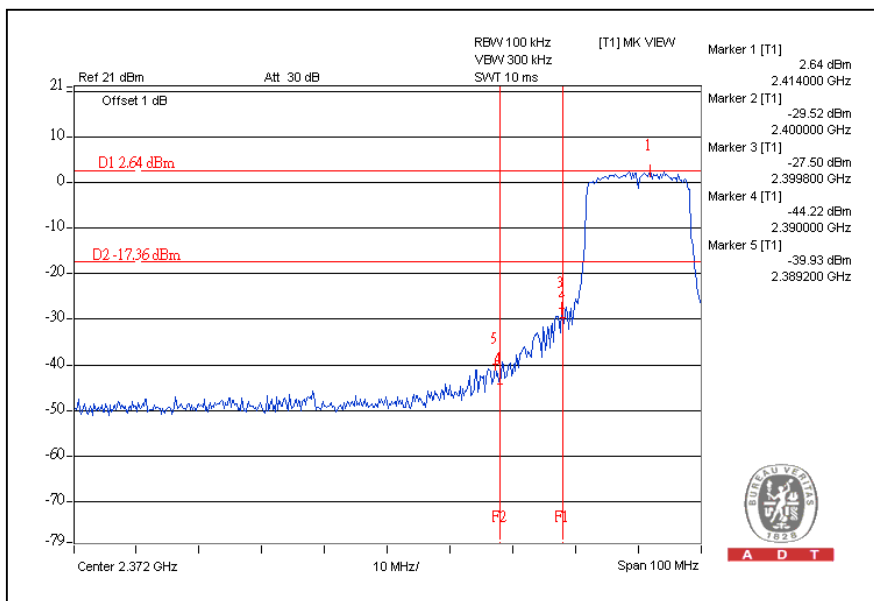

CH11

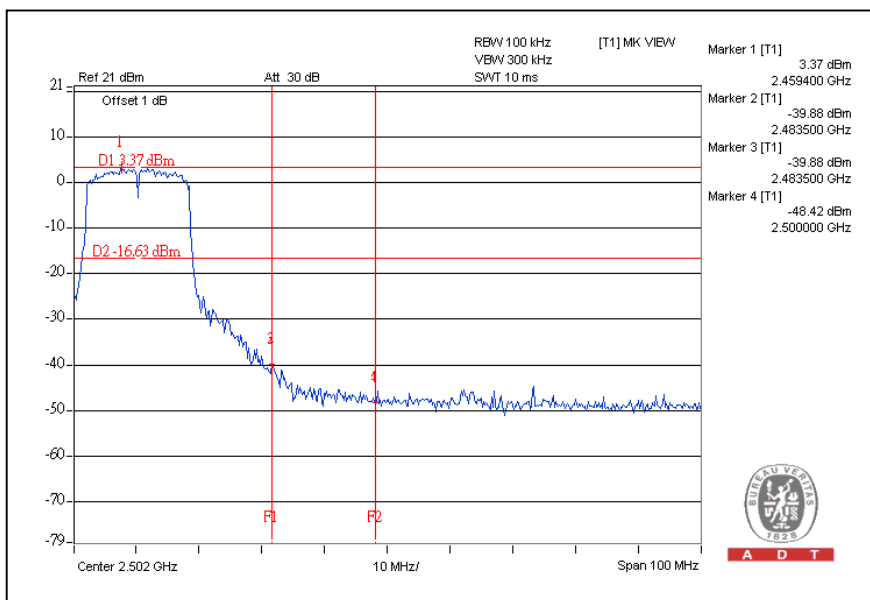



A D T

CH1

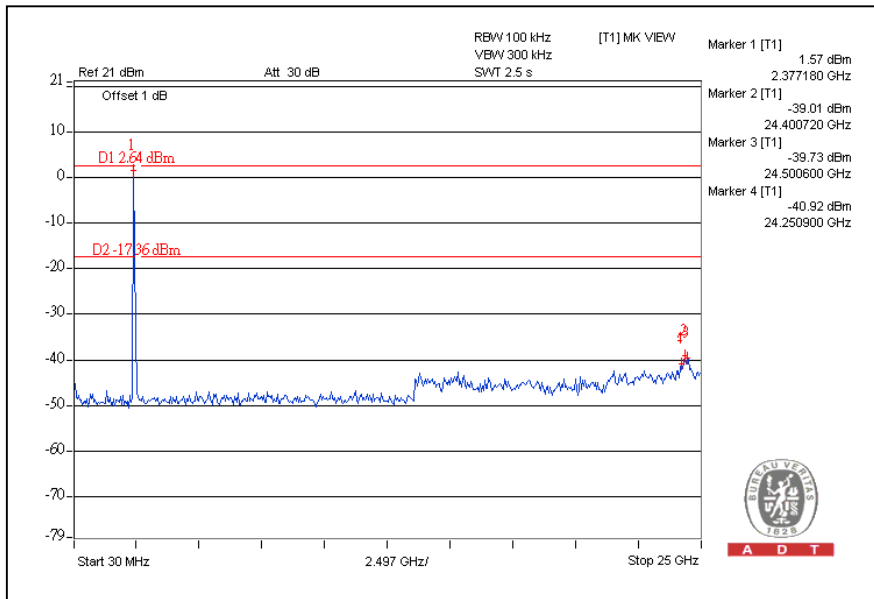

CH11

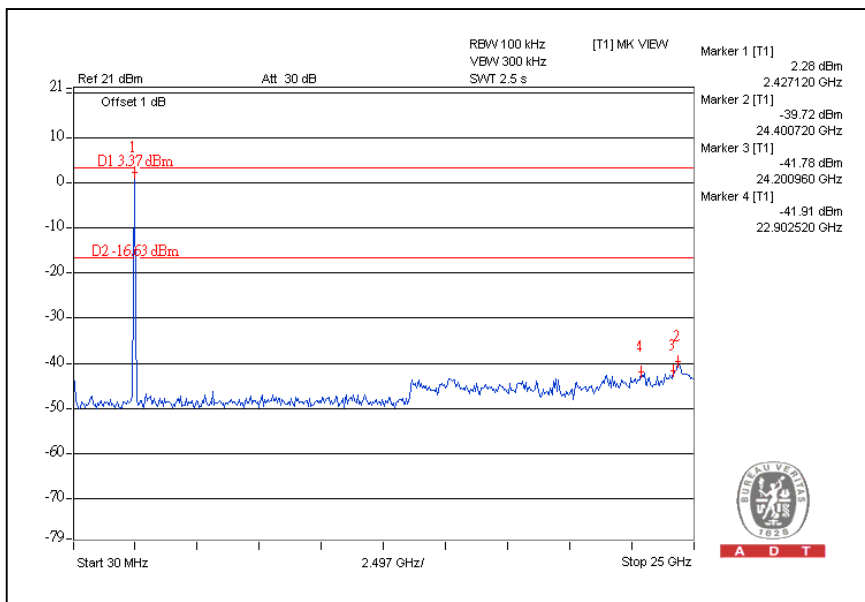

802.11n (20MHz) OFDM MODULATION:

CH1

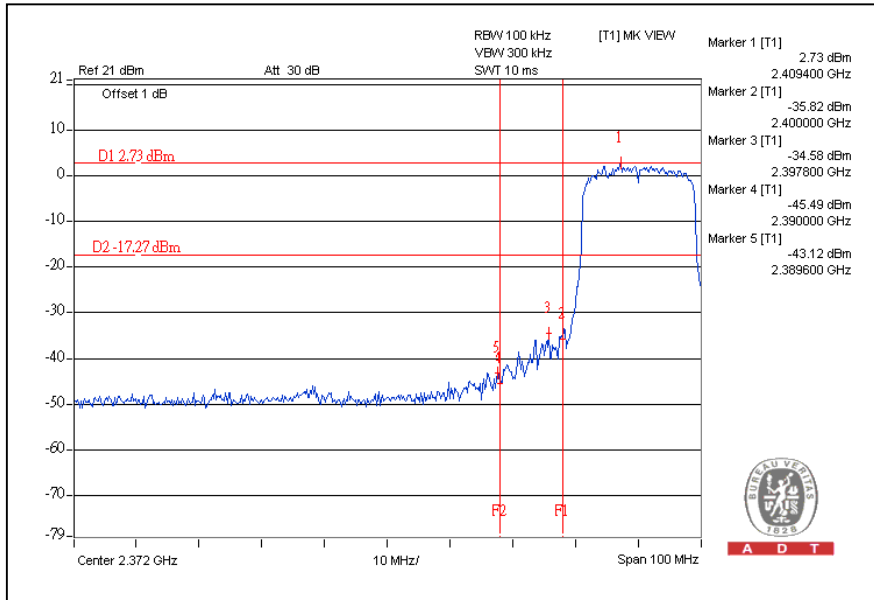

CH11

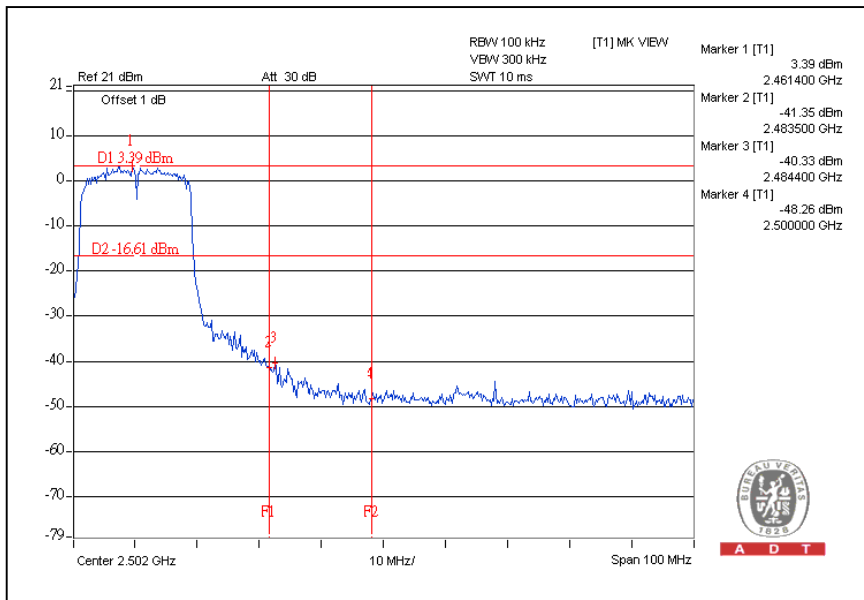



A D T

CH1

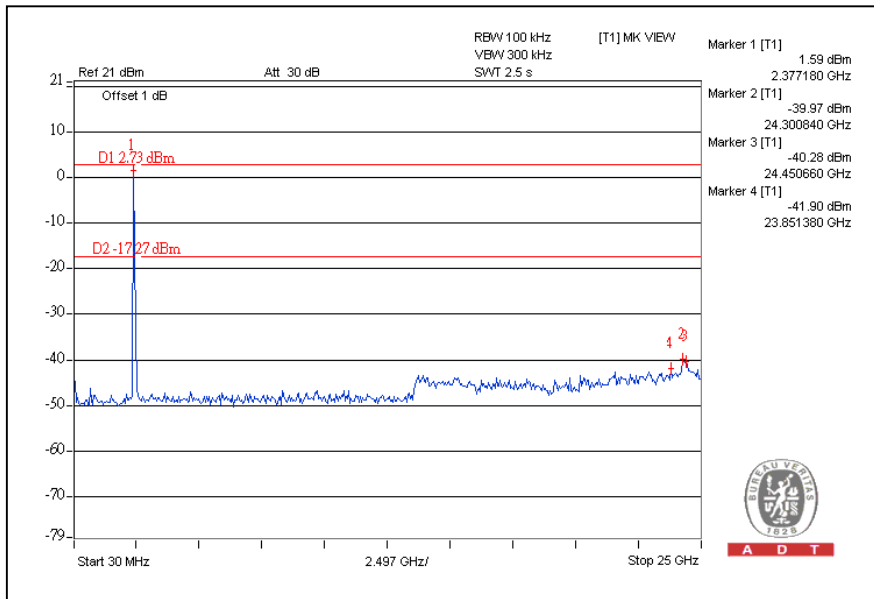

CH11

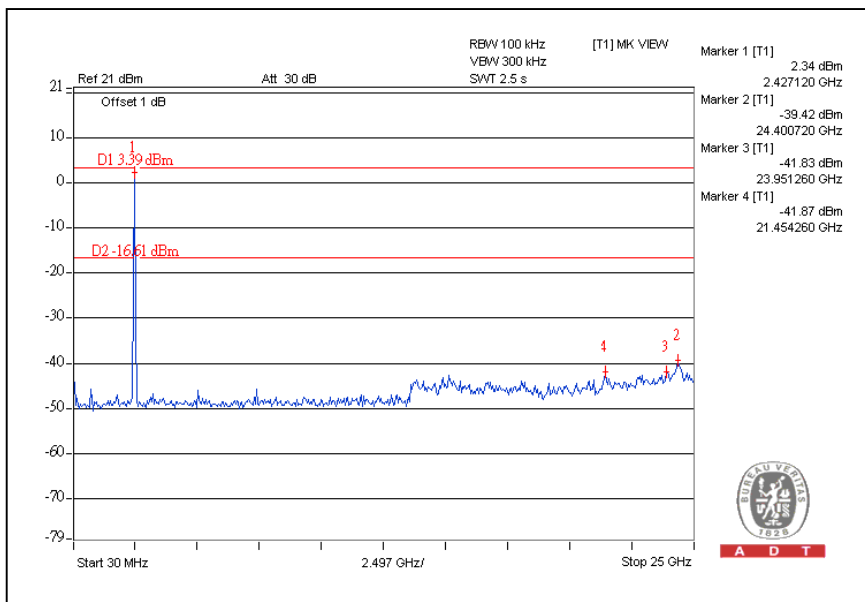

802.11n (40MHz) OFDM MODULATION:

CH1

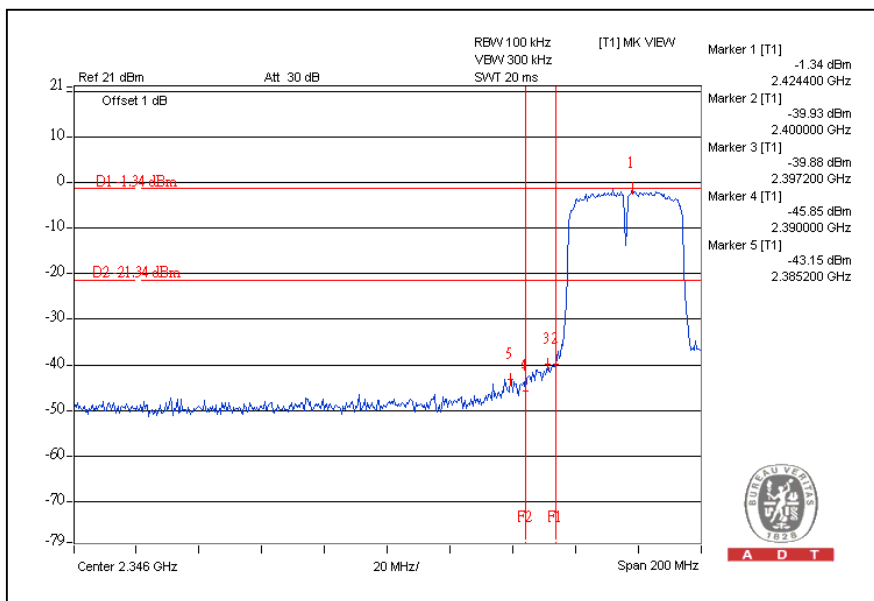

CH7

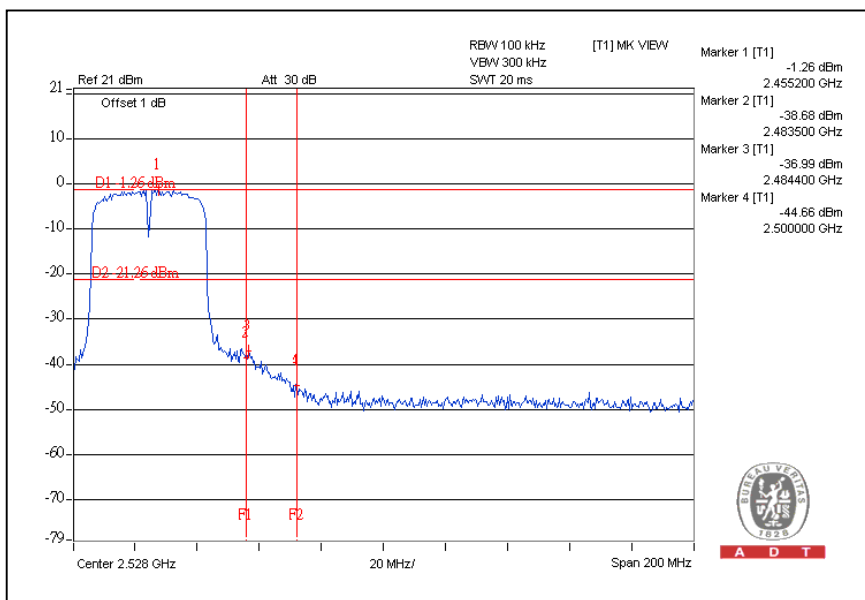



A D T

CH1

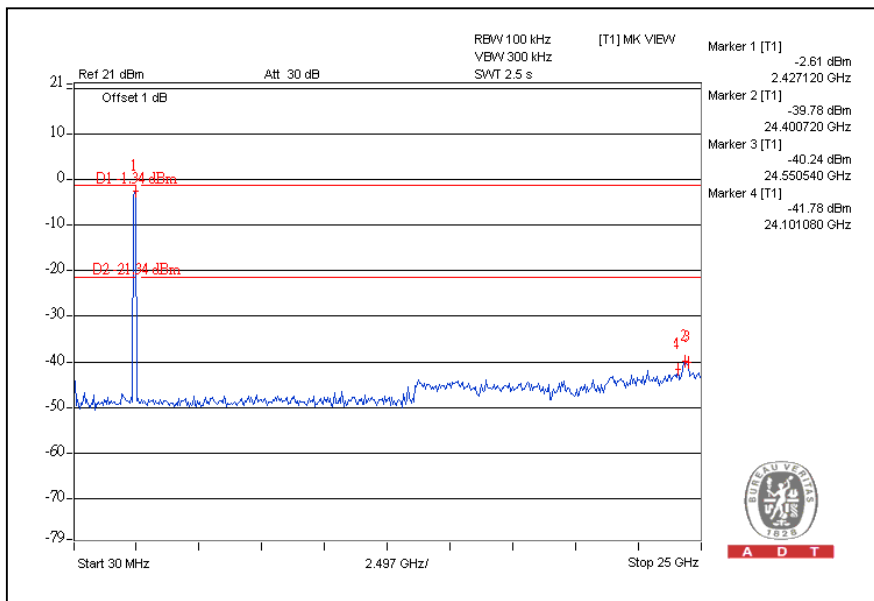

CH7

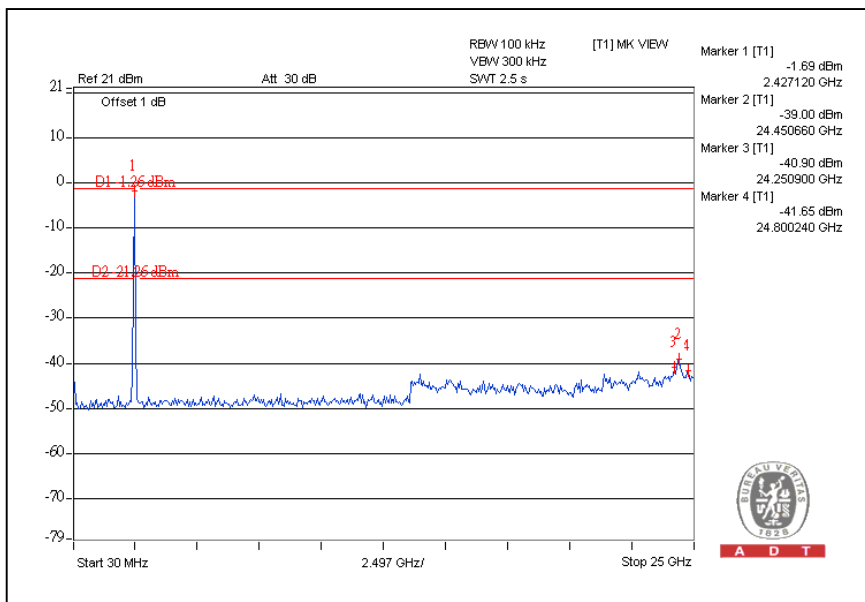



A D T

5. INFORMATION ON THE TESTING LABORATORIES

We, Bureau Veritas Consumer Products Services (H.K.) Ltd., Taoyuan Branch, were founded in 1988 to provide our best service in EMC, Radio, Telecom and Safety consultation. Our laboratories are accredited and approved according to ISO/IEC 17025:

Copies of accreditation certificates of our laboratories obtained from approval agencies can be downloaded from our web site:

www.adt.com.tw/index.5/phtml. If you have any comments, please feel free to contact us at the following:

Linko EMC/RF Lab:

Tel: 886-2-26052180

Fax: 886-2-26052943

Hsin Chu EMC/RF Lab:

Tel: 886-3-5935343

Fax: 886-3-5935342

Hwa Ya EMC/RF/Safety Telecom Lab:

Tel: 886-3-3183232

Fax: 886-3-3185050

Web Site: www.adt.com.tw

The address and road map of all our labs can be found in our web site also



A D T

6.APPENDIX-A- MODIFICATIONS RECORDERS FOR ENGINEERING CHANGES TO THE EUT BY THE LAB

No any modifications are made to the EUT by the lab during the test.

---END---