



FCC TEST REPORT (Zigbee)

REPORT NO.: RF131128E01-1

MODEL NO.: F7C031

FCC ID: K7SF7C031

RECEIVED: Nov. 28, 2013

TESTED: Dec. 09, 2013 to May 02, 2014

ISSUED: June 12, 2014

APPLICANT: Belkin, International Inc.,

ADDRESS: 12045 East Waterfront Drive Playa Vista,
California 90094 United States

ISSUED BY: Bureau Veritas Consumer Products Services
(H.K.) Ltd., Taoyuan Branch Hsin Chu Laboratory

LAB ADDRESS : No. 81-1, Lu Liao Keng, 9th Ling, Wu Lung Tsuen,
Chiung Lin Hsiang, Hsin Chu Hsien 307, Taiwan,
R.O.C.

TEST LOCATION (1): No. 81-1, Lu Liao Keng, 9th Ling, Wu Lung Tsuen,
Chiung Lin Hsiang, Hsin Chu Hsien 307, Taiwan,
R.O.C.

TEST LOCATION (2): No. 49, Ln. 206, Wende Rd., Shangshan Tsuen,
Chiung Lin Hsiang, Hsin Chu Hsien 307, Taiwan,
R.O.C.

This report should not be used by the client to claim product certification, approval, or endorsement by TAF or any government agencies.



This report is for your exclusive use. Any copying or replication of this report to or for any other person or entity, or use of our name or trademark, is permitted only with our prior written permission. This report sets forth our findings solely with respect to the test samples identified herein. The results set forth in this report are not indicative or representative of the quality or characteristics of the lot from which a test sample was taken or any similar or identical product unless specifically and expressly noted. Our report includes all of the tests requested by you and the results thereof based upon the information that you provided to us. You have 60 days from date of issuance of this report to notify us of any material error or omission caused by our negligence, provided, however, that such notice shall be in writing and shall specifically address the issue you wish to raise. A failure to raise such issue within the prescribed time shall constitute your unqualified acceptance of the completeness of this report, the tests conducted and the correctness of the report contents. Unless specific mention, the uncertainty of measurement has been explicitly taken into account to declare the compliance or non-compliance to the specification



Table of Contents

RELEASE CONTROL RECORD	4
1. CERTIFICATION	5
2. SUMMARY OF TEST RESULTS	6
2.1 MEASUREMENT UNCERTAINTY	7
3. GENERAL INFORMATION.....	8
3.1 GENERAL DESCRIPTION OF EUT (Zigbee)	8
3.2 DESCRIPTION OF TEST MODES.....	10
3.2.1 TEST MODE APPLICABILITY AND TESTED CHANNEL DETAIL.....	11
3.3 GENERAL DESCRIPTION OF APPLIED STANDARDS	13
3.4 DUTY CYCLE OF TEST SIGNAL.....	13
3.5 DESCRIPTION OF SUPPORT UNITS	14
3.6 CONFIGURATION OF SYSTEM UNDER TEST	14
4. TEST TYPES AND RESULTS	15
4.1 CONDUCTED EMISSION MEASUREMENT	15
4.1.1 LIMITS OF CONDUCTED EMISSION MEASUREMENT.....	15
4.1.2 TEST INSTRUMENTS	15
4.1.3 TEST PROCEDURES	16
4.1.4 DEVIATION FROM TEST STANDARD	16
4.1.5 TEST SETUP	16
4.1.6 EUT OPERATING CONDITIONS	17
4.1.7 TEST RESULTS	18
4.2 RADIATED EMISSION AND BANDEDGE MEASUREMENT.....	20
4.2.1 LIMITS OF RADIATED EMISSION AND BANDEDGE MEASUREMENT	20
4.2.2 TEST INSTRUMENTS	21
4.2.3 TEST PROCEDURES	24
4.2.4 DEVIATION FROM TEST STANDARD	24
4.2.5 TEST SETUP	25
4.2.6 EUT OPERATING CONDITIONS	25
4.2.7 TEST RESULTS (MODE 1).....	26
4.2.8 TEST RESULTS (MODE 2).....	30
4.3 6dB BANDWIDTH MEASUREMENT	34
4.3.1 LIMITS OF 6dB BANDWIDTH MEASUREMENT	34
4.3.2 TEST INSTRUMENTS	34
4.3.3 TEST PROCEDURE	34
4.3.4 DEVIATION FROM TEST STANDARD	34
4.3.5 TEST SETUP	34
4.3.6 EUT OPERATING CONDITIONS	34
4.3.7 TEST RESULTS	35
4.4 CONDUCTED OUTPUT POWER MEASUREMENT	36
4.4.1 LIMITS OF MAXIMUM PEAK OUTPUT POWER MEASUREMENT	36
4.4.2 TEST INSTRUMENTS	36
4.4.3 TEST PROCEDURES	36
4.4.4 DEVIATION FROM TEST STANDARD	37
4.4.5 TEST SETUP	37
4.4.6 EUT OPERATING CONDITIONS	37
4.4.7 TEST RESULTS	37
4.5 AVERAGE OUTPUT POWER	38
4.5.1 LIMITS OF AVERAGE OUTPUT POWER MEASUREMENT	38
4.5.2 TEST INSTRUMENTS	38
4.5.3 TEST PROCEDURES	38



A D T

4.5.4	TEST SETUP	38
4.5.5	EUT OPERATING CONDITIONS	38
4.5.6	TEST RESULTS	39
4.6	POWER SPECTRAL DENSITY MEASUREMENT	40
4.6.1	LIMITS OF POWER SPECTRAL DENSITY MEASUREMENT	40
4.6.2	TEST INSTRUMENTS	40
4.6.3	TEST PROCEDURE	40
4.6.4	DEVIATION FROM TEST STANDARD	40
4.6.5	TEST SETUP	40
4.6.6	EUT OPERATING CONDITION	40
4.6.7	TEST RESULTS	41
4.7	CONDUCTED OUT-BAND EMISSION MEASUREMENT	42
4.7.1	LIMITS OF CONDUCTED OUT-BAND EMISSION MEASUREMENT	42
4.7.2	TEST INSTRUMENTS	42
4.7.3	TEST PROCEDURE	42
4.7.4	DEVIATION FROM TEST STANDARD	43
4.7.5	TEST SETUP	43
4.7.6	EUT OPERATING CONDITION	43
4.7.7	TEST RESULTS	43
5.	PHOTOGRAPHS OF THE TEST CONFIGURATION	45
6.	INFORMATION ON THE TESTING LABORATORIES	46
7.	APPENDIX A - MODIFICATIONS RECORDERS FOR ENGINEERING CHANGES TO THE EUT BY THE LAB	47



A D T

RELEASE CONTROL RECORD

ISSUE NO.	REASON FOR CHANGE	DATE ISSUED
RF131128E01-1	Original release	June 12, 2014



1. CERTIFICATION

PRODUCT: WeMo Link
BRAND NAME: Belkin
MODEL NO.: F7C031
TEST SAMPLE: ENGINEERING SAMPLE
APPLICANT: Belkin, International Inc.,
TESTED: Dec. 09, 2013 to May 02, 2014
STANDARDS: **FCC Part 15, Subpart C (Section 15.247)**
ANSI C63.10-2009

The above equipment (Model: F7C031) has been tested by **Bureau Veritas Consumer Products Services (H.K.) Ltd., Taoyuan Branch**, and found compliance with the requirement of the above standards. The test record, data evaluation & Equipment Under Test (EUT) configurations represented herein are true and accurate accounts of the measurements of the sample's EMC characteristics under the conditions specified in this report.

PREPARED BY : , **DATE:** June 12, 2014
(Lori Chung, Specialist)

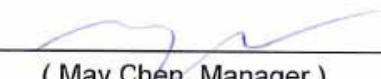
APPROVED BY : , **DATE:** June 12, 2014
(May Chen, Manager)



A D T

2. SUMMARY OF TEST RESULTS

The EUT has been tested according to the following specifications:

APPLIED STANDARD: FCC PART 15, SUBPART C (SECTION 15.247)			
STANDARD SECTION	TEST TYPE	RESULT	REMARK
15.207	AC Power Conducted Emission	PASS	Meet the requirement of limit. Minimum passing margin is -9.97dB at 0.97031MHz
15.205 & 15.209	Radiated Emissions	PASS	Meet the requirement of limit. Minimum passing margin is -3.6dB at 839.75MHz
15.247(d)	Band Edge Measurement	PASS	Meet the requirement of limit. Minimum passing margin is -4.6dB at 2483.50MHz
15.247(d)	Antenna Port Emission	PASS	Meet the requirement of limit.
15.247(a)(2)	6dB bandwidth	PASS	Meet the requirement of limit.
15.247(b)	Conducted output power	PASS	Meet the requirement of limit.
15.247(e)	Power Spectral Density	PASS	Meet the requirement of limit.
15.203	Antenna Requirement	PASS	Antenna connector is i-pex(MHF) not a standard connector.



A D T

2.1 MEASUREMENT UNCERTAINTY

Where relevant, the following measurement uncertainty levels have been estimated for tests performed on the EUT as specified in CISPR 16-4-2:

This uncertainty represents an expanded uncertainty expressed at approximately the 95% confidence level using a coverage factor of $k=2$.

Measurement	Value
Conducted emissions	2.98 dB
Radiated emissions (30MHz-1GHz)	5.37 dB
Radiated emissions (1GHz -6GHz)	3.65 dB
Radiated emissions (6GHz -18GHz)	3.88 dB
Radiated emissions (18GHz -40GHz)	4.11 dB



A D T

3. GENERAL INFORMATION

3.1 GENERAL DESCRIPTION OF EUT (Zigbee)

PRODUCT	WeMo Link
MODEL NO.	F7C031
POWER SUPPLY	Please see NOTE
MODULATION TYPE	O-QPSK
TRANSFER RATE	250kbps
OPERATING FREQUENCY	2405 ~ 2475MHz
NUMBER OF CHANNEL	15
MAXIMUM OUTPUT POWER	95.719mW
ANTENNA TYPE	Please see NOTE
DATA CABLE	NA
I/O PORTS	Refer to user's manual
ASSOCIATED DEVICES	NA

NOTE:

1. According to the applicant's requirement two test samples were tested for radiated spurious emission only.
2. There are WLAN technology and Zigbee technology used for the EUT.
3. The antennas provided to the EUT, please refer to the following table:

Zigbee Antenna Spec.				
Brand	Antenna Type	Antenna Connector	Gain(dBi)	Frequency range (MHz)
WNC	PIFA	i-pex(MHF)	2.17	2400 – 2483.5
WLAN Antenna Spec.				
Brand	Antenna Type	Antenna Connector	Gain(dBi)	Frequency range (MHz)
WNC	PIFA	i-pex(MHF)	1.40	2400 – 2483.5

4. The EUT must be supplied with an internal power supply as below table:

Brand	Model No.	Spec.
KTEC	KSP20A0330100	AC Input: 100~240V, 50/60Hz, 0.18A DC Output: 3.3V, 1.2A

5. Spurious emission of the simultaneous operation (WLAN & Zigbee) has been evaluated and no non-compliance was found.
6. The above EUT information was declared by the manufacturer and for more detailed features description, please refer to the manufacturer's specifications or User's Manual.



A D T

3.2 DESCRIPTION OF TEST MODES

15 channels are provided to this EUT.

Channel	Freq. (MHz)	Channel	Freq. (MHz)	Channel	Freq. (MHz)	Channel	Freq. (MHz)
11	2405	15	2425	19	2445	23	2465
12	2410	16	2430	20	2450	24	2470
13	2415	17	2435	21	2455	25	2475
14	2420	18	2440	22	2460		



3.2.1 TEST MODE APPLICABILITY AND TESTED CHANNEL DETAIL

EUT CONFIGURE MODE	APPLICABLE TO					DESCRIPTION
	PLC	RE < 1G	RE ≥ 1G	APCM	OB	
MODE 1	√	√	√	√	√	Sample 1
MODE 2	-	√	√	-	-	Sample 2

Where **PLC**: Power Line Conducted Emission **RE < 1G**: Radiated Emission below 1GHz
RE ≥ 1G: Radiated Emission above 1GHz **APCM**: Antenna Port Conducted Measurement
OB: Conducted Out-Band Emission Measurement

NOTE: 1. The EUT's antenna had been pre-tested on the positioned of each 2 axis. The worst case was found when positioned on X-plane.

POWER LINE CONDUCTED EMISSION TEST:

- Pre-Scan has been conducted to determine the worst-case mode from all possible combinations between available modulations, data rates and antenna ports (if EUT with antenna diversity architecture).
- Following channel(s) was (were) selected for the final test as listed below.

AVAILABLE CHANNEL	TESTED CHANNEL	MODULATION TECHNOLOGY	MODULATION TYPE	DATA RATE (kbps)
11 to 25	11	DSSS	O-QPSK	250

RADIATED EMISSION TEST (BELOW 1 GHz):

- Pre-Scan has been conducted to determine the worst-case mode from all possible combinations between available modulations, data rates and antenna ports (if EUT with antenna diversity architecture).
- Following channel(s) was (were) selected for the final test as listed below.

AVAILABLE CHANNEL	TESTED CHANNEL	MODULATION TECHNOLOGY	MODULATION TYPE	DATA RATE (kbps)
11 to 25	11	DSSS	O-QPSK	250

RADIATED EMISSION TEST (ABOVE 1 GHz):

- Pre-Scan has been conducted to determine the worst-case mode from all possible combinations between available modulations, data rates and antenna ports (if EUT with antenna diversity architecture).
- Following channel(s) was (were) selected for the final test as listed below.

AVAILABLE CHANNEL	TESTED CHANNEL	MODULATION TECHNOLOGY	MODULATION TYPE	DATA RATE (kbps)
11 to 25	11, 18, 25	DSSS	O-QPSK	250



ANTENNA PORT CONDUCTED MEASUREMENT:

- This item includes all test value of each mode, but only includes spectrum plot of worst value of each mode.
- Pre-Scan has been conducted to determine the worst-case mode from all possible combinations between available modulations, data rates and antenna ports (if EUT with antenna diversity architecture).
- Following channel(s) was (were) selected for the final test as listed below.

AVAILABLE CHANNEL	TESTED CHANNEL	MODULATION TECHNOLOGY	MODULATION TYPE	DATA RATE (kbps)
11 to 25	11, 18, 25	DSSS	O-QPSK	250

CONDUCTED OUT-BAND EMISSION MEASUREMENT:

- Pre-Scan has been conducted to determine the worst-case mode from all possible combinations between available modulations, data rates and antenna ports (if EUT with antenna diversity architecture).
- Following channel(s) was (were) selected for the final test as listed below.

AVAILABLE CHANNEL	TESTED CHANNEL	MODULATION TECHNOLOGY	MODULATION TYPE	DATA RATE (kbps)
11 to 25	11, 25	DSSS	O-QPSK	250

TEST CONDITION:

APPLICABLE TO	ENVIRONMENTAL CONDITIONS	INPUT POWER	TESTED BY
PLC	24deg. C, 61%RH	120Vac, 60Hz	Jyunchun Lin
RE<1G	22deg. C, 63%RH	120Vac, 60Hz	Robert Cheng
RE≥1G	22deg. C, 71%RH 22deg. C, 68%RH	120Vac, 60Hz	Tim Ho Chilin Lee
APCM	25deg. C, 60%RH	120Vac, 60Hz	Chilin Lee
OB	25deg. C, 60%RH	120Vac, 60Hz	Chilin Lee

3.3 GENERAL DESCRIPTION OF APPLIED STANDARDS

The EUT is a RF product. According to the specifications of the manufacturer, it must comply with the requirements of the following standards:

FCC Part 15, Subpart C (15.247)

558074 D01 DTS Meas Guidance v03r01

ANSI C63.10-2009

All test items have been performed and recorded as per the above standards.

3.4 DUTY CYCLE OF TEST SIGNAL

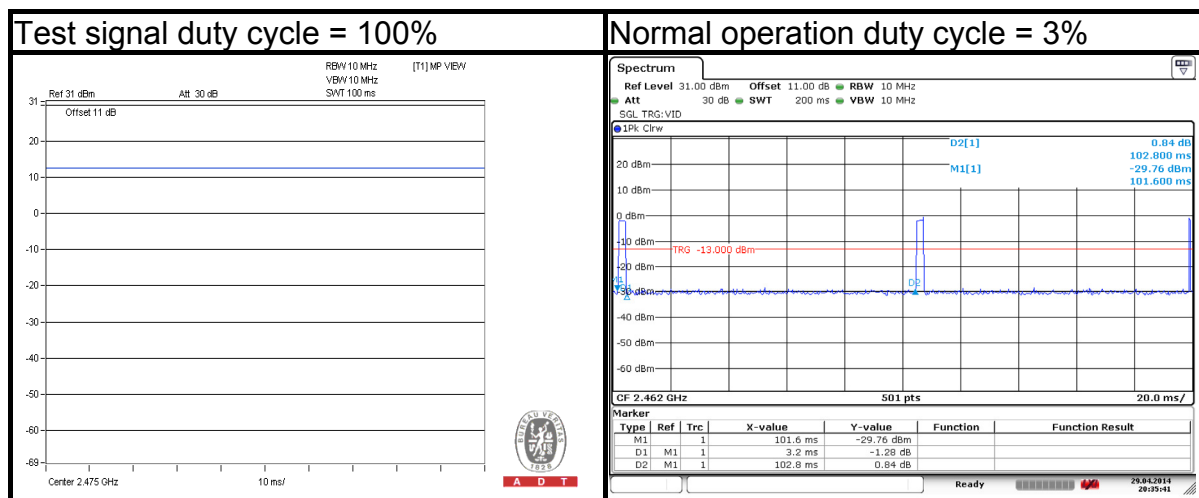

NOTE: Duty cycle 66% is the maximum capability of the RF chipset and declare by chip vendor.



A D T

3.5 DESCRIPTION OF SUPPORT UNITS

The EUT has been tested as an independent unit.

3.6 CONFIGURATION OF SYSTEM UNDER TEST

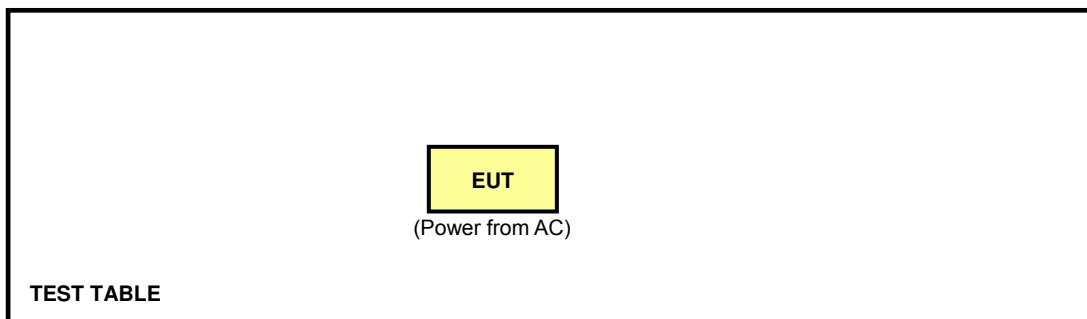



A D T

4. TEST TYPES AND RESULTS

4.1 CONDUCTED EMISSION MEASUREMENT

4.1.1 LIMITS OF CONDUCTED EMISSION MEASUREMENT

FREQUENCY OF EMISSION (MHz)	CONDUCTED LIMIT (dB μ V)	
	Quasi-peak	Average
0.15-0.5	66 to 56	56 to 46
0.5-5	56	46
5-30	60	50

- NOTE:**
1. The lower limit shall apply at the transition frequencies.
 2. The limit decreases in line with the logarithm of the frequency in the range of 0.15 to 0.50 MHz.

4.1.2 TEST INSTRUMENTS

DESCRIPTION & MANUFACTURER	MODEL NO.	SERIAL NO.	CALIBRATED DATE	CALIBRATED UNTIL
Test Receiver ROHDE & SCHWARZ	ESCS 30	100287	Feb. 28, 2013	Feb. 27, 2014
Line-Impedance Stabilization Network (for EUT) ROHDE & SCHWARZ	NSLK-8127	5127-523	Oct. 02, 2013	Oct. 01, 2014
Line-Impedance Stabilization Network (for Peripheral) ROHDE & SCHWARZ	ENV216	100071	Nov. 13, 2013	Nov. 12, 2014
RF Cable (JYEBAO)	5DFB	COACAB-001	May 27, 2013	May 26, 2014
50 ohms Terminator	50	3	Oct. 17, 2013	Oct. 16, 2014
50 ohms Terminator	N/A	EMC-04	Oct. 17, 2013	Oct. 16, 2014
Software ADT	BV ADT_Cond_V7.3.7 .3	NA	NA	NA

Note:

1. The calibration interval of the above test instruments is 12 months and the calibrations are traceable to NML/ROC and NIST/USA.
2. The test was performed in Shielded Room No. A.
3. The VCCI Con A Registration No. is C-817.
4. Tested Date: Dec. 09, 2013

4.1.3 TEST PROCEDURES

- a. The EUT was placed 0.4 meters from the conducting wall of the shielded room with EUT being connected to the power mains through a line impedance stabilization network (LISN). Other support units were connected to the power mains through another LISN.
- b. The two LISNs provide 50 ohm/ 50uH of coupling impedance for the measuring instrument.
- c. Both lines of the power mains connected to the EUT were checked for maximum conducted interference.
- d. The frequency range from 150kHz to 30MHz was searched. Emission levels under (Limit - 20dB) were not recorded.

NOTE:

1. The resolution bandwidth of test receiver is 9kHz for Quasi-peak detection (QP) & Average detection (AV).

4.1.4 DEVIATION FROM TEST STANDARD

No deviation

4.1.5 TEST SETUP

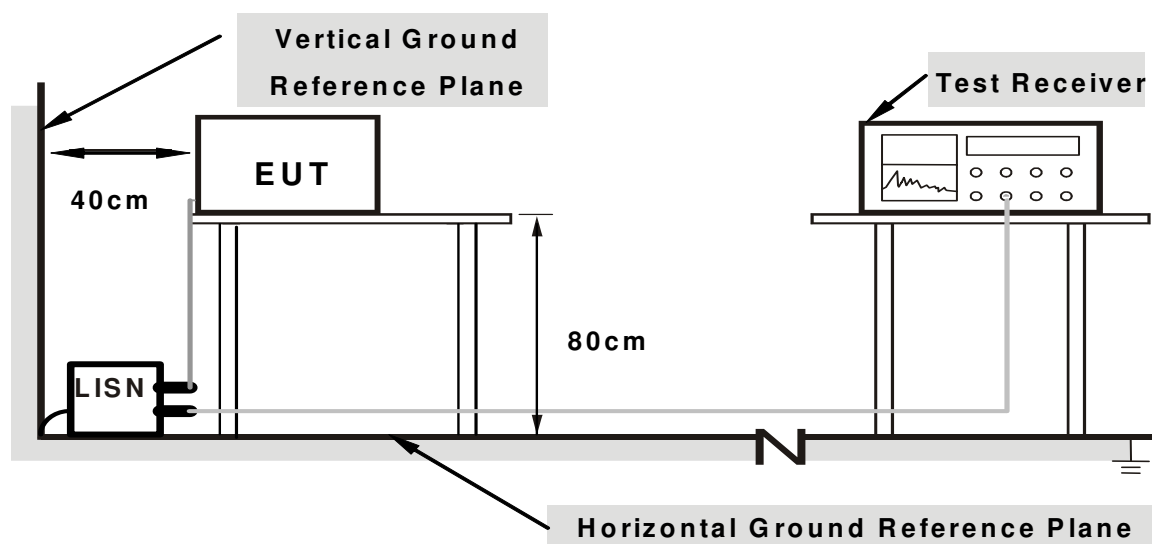

Note: 1.Support units were connected to second LISN.

For the actual test configuration, please refer to the related item – Photographs of the Test Configuration.

4.1.6 EUT OPERATING CONDITIONS

1. Controlling software (RT5350QA.exe & HyperTerminal paste Zigbee command) has been activated to set the EUT on specific status.

4.1.7 TEST RESULTS

PHASE	Line (L)	DETECTOR FUNCTION	Quasi-Peak (QP) / Average (AV)
-------	----------	-------------------	--------------------------------

No	Freq.	Corr.	Reading Value		Emission Level		Limit		Margin	
	[MHz]	[dB]	[dB (uV)]		[dB (uV)]		[dB (uV)]		(dB)	
			Q.P.	AV.	Q.P.	AV.	Q.P.	AV.	Q.P.	AV.
1	0.16322	0.07	40.71	39.71	40.78	39.78	65.30	55.30	-24.52	-15.52
2	0.29844	0.11	29.26	16.30	29.37	16.41	60.29	50.29	-30.92	-33.88
3	0.52891	0.15	34.96	24.04	35.11	24.19	56.00	46.00	-20.89	-21.81
4	0.97031	0.18	45.69	34.31	45.87	34.49	56.00	46.00	-10.13	-11.51
5	1.94100	0.24	30.65	22.11	30.89	22.35	56.00	46.00	-25.11	-23.65
6	2.91175	0.34	33.46	22.76	33.80	23.10	56.00	46.00	-22.20	-22.90

REMARKS:

1. Q.P. and AV. are abbreviations of quasi-peak and average individually.
2. The emission levels of other frequencies were very low against the limit.
3. Margin value = Emission Level – Limit value
4. Correction Factor = Insertion loss + Cable loss
5. Emission Level = Correction Factor + Reading Value

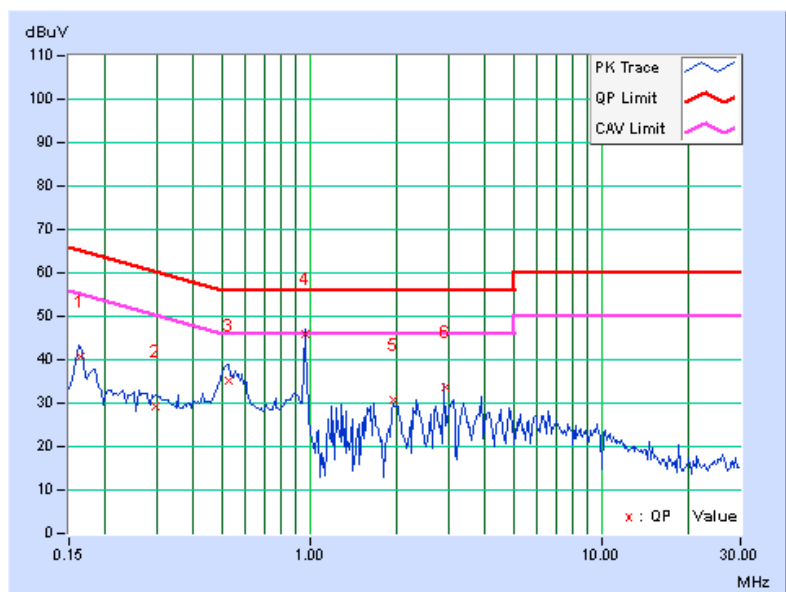

PHASE	Neutral (N)	DETECTOR FUNCTION	Quasi-Peak (QP) / Average (AV)
-------	-------------	-------------------	--------------------------------

No	Freq.	Corr.	Reading Value		Emission Level		Limit		Margin	
	[MHz]	(dB)	Q.P.	AV.	Q.P.	AV.	Q.P.	AV.	Q.P.	AV.
1	0.16562	0.07	39.39	38.91	39.46	38.98	65.18	55.18	-25.72	-16.20
2	0.30625	0.11	27.73	15.09	27.84	15.20	60.07	50.07	-32.23	-34.87
3	0.52109	0.15	34.54	24.30	34.69	24.45	56.00	46.00	-21.31	-21.55
4	0.97031	0.18	45.85	34.51	46.03	34.69	56.00	46.00	-9.97	-11.31
5	1.94234	0.23	30.95	22.57	31.18	22.80	56.00	46.00	-24.82	-23.20
6	2.91366	0.28	32.76	22.66	33.04	22.94	56.00	46.00	-22.96	-23.06

REMARKS:

1. Q.P. and AV. are abbreviations of quasi-peak and average individually.
2. The emission levels of other frequencies were very low against the limit.
3. Margin value = Emission Level – Limit value
4. Correction Factor = Insertion loss + Cable loss
5. Emission Level = Correction Factor + Reading Value

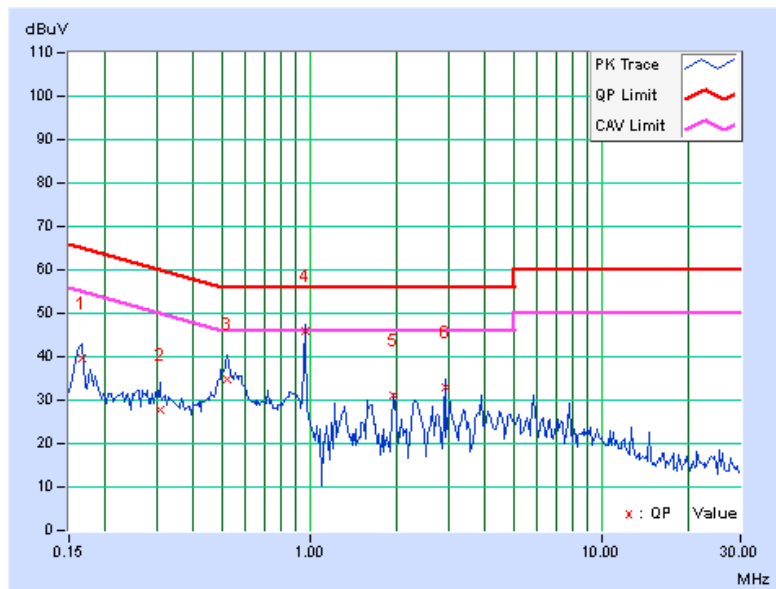



A D T

4.2 RADIATED EMISSION AND BANDEGE MEASUREMENT

4.2.1 LIMITS OF RADIATED EMISSION AND BANDEGE MEASUREMENT

Radiated emissions which fall in the restricted bands must comply with the radiated emission limits specified as below table. Other emissions shall be at least 20dB below the highest level of the desired power:

Frequencies (MHz)	Field strength (microvolts/meter)	Measurement distance (meters)
0.009-0.490	2400/F(kHz)	300
0.490-1.705	24000/F(kHz)	30
1.705-30.0	30	30
30-88	100	3
88-216	150	3
216-960	200	3
Above 960	500	3

NOTE:

1. The lower limit shall apply at the transition frequencies.
2. Emission level (dBuV/m) = 20 log Emission level (uV/m).
3. For frequencies above 1000MHz, the field strength limits are based on average detector, however, the peak field strength of any emission shall not exceed the maximum permitted average limits, specified above by more than 20dB.



A D T

4.2.2 TEST INSTRUMENTS

For MODE 1 below 1GHz test:

DESCRIPTION & MANUFACTURER	MODEL NO.	SERIAL NO.	CALIBRATED DATE	CALIBRATED UNTIL
MXE EMI Receiver Agilent	N9038A	MY51210105	Jan. 29, 2013	Jan. 28, 2014
Pre-Amplifier Mini-Circuits	ZFL-1000VH2 B	AMP-ZFL-03	Nov. 13, 2013	Nov. 12, 2014
Trilog Broadband Antenna SCHWARZBECK	VULB 9168	9168-360	Mar. 19, 2013	Mar. 18, 2014
RF Cable	NA	CHGCAB_001	Oct. 05, 2013	Oct. 04, 2014
Spectrum Analyzer R&S	FSV40	100964	July 15, 2013	July 14, 2014
Horn_Antenna AISI	AIH.8018	0000320091110	Nov. 18, 2013	Nov. 17, 2014
Pre-Amplifier Agilent	8449B	3008A02578	June 25, 2013	June 24, 2014
RF Cable	NA	RF104-201 RF104-203 RF104-204	Dec. 12, 2013	Dec. 11, 2014
Spectrum Analyzer Agilent	E4446A	MY48250253	Aug. 28, 2013	Aug. 27, 2014
Pre-Amplifier SPACEK LABS	SLKKa-48-6	9K16	Nov. 13, 2013	Nov. 12, 2014
Horn_Antenna SCHWARZBECK	BBHA 9170	9170-424	Oct. 08, 2013	Oct. 07, 2014
Software	ADT_Radiated _V8.7.07	NA	NA	NA
Antenna Tower & Turn Table CT	NA	NA	NA	NA

Note:

1. The calibration interval of the above test instruments is 12 months and the calibrations are traceable to NML/ROC and NIST/USA.
2. The horn antenna, preamplifier (model: 8449B) are used only for the measurement of emission frequency above 1GHz if tested.
- 3 The test was performed in 966 Chamber No. G.
4. The FCC Site Registration No. is 966073.
- 5 The VCCI Site Registration No. is G-137.
- 6 The CANADA Site Registration No. is IC 7450H-2.
- 7 Tested Date: Jan. 15, 2014



A D T

For MODE 2 below 1GHz test:

DESCRIPTION & MANUFACTURER	MODEL NO.	SERIAL NO.	CALIBRATED DATE	CALIBRATED UNTIL
MXE EMI Receiver Agilent	N9038A	MY51210105	Jan. 21, 2014	Jan. 20, 2015
Pre-Amplifier Mini-Circuits	ZFL-1000VH2 B	AMP-ZFL-03	Nov. 13, 2013	Nov. 12, 2014
Trilog Broadband Antenna SCHWARZBECK	VULB 9168	9168-360	Feb. 26, 2014	Feb. 25, 2015
RF Cable	NA	CHGCAB_001	Oct. 05, 2013	Oct. 04, 2014
Spectrum Analyzer R&S	FSV40	100964	July 15, 2013	July 14, 2014
Horn_Antenna AISI	AIH.8018	0000320091110	Nov. 18, 2013	Nov. 17, 2014
Pre-Amplifier Agilent	8449B	3008A02578	June 25, 2013	June 24, 2014
RF Cable	NA	RF104-201 RF104-203 RF104-204	Dec. 12, 2013	Dec. 11, 2014
Spectrum Analyzer Agilent	E4446A	MY48250253	Aug. 28, 2013	Aug. 27, 2014
Pre-Amplifier SPACEK LABS	SLKKa-48-6	9K16	Nov. 13, 2013	Nov. 12, 2014
Horn_Antenna SCHWARZBECK	BBHA 9170	9170-424	Oct. 08, 2013	Oct. 07, 2014
Software	ADT_Radiated _V8.7.07	NA	NA	NA
Antenna Tower & Turn Table CT	NA	NA	NA	NA

Note:

1. The calibration interval of the above test instruments is 12 months and the calibrations are traceable to NML/ROC and NIST/USA.
2. The horn antenna, preamplifier (model: 8449B) are used only for the measurement of emission frequency above 1GHz if tested.
- 3 The test was performed in 966 Chamber No. G.
4. The FCC Site Registration No. is 966073.
- 5 The VCCI Site Registration No. is G-137.
- 6 The CANADA Site Registration No. is IC 7450H-2.
- 7 Tested Date: Apr. 03, 2014



A D T

For above 1GHz test:

DESCRIPTION & MANUFACTURER	MODEL NO.	SERIAL NO.	CALIBRATED DATE	CALIBRATED UNTIL
MXE EMI Receiver Agilent	N9038A	MY51210105	Jan. 21, 2014	Jan. 20, 2015
Pre-Amplifier Mini-Circuits	ZFL-1000VH2 B	AMP-ZFL-03	Nov. 13, 2013	Nov. 12, 2014
Trilog Broadband Antenna SCHWARZBECK	VULB 9168	9168-360	Feb. 26, 2014	Feb. 25, 2015
RF Cable	NA	CHGCAB_001	Oct. 05, 2013	Oct. 04, 2014
Spectrum Analyzer R&S	FSV40	100964	July 15, 2013	July 14, 2014
Horn_Antenna AISI	AIH.8018	0000320091110	Nov. 18, 2013	Nov. 17, 2014
Pre-Amplifier Agilent	8449B	3008A02578	June 25, 2013	June 24, 2014
RF Cable	NA	RF104-201 RF104-203 RF104-204	Dec. 12, 2013	Dec. 11, 2014
Spectrum Analyzer Agilent	E4446A	MY48250253	Aug. 28, 2013	Aug. 27, 2014
Pre-Amplifier SPACEK LABS	SLKKa-48-6	9K16	Nov. 13, 2013	Nov. 12, 2014
Horn_Antenna SCHWARZBECK	BBHA 9170	9170-424	Oct. 08, 2013	Oct. 07, 2014
Software	ADT_Radiated _V8.7.07	NA	NA	NA
Antenna Tower & Turn Table CT	NA	NA	NA	NA

Note:

1. The calibration interval of the above test instruments is 12 months and the calibrations are traceable to NML/ROC and NIST/USA.
2. The horn antenna, preamplifier (model: 8449B) are used only for the measurement of emission frequency above 1GHz if tested.
- 3 The test was performed in 966 Chamber No. G.
4. The FCC Site Registration No. is 966073.
- 5 The VCCI Site Registration No. is G-137.
- 6 The CANADA Site Registration No. is IC 7450H-2.
- 7 Tested Date: May 07, 2014

4.2.3 TEST PROCEDURES

- a. The EUT was placed on the top of a rotating table 0.8 meters above the ground at 3 meter chamber room for test. The table was rotated 360 degrees to determine the position of the highest radiation.
- b. The EUT was set 3 meters away from the interference-receiving antenna, which was mounted on the top of a variable-height antenna tower.
- c. The height of antenna is varied from one meter to four meters above the ground to determine the maximum value of the field strength. Both horizontal and vertical polarizations of the antenna are set to make the measurement.
- d. For each suspected emission, the EUT was arranged to its worst case and then the antenna was tuned to heights from 1 meter to 4 meters and the rotatable table was turned from 0 degrees to 360 degrees to find the maximum reading.
- e. The test-receiver system was set to quasi-peak detect function and specified bandwidth with maximum hold mode when the test frequency is below 1 GHz.
- f. The test-receiver system was set to peak detect function and specified bandwidth with maximum hold mode when the test frequency is above 1 GHz.

Note:

1. The resolution bandwidth and video bandwidth of test receiver/spectrum analyzer is 120kHz for Quasi-peak detection (QP) at frequency below 1GHz.
2. The resolution bandwidth of test receiver/spectrum analyzer is 1 MHz and the video bandwidth is 3 MHz for Peak detection (PK) at frequency above 1GHz.
3. For the test signal duty cycle is 100%, the resolution bandwidth of test receiver/spectrum analyzer is 1MHz and the video bandwidth is 10Hz for Average detection (AV) at frequency above 1GHz.
4. Emission AV = Emission AV Reading(Test signal is continuous wave (Duty cycle 100%), Measured by 1MHz/10Hz) + AV Factor
AV Factor = $20 \log(\text{max.duty cycle}) = 20 \log(66\%) = -3.6\text{dB}$

4.2.4 DEVIATION FROM TEST STANDARD

No deviation

4.2.5 TEST SETUP

<Frequency Range below 1GHz>

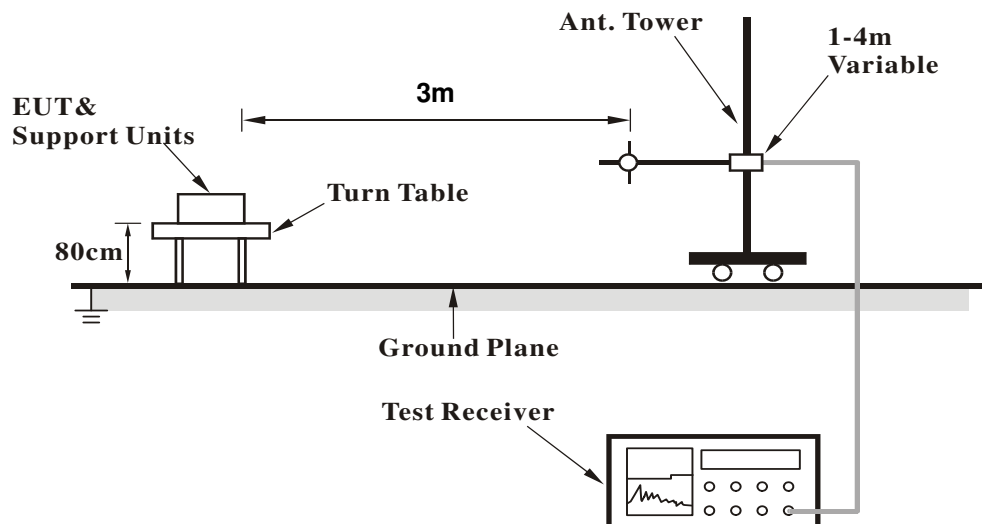

<Frequency Range above 1GHz>

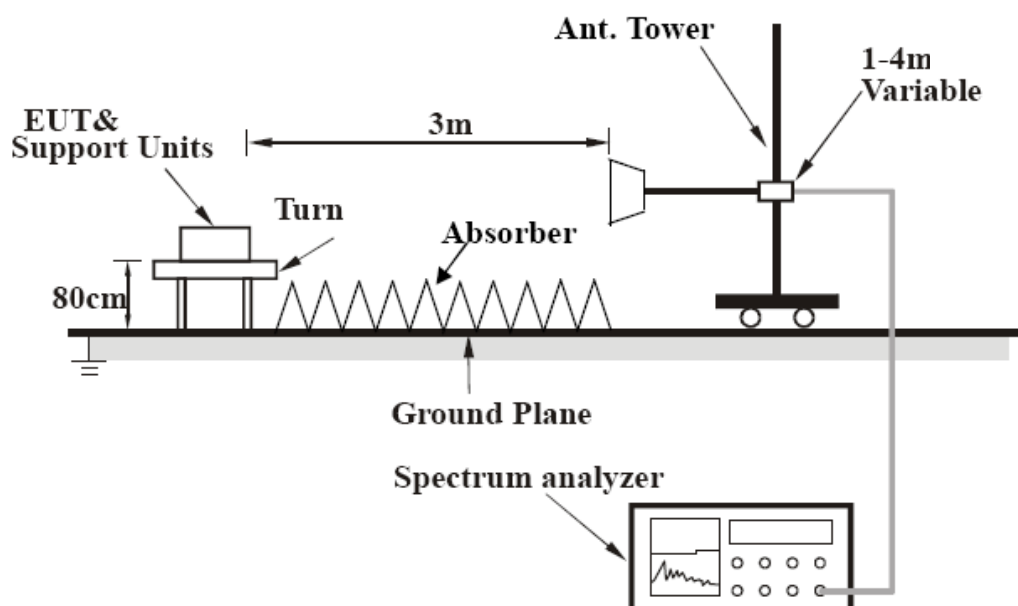

For the actual test configuration, please refer to the related item – Photographs of the Test Configuration.

4.2.6 EUT OPERATING CONDITIONS

Same as 4.1.6

4.2.7 TEST RESULTS (MODE 1)

BELOW 1GHz WORST-CASE DATA

CHANNEL	TX Channel 11	DETECTOR FUNCTION	Quasi-Peak (QP)
FREQUENCY RANGE	Below 1GHz		

ANTENNA POLARITY & TEST DISTANCE: HORIZONTAL AT 3 M

NO.	FREQ. (MHz)	EMISSION LEVEL (dBuV/m)	LIMIT (dBuV/m)	MARGIN (dB)	ANTENNA HEIGHT (m)	TABLE ANGLE (Degree)	RAW VALUE (dBuV)	CORRECTION FACTOR (dB/m)
1	141.10	28.0 QP	43.5	-15.5	1.50 H	61	41.60	-13.60
2	221.12	22.4 QP	46.0	-23.6	1.23 H	245	38.50	-16.10
3	600.24	36.1 QP	46.0	-9.9	1.45 H	245	41.10	-5.00
4	765.24	34.3 QP	46.0	-11.7	1.45 H	57	36.00	-1.70
5	841.10	41.8 QP	46.0	-4.2	1.75 H	98	42.70	-0.90
6	921.12	34.4 QP	46.0	-11.6	1.42 H	65	33.70	0.70

ANTENNA POLARITY & TEST DISTANCE: VERTICAL AT 3 M

NO.	FREQ. (MHz)	EMISSION LEVEL (dBuV/m)	LIMIT (dBuV/m)	MARGIN (dB)	ANTENNA HEIGHT (m)	TABLE ANGLE (Degree)	RAW VALUE (dBuV)	CORRECTION FACTOR (dB/m)
1	103.21	33.8 QP	43.5	-9.7	1.50 V	71	51.20	-17.40
2	114.51	37.1 QP	43.5	-6.4	1.50 V	69	53.10	-16.00
3	133.11	36.4 QP	43.5	-7.1	1.50 V	67	50.50	-14.10
4	208.72	29.6 QP	43.5	-13.9	1.50 V	71	46.10	-16.50
5	600.11	37.1 QP	46.0	-8.9	1.00 V	301	42.10	-5.00
6	839.75	42.4 QP	46.0	-3.6	1.50 V	12	43.40	-1.00

REMARKS:

1. Emission Level(dBuV/m) = Raw Value(dBuV) + Correction Factor(dB/m)
2. Correction Factor(dB/m) = Antenna Factor(dB/m) + Cable Factor(dB) – Pre-Amplifier Factor(dB)
3. The other emission levels were very low against the limit.
4. Margin value = Emission Level – Limit value



A D T

ABOVE 1GHz DATA

CHANNEL	TX Channel 11	DETECTOR FUNCTION	Peak (PK)
FREQUENCY RANGE	1GHz ~ 25GHz		Average (AV)

ANTENNA POLARITY & TEST DISTANCE: HORIZONTAL AT 3 M

NO.	FREQ. (MHz)	EMISSION LEVEL (dBuV/m)	LIMIT (dBuV/m)	MARGIN (dB)	ANTENNA HEIGHT (m)	TABLE ANGLE (Degree)	RAW VALUE (dBuV)	CORRECTION FACTOR (dB/m)
1	2390.00	60.8 PK	74.0	-13.2	1.24 H	360	62.50	-1.70
2	2390.00	47.3 AV	54.0	-6.7	1.24 H	360	49.00	-1.70
3	*2405.00	118.8 PK			1.24 H	360	120.44	-1.64
4	*2405.00	110.8 AV			1.24 H	360	112.44	-1.64
5	4810.00	61.9 PK	74.0	-12.1	1.14 H	255	54.74	7.16
6	4810.00	47.1 AV	54.0	-6.9	1.14 H	255	39.94	7.16

ANTENNA POLARITY & TEST DISTANCE: VERTICAL AT 3 M

NO.	FREQ. (MHz)	EMISSION LEVEL (dBuV/m)	LIMIT (dBuV/m)	MARGIN (dB)	ANTENNA HEIGHT (m)	TABLE ANGLE (Degree)	RAW VALUE (dBuV)	CORRECTION FACTOR (dB/m)
1	2390.00	57.2 PK	74.0	-16.8	1.05 V	274	58.90	-1.70
2	2390.00	43.1 AV	54.0	-10.9	1.05 V	274	44.80	-1.70
3	*2405.00	115.0 PK			1.05 V	274	116.64	-1.64
4	*2405.00	106.8 AV			1.05 V	274	108.44	-1.64
5	4810.00	62.1 PK	74.0	-11.9	1.00 V	170	54.94	7.16
6	4810.00	48.3 AV	54.0	-5.7	1.00 V	170	41.14	7.16

REMARKS:

1. Emission Level(dBuV/m) = Raw Value(dBuV) + Correction Factor(dB/m)
2. Correction Factor(dB/m) = Antenna Factor(dB/m) + Cable Factor(dB) – Pre-Amplifier Factor(dB)
3. The other emission levels were very low against the limit.
4. Margin value = Emission Level – Limit value
5. " * ": Fundamental frequency.



A D T

CHANNEL	TX Channel 18	DETECTOR FUNCTION	Peak (PK)
FREQUENCY RANGE	1GHz ~ 25GHz		Average (AV)

ANTENNA POLARITY & TEST DISTANCE: HORIZONTAL AT 3 M

NO.	FREQ. (MHz)	EMISSION LEVEL (dBuV/m)	LIMIT (dBuV/m)	MARGIN (dB)	ANTENNA HEIGHT (m)	TABLE ANGLE (Degree)	RAW VALUE (dBuV)	CORRECTION FACTOR (dB/m)
1	2390.00	47.7 PK	74.0	-26.3	1.20 H	360	49.40	-1.70
2	2390.00	30.6 AV	54.0	-23.4	1.20 H	360	32.30	-1.70
3	*2440.00	114.8 PK			1.20 H	360	116.28	-1.48
4	*2440.00	107.2 AV			1.20 H	360	108.68	-1.48
5	2483.50	48.9 PK	74.0	-25.1	1.20 H	360	50.18	-1.28
6	2483.50	31.7 AV	54.0	-22.3	1.20 H	360	32.98	-1.28
7	4880.00	58.2 PK	74.0	-15.8	1.10 H	279	50.85	7.35
8	4880.00	42.2 AV	54.0	-11.8	1.10 H	279	34.85	7.35
9	7320.00	63.2 PK	74.0	-10.8	1.53 H	114	48.24	14.96
10	7320.00	47.0 AV	54.0	-7.0	1.53 H	114	32.04	14.96

ANTENNA POLARITY & TEST DISTANCE: VERTICAL AT 3 M

NO.	FREQ. (MHz)	EMISSION LEVEL (dBuV/m)	LIMIT (dBuV/m)	MARGIN (dB)	ANTENNA HEIGHT (m)	TABLE ANGLE (Degree)	RAW VALUE (dBuV)	CORRECTION FACTOR (dB/m)
1	2390.00	47.8 PK	74.0	-26.2	1.05 V	277	49.50	-1.70
2	2390.00	30.5 AV	54.0	-23.5	1.05 V	277	32.20	-1.70
3	*2440.00	111.1 PK			1.05 V	277	112.58	-1.48
4	*2440.00	102.6 AV			1.05 V	277	104.08	-1.48
5	2483.50	48.6 PK	74.0	-25.4	1.05 V	277	49.88	-1.28
6	2483.50	31.5 AV	54.0	-22.5	1.05 V	277	32.78	-1.28
7	4880.00	59.0 PK	74.0	-15.0	1.00 V	174	51.65	7.35
8	4880.00	44.2 AV	54.0	-9.8	1.00 V	174	36.85	7.35
9	7320.00	63.6 PK	74.0	-10.4	1.00 V	141	48.64	14.96
10	7320.00	48.1 AV	54.0	-5.9	1.00 V	141	33.14	14.96

REMARKS:

1. Emission Level(dBuV/m) = Raw Value(dBuV) + Correction Factor(dB/m)
2. Correction Factor(dB/m) = Antenna Factor(dB/m) + Cable Factor(dB) – Pre-Amplifier Factor(dB)
3. The other emission levels were very low against the limit.
4. Margin value = Emission Level – Limit value
5. " * ": Fundamental frequency.



A D T

CHANNEL	TX Channel 25	DETECTOR FUNCTION	Peak (PK)
FREQUENCY RANGE	1GHz ~ 25GHz		Average (AV)

ANTENNA POLARITY & TEST DISTANCE: HORIZONTAL AT 3 M

NO.	FREQ. (MHz)	EMISSION LEVEL (dBuV/m)	LIMIT (dBuV/m)	MARGIN (dB)	ANTENNA HEIGHT (m)	TABLE ANGLE (Degree)	RAW VALUE (dBuV)	CORRECTION FACTOR (dB/m)
1	*2475.00	111.9 PK			1.18 H	359	113.22	-1.32
2	*2475.00	104.3 AV			1.18 H	359	105.62	-1.32
3	2483.50	63.5 PK	74.0	-10.5	1.18 H	359	64.78	-1.28
4	2483.50	49.3 AV	54.0	-4.7	1.18 H	359	50.58	-1.28
5	4950.00	54.6 PK	74.0	-19.4	1.16 H	333	47.06	7.54
6	4950.00	39.7 AV	54.0	-14.3	1.16 H	333	32.16	7.54
7	7425.00	58.1 PK	74.0	-15.9	1.06 H	315	43.22	14.88
8	7425.00	41.6 AV	54.0	-12.4	1.06 H	315	26.72	14.88

ANTENNA POLARITY & TEST DISTANCE: VERTICAL AT 3 M

NO.	FREQ. (MHz)	EMISSION LEVEL (dBuV/m)	LIMIT (dBuV/m)	MARGIN (dB)	ANTENNA HEIGHT (m)	TABLE ANGLE (Degree)	RAW VALUE (dBuV)	CORRECTION FACTOR (dB/m)
1	*2475.00	107.6 PK			1.01 V	273	108.92	-1.32
2	*2475.00	100.2 AV			1.01 V	273	101.52	-1.32
3	2483.50	59.7 PK	74.0	-14.3	1.01 V	273	60.98	-1.28
4	2483.50	45.0 AV	54.0	-9.0	1.01 V	273	46.28	-1.28
5	4950.00	53.9 PK	74.0	-20.1	1.16 V	333	46.36	7.54
6	4950.00	39.6 AV	54.0	-14.4	1.16 V	333	32.06	7.54
7	7425.00	57.5 PK	74.0	-16.5	1.00 V	155	42.62	14.88
8	7425.00	43.1 AV	54.0	-10.9	1.00 V	155	28.22	14.88

REMARKS:

1. Emission Level(dBuV/m) = Raw Value(dBuV) + Correction Factor(dB/m)
2. Correction Factor(dB/m) = Antenna Factor(dB/m) + Cable Factor(dB) – Pre-Amplifier Factor(dB)
3. The other emission levels were very low against the limit.
4. Margin value = Emission Level – Limit value
5. " * ": Fundamental frequency.

4.2.8 TEST RESULTS (MODE 2)

BELOW 1GHz WORST-CASE DATA

CHANNEL	TX Channel 11	DETECTOR FUNCTION	Quasi-Peak (QP)
FREQUENCY RANGE	Below 1GHz		

ANTENNA POLARITY & TEST DISTANCE: HORIZONTAL AT 3 M								
NO.	FREQ. (MHz)	EMISSION LEVEL (dBuV/m)	LIMIT (dBuV/m)	MARGIN (dB)	ANTENNA HEIGHT (m)	TABLE ANGLE (Degree)	RAW VALUE (dBuV)	CORRECTION FACTOR (dB/m)
1	142.01	29.5 QP	43.5	-14.0	1.24 H	110	43.05	-13.51
2	222.33	24.2 QP	46.0	-21.8	1.45 H	301	40.36	-16.15
3	600.35	36.2 QP	46.0	-9.8	1.22 H	301	41.29	-5.08
4	765.47	35.6 QP	46.0	-10.4	1.23 H	85	37.35	-1.73
5	841.24	42.0 QP	46.0	-4.1	1.65 H	124	42.86	-0.91
6	921.31	34.2 QP	46.0	-11.8	1.24 H	102	33.60	0.61
ANTENNA POLARITY & TEST DISTANCE: VERTICAL AT 3 M								
NO.	FREQ. (MHz)	EMISSION LEVEL (dBuV/m)	LIMIT (dBuV/m)	MARGIN (dB)	ANTENNA HEIGHT (m)	TABLE ANGLE (Degree)	RAW VALUE (dBuV)	CORRECTION FACTOR (dB/m)
1	104.11	34.0 QP	43.5	-9.5	1.24 V	95	51.25	-17.24
2	114.85	38.2 QP	43.5	-5.3	1.44 V	101	54.05	-15.84
3	133.42	36.7 QP	43.5	-6.9	1.68 V	105	50.79	-14.14
4	208.91	30.0 QP	43.5	-13.6	1.24 V	102	46.46	-16.51
5	600.01	37.0 QP	46.0	-9.0	1.42 V	35	42.11	-5.10
6	839.89	42.2 QP	46.0	-3.8	1.75 V	96	43.14	-0.93

REMARKS:

1. Emission Level(dBuV/m) = Raw Value(dBuV) + Correction Factor(dB/m)
2. Correction Factor(dB/m) = Antenna Factor(dB/m) + Cable Factor(dB) – Pre-Amplifier Factor(dB)
3. The other emission levels were very low against the limit.
4. Margin value = Emission Level – Limit value



A D T

ABOVE 1GHz DATA

CHANNEL	TX Channel 11	DETECTOR FUNCTION	Peak (PK)
FREQUENCY RANGE	1GHz ~ 25GHz		Average (AV)

ANTENNA POLARITY & TEST DISTANCE: HORIZONTAL AT 3 M

NO.	FREQ. (MHz)	EMISSION LEVEL (dBuV/m)	LIMIT (dBuV/m)	MARGIN (dB)	ANTENNA HEIGHT (m)	TABLE ANGLE (Degree)	RAW VALUE (dBuV)	CORRECTION FACTOR (dB/m)
1	2390.00	60.6 PK	74.0	-13.4	1.23 H	360	62.30	-1.70
2	2390.00	47.3 AV	54.0	-6.7	1.23 H	360	49.00	-1.70
3	*2405.00	118.7 PK			1.27 H	348	120.34	-1.64
4	*2405.00	110.8 AV			1.27 H	348	112.44	-1.64
5	4810.00	61.9 PK	74.0	-12.1	1.17 H	256	54.74	7.16
6	4810.00	46.9 AV	54.0	-7.1	1.17 H	256	39.74	7.16

ANTENNA POLARITY & TEST DISTANCE: VERTICAL AT 3 M

NO.	FREQ. (MHz)	EMISSION LEVEL (dBuV/m)	LIMIT (dBuV/m)	MARGIN (dB)	ANTENNA HEIGHT (m)	TABLE ANGLE (Degree)	RAW VALUE (dBuV)	CORRECTION FACTOR (dB/m)
1	2390.00	57.6 PK	74.0	-16.4	1.06 V	282	59.30	-1.70
2	2390.00	43.2 AV	54.0	-10.8	1.06 V	282	44.90	-1.70
3	*2405.00	115.1 PK			1.02 V	288	116.74	-1.64
4	*2405.00	107.2 AV			1.02 V	288	108.84	-1.64
5	4810.00	61.9 PK	74.0	-12.1	1.00 V	173	54.74	7.16
6	4810.00	48.3 AV	54.0	-5.7	1.00 V	173	41.14	7.16

REMARKS:

1. Emission Level(dBuV/m) = Raw Value(dBuV) + Correction Factor(dB/m)
2. Correction Factor(dB/m) = Antenna Factor(dB/m) + Cable Factor(dB) – Pre-Amplifier Factor(dB)
3. The other emission levels were very low against the limit.
4. Margin value = Emission Level – Limit value
5. " * ": Fundamental frequency.



A D T

CHANNEL	TX Channel 18	DETECTOR FUNCTION	Peak (PK)
FREQUENCY RANGE	1GHz ~ 25GHz		Average (AV)

ANTENNA POLARITY & TEST DISTANCE: HORIZONTAL AT 3 M

NO.	FREQ. (MHz)	EMISSION LEVEL (dBuV/m)	LIMIT (dBuV/m)	MARGIN (dB)	ANTENNA HEIGHT (m)	TABLE ANGLE (Degree)	RAW VALUE (dBuV)	CORRECTION FACTOR (dB/m)
1	2390.00	47.4 PK	74.0	-26.6	1.16 H	351	49.10	-1.70
2	2390.00	30.1 AV	54.0	-23.9	1.16 H	351	31.80	-1.70
3	*2440.00	114.6 PK			1.21 H	360	116.08	-1.48
4	*2440.00	107.0 AV			1.21 H	360	108.48	-1.48
5	2483.50	49.0 PK	74.0	-25.0	1.23 H	360	50.28	-1.28
6	2483.50	31.7 AV	54.0	-22.3	1.23 H	360	32.98	-1.28
7	4880.00	58.2 PK	74.0	-15.8	1.14 H	267	50.85	7.35
8	4880.00	42.1 AV	54.0	-11.9	1.14 H	267	34.75	7.35
9	7320.00	62.6 PK	74.0	-11.4	1.47 H	130	47.64	14.96
10	7320.00	46.5 AV	54.0	-7.5	1.47 H	130	31.54	14.96

ANTENNA POLARITY & TEST DISTANCE: VERTICAL AT 3 M

NO.	FREQ. (MHz)	EMISSION LEVEL (dBuV/m)	LIMIT (dBuV/m)	MARGIN (dB)	ANTENNA HEIGHT (m)	TABLE ANGLE (Degree)	RAW VALUE (dBuV)	CORRECTION FACTOR (dB/m)
1	2390.00	47.4 PK	74.0	-26.6	1.00 V	291	49.10	-1.70
2	2390.00	30.3 AV	54.0	-23.7	1.00 V	291	32.00	-1.70
3	*2440.00	111.3 PK			1.04 V	284	112.78	-1.48
4	*2440.00	102.5 AV			1.04 V	284	103.98	-1.48
5	2483.50	48.5 PK	74.0	-25.5	1.01 V	291	49.78	-1.28
6	2483.50	31.2 AV	54.0	-22.8	1.01 V	291	32.48	-1.28
7	4880.00	59.0 PK	74.0	-15.0	1.06 V	182	51.65	7.35
8	4880.00	44.4 AV	54.0	-9.6	1.06 V	182	37.05	7.35
9	7320.00	63.3 PK	74.0	-10.7	1.00 V	134	48.34	14.96
10	7320.00	47.9 AV	54.0	-6.1	1.00 V	134	32.94	14.96

REMARKS:

1. Emission Level(dBuV/m) = Raw Value(dBuV) + Correction Factor(dB/m)
2. Correction Factor(dB/m) = Antenna Factor(dB/m) + Cable Factor(dB) – Pre-Amplifier Factor(dB)
3. The other emission levels were very low against the limit.
4. Margin value = Emission Level – Limit value
5. " * ": Fundamental frequency.



A D T

CHANNEL	TX Channel 25	DETECTOR FUNCTION	Peak (PK)
FREQUENCY RANGE	1GHz ~ 25GHz		Average (AV)

ANTENNA POLARITY & TEST DISTANCE: HORIZONTAL AT 3 M

NO.	FREQ. (MHz)	EMISSION LEVEL (dBuV/m)	LIMIT (dBuV/m)	MARGIN (dB)	ANTENNA HEIGHT (m)	TABLE ANGLE (Degree)	RAW VALUE (dBuV)	CORRECTION FACTOR (dB/m)
1	*2475.00	112.1 PK			1.17 H	348	113.42	-1.32
2	*2475.00	104.7 AV			1.17 H	348	106.02	-1.32
3	2483.50	63.5 PK	74.0	-10.5	1.15 H	347	64.78	-1.28
4	2483.50	49.4 AV	54.0	-4.6	1.15 H	347	50.68	-1.28
5	4950.00	54.6 PK	74.0	-19.4	1.19 H	319	47.06	7.54
6	4950.00	39.5 AV	54.0	-14.5	1.19 H	319	31.96	7.54
7	7425.00	57.8 PK	74.0	-16.2	1.03 H	317	42.92	14.88
8	7425.00	41.4 AV	54.0	-12.6	1.03 H	317	26.52	14.88

ANTENNA POLARITY & TEST DISTANCE: VERTICAL AT 3 M

NO.	FREQ. (MHz)	EMISSION LEVEL (dBuV/m)	LIMIT (dBuV/m)	MARGIN (dB)	ANTENNA HEIGHT (m)	TABLE ANGLE (Degree)	RAW VALUE (dBuV)	CORRECTION FACTOR (dB/m)
1	*2475.00	107.6 PK			1.03 V	287	108.92	-1.32
2	*2475.00	100.0 AV			1.03 V	287	101.32	-1.32
3	2483.50	59.4 PK	74.0	-14.6	1.01 V	278	60.68	-1.28
4	2483.50	44.7 AV	54.0	-9.3	1.01 V	278	45.98	-1.28
5	4950.00	53.7 PK	74.0	-20.3	1.14 V	331	46.16	7.54
6	4950.00	39.3 AV	54.0	-14.7	1.14 V	331	31.76	7.54
7	7425.00	56.9 PK	74.0	-17.1	1.00 V	164	42.02	14.88
8	7425.00	42.6 AV	54.0	-11.4	1.00 V	164	27.72	14.88

REMARKS:

1. Emission Level(dBuV/m) = Raw Value(dBuV) + Correction Factor(dB/m)
2. Correction Factor(dB/m) = Antenna Factor(dB/m) + Cable Factor(dB) – Pre-Amplifier Factor(dB)
3. The other emission levels were very low against the limit.
4. Margin value = Emission Level – Limit value
5. " * ": Fundamental frequency.

4.3 6dB BANDWIDTH MEASUREMENT

4.3.1 LIMITS OF 6dB BANDWIDTH MEASUREMENT

The minimum of 6dB Bandwidth Measurement is 0.5 MHz.

4.3.2 TEST INSTRUMENTS

DESCRIPTION & MANUFACTURER	MODEL NO.	SERIAL NO.	CALIBRATED DATE	CALIBRATED UNTIL
SPECTRUM ANALYZER R&S	FSV 40	100964	July 15, 2013	July 14, 2014

Note:

1. The calibration interval of the above test instruments is 12 months and the calibrations are traceable to NML/ROC and NIST/USA.
2. Tested date : May 02, 2014

4.3.3 TEST PROCEDURE

1. Set resolution bandwidth (RBW) = 100kHz
2. Set the video bandwidth (VBW) $\geq 3 \times$ RBW, Detector = Peak.
3. Trace mode = max hold.
4. Sweep = auto couple.
5. Measure the maximum width of the emission that is constrained by the frequencies associated with the two amplitude points (upper and lower) that are attenuated by 6 dB relative to the maximum level measured in the fundamental emission

4.3.4 DEVIATION FROM TEST STANDARD

No deviation

4.3.5 TEST SETUP

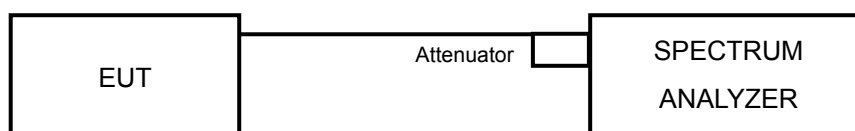

4.3.6 EUT OPERATING CONDITIONS

The software provided by client to enable the EUT under transmission condition continuously at lowest, middle and highest channel frequencies individually.

4.3.7 TEST RESULTS

CHANNEL	FREQUENCY (MHz)	6dB BANDWIDTH (MHz)	MINIMUM LIMIT (MHz)	PASS / FAIL
11	2405	1.61	0.5	PASS
18	2440	1.60	0.5	PASS
25	2475	1.59	0.5	PASS

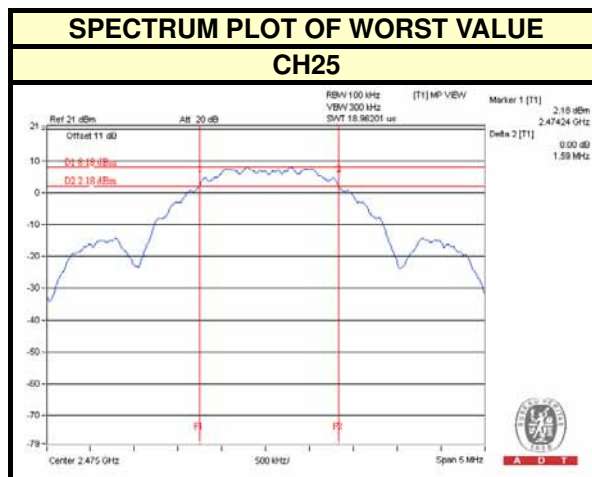



A D T

4.4 CONDUCTED OUTPUT POWER MEASUREMENT

4.4.1 LIMITS OF MAXIMUM PEAK OUTPUT POWER MEASUREMENT

For systems using digital modulation in the 2400–2483.5 MHz bands: 1 Watt (30dBm)

4.4.2 TEST INSTRUMENTS

DESCRIPTION & MANUFACTURER	MODEL NO.	SERIAL NO.	CALIBRATED DATE	CALIBRATED UNTIL
Power Meter	ML2495A	1014008	Apr. 30, 2014	Apr. 29, 2015
Power Sensor	MA2411B	0917122	Apr. 30, 2014	Apr. 29, 2015

Note:

1. The calibration interval of the above test instruments is 12 months and the calibrations are traceable to NML/ROC and NIST/USA.
2. Tested date : May 02, 2014

4.4.3 TEST PROCEDURES

The peak power sensor was used on the output port of the EUT. A power meter was used to read the response of the peak power sensor. Record the peak power level.

4.4.4 DEVIATION FROM TEST STANDARD

No deviation.

4.4.5 TEST SETUP

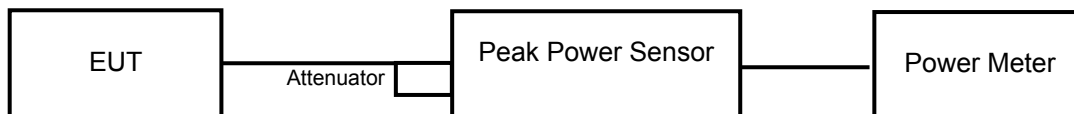

4.4.6 EUT OPERATING CONDITIONS

Same as Item 4.3.6

4.4.7 TEST RESULTS

CHANNEL	FREQUENCY (MHz)	PEAK POWER (mW)	PEAK POWER (dBm)	LIMIT (dBm)	PASS/FAIL
11	2405	95.719	19.81	30	PASS
18	2440	25.823	14.12	30	PASS
25	2475	18.030	12.56	30	PASS

4.5 AVERAGE OUTPUT POWER

4.5.1 LIMITS OF AVERAGE OUTPUT POWER MEASUREMENT

Average output power is for reference only.

4.5.2 TEST INSTRUMENTS

DESCRIPTION & MANUFACTURER	MODEL NO.	SERIAL NO.	CALIBRATED DATE	CALIBRATED UNTIL
Power Meter	ML2495A	1014008	Apr. 30, 2014	Apr. 29, 2015
Power Sensor	MA2411B	0917122	Apr. 30, 2014	Apr. 29, 2015

Note:

1. The calibration interval of the above test instruments is 12 months and the calibrations are traceable to NML/ROC and NIST/USA.
2. Tested date : May 02, 2014

4.5.3 TEST PROCEDURES

Method PM is used to perform output power measurement, trigger and gating function of wide band power meter is enabled to measure max output power of TX on burst. Duty factor is not added to measured value.

4.5.4 TEST SETUP

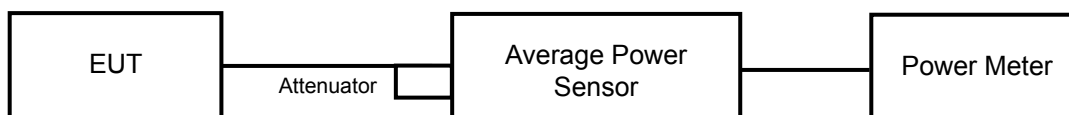

4.5.5 EUT OPERATING CONDITIONS

Same as Item 4.3.6



A D T

4.5.6 TEST RESULTS

CHANNEL	FREQUENCY (MHz)	AVERAGE POWER (mW)	AVERAGE POWER (dBm)
11	2405	93.972	19.73
18	2440	25.177	14.01
25	2475	17.539	12.44

4.6 POWER SPECTRAL DENSITY MEASUREMENT

4.6.1 LIMITS OF POWER SPECTRAL DENSITY MEASUREMENT

The Maximum of Power Spectral Density Measurement is 8dBm.

4.6.2 TEST INSTRUMENTS

DESCRIPTION & MANUFACTURER	MODEL NO.	SERIAL NO.	CALIBRATED DATE	CALIBRATED UNTIL
SPECTRUM ANALYZER R&S	FSV 40	100964	July 15, 2013	July 14, 2014

Note:

1. The calibration interval of the above test instruments is 12 months and the calibrations are traceable to NML/ROC and NIST/USA.
2. Tested date : May 02, 2014

4.6.3 TEST PROCEDURE

1. Set the RBW = 3 kHz, VBW =10 kHz, Detector = peak.
2. Sweep time = auto couple, Trace mode = max hold, allow trace to fully stabilize.
3. Use the peak marker function to determine the maximum amplitude level.

4.6.4 DEVIATION FROM TEST STANDARD

No deviation

4.6.5 TEST SETUP

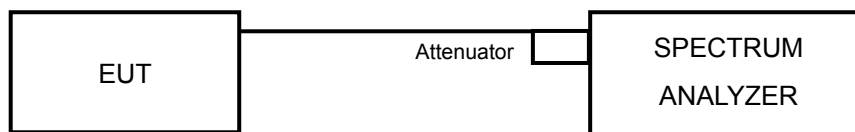

4.6.6 EUT OPERATING CONDITION

Same as Item 4.3.6

4.6.7 TEST RESULTS

Channel	FREQUENCY (MHz)	PSD (dBm)	Limit (dBm)	PASS /FAIL
11	2405	4.78	8	PASS
18	2440	-1.30	8	PASS
25	2475	-3.62	8	PASS

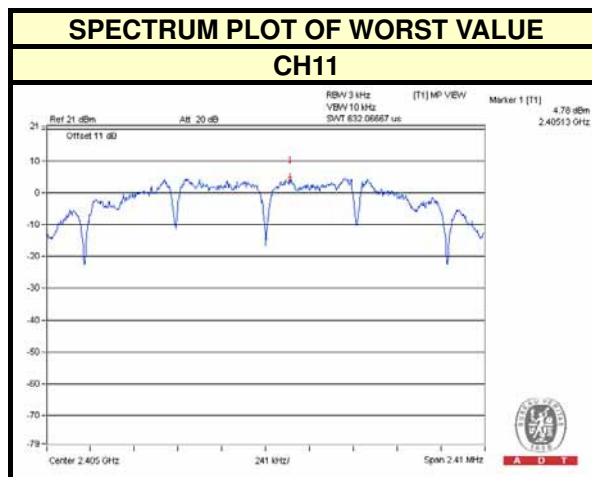



A D T

4.7 CONDUCTED OUT-BAND EMISSION MEASUREMENT

4.7.1 LIMITS OF CONDUCTED OUT-BAND EMISSION MEASUREMENT

Below 20dB of the highest emission level of operating band (in 100kHz Resolution Bandwidth).

4.7.2 TEST INSTRUMENTS

DESCRIPTION & MANUFACTURER	MODEL NO.	SERIAL NO.	CALIBRATED DATE	CALIBRATED UNTIL
SPECTRUM ANALYZER R&S	FSV 40	100964	July 15, 2013	July 14, 2014

Note:

1. The calibration interval of the above test instruments is 12 months and the calibrations are traceable to NML/ROC and NIST/USA.
2. Tested date : May 02, 2014

4.7.3 TEST PROCEDURE

Measurement Procedure - Reference Level

1. Set the RBW = 100 kHz.
2. Set the VBW \geq 300 kHz.
3. Detector = peak.
4. Sweep time = auto couple.
5. Trace mode = max hold.
6. Allow trace to fully stabilize.
7. Use the peak marker function to determine the maximum power level in any 100 kHz band segment within the fundamental EBW.

Measurement Procedure –Unwanted Emission Level

1. Set RBW = 100 kHz.
2. Set VBW \geq 300 kHz.
3. Set span to encompass the spectrum to be examined
4. Detector = peak.
5. Trace Mode = max hold.
6. Sweep = auto couple.

4.7.4 DEVIATION FROM TEST STANDARD

No deviation

4.7.5 TEST SETUP

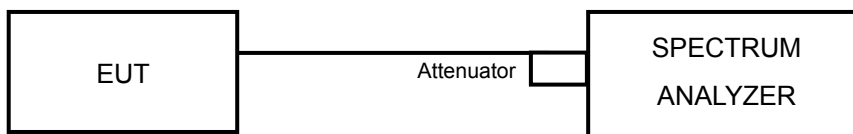

4.7.6 EUT OPERATING CONDITION

Same as Item 4.3.6

4.7.7 TEST RESULTS

The spectrum plots are attached on the following pages. D1 line indicates the highest level, and D2 line indicates the 20dB offset below D1. It shows compliance with the requirement.



A D T

CH 11

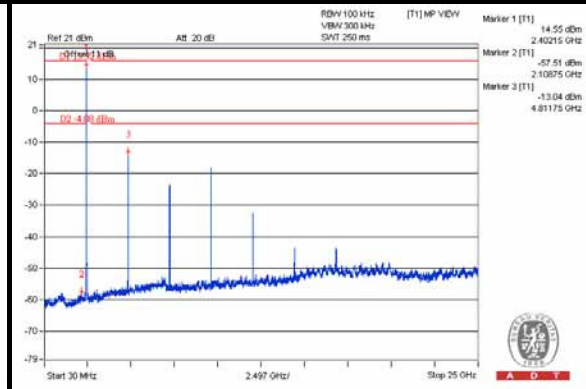
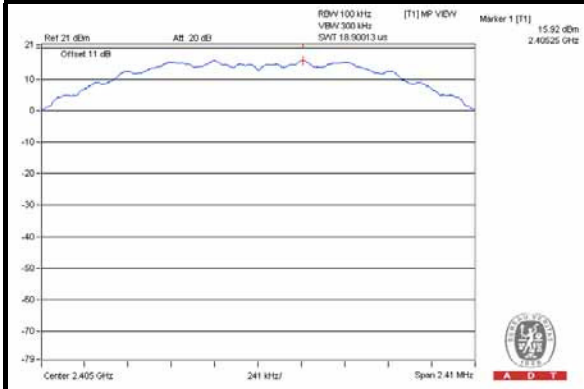

CH 18

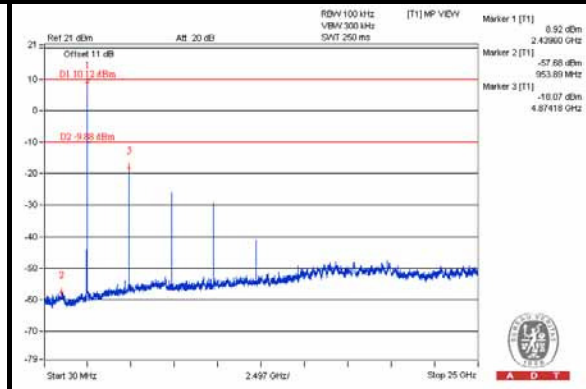
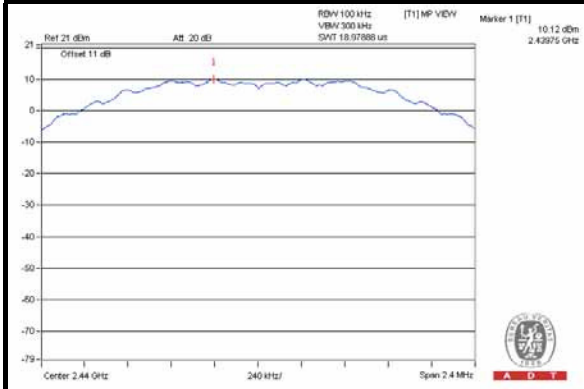

CH 25

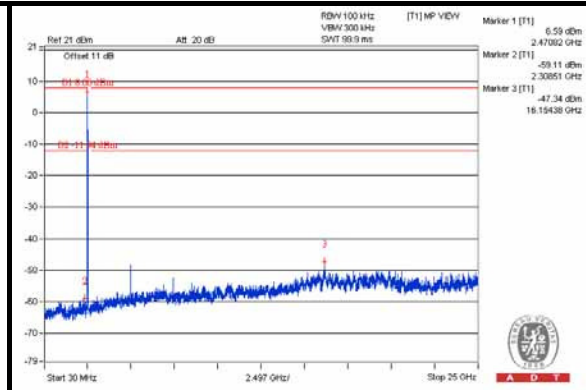
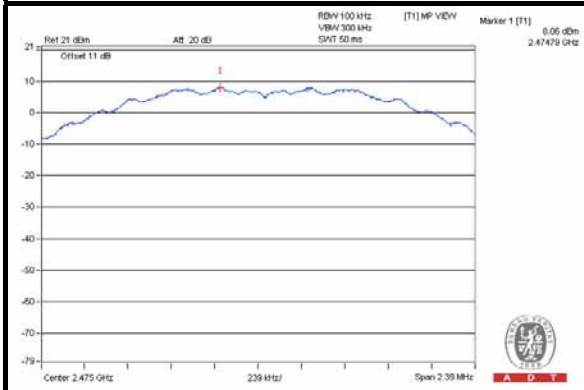

CH 11 Band edge

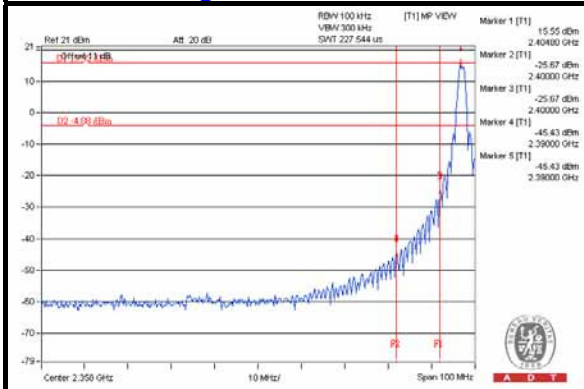

CH 25 Band edge

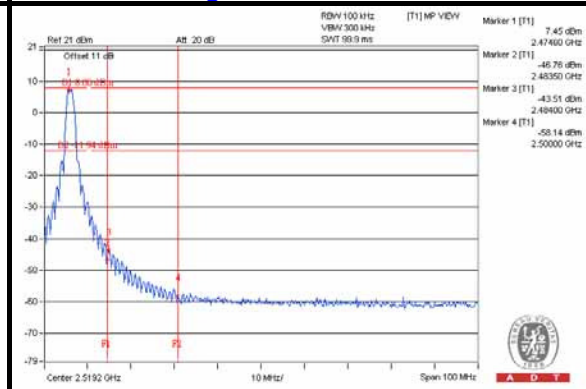

5. PHOTOGRAPHS OF THE TEST CONFIGURATION

Please refer to the attached file (Test Setup Photo).



A D T

6. INFORMATION ON THE TESTING LABORATORIES

We, Bureau Veritas Consumer Products Services (H.K.) Ltd., Taoyuan Branch, were founded in 1988 to provide our best service in EMC, Radio, Telecom and Safety consultation. Our laboratories are accredited and approved according to ISO/IEC 17025.

If you have any comments, please feel free to contact us at the following:

Linko EMC/RF Lab:

Tel: 886-2-26052180

Fax: 886-2-26052943

Hsin Chu EMC/RF Lab:

Tel: 886-3-5935343

Fax: 886-3-5935342

Hwa Ya EMC/RF/Safety/Telecom Lab:

Tel: 886-3-3183232

Fax: 886-3-3270892

Email: service.adt@tw.bureauveritas.com

Web Site: www.bureauveritas-adt.com

The address and road map of all our labs can be found in our web site also.



A D T

7. APPENDIX A - MODIFICATIONS RECORDERS FOR ENGINEERING CHANGES TO THE EUT BY THE LAB

No modifications were made to the EUT by the lab during the test.

--- END ---