

*FCC PART 15, SUBPART B and C
TEST REPORT*

for

Conserve Gateway Connect

MODEL: F7C001

Prepared for

BELKIN INTERNATIONAL, INC.
12045 EAST WATERFRONT DRIVE
PLAYA VISTA, CA 90094

Prepared by: _____

JOSH HANSEN

Approved by: _____

JOEY MADLANGBAYAN

COMPATIBLE ELECTRONICS INC.
20621 PASCAL WAY
LAKE FOREST, CALIFORNIA 92630
(949) 587-0400

DATE: September 17, 2010

	REPORT	APPENDICES					TOTAL
	BODY	A	B	C	D	E	
PAGES	19	2	2	2	14	94	133

This report shall not be reproduced except in full, without the written approval of Compatible Electronics.

TABLE OF CONTENTS

Section / Title	PAGE
GENERAL REPORT SUMMARY	4
SUMMARY OF TEST RESULTS	5
1. PURPOSE	6
2. ADMINISTRATIVE DATA	7
2.1 Location of Testing	7
2.2 Traceability Statement	7
2.3 Cognizant Personnel	7
2.4 Date Test Sample was Received	7
2.5 Disposition of the Test Sample	7
2.6 Abbreviations and Acronyms	7
3. APPLICABLE DOCUMENTS	8
4. Description of Test Configuration	9
4.1 Description of Test Configuration - EMI	9
4.1.1 Cable Construction and Termination	10
5. LISTS OF EUT, ACCESSORIES AND TEST EQUIPMENT	11
5.1 EUT and Accessory List	11
5.2 EMI Test Equipment	12
6. TEST SITE DESCRIPTION1	13
6.1 Test Facility Description	13
6.2 EUT Mounting, Bonding and Grounding	13
7. CHARACTERISTICS OF THE TRANSMITTER	14
7.1 Antenna Gain	14
8. Test Procedures	15
8.1 RF Emissions	15
8.1.1 Conducted Emissions Test	15
8.1.2 Radiated Emissions (Spurious and Harmonics) Test	16
8.2 6 dB Bandwidth	17
8.3 Peak Output Power	17
8.4 RF Antenna Conducted Test	17
8.5 RF Band Edges	18
8.6 Spectral Density Test	18
8.6 Voltage Fluctuations	18
9. CONCLUSIONS	19

LIST OF APPENDICES

APPENDIX	TITLE
A	Laboratory Recognitions
B	Modifications to the EUT
C	Additional Models Covered Under This Report
D	Diagrams, Charts, and Photos <ul style="list-style-type: none">• Test Setup Diagrams• Radiated and Conducted Emissions Photos• Antenna and Effective Gain Factors
E	Data Sheets

LIST OF FIGURES

FIGURE	TITLE
1	Conducted Emissions Test Setup
2	Plot Map And Layout of Test Site

GENERAL REPORT SUMMARY

This electromagnetic emission test report is generated by Compatible Electronics Inc., which is an independent testing and consulting firm. The test report is based on testing performed by Compatible Electronics personnel according to the measurement procedures described in the test specifications given below and in the "Test Procedures" section of this report.

The measurement data and conclusions appearing herein relate only to the sample tested and this report may not be reproduced without the written permission of Compatible Electronics, unless done so in full.

This report must not be used to claim product endorsement by NVLAP or any other agency of the U.S. Government.

Device Tested: Conserve Gateway Connect
Model: F7C001
S/N: N/A

Product Description: See Expository Statement.

Modifications: The EUT was modified in order to meet the specifications. See Annex B for description

Manufacturer: BELKIN INTERNATIONAL, INC.
12045 East Waterfront Drive
Playa Vista, CA 90094

Test Dates: August 26th, and September 1st, 2nd, and 3rd 2010

Test Specifications: EMI requirements
CFR Title 47, Part 15, Subpart B; and Subpart C, sections 15.205, 15.207, 15.209, and 15.247

Test Procedure: ANSI C63.10: 2009

Test Deviations: The test procedure was not deviated from during the testing.

SUMMARY OF TEST RESULTS

TEST	DESCRIPTION	RESULTS
1	Conducted RF Emissions, 150 kHz – 30 MHz	Complies with the Class B limits of CFR Title 47, Part 15 Subpart B; and the limits of CFR Title 47, Part 15, Subpart C, section 15.207
2	Spurious Radiated RF Emissions, 30 MHz – 1000 MHz	Complies with the Class B limits of CFR Title 47, Part 15 Subpart B; and the limits of CFR Title 47, Part 15, Subpart C, section 15.209
3	Spurious Radiated RF Emissions, 9 kHz – 30 MHz and 1000 MHz – 25000 MHz	Complies with the Class B limits of CFR Title 47, Part 15, Subpart B; and CFR Title 47, Part 15, Subpart C, section 15.247(d)
4	Fundamental and Emissions produced by the intentional radiator in non-restricted bands, 10 kHz – 25 GHz	Complies with the relevant requirements of CFR Title 47, Part 15, Subpart C, section 15.247(d)
5	Emissions produced by the intentional radiator in restricted bands, 10 kHz – 25 GHz	Complies with the relevant requirements of CFR Title 47, Part 15, Subpart C, section 15.205, 15.209, and section 15.247 (d)
6	6 dB Bandwidth	Complies with the relevant requirements of FCC Title 47, Part 15, Subpart C, section 15.247 (a)(2)
7	Peak Power Output	Complies with the relevant requirements of FCC Title 47, Part 15, Subpart C, section 15.247 (b)(3), and (b)(4)
8	RF Conducted Antenna Test	Complies with the relevant requirements of FCC Title 47, Part 15, Subpart C, section 15.247 (d)
9	Peak Power Spectral Density from the Intentional Radiator to the Antenna	Complies with the relevant requirements of CFR Title 47, Part 15, Subpart C, section 15.247 (e)
10	Voltage Fluctuations	Complies with the relevant requirements of FCC Title 47, Part 15, Subpart C section 15.31 (e).

1. PURPOSE

This document is a qualification test report based on the Electromagnetic Interference (EMI) tests performed on the Conserve Gateway Connect, Model: F7C001. The EMI measurements were performed according to the measurement procedure described in ANSI C63.10: 2009. The tests were performed in order to determine whether the electromagnetic emissions from the equipment under test, referred to as EUT hereafter, are within the Class B specification limits defined by CFR Title 47, Part 15, Subpart B; and Subpart C, sections 15.205, 15.209, and 15.247.

Note: For the unintentional radiator portion of the test, the EUT was within the **Class B** specification limits defined by CFR Title 47, Part 15, Subpart B.



2. ADMINISTRATIVE DATA

2.1 Location of Testing

The EMI tests described herein were performed at the test facility of Compatible Electronics, 20621 Pascal Way, Lake Forest, California 92630.

2.2 Traceability Statement

The calibration certificates of all test equipment used during the test are on file at the location of the test. The calibration is traceable to the National Institute of Standards and Technology (NIST).

2.3 Cognizant Personnel

Belkin International, Inc.

Daniel Wesey EMC Regulatory Compliance Engineer

Compatible Electronics Inc.

Matt Harrison Test Technician
Kyle Fujimoto Test Engineer
Josh Hansen Lab Manager, Lake Forest Division
Jeff Klinger Director of Engineering

2.4 Date Test Sample was Received

The test sample was received prior to the date of testing.

2.5 Disposition of the Test Sample

The test sample was returned to Belkin Inc.

2.6 Abbreviations and Acronyms

The following abbreviations and acronyms may be used in this document.

RF	Radio Frequency
EMI	Electromagnetic Interference
EUT	Equipment Under Test
P/N	Part Number
S/N	Serial Number
HP	Hewlett Packard
ITE	Information Technology Equipment
CML	Corrected Meter Limit
LISN	Line Impedance Stabilization Network
N/A	Not Applicable

3. APPLICABLE DOCUMENTS

The following documents are referenced or used in the preparation of this EMI Test Report.

SPEC	TITLE
FCC Title 47, Part 15 Subpart B	FCC Rules - Radio frequency devices (including digital devices) – Unintentional Radiators
FCC Title 47, Part 15 Subpart C	FCC Rules - Radio frequency devices (including digital devices) – Intentional Radiators
ANSI C63.10 2009	Methods of measurement of radio-noise emissions from low-voltage electrical and electronic equipment in the range of 9 kHz to 40 GHz

4. DESCRIPTION OF TEST CONFIGURATION

4.1 Description of Test Configuration - EMI

The Conserve Gateway Connect, Model: F7C001 (EUT) was connected to a power supply via its power jack, a Mouse via its USB port, a Network Switch via its Network Port. The EUT was continuously transmitting and/or receiving continuously during the test depending on how the EUT was programmed.

Operation of the EUT during the testing:

For the intentional radiator portion of the test: The EUT used a program that locked one channel at a time so that the low, middle, and high channels could be tested. The carrier was modulated in the same way it would be when the EUT was in its normal mode.

The final radiated as well as the conducted data was taken in the modes above. Please see Appendix E for the data sheets.

For the unintentional radiator and conducted emission portion of the test: The EUT used a program that allowed the EUT to function as normal on each of the low, middle, and high channels. The carrier was modulated in the same way it would be when the EUT was in its normal mode.

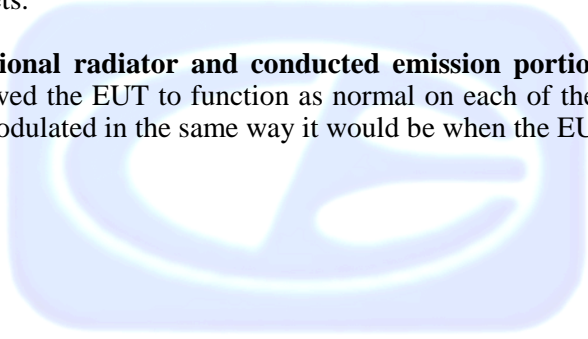

4.1.1 Cable Construction and Termination

Cable 1 This is a 1-meter unshielded cable connecting the EUT with the Network Switch (1). The cable has an RJ-45 connector at each end.

Cable 2 This is a 15-meter unshielded cable connecting the EUT with the Network Switch (2). The cable has an RJ-45 connector at each end.

Cable 3 This is a 1.5-meter unshielded cable connecting the Network Switch (2) with the Laptop. The cable has an RJ-45 connector at each end.

Cable 4 This is a 1.5-meter foil shielded cable connecting the EUT with the Mouse. The cable has a USB connector at the EUT end and is hard wired into the Mouse.

Cable 5 This is a 2-meter unshielded cable connecting the EUT with the AC Adapter. The cable has a 1/5 DC barrel connector at the EUT end and is hard wired into the AC Adapter. There is a Ferrite at the EUT side of connector.



5. LISTS OF EUT, ACCESSORIES AND TEST EQUIPMENT

5.1 EUT and Accessory List

EQUIPMENT	MANUFACTURER	MODEL NUMBER	SERIAL NUMBER	FCC ID
CONSERVE GATEWAY CONNECT (EUT)	Belkin International, Inc.	F7C001	N/A	K7SF7C001
AC ADAPTER (1) FOR EUT	DVE	DSA-12PFA-05	N/A	N/A
AC ADAPTER (2) FOR EUT	Leader Electronics Inc.	MU12-G050200-A1	N/A	N/A
LAPTOP	DELL	PPO4X	N/A	N/A
NETWORK SWITCH	NETGEAR	FS105	N/A	N/A

5.2 EMI Test Equipment

EQUIPMENT TYPE	MANUFACTURER	MODEL NUMBER	SERIAL NUMBER	CALIBRATION DATE	CALIBRATION DUE DATE
GENERAL TEST EQUIPMENT USED FOR ALL RF EMISSIONS TESTS					
Computer	Compatible Electronics	NONE	NONE	N/A	N/A
EMI Receiver	Rohde & Schwarz	ESIB40	100172	1/07/2009	1/07/2011
RF RADIATED EMISSIONS TEST EQUIPMENT					
CombiLog Antenna	Com Power	AC-220	003	5/06/2010	5/06/2011
Loop Antenna	Com-Power	AL-130	17085	8/01/2008	8/01/2011
Horn Antenna	Com-Power	AH-118	071225	11/24/2009	11/24/2011
Horn Antenna	Com-Power	AHA-118	701084	8/27/2008	8/27/2011
Horn Antenna	Com-Power	AH-826	081033	11/28/2005	N.C.R.
Pre Amplifier	Com-Power	PA-122	01321	2/1/2010	2/1/2011
Preamplifier	Com-Power	PA-840	181289	2/1/2010	2/1/2011
RF RADIATED EMISSIONS TEST EQUIPMENT					
10 dB Attenuator	Aeroflex/Weinshcel	2-10	BX9280	12/11/2009	12/11/2010
Power Analyzer	Boonton Electronics	4500A-01	1282	6/30/2008	6/30/2011
Mast, Antenna Positioner	Sunol Science Corporation	TWR 95-4	020808-3	N/A	N/A
Antenna Mast	Sunol Science Corporation	TWR 95-4	020808-3	N/A	N/A
Turntable	Sunol Science Corporation	FM 2001	N/A	N/A	N/A
Mast and Turntable Controller	Sunol Science Corporation	SC104V	020808-1	N/A	N/A

6. TEST SITE DESCRIPTION1**6.1 Test Facility Description**

Please refer to section 2.1 and 7.1 of this report for EMI test location.

6.2 EUT Mounting, Bonding and Grounding

The EUT was mounted on a 1.0 by 1.5 meter non-conductive table 0.8 meters above the ground plane.

The EUT was not grounded.



7. CHARACTERISTICS OF THE TRANSMITTER**7.1 Antenna Gain**

The antenna has a max gain of 4.4 dBi.



8. TEST PROCEDURES

The following sections describe the test methods and the specifications for the tests. Test results are also included in this section.

8.1 RF Emissions

8.1.1 Conducted Emissions Test

The receiver was used as a measuring meter. The receiver was used in the peak detect mode with the "Max Hold" feature activated. In this mode, the receiver records the highest measured reading over all the sweeps. The quasi-peak detector was used only where indicated in the data sheets. An attenuator was used for the protection of the receiver input stage, and the offset was adjusted accordingly to read the actual data measured. The LISN output was measured using the receiver. The output of the second LISN was terminated by a 50 ohm termination. The effective measurement bandwidth used for this test was 9 kHz.

Please see section 6.2 of this report for mounting, bonding and grounding of the EUT. The EUT was powered through the LISN, which was bonded to the ground plane. The LISN power was filtered and the filter was bonded to the ground plane. The EUT was set up with the minimum distances from any conductive surfaces as specified in ANSI C63.10: 2009. The excess power cord was wrapped in a figure eight pattern to form a bundle not exceeding 0.4 meters in length.

The conducted emissions from the EUT were maximized for operating mode as well as cable placement. The final data was collected under program control by the Compatible Electronics conducted emissions software in several overlapping sweeps by running the receiver at a minimum scan rate of 10 seconds per octave. The final qualification data is located in Appendix E.

Test Results:

Complies with the **Class B** limits of CFR Title 47, Part 15 Subpart B; and the limits of CFR Title 47, Part 15, Subpart C, section 15.207.

8.1.2 Radiated Emissions (Spurious and Harmonics) Test

The receiver was used as a measuring meter. The receiver was used in the peak detect mode with the "Max Hold" feature activated. In this mode, the receiver records the highest measured reading over all the sweeps. Amplifiers were used to increase the sensitivity of the instrument. The Com Power Microwave Preamplifier Model: PA-122 was used for frequencies above 1 GHz, and the Com Power Microwave Preamplifier Model: PA-840 was used for frequencies above 18 GHz.

The quasi-peak adapter was used only for those readings which are marked accordingly on the data sheets.

The frequencies above 1 GHz were averaged manually by narrowing the video filter down to 10 Hz and putting the sweep time on AUTO on the receiver to keep the amplitude reading calibrated.

The measurement bandwidths and transducers used for the radiated emissions test were:

FREQUENCY RANGE	EFFECTIVE MEASUREMENT BANDWIDTH	TRANSDUCER
10 kHz to 150 kHz	200 Hz	Active Loop Antenna
150 kHz to 30 MHz	9 kHz	Active Loop Antenna
30 MHz to 1000 MHz	120 kHz	CombiLog Antenna
1 GHz to 25 GHz	1 MHz	Horn Antenna

The Semi-Anechoic test site of Compatible Electronics, Inc, Lab P (Lake Forest) was used for radiated emission testing. This test site is set up according to ANSI C63.10: 2009. Please see section 6.2 of this report for mounting, bonding and grounding of the EUT. The turntable supporting the EUT is remote controlled using a motor. The turntable permits EUT rotation of 360 degrees in order to maximize emissions. Also, the antenna mast allows height variation of the antenna from 1 meter to 4 meters. Data was collected in the worst case (highest emission) configuration of the EUT. At each reading, the EUT was rotated 360 degrees and the antenna height was varied from 1 to 4 meters (for E field radiated field strength). The gun sight method was used when measuring with the horn antenna in order to ensure accurate results. The EUT was tested at a 3 meter test distance from 10 kHz to 25 GHz to obtain the final test data. There were no emissions found below 30MHz

Test Results:

The EUT complies with the **Class B** limits of CFR Title 47, Part 15, Subpart B; and the limits of CFR Title 47, Part 15, Subpart C, Sections 15.209 and 15.247 (d) for radiated emissions. Please see Appendix E for the data sheets.

8.2 6 dB Bandwidth

The 6 dB Bandwidth was measured using the EMI Receiver. The bandwidth was measured using a direct connection from the RF output of the EUT. The resolution bandwidth was 100 kHz and the video bandwidth was 300 kHz.

Test Results:

The EUT complies with the relevant requirements of FCC Title 47, Part 15, Subpart C section 15.247 (a)(2). Please see the data sheets located in Appendix E.

8.3 Peak Output Power

The Peak Output Power was measured using the Peak Power Meter. The peak output power was measured using a direct connection from the RF output of the EUT. The measurement bandwidth is 5GHz. The cable loss was added back into the reading using self calibration feature.

Test Results:

The EUT complies with the relevant requirements of FCC Title 47, Part 15, Subpart C section 15.247 (b)(4). The maximum peak output power is less than 1 watt. Please see the data sheets located in Appendix E.

8.4 RF Antenna Conducted Test

The RF antenna conducted test was performed using the EMI Receiver. The RF antenna conducted test measured using a direct connection from the RF out on the EUT into the input of the EMI Receiver. The resolution bandwidth was 100 kHz, and the video bandwidth was 1 MHz. The spans were wide enough to include all the harmonics and emissions that were produced by the intentional radiator.

Test Results:

The EUT complies with the relevant requirements of FCC Title 47, Part 15, Subpart C section 15.247 (d). The RF power that is produced by the intentional radiator is at least 20 dB below that in the 100 kHz bandwidth within the band that contains the highest level of desired power. Please see the radiated emission data sheets located in Appendix E.

8.5 RF Band Edges

The RF band edges were taken at the edges of the ISM spectrum (2400 MHz when the EUT was on the low channel and 2483.5 MHz when the EUT was on the high channel) using the EMI Receiver. A preamplifier was used to boost the signal level, with the plots being taken at a 3 meter test distance. The radiated emissions test procedure as describe in section 8.2 of this test report was used to maximize the emission.

Test Results:

The EUT complies with the relevant requirements of FCC Title 47, Part 15, Subpart C section 15.247 (d). The RF power at the band edges at 2400 MHz and 2483.5 MHz meet the requirements of FCC Title 47, Part 15, Subpart C section 15.247 (d). Please see the data sheets located in Appendix E.

8.6 Spectral Density Test

The spectrum density output was measured using the EMI Receiver. The spectral density output was measured using a direct connection from the RF out on the EUT into the input of the EMI Receiver. The resolution bandwidth 3 kHz, and the video bandwidth was 10 kHz. The highest 1.5 MHz of the signal was used as the frequency span with the sweep rate being 1 second for every 3 kHz of span.

Test Results:

The EUT complies with the relevant requirements of FCC Title 47, Part 15, Subpart C section 15.247 (e).

8.6 Voltage Fluctuations

The supply voltage fluctuation test was performed using the EMI Receiver. The EUT input power was varied between 85% and 115% of the nominal rated supply voltage. The carrier frequency was monitored for any change in amplitude.

Test Results:

The EUT complies with the relevant requirements of FCC Title 47, Part 15, Subpart C section 15.31 (e).

9. CONCLUSIONS

The Conserve Gateway Connect Model: F7C001 meets all of the specification limits defined in FCC Title 47, Part 15, Subpart C, sections 15.205, 15.209, 15.247, and 15.31.

Note: For the unintentional radiator portion of the test, the EUT was within the **Class B** specification limits defined by CFR Title 47, Part 15, Subpart B.





APPENDIX A

LABORATORY RECOGNITIONS

Brea Division
114 Olinda Drive
Brea, CA 92823
(714) 579-0500

Agoura Division
2337 Troutdale Drive
Agoura, CA 91301
(818) 597-0600

Silverado Division
19121 El Toro Road
Silverado, CA 92676
(949) 589-0700

Lake Forest Division
20621 Pascal Way
Lake Forest, CA 92630
(949) 587-0400

LABORATORY RECOGNITIONS

Compatible Electronics has the following agency accreditations:

National Voluntary Laboratory Accreditation Program - Lab Code: 200527-0

Voluntary Control Council for Interference - Registration Numbers: R-3276, C-3645, T-11758

Bureau of Standards and Metrology Inspection - Reference Number: SL2-IN-E-1031

Conformity Assessment Body for the EMC Directive Under the US/EU MRA Appointed by NIST

Compatible Electronics is recognized or on file with the following agencies:

Industry Canada
Site Number: 2154C-1



APPENDIX B

MODIFICATIONS TO THE EUT

MODIFICATIONS TO THE EUT

The modifications listed below were made to the EUT to pass FCC Subpart B and FCC 15.247 specifications.

All the rework described below was implemented during the test in a method that could be reproduced in all the units by the manufacturer.

- Changed R5 to 2.7pF.
- Changed DAC-0 Receive only antenna to ACX AT9520-B2R4HAAT/LF
- Ferrite Bead DIGIKEY (Mfg P/N ZCAT1518-0730) 445-2040-ND Material on Power Cable 1” from DC Barrel Connector.

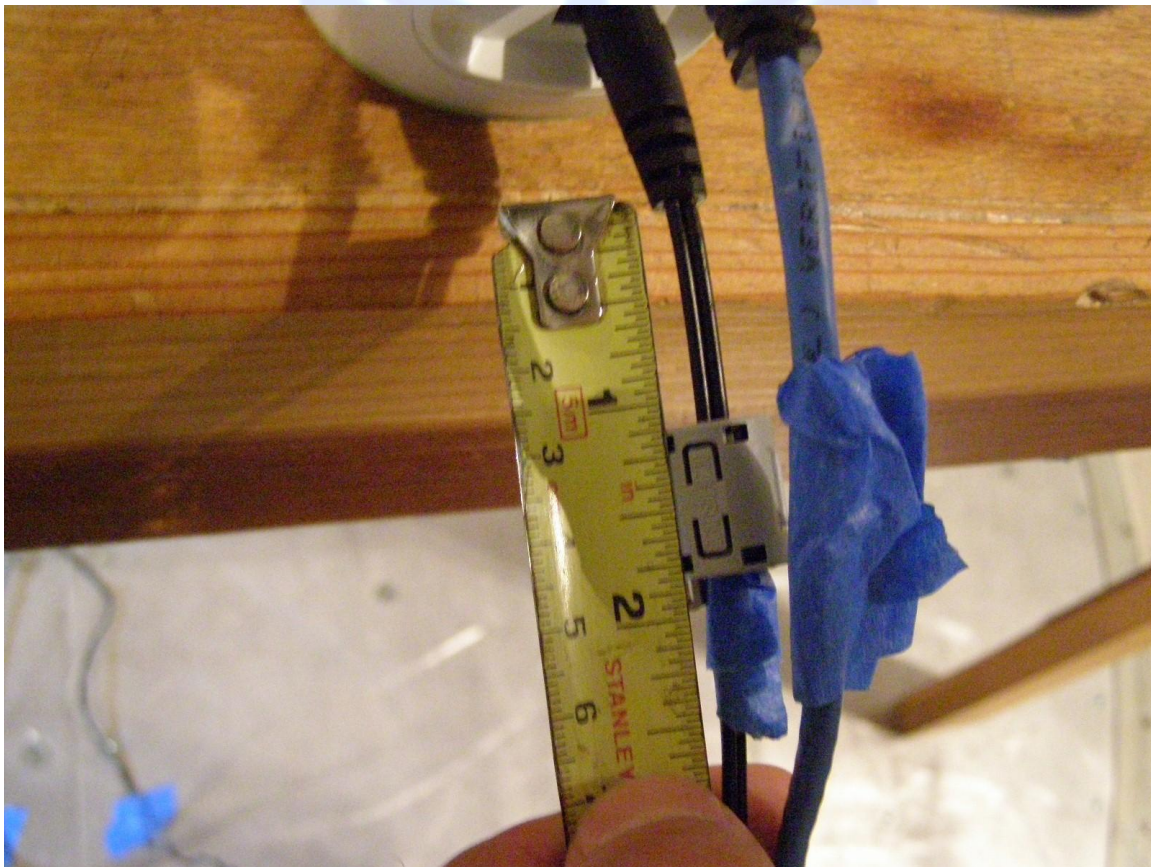



APPENDIX C

***ADDITIONAL MODELS COVERED
UNDER THIS REPORT***

Brea Division
114 Olinda Drive
Brea, CA 92823
(714) 579-0500

Agoura Division
2337 Troutdale Drive
Agoura, CA 91301
(818) 597-0600

Silverado Division
19121 El Toro Road
Silverado, CA 92676
(949) 589-0700

Lake Forest Division
20621 Pascal Way
Lake Forest, CA 92630
(949) 587-0400

ADDITIONAL MODELS COVERED UNDER THIS REPORT

USED FOR THE PRIMARY TEST



Conserve Gateway Connect
Model: F7C001
S/N: N/A

There were no additional models covered under this report.

APPENDIX D

DIAGRAMS, CHARTS, AND PHOTOS

FIGURE 1: CONDUCTED EMISSIONS TEST SETUP

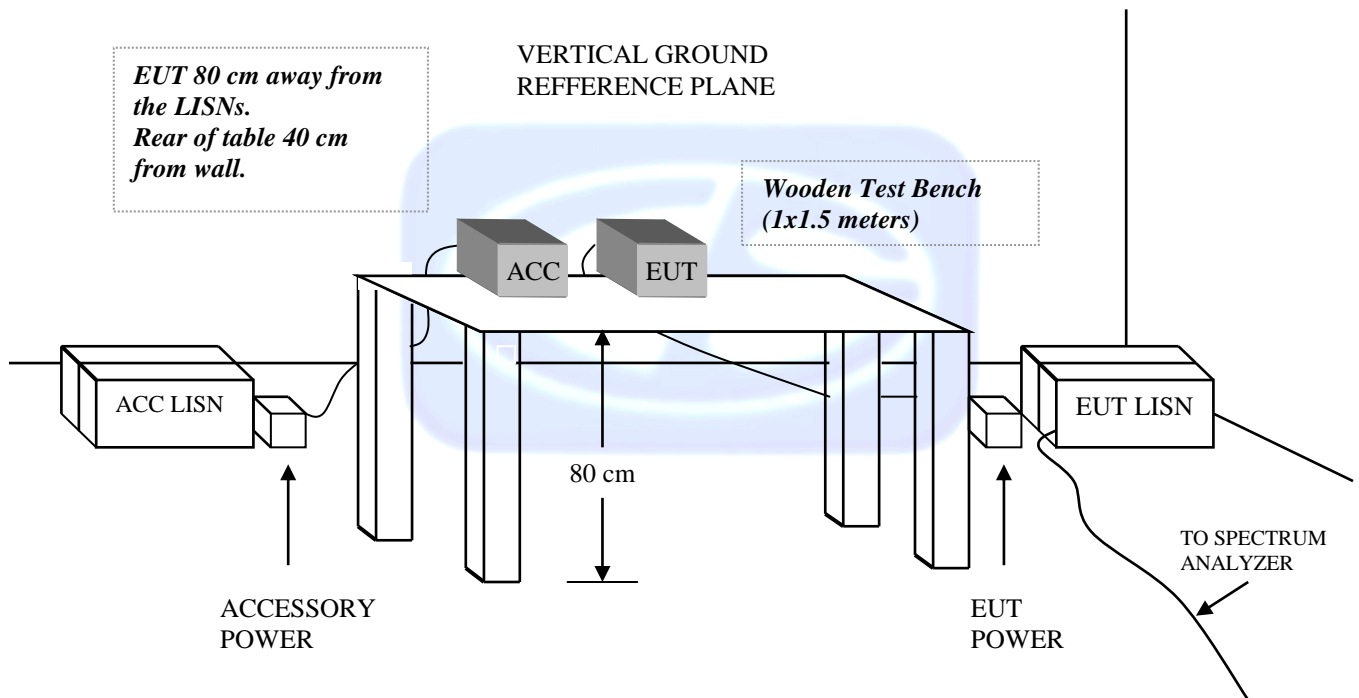
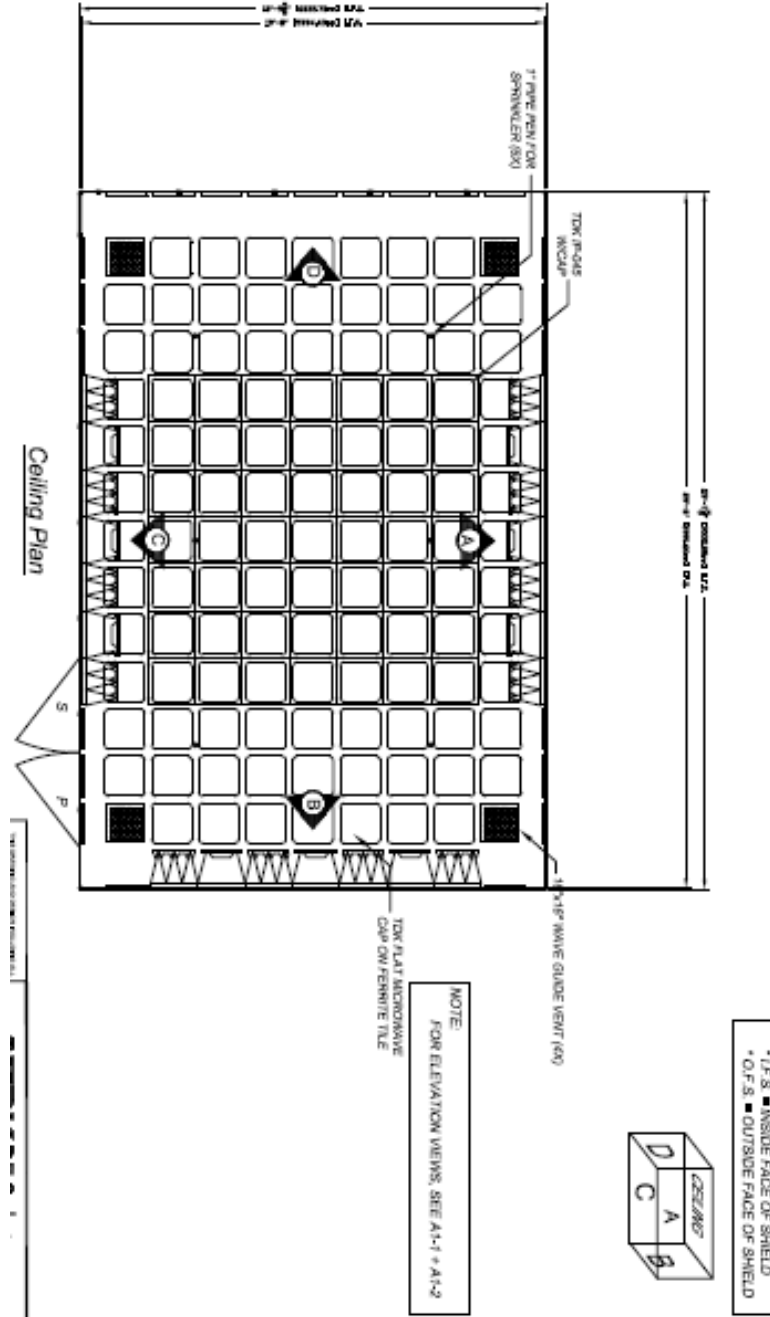

FIGURE 2: PLOT MAP AND LAYOUT OF RADIATED SITE



TDK FAC-3 test chamber

COM-POWER AL-130**LOOP ANTENNA****S/N: 17085****CALIBRATION DATE: August 1, 2008**

FREQUENCY (MHz)	MAGNETIC (dB/m)	ELECTRIC (dB/m)	FREQUENCY (MHz)	MAGNETIC (dB/m)	ELECTRIC (dB/m)
0.009	-43	8.5	0.8	-41.53	9.97
0.01	-41.93	9.57	0.9	-41.46	10.04
0.02	-41.29	10.21	1	-41.29	10.21
0.03	-40.73	10.77	2	-40.97	10.53
0.04	-41.03	10.47	3	-41.1	10.4
0.05	-42.37	9.13	4	-41.36	10.14
0.06	-41.6	9.9	5	-40.93	10.57
0.07	-41.96	9.54	6	-40.67	10.83
0.08	-42.1	9.4	7	-41.07	10.43
0.09	-41.83	9.67	8	-40.9	10.6
0.1	-41.83	9.67	9	-40.1	11.4
0.2	-44.46	7.04	10	-41.16	10.34
0.3	-41.73	9.77	15	-47.97	3.53
0.4	-41.8	9.7	20	-40.77	10.73
0.5	-41.8	9.7	25	-44.37	7.13
0.6	-41.33	10.17	30	-43.1	8.4
0.7	-41.36	10.14			

COM-POWER AC-220**COMBYLOG ANTENNA**

S/N: 003

CALIBRATION DATE: *May 6, 2010*

FREQUENCY (MHz)	FACTOR (dB)	FREQUENCY (MHz)	FACTOR (dB)
25	21.3	180	9.8
30	20.6	200	10.4
35	20.4	250	13.8
40	19.3	275	13.2
45	17.1	300	14.3
50	16.2	400	16
60	13.5	500	17.9
70	7.4	600	18.8
80	8.1	700	20.0
90	9.2	800	21.5
100	10.1	900	23.4
120	10.6	1000	23.4
125	11.1	1200	23.3
140	10.3	1400	23.8
150	12.6	1600	24.5
160	10.2	1800	26.9
175	9.7	2010	28

COM POWER AHA-118**HORN ANTENNA**

S/N: 701084

CALIBRATION DATE: *August 27, 2008*

FREQUENCY (GHz)	FACTOR (dB)	FREQUENCY (GHz)	FACTOR (dB)
1000	-1.84	9500	10.56
1500	-0.43	10000	11.07
2000	0.87	10500	12.03
2500	2.13	11000	13.2
3000	4.07	11500	16.66
3500	3.47	12000	16.97
4000	4.74	12500	16.33
4500	5.23	13000	15.1
5000	7.84	13500	13.4
5500	7.07	14000	19.03
6000	9.97	14500	17.33
6500	9.57	15000	12
7000	11.2	15500	11.53
7500	11.8	16000	11.96
8000	14.8	16500	12.37
8500	12.7	17000	15.66
9000	12.37	17500	17.43
		18000	16.2

COM POWER AH-118**HORN ANTENNA**

S/N: 071225

CALIBRATION DATE: *November 24, 2009*

FREQUENCY (GHz)	FACTOR (dB)	FREQUENCY (GHz)	FACTOR (dB)
1000	25	9500	37.7
1500	25.4	10000	39.4
2000	28.5	10500	39.4
2500	28.5	11000	39.2
3000	30.1	11500	40.3
3500	30.6	12000	39
4000	30.4	12500	40.7
4500	32.1	13000	39.8
5000	33.3	13500	40.1
5500	33.4	14000	43
6000	34.6	14500	43.8
6500	35.1	15000	41.5
7000	37.2	15500	38.9
7500	37.8	16000	39.8
8000	37.5	16500	40
8500	37.4	17000	41.7
9000	38	17500	46.1
		18000	46.4

COM-POWER PA-122**PREAMPLIFIER**

S/N: 01321

CALIBRATION DATE: *February 1, 2010*

FREQUENCY (GHz)	FACTOR (dB)	FREQUENCY (GHz)	FACTOR (dB)
500	31.52	13500	30.13
1000	31.53	14000	30.58
1500	31.24	14500	30.58
2000	30.99	15000	29.12
2500	30.66	15500	28.92
3000	30.44	16000	29.7
3500	29.9	16500	29.65
4000	29.27	17000	28.64
4500	28.63	17500	28.26
5000	28.2	18000	27.76
5500	28.13	18500	27.29
6000	28.4	19000	27.11
6500	28.29	19500	26.99
7000	28.19	20000	26.92
7500	28.72	20500	24.87
8000	29.22	21000	25.17
8500	29.05	21500	26.97
9000	28.71	22000	25.73
9500	28.5	22500	23.43
10000	29.13	23000	20.9
10500	29.92	23500	15.81
11000	29.96	24000	9.12
11500	29.55	24500	4.18
12000	30.03	25000	-0.41
12500	30.43	25500	-3.32
13000	30.02	26000	-7.42
		26500	-6.73

COM-POWER AH826**HORN ANTENNA**

S/N: 081033

CALIBRATION DATE: *November 28, 2005*

FREQUENCY (GHz)	FACTOR (dB)	FREQUENCY (GHz)	FACTOR (dB)
18.0	22.5	22.5	24.5
18.5	23.4	23.0	24.7
19.0	23.9	23.5	25.6
19.5	24.5	24.0	24.9
20.0	22.9	24.5	24.3
20.5	22.8	25.0	24.1
21.0	24.1	25.5	24.7
21.5	23.6	26.0	23.4
22.0	24.0	26.5	25.0

COM-POWER PA-840**MICROWAVE PREAMPLIFIER**

S/N: 181289

CALIBRATION DATE: February 1, 2010

FREQUENCY (GHz)	FACTOR (dB)	FREQUENCY (GHz)	FACTOR (dB)
18000	30.78	31000	30.71
19000	27.79	31500	29.83
20000	28.36	32000	29.2
21000	26.71	32500	30.06
22000	28.05	33000	31.15
23000	26.76	33500	29.18
24000	28.66	34000	28.28
25000	30.72	34500	27.82
26000	32.25	35000	29.9
26500	31.19	35500	28.58
27000	31.79	36000	27.71
27500	32.1	36500	27.97
28000	32.31	37000	30.82
28500	29.5	37500	25.92
29000	30.31	38000	28.08
29500	29.29	38500	30.06
30000	30.74	39000	31.08
30500	29.88	39500	25.67
		39999	31.67



FRONT VIEW

BELKIN INTERNATIONAL, INC.
CONSERVE GATEWAY CONNECT
MODEL: F7C001
FCC SUBPART B AND C – RADIATED EMISSIONS

**PHOTOGRAPH SHOWING THE EUT CONFIGURATION
FOR MAXIMUM EMISSIONS**

Brea Division
114 Olinda Drive
Brea, CA 92823
(714) 579-0500

Agoura Division
2337 Troutdale Drive
Agoura, CA 91301
(818) 597-0600

Silverado Division
19121 El Toro Road
Silverado, CA 92676
(949) 589-0700

Lake Forest Division
20621 Pascal Way
Lake Forest, CA 92630
(949) 587-0400



REAR VIEW

BELKIN INTERNATIONAL, INC.
CONSERVE GATEWAY CONNECT
MODEL: F7C001
FCC SUBPART B AND C – RADIATED EMISSIONS

**PHOTOGRAPH SHOWING THE EUT CONFIGURATION
FOR MAXIMUM EMISSIONS**

Brea Division
114 Olinda Drive
Brea, CA 92823
(714) 579-0500

Agoura Division
2337 Troutdale Drive
Agoura, CA 91301
(818) 597-0600

Silverado Division
19121 El Toro Road
Silverado, CA 92676
(949) 589-0700

Lake Forest Division
20621 Pascal Way
Lake Forest, CA 92630
(949) 587-0400



FRONT VIEW

BELKIN INTERNATIONAL, INC.
CONSERVE GATEWAY CONNECT
MODEL: F7C001
FCC SUBPART B AND C – CONDUCTED EMISSIONS

**PHOTOGRAPH SHOWING THE EUT CONFIGURATION
FOR MAXIMUM EMISSIONS**

Brea Division
114 Olinda Drive
Brea, CA 92823
(714) 579-0500

Agoura Division
2337 Troutdale Drive
Agoura, CA 91301
(818) 597-0600

Silverado Division
19121 El Toro Road
Silverado, CA 92676
(949) 589-0700

Lake Forest Division
20621 Pascal Way
Lake Forest, CA 92630
(949) 587-0400

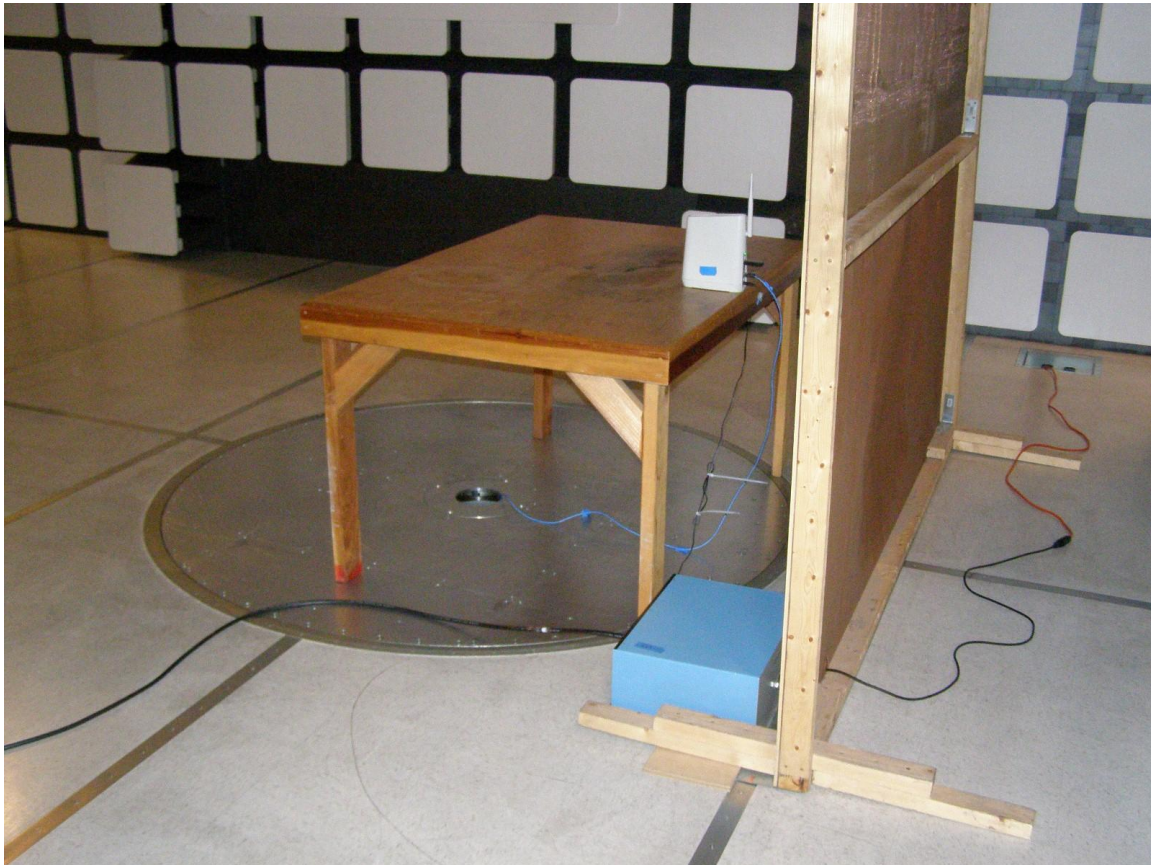

REAR VIEW

BELKIN INTERNATIONAL, INC.
CONSERVE GATEWAY CONNECT
MODEL: F7C001
FCC SUBPART B AND C – CONDUCTED EMISSIONS

**PHOTOGRAPH SHOWING THE EUT CONFIGURATION
FOR MAXIMUM EMISSIONS**

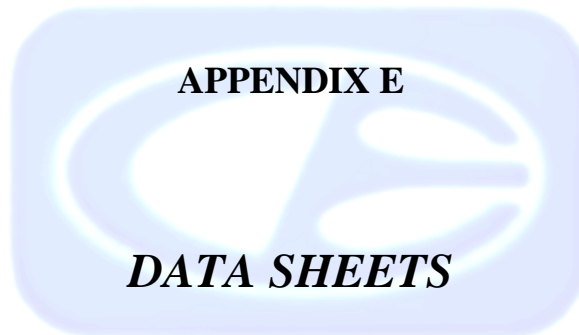

CONDUCTED EMISIONS

DATA SHEETS

Title: FCC 15.207
File: Conducted Pre-Line.set
Operator: Matt Harrison
EUT Type: Solo F7C001
EUT Condition: 802.11b, Ch.1, 6Mb/, AC Adapter (1)
Comments: USB Terminated to Mouse, and Alt Ethernet terminated to Hub (no power to hub)
Witness: Daniel
Temp: 63f
Hum: 47%
120V 60Hz

8/25/2010 11:26:49 AM
Sequence: Preliminary Scan

Compatible Electronics, Inc. FAC-3 (LAB-P)

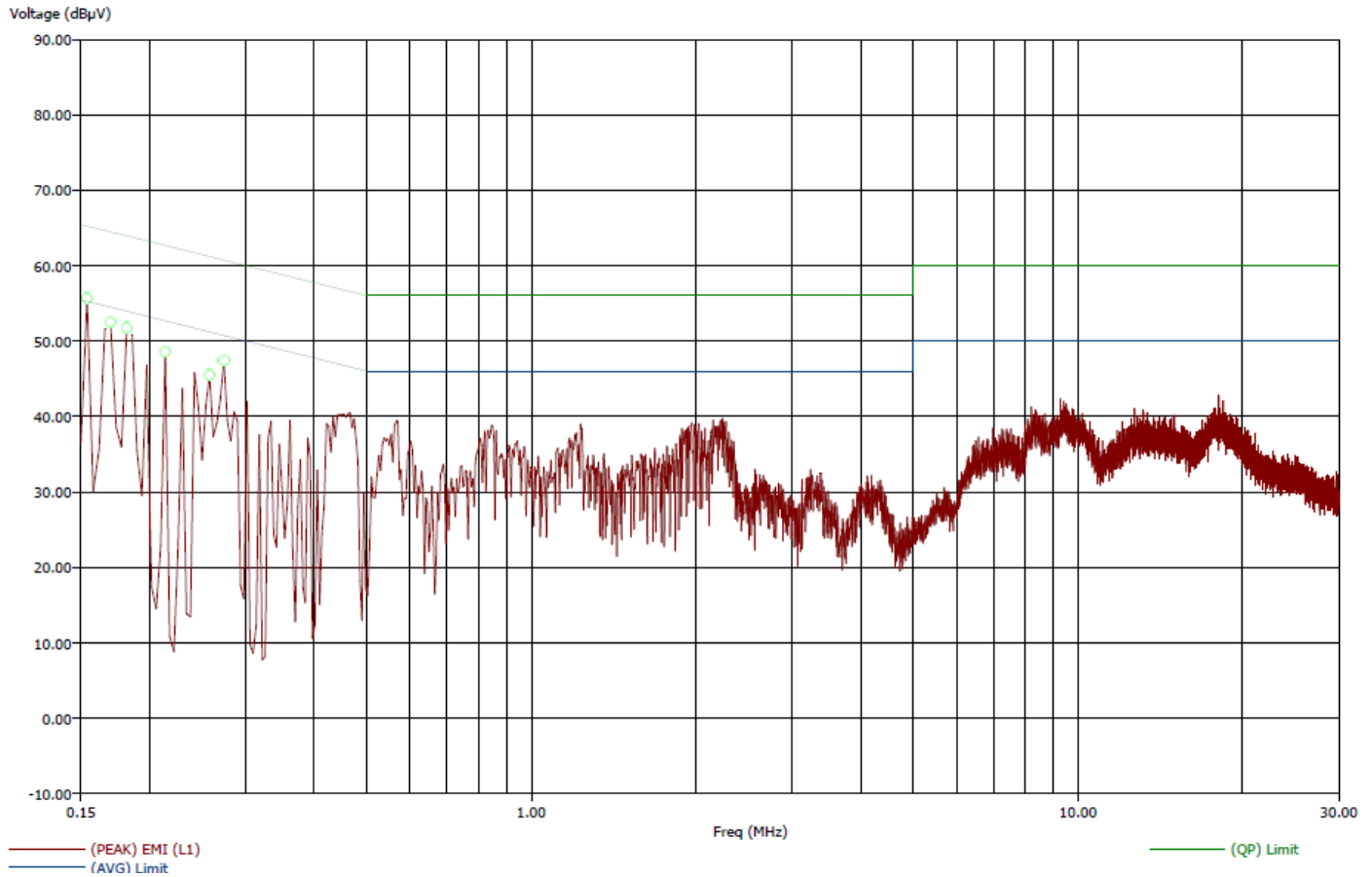

Title: FCC 15.207
 File: Conducted Final-Line.set
 Operator: Matt Harrison
 EUT Type: Solo F7C001
 EUT Condition: 802.11b, Ch.1, 6Mb/, AC Adapter (1)
 Comments: USB Terminated to Mouse, and Alt Ethernet terminated to Hub (no power to hub)
 Witness: Daniel
 Temp: 63f
 Hum: 47%
 120V 60Hz

8/25/2010 11:30:13 AM
 Sequence: Final Measurements

Compatible Electronics, Inc. FAC-3 (LAB-P)

Freq (MHz)	(AVG) Margin AVL (dB)	(QP) Margin QPL (dB)	(AVG) EMI (dBµV)	(QP) EMI (dBµV)	(PEAK) EMI (dBµV)	(AVG) Limit (dBµV)	(QP) Limit (dBµV)	Transducer (dB)	Cable (dB)
0.15	-36.03	-18.31	19.22	46.94	55.60	55.25	65.25	0.00	0.05
0.17	-22.28	-15.59	32.19	48.89	56.29	54.47	64.47	0.00	0.05
0.18	-18.80	-15.53	35.14	48.41	54.44	53.94	63.94	0.00	0.05
0.21	-37.85	-22.55	14.81	40.11	53.23	52.67	62.67	0.00	0.06
0.26	-21.02	-19.90	30.18	41.30	48.73	51.20	61.20	0.00	0.08
0.27	-19.93	-19.98	30.79	40.75	48.03	50.73	60.73	0.00	0.08

Title: FCC 15.207
File: Conducted Pre-Neutral.set
Operator: Matt Harrison
EUT Type: Solo F7C001
EUT Condition: 802.11b, Ch.1, 6Mb/, AC Adapter (1)
Comments: USB Terminated to Mouse, and Alt Ethernet terminated to Hub (no power to hub)
Witness: Daniel
Temp: 63f
Hum: 47%
120V 60Hz

8/25/2010 11:38:16 AM
Sequence: Preliminary Scan

Compatible Electronics, Inc. FAC-3 (LAB-P)

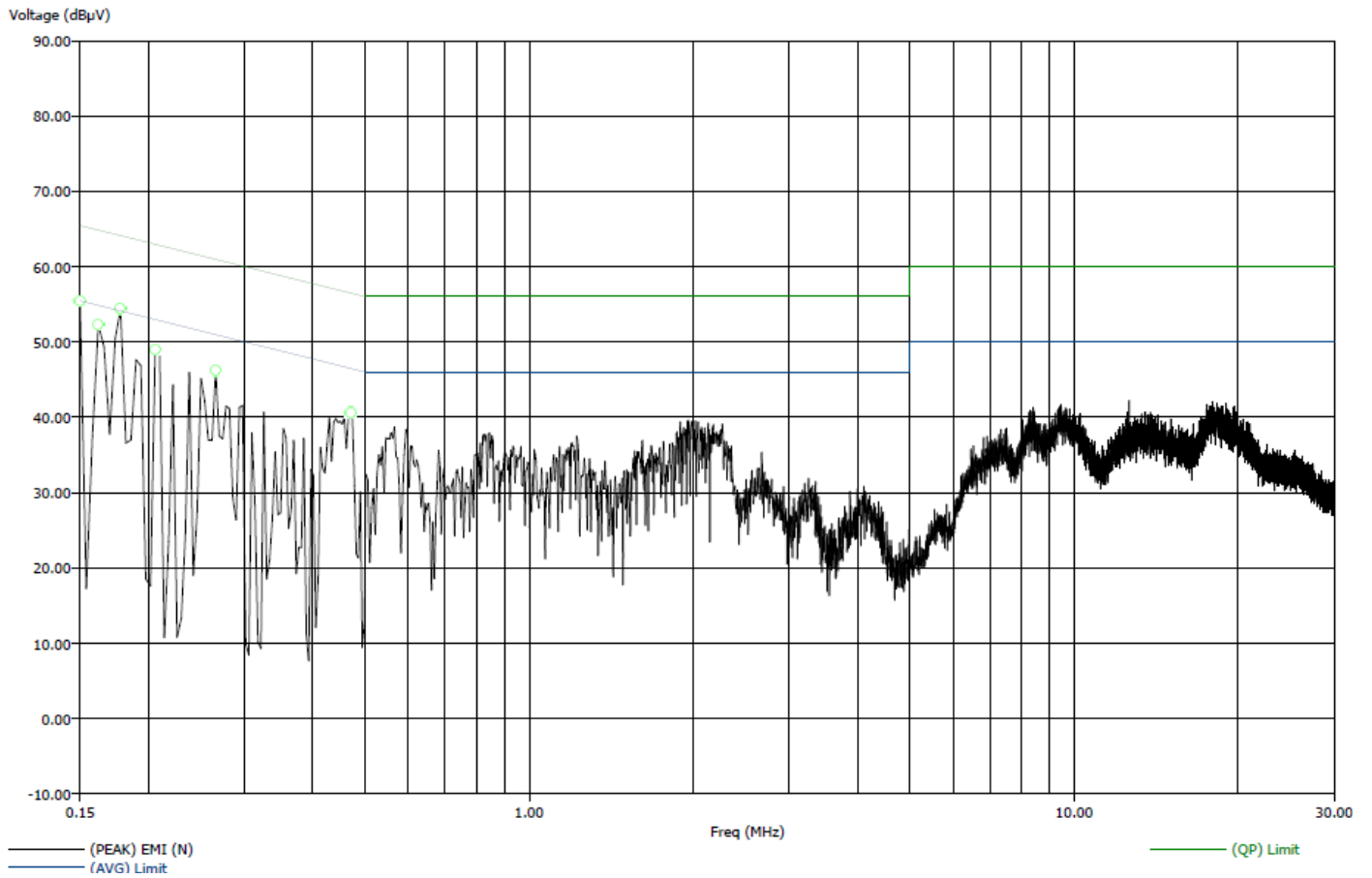

Title: FCC 15.207
 File: Conducted Final-Neutral.set
 Operator: Matt Harrison
 EUT Type: Solo F7C001
 EUT Condition: 802.11b, Ch.1, 6Mb/, AC Adapter (1)
 Comments: USB Terminated to Mouse, and Alt Ethernet terminated to Hub (no power to hub)
 Witness: Daniel
 Temp: 63f
 Hum: 47%
 120V 60Hz

8/25/2010 11:40:47 AM
 Sequence: Final Measurements

Compatible Electronics, Inc. FAC-3 (LAB-P)

Freq (MHz)	(AVG) Margin AVL (dB)	(QP) Margin QPL (dB)	(AVG) EMI (dBμV)	(QP) EMI (dBμV)	(PEAK) EMI (dBμV)	(AVG) Limit (dBμV)	(QP) Limit (dBμV)	Transducer (dB)	Cable (dB)
0.15	-35.23	-16.87	20.22	48.59	56.58	55.46	65.46	0.15	0.05
0.16	-33.15	-17.81	21.70	47.04	55.68	54.85	64.85	0.14	0.05
0.18	-18.81	-14.95	35.30	49.17	56.20	54.11	64.11	0.13	0.05
0.21	-36.36	-21.48	16.61	41.48	49.89	52.97	62.97	0.12	0.05
0.27	-22.04	-20.55	28.92	40.40	47.94	50.96	60.96	0.10	0.08
0.47	-21.44	-17.14	25.05	39.35	42.28	46.49	56.49	0.07	0.13

Title: FCC 15.207
File: Conducted Pre-Line2.set
Operator: Matt Harrison
EUT Type: Solo F7C001
EUT Condition: 802.11b, Ch.1, 6Mb/, AC Adapter (2)
Comments: USB Terminated to Mouse, and Alt Ethernet terminated to Hub (no power to hub)
Witness: Daniel
Temp: 63f
Hum: 47%
120V 60Hz

8/25/2010 11:54:44 AM
Sequence: Preliminary Scan

Compatible Electronics, Inc. FAC-3 (LAB-P)

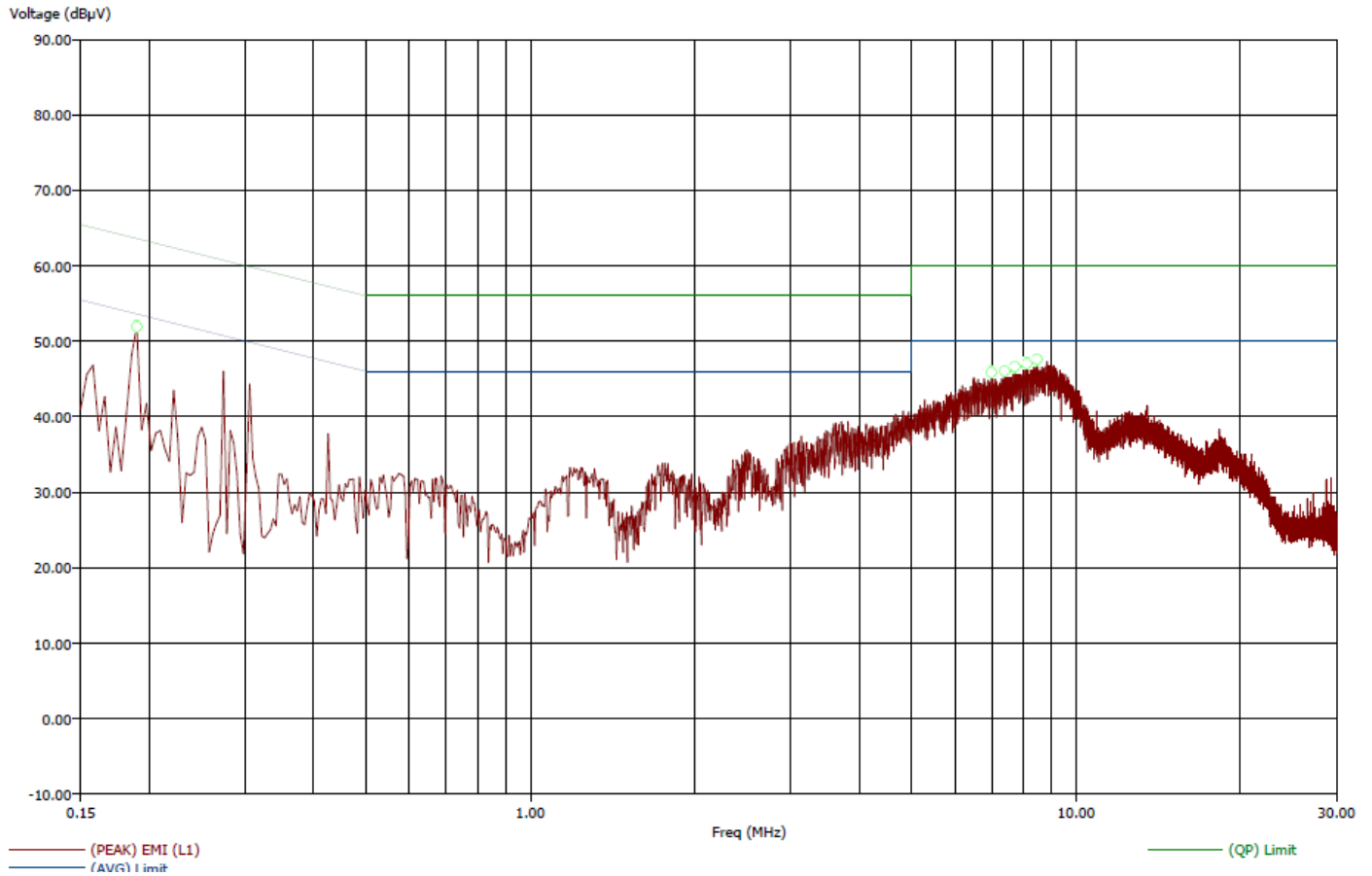

Title: FCC 15.207
File: Conducted Final-Line2.set
Operator: Matt Harrison
EUT Type: Solo F7C001
EUT Condition: 802.11b, Ch.1, 6Mb/, AC Adapter (2)
Comments: USB Terminated to Mouse, and Alt Ethernet terminated to Hub (no power to hub)
Witness: Daniel
Temp: 63f
Hum: 47%
120V 60Hz

8/25/2010 11:57:18 AM
Sequence: Final Measurements

Compatible Electronics, Inc. FAC-3 (LAB-P)

Freq (MHz)	(AVG) Margin AVL (dB)	(QP) Margin QPL (dB)	(AVG) EMI (dBµV)	(QP) EMI (dBµV)	(PEAK) EMI (dBµV)	(AVG) Limit (dBµV)	(QP) Limit (dBµV)	Transducer (dB)	Cable (dB)
0.19	-39.66	-27.32	13.95	36.28	48.93	53.60	63.60	0.00	0.05
7.00	-18.29	-18.52	31.71	41.48	46.39	50.00	60.00	0.67	0.22
7.41	-17.92	-18.02	32.08	41.98	46.99	50.00	60.00	0.70	0.23
7.74	-17.49	-17.61	32.51	42.39	46.96	50.00	60.00	0.74	0.24
8.13	-16.89	-17.00	33.11	43.00	47.96	50.00	60.00	0.78	0.25
8.49	-16.29	-16.70	33.71	43.30	48.10	50.00	60.00	0.80	0.26

Title: FCC 15.207
File: Conducted Pre-Neutral2.set
Operator: Matt Harrison
EUT Type: Solo F7C001
EUT Condition: 802.11b, Ch.1, 6Mb/, AC Adapter (2)
Comments: USB Terminated to Mouse, and Alt Ethernet terminated to Hub (no power to hub)
Witness: Daniel
Temp: 63f
Hum: 47%
120V 60Hz

8/25/2010 12:04:13 PM
Sequence: Preliminary Scan

Compatible Electronics, Inc. FAC-3 (LAB-P)

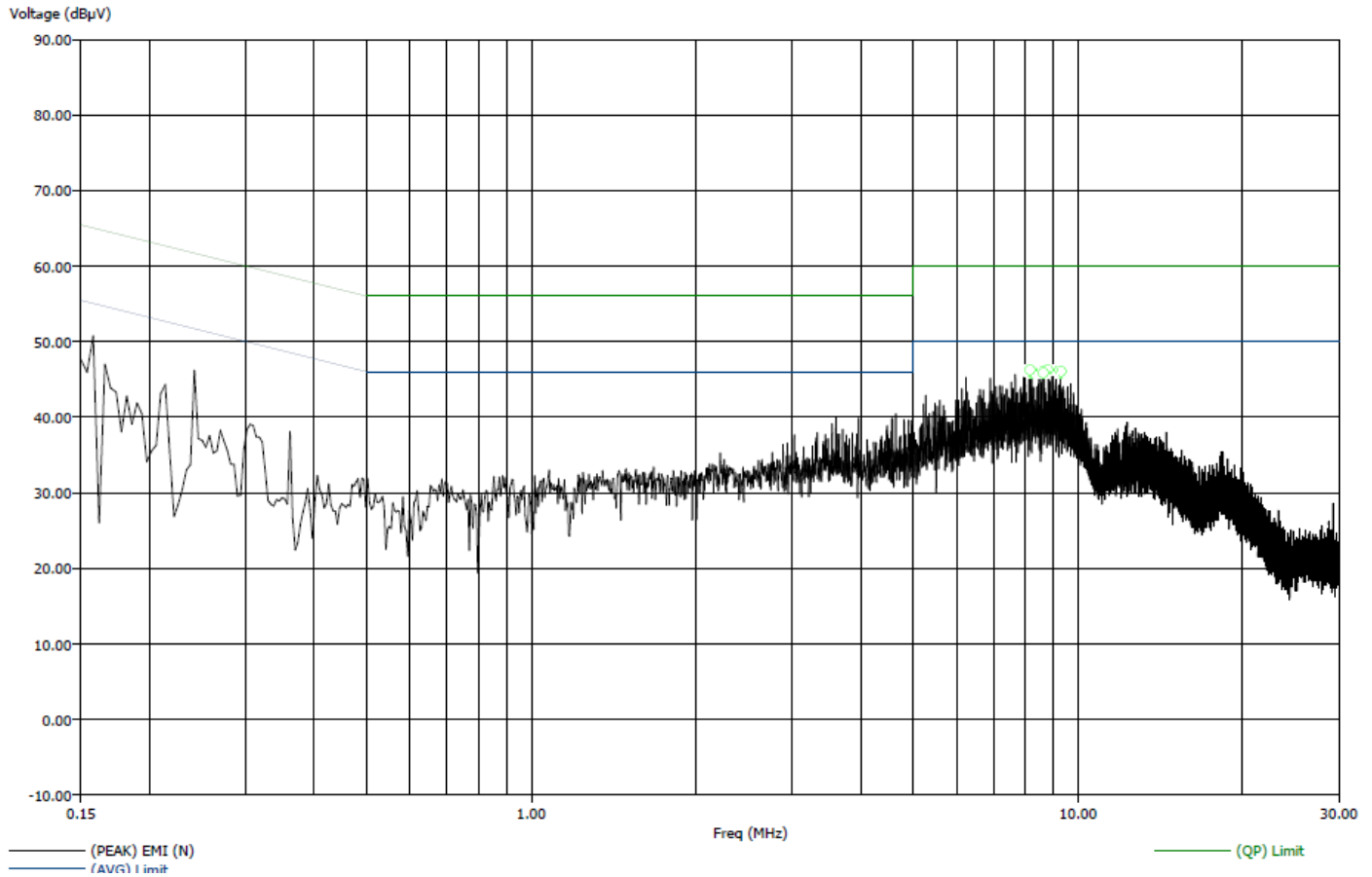

Title: FCC 15.207
File: Conducted Final-Neutral2.set
Operator: Matt Harrison
EUT Type: Solo F7C001
EUT Condition: 802.11b, Ch.1, 6Mb/, AC Adapter (2)
Comments: USB Terminated to Mouse, and Alt Ethernet terminated to Hub (no power to hub)
Witness: Daniel
Temp: 63f
Hum: 47%
120V 60Hz

8/25/2010 12:07:00 PM
Sequence: Final Measurements

Compatible Electronics, Inc. FAC-3 (LAB-P)

Freq (MHz)	(AVG) Margin AVL (dB)	(QP) Margin QPL (dB)	(AVG) EMI (dBµV)	(QP) EMI (dBµV)	(PEAK) EMI (dBµV)	(AVG) Limit (dBµV)	(QP) Limit (dBµV)	Transducer (dB)	Cable (dB)
8.18	-22.39	-22.41	27.61	37.59	47.09	50.00	60.00	0.23	0.25
8.23	-22.18	-22.47	27.82	37.53	47.01	50.00	60.00	0.23	0.25
8.66	-22.12	-22.24	27.88	37.76	47.62	50.00	60.00	0.25	0.26
8.82	-22.11	-22.30	27.89	37.70	47.25	50.00	60.00	0.25	0.27
8.97	-21.98	-22.43	28.02	37.57	46.43	50.00	60.00	0.25	0.27
9.28	-22.28	-22.96	27.72	37.04	46.51	50.00	60.00	0.27	0.28

Title: FCC 15.207
File: Conducted Pre-Line.set
Operator: Matt Harrison
EUT Type: Solo F7C001
EUT Condition: 802.11g, Ch.1, 6Mb/, AC Adapter (1)
Comments: USB Terminated to Mouse, and Alt Ethernet terminated to Hub (no power to hub)
Witness: Daniel
Temp: 63f
Hum: 47%
120V 60Hz

9/3/2010 3:00:37 PM
Sequence: Preliminary Scan

Compatible Electronics, Inc. FAC-3 (LAB-P)

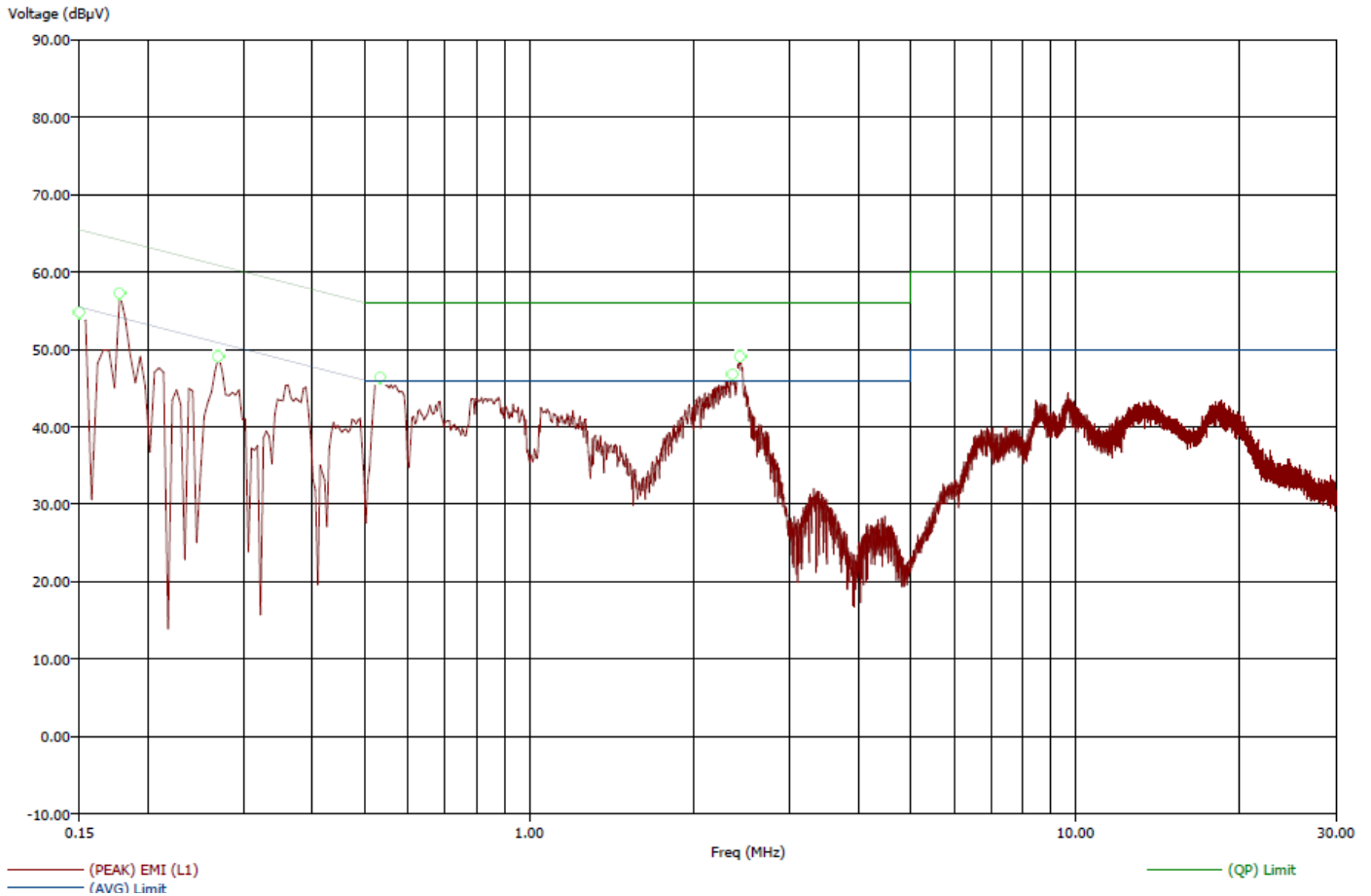

Title: FCC 15.207
File: Conducted Final-Line.set
Operator: Matt Harrison
EUT Type: Solo F7C001
EUT Condition: 802.11g, Ch.1, 6Mb/, AC Adapter (1)
Comments: USB Terminated to Mouse, and Alt Ethernet terminated to Hub (no power to hub)
Witness: Daniel
Temp: 63f
Hum: 47%
120V 60Hz

9/3/2010 3:04:23 PM
Sequence: Final Measurements

Compatible Electronics, Inc. FAC-3 (LAB-P)

Freq (MHz)	(AVG) Margin AVL (dB)	(QP) Margin QPL (dB)	(AVG) EMI (dBµV)	(QP) EMI (dBµV)	(PEAK) EMI (dBµV)	(AVG) Limit (dBµV)	(QP) Limit (dBµV)	Transducer (dB)	Cable (dB)
0.15	-35.79	-17.94	19.67	47.52	59.51	55.46	65.46	0.00	0.05
0.18	-14.40	-12.19	39.71	51.92	57.76	54.11	64.11	0.00	0.05
0.27	-16.31	-15.80	34.53	45.04	50.86	50.84	60.84	0.00	0.08
0.53	-13.73	-10.81	32.27	45.19	47.45	46.00	56.00	0.16	0.13
2.35	-10.54	-13.14	35.46	42.86	46.75	46.00	56.00	0.23	0.18
2.43	-9.38	-11.77	36.62	44.23	48.93	46.00	56.00	0.28	0.18

Title: FCC 15.207
File: Conducted Pre-Neutral.set
Operator: Matt Harrison
EUT Type: Solo F7C001
EUT Condition: 802.11g, Ch.1, 6Mb/, AC Adapter (1)
Comments: USB Terminated to Mouse, and Alt Ethernet terminated to Hub (no power to hub)
Witness: Daniel
Temp: 63f
Hum: 47%
120V 60Hz

9/3/2010 3:11:25 PM
Sequence: Preliminary Scan

Compatible Electronics, Inc. FAC-3 (LAB-P)

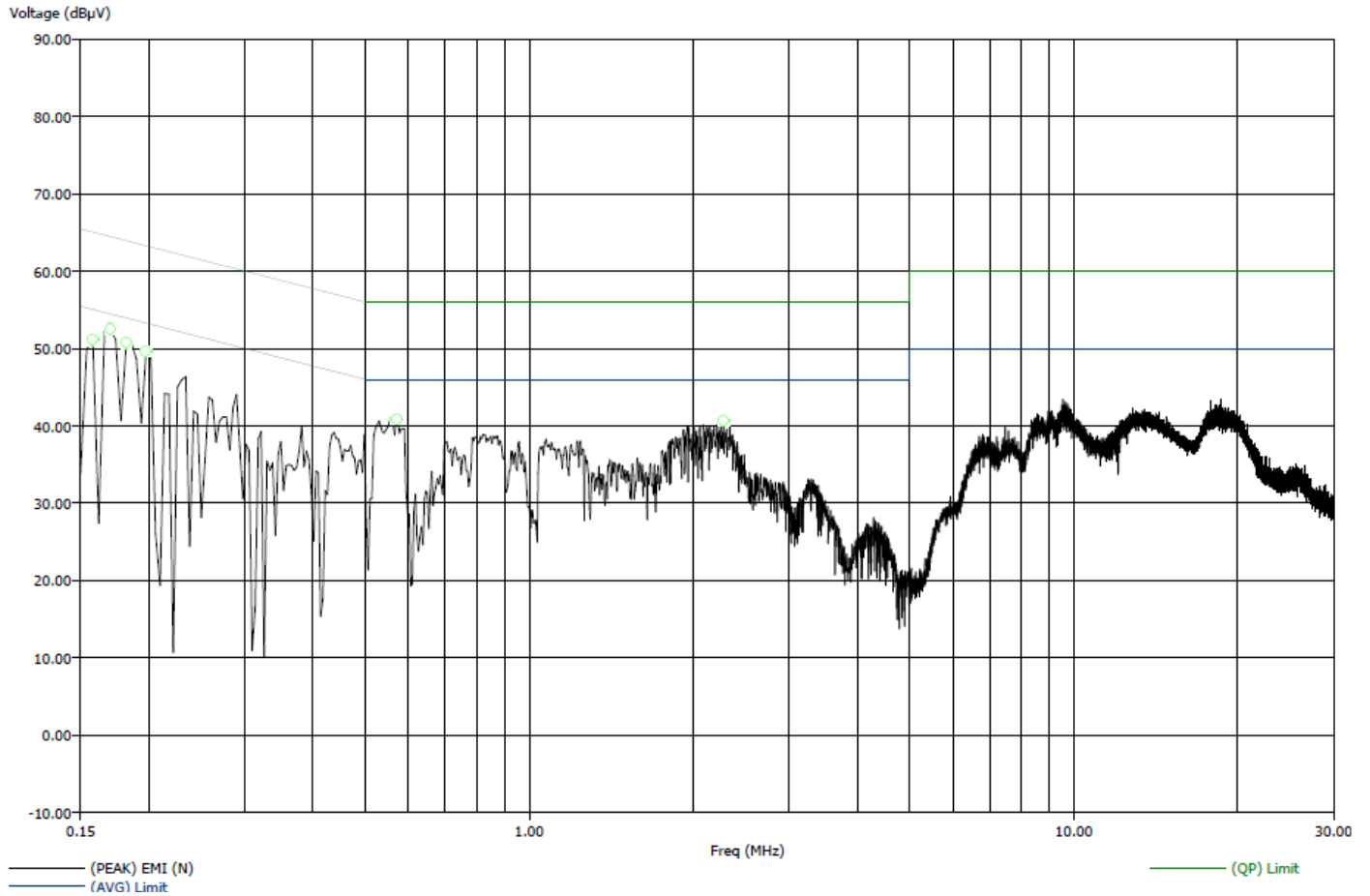

Title: FCC 15.207
File: Conducted Final-Neutral.set
Operator: Matt Harrison
EUT Type: Solo F7C001
EUT Condition: 802.11g, Ch.1, 6Mb/, AC Adapter (1)
Comments: USB Terminated to Mouse, and Alt Ethernet terminated to Hub (no power to hub)
Witness: Daniel
Temp: 63f
Hum: 47%
120V 60Hz

9/3/2010 3:14:15 PM
Sequence: Final Measurements

Compatible Electronics, Inc. FAC-3 (LAB-P)

Freq (MHz)	(AVG) Margin AVL (dB)	(QP) Margin QPL (dB)	(AVG) EMI (dBµV)	(QP) EMI (dBµV)	(PEAK) EMI (dBµV)	(AVG) Limit (dBµV)	(QP) Limit (dBµV)	Transducer (dB)	Cable (dB)
0.16	-35.77	-18.56	19.28	46.49	55.68	55.05	65.05	0.14	0.05
0.17	-27.59	-18.89	26.89	45.59	56.86	54.47	64.47	0.13	0.05
0.18	-16.73	-14.41	37.21	49.53	55.38	53.94	63.94	0.13	0.05
0.20	-23.61	-17.12	29.66	46.16	53.46	53.28	63.28	0.12	0.05
0.57	-21.03	-17.10	24.97	38.90	42.41	46.00	56.00	0.07	0.13
2.27	-21.77	-20.47	24.23	35.53	41.28	46.00	56.00	0.08	0.19

Title: FCC 15.207
File: Conducted Pre-Line 2.set
Operator: Matt Harrison
EUT Type: Solo F7C001
EUT Condition: 802.11g, Ch.1, 6Mb/s, AC Adapter (2)
Comments: USB Terminated to Mouse, and Alt Ethernet terminated to Hub (no power to hub)
Witness: Daniel
Temp: 63f
Hum: 47%
120V 60Hz

9/3/2010 3:31:55 PM
Sequence: Preliminary Scan

Compatible Electronics, Inc. FAC-3 (LAB-P)

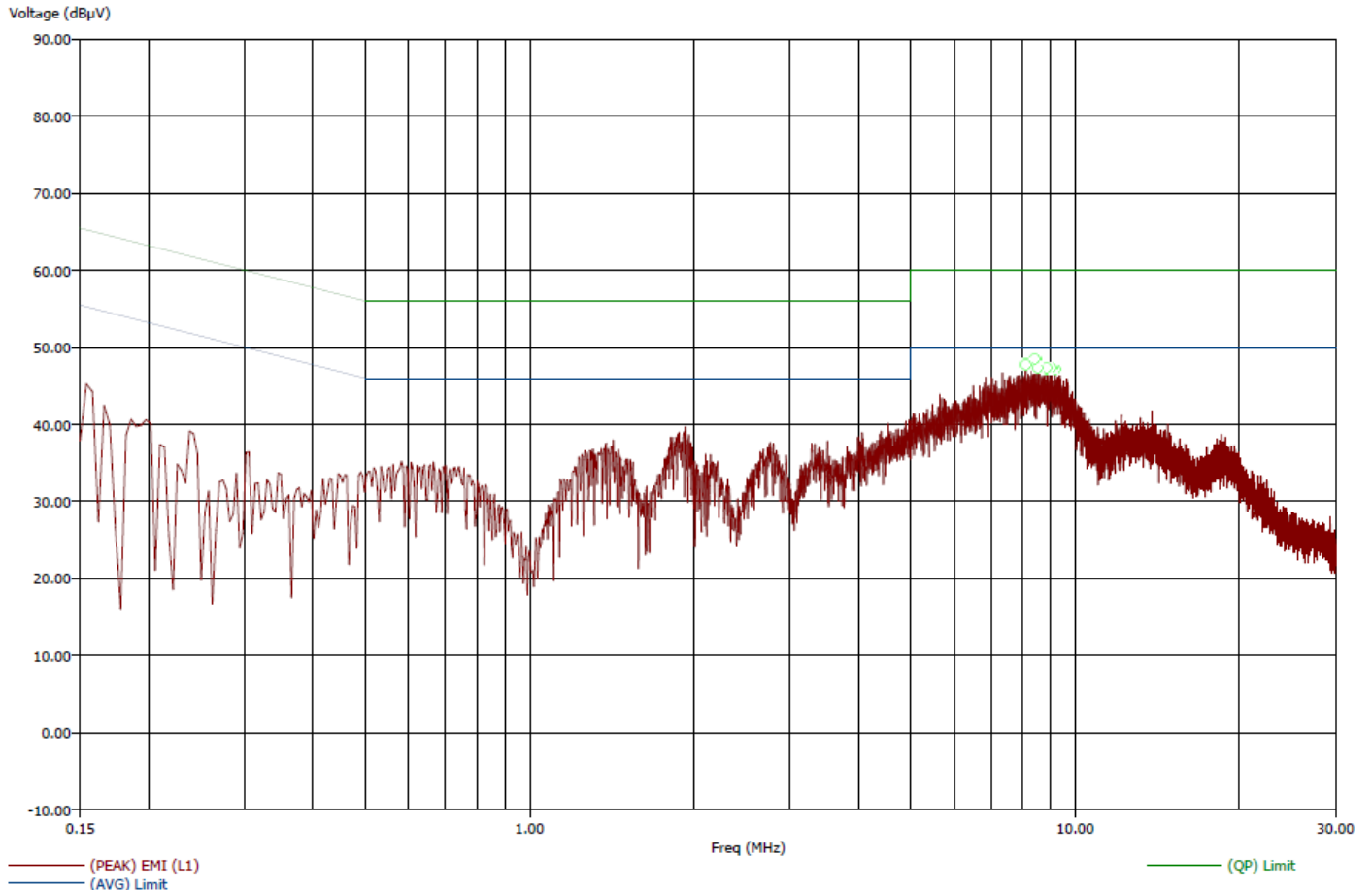

Title: FCC 15.207
File: Conducted Final-Line 2.set
Operator: Matt Harrison
EUT Type: Solo F7C001
EUT Condition: 802.11g, Ch.1, 6Mb/s, AC Adapter (2)
Comments: USB Terminated to Mouse, and Alt Ethernet terminated to Hub (no power to hub)
Witness: Daniel
Temp: 63f
Hum: 47%
120V 60Hz

9/3/2010 3:36:31 PM
Sequence: Final Measurements

Compatible Electronics, Inc. FAC-3 (LAB-P)

Freq (MHz)	(AVG) Margin AVL (dB)	(QP) Margin QPL (dB)	(AVG) EMI (dBµV)	(QP) EMI (dBµV)	(PEAK) EMI (dBµV)	(AVG) Limit (dBµV)	(QP) Limit (dBµV)	Transducer (dB)	Cable (dB)
8.10	-17.97	-17.34	32.03	42.66	48.31	50.00	60.00	0.78	0.25
8.44	-17.58	-17.07	32.42	42.93	49.05	50.00	60.00	0.79	0.26
8.53	-17.55	-17.28	32.45	42.72	48.86	50.00	60.00	0.80	0.26
8.86	-17.38	-17.32	32.62	42.68	48.60	50.00	60.00	0.82	0.27
9.05	-17.62	-17.54	32.38	42.46	48.69	50.00	60.00	0.83	0.27
9.19	-17.65	-17.61	32.35	42.39	48.53	50.00	60.00	0.83	0.27

Title: FCC 15.207
File: Conducted Pre-Neutral 2.set
Operator: Matt Harrison
EUT Type: Solo F7C001
EUT Condition: 802.11g, Ch.1, 6Mb/s, AC Adapter (2)
Comments: USB Terminated to Mouse, and Alt Ethernet terminated to Hub (no power to hub)
Witness: Daniel
Temp: 63f
Hum: 47%
120V 60Hz

9/3/2010 3:43:43 PM
Sequence: Preliminary Scan

Compatible Electronics, Inc. FAC-3 (LAB-P)

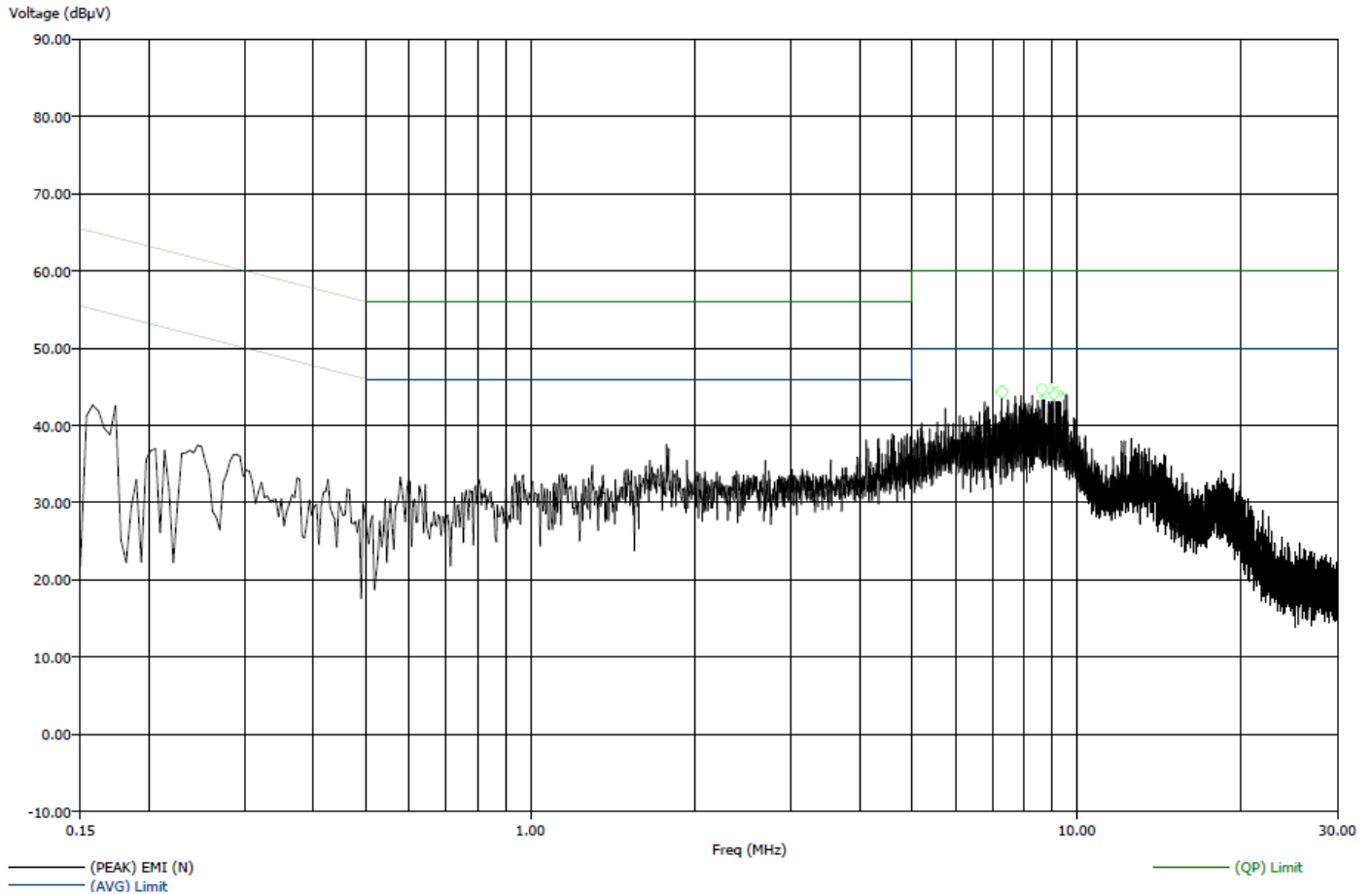

Title: FCC 15.207
File: Conducted Final-Neutral 2.set
Operator: Matt Harrison
EUT Type: Solo F7C001
EUT Condition: 802.11g, Ch.1, 6Mb/s, AC Adapter (2)
Comments: USB Terminated to Mouse, and Alt Ethernet terminated to Hub (no power to hub)
Witness: Daniel
Temp: 63f
Hum: 47%
120V 60Hz

9/3/2010 3:47:03 PM
Sequence: Final Measurements

Compatible Electronics, Inc. FAC-3 (LAB-P)

Freq (MHz)	(AVG) Margin AVL (dB)	(QP) Margin QPL (dB)	(AVG) EMI (dBµV)	(QP) EMI (dBµV)	(PEAK) EMI (dBµV)	(AVG) Limit (dBµV)	(QP) Limit (dBµV)	Transducer (dB)	Cable (dB)
7.29	-24.03	-23.79	25.97	36.21	45.39	50.00	60.00	0.20	0.23
8.64	-23.19	-22.73	26.81	37.27	46.33	50.00	60.00	0.25	0.26
8.70	-22.97	-23.08	27.03	36.92	46.22	50.00	60.00	0.25	0.26
8.87	-23.08	-23.09	26.92	36.91	46.28	50.00	60.00	0.25	0.27
9.07	-23.23	-23.28	26.77	36.72	46.33	50.00	60.00	0.26	0.27
9.22	-23.57	-23.61	26.43	36.39	45.83	50.00	60.00	0.26	0.27

Title: FCC 15.207
File: Conducted Pre-Line 3.set
Operator: Matt Harrison
EUT Type: Solo F7C001
EUT Condition: 802.11g, Ch.6, Receive Only Mode (Transmitter Off)
Comments: USB Terminated to Mouse, and Alt Ethernet terminated to Hub (no power to hub)
Witness: Daniel
Temp: 63f
Hum: 47%
120V 60Hz

9/3/2010 4:01:11 PM
Sequence: Preliminary Scan

Compatible Electronics, Inc. FAC-3 (LAB-P)

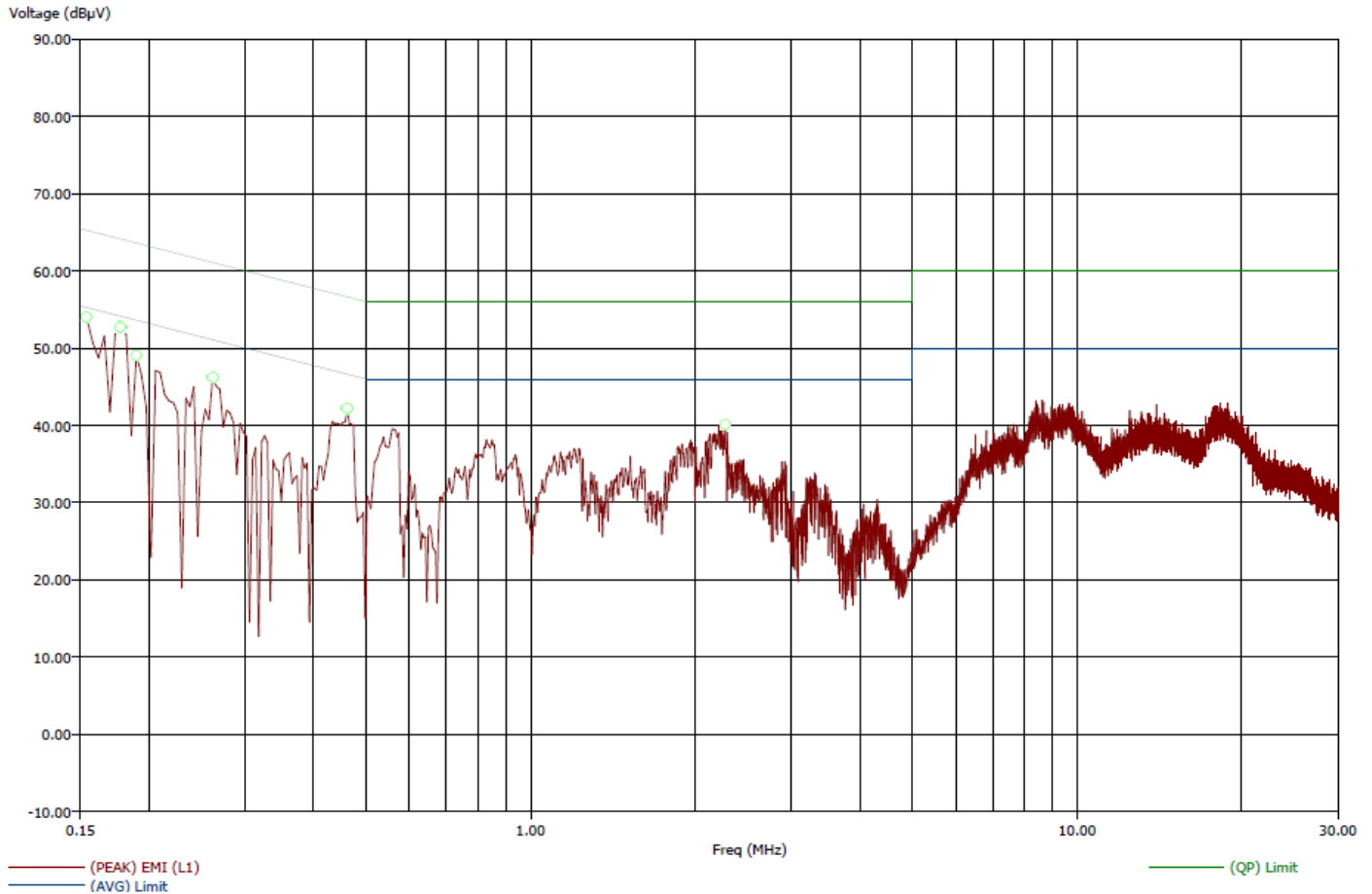

Title: FCC 15.207
File: Conducted Final-Line 3.set
Operator: Matt Harrison
EUT Type: Solo F7C001
EUT Condition: 802.11g, Ch.6, Receive Only Mode (Transmitter Off)
Comments: USB Terminated to Mouse, and Alt Ethernet terminated to Hub (no power to hub)
Witness: Daniel
Temp: 63f
Hum: 47%
120V 60Hz

9/3/2010 4:04:22 PM
Sequence: Final Measurements

Compatible Electronics, Inc. FAC-3 (LAB-P)

Freq (MHz)	(AVG) Margin AVL (dB)	(QP) Margin QPL (dB)	(AVG) EMI (dB μ V)	(QP) EMI (dB μ V)	(PEAK) EMI (dB μ V)	(AVG) Limit (dB μ V)	(QP) Limit (dB μ V)	Transducer (dB)	Cable (dB)
0.15	-34.45	-18.10	20.80	47.16	55.54	55.25	65.25	0.00	0.05
0.18	-17.68	-13.69	36.43	50.42	55.64	54.11	64.11	0.00	0.05
0.19	-20.81	-15.39	32.80	48.21	54.14	53.60	63.60	0.00	0.05
0.26	-20.14	-18.93	30.94	42.15	48.85	51.08	61.08	0.00	0.08
0.46	-19.31	-16.87	27.31	39.75	42.92	46.62	56.62	0.16	0.13
2.27	-22.88	-21.16	23.12	34.84	41.57	46.00	56.00	0.23	0.19

Title: FCC 15.207
File: Conducted Pre-Neutral 3.set
Operator: Matt Harrison
EUT Type: Solo F7C001
EUT Condition: 802.11g, Ch.1, Receive Only Mode (Transmitter Off)
Comments: USB Terminated to Mouse, and Alt Ethernet terminated to Hub (no power to hub)
Witness: Daniel
Temp: 63f
Hum: 47%
120V 60Hz

9/3/2010 4:11:01 PM
Sequence: Preliminary Scan

Compatible Electronics, Inc. FAC-3 (LAB-P)

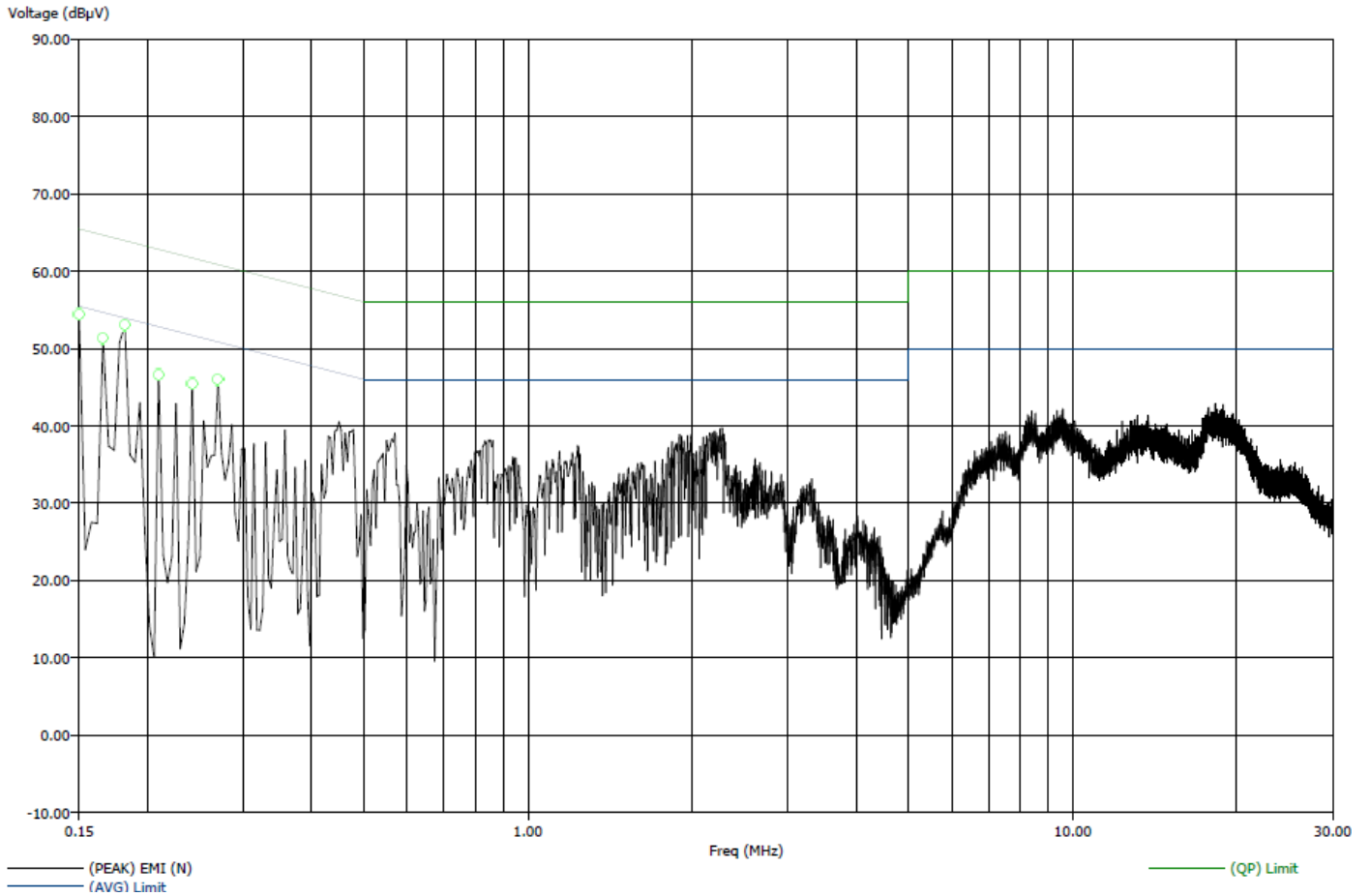

Title: FCC 15.207
File: Conducted Final-Neutral 3.set
Operator: Matt Harrison
EUT Type: Solo F7C001
EUT Condition: 802.11g, Ch.1, Receive Only Mode (Transmitter Off)
Comments: USB Terminated to Mouse, and Alt Ethernet terminated to Hub (no power to hub)
Witness: Daniel
Temp: 63f
Hum: 47%
120V 60Hz

9/3/2010 4:13:47 PM
Sequence: Final Measurements

Compatible Electronics, Inc. FAC-3 (LAB-P)

Freq (MHz)	(AVG) Margin AVL (dB)	(QP) Margin QPL (dB)	(AVG) EMI (dB μ V)	(QP) EMI (dB μ V)	(PEAK) EMI (dB μ V)	(AVG) Limit (dB μ V)	(QP) Limit (dB μ V)	Transducer (dB)	Cable (dB)
0.15	-33.65	-13.97	21.81	51.48	59.46	55.46	65.46	0.15	0.05
0.17	-30.12	-19.44	24.54	45.22	54.87	54.66	64.66	0.14	0.05
0.18	-18.85	-14.88	35.09	49.06	55.69	53.94	63.94	0.13	0.05
0.21	-37.39	-18.27	15.43	44.54	52.70	52.81	62.81	0.11	0.05
0.24	-34.64	-23.77	17.06	37.93	46.10	51.70	61.70	0.10	0.07
0.27	-22.41	-21.08	28.43	39.76	47.74	50.84	60.84	0.10	0.08

RADIATED EMISSIONS

DATA SHEETS

Title: FCC 15.209
File: Radiated Pre-scan 30-1000Mhz.set
Operator: Matt Harrison
EUT Type: Solo F7C001
EUT Condition: 802.11b, "Worst Case" Ch.1, 6Mb/s, AC Adapter (2)
Comments: USB Terminated to Mouse, and Alt Ethernet terminated to Hub (no power to hub)
Temp: 62f
Hum: 50%
120V 60Hz

8/25/2010 9:33:01 AM
Sequence: Preliminary Scan

Compatible Electronics, Inc. FAC-3 (LAB P)

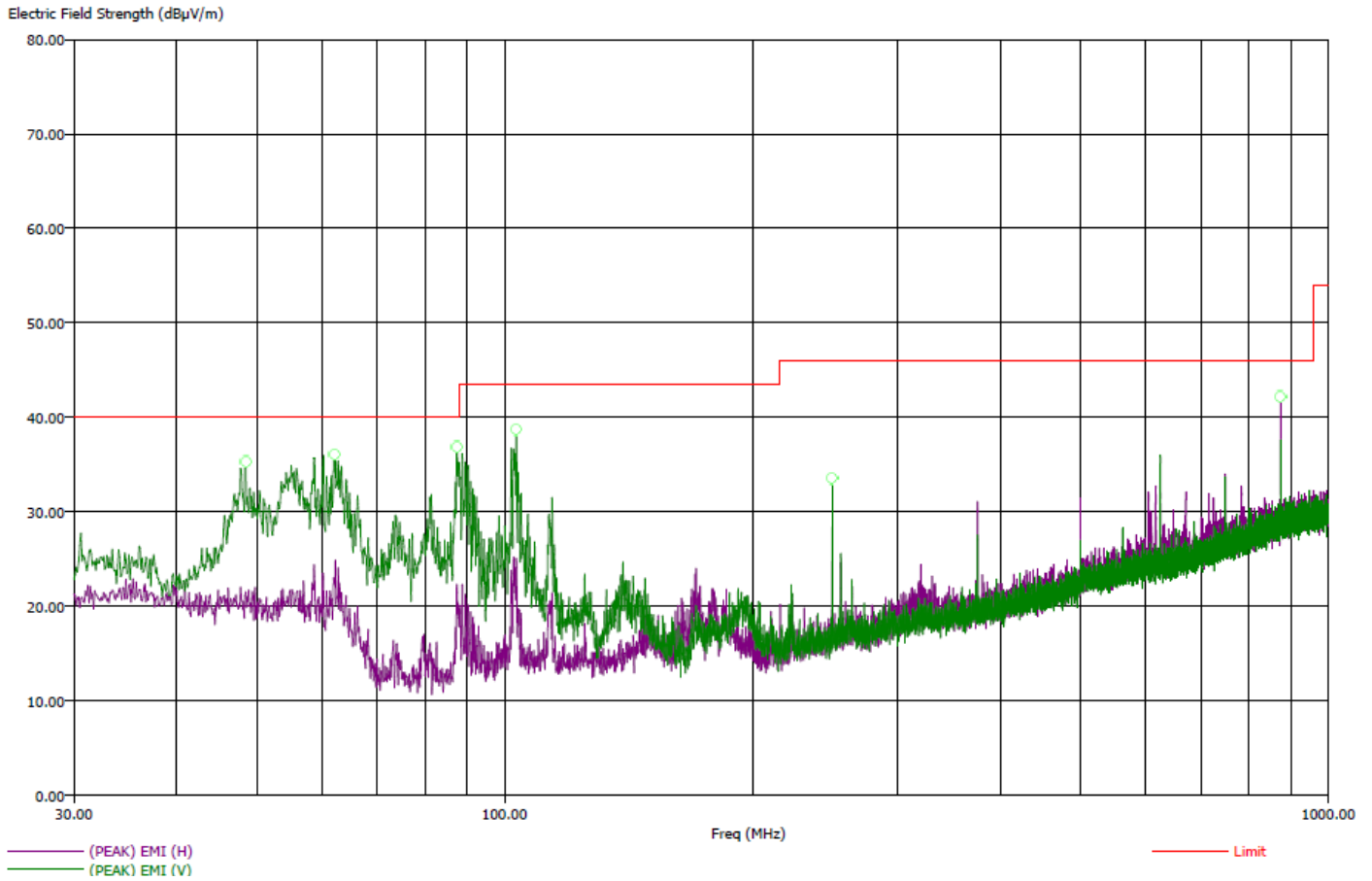

Title: FCC 15.209
File: Radiated Pre-Scan 30-2000Mhz.set
Operator: Matt Harrison
EUT Type: Solo F7C001
EUT Condition: 802.11b, "Worst Case" Ch.1, 6Mb/s, AC Adapter (2)
Comments: USB Terminated to Mouse, and Alt Ethernet terminated to Hub (no power to hub)
Temp: 62f
Hum: 50%
120V 60Hz

8/25/2010 10:37:59 AM
Sequence: Preliminary Scan

Compatible Electronics, Inc. FAC-3 (LAB P)

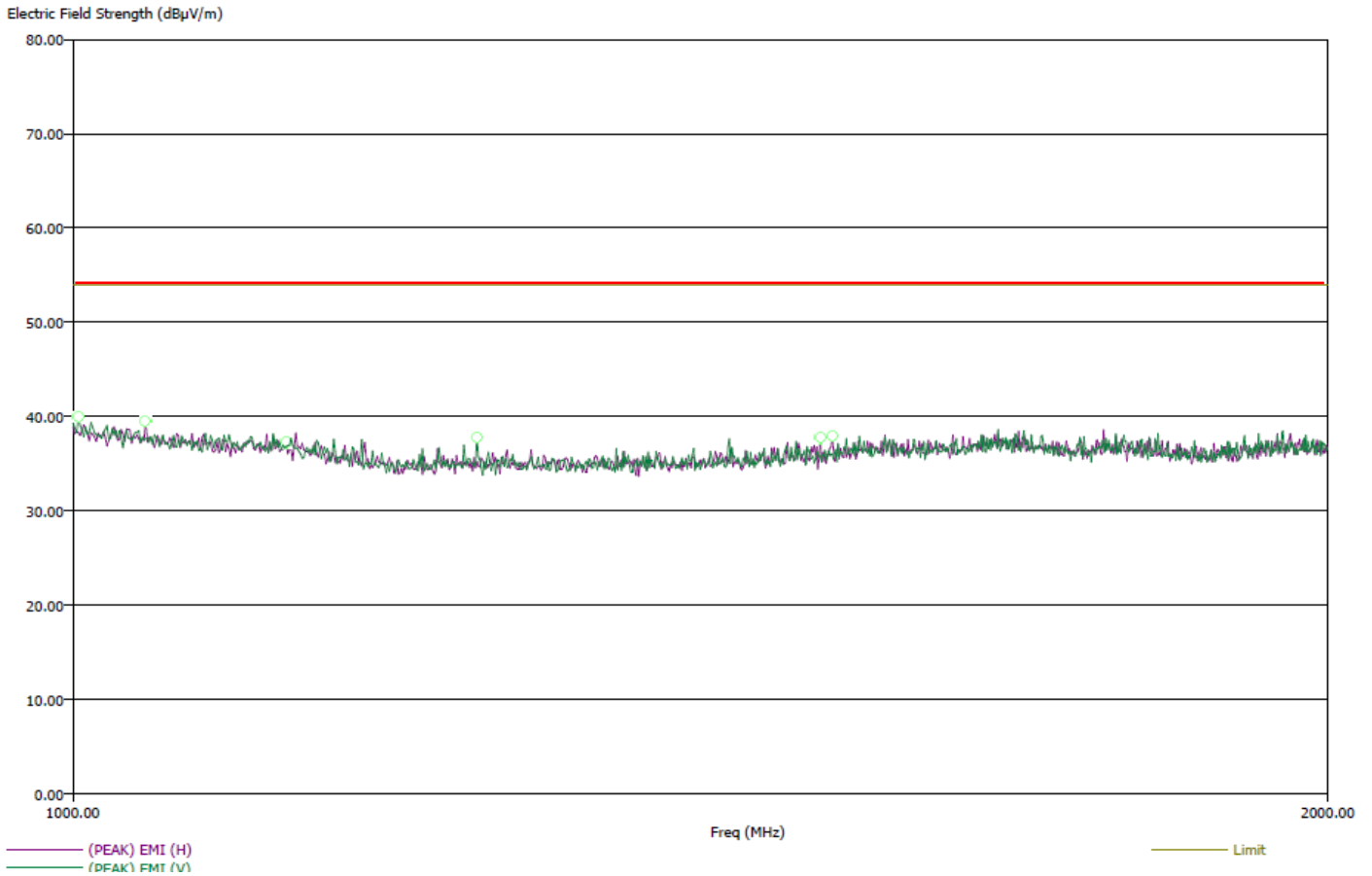

Title: FCC 15.209
 File: Radiated Final 30-1000Mhz.set
 Operator: Matt Harrison
 EUT Type: Solo F7C001
 EUT Condition: 802.11b, "Worst Case" Ch.1, 6Mb/s, AC Adapter (2)
 Comments: USB Terminated to Mouse, and Alt Ethernet terminated to Hub (no power to hub)
 Temp: 62f
 Hum: 50%
 120V 60Hz

8/25/2010
 Sequence: Final Measurements

Compatible Electronics, Inc. FAC-3 (LAB P)

Freq (MHz)	(QP) Margin (dB)	(QP) EMI (dBµV/m)	(PEAK) EMI (dBµV/m)	Limit (dBµV/m)	Pol	Ttbl Agl (deg)	Twr Ht (cm)	Transducer (dB)	Cable (dB)
48.50	-6.98	33.02	36.26	40.00	V	0.00	99.35	16.68	0.72
62.10	-5.87	34.13	38.00	40.00	V	187.00	109.41	12.41	0.83
87.50	-4.34	35.66	37.62	40.00	V	360.00	104.11	8.93	1.01
103.30	-3.95	39.57	41.84	43.52	V	182.50	106.35	10.49	1.08
250.00	-8.95	37.05	38.21	46.00	V	45.00	114.35	13.80	1.60
875.00	-7.51	38.49	41.16	46.00	H	274.50	103.94	22.11	3.64

Freq (MHz)	(AVG) Margin (dB)	(PEAK) Margin (dB)	(AVG) EMI (dBµV/m)	(PEAK) EMI (dBµV/m)	(AVG) Limit (dBµV/m)	(PEAK) Limit (dBµV/m)	Pol	Ttbl Agl (deg)	Twr Ht (cm)
1003.00	-26.29	-21.21	27.69	32.77	53.98	53.98	V	144.50	270.41
1041.00	-27.10	-14.76	26.88	39.22	53.98	53.98	H	71.25	265.11
1125.00	-27.35	-14.88	26.63	39.10	53.98	53.98	H	293.00	208.29
1250.00	-23.85	-14.25	30.13	39.73	53.98	53.98	V	176.25	124.23
1511.00	-28.86	-16.19	25.12	37.79	53.98	53.98	H	189.00	138.29
1521.00	-28.66	-16.27	25.32	37.71	53.98	53.98	H	321.25	129.82

No Spurious Emissions found below 30 MHz or above 1,521.00 MHz

FCC 15.247

Belkin International, Inc.
 802.11 b and 802.11 g Device
 Model: F7C001

Date: 09/01/2010
 Lab: P
 Tested By: Kyle Fujimoto

Channel 1 - 802.11 b Mode

Freq. (MHz)	Level (dBuV)	Pol (v/h)	Limit	Margin	Peak / QP / Avg	Ant. Height (m)	Table Angle (deg)	Comments
4824	44.19	H	74	-29.81	Peak	1.5	280	
4824	33.14	H	54	-20.86	Avg	1.5	280	
7236	50.36	H	74	-23.64	Peak	1.3	270	
7236	36.55	H	54	-17.45	Avg	1.3	270	
9648		H	--	--	Peak			Not in Restricted Band
9648		H	--	--	Avg			Not in Restricted Band
12060	59.89	H	74	-14.11	Peak	1	240	
12060	45.39	H	54	-8.61	Avg	1	240	
14472	62.01	H	74	-11.99	Peak	1	225.25	
14472	47.71	H	54	-6.29	Avg	1	225.25	
16884		H	--	--	Peak			Not in Restricted Band
16884		H	--	--	Avg			Not in Restricted Band
19296	50.83	H	74	-23.16	Peak	1	220	
19296	37.31	H	54	-16.68	Avg	1	220	
21708		H	--	--	Peak			Not in Restricted Band
21708		H	--	--	Avg			Not in Restricted Band
24120		H	--	--	Peak			Not in Restricted Band
24120		H	--	--	Avg			Not in Restricted Band

FCC 15.247

Belkin International, Inc.
 802.11 b and 802.11 g Device
 Model: F7C001

Date: 09/01/2010
 Lab: P
 Tested By: Kyle Fujimoto

Channel 1 - 802.11 b Mode

Freq. (MHz)	Level (dBuV)	Pol (v/h)	Limit	Margi n	Peak / QP / Avg	Ant. Height (m)	Table Angle (deg)	Comments
4824	43.77	V	74	-30.23	Peak	1.28	304	
4824	30.99	V	54	-23.01	Avg	1.28	304	
7236	51.03	V	74	-22.97	Peak	1.28	285	
7236	36.57	V	54	-17.43	Avg	1.28	285	
9648		V	--	--	Peak			Not in Restricted Band
9648		V	--	--	Avg			Not in Restricted Band
12060	58.83	V	74	-15.17	Peak	1.11	250	
12060	45.41	V	54	-8.59	Avg	1.11	250	
14472	61.18	V	74	-12.82	Peak	1.3	64	
14472	47.74	V	54	-6.26	Avg	1.3	64	
16884		V	--	--	Peak			Not in Restricted Band
16884		V	--	--	Avg			Not in Restricted Band
19296	52.25	V	74	-21.74	Peak	1	220	
19296	37.28	V	54	-16.71	Avg	1	220	
21708		V	--	--	Peak			Not in Restricted Band
21708		V	--	--	Avg			Not in Restricted Band
24120		V	--	--	Peak			Not in Restricted Band
24120		V	--	--	Avg			Not in Restricted Band

FCC 15.247

Belkin International, Inc.
 802.11 b and 802.11 g Device
 Model: F7C001

Date: 09/01/2010
 Lab: P
 Tested By: Kyle Fujimoto

Channel 6 - 802.11 b Mode

Freq. (MHz)	Level (dBuV)	Pol (v/h)	Limit	Margi n	Peak / QP / Avg	Ant. Height (m)	Table Angle (deg)	Comments
4874	44.34	H	74	-29.66	Peak	1.32	322.25	
4874	33.84	H	54	-20.16	Avg	1.32	322.25	
7311	50.23	H	74	-23.77	Peak	1.14	262.25	
7311	36.91	H	54	-17.09	Avg	1.14	262.25	
9748		H	--	--	Peak			Not in Restricted Band
9748		H	--	--	Avg			Not in Restricted Band
12185	59.26	H	74	-14.74	Peak	1.08	333	
12185	45.26	H	54	-8.74	Avg	1.08	333	
14622		H	--	--	Peak			Not in Restricted Band
14622		H	--	--	Avg			Not in Restricted Band
17059		H	--	--	Peak			Not in Restricted Band
17059		H	--	--	Avg			Not in Restricted Band
19496	50.20	H	74	-23.79	Peak	1	130	
19496	36.86	H	54	-17.13	Avg	1	130	
21933		H	--	--	Peak			Not in Restricted Band
21933		H	--	--	Avg			Not in Restricted Band
24370		H	--	--	Peak			Not in Restricted Band
24370		H	--	--	Avg			Not in Restricted Band

FCC 15.247

Belkin International, Inc.
 802.11 b and 802.11 g Device
 Model: F7C001

Date: 09/01/2010
 Lab: P
 Tested By: Kyle Fujimoto

Channel 6 - 802.11 b Mode

Freq. (MHz)	Level (dBuV)	Pol (v/h)	Limit	Margi n	Peak / QP / Avg	Ant. Height (m)	Table Angle (deg)	Comments
4874	44.31	V	74	-29.69	Peak	1.08	300	
4874	30.78	V	54	-23.22	Avg	1.08	300	
7311	50.45	V	74	-23.55	Peak	1.23	134	
7311	36.93	V	54	-17.07	Avg	1.23	134	
9748		V	--	--	Peak			Not in Restricted Band
9748		V	--	--	Avg			Not in Restricted Band
12185	59.26	V	74	-14.74	Peak	1.3	260	
12185	45.3	V	54	-8.7	Avg	1.3	260	
14622		V	--	--	Peak			Not in Restricted Band
14622		V	--	--	Avg			Not in Restricted Band
17059		V	--	--	Peak			Not in Restricted Band
17059		V	--	--	Avg			Not in Restricted Band
19496	50.49	V	74	-23.50	Peak	1	155	
19496	36.82	V	54	-17.17	Avg	1	155	
21933		V	--	--	Peak			Not in Restricted Band
21933		V	--	--	Avg			Not in Restricted Band
24370		V	--	--	Peak			Not in Restricted Band
24370		V	--	--	Avg			Not in Restricted Band

FCC 15.247

Belkin International, Inc.
 802.11 b and 802.11 g Device
 Model: F7C001

Date: 09/01/2010
 Lab: P
 Tested By: Kyle Fujimoto

Channel 11 - 802.11 b Mode

Freq. (MHz)	Level (dBuV)	Pol (v/h)	Limit	Margi n	Peak / QP / Avg	Ant. Height (m)	Table Angle (deg)	Comments
4924	45.86	H	74	-28.14	Peak	1.65	283	
4924	34.59	H	54	-19.41	Avg	1.65	283	
7386	46.8	H	74	-27.2	Peak	1.71	324	
7386	37.85	H	54	-16.15	Avg	1.71	324	
9848		H	--	--	Peak			Not in Restricted Band
9848		H	--	--	Avg			Not in Restricted Band
12310	59.44	H	74	-14.56	Peak	1.47	275	
12310	45.92	H	54	-8.08	Avg	1.47	275	
14772		H	--	--	Peak			Not in Restricted Band
14772		H	--	--	Avg			Not in Restricted Band
17234		H	--	--	Peak			Not in Restricted Band
17234		H	--	--	Avg			Not in Restricted Band
19696	51.45	H	74	-22.54	Peak	1	284	
19696	37.21	H	54	-16.78	Avg	1	284	
22158	53.77	H	74	-20.22	Peak	1	203	
22158	40.17	H	54	-13.82	Avg	1	203	
24620		H	--	--	Peak			Not in Restricted Band
24620		H	--	--	Avg			Not in Restricted Band

FCC 15.247

Belkin International, Inc.
 802.11 b and 802.11 g Device
 Model: F7C001

Date: 09/01/2010
 Lab: P
 Tested By: Kyle Fujimoto

Channel 11 - 802.11 b Mode

Freq. (MHz)	Level (dBuV)	Pol (v/h)	Limit	Margi n	Peak / QP / Avg	Ant. Height (m)	Table Angle (deg)	Comments
4924	45.82	V	74	-28.18	Peak	1.08	34	
4924	34.33	V	54	-19.67	Avg	1.08	34	
7386	50.85	V	74	-23.15	Peak	1.08	286	
7386	37.05	V	54	-16.95	Avg	1.08	286	
9848		V	--	--	Peak			Not in Restricted Band
9848		V	--	--	Avg			Not in Restricted Band
12310	59.7	V	74	-14.3	Peak	1.18	214	
12310	45.88	V	54	-8.12	Avg	1.18	214	
14772		V	--	--	Peak			Not in Restricted Band
14772		V	--	--	Avg			Not in Restricted Band
17234		V	--	--	Peak			Not in Restricted Band
17234		V	--	--	Avg			Not in Restricted Band
19696	50.61	V	74	-23.38	Peak	1	52	
19696	37.37	V	54	-16.62	Avg	1	52	
22158	53.55	V	74	-20.44	Peak	1	63	
22158	40.13	V	54	-13.86	Avg	1	63	
24620		V	--	--	Peak			Not in Restricted Band
24620		V	--	--	Avg			Not in Restricted Band

Title: FCC 15.209 9/3/2010 9:46:25 AM
File: Radiated Pre-Scan 30-1000Mhz.set Sequence: Preliminary Scan
Operator: Matt Harrison
EUT Type: Solo F7C001
EUT Condition: 802.11g, "Worst Case" Ch.1, 6Mb/s, AC Adapter (2)
Comments: USB Terminated to Mouse, and Alt Ethernet terminated to Hub (no power to hub)
Witness: Daniel
Temp: 63f
Hum: 47%
120V 60Hz

Compatible Electronics, Inc. FAC-3 (LAB P)

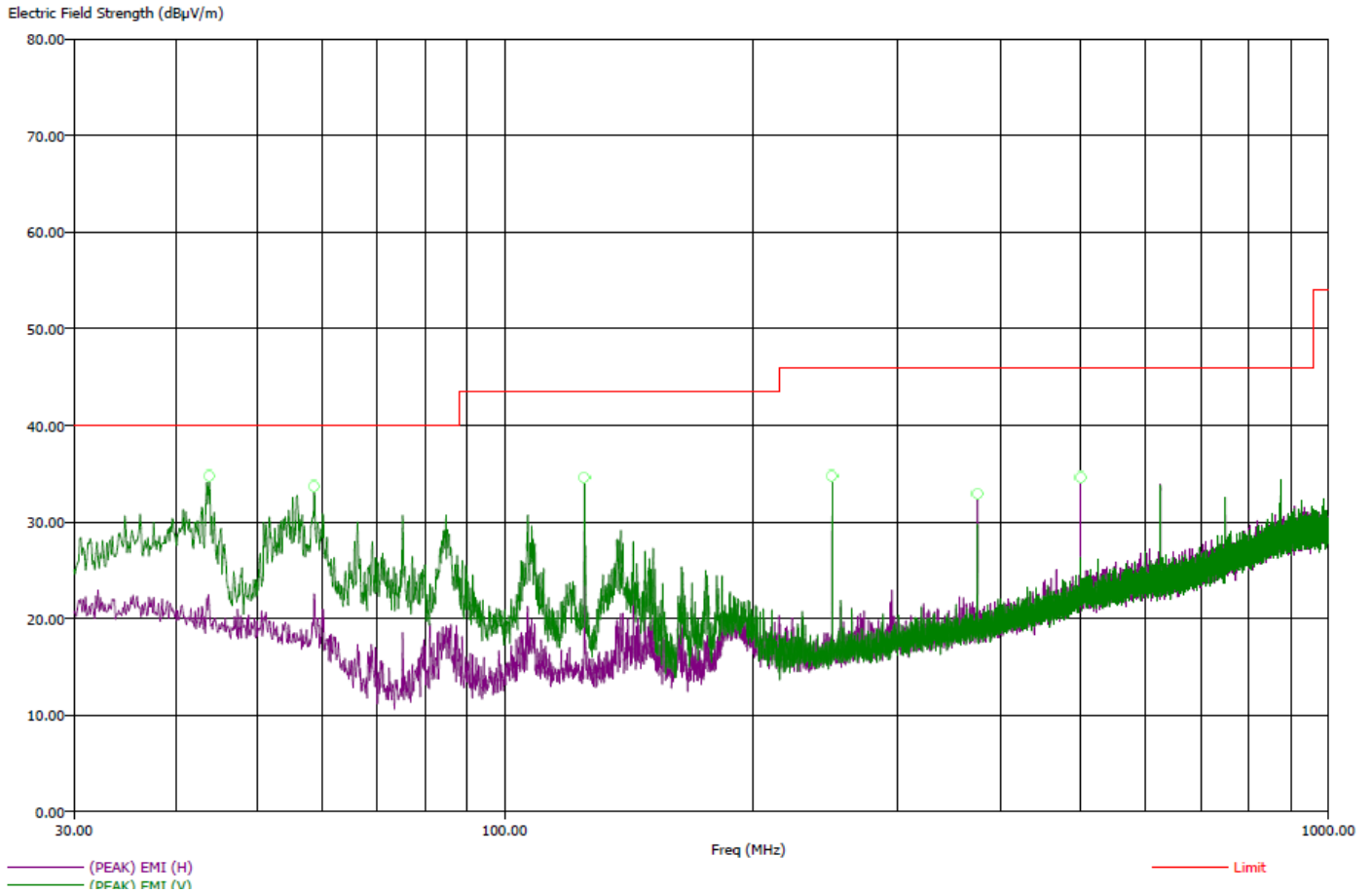

Title: FCC 15.209
File: Radiated Pre-Scan 30-2000Mhz.set
Operator: Matt Harrison
EUT Type: Solo F7C001
EUT Condition: 802.11g, "Worst Case" Ch.1, 6Mb/s, AC Adapter (2)
Comments: USB Terminated to Mouse, and Alt Ethernet terminated to Hub (no power to hub)
Witness: Daniel
Temp: 63f
Hum: 47%
120V 60Hz

9/3/2010 10:23:31 AM
Sequence: Preliminary Scan

Compatible Electronics, Inc. FAC-3 (LAB P)

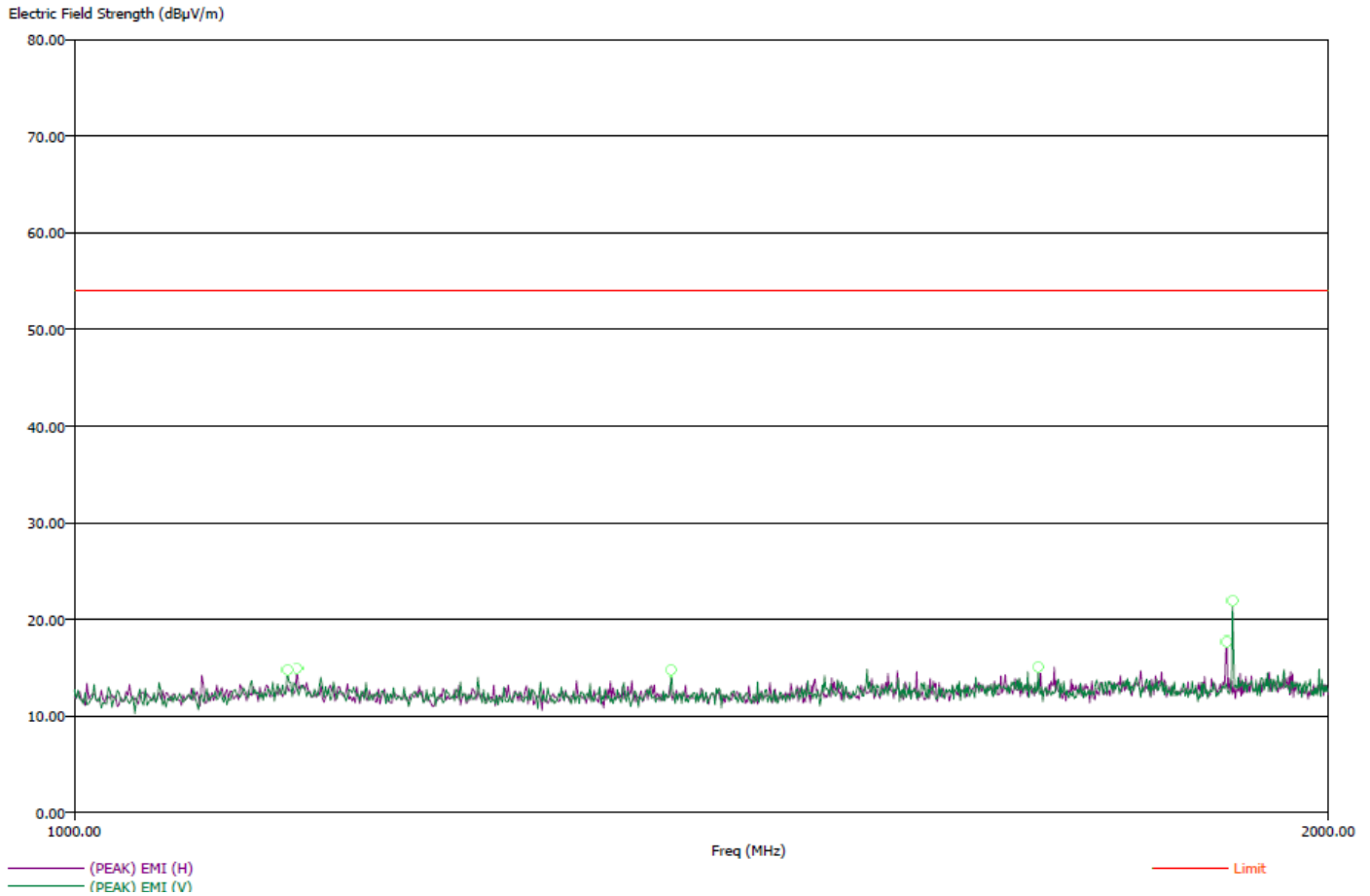

Title: FCC 15.209
 File: Radiated Final 30-1000Mhz.set
 Operator: Matt Harrison
 EUT Type: Solo F7C001
 EUT Condition: 802.11g, "Worst Case" Ch.1, 6Mb/s, AC Adapter (2)
 Comments: USB Terminated to Mouse, and Alt Ethernet terminated to Hub (no power to hub)
 Witness: Daniel
 Temp: 63f
 Hum: 47%
 120V 60Hz

9/3/2010
 Sequence: Final Measurements

Compatible Electronics, Inc. FAC-3 (LAB P)

Freq (MHz)	(QP) Margin (dB)	(QP) EMI (dBµV/m)	(PEAK) EMI (dBµV/m)	Limit (dBµV/m)	Pol	Ttbl Agl (deg)	Twr Ht (cm)	Transducer (dB)	Cable (dB)
43.80	-6.06	33.94	36.91	40.00	V	134.75	106.88	17.29	0.67
58.70	-8.23	31.77	35.50	40.00	V	360.25	160.47	14.21	0.82
125.10	-6.31	37.21	38.73	43.52	V	149.50	136.05	11.10	1.18
250.00	-8.62	37.38	38.50	46.00	V	213.75	104.35	13.80	1.60
375.00	-10.57	35.43	36.93	46.00	H	193.25	114.41	15.72	2.18
500.00	-8.85	37.15	38.84	46.00	H	184.50	100.00	17.90	2.55

Freq (MHz)	(AVG) Margin (dB)	(PEAK) Margin (dB)	(AVG) EMI (dBµV/m)	(PEAK) EMI (dBµV/m)	(AVG) Limit (dBµV/m)	(PEAK) Limit (dBµV/m)	Pol	Ttbl Agl (deg)	Twr Ht (cm)
1125.00	-21.49	-15.75	32.49	38.23	53.98	53.98	V	186.00	104.29
1131.00	-28.15	-15.37	25.83	38.61	53.98	53.98	H	186.75	399.70
1391.00	-29.81	-17.37	24.17	36.61	53.98	53.98	V	45.00	289.00
1704.00	-27.86	-14.55	26.12	39.43	53.98	53.98	V	113.00	226.11
1891.00	-28.77	-16.36	25.21	37.62	53.98	53.98	H	300.00	290.00
1897.00	-28.85	-15.85	25.13	38.13	53.98	53.98	V	217.75	147.00

No Spurious Emissions found below 30 MHz or above 1,897.00 MHz

FCC 15.247

Belkin International, Inc.
 802.11 b and 802.11 g Device
 Model: F7C001

Date: 09/02/2010
 Lab: P
 Tested By: Matt Harrison

Channel 1 - 802.11 g Mode

Freq. (MHz)	Level (dBuV)	Pol (v/h)	Limit	Margi n	Peak / QP / Avg	Ant. Height (m)	Table Angle (deg)	Comments
4824	46.47	H	74	-27.53	Peak	1.44	60	
4824	31.12	H	54	-22.88	Avg	1.44	60	
7236	59.24	H	74	-14.76	Peak	1.12	262	
7236	39.1	H	54	-14.9	Avg	1.12	262	
9648		H	--	--	Peak			Not in Restricted Band
9648		H	--	--	Avg			Not in Restricted Band
12060	59.31	H	74	-14.69	Peak	1.14	285	
12060	45.44	H	54	-8.56	Avg	1.14	285	
14472	61.8	H	74	-12.2	Peak	1.11	284.75	
14472	47.77	H	54	-6.23	Avg	1.11	284.75	
16884		H	--	--	Peak			Not in Restricted Band
16884		H	--	--	Avg			Not in Restricted Band
19296	35.87	H	74	-38.13	Peak	1	260	
19296	22.35	H	54	-31.65	Avg	1	260	
21708		H	--	--	Peak			Not in Restricted Band
21708		H	--	--	Avg			Not in Restricted Band
24120		H	--	--	Peak			Not in Restricted Band
24120		H	--	--	Avg			Not in Restricted Band

FCC 15.247

Belkin International, Inc.
 802.11 b and 802.11 g Device
 Model: F7C001

Date: 09/02/2010
 Lab: P
 Tested By: Matt Harrison

Channel 1 - 802.11 g Mode

Freq. (MHz)	Level (dBuV)	Pol (v/h)	Limit	Margi n	Peak / QP / Avg	Ant. Height (m)	Table Angle (deg)	Comments
4824	45.95	V	74	-28.05	Peak	1.33	290	
4824	32.52	V	54	-21.48	Avg	1.33	290	
7236	59.18	V	74	-14.82	Peak	1.83	240	
7236	39.66	V	54	-14.34	Avg	1.83	240	
9648		V	--	--	Peak			Not in Restricted Band
9648		V	--	--	Avg			Not in Restricted Band
12060	60.22	V	74	-13.78	Peak	1.49	265	
12060	45.49	V	54	-8.51	Avg	1.49	265	
14472	61.29	V	74	-12.71	Peak	1.43	65	
14472	47.79	V	54	-6.21	Avg	1.43	65	
16884		V	--	--	Peak			Not in Restricted Band
16884		V	--	--	Avg			Not in Restricted Band
19296	37.13	V	74	-36.87	Peak	1	290	
19296	22.38	V	54	-31.62	Avg	1	290	
21708		V	--	--	Peak			Not in Restricted Band
21708		V	--	--	Avg			Not in Restricted Band
24120		V	--	--	Peak			Not in Restricted Band
24120		V	--	--	Avg			Not in Restricted Band

FCC 15.247

Belkin International, Inc.
 802.11 b and 802.11 g Device
 Model: F7C001

Date: 09/02/2010
 Lab: P
 Tested By: Matt Harrison

Channel 6 - 802.11 g Mode

Freq. (MHz)	Level (dBuV)	Pol (v/h)	Limit	Margi n	Peak / QP / Avg	Ant. Height (m)	Table Angle (deg)	Comments
4874	44.47	H	74	-29.53	Peak	1.03	285	
4874	30.8	H	54	-23.2	Avg	1.03	285	
7311	50.86	H	74	-23.14	Peak	1	130	
7311	36.92	H	54	-17.08	Avg	1	130	
9748		H	--	--	Peak			Not in Restricted Band
9748		H	--	--	Avg			Not in Restricted Band
12185	58.83	H	74	-15.17	Peak	1.3	243	
12185	45.29	H	54	-8.71	Avg	1.3	243	
14622		H	--	--	Peak			Not in Restricted Band
14622		H	--	--	Avg			Not in Restricted Band
17059		H	--	--	Peak			Not in Restricted Band
17059		H	--	--	Avg			Not in Restricted Band
19496	36.12	H	74	-37.88	Peak	1	195	
19496	21.71	H	54	-32.29	Avg	1	195	
21933		H	--	--	Peak			Not in Restricted Band
21933		H	--	--	Avg			Not in Restricted Band
24370		H	--	--	Peak			Not in Restricted Band
24370		H	--	--	Avg			Not in Restricted Band

FCC 15.247

Belkin International, Inc.
 802.11 b and 802.11 g Device
 Model: F7C001

Date: 09/02/2010
 Lab: P
 Tested By: Matt Harrison

Channel 6 - 802.11 g Mode

Freq. (MHz)	Level (dBuV)	Pol (v/h)	Limit	Margi n	Peak / QP / Avg	Ant. Height (m)	Table Angle (deg)	Comments
4874	44.48	V	74	-29.52	Peak	1.3	270	
4874	30.79	V	54	-23.21	Avg	1.3	270	
7311	51.79	V	74	-22.21	Peak	1.5	311	
7311	36.94	V	54	-17.06	Avg	1.5	311	
9748		V	--	--	Peak			Not in Restricted Band
9748		V	--	--	Avg			Not in Restricted Band
12185	60.01	V	74	-13.99	Peak	1.69	215	
12185	45.32	V	54	-8.68	Avg	1.69	215	
14622		V	--	--	Peak			Not in Restricted Band
14622		V	--	--	Avg			Not in Restricted Band
17059		V	--	--	Peak			Not in Restricted Band
17059		V	--	--	Avg			Not in Restricted Band
19496	35.33	V	74	-38.67	Peak	1	290	
19496	21.94	V	54	-32.06	Avg	1	290	
21933		V	--	--	Peak			Not in Restricted Band
21933		V	--	--	Avg			Not in Restricted Band
24370		V	--	--	Peak			Not in Restricted Band
24370		V	--	--	Avg			Not in Restricted Band

FCC 15.247

Belkin International, Inc.
 802.11 b and 802.11 g Device
 Model: F7C001

Date: 09/02/2010
 Lab: P
 Tested By: Matt Harrison

Channel 11 - 802.11 g Mode

Freq. (MHz)	Level (dBuV)	Pol (v/h)	Limit	Margi n	Peak / QP / Avg	Ant. Height (m)	Table Angle (deg)	Comments
4924	44.61	H	74	-29.39	Peak	1.5	220	
4924	31.21	H	54	-22.79	Avg	1.5	220	
7386	61.85	H	74	-12.15	Peak	1	260	
7386	39.74	H	54	-14.26	Avg	1	260	
9848		H	--	--	Peak			Not in Restricted Band
9848		H	--	--	Avg			Not in Restricted Band
12310	60.17	H	74	-13.83	Peak	1.53	260	
12310	46.01	H	54	-7.99	Avg	1.53	260	
14772		H	--	--	Peak			Not in Restricted Band
14772		H	--	--	Avg			Not in Restricted Band
17234		H	--	--	Peak			Not in Restricted Band
17234		H	--	--	Avg			Not in Restricted Band
19696	35.74	H	74	-38.26	Peak	1	23	
19696	22.56	H	54	-31.44	Avg	1	23	
22158	37.87	H	74	-36.13	Peak	1	181	
22158	23.69	H	54	-30.31	Avg	1	181	
24620		H	--	--	Peak			Not in Restricted Band
24620		H	--	--	Avg			Not in Restricted Band

FCC 15.247

Belkin International, Inc.
 802.11 b and 802.11 g Device
 Model: F7C001

Date: 09/02/2010
 Lab: P
 Tested By: Matt Harrison

Channel 11 - 802.11 g Mode

Freq. (MHz)	Level (dBuV)	Pol (v/h)	Limit	Margi n	Peak / QP / Avg	Ant. Height (m)	Table Angle (deg)	Comments
4924	45.66	V	74	-28.34	Peak	1.05	220	
4924	31.3	V	54	-22.7	Avg	1.05	220	
7386	61.44	V	74	-12.56	Peak	1.3	220.25	
7386	39.47	V	54	-14.53	Avg	1.3	220.25	
9848		V	--	--	Peak			Not in Restricted Band
9848		V	--	--	Avg			Not in Restricted Band
12310	60.19	V	74	-13.81	Peak	1.03	220	
12310	45.95	V	54	-8.05	Avg	1.03	220	
14772		V	--	--	Peak			Not in Restricted Band
14772		V	--	--	Avg			Not in Restricted Band
17234		V	--	--	Peak			Not in Restricted Band
17234		V	--	--	Avg			Not in Restricted Band
19696	35.9	V	74	-38.1	Peak	1	160	
19696	22.48	V	54	-31.52	Avg	1	160	
22158	37.36	V	74	-36.64	Peak	1	200	
22158	23.38	V	54	-30.62	Avg	1	200	
24620		V	--	--	Peak			Not in Restricted Band
24620		V	--	--	Avg			Not in Restricted Band

Title: FCC 15.209
File: Radiated Pre-Scan 30-2000Mhz RxOnly.set
Operator: Matt Harrison
EUT Type: Solo F7C001
EUT Condition: 802.11g, Ch.6, Receive Only Mode (Transmitter Off)
Comments: USB Terminated to Mouse, and Alt Ethernet terminated to Hub (no power to hub)
Witness: Daniel
Temp: 63f
Hum: 47%
120V 60Hz

9/3/2010 11:09:32 AM
Sequence: Preliminary Scan

Compatible Electronics, Inc. FAC-3 (LAB P)

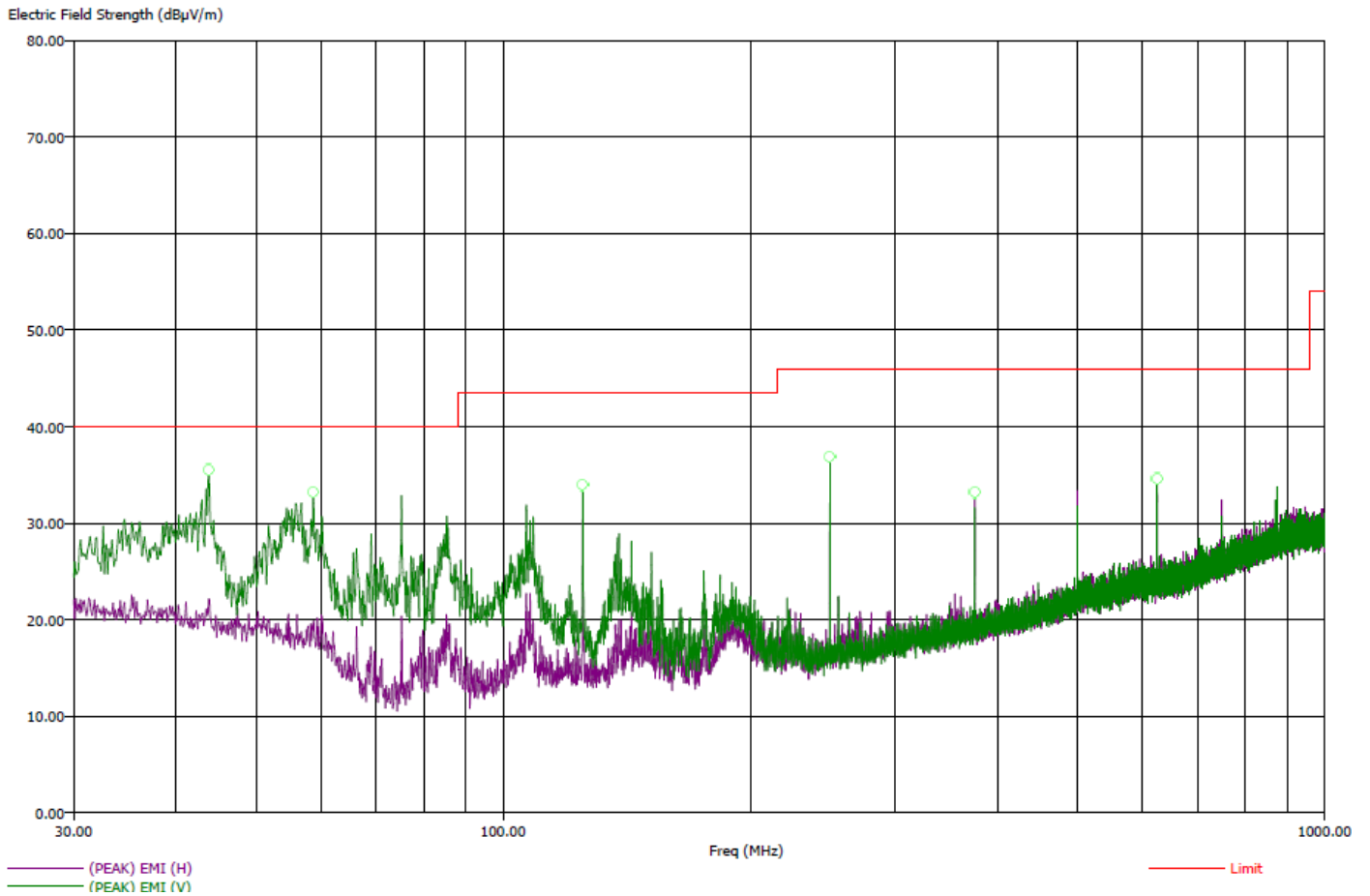

Title: FCC 15.209
File: Radiated Pre-Scan 30-2000Mhz RxOnly.set
Operator: Matt Harrison
EUT Type: Solo F7C001
EUT Condition: 802.11g, Ch.6, Receive Only Mode (Transmitter Off)
Comments: USB Terminated to Mouse, and Alt Ethernet terminated to Hub (no power to hub)
Witness: Daniel
Temp: 63f
Hum: 47%
120V 60Hz

9/3/2010 11:09:32 AM
Sequence: Preliminary Scan

Compatible Electronics, Inc. FAC-3 (LAB P)

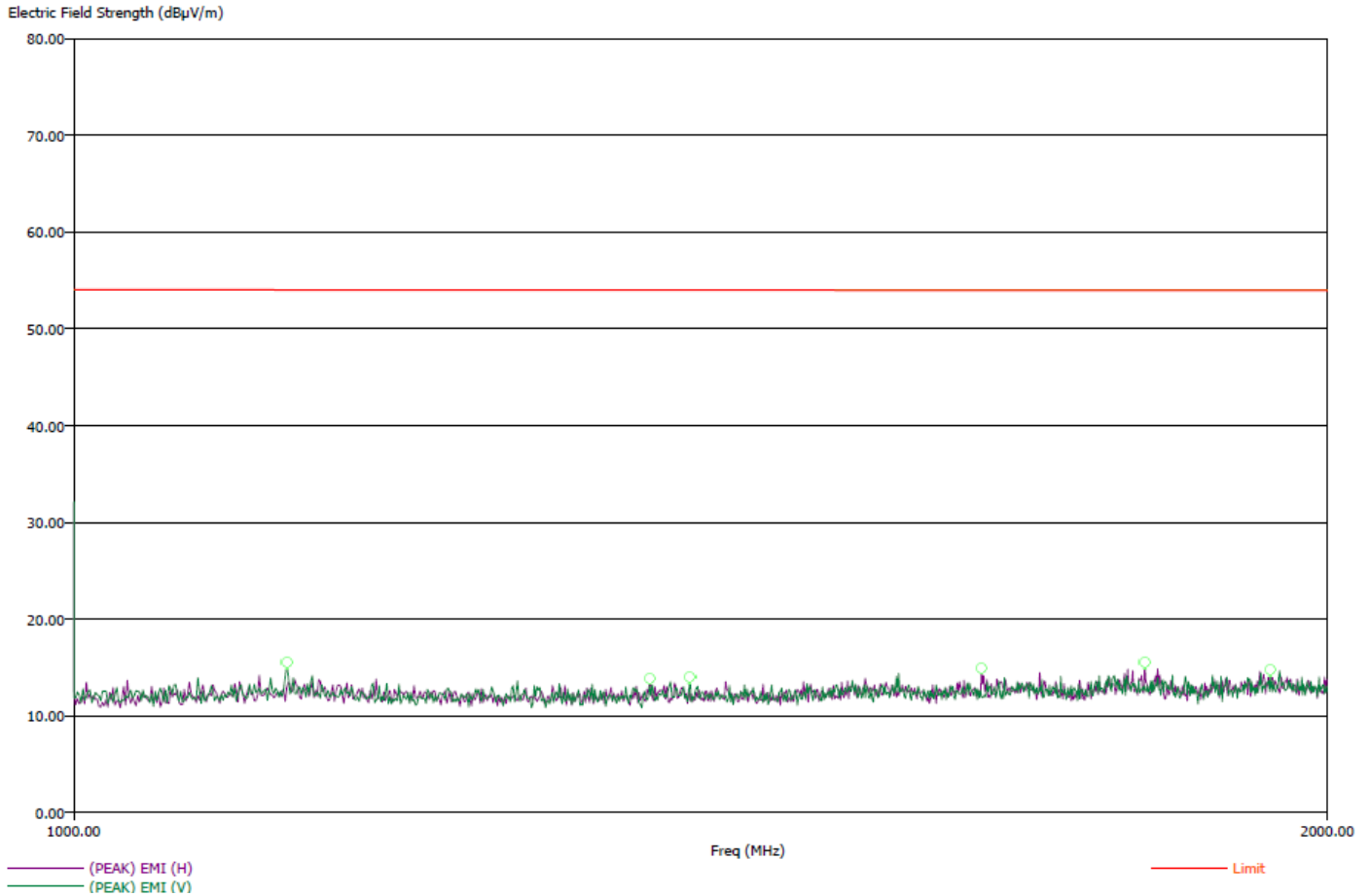

Title: FCC 15.209
 File: Radiated Final 30-2000Mhz gRxOnly.set
 Operator: Matt Harrison
 EUT Type: Solo F7C001
 EUT Condition: 802.11g, Ch.6, Receive Only Mode (Transmitter Off)
 Comments: USB Terminated to Mouse, and Alt Ethernet terminated to Hub (no power to hub)
 Witness: Daniel
 Temp: 63f
 Hum: 47%
 120V 60Hz

9/3/2010
 Sequence: Final Measurements

Compatible Electronics, Inc. FAC-3 (LAB P)

Freq (MHz)	(QP) Margin (dB)	(QP) EMI (dBµV/m)	(PEAK) EMI (dBµV/m)	Limit (dBµV/m)	Pol	Ttbl Agl (deg)	Twr Ht (cm)	Transducer (dB)	Cable (dB)
43.80	-6.57	33.43	36.20	40.00	V	155.00	109.64	17.29	0.67
58.70	-9.99	30.01	34.14	40.00	V	73.75	178.64	14.20	0.82
125.10	-5.96	37.56	39.11	43.52	V	144.25	119.52	11.10	1.18
250.00	-8.42	37.58	38.82	46.00	V	-0.25	135.11	13.80	1.60
375.00	-10.53	35.47	37.50	46.00	H	193.75	99.52	15.72	2.18
625.10	-11.17	34.83	36.94	46.00	V	317.50	114.58	19.12	2.88

Freq (MHz)	(AVG) Margin (dB)	(AVG) EMI (dBµV/m)	(PEAK) EMI (dBµV/m)	Limit (dBµV/m)	Pol	Ttbl Agl (deg)	Twr Ht (cm)	Transducer (dB)	Cable (dB)
1125.00	-25.34	28.64	30.77	53.98	V	172.00	103.52	20.00	4.04
1375.00	-26.08	27.90	38.19	53.98	H	176.75	133.05	18.05	4.81
1406.00	-29.81	24.17	37.17	53.98	V	74.00	332.94	18.03	4.85
1652.00	-27.84	26.14	38.89	53.98	H	238.50	400.05	18.70	5.40
1808.00	-28.29	25.69	38.93	53.98	H	360.25	135.76	17.61	5.73
1938.00	-28.25	25.73	38.75	53.98	V	0.00	258.47	17.81	5.61

No Spurious Emissions found below 30 MHz or above 1,938.00 MHz



Channel (1) 802.11 b -6 dB Bandwidth



Ref Lvl	Delta 2 [T2]	RBW	100 kHz	RF Att	40 dB
122.3 dBμV	0.62 dB	VBW	300 kHz	Unit	dBμV
	12.12424850 MHz	SWT	12.5 ms		

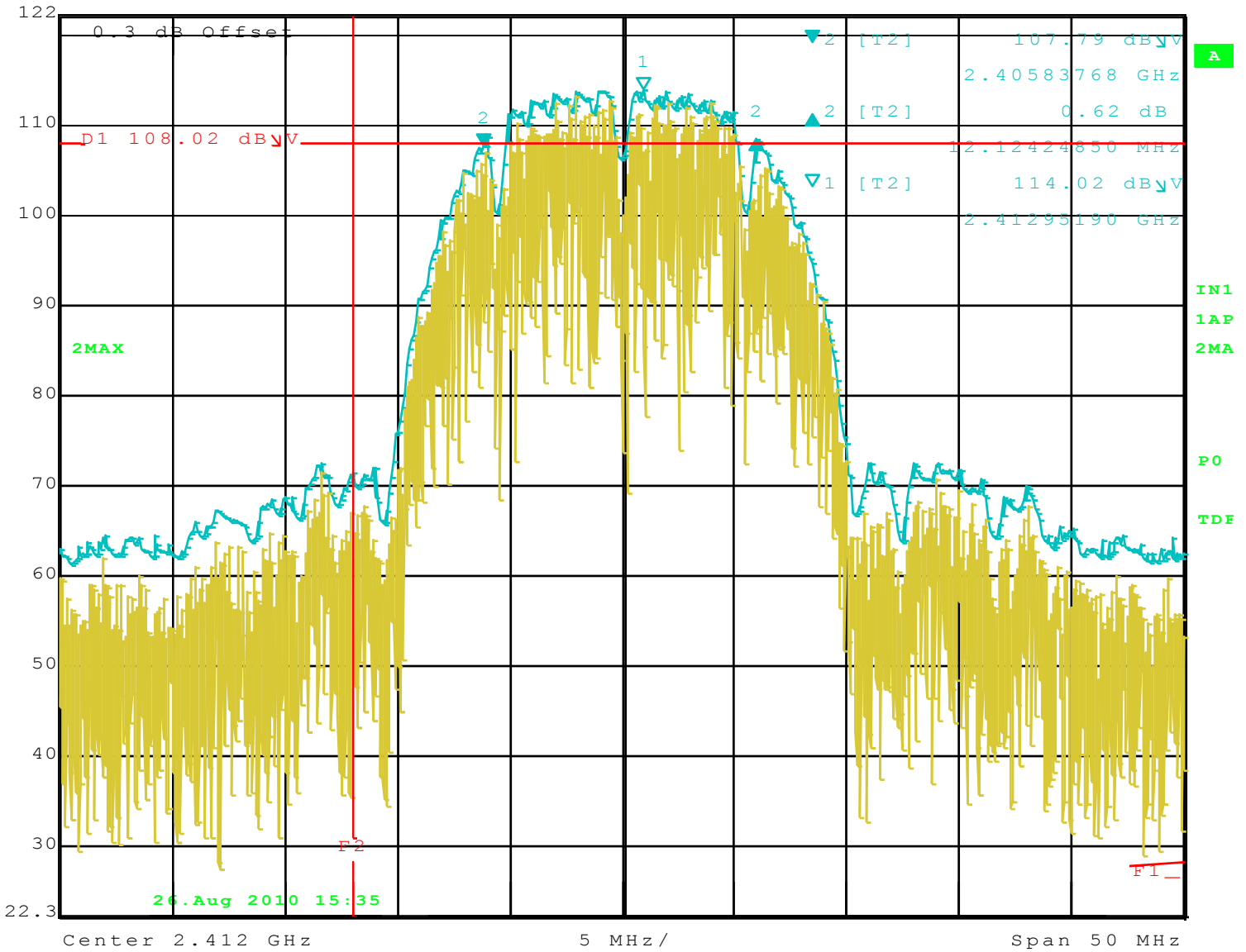

Date: 26.AUG.2010 15:35:52

Channel (6) 802.11 b -6 dB Bandwidth

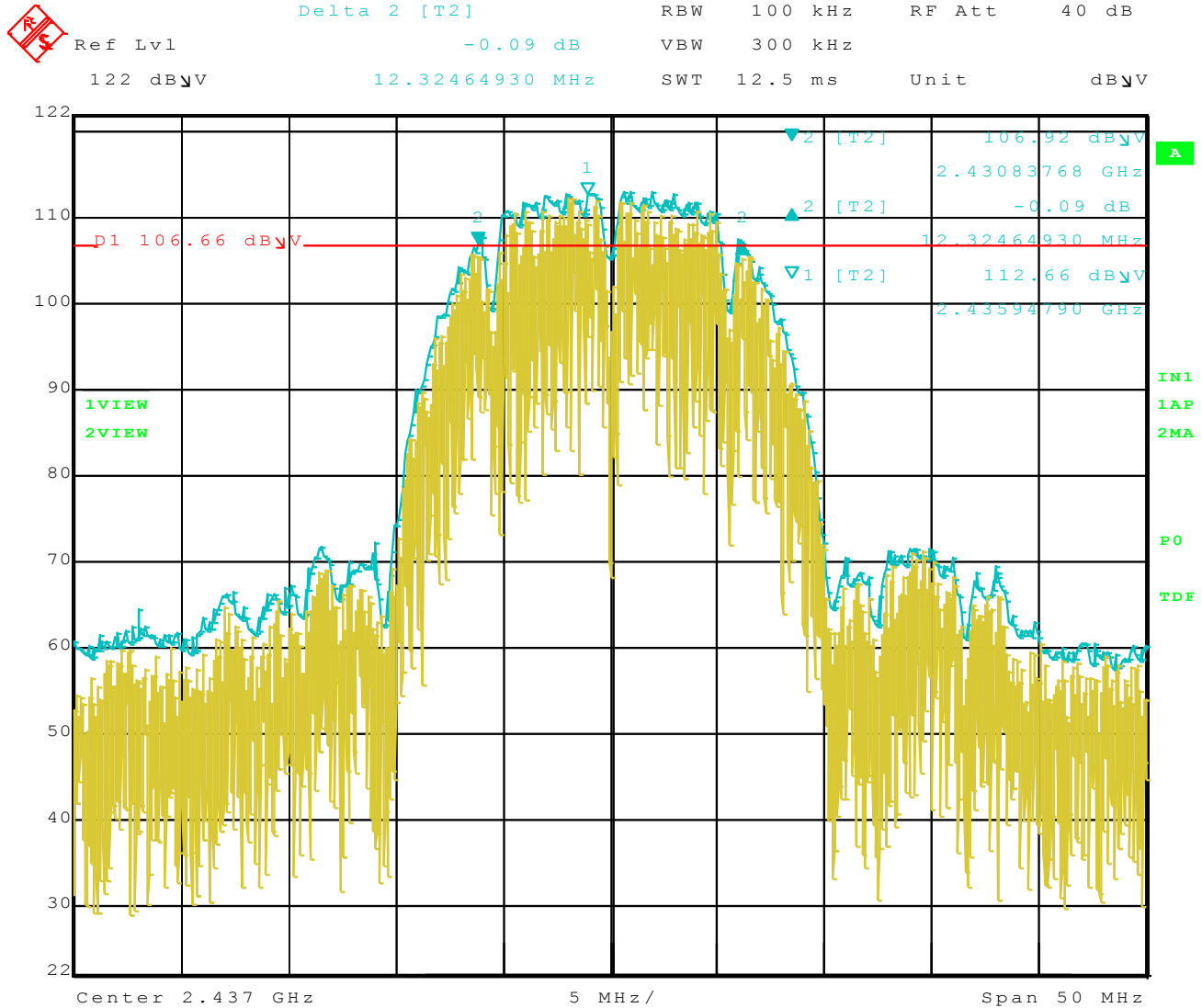

Date: 1.SEP.2010 16:55:09

Channel (11) 802.11 b -6 dB Bandwidth



	Delta 2 [T2]	RBW	100 kHz	RF Att	40 dB
Ref Lvl	0.12 dB	VBW	300 kHz		
132 dB μ V	12.22444890 MHz	SWT	12.5 ms	Unit	dB μ V

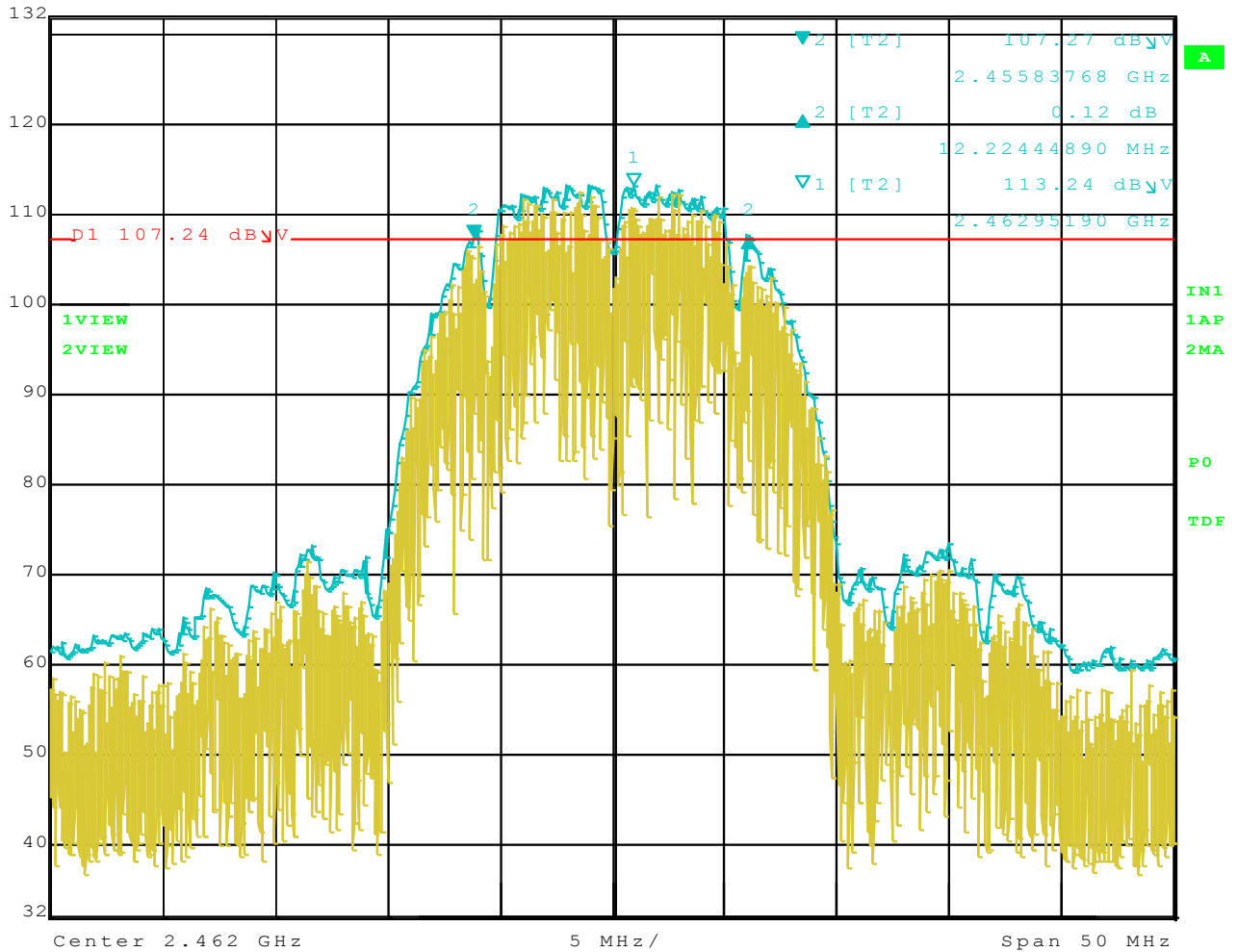

Date: 1.SEP.2010 17:07:06

Channel (1) 802.11 g -6 dB Bandwidth

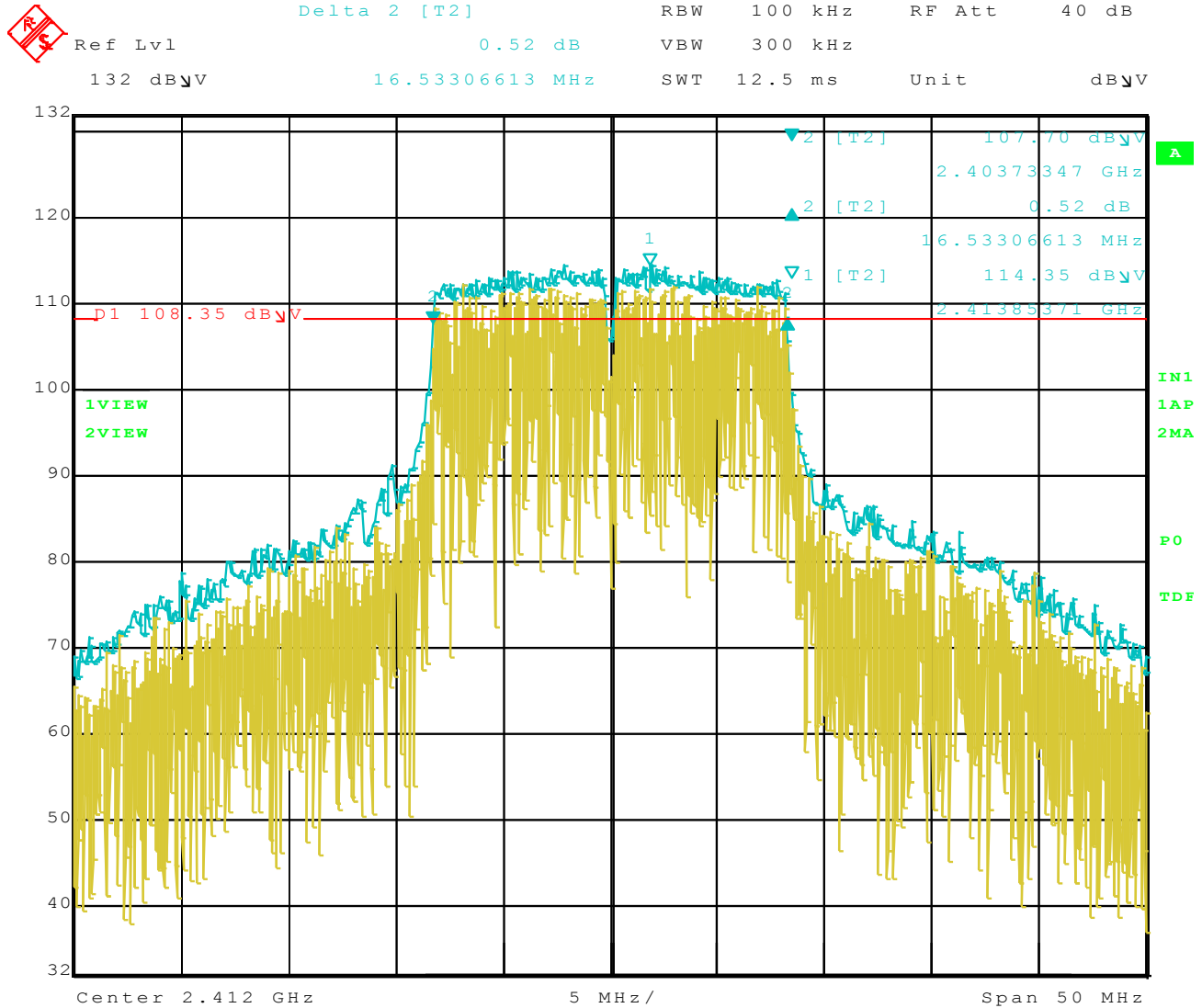

Date: 1.SEP.2010 17:14:45

Channel (6) 802.11 g -6 dB Bandwidth

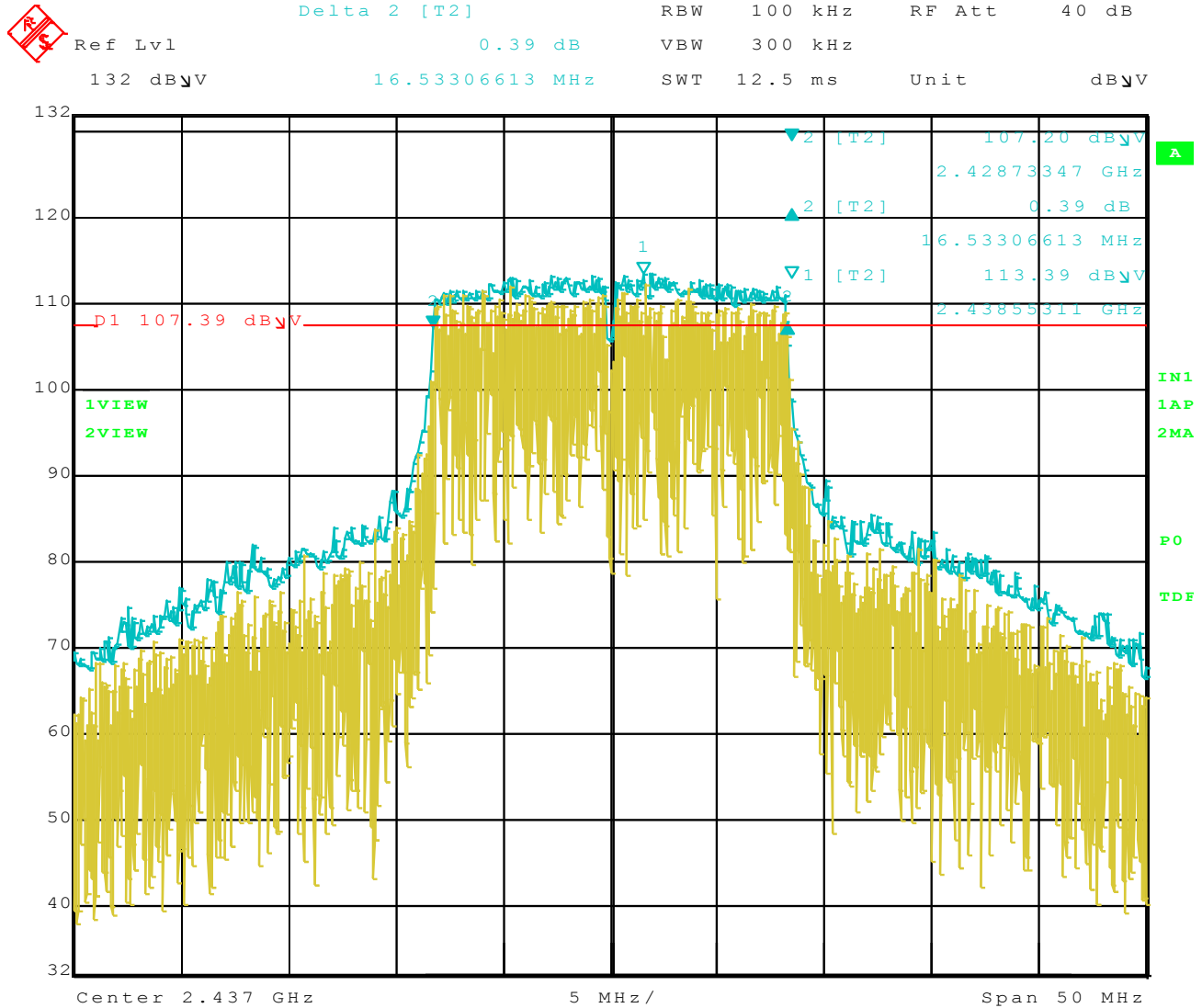

Date: 1.SEP.2010 17:23:07

Channel (11) 802.11 g -6 dB Bandwidth



	Delta 2 [T2]	RBW	100 kHz	RF Att	40 dB
Ref Lvl	3.33 dB	VBW	300 kHz		
132 dB μ V	16.43286573 MHz	SWT	12.5 ms	Unit	dB μ V

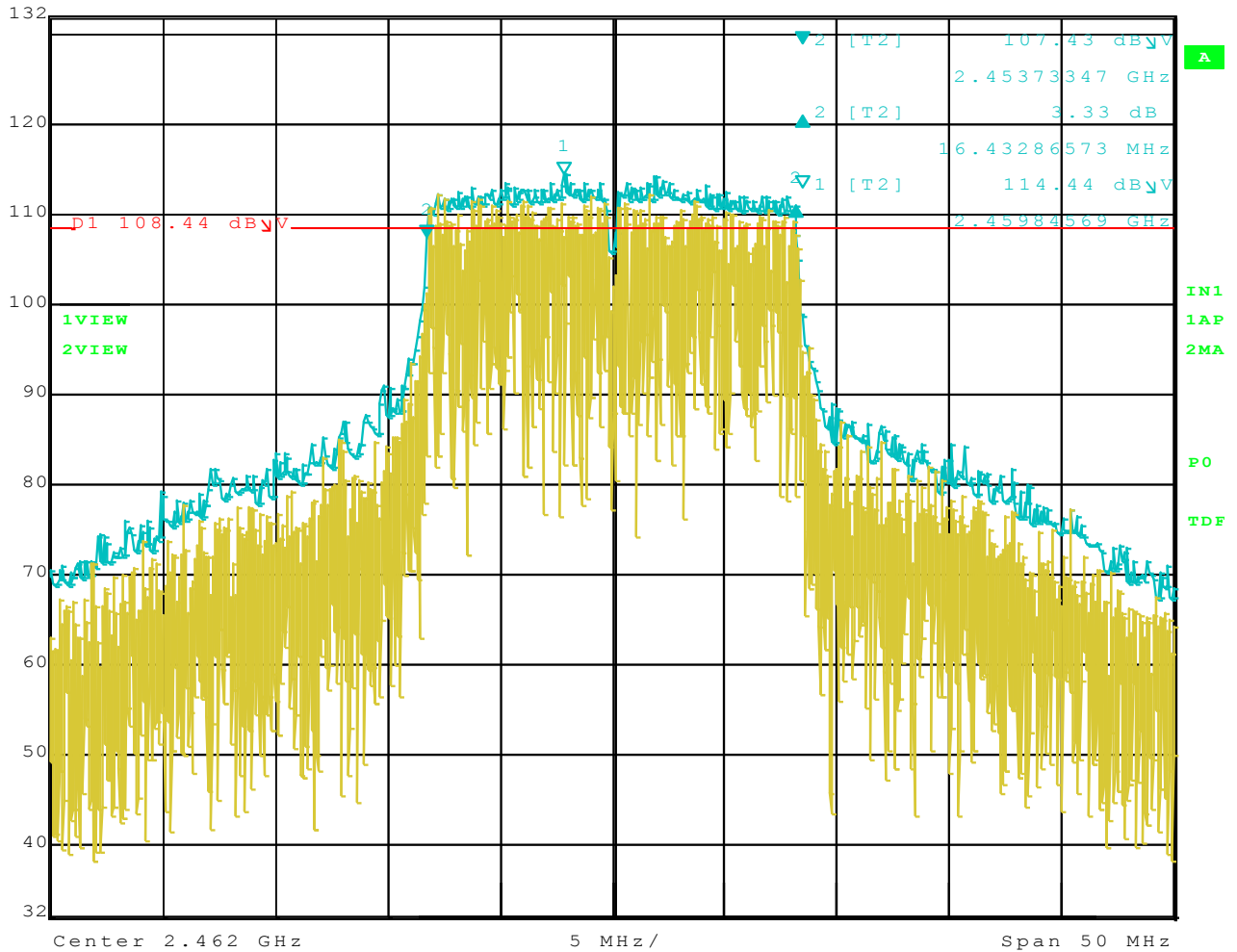

Date: 1.SEP.2010 17:28:51

PEAK POWER OUTPUT

DATA SHEETS

Title: FCC 15.247
Operator: Matt Harrison
EUT Type: Solo F7C001
EUT Condition: DAC 1 Factory Default Power Settings
Witness: Daniel
Temp: 68f
Hum: 45%
120V 60Hz

8/26/2010

Compatible Electronics, Inc. FAC-3 (LAB P)

Channel	802.11b Worst Case Data Rate 1Mb/s			802.11g Worst Case Data Rate 6Mb/s		
	99% PK Pwr (dBm)	100% PK Pwr (dBm)	AVG Pwr (dBm)	99% PK Pwr (dBm)	100% PK Pwr (dBm)	AVG Pwr (dBm)
1	20.74	21.21	18.34	26.14	27.50	20.24
6	20.00	20.53	17.62	25.79	27.27	19.76
11	20.39	20.78	17.97	25.94	27.34	20.04



RF CONDUCTED ANTENNA TEST

DATA SHEETS

Channel (1) 802.11 b RF Antenna Conducted 2 – 2000MHz

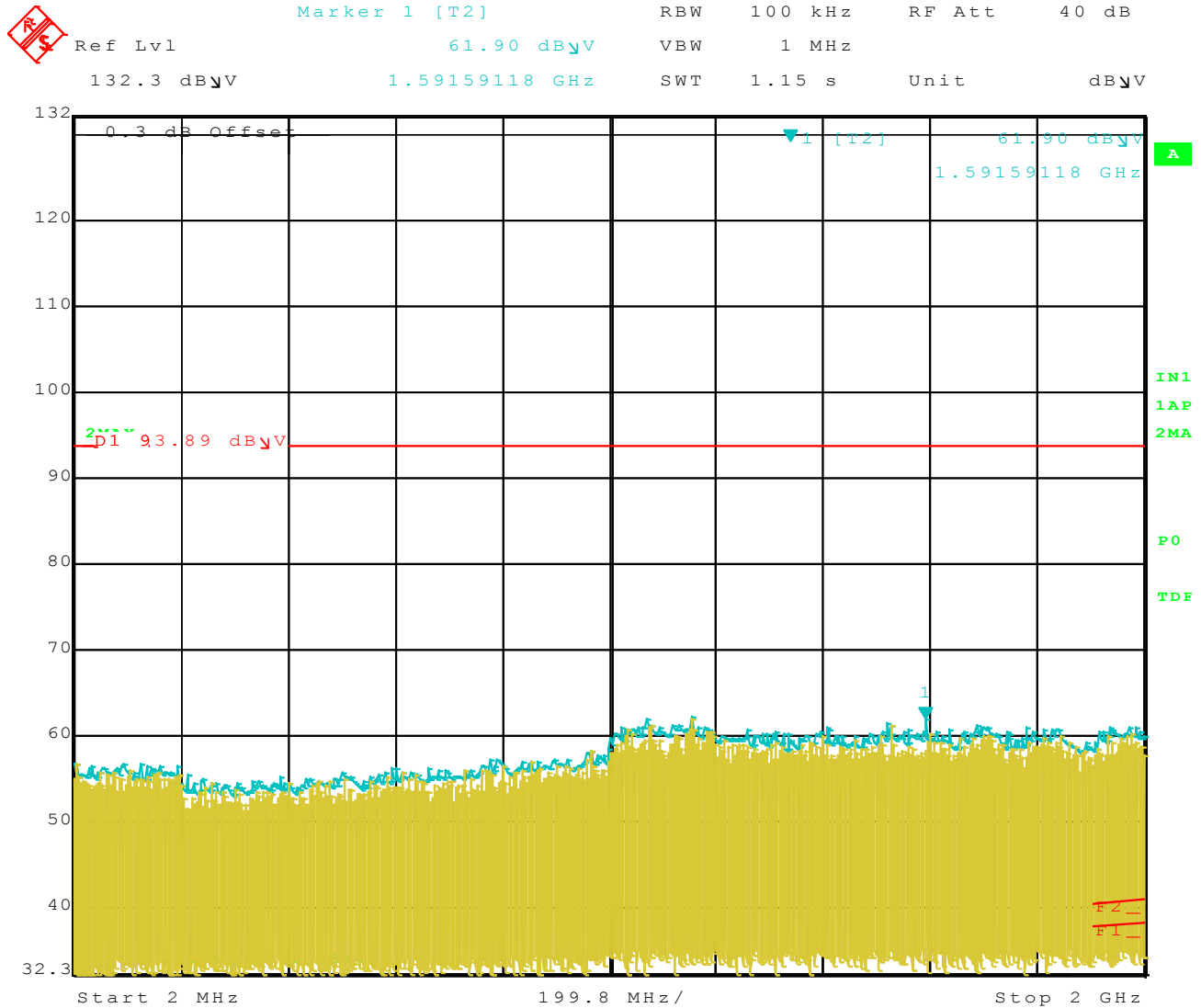

Date: 26.AUG.2010 15:48:56

Channel (1) 802.11 b RF Antenna Conducted 2 – 3 GHz

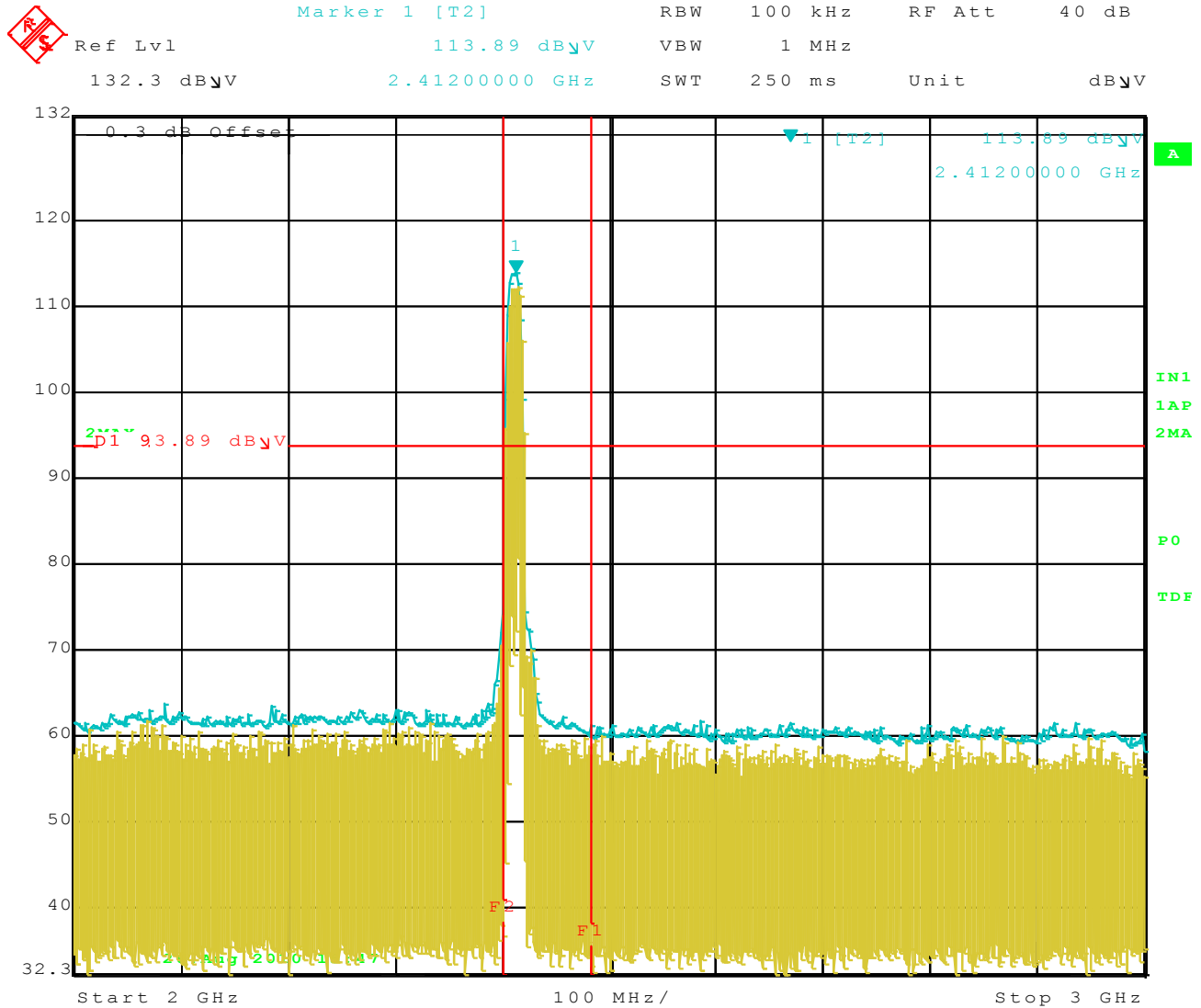

Date: 26.AUG.2010 15:47:34

Channel (1) 802.11 b RF Antenna Conducted 3 – 10 GHz

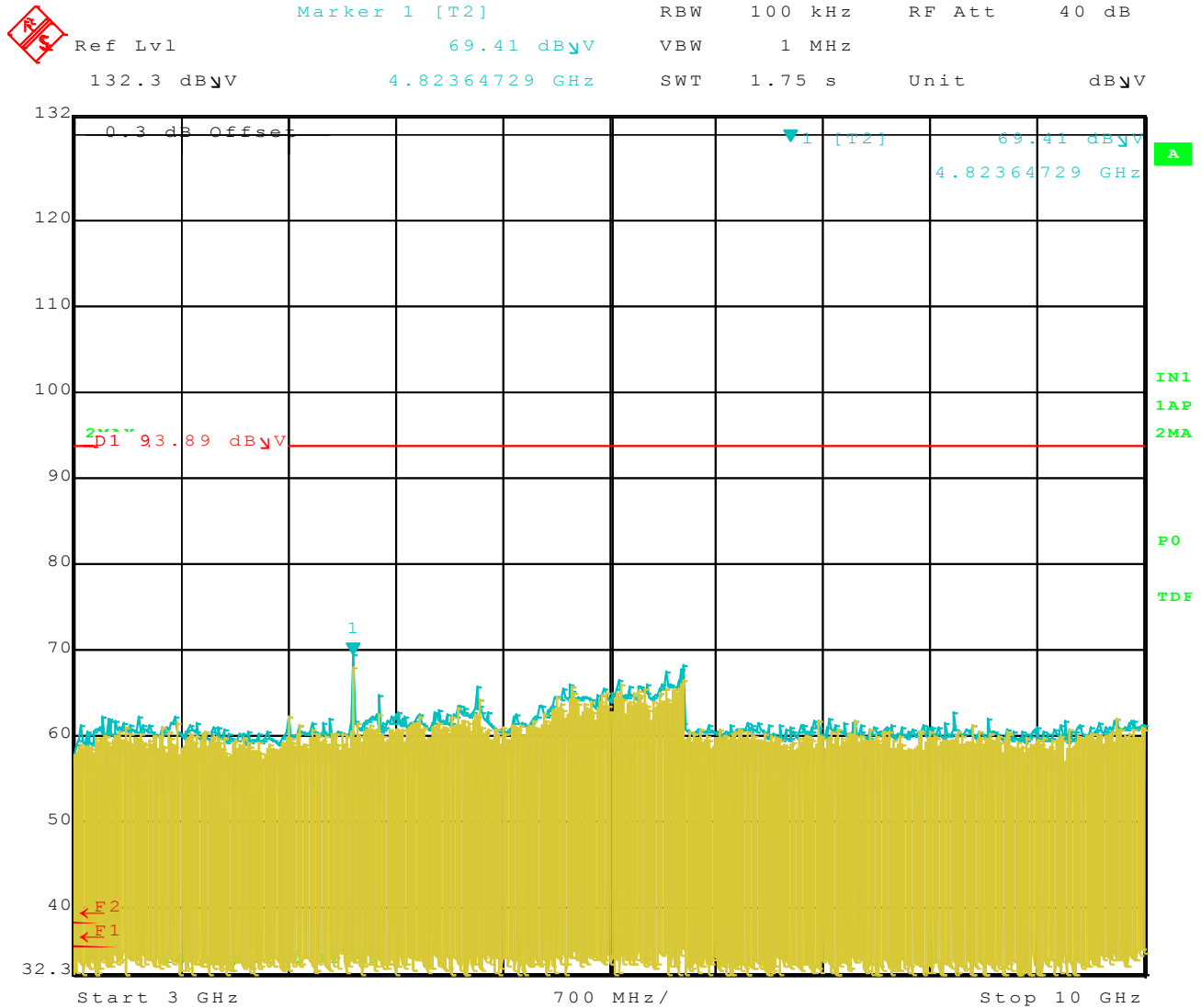

Date: 26.AUG.2010 15:50:10

Channel (1) 802.11 b RF Antenna Conducted 10 – 25GHz

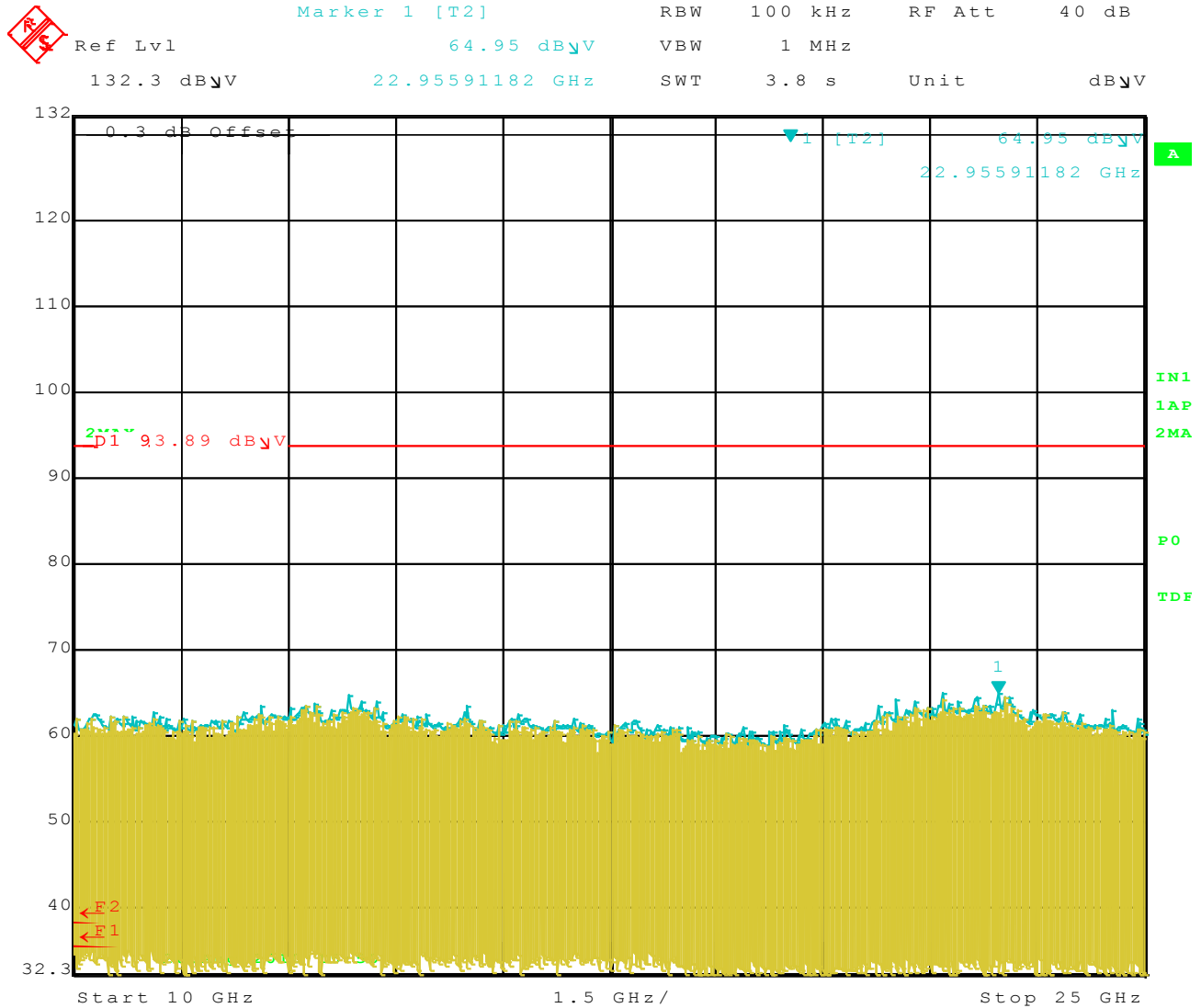

Date: 26.AUG.2010 15:50:59

Channel (6) 802.11 b RF Antenna Conducted 2 – 2000MHz

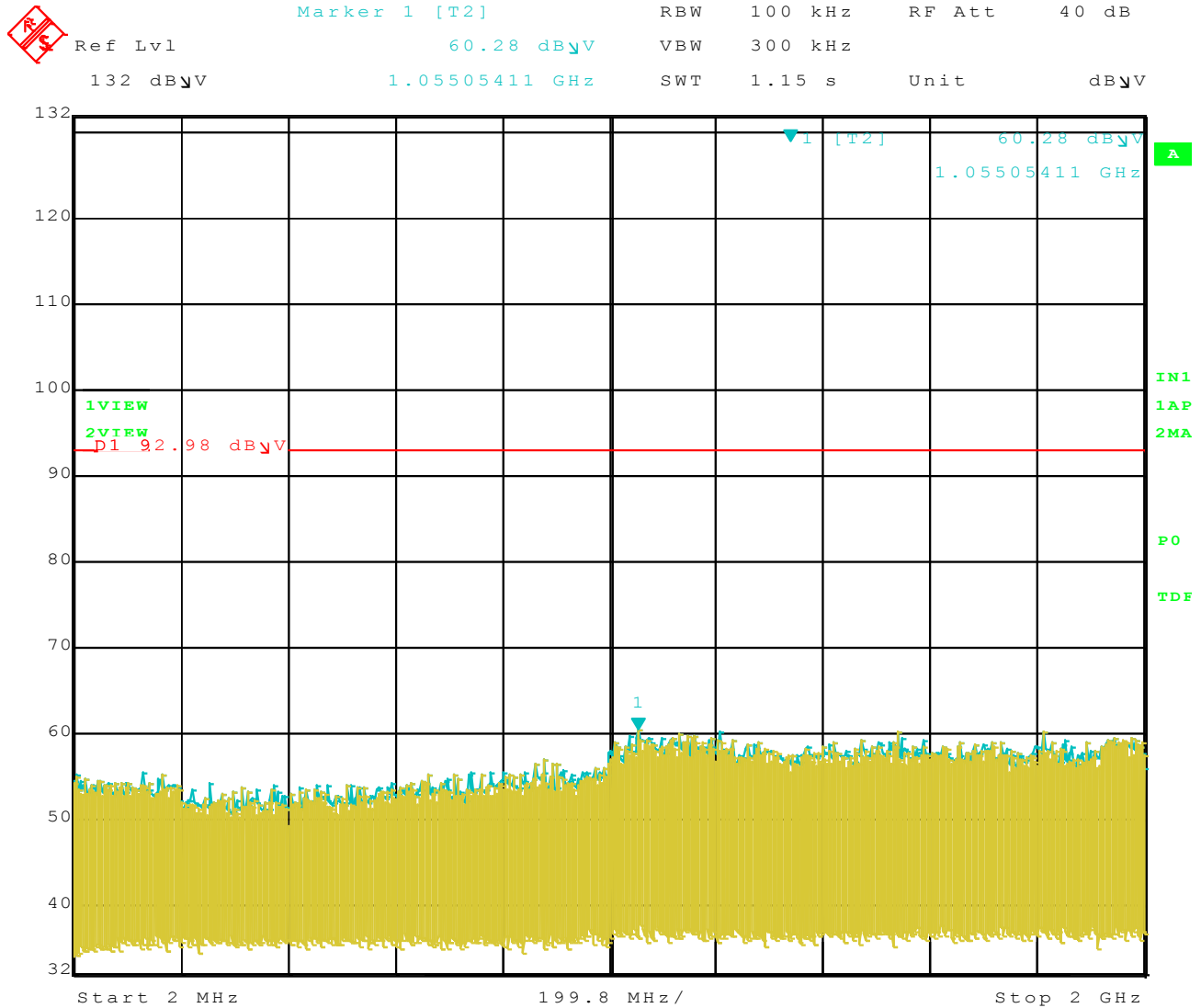

Date: 1.SEP.2010 16:58:16

Channel (6) 802.11 b RF Antenna Conducted 2 – 3 GHz

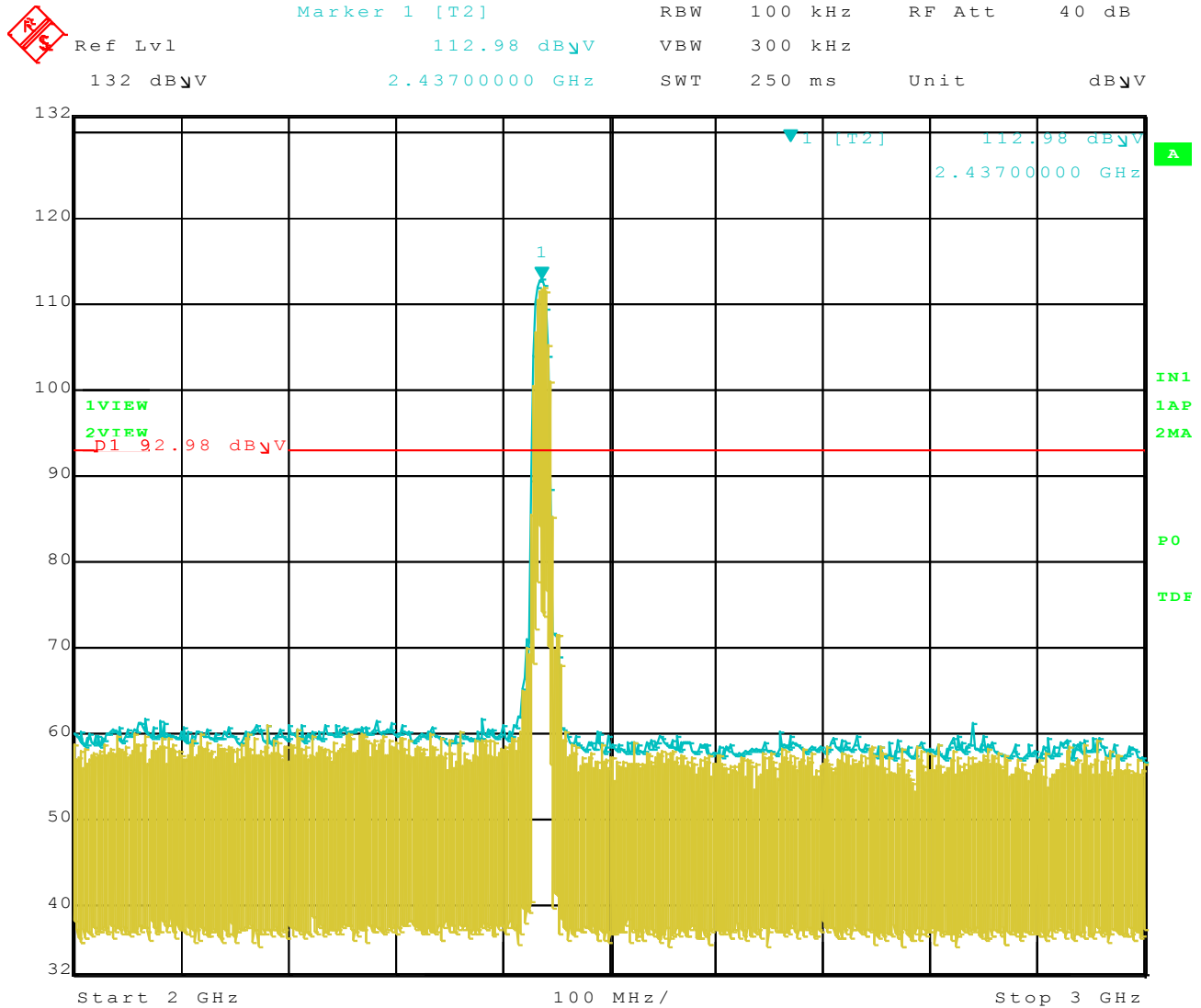

Date: 1.SEP.2010 16:57:07

Channel (6) 802.11 b RF Antenna Conducted 3 – 10 GHz

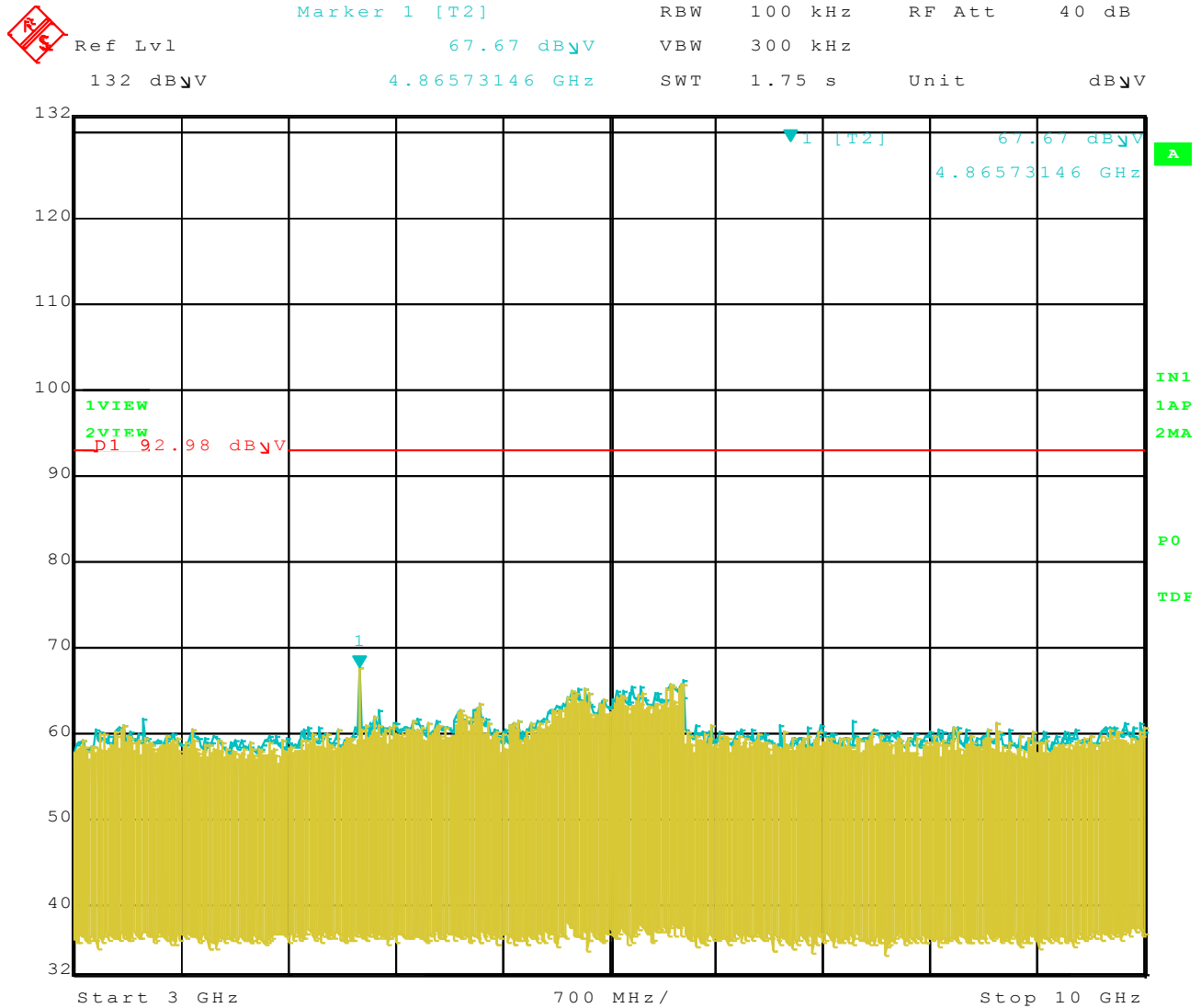

Date: 1.SEP.2010 16:58:37

Channel (6) 802.11 b RF Antenna Conducted 10 – 25GHz

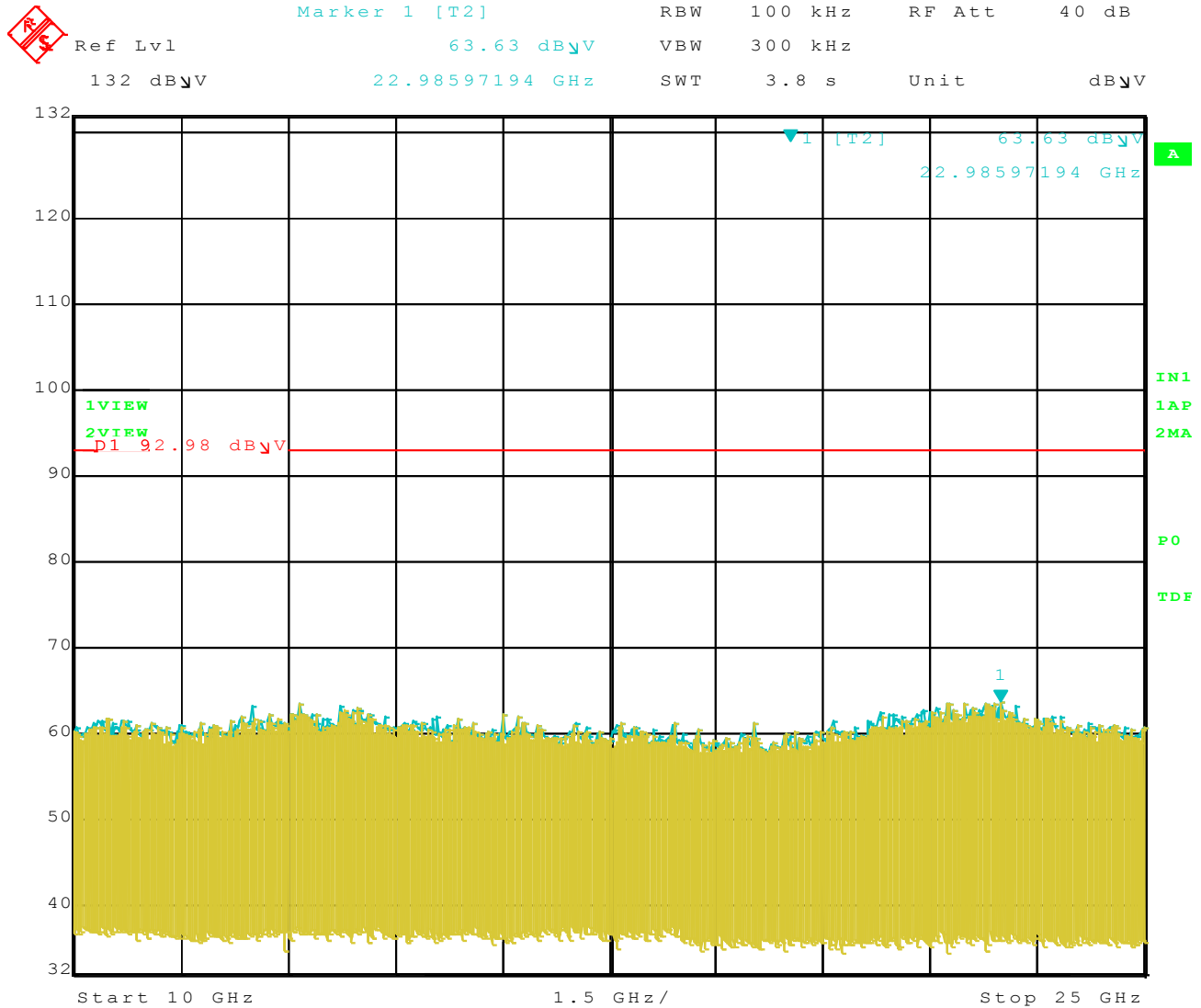

Date: 1.SEP.2010 16:59:00

Channel (11) 802.11 b RF Antenna Conducted 2 – 2000MHz

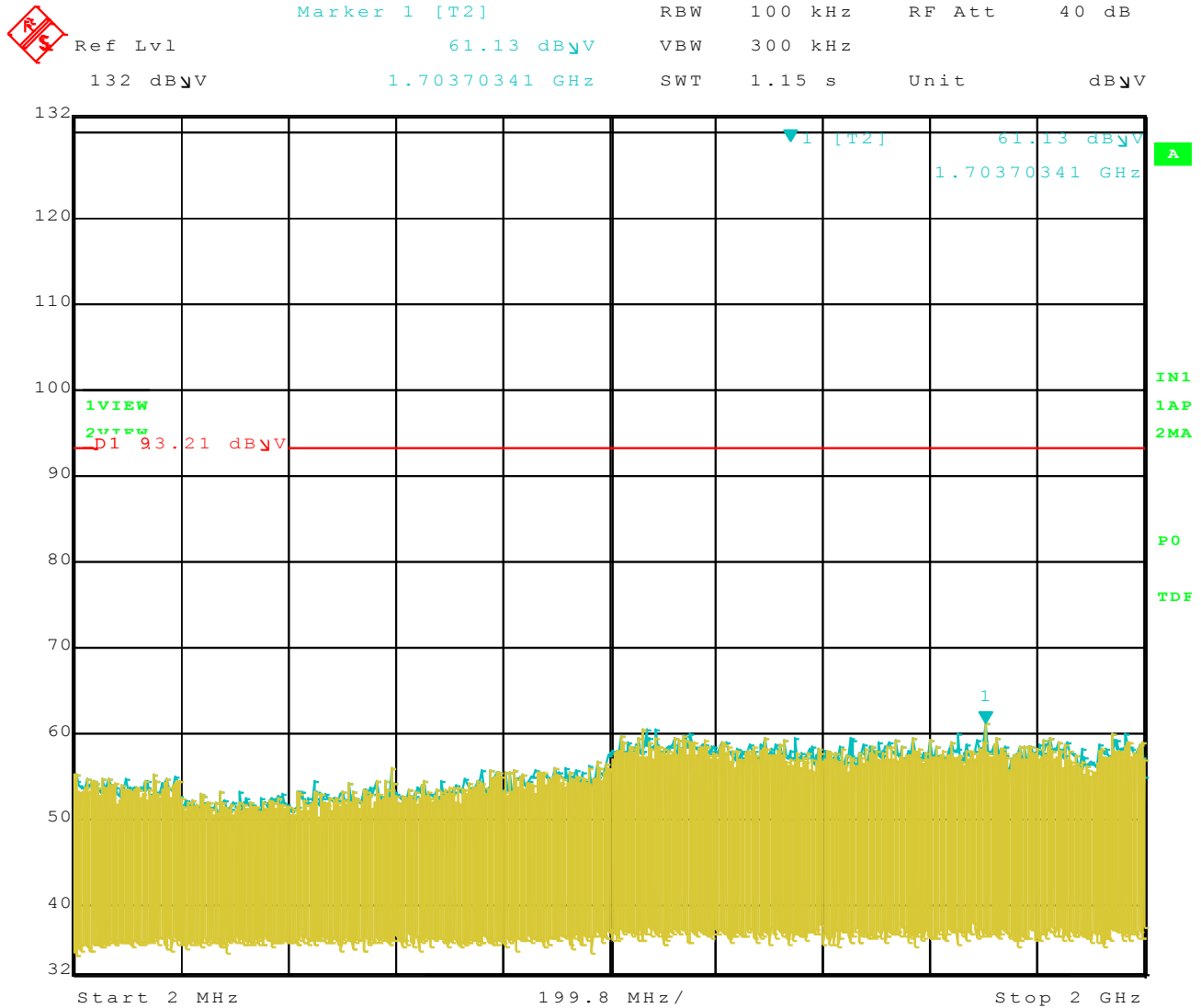

Date: 1.SEP.2010 17:10:55

Channel (11) 802.11 b RF Antenna Conducted
2 – 3 GHz

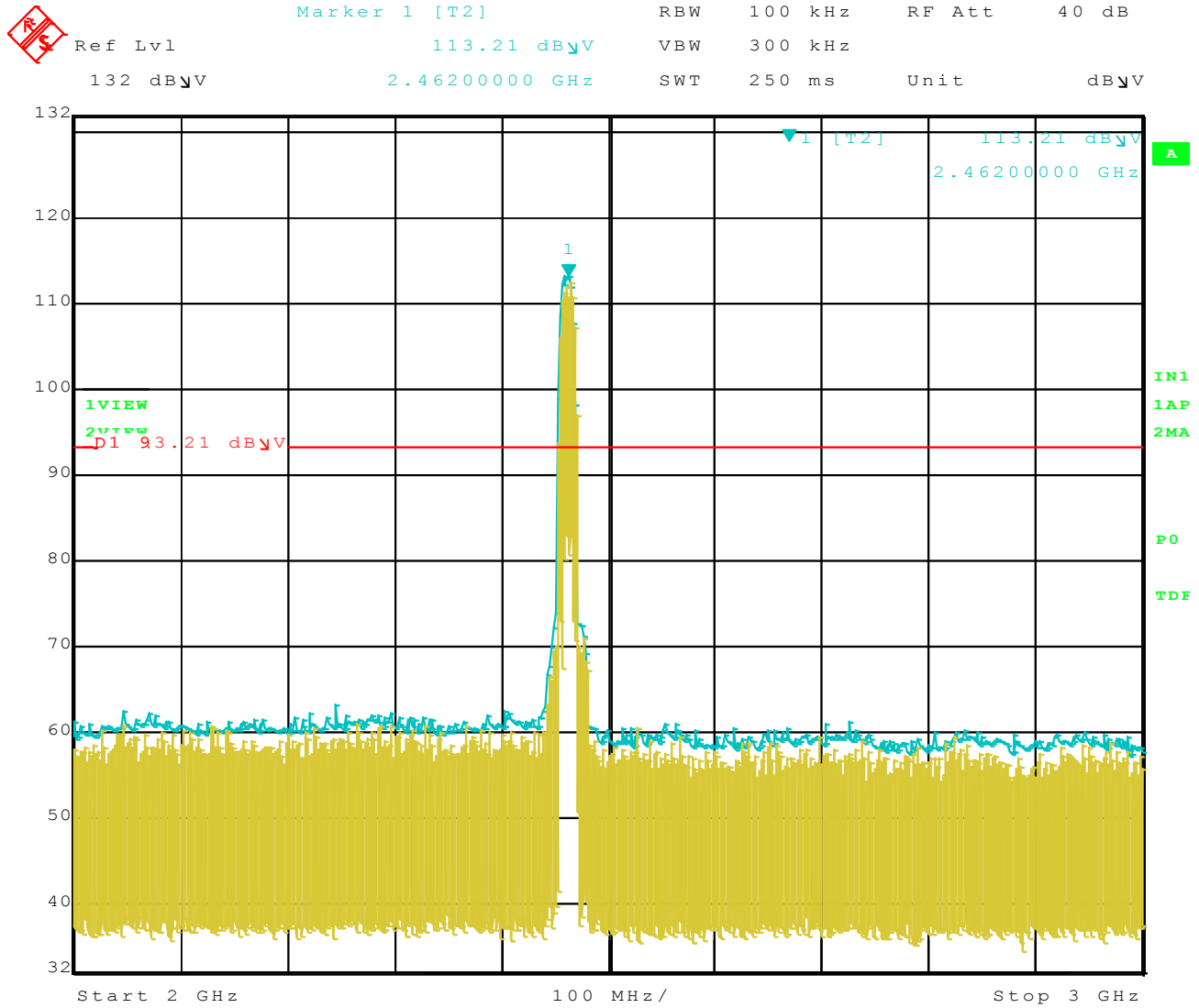

Date: 1.SEP.2010 17:10:25

Channel (11) 802.11 b RF Antenna Conducted 3 – 10 GHz

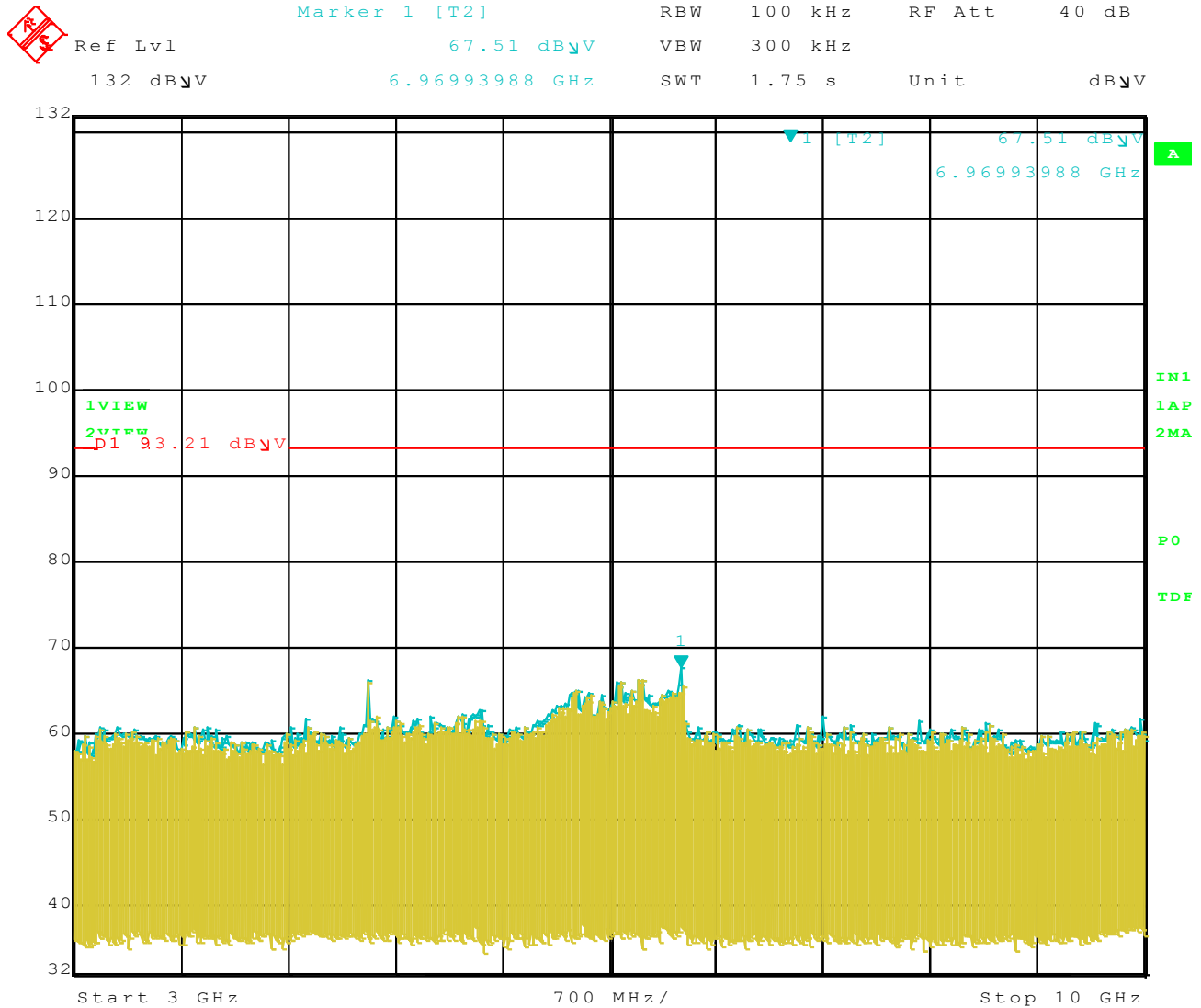

Date: 1.SEP.2010 17:11:20

Channel (11) 802.11 b RF Antenna Conducted
10 – 25GHz

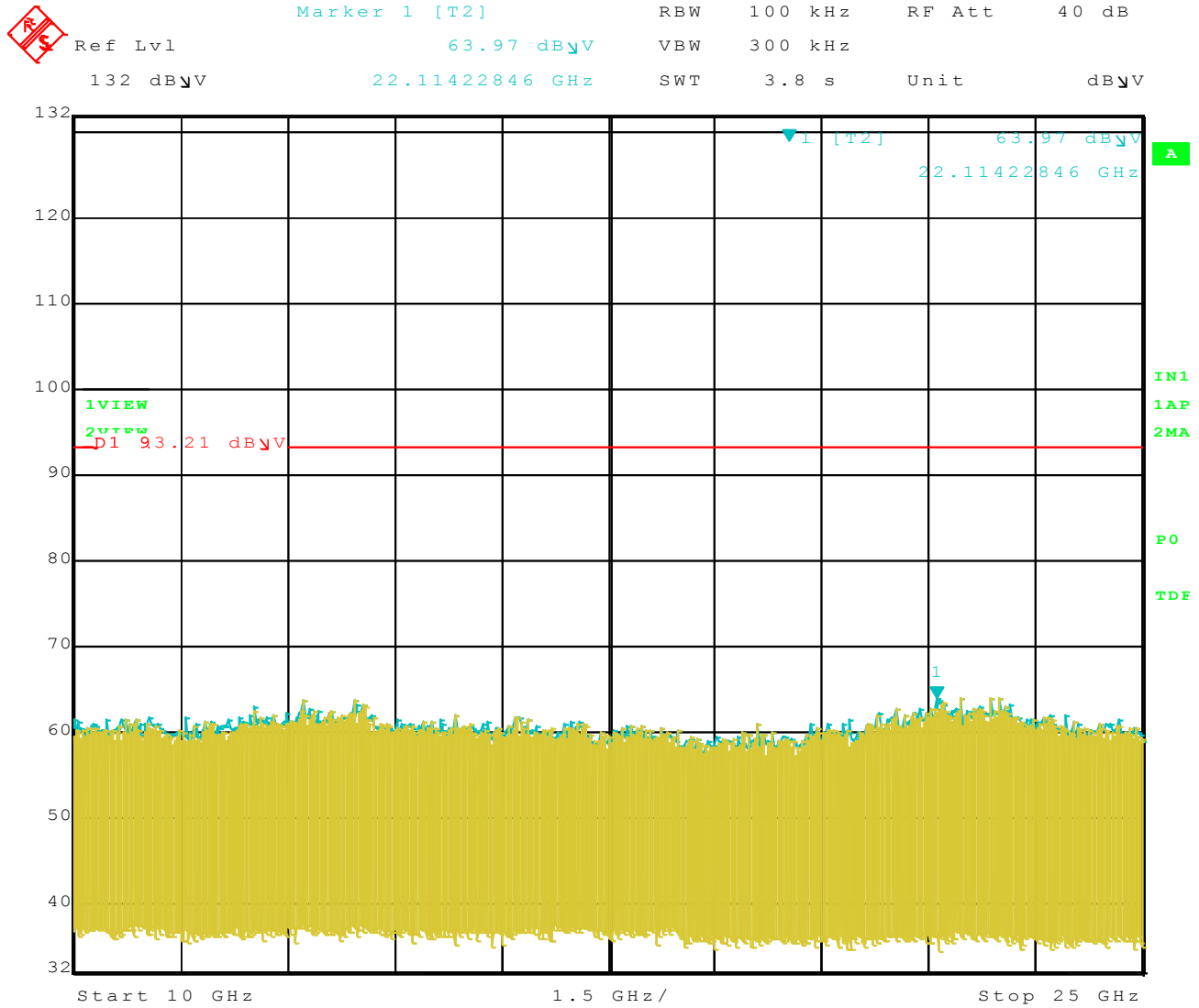

Date: 1.SEP.2010 17:11:51

Channel (1) 802.11 g RF Antenna Conducted 2 – 2000MHz



	Marker 1 [T2]	RBW 100 kHz	RF Att 40 dB
Ref Lvl	61.09 dB μ V	VBW 300 kHz	
132 dB μ V	1.95595591 GHz	SWT 1.15 s	Unit dB μ V

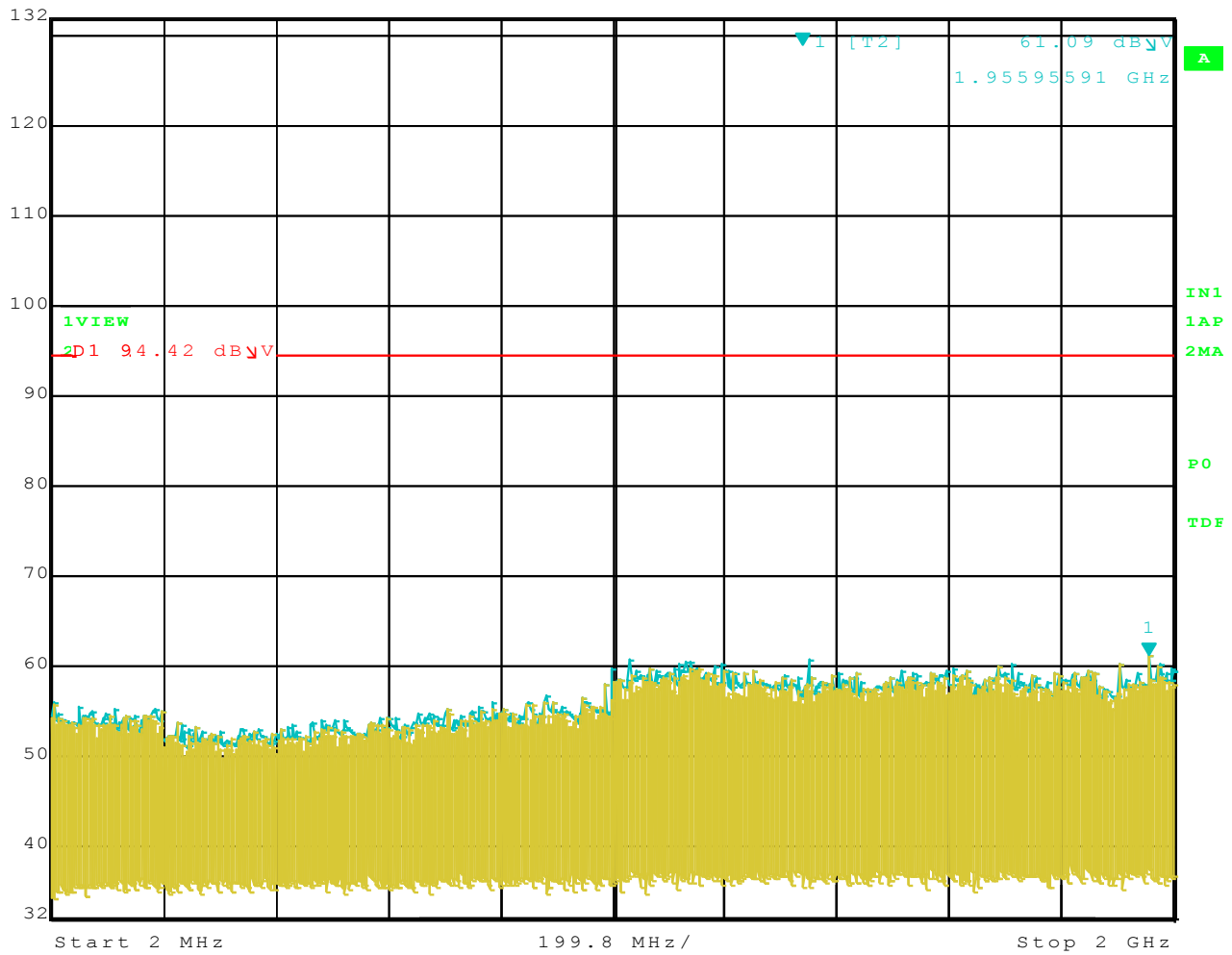

Date: 1.SEP.2010 17:19:39

Channel (1) 802.11 g RF Antenna Conducted 2 – 3 GHz

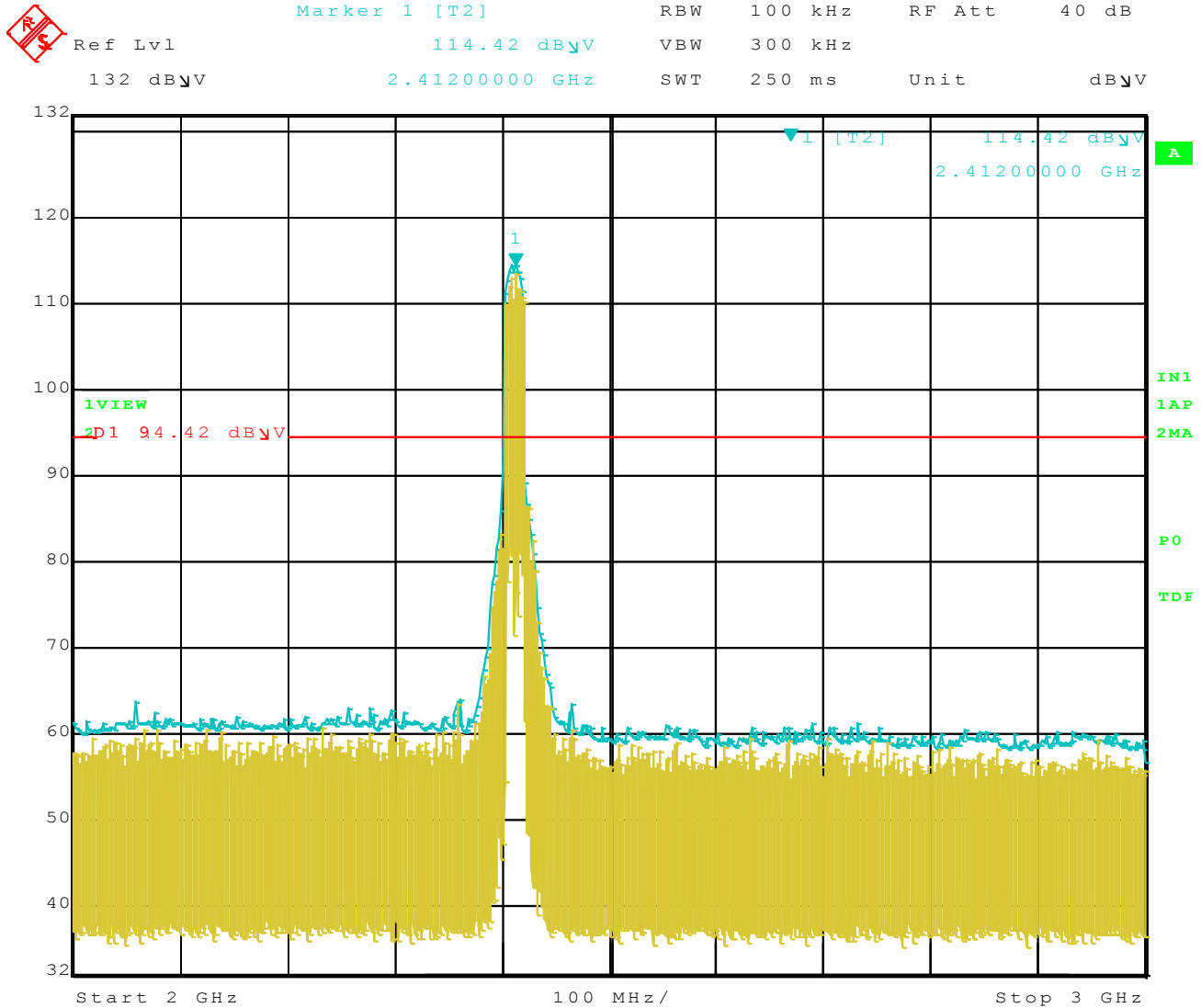

Date: 1.SEP.2010 17:18:38

Channel (1) 802.11 g RF Antenna Conducted 3 – 10 GHz



Ref Lvl	67.25 dB μ V	RBW	100 kHz	RF Att	40 dB
132 dB μ V	6.98396794 GHz	VBW	300 kHz	SWT	1.75 s
		Unit			dB μ V

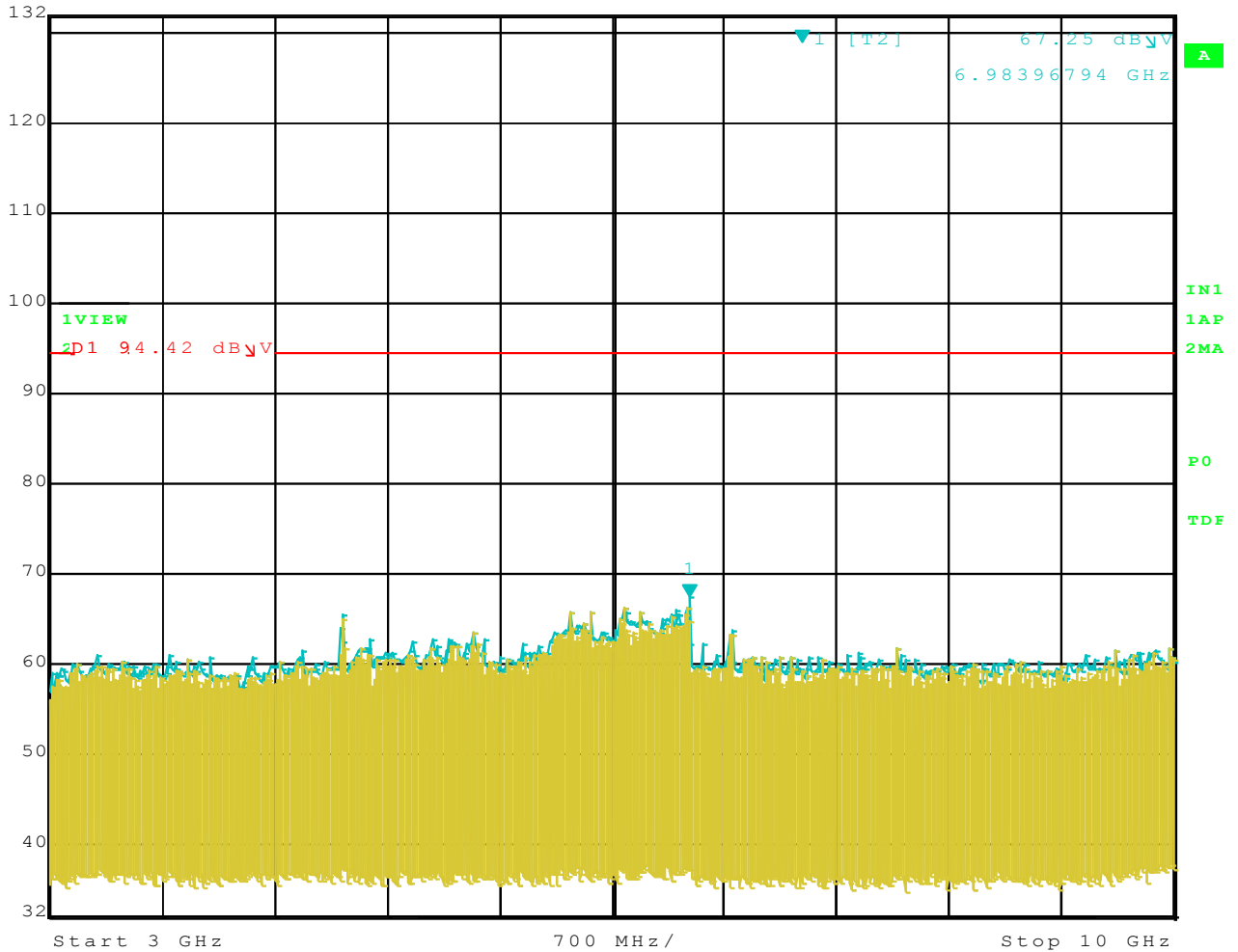

Date: 1.SEP.2010 17:20:07

Channel (1) 802.11 g RF Antenna Conducted 10 – 25GHz

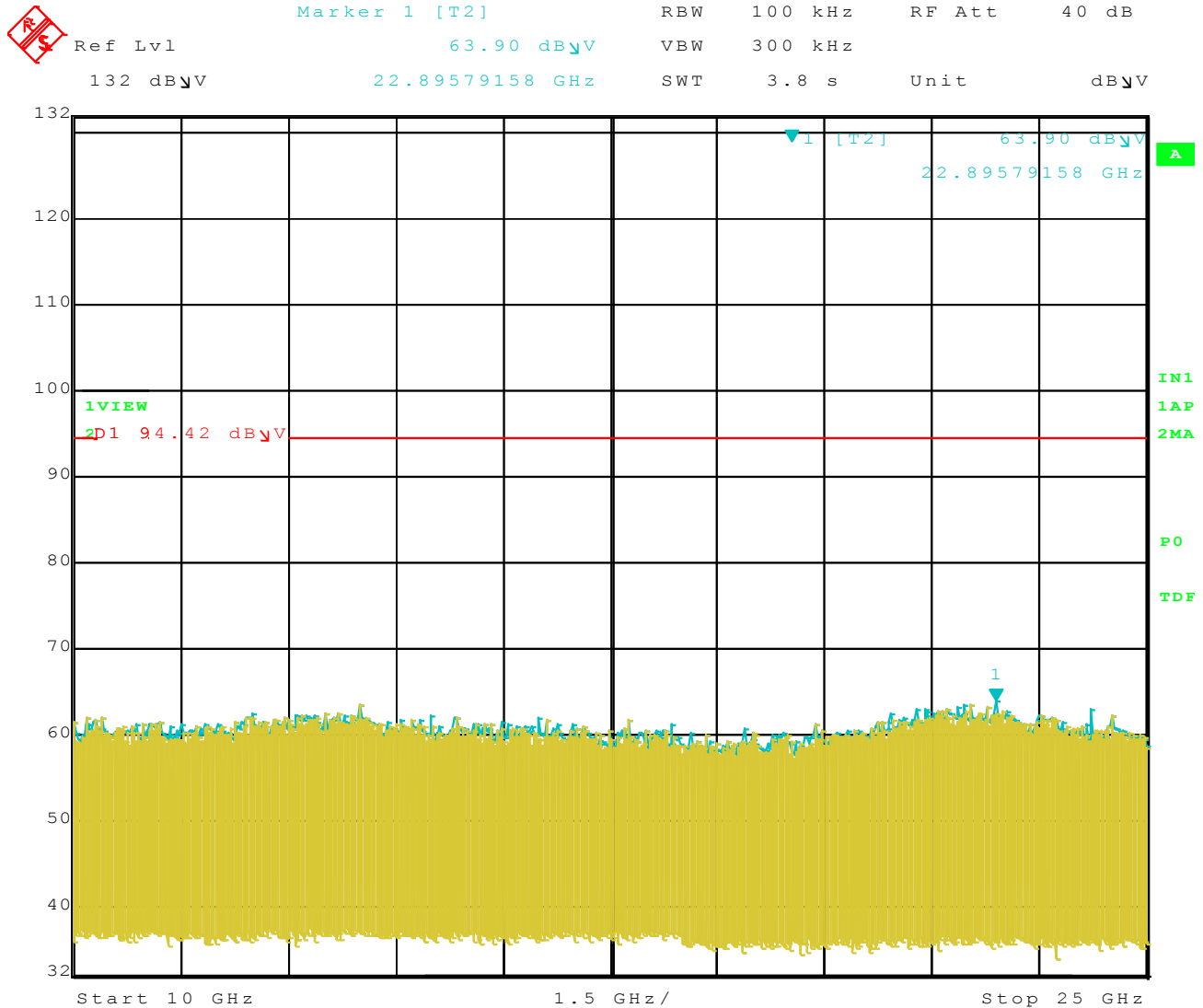

Date: 1.SEP.2010 17:20:38

Channel (6) 802.11 g RF Antenna Conducted 2 – 2000MHz

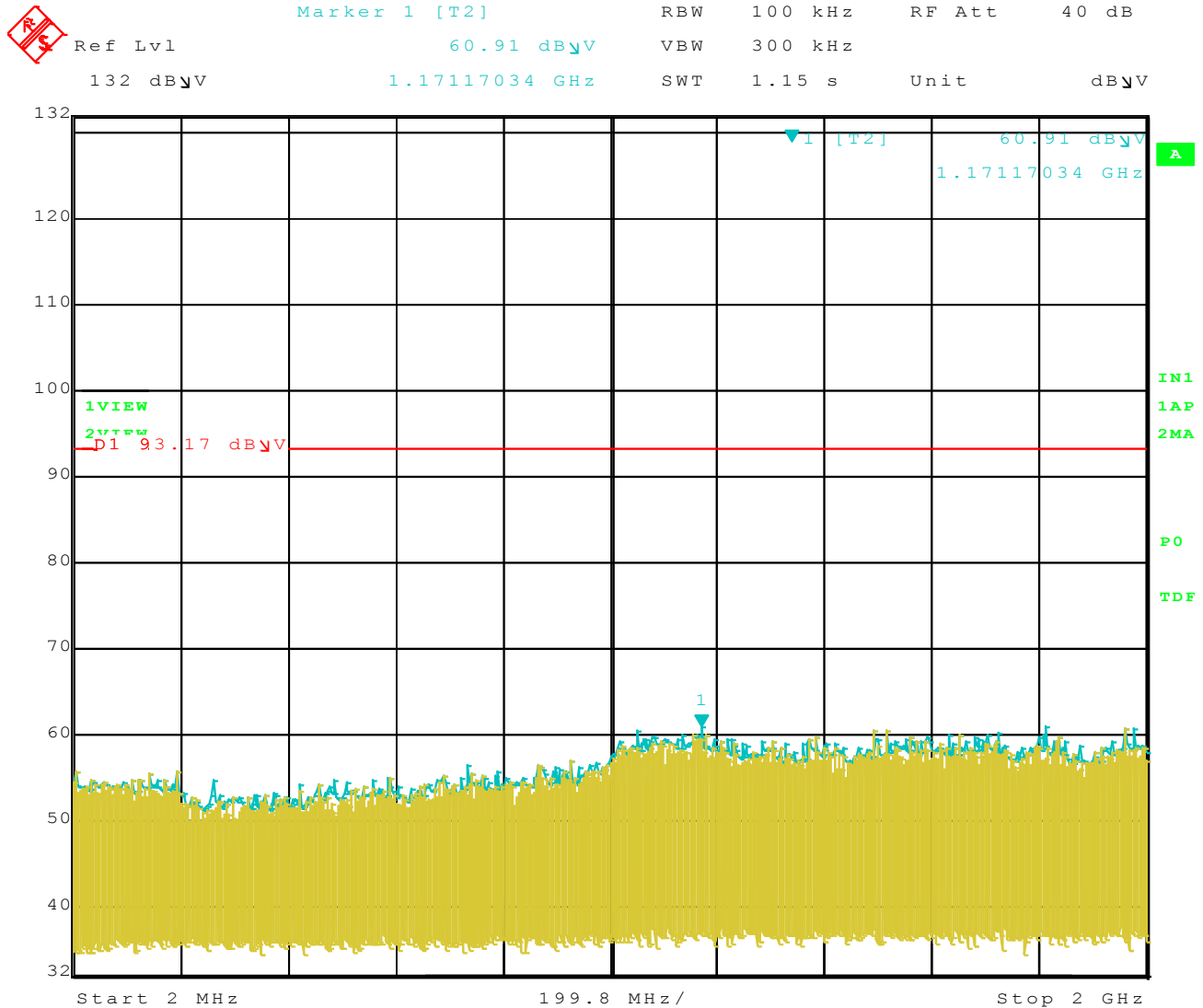

Date: 1.SEP.2010 17:25:12

Channel (6) 802.11 g RF Antenna Conducted 2 – 3 GHz

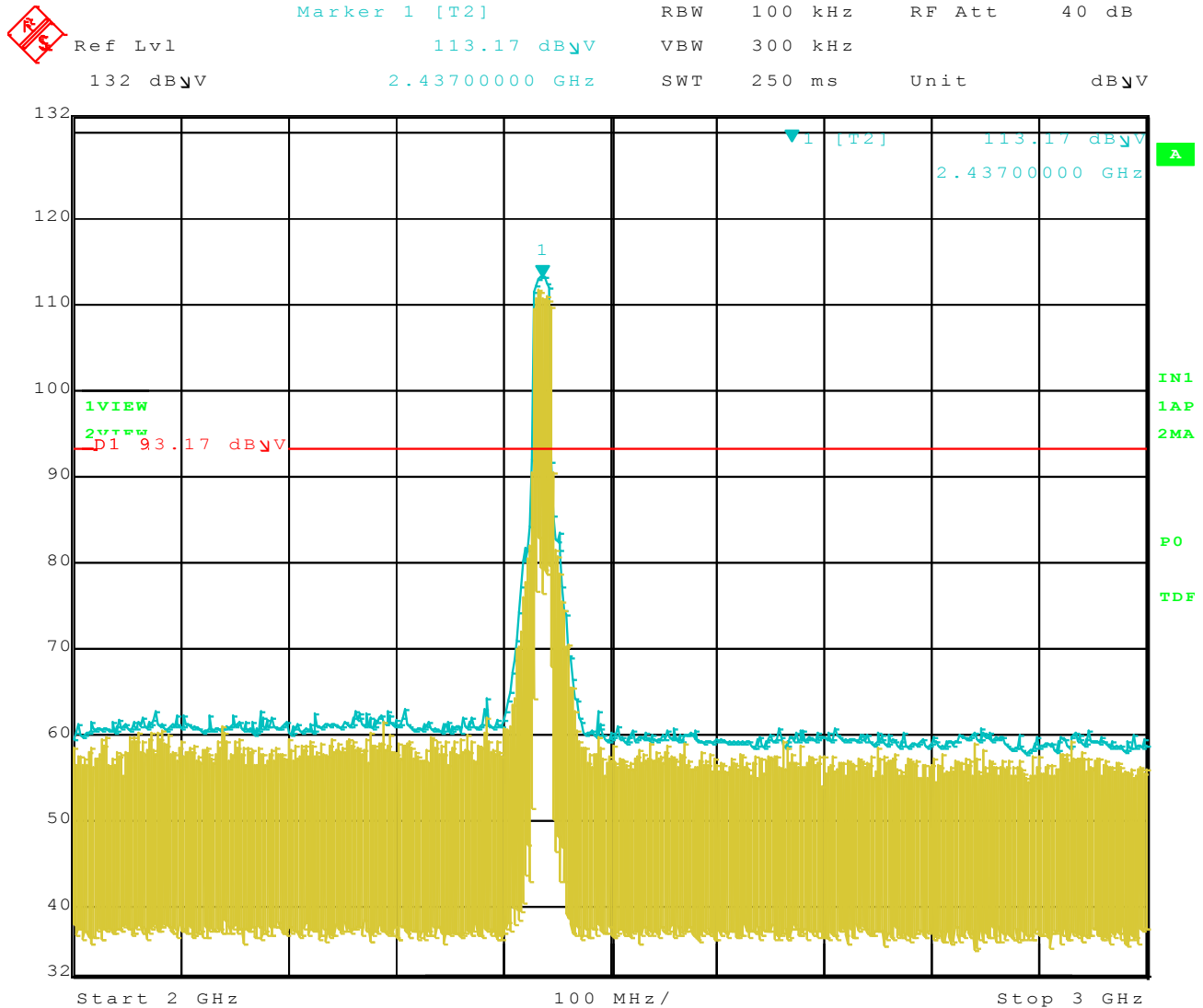

Date: 1.SEP.2010 17:24:31

Channel (6) 802.11 g RF Antenna Conducted 3 – 10 GHz

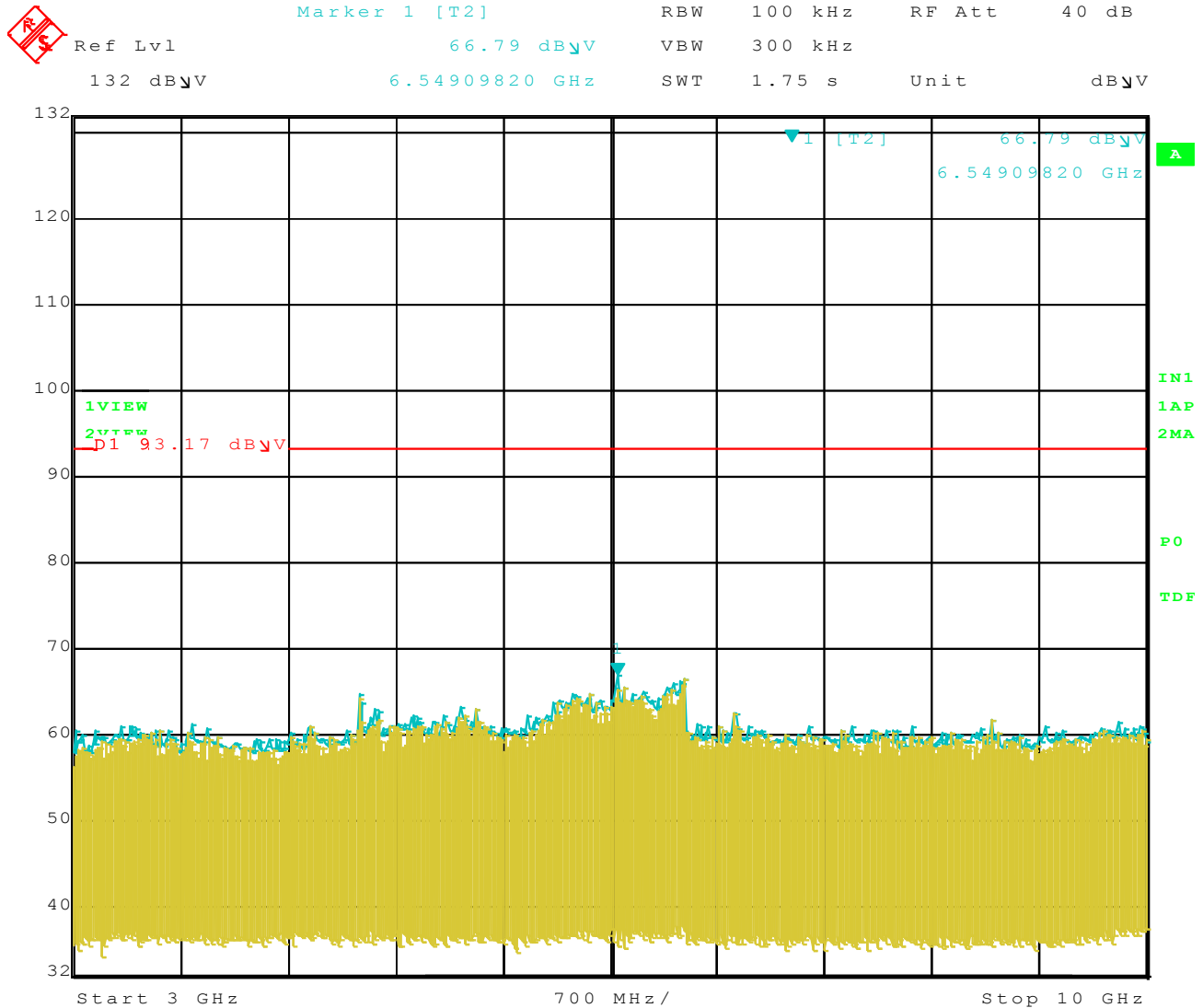

Date: 1.SEP.2010 17:25:47

Channel (6) 802.11 g RF Antenna Conducted 10 – 25GHz



Ref Lvl	63.52 dByV	RBW	100 kHz	RF Att	40 dB
132 dByV	23.01603206 GHz	VBW	300 kHz	SWT	3.8 s
		Unit			dByV

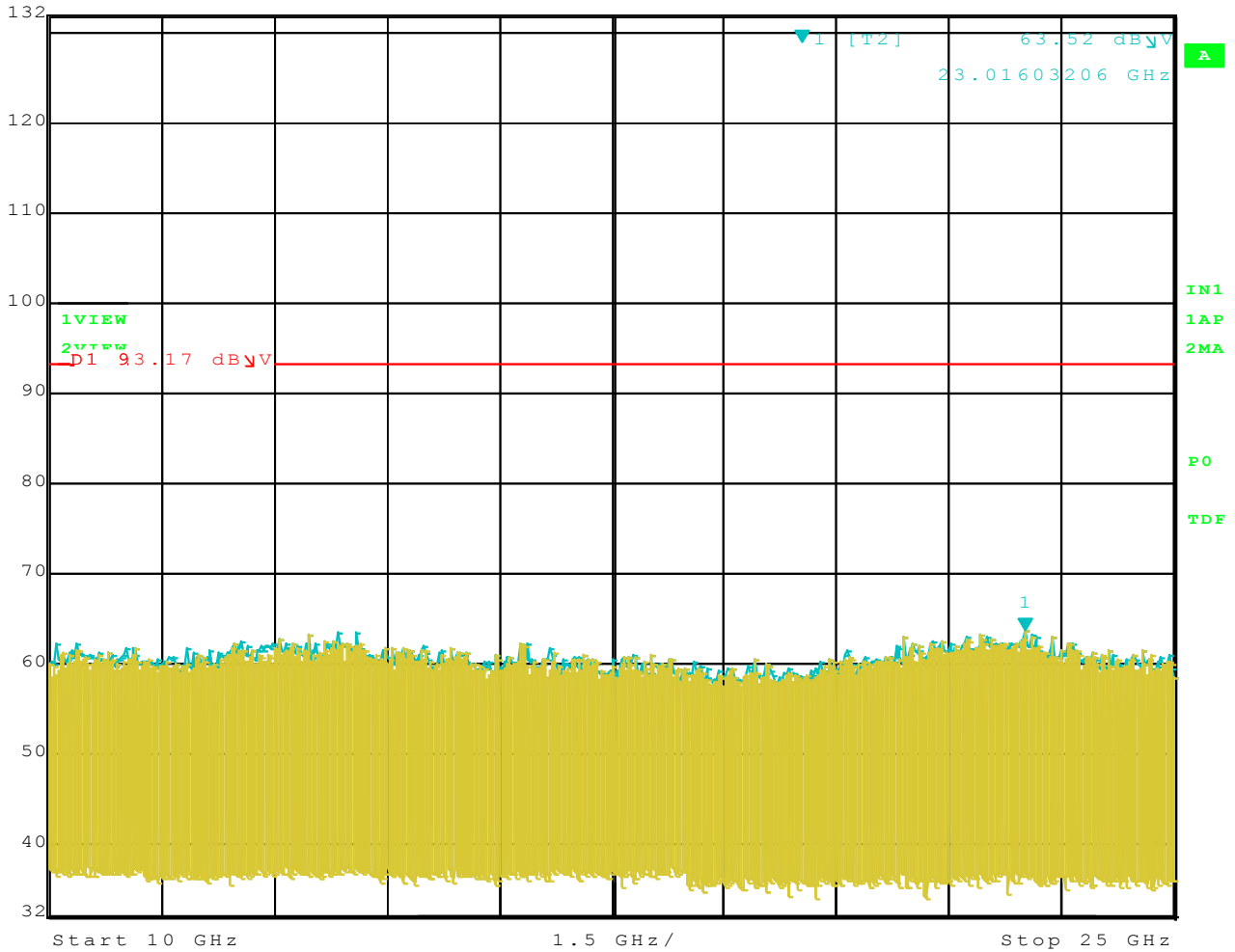

Date: 1.SEP.2010 17:26:21

Channel (11) 802.11 g RF Antenna Conducted
2 – 2000MHz

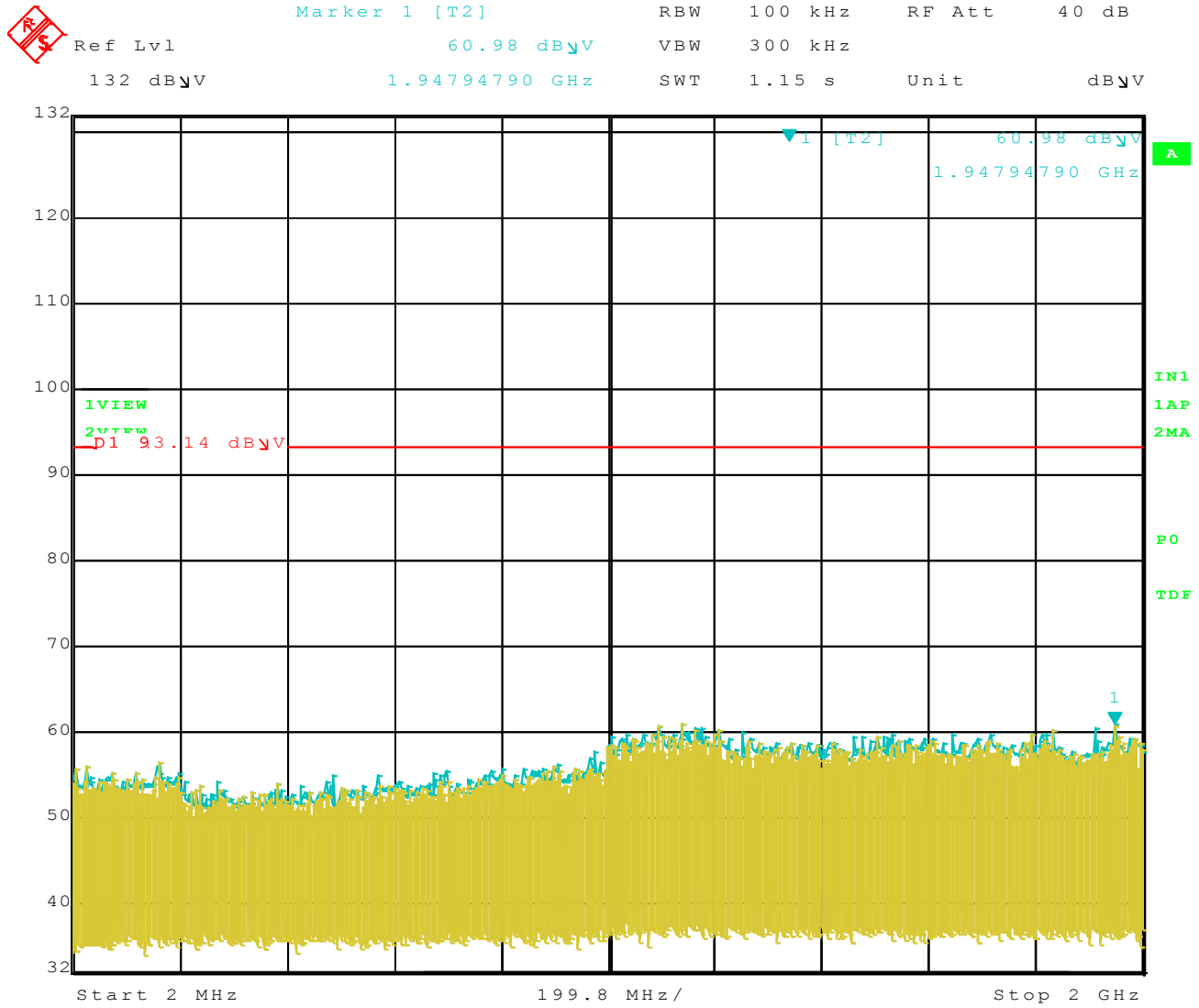

Date: 1.SEP.2010 17:30:29

**Channel (11) 802.11 g RF Antenna Conducted
 2 – 3 GHz**

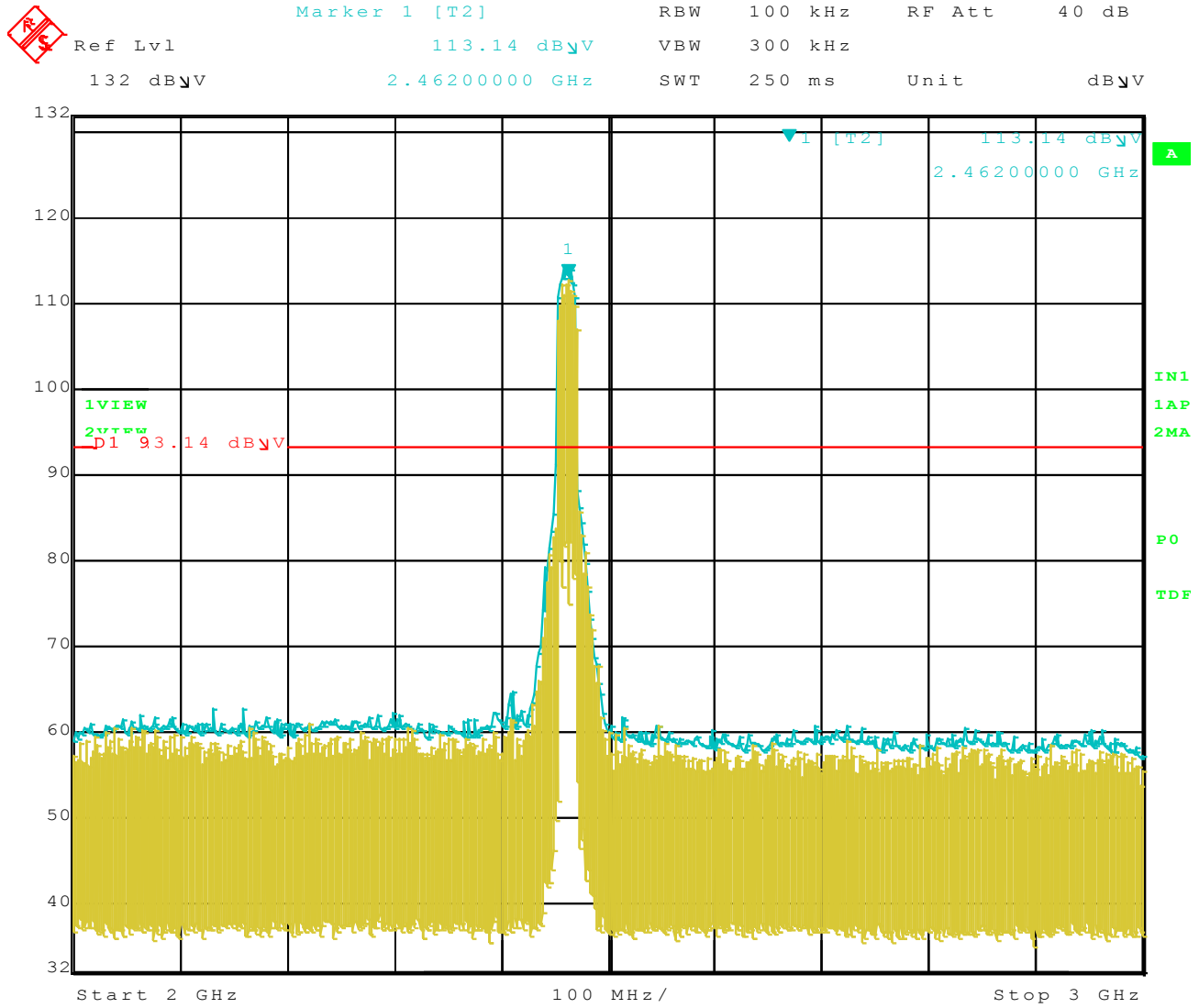

Date: 1.SEP.2010 17:29:56

Channel (11) 802.11 g RF Antenna Conducted 3 – 10 GHz

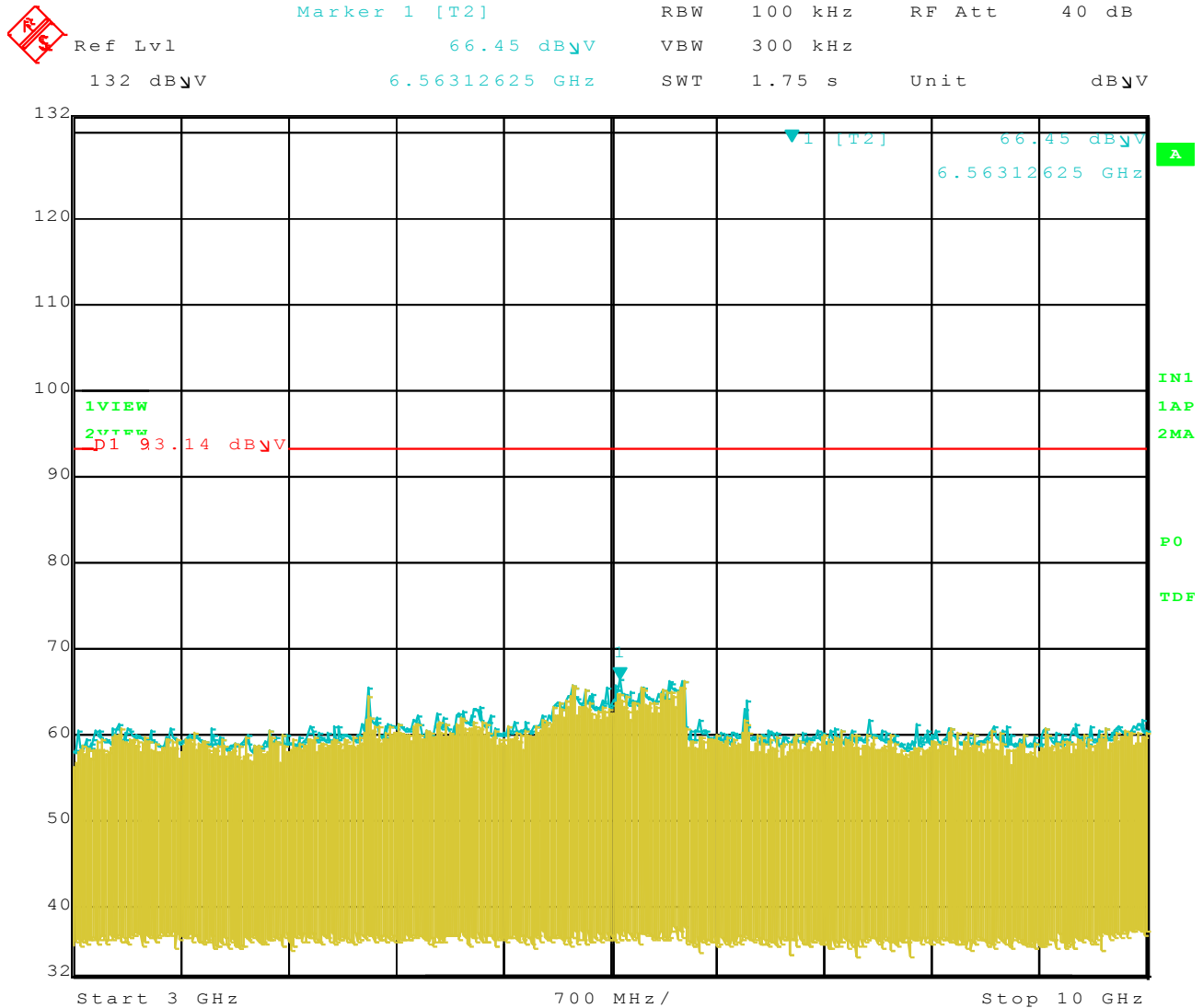

Date: 1.SEP.2010 17:31:06

Channel (11) 802.11 g RF Antenna Conducted 10 – 25GHz

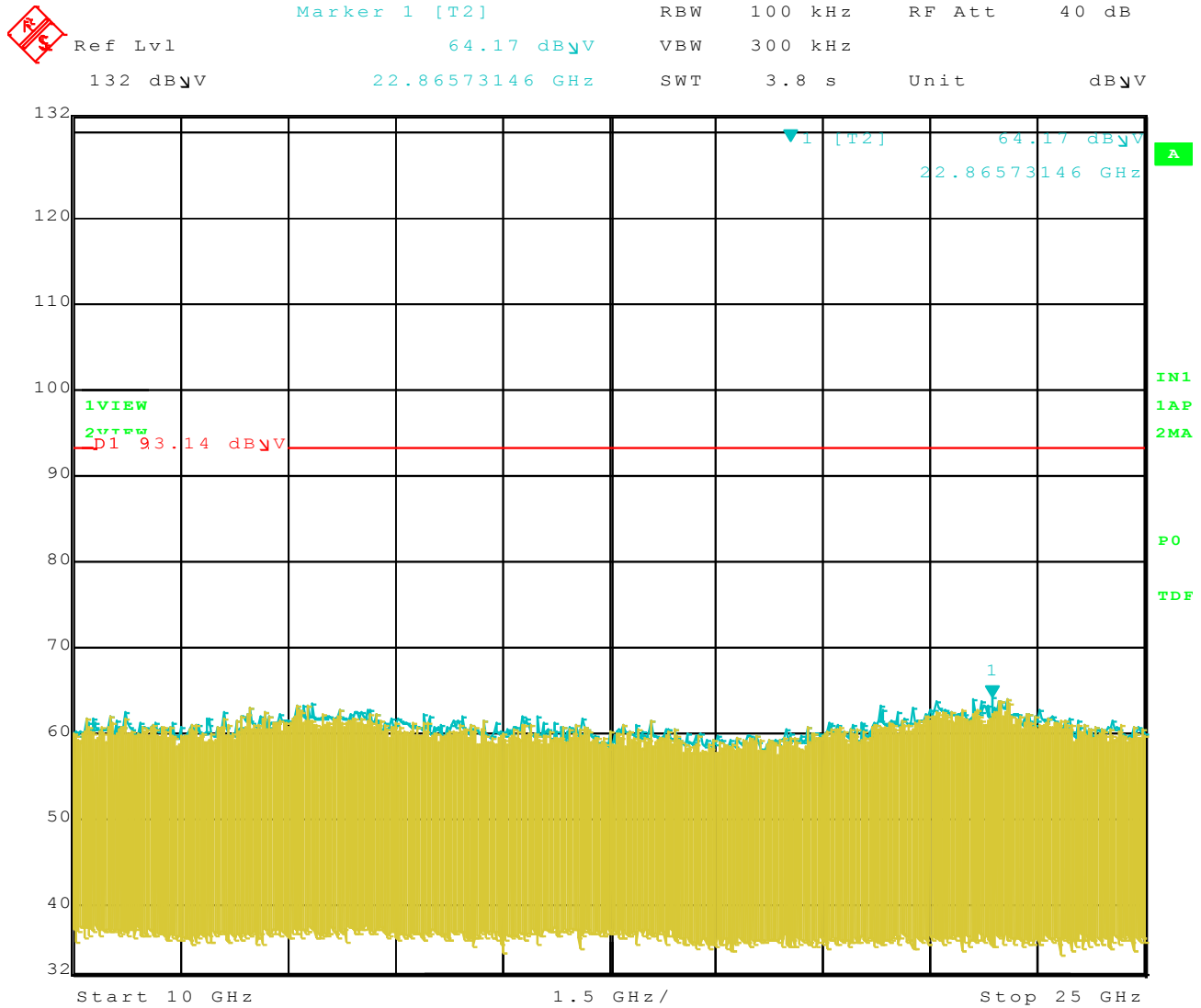

Date: 1.SEP.2010 17:31:47

SPECTRAL DENSITY OUTPUT

DATA SHEETS

Channel (1) 802.11 b Spectral Density Output

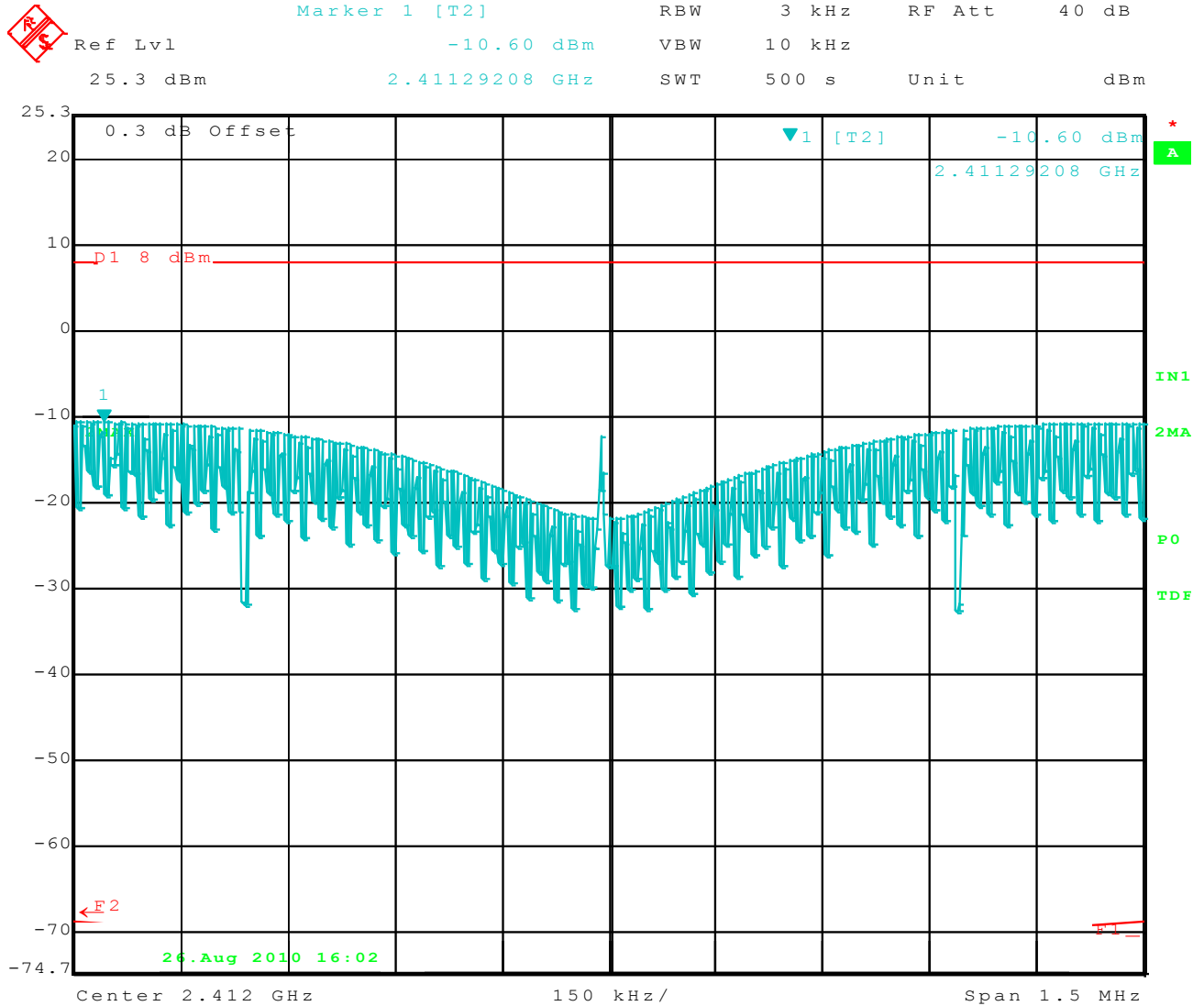

Date: 26.AUG.2010 16:02:46

Channel (6) 802.11 b Spectral Density Output

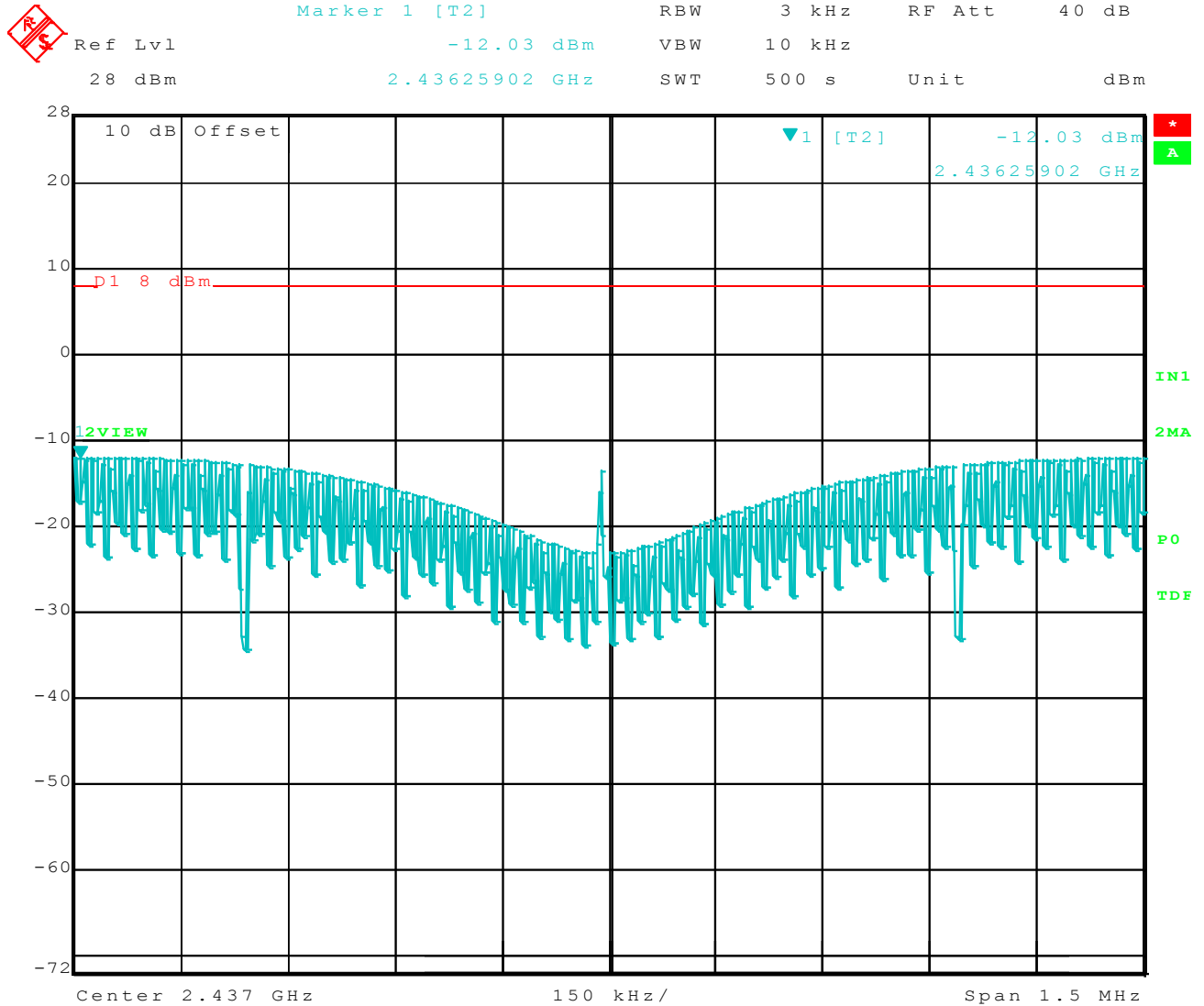

Date: 1.SEP.2010 18:37:06

Channel (11) 802.11 b Spectral Density Output

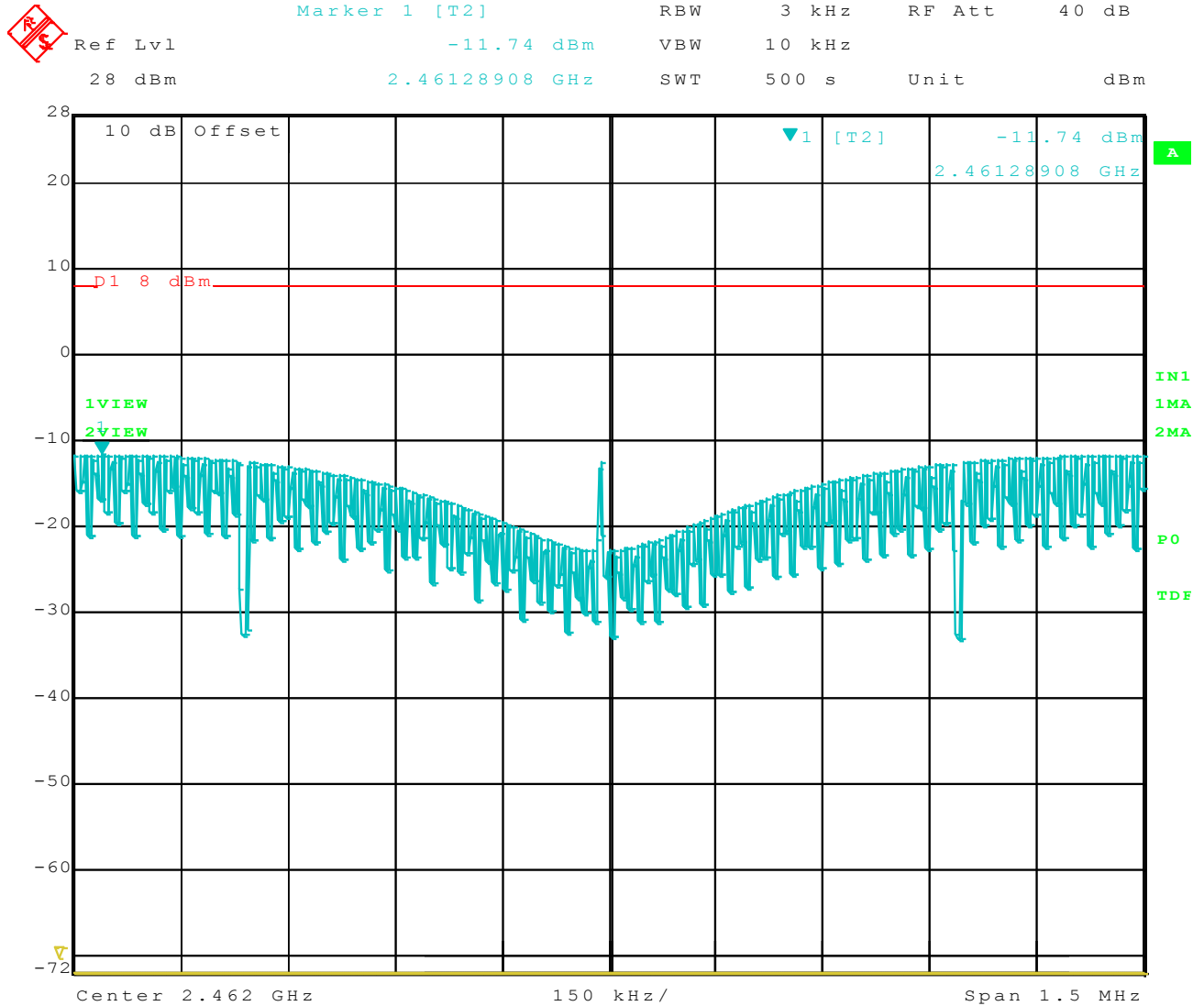

Date: 1.SEP.2010 18:46:08

Channel (1) 802.11 g Spectral Density Output

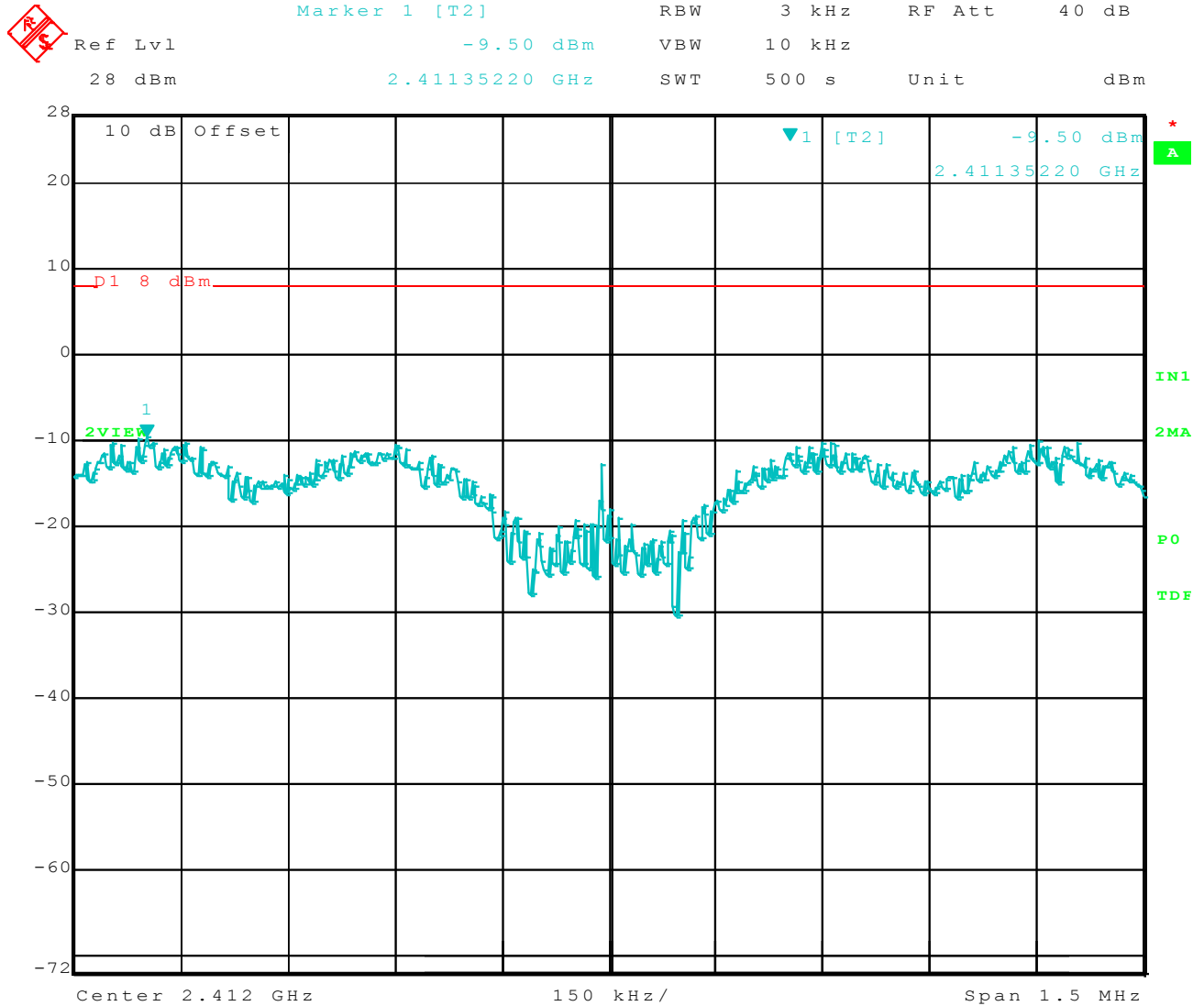

Date: 1.SEP.2010 18:26:15

Channel (6) 802.11 g Spectral Density Output

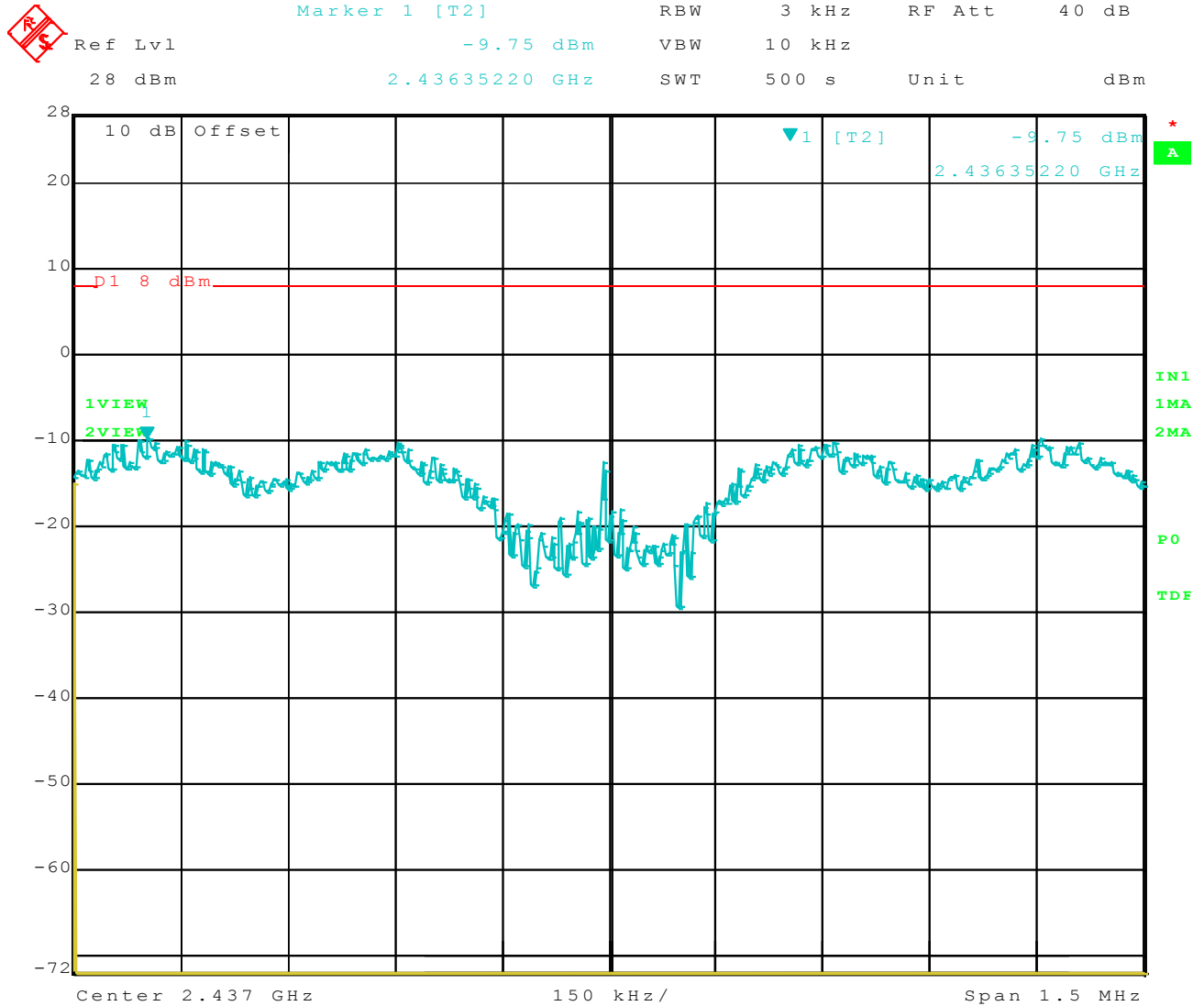

Date: 1.SEP.2010 18:16:23

Channel (11) 802.11 g Spectral Density Output

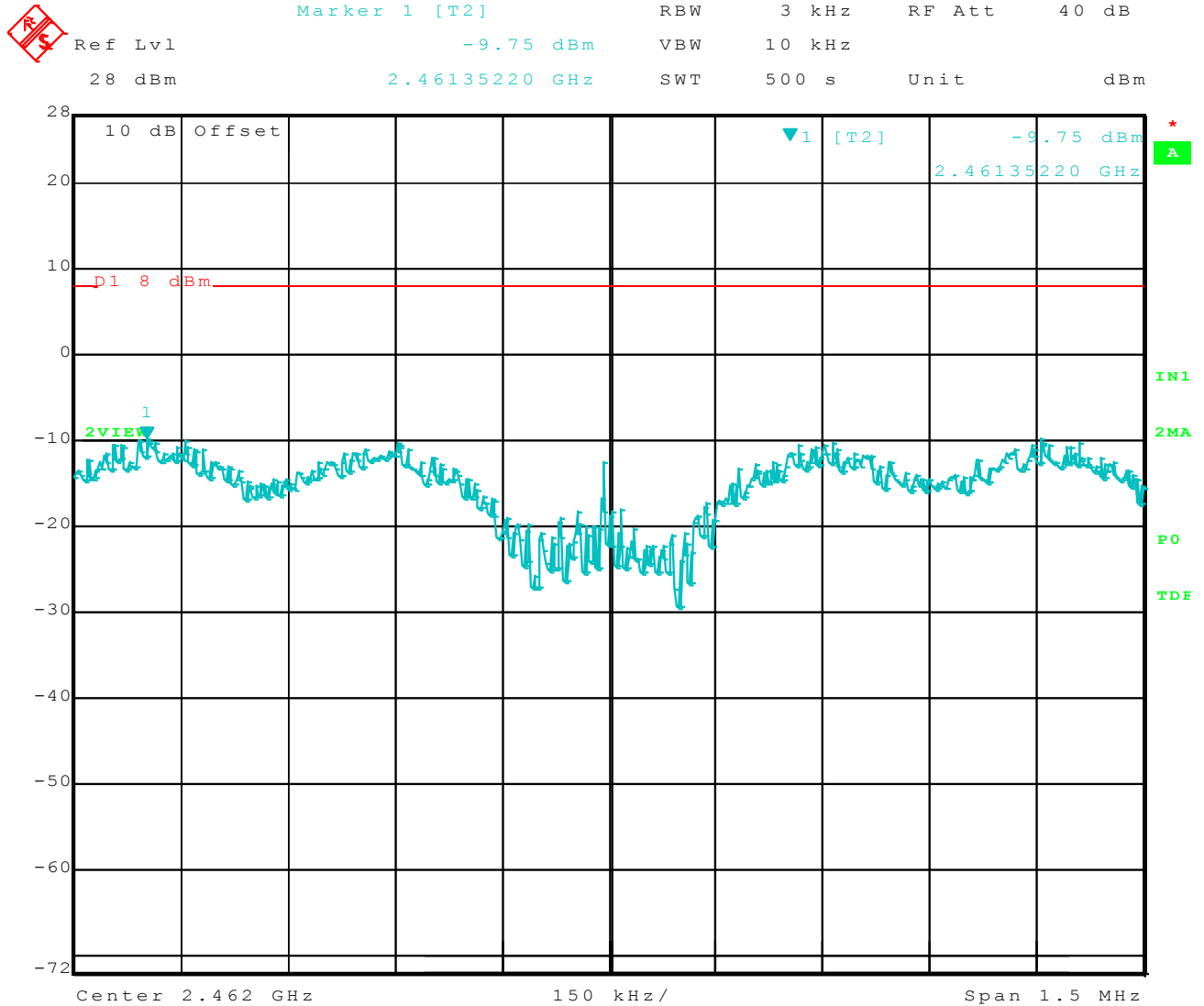

Date: 1.SEP.2010 18:07:07

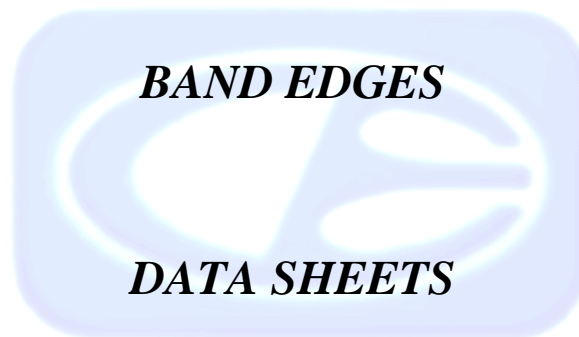

Channel (1) 802.11 b Horizontal Band Edge

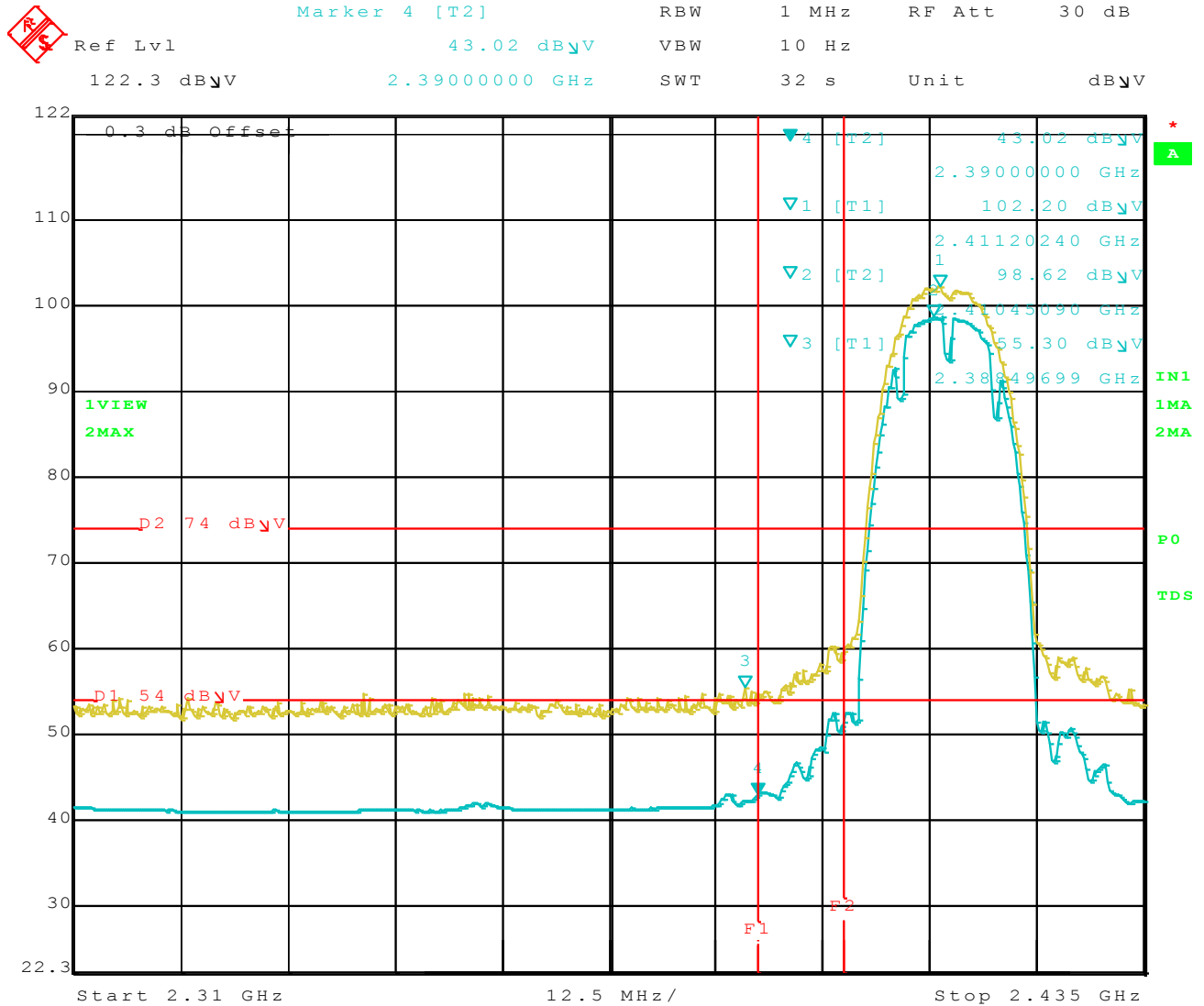

Date: 1.SEP.2010 11:36:03

Channel (1) 802.11 b Vertical Band Edge

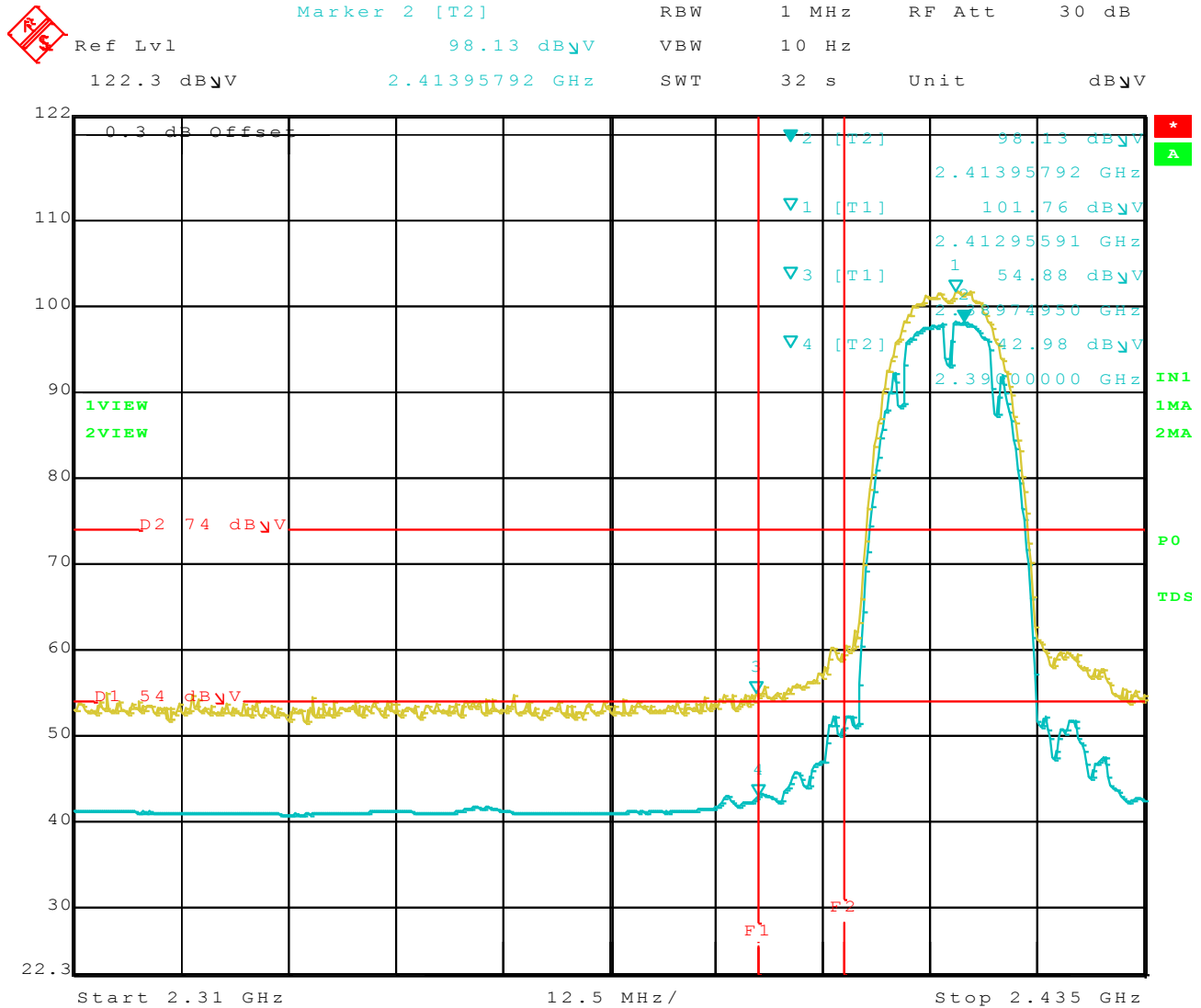

Date: 1.SEP.2010 11:31:33

Channel (11) 802.11 b Horizontal Band Edge

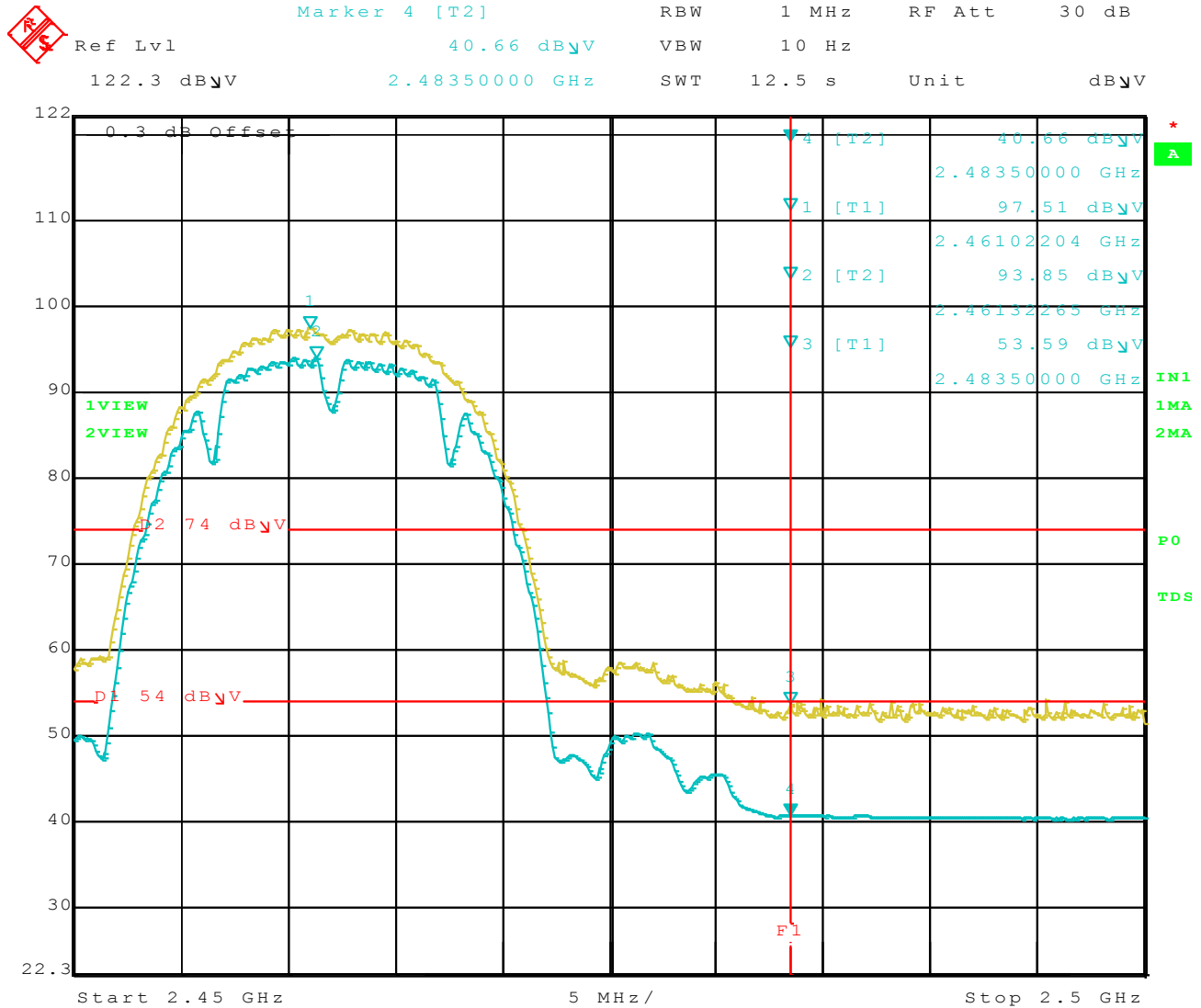

Date: 1.SEP.2010 11:42:42

Channel (11) 802.11 b Vertical Band Edge

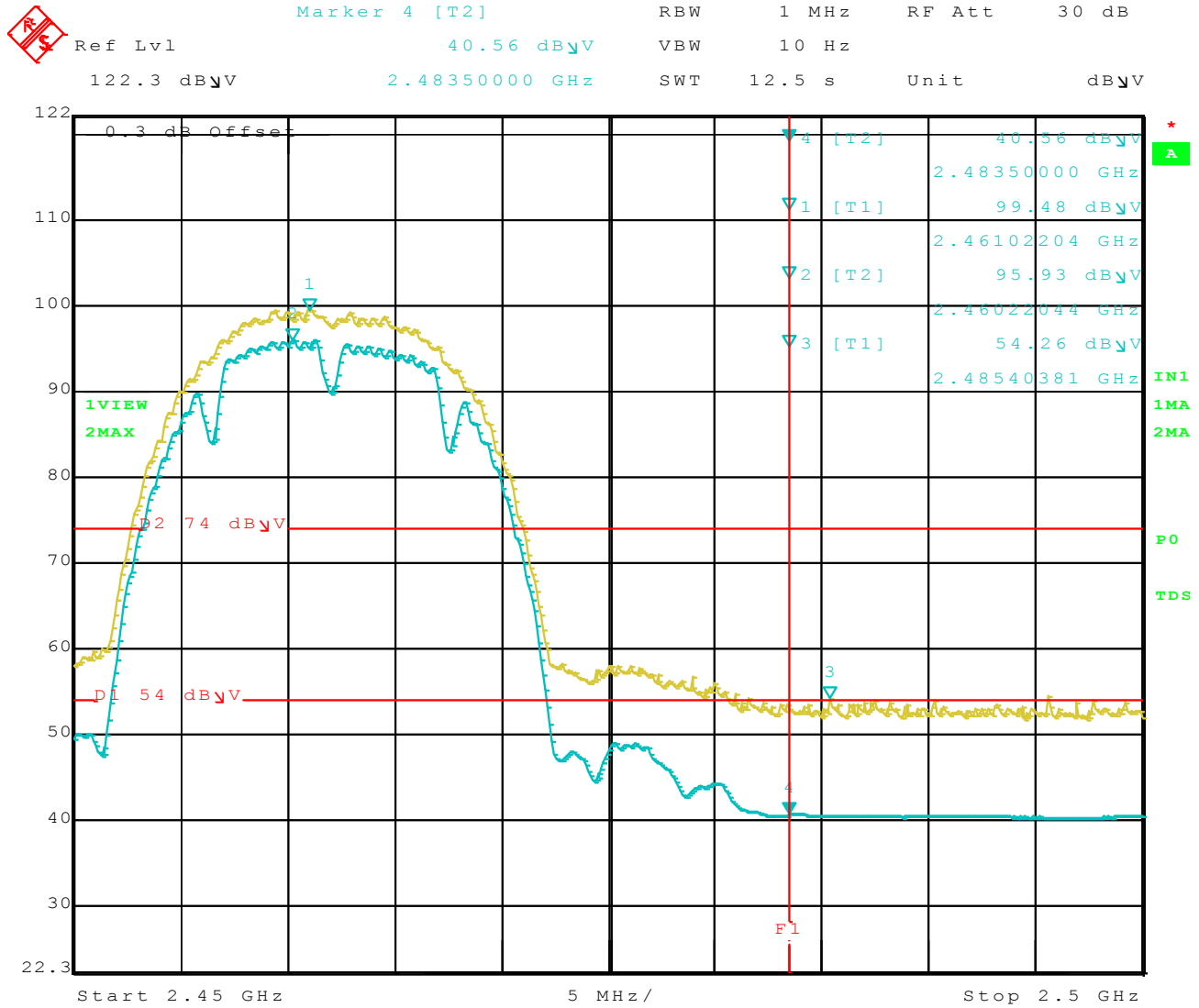

Date: 1.SEP.2010 11:47:43

Channel (1) 802.11 g Horizontal Band Edge

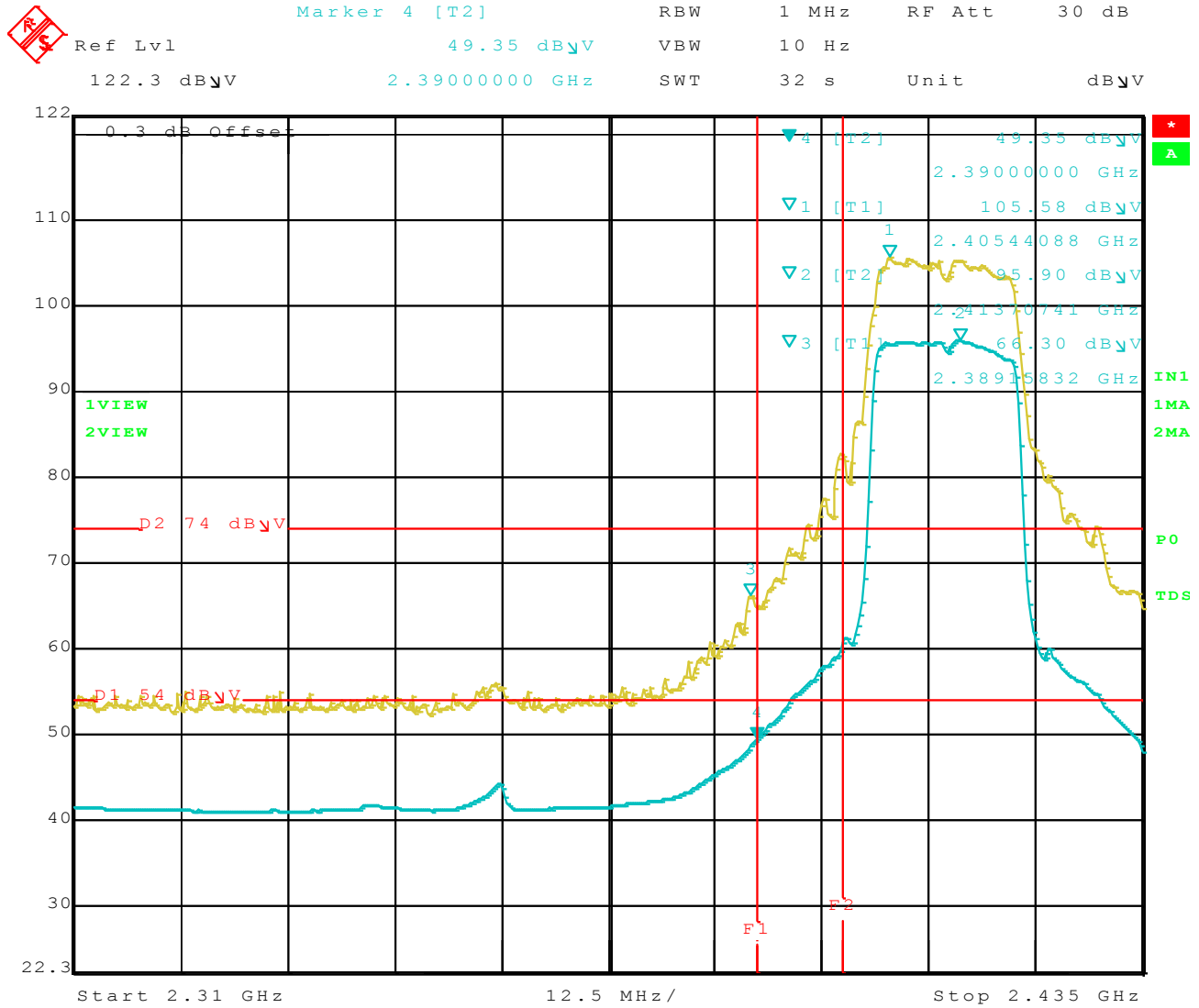

Date: 1.SEP.2010 10:44:21

Channel (1) 802.11 g Vertical Band Edge

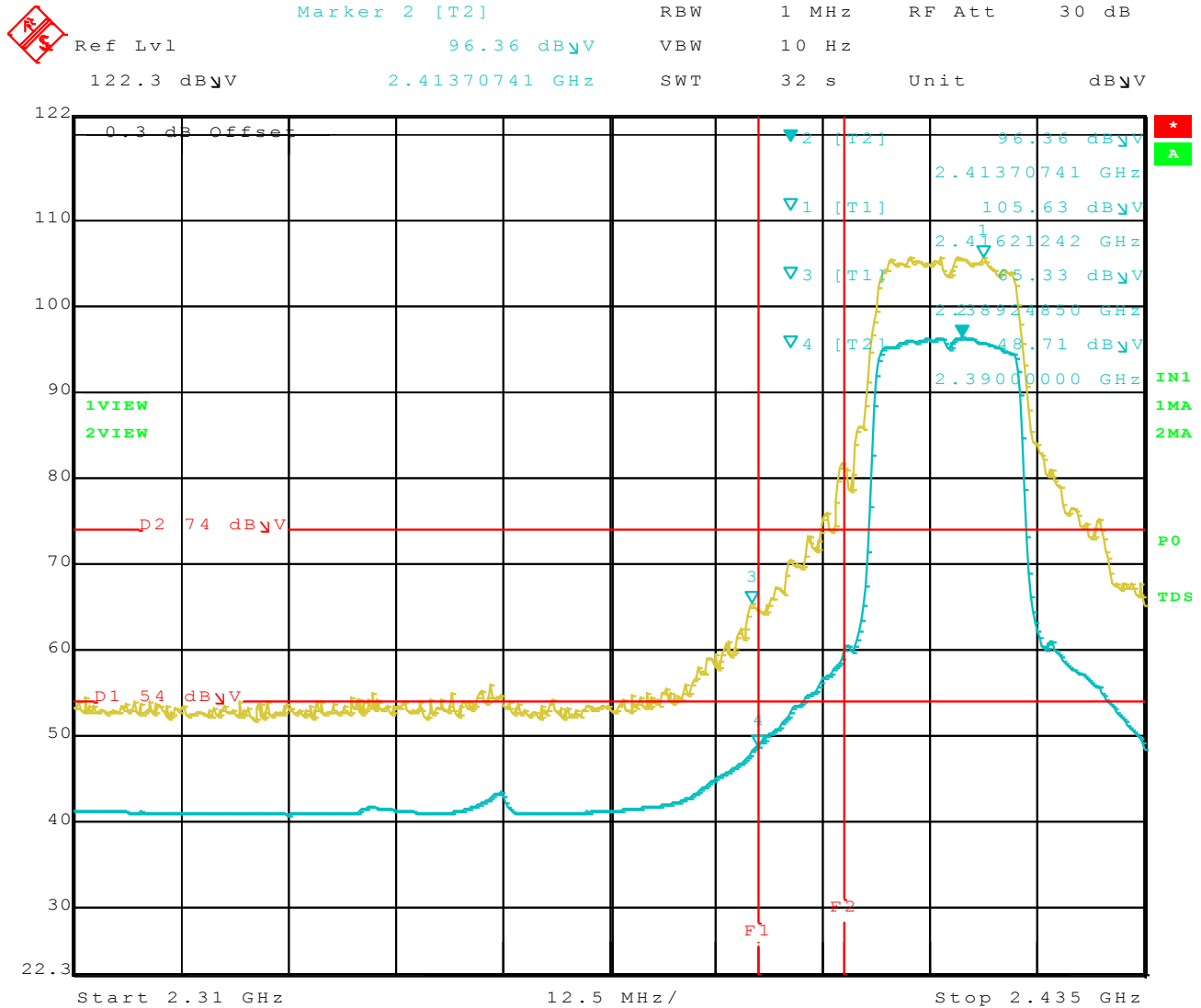

Date: 1.SEP.2010 10:50:13

Channel (11) 802.11 g Horizontal Band Edge

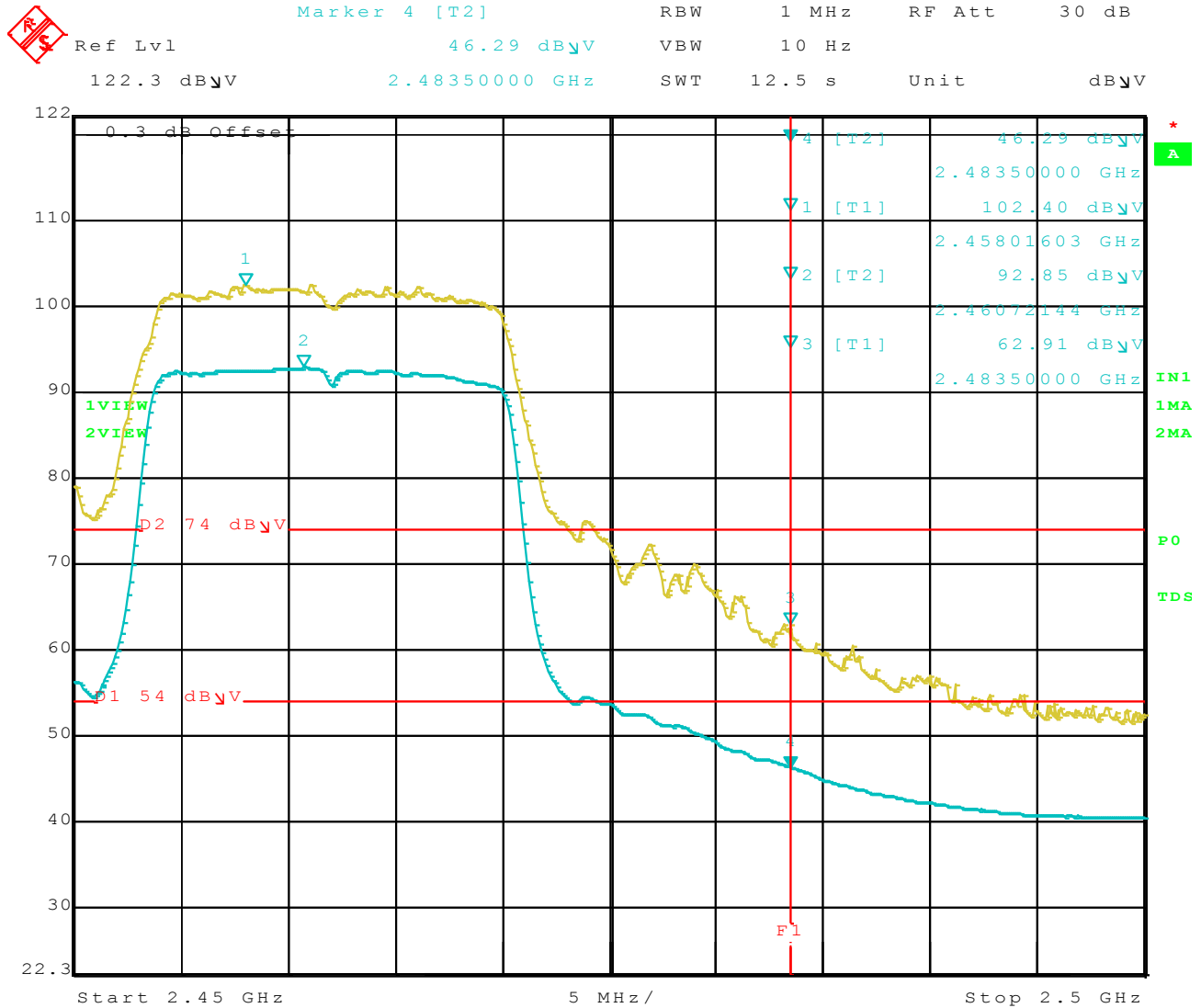

Date: 1.SEP.2010 11:08:57

Channel (11) 802.11 g Vertical Band Edge

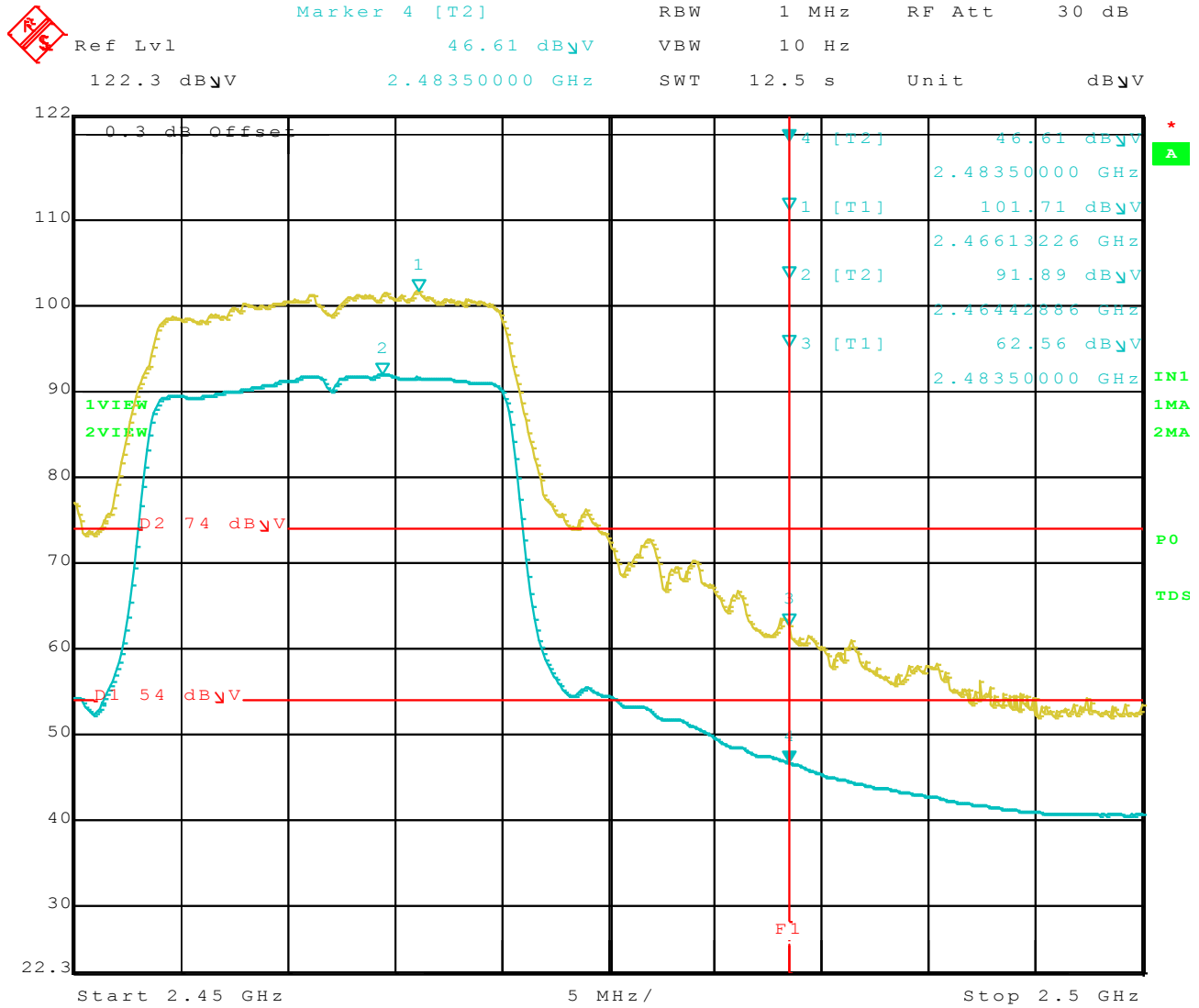

Date: 1.SEP.2010 11:02:56