



# FCC TEST REPORT

**REPORT NO.:** RF970430L10

**MODEL NO.:** F5D8055v1

**RECEIVED:** Apr. 30, 2008

**TESTED:** May 06 ~ Aug. 04, 2008

**ISSUED:** Aug. 08, 2008

**APPLICANT:** Belkin International, Inc.

**ADDRESS:** 501 West Walnut Street, Compton, CA  
90220-5221

**ISSUED BY:** Advance Data Technology Corporation

**LAB ADDRESS:** No. 47, 14th Ling, Chia Pau Tsuen, Lin Kou  
Hsiang, Taipei Hsien 244, Taiwan, R.O.C.

**TEST LOCATION:** No. 19, Hwa Ya 2nd Rd, Wen Hwa Tsuen, Kwei  
Shan Hsiang, Taoyuan Hsien 333, Taiwan,  
R.O.C.

No. 47, 14th Ling, Chia Pau Tsuen, Lin Kou  
Hsiang, Taipei Hsien 244, Taiwan, R.O.C.

This test report consists of 91 pages in total. It may be duplicated completely for legal use with the approval of the applicant. It should not be reproduced except in full, without the written approval of our laboratory. The client should not use it to claim product endorsement by TAF or any government agencies. The test results in the report only apply to the tested sample.





## TABLE OF CONTENTS

1.	CERTIFICATION.....	4
2.	SUMMARY OF TEST RESULTS .....	5
2.1	MEASUREMENT UNCERTAINTY.....	5
3.	GENERAL INFORMATION.....	6
3.1	GENERAL DESCRIPTION OF EUT .....	6
3.2	DESCRIPTION OF TEST MODES .....	7
3.2.1	CONFIGURATION OF SYSTEM UNDER TEST .....	8
3.2.2	TEST MODE APPLICABILITY AND TESTED CHANNEL DETAIL .....	9
3.3	GENERAL DESCRIPTION OF APPLIED STANDARDS .....	11
3.4	DESCRIPTION OF SUPPORT UNITS .....	12
4.	TEST TYPES AND RESULTS .....	13
4.1	RADIATED EMISSION MEASUREMENT .....	13
4.1.1	LIMITS OF RADIATED EMISSION MEASUREMENT .....	13
4.1.2	TEST INSTRUMENTS.....	14
4.1.3	TEST PROCEDURES .....	16
4.1.4	DEVIATION FROM TEST STANDARD.....	16
4.1.5	TEST SETUP .....	17
4.1.6	EUT OPERATING CONDITIONS .....	17
4.1.7	TEST RESULTS .....	18
4.2	CONDUCTED EMISSION MEASUREMENT .....	32
4.2.1	LIMITS OF CONDUCTED EMISSION MEASUREMENT .....	32
4.2.2	TEST INSTRUMENTS.....	32
4.2.3	TEST PROCEDURES .....	33
4.2.4	DEVIATION FROM TEST STANDARD.....	33
4.2.5	TEST SETUP .....	34
4.2.6	EUT OPERATING CONDITIONS .....	34
4.2.7	TEST RESULTS .....	35
4.3	6dB BANDWIDTH MEASUREMENT .....	37
4.3.1	LIMITS OF 6dB BANDWIDTH MEASUREMENT .....	37
4.3.2	TEST INSTRUMENTS.....	37
4.3.3	TEST PROCEDURE.....	37
4.3.4	DEVIATION FROM TEST STANDARD.....	37
4.3.5	TEST SETUP .....	38
4.3.6	EUT OPERATING CONDITIONS .....	38
4.3.7	TEST RESULTS .....	39
4.4	MAXIMUM PEAK OUTPUT POWER.....	51
4.4.1	LIMITS OF MAXIMUM PEAK OUTPUT POWER MEASUREMENT .....	51
4.4.2	INSTRUMENTS.....	51
4.4.3	TEST PROCEDURES .....	51
4.4.4	DEVIATION FROM TEST STANDARD.....	52
4.4.5	TEST SETUP .....	52
4.4.6	EUT OPERATING CONDITIONS .....	52



4.4.7	TEST RESULTS .....	53
4.5	POWER SPECTRAL DENSITY MEASUREMENT .....	55
4.5.1	LIMITS OF POWER SPECTRAL DENSITY MEASUREMENT .....	55
4.5.2	TEST INSTRUMENTS.....	55
4.5.3	TEST PROCEDURE.....	55
4.5.4	DEVIATION FROM TEST STANDARD.....	56
4.5.5	TEST SETUP .....	56
4.5.6	EUT OPERATING CONDITION.....	56
4.5.7	TEST RESULTS .....	57
4.6	BAND EDGES MEASUREMENT .....	69
4.6.1	LIMITS OF BAND EDGES MEASUREMENT .....	69
4.6.2	TEST INSTRUMENTS.....	69
4.6.3	TEST PROCEDURE.....	70
4.6.4	DEVIATION FROM TEST STANDARD.....	71
4.6.5	EUT OPERATING CONDITION.....	71
4.6.6	TEST RESULTS .....	72
4.7	ANTENNA REQUIREMENT .....	88
4.7.1	STANDARD APPLICABLE.....	88
4.7.2	ANTENNA CONNECTED CONSTRUCTION .....	88
5.	PHOTOGRAPHS OF THE TEST CONFIGURATION.....	89
6.	INFORMATION ON THE TESTING LABORATORIES .....	90
7.	APPENDIX A - MODIFICATIONS RECORDERS FOR ENGINEERING CHANGES TO THE EUT BY THE LAB.....	91



# 1. CERTIFICATION

**PRODUCT:** N+ Wireless USB Adapter  
**MODEL:** F5D8055v1  
**BRAND:** Belkin  
**APPLICANT:** Belkin International, Inc.  
**TEST SAMPLE:** ENGINEERING SAMPLE  
**TESTED:** May 06 ~ Aug. 04, 2008  
**STANDARDS:** **FCC Part 15, Subpart C (Section 15.247)**  
ANSI C63.4-2003

The above equipment (Model: F5D8055v1) has been tested by **Advance Data Technology Corporation**, and found compliance with the requirement of the above standards. The test record, data evaluation & Equipment Under Test (EUT) configurations represented herein are true and accurate accounts of the measurements of the sample's EMC characteristics under the conditions specified in this report.

**PREPARED BY** : Ivy Lin , **DATE:** Aug. 08, 2008  
Ivy Lin / Specialist

**TECHNICAL ACCEPTANCE** : Long Chen , **DATE:** Aug. 08, 2008  
Responsible for RF Long Chen / Senior Engineer

**APPROVED BY** : Gary Chang , **DATE:** Aug. 08, 2008  
Gary Chang / Assistant Manager

## 2. SUMMARY OF TEST RESULTS

The EUT has been tested according to the following specifications:

APPLIED STANDARD: FCC PART 15, SUBPART C (SECTION 15.247)			
STANDARD SECTION	TEST TYPE AND LIMIT	RESULT	REMARK
15.207	AC Power Conducted Emission	PASS	Meet the requirement of limit. Minimum passing margin is -20.92dB at 0.220MHz
15.247(a)(2)	Spectrum Bandwidth of a Direct Sequence Spread Spectrum System Limit: min. 500kHz	PASS	Meet the requirement of limit.
15.247(b)	Maximum Peak Output Power Limit: max. 30dBm	PASS	Meet the requirement of limit.
15.247(d)	Radiated Emissions Limit: Table 15.209	PASS	Meet the requirement of limit. Minimum passing margin is -1.82dB at 2386.00MHz
15.247(e)	Power Spectral Density Limit: max. 8dBm	PASS	Meet the requirement of limit.
15.247(d)	Band Edge Measurement Limit: 20dB less than the peak value of fundamental frequency	PASS	Meet the requirement of limit.

### 2.1 MEASUREMENT UNCERTAINTY

Where relevant, the following measurement uncertainty levels have been estimated for tests performed on the EUT as specified in CISPR 16-4-2:

MEASUREMENT	FREQUENCY	UNCERTAINTY
Conducted emissions	9kHz ~ 30MHz	2.44dB
Radiated emissions	30MHz ~ 1000MHz	4.03 dB
	1GHz ~ 18GHz	2.26 dB
	18GHz ~ 40GHz	1.94 dB

This uncertainty represents an expanded uncertainty expressed at approximately the 95% confidence level using a coverage factor of  $k = 2$ .

### 3. GENERAL INFORMATION

#### 3.1 GENERAL DESCRIPTION OF EUT

<b>EUT</b>	N+ Wireless USB Adapter
<b>MODEL NO.</b>	F5D8055v1
<b>FCC ID</b>	K7SF5D8055A
<b>POWER SUPPLY</b>	5Vdc from host equipment
<b>MODULATION TYPE</b>	CCK, DQPSK, DBPSK for DSSS 64QAM, 16QAM, QPSK, BPSK for OFDM
<b>MODULATION TECHNOLOGY</b>	DSSS, OFDM
<b>TRANSFER RATE</b>	802.11b: 11.0/ 5.5/ 2.0/ 1.0Mbps 802.11g: 54.0/ 48.0/ 36.0/ 24.0/ 18.0/ 12.0/ 9.0/ 6.0Mbps Draft 802.11n: up to 300.0Mbps
<b>FREQUENCY RANGE</b>	2400.0 ~ 2483.5MHz
<b>NUMBER OF CHANNEL</b>	11 for 802.11b, 802.11g, draft 802.11n (20MHz) 7 for draft 802.11n (40MHz)
<b>OUTPUT POWER</b>	50.234mW
<b>ANTENNA TYPE</b>	PIFA antenna with 2.0dBi gain
<b>DATA CABLE</b>	1.8m shielded USB cable without core for cradle
<b>I/O PORTS</b>	USB
<b>ACCESSORY DEVICES</b>	cradle

**NOTE:**

1. The EUT incorporates a MIMO function. Physically, the EUT provides two completed transmitters and two receivers.

MODULATION MODE	TX FUNCTION
802.11b	1TX
802.11g	1TX
Draft 802.11n (20MHz)	2TX
Draft 802.11n (40MHz)	2TX

2. The above EUT information was declared by manufacturer and for more detailed features description, please refer to the manufacturer's specifications or user's manual.

### 3.2 DESCRIPTION OF TEST MODES

11 channels are provided for 802.11b, 802.11g and draft 802.11n (20MHz):

CHANNEL	FREQUENCY	CHANNEL	FREQUENCY
1	2412MHz	7	2442MHz
2	2417MHz	8	2447MHz
3	2422MHz	9	2452MHz
4	2427MHz	10	2457MHz
5	2432MHz	11	2462MHz
6	2437MHz		

7 channels are provided for draft 802.11n (40MHz):

CHANNEL	FREQUENCY	CHANNEL	FREQUENCY
1	2422MHz	5	2442MHz
2	2427MHz	6	2447MHz
3	2432MHz	7	2452MHz
4	2437MHz		

### 3.2.1 CONFIGURATION OF SYSTEM UNDER TEST

#### Test Mode A

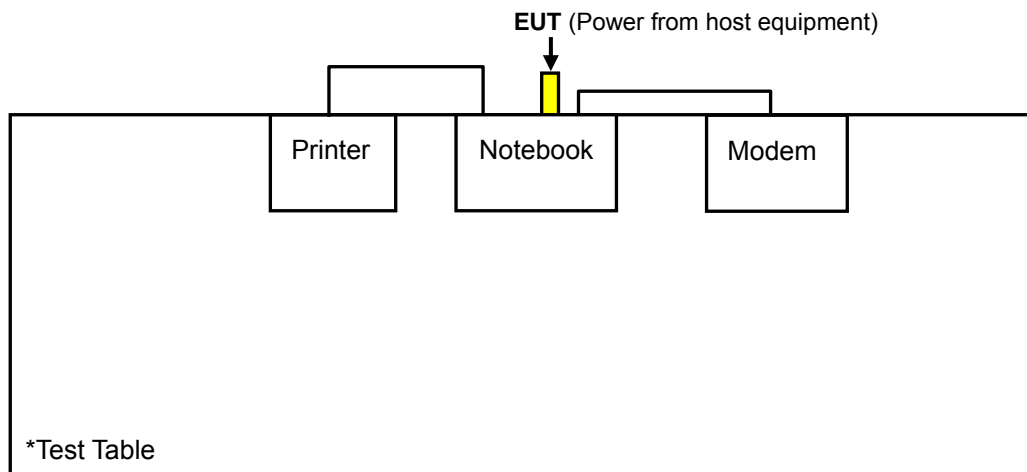

#### Test Mode B

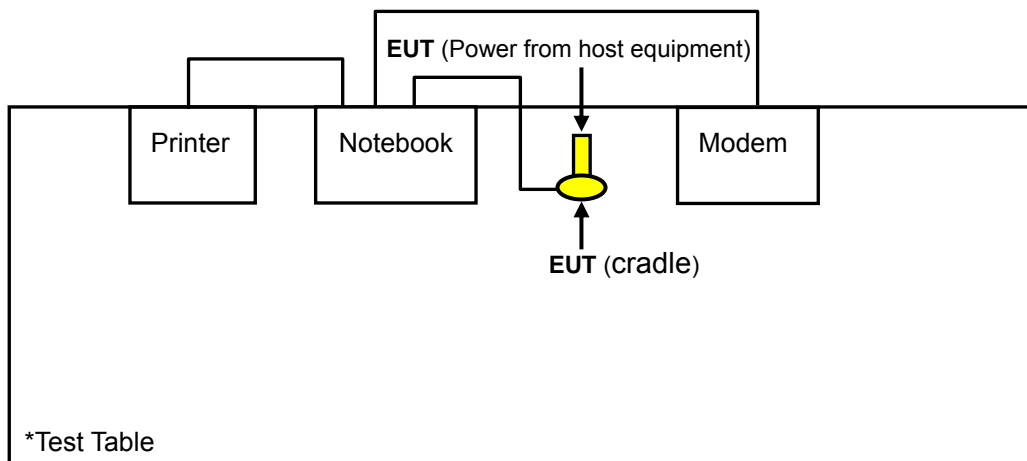



### 3.2.2 TEST MODE APPLICABILITY AND TESTED CHANNEL DETAIL

EUT CONFIGURE MODE	APPLICABLE TO				DESCRIPTION
	RE $\geq$ 1G	RE<1G	PLC	APCM	
A	√	-	-	√	Without cradle
B	-	√	√	-	With cradle

Where **RE $\geq$ 1G**: Radiated Emission above 1GHz      **RE<1G**: Radiated Emission below 1GHz  
**PLC**: Power Line Conducted Emission      **APCM**: Antenna Port Conducted Measurement  
**Note**: "-" means no effect.

#### **RADIATED EMISSION TEST (ABOVE 1GHz):**

- Pre-Scan has been conducted to determine the worst-case mode from all possible combinations between available modulations, data rates, XYZ Axis and antenna ports (if EUT with antenna diversity architecture).
- Following channel(s) was (were) selected for the final test as listed below.

EUT CONFIGURE MODE	MODE	AVAILABLE CHANNEL	TESTED CHANNEL	MODULATION TECHNOLOGY	MODULATION TYPE	DATA RATE (Mbps)	AXIS
A	802.11b	1 to 11	1, 6, 11	DSSS	DBPSK	1.0	X
	802.11g	1 to 11	1, 6, 11	OFDM	BPSK	6.0	
	Draft 802.11n (20MHz)	1 to 11	1, 6, 11	OFDM	BPSK	7.2	
	Draft 802.11n (40MHz)	1 to 7	1, 4, 7	OFDM	BPSK	15.0	

#### **RADIATED EMISSION TEST (BELOW 1GHz):**

- Pre-Scan has been conducted to determine the worst-case mode from all possible combinations between available modulations, data rates, XYZ Axis and antenna ports (if EUT with antenna diversity architecture).
- Following channel(s) was (were) selected for the final test as listed below.

EUT CONFIGURE MODE	MODE	AVAILABLE CHANNEL	TESTED CHANNEL	MODULATION TECHNOLOGY	MODULATION TYPE	DATA RATE (Mbps)	AXIS
B	802.11b	1 to 11	1	DSSS	DBPSK	1.0	Z

**POWER LINE CONDUCTED EMISSION TEST:**

- Pre-Scan has been conducted to determine the worst-case mode from all possible combinations between available modulations, data rates and antenna ports (if EUT with antenna diversity architecture).
- Following channel(s) was (were) selected for the final test as listed below.

EUT CONFIGURE MODE	MODE	AVAILABLE CHANNEL	TESTED CHANNEL	MODULATION TECHNOLOGY	MODULATION TYPE	DATA RATE (Mbps)
B	802.11b	1 to 11	1	DSSS	DBPSK	1.0

**BANDEDGE MEASUREMENT:**

- Pre-Scan has been conducted to determine the worst-case mode from all possible combinations between available modulations, data rates, XYZ Axis and antenna ports (if EUT with antenna diversity architecture).
- Following channel(s) was (were) selected for the final test as listed below.

EUT CONFIGURE MODE	MODE	AVAILABLE CHANNEL	TESTED CHANNEL	MODULATION TECHNOLOGY	MODULATION TYPE	DATA RATE (Mbps)	AXIS
A	802.11b	1 to 11	1, 11	DSSS	DBPSK	1.0	X
	802.11g	1 to 11	1, 11	OFDM	BPSK	6.0	
	Draft 802.11n (20MHz)	1 to 11	1, 11	OFDM	BPSK	7.2	
	Draft 802.11n (40MHz)	1 to 7	1, 7	OFDM	BPSK	15.0	

**ANTENNA PORT CONDUCTED MEASUREMENT:**

- Pre-Scan has been conducted to determine the worst-case mode from all possible combinations between available modulations, data rates and antenna ports (if EUT with antenna diversity architecture).
- Following channel(s) was (were) selected for the final test as listed below.

EUT CONFIGURE MODE	MODE	AVAILABLE CHANNEL	TESTED CHANNEL	MODULATION TECHNOLOGY	MODULATION TYPE	DATA RATE (Mbps)
A	802.11b	1 to 11	1, 6, 11	DSSS	DBPSK	1.0
	802.11g	1 to 11	1, 6, 11	OFDM	BPSK	6.0
	Draft 802.11n (20MHz)	1 to 11	1, 6, 11	OFDM	BPSK	7.2
	Draft 802.11n (40MHz)	1 to 7	1, 4, 7	OFDM	BPSK	15.0



### **3.3 GENERAL DESCRIPTION OF APPLIED STANDARDS**

The EUT is a RF Product. According to the specifications of the manufacturer, it must comply with the requirements of the following standards:

**FCC Part 15, Subpart C (15.247)**

**ANSI C63.4-2003**

All test items have been performed and recorded as per the above standards.

**NOTE:** The EUT is also considered as a kind of computer peripheral, because the connection to computer is necessary for typical use. It has been verified to comply with the requirements of FCC Part 15, Subpart B, Class B (DoC). The test report has been issued separately.



### 3.4 DESCRIPTION OF SUPPORT UNITS

The EUT has been tested as an independent unit together with other necessary accessories or support units. The following support units or accessories were used to form a representative test configuration during the tests.

#### For test mode A

NO.	PRODUCT	BRAND	MODEL NO.	SERIAL NO.	FCC ID
1	NOTEBOOK COMPUTER	DELL	PP05L	12130898320	E2K24CLNS
2	MODEM	ACEEX	1414V/3	0401008260	IFAXDM1414
3	PRINTER	EPSON	LQ-300+	DCGY054146	FCC DoC Approved

NO.	SIGNAL CABLE DESCRIPTION OF THE ABOVE SUPPORT UNITS
1	NA
2	1.2m braid shielded wire, DB25 & DB9 connector, w/o core.
3	1.8m braid shielded wire, DB25 connector, w/o core.

**NOTE:** All power cords of the above support units are non shielded (1.8m).

#### For test mode B

NO.	PRODUCT	BRAND	MODEL NO.	SERIAL NO.	FCC ID
1	NOTEBOOK COMPUTER	DELL	PP05L	16484462992	E2K24CLNS
2	PRINTER	EPSON	LQ-300+	DCGY017096	FCC DoC Approved
3	MODEM	ACEEX	1414	980020503	IFAXDM1414

NO.	SIGNAL CABLE DESCRIPTION OF THE ABOVE SUPPORT UNITS
1	NA
2	1.8m braid shielded wire, terminated with DB25 and Centronics connector via metallic frame, w/o core
3	1.2 m braid shielded wire, terminated with DB25 and DB9 connector via metallic frame, w/o core.

**NOTE:** All power cords of the above support units are non shielded (1.8m).

## 4. TEST TYPES AND RESULTS

### 4.1 RADIATED EMISSION MEASUREMENT

#### 4.1.1 LIMITS OF RADIATED EMISSION MEASUREMENT

Emissions radiated outside of the specified bands, shall be according to the general radiated limits in 15.209 as following:

FREQUENCIES (MHz)	FIELD STRENGTH (microvolts/meter)	MEASUREMENT DISTANCE (meters)
0.009 ~ 0.490	2400/F(kHz)	300
0.490 ~ 1.705	24000/F(kHz)	30
1.705 ~ 30.0	30	30
30 ~ 88	100	3
88 ~ 216	150	3
216 ~ 960	200	3
Above 960	500	3

**NOTE:**

1. The lower limit shall apply at the transition frequencies.
2. Emission level (dBuV/m) = 20 log Emission level (uV/m).
3. As shown in 15.35(b), for frequencies above 1000MHz, the field strength limits are based on average detector, however, the peak field strength of any emission shall not exceed the maximum permitted average limits, specified above by more than 20dB under any condition of modulation.



#### 4.1.2 TEST INSTRUMENTS

##### Test mode A

DESCRIPTION & MANUFACTURER	MODEL NO.	SERIAL NO.	CALIBRATED UNTIL
Test Receiver ROHDE & SCHWARZ	ESI7	838496/016	Dec. 25, 2008
Spectrum Analyzer ROHDE & SCHWARZ	FSP40	100039	Dec. 02, 2008
BILOG Antenna SCHWARZBECK	VULB9168	9168-155	Apr. 29, 2009
HORN Antenna SCHWARZBECK	BBHA 9120D	9120D-408	Jan. 21, 2009
HORN Antenna SCHWARZBECK	BBHA 9170	BBHA9170242	Jan. 06, 2009
Preamplifier Agilent	8449B	3008A01960	Oct. 30, 2008
Preamplifier Agilent	8447D	2944A10631	Oct. 31, 2008
RF signal cable HUBER+SUHNNER	SUCOFLEX 104	274397/4	Nov. 07, 2008
RF signal cable HUBER+SUHNNER	SUCOFLEX 104	283401/4	Nov. 07, 2008
Software ADT.	ADT_Radiated_V7.6	NA	NA
Antenna Tower inn-co GmbH	MA 4000	010303	NA
Antenna Tower Controller inn-co GmbH	CO2000	019303	NA
Turn Table ADT.	TT100.	TT93021704	NA
Turn Table Controller ADT.	SC100.	SC93021704	NA

- NOTE:**
1. The calibration interval of the above test instruments is 12 months and the calibrations are traceable to NML/ROC and NIST/USA.
  2. The test was performed in HwaYa Chamber 4.
  3. The horn antenna and HP preamplifier (model: 8449B) are used only for the measurement of emission frequency above 1GHz if tested.
  4. The FCC Site Registration No. is 460141.
  5. The IC Site Registration No. is IC3789B-4.



### Test mode B

DESCRIPTION & MANUFACTURER	MODEL NO.	SERIAL NO.	CALIBRATED UNTIL
ROHDE & SCHWARZ TEST RECEIVER	ESCI	100412	Jul. 21, 2009
SCHAFFENR BILOG Antenna	CBL6111D	21872	Apr. 28, 2009
ADT. Turn Table	TT100	0505	NA
ADT. Tower	AT100	0505	NA
Software	ADT_Radiate d_V7.6.15	NA	NA
ADT RF Switches BOX	EM-H-01-1	1002	Aug. 20, 2008
TIMES RF cable	LMR-600	CABLE-ST5-01	Aug. 20, 2008

- NOTE:**
1. The calibration interval of the above test instruments is 12 months. And the calibrations are traceable to NML/ROC and NIST/USA.
  2. The test was performed in ADT Open Site No. 5.
  3. The VCCI Site Registration No. R-1039.
  4. The Industry Canada Reference No. IC 3789A-5

#### 4.1.3 TEST PROCEDURES

- a. The EUT was placed on the top of a rotating table 0.8 meters above the ground at a 3 meters semi-anechoic chamber and 10 meters open area test site. The table was rotated 360 degrees to determine the position of the highest radiation.
- b. The EUT was set 3 meters away from the interference-receiving antenna, which was mounted on the top of a variable-height antenna tower.
- c. The antenna is a broadband antenna, and its height is varied from one meter to four meters above the ground to determine the maximum value of the field strength. Both horizontal and vertical polarizations of the antenna are set to make the measurement.
- d. For each suspected emission, the EUT was arranged to its worst case and then the antenna was tuned to heights from 1 meter to 4 meters and the rotatable table was turned from 0 degrees to 360 degrees to find the maximum reading.
- e. The test-receiver system was set to Peak Detect Function and Specified Bandwidth with Maximum Hold Mode.
- f. If the emission level of the EUT in peak mode was lower than the limit specified, then testing could be stopped and the peak values of the EUT would be reported. Otherwise the emissions would be re-tested one by one using peak, quasi-peak or average method as specified and then reported in a data sheet.

**NOTE:**

1. The resolution bandwidth and video bandwidth of test receiver/spectrum analyzer is 120kHz for Quasi-peak detection at frequency below 1GHz.
2. The resolution bandwidth of test receiver/spectrum analyzer is 1MHz and video bandwidth is 3MHz for Peak detection at frequency above 1GHz.
3. The resolution bandwidth of test receiver/spectrum analyzer is 1MHz and the video bandwidth is 10Hz for Average detection (AV) at frequency above 1GHz.
4. All modes of operation were investigated and the worst-case emissions are reported.

#### 4.1.4 DEVIATION FROM TEST STANDARD

No deviation.



#### 4.1.5 TEST SETUP

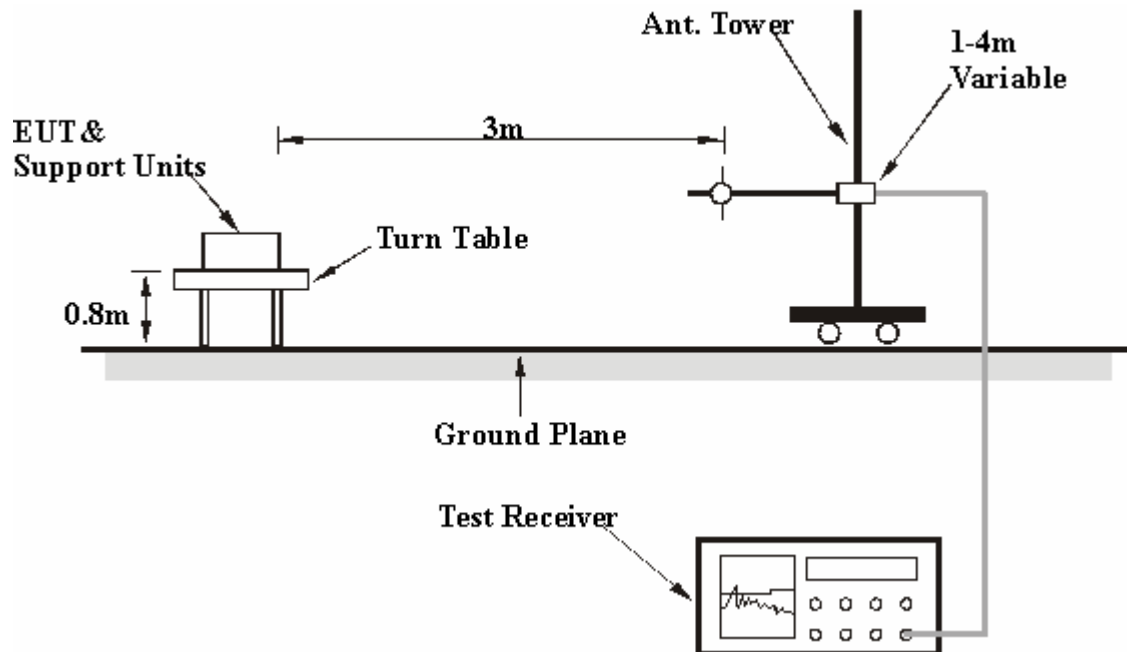

For the actual test configuration, please refer to the attached file (Test Setup Photo).

#### 4.1.6 EUT OPERATING CONDITIONS

- a. Connected the EUT to a notebook system and placed on a testing table.
- b. The notebook system ran a test program (provided by manufacturer) to enable EUT under transmission/receiving condition continuously at specific channel frequency.
- c. The necessary accessories enable the system in full functions.

#### 4.1.7 TEST RESULTS

##### 802.11b DSSS MODULATION

EUT TEST CONDITION		MEASUREMENT DETAIL	
CHANNEL	Channel 1	FREQUENCY RANGE	1 ~ 25GHz
INPUT POWER	120Vac, 60 Hz	DETECTOR FUNCTION	Peak (PK) Average (AV)
ENVIRONMENTAL CONDITIONS	20deg. C, 63%RH 1006hPa	TEST MODE	A
TESTED BY	Match Tsui		

ANTENNA POLARITY & TEST DISTANCE: HORIZONTAL AT 3 M								
NO.	FREQ. (MHz)	EMISSION LEVEL (dBuV/m)	LIMIT (dBuV/m)	MARGIN (dB)	ANTENNA HEIGHT (m)	TABLE ANGLE (Degree)	RAW VALUE (dBuV)	CORRECTION FACTOR (dB/m)
1	2386.00	60.92 PK	74.00	-13.08	1.40 H	252	29.55	31.37
2	2386.00	52.18 AV	54.00	-1.82	1.40 H	252	20.81	31.37
3	*2412.00	103.29 PK			1.40 H	250	71.83	31.46
4	*2412.00	98.72 AV			1.40 H	250	67.26	31.46
5	4824.00	54.21 PK	74.00	-19.79	1.16 H	135	16.55	37.66
6	4824.00	48.96 AV	54.00	-5.04	1.16 H	135	11.30	37.66
ANTENNA POLARITY & TEST DISTANCE: VERTICAL AT 3 M								
NO.	FREQ. (MHz)	EMISSION LEVEL (dBuV/m)	LIMIT (dBuV/m)	MARGIN (dB)	ANTENNA HEIGHT (m)	TABLE ANGLE (Degree)	RAW VALUE (dBuV)	CORRECTION FACTOR (dB/m)
1	2386.00	58.17 PK	74.00	-15.83	1.34 V	4	26.80	31.37
2	2386.00	47.45 AV	54.00	-6.55	1.34 V	4	16.08	31.37
3	*2412.00	99.24 PK			1.31 V	5	67.78	31.46
4	*2412.00	95.08 AV			1.31 V	5	63.62	31.46
5	4824.00	50.25 PK	74.00	-23.75	1.04 V	160	12.59	37.66
6	4824.00	42.59 AV	54.00	-11.41	1.04 V	160	4.93	37.66

- REMARKS:**
1. Emission level (dBuV/m) = Raw Value (dBuV) + Correction Factor (dB/m).
  2. Correction Factor (dB/m) = Antenna Factor (dB/m) + Cable Factor (dB).
  3. The other emission levels were very low against the limit.
  4. Margin value = Emission level – Limit value.
  5. “ \* “: Fundamental frequency.

EUT TEST CONDITION		MEASUREMENT DETAIL	
CHANNEL	Channel 6	FREQUENCY RANGE	1 ~ 25GHz
INPUT POWER	120Vac, 60 Hz	DETECTOR FUNCTION	Peak (PK) Average (AV)
ENVIRONMENTAL CONDITIONS	20deg. C, 63%RH 1006hPa	TEST MODE	A
TESTED BY	Match Tsui		

ANTENNA POLARITY & TEST DISTANCE: HORIZONTAL AT 3 M								
NO.	FREQ. (MHz)	EMISSION LEVEL (dBuV/m)	LIMIT (dBuV/m)	MARGIN (dB)	ANTENNA HEIGHT (m)	TABLE ANGLE (Degree)	RAW VALUE (dBuV)	CORRECTION FACTOR (dB/m)
1	*2437.00	105.10 PK			1.38 H	250	73.55	31.55
2	*2437.00	100.66 AV			1.38 H	250	69.11	31.55
3	4874.00	53.11 PK	74.00	-20.89	1.16 H	140	15.32	37.79
4	4874.00	47.67 AV	54.00	-6.33	1.16 H	140	9.88	37.79
ANTENNA POLARITY & TEST DISTANCE: VERTICAL AT 3 M								
NO.	FREQ. (MHz)	EMISSION LEVEL (dBuV/m)	LIMIT (dBuV/m)	MARGIN (dB)	ANTENNA HEIGHT (m)	TABLE ANGLE (Degree)	RAW VALUE (dBuV)	CORRECTION FACTOR (dB/m)
1	*2437.00	102.59 PK			1.00 V	285	71.04	31.55
2	*2437.00	98.43 AV			1.00 V	285	66.88	31.55
3	4874.00	51.57 PK	74.00	-22.43	1.03 V	281	13.78	37.79
4	4874.00	41.85 AV	54.00	-12.15	1.03 V	281	4.06	37.79

- REMARKS:**
1. Emission level (dBuV/m) = Raw Value (dBuV) + Correction Factor (dB/m).
  2. Correction Factor (dB/m) = Antenna Factor (dB/m) + Cable Factor (dB).
  3. The other emission levels were very low against the limit.
  4. Margin value = Emission level – Limit value.
  5. “ \* ”: Fundamental frequency.



EUT TEST CONDITION		MEASUREMENT DETAIL	
CHANNEL	Channel 11	FREQUENCY RANGE	1 ~ 25GHz
INPUT POWER	120Vac, 60 Hz	DETECTOR FUNCTION	Peak (PK) Average (AV)
ENVIRONMENTAL CONDITIONS	20deg. C, 63%RH 1006hPa	TEST MODE	A
TESTED BY	Match Tsui		

ANTENNA POLARITY & TEST DISTANCE: HORIZONTAL AT 3 M								
NO.	FREQ. (MHz)	EMISSION LEVEL (dBuV/m)	LIMIT (dBuV/m)	MARGIN (dB)	ANTENNA HEIGHT (m)	TABLE ANGLE (Degree)	RAW VALUE (dBuV)	CORRECTION FACTOR (dB/m)
1	*2462.00	103.91 PK			1.38 H	19	72.27	31.64
2	*2462.00	100.50 AV			1.38 H	19	68.86	31.64
3	2483.50	62.58 PK	74.00	-11.42	1.05 H	33	30.87	31.71
4	2483.50	51.82 AV	54.00	-2.18	1.05 H	33	20.11	31.71
5	4924.00	51.27 PK	74.00	-22.73	1.30 H	147	13.35	37.92
6	4924.00	45.74 AV	54.00	-8.26	1.30 H	147	7.82	37.92
ANTENNA POLARITY & TEST DISTANCE: VERTICAL AT 3 M								
NO.	FREQ. (MHz)	EMISSION LEVEL (dBuV/m)	LIMIT (dBuV/m)	MARGIN (dB)	ANTENNA HEIGHT (m)	TABLE ANGLE (Degree)	RAW VALUE (dBuV)	CORRECTION FACTOR (dB/m)
1	*2462.00	102.12 PK			1.00 V	285	70.48	31.64
2	*2462.00	98.30 AV			1.00 V	285	66.66	31.64
3	2483.50	59.10 PK	74.00	-14.90	1.00 V	285	27.39	31.71
4	2483.50	49.21 AV	54.00	-4.79	1.00 V	285	17.50	31.71
5	4924.00	50.25 PK	74.00	-23.75	1.40 V	333	12.33	37.92
6	4924.00	42.69 AV	54.00	-11.31	1.40 V	333	4.77	37.92

- REMARKS:**
1. Emission level (dBuV/m) = Raw Value (dBuV) + Correction Factor (dB/m).
  2. Correction Factor (dB/m) = Antenna Factor (dB/m) + Cable Factor (dB).
  3. The other emission levels were very low against the limit.
  4. Margin value = Emission level – Limit value.
  5. “ \* ”: Fundamental frequency.

### 802.11g OFDM MODULATION

EUT TEST CONDITION		MEASUREMENT DETAIL	
CHANNEL	Channel 1	FREQUENCY RANGE	1 ~ 25GHz
INPUT POWER	120Vac, 60 Hz	DETECTOR FUNCTION	Peak (PK) Average (AV)
ENVIRONMENTAL CONDITIONS	20deg. C, 63%RH 1006hPa	TEST MODE	A
TESTED BY	Match Tsui		

ANTENNA POLARITY & TEST DISTANCE: HORIZONTAL AT 3 M								
NO.	FREQ. (MHz)	EMISSION LEVEL (dBuV/m)	LIMIT (dBuV/m)	MARGIN (dB)	ANTENNA HEIGHT (m)	TABLE ANGLE (Degree)	RAW VALUE (dBuV)	CORRECTION FACTOR (dB/m)
1	2390.00	61.83 PK	74.00	-12.17	1.10 H	360	30.45	31.38
2	2390.00	46.89 AV	54.00	-7.11	1.10 H	360	15.51	31.38
3	*2412.00	100.10 PK			1.08 H	360	68.64	31.46
4	*2412.00	89.60 AV			1.08 H	360	58.14	31.46
5	4824.00	48.77 PK	74.00	-25.23	1.38 H	0	11.11	37.66
6	4824.00	35.87 AV	54.00	-18.13	1.38 H	0	-1.79	37.66
ANTENNA POLARITY & TEST DISTANCE: VERTICAL AT 3 M								
NO.	FREQ. (MHz)	EMISSION LEVEL (dBuV/m)	LIMIT (dBuV/m)	MARGIN (dB)	ANTENNA HEIGHT (m)	TABLE ANGLE (Degree)	RAW VALUE (dBuV)	CORRECTION FACTOR (dB/m)
1	2390.00	58.80 PK	74.00	-15.20	1.23 V	196	27.41	31.38
2	2390.00	45.52 AV	54.00	-8.48	1.23 V	196	14.13	31.38
3	*2412.00	97.50 PK			1.22 V	204	66.04	31.46
4	*2412.00	87.40 AV			1.22 V	204	55.94	31.46
5	4824.00	48.41 PK	74.00	-25.59	1.38 V	360	10.75	37.66
6	4824.00	35.69 AV	54.00	-18.31	1.38 V	360	-1.97	37.66

- REMARKS:**
1. Emission level (dBuV/m) = Raw Value (dBuV) + Correction Factor (dB/m).
  2. Correction Factor (dB/m) = Antenna Factor (dB/m) + Cable Factor (dB).
  3. The other emission levels were very low against the limit.
  4. Margin value = Emission level – Limit value.
  5. “ \* “: Fundamental frequency.



EUT TEST CONDITION		MEASUREMENT DETAIL	
CHANNEL	Channel 6	FREQUENCY RANGE	1 ~ 25GHz
INPUT POWER	120Vac, 60 Hz	DETECTOR FUNCTION	Peak (PK) Average (AV)
ENVIRONMENTAL CONDITIONS	20deg. C, 63%RH 1006hPa	TEST MODE	A
TESTED BY	Match Tsui		

ANTENNA POLARITY & TEST DISTANCE: HORIZONTAL AT 3 M								
NO.	FREQ. (MHz)	EMISSION LEVEL (dBuV/m)	LIMIT (dBuV/m)	MARGIN (dB)	ANTENNA HEIGHT (m)	TABLE ANGLE (Degree)	RAW VALUE (dBuV)	CORRECTION FACTOR (dB/m)
1	*2437.00	101.60 PK			1.09 H	37	70.05	31.55
2	*2437.00	91.59 AV			1.09 H	37	60.04	31.55
3	4874.00	48.72 PK	74.00	-25.28	1.09 H	360	10.93	37.79
4	4874.00	35.64 AV	54.00	-18.36	1.09 H	360	-2.15	37.79
ANTENNA POLARITY & TEST DISTANCE: VERTICAL AT 3 M								
NO.	FREQ. (MHz)	EMISSION LEVEL (dBuV/m)	LIMIT (dBuV/m)	MARGIN (dB)	ANTENNA HEIGHT (m)	TABLE ANGLE (Degree)	RAW VALUE (dBuV)	CORRECTION FACTOR (dB/m)
1	*2437.00	97.33 PK			1.31 V	34	65.78	31.55
2	*2437.00	87.09 AV			1.31 V	34	55.54	31.55
3	4874.00	48.78 PK	74.00	-25.22	1.10 V	360	10.99	37.79
4	4874.00	35.55 AV	54.00	-18.45	1.10 V	360	-2.24	37.79

- REMARKS:**
1. Emission level (dBuV/m) = Raw Value (dBuV) + Correction Factor (dB/m).
  2. Correction Factor (dB/m) = Antenna Factor (dB/m) + Cable Factor (dB).
  3. The other emission levels were very low against the limit.
  4. Margin value = Emission level – Limit value.
  5. “ \* “: Fundamental frequency.

EUT TEST CONDITION		MEASUREMENT DETAIL	
CHANNEL	Channel 11	FREQUENCY RANGE	1 ~ 25GHz
INPUT POWER	120Vac, 60 Hz	DETECTOR FUNCTION	Peak (PK) Average (AV)
ENVIRONMENTAL CONDITIONS	20deg. C, 63%RH 1006hPa	TEST MODE	A
TESTED BY	Match Tsui		

ANTENNA POLARITY & TEST DISTANCE: HORIZONTAL AT 3 M								
NO.	FREQ. (MHz)	EMISSION LEVEL (dBuV/m)	LIMIT (dBuV/m)	MARGIN (dB)	ANTENNA HEIGHT (m)	TABLE ANGLE (Degree)	RAW VALUE (dBuV)	CORRECTION FACTOR (dB/m)
1	*2462.00	100.52 PK			1.06 H	201	68.88	31.64
2	*2462.00	90.29 AV			1.06 H	201	58.65	31.64
3	2483.50	62.96 PK	74.00	-11.04	1.08 H	200	31.25	31.71
4	2483.50	46.71 AV	54.00	-7.29	1.08 H	200	15.00	31.71
5	4924.00	49.33 PK	74.00	-24.67	1.05 H	360	11.41	37.92
6	4924.00	36.48 AV	54.00	-17.52	1.05 H	360	-1.44	37.92
ANTENNA POLARITY & TEST DISTANCE: VERTICAL AT 3 M								
NO.	FREQ. (MHz)	EMISSION LEVEL (dBuV/m)	LIMIT (dBuV/m)	MARGIN (dB)	ANTENNA HEIGHT (m)	TABLE ANGLE (Degree)	RAW VALUE (dBuV)	CORRECTION FACTOR (dB/m)
1	*2462.00	98.53 PK			1.16 V	200	66.89	31.64
2	*2462.00	88.83 AV			1.16 V	200	57.19	31.64
3	2483.50	61.01 PK	74.00	-12.99	1.16 V	200	29.30	31.71
4	2483.50	46.41 AV	54.00	-7.59	1.16 V	200	14.70	31.71
5	4924.00	48.81 PK	74.00	-25.19	1.10 V	360	10.89	37.92
6	4924.00	35.66 AV	54.00	-18.34	1.10 V	360	-2.26	37.92

- REMARKS:**
1. Emission level (dBuV/m) = Raw Value (dBuV) + Correction Factor (dB/m).
  2. Correction Factor (dB/m) = Antenna Factor (dB/m) + Cable Factor (dB).
  3. The other emission levels were very low against the limit.
  4. Margin value = Emission level – Limit value.
  5. “ \* ”: Fundamental frequency.

### DRAFT 802.11n (20MHz) OFDM MODULATION

EUT TEST CONDITION		MEASUREMENT DETAIL	
CHANNEL	Channel 1	FREQUENCY RANGE	1 ~ 25GHz
INPUT POWER	120Vac, 60 Hz	DETECTOR FUNCTION	Peak (PK) Average (AV)
ENVIRONMENTAL CONDITIONS	20deg. C, 63%RH 1006hPa	TEST MODE	A
TESTED BY	Match Tsui		

ANTENNA POLARITY & TEST DISTANCE: HORIZONTAL AT 3 M								
NO.	FREQ. (MHz)	EMISSION LEVEL (dBuV/m)	LIMIT (dBuV/m)	MARGIN (dB)	ANTENNA HEIGHT (m)	TABLE ANGLE (Degree)	RAW VALUE (dBuV)	CORRECTION FACTOR (dB/m)
1	2390.00	55.83 PK	74.00	-18.17	1.06 H	360	24.44	31.38
2	2390.00	45.17 AV	54.00	-8.83	1.06 H	360	13.79	31.38
3	*2412.00	100.27 PK			1.06 H	360	68.81	31.46
4	*2412.00	89.78 AV			1.06 H	360	58.32	31.46
5	4824.00	48.95 PK	74.00	-25.05	1.00 H	360	11.29	37.66
6	4824.00	35.73 AV	54.00	-18.27	1.00 H	360	-1.93	37.66
ANTENNA POLARITY & TEST DISTANCE: VERTICAL AT 3 M								
NO.	FREQ. (MHz)	EMISSION LEVEL (dBuV/m)	LIMIT (dBuV/m)	MARGIN (dB)	ANTENNA HEIGHT (m)	TABLE ANGLE (Degree)	RAW VALUE (dBuV)	CORRECTION FACTOR (dB/m)
1	2390.00	56.94 PK	74.00	-17.06	1.20 V	213	25.56	31.38
2	2390.00	45.13 AV	54.00	-8.87	1.20 V	213	13.75	31.38
3	*2412.00	98.53 PK			1.20 V	202	67.07	31.46
4	*2412.00	87.71 AV			1.20 V	202	56.25	31.46
5	4824.00	48.65 PK	74.00	-25.35	1.10 V	360	10.99	37.66
6	4824.00	35.52 AV	54.00	-18.48	1.10 V	360	-2.14	37.66

- REMARKS:**
1. Emission level (dBuV/m) = Raw Value (dBuV) + Correction Factor (dB/m).
  2. Correction Factor (dB/m) = Antenna Factor (dB/m) + Cable Factor (dB).
  3. The other emission levels were very low against the limit.
  4. Margin value = Emission level – Limit value.
  5. “ \* “: Fundamental frequency.



EUT TEST CONDITION		MEASUREMENT DETAIL	
CHANNEL	Channel 6	FREQUENCY RANGE	1 ~ 25GHz
INPUT POWER	120Vac, 60 Hz	DETECTOR FUNCTION	Peak (PK) Average (AV)
ENVIRONMENTAL CONDITIONS	20deg. C, 63%RH 1006hPa	TEST MODE	A
TESTED BY	Match Tsui		

ANTENNA POLARITY & TEST DISTANCE: HORIZONTAL AT 3 M								
NO.	FREQ. (MHz)	EMISSION LEVEL (dBuV/m)	LIMIT (dBuV/m)	MARGIN (dB)	ANTENNA HEIGHT (m)	TABLE ANGLE (Degree)	RAW VALUE (dBuV)	CORRECTION FACTOR (dB/m)
1	*2437.00	100.70 PK			1.06 H	40	69.15	31.55
2	*2437.00	90.45 AV			1.06 H	40	58.90	31.55
3	4874.00	48.97 PK	74.00	-25.03	1.05 H	360	11.18	37.79
4	4874.00	36.05 AV	54.00	-17.95	1.05 H	360	-1.74	37.79
ANTENNA POLARITY & TEST DISTANCE: VERTICAL AT 3 M								
NO.	FREQ. (MHz)	EMISSION LEVEL (dBuV/m)	LIMIT (dBuV/m)	MARGIN (dB)	ANTENNA HEIGHT (m)	TABLE ANGLE (Degree)	RAW VALUE (dBuV)	CORRECTION FACTOR (dB/m)
1	*2437.00	99.01 PK			1.30 V	33	67.46	31.55
2	*2437.00	88.73 AV			1.30 V	33	57.18	31.55
3	4874.00	49.07 PK	74.00	-24.93	1.10 V	0	11.28	37.79
4	4874.00	36.13 AV	54.00	-17.87	1.10 V	0	-1.66	37.79

- REMARKS:**
1. Emission level (dBuV/m) = Raw Value (dBuV) + Correction Factor (dB/m).
  2. Correction Factor (dB/m) = Antenna Factor (dB/m) + Cable Factor (dB).
  3. The other emission levels were very low against the limit.
  4. Margin value = Emission level – Limit value.
  5. “ \* ”: Fundamental frequency.



EUT TEST CONDITION		MEASUREMENT DETAIL	
CHANNEL	Channel 11	FREQUENCY RANGE	1 ~ 25GHz
INPUT POWER	120Vac, 60 Hz	DETECTOR FUNCTION	Peak (PK) Average (AV)
ENVIRONMENTAL CONDITIONS	20deg. C, 63%RH 1006hPa	TEST MODE	A
TESTED BY	Match Tsui		

ANTENNA POLARITY & TEST DISTANCE: HORIZONTAL AT 3 M								
NO.	FREQ. (MHz)	EMISSION LEVEL (dBuV/m)	LIMIT (dBuV/m)	MARGIN (dB)	ANTENNA HEIGHT (m)	TABLE ANGLE (Degree)	RAW VALUE (dBuV)	CORRECTION FACTOR (dB/m)
1	*2462.00	100.74 PK			1.05 H	33	69.10	31.64
2	*2462.00	91.41 AV			1.05 H	33	59.77	31.64
3	2483.50	55.73 PK	74.00	-18.27	1.05 H	33	24.02	31.71
4	2483.50	46.48 AV	54.00	-7.52	1.05 H	33	14.77	31.71
5	4924.00	49.26 PK	74.00	-24.74	1.01 H	1	11.34	37.92
6	4924.00	36.21 AV	54.00	-17.79	1.01 H	1	-1.71	37.92
ANTENNA POLARITY & TEST DISTANCE: VERTICAL AT 3 M								
NO.	FREQ. (MHz)	EMISSION LEVEL (dBuV/m)	LIMIT (dBuV/m)	MARGIN (dB)	ANTENNA HEIGHT (m)	TABLE ANGLE (Degree)	RAW VALUE (dBuV)	CORRECTION FACTOR (dB/m)
1	*2462.00	98.92 PK			1.24 V	360	67.28	31.64
2	*2462.00	88.62 AV			1.24 V	360	56.98	31.64
3	2483.50	57.34 PK	74.00	-16.66	1.24 V	360	25.63	31.71
4	2483.50	46.10 AV	54.00	-7.90	1.24 V	360	14.39	31.71
5	4924.00	48.91 PK	74.00	-25.09	1.21 V	360	10.99	37.92
6	4924.00	36.21 AV	54.00	-17.79	1.21 V	360	-1.71	37.92

- REMARKS:**
1. Emission level (dBuV/m) = Raw Value (dBuV) + Correction Factor (dB/m).
  2. Correction Factor (dB/m) = Antenna Factor (dB/m) + Cable Factor (dB).
  3. The other emission levels were very low against the limit.
  4. Margin value = Emission level – Limit value.
  5. “ \* ”: Fundamental frequency.

### DRAFT 802.11n (40MHz) OFDM MODULATION

EUT TEST CONDITION		MEASUREMENT DETAIL	
CHANNEL	Channel 1	FREQUENCY RANGE	1 ~ 25GHz
INPUT POWER	120Vac, 60 Hz	DETECTOR FUNCTION	Peak (PK) Average (AV)
ENVIRONMENTAL CONDITIONS	20deg. C, 63%RH 1006hPa	TEST MODE	A
TESTED BY	Match Tsui		

ANTENNA POLARITY & TEST DISTANCE: HORIZONTAL AT 3 M								
NO.	FREQ. (MHz)	EMISSION LEVEL (dBuV/m)	LIMIT (dBuV/m)	MARGIN (dB)	ANTENNA HEIGHT (m)	TABLE ANGLE (Degree)	RAW VALUE (dBuV)	CORRECTION FACTOR (dB/m)
1	2390.00	57.00 PK	74.00	-17.00	1.09 H	38	25.62	31.38
2	2390.00	45.71 AV	54.00	-8.29	1.09 H	38	14.33	31.38
3	*2422.00	99.05 PK			1.09 H	38	67.55	31.50
4	*2422.00	89.04 AV			1.09 H	38	57.54	31.50
5	4844.00	49.28 PK	74.00	-24.72	1.00 H	360	11.57	37.71
6	4844.00	36.00 AV	54.00	-18.00	1.00 H	360	-1.71	37.71
ANTENNA POLARITY & TEST DISTANCE: VERTICAL AT 3 M								
NO.	FREQ. (MHz)	EMISSION LEVEL (dBuV/m)	LIMIT (dBuV/m)	MARGIN (dB)	ANTENNA HEIGHT (m)	TABLE ANGLE (Degree)	RAW VALUE (dBuV)	CORRECTION FACTOR (dB/m)
1	2390.00	55.80 PK	74.00	-18.20	1.28 V	359	24.41	31.38
2	2390.00	45.33 AV	54.00	-8.67	1.28 V	359	13.95	31.38
3	*2422.00	95.91 PK			1.28 V	359	64.41	31.50
4	*2422.00	86.42 AV			1.28 V	359	54.92	31.50
5	4844.00	48.09 PK	74.00	-25.91	1.10 V	360	10.38	37.71
6	4844.00	35.20 AV	54.00	-18.80	1.10 V	360	-2.51	37.71

- REMARKS:**
1. Emission level (dBuV/m) = Raw Value (dBuV) + Correction Factor (dB/m).
  2. Correction Factor (dB/m) = Antenna Factor (dB/m) + Cable Factor (dB).
  3. The other emission levels were very low against the limit.
  4. Margin value = Emission level – Limit value.
  5. “ \* “: Fundamental frequency.

EUT TEST CONDITION		MEASUREMENT DETAIL	
CHANNEL	Channel 4	FREQUENCY RANGE	1 ~ 25GHz
INPUT POWER	120Vac, 60 Hz	DETECTOR FUNCTION	Peak (PK) Average (AV)
ENVIRONMENTAL CONDITIONS	20deg. C, 63%RH 1006hPa	TEST MODE	A
TESTED BY	Match Tsui		

ANTENNA POLARITY & TEST DISTANCE: HORIZONTAL AT 3 M								
NO.	FREQ. (MHz)	EMISSION LEVEL (dBuV/m)	LIMIT (dBuV/m)	MARGIN (dB)	ANTENNA HEIGHT (m)	TABLE ANGLE (Degree)	RAW VALUE (dBuV)	CORRECTION FACTOR (dB/m)
1	2390.00	54.12 PK	74.00	-19.87	1.09 H	32	22.74	31.38
2	2390.00	45.38 AV	54.00	-8.62	1.09 H	32	14.00	31.38
3	*2437.00	99.02 PK			1.09 H	32	67.47	31.55
4	*2437.00	89.41 AV			1.09 H	32	57.86	31.55
5	2483.50	56.69 PK	74.00	-17.31	1.09 H	32	24.98	31.71
6	2483.50	46.60 AV	54.00	-7.40	1.09 H	32	14.89	31.71
7	4874.00	49.26 PK	74.00	-24.74	1.05 H	1	11.47	37.79
8	4874.00	35.80 AV	54.00	-18.20	1.05 H	1	-1.99	37.79
ANTENNA POLARITY & TEST DISTANCE: VERTICAL AT 3 M								
NO.	FREQ. (MHz)	EMISSION LEVEL (dBuV/m)	LIMIT (dBuV/m)	MARGIN (dB)	ANTENNA HEIGHT (m)	TABLE ANGLE (Degree)	RAW VALUE (dBuV)	CORRECTION FACTOR (dB/m)
1	2390.00	55.13 PK	74.00	-18.87	1.58 V	360	23.75	31.38
2	2390.00	45.11 AV	54.00	-8.89	1.58 V	360	13.73	31.38
3	*2437.00	96.04 PK			1.58 V	360	64.49	31.55
4	*2437.00	85.73 AV			1.58 V	360	54.18	31.55
5	2483.50	55.79 PK	74.00	-18.21	1.58 V	360	24.08	31.71
6	2483.50	45.78 AV	54.00	-8.22	1.58 V	360	14.07	31.71
7	4874.00	49.00 PK	74.00	-25.00	1.10 V	360	11.21	37.79
8	4874.00	36.07 AV	54.00	-17.93	1.10 V	360	-1.72	37.79

- REMARKS:**
1. Emission level (dBuV/m) = Raw Value (dBuV) + Correction Factor (dB/m).
  2. Correction Factor (dB/m) = Antenna Factor (dB/m) + Cable Factor (dB).
  3. The other emission levels were very low against the limit.
  4. Margin value = Emission level – Limit value.
  5. “ \* “: Fundamental frequency.

EUT TEST CONDITION		MEASUREMENT DETAIL	
CHANNEL	Channel 7	FREQUENCY RANGE	1 ~ 25GHz
INPUT POWER	120Vac, 60 Hz	DETECTOR FUNCTION	Peak (PK) Average (AV)
ENVIRONMENTAL CONDITIONS	20deg. C, 63%RH 1006hPa	TEST MODE	A
TESTED BY	Match Tsui		

ANTENNA POLARITY & TEST DISTANCE: HORIZONTAL AT 3 M								
NO.	FREQ. (MHz)	EMISSION LEVEL (dBuV/m)	LIMIT (dBuV/m)	MARGIN (dB)	ANTENNA HEIGHT (m)	TABLE ANGLE (Degree)	RAW VALUE (dBuV)	CORRECTION FACTOR (dB/m)
1	*2452.00	100.35 PK			1.07 H	32	68.75	31.60
2	*2452.00	89.79 AV			1.07 H	32	58.19	31.60
3	2483.50	57.90 PK	74.00	-16.10	1.04 H	33	26.19	31.71
4	2483.50	48.12 AV	54.00	-5.88	1.04 H	33	16.41	31.71
5	4904.00	49.04 PK	74.00	-24.96	1.01 H	1	11.17	37.87
6	4904.00	35.91 AV	54.00	-18.09	1.01 H	1	-1.96	37.87
ANTENNA POLARITY & TEST DISTANCE: VERTICAL AT 3 M								
NO.	FREQ. (MHz)	EMISSION LEVEL (dBuV/m)	LIMIT (dBuV/m)	MARGIN (dB)	ANTENNA HEIGHT (m)	TABLE ANGLE (Degree)	RAW VALUE (dBuV)	CORRECTION FACTOR (dB/m)
1	*2452.00	95.50 PK			1.03 V	35	63.90	31.60
2	*2452.00	85.47 AV			1.03 V	35	53.87	31.60
3	2483.50	58.75 PK	74.00	-15.25	1.03 V	35	27.04	31.71
4	2483.50	47.79 AV	54.00	-6.21	1.03 V	35	16.08	31.71
5	4904.00	48.06 PK	74.00	-25.94	1.01 V	360	10.19	37.87
6	4904.00	35.34 AV	54.00	-18.66	1.01 V	360	-2.53	37.87

- REMARKS:**
1. Emission level (dBuV/m) = Raw Value (dBuV) + Correction Factor (dB/m).
  2. Correction Factor (dB/m) = Antenna Factor (dB/m) + Cable Factor (dB).
  3. The other emission levels were very low against the limit.
  4. Margin value = Emission level – Limit value.
  5. “ \* “: Fundamental frequency.



**BELOW 1GHz WORST-CASE DATA : 802.11b DSSS MODULATION**

EUT TEST CONDITION		MEASUREMENT DETAIL	
CHANNEL	Channel 1	FREQUENCY RANGE	Below 1000MHz
INPUT POWER	120Vac, 60 Hz	DETECTOR FUNCTION	Quasi-Peak
ENVIRONMENTAL CONDITIONS	29deg. C, 58%RH 1006hPa	TEST MODE	B
TESTED BY	Rober Tsai		

ANTENNA POLARITY & TEST DISTANCE: HORIZONTAL AT 3 M								
NO.	FREQ. (MHz)	EMISSION LEVEL (dBuV/m)	LIMIT (dBuV/m)	MARGIN (dB)	ANTENNA HEIGHT (m)	TABLE ANGLE (Degree)	RAW VALUE (dBuV)	CORRECTION FACTOR (dB/m)
1	115.13	34.16 QP	43.50	-9.34	1.00 H	131	21.58	12.58
2	149.39	31.38 QP	43.50	-12.12	1.00 H	355	18.33	13.05
3	155.59	32.63 QP	43.50	-10.87	1.49 H	152	19.41	13.22
4	161.17	35.42 QP	43.50	-8.08	1.99 H	288	22.23	13.19
5	176.30	31.19 QP	43.50	-12.31	2.41 H	244	20.02	11.17
6	185.00	31.19 QP	43.50	-12.31	2.41 H	201	20.49	10.70
7	213.95	29.91 QP	43.50	-13.59	1.00 H	154	18.17	11.74
8	360.38	38.66 QP	46.00	-7.34	1.00 H	169	21.41	17.25
9	369.43	32.20 QP	46.00	-13.80	1.32 H	24	14.69	17.51
10	464.96	35.28 QP	46.00	-10.72	1.90 H	127	15.49	19.79
11	500.99	37.64 QP	46.00	-8.36	1.50 H	99	17.03	20.61
12	512.98	33.51 QP	46.00	-12.49	1.93 H	168	12.49	21.02
13	600.01	31.35 QP	46.00	-14.65	1.00 H	252	7.53	23.82
14	800.05	27.45 QP	46.00	-18.55	1.00 H	8	1.08	26.37

- REMARKS:**
1. Emission level (dBuV/m) = Raw Value (dBuV) + Correction Factor (dB/m).
  2. Correction Factor (dB/m) = Antenna Factor (dB/m) + Cable Factor (dB).
  3. The other emission levels were very low against the limit.
  4. Margin value = Emission level – Limit value.



EUT TEST CONDITION		MEASUREMENT DETAIL	
CHANNEL	Channel 1	FREQUENCY RANGE	Below 1000MHz
INPUT POWER	120Vac, 60 Hz	DETECTOR FUNCTION	Quasi-Peak
ENVIRONMENTAL CONDITIONS	29deg. C, 58%RH 1006hPa	TEST MODE	B
TESTED BY	Rober Tsai		

ANTENNA POLARITY & TEST DISTANCE: VERTICAL AT 3 M								
NO.	FREQ. (MHz)	EMISSION LEVEL (dBuV/m)	LIMIT (dBuV/m)	MARGIN (dB)	ANTENNA HEIGHT (m)	TABLE ANGLE (Degree)	RAW VALUE (dBuV)	CORRECTION FACTOR (dB/m)
1	74.89	32.53 QP	40.00	-7.47	1.53 V	86	24.25	8.28
2	111.61	39.42 QP	43.50	-4.08	1.00 V	262	27.24	12.18
3	120.16	33.46 QP	43.50	-10.04	1.00 V	199	20.32	13.14
4	130.25	37.70 QP	43.50	-5.80	2.10 V	149	24.54	13.16
5	151.95	37.87 QP	43.50	-5.63	1.00 V	179	24.77	13.10
6	180.88	30.23 QP	43.50	-13.27	1.00 V	217	19.45	10.78
7	360.36	41.78 QP	46.00	-4.22	1.72 V	232	24.53	17.25
8	375.02	30.56 QP	46.00	-15.44	1.00 V	0	12.89	17.67
9	500.95	34.56 QP	46.00	-11.44	1.41 V	123	13.95	20.61
10	600.26	32.95 QP	46.00	-13.05	1.57 V	323	9.13	23.82
11	633.01	36.54 QP	46.00	-9.46	1.00 V	252	12.41	24.13
12	800.06	30.07 QP	46.00	-15.93	1.68 V	163	3.70	26.37

- REMARKS:**
1. Emission level (dBuV/m) = Raw Value (dBuV) + Correction Factor (dB/m).
  2. Correction Factor (dB/m) = Antenna Factor (dB/m) + Cable Factor (dB).
  3. The other emission levels were very low against the limit.
  4. Margin value = Emission level – Limit value.

## 4.2 CONDUCTED EMISSION MEASUREMENT

### 4.2.1 LIMITS OF CONDUCTED EMISSION MEASUREMENT

FREQUENCY OF EMISSION (MHz)	CONDUCTED LIMIT (dB $\mu$ V)	
	Quasi-peak	Average
0.15 ~ 0.5	66 to 56	56 to 46
0.5 ~ 5	56	46
5 ~ 30	60	50

- NOTE:**
1. The lower limit shall apply at the transition frequencies.
  2. The limit decreases in line with the logarithm of the frequency in the range of 0.15 to 0.50MHz.
  3. All emanations from a class A/B digital device or system, including any network of conductors and apparatus connected thereto, shall not exceed the level of field strengths specified above.

### 4.2.2 TEST INSTRUMENTS

DESCRIPTION & MANUFACTURER	MODEL NO.	SERIAL NO.	CALIBRATED UNTIL
Test Receiver ROHDE & SCHWARZ	ESCS30	100288	Sep. 21, 2008
RF signal cable Woken	5D-FB	Cable-HYCO2-01	Jan. 03, 2009
LISN ROHDE & SCHWARZ	ESH2-Z5	100100	Jan. 06, 2009
LISN SCHWARZBECK	ESH3-Z5	100311	Jun. 30, 2009
Software ADT	ADT_Cond_V3	NA	NA

- NOTE:**
1. The calibration interval of the above test instruments is 12 months and the calibrations are traceable to NML/ROC and NIST/USA.
  2. The test was performed in HwaYa Shielded Room 2.
  3. The VCCI Site Registration No. is C-2047.



#### 4.2.3 TEST PROCEDURES

- a. The EUT was placed 0.4 meters from the conducting wall of the shielded room with EUT being connected to the power mains through a line impedance stabilization network (LISN). Other support units were connected to the power mains through another LISN. The two LISNs provide 50 ohm/ 50uH of coupling impedance for the measuring instrument.
- b. Both lines of the power mains connected to the EUT were checked for maximum conducted interference.
- c. The frequency range from 150kHz to 30MHz was searched. Emission levels under (Limit - 20dB) was not recorded.

**NOTE:** All modes of operation were investigated and the worst-case emissions are reported.

#### 4.2.4 DEVIATION FROM TEST STANDARD

No deviation.

#### 4.2.5 TEST SETUP

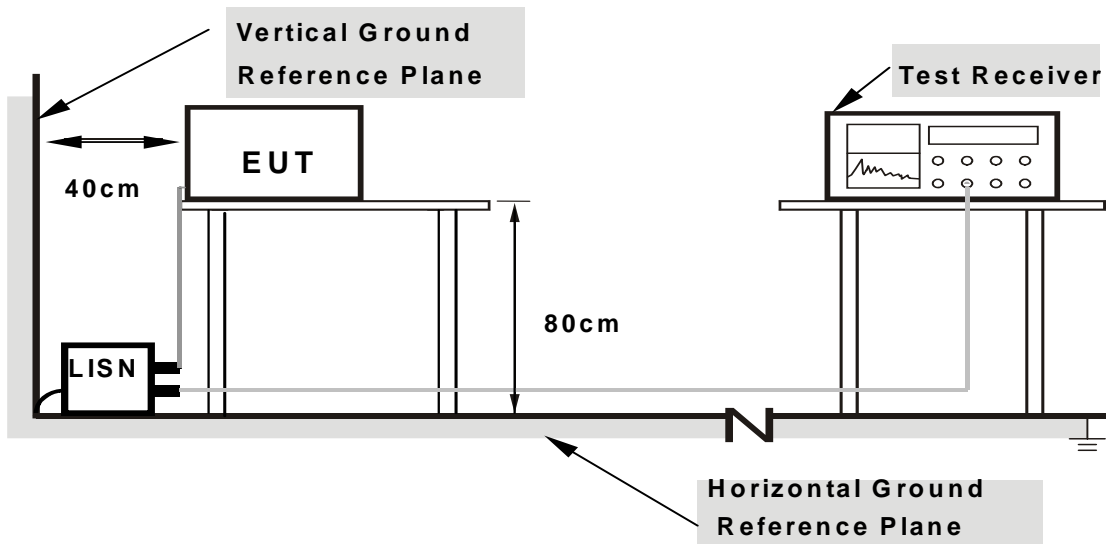

- Note:**
1. Support units were connected to second LISN.
  2. Both of LISNs (AMN) are 80 cm from EUT and at least 80 from other units and other metal planes

For the actual test configuration, please refer to the attached file (Test Setup Photo).

#### 4.2.6 EUT OPERATING CONDITIONS

Same as 4.1.6.

## 4.2.7 TEST RESULTS

### CONDUCTED WORST-CASE DATA : 802.11b DSSS MODULATION

EUT TEST CONDITION		MEASUREMENT DETAIL	
CHANNEL	Channel 1	PHASE	Line 1
MODULATION TYPE	DBPSK	INPUT POWER	120Vac, 60Hz
TRANSFER RATE	1.0Mbps	6dB BANDWIDTH	9kHz
ENVIRONMENTAL CONDITIONS	27deg. C, 66%RH, 1010hPa	TEST MODE	B
TESTED BY	Dean Wang		

No	Freq. [MHz]	Corr. Factor (dB)	Reading Value [dB (uV)]		Emission Level [dB (uV)]		Limit [dB (uV)]		Margin (dB)	
			Q.P.	AV.	Q.P.	AV.	Q.P.	AV.	Q.P.	AV.
1	0.166	0.14	39.40	-	39.54	-	65.18	55.18	-25.64	-
2	<b>0.220</b>	<b>0.14</b>	<b>41.75</b>	-	<b>41.89</b>	-	<b>62.81</b>	<b>52.81</b>	<b>-20.92</b>	-
3	0.342	0.15	35.00	-	35.15	-	59.15	49.15	-24.00	-
4	0.686	0.16	31.18	-	31.34	-	56.00	46.00	-24.66	-
5	4.020	0.43	23.88	-	24.31	-	56.00	46.00	-31.69	-
6	9.074	0.55	34.19	-	34.74	-	60.00	50.00	-25.26	-

- REMARKS:**
1. Q.P. and AV. are abbreviations of quasi-peak and average individually.
  2. "-": The Quasi-peak reading value also meets average limit and measurement with the average detector is unnecessary.
  3. The emission levels of other frequencies were very low against the limit.
  4. Margin value = Emission level - Limit value
  5. Correction factor = Insertion loss + Cable loss
  6. Emission Level = Correction Factor + Reading Value.

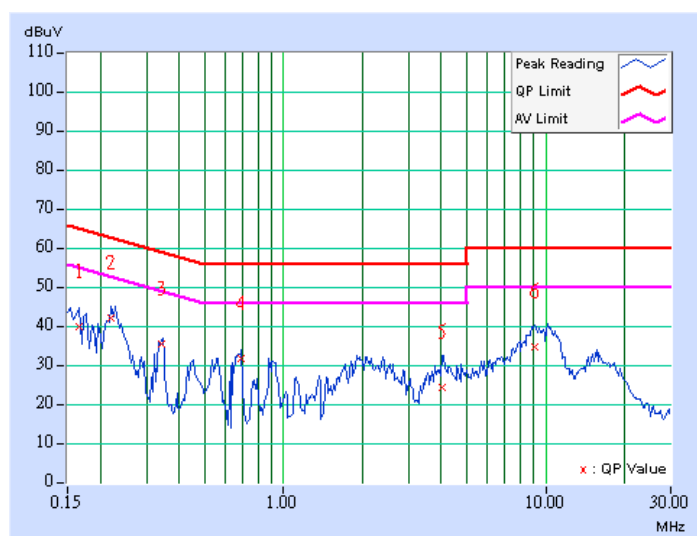

EUT TEST CONDITION		MEASUREMENT DETAIL	
CHANNEL	Channel 6	PHASE	Line 2
MODULATION TYPE	BPSK	INPUT POWER	120Vac, 60Hz
TRANSFER RATE	1.0Mbps	6dB BANDWIDTH	9kHz
ENVIRONMENTAL CONDITIONS	27deg. C, 66%RH, 1010hPa	TEST MODE	B
TESTED BY	Dean Wang		

No	Freq. [MHz]	Corr. Factor (dB)	Reading Value [dB (uV)]		Emission Level [dB (uV)]		Limit [dB (uV)]		Margin (dB)	
			Q.P.	AV.	Q.P.	AV.	Q.P.	AV.	Q.P.	AV.
1	0.158	0.13	39.41	-	39.54	-	65.58	55.58	-26.04	-
2	0.224	0.13	40.55	-	40.68	-	62.66	52.66	-21.98	-
3	0.341	0.14	34.98	-	35.12	-	59.17	49.17	-24.05	-
4	0.685	0.15	30.48	-	30.63	-	56.00	46.00	-25.37	-
5	2.160	0.27	28.00	-	28.27	-	56.00	46.00	-27.73	-
6	9.102	0.59	34.65	-	35.24	-	60.00	50.00	-24.76	-

- REMARKS:**
1. Q.P. and AV. are abbreviations of quasi-peak and average individually.
  2. "-": The Quasi-peak reading value also meets average limit and measurement with the average detector is unnecessary.
  3. The emission levels of other frequencies were very low against the limit.
  4. Margin value = Emission level - Limit value
  5. Correction factor = Insertion loss + Cable loss
  6. Emission Level = Correction Factor + Reading Value.

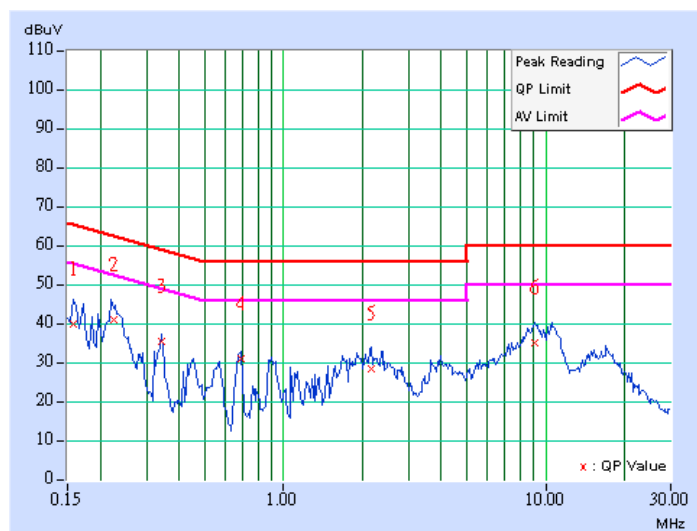



### 4.3 6dB BANDWIDTH MEASUREMENT

#### 4.3.1 LIMITS OF 6dB BANDWIDTH MEASUREMENT

The minimum of 6dB Bandwidth Measurement is 0.5 MHz.

#### 4.3.2 TEST INSTRUMENTS

DESCRIPTION & MANUFACTURER	MODEL NO.	SERIAL NO.	CALIBRATED UNTIL
R&S SPECTRUM ANALYZER	FSP40	100041	Apr. 21, 2009

**NOTE:** The calibration interval of the above test instruments is 12 months and the calibrations are traceable to NML/ROC and NIST/USA.

#### 4.3.3 TEST PROCEDURE

The transmitter output was connected to the spectrum analyzer through an attenuator. The bandwidth of the fundamental frequency was measured by spectrum analyzer with 100kHz RBW and 300kHz VBW. The 6dB bandwidth is defined as the total spectrum the power of which is higher than peak power minus 6dB.

#### 4.3.4 DEVIATION FROM TEST STANDARD

No deviation.

#### 4.3.5 TEST SETUP

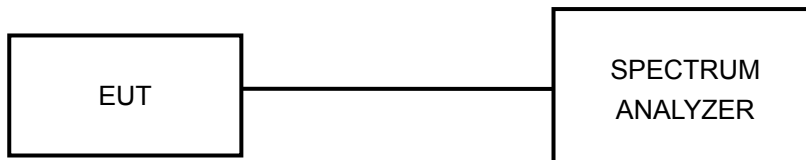

#### 4.3.6 EUT OPERATING CONDITIONS

The software provided by client to enable the EUT under transmission condition continuously at lowest, middle and highest channel frequencies individually.









### 802.11g OFDM MODULATION

<b>MODULATION TYPE</b>	BPSK	<b>TRANSFER RATE</b>	6.0Mbps
<b>INPUT POWER</b>	120Vac, 60Hz	<b>ENVIRONMENTAL CONDITIONS</b>	25 deg.C, 65 %RH, 1010hPa
<b>TESTED BY</b>	Brad Wu		

CHANNEL	CHANNEL FREQUENCY (MHz)	6dB BANDWIDTH (MHz)	MINIMUM LIMIT (MHz)	PASS / FAIL
1	2412	16.58	0.5	PASS
6	2437	16.59	0.5	PASS
11	2462	16.62	0.5	PASS

### CH 1

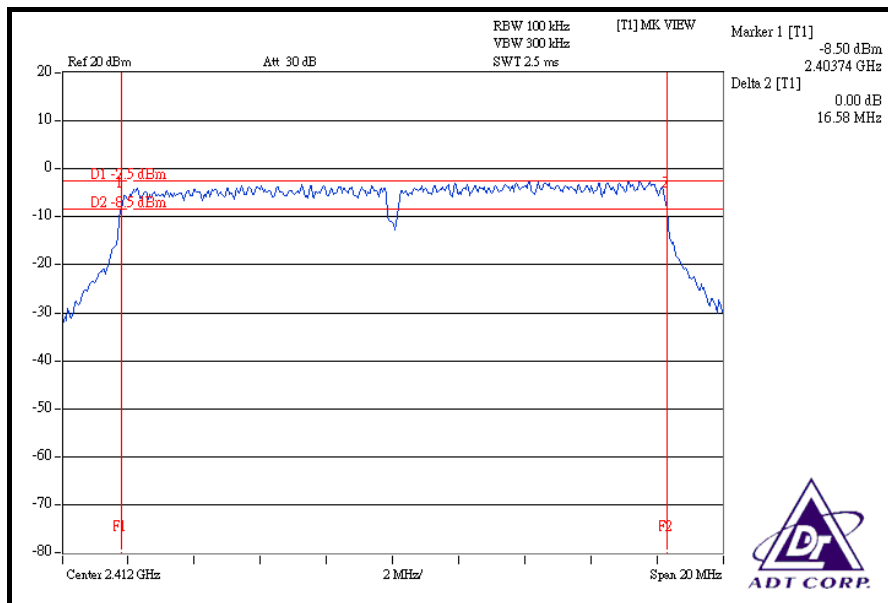





**DRAFT 802.11n (20MHz) OFDM MODULATION**

<b>MODULATION TYPE</b>	BPSK	<b>TRANSFER RATE</b>	7.2Mbps
<b>INPUT POWER</b>	120Vac, 60Hz	<b>ENVIRONMENTAL CONDITIONS</b>	25 deg.C, 65 %RH, 1010hPa
<b>TESTED BY</b>	Brad Wu		

CHANNEL	CHANNEL FREQUENCY (MHz)	6dB BANDWIDTH (MHz)		MINIMUM LIMIT (MHz)	PASS / FAIL
		CHAIN 0	CHAIN 1		
1	2412	17.69	17.72	0.5	PASS
6	2437	17.71	17.71	0.5	PASS
11	2462	17.71	17.73	0.5	PASS

**FOR CHAIN 0: CH 1**

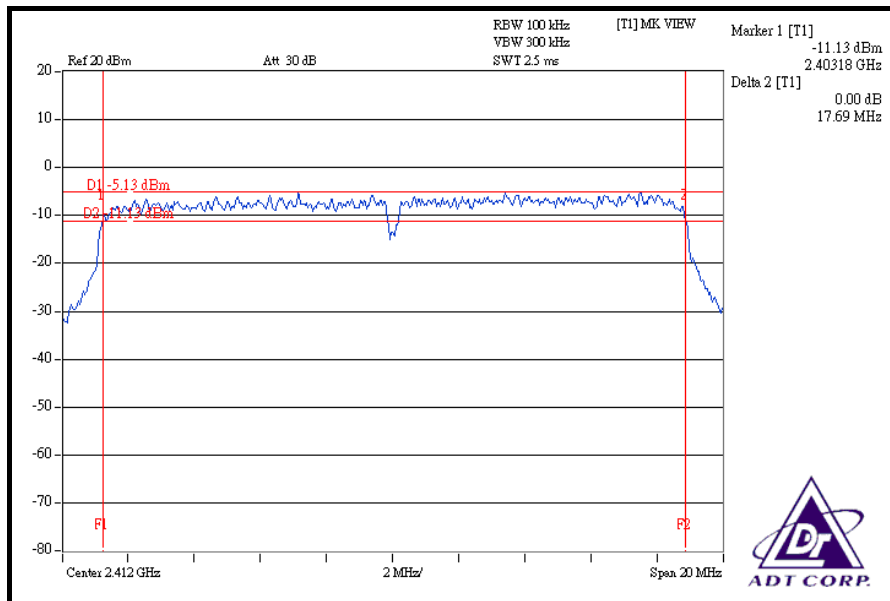

### CH 6

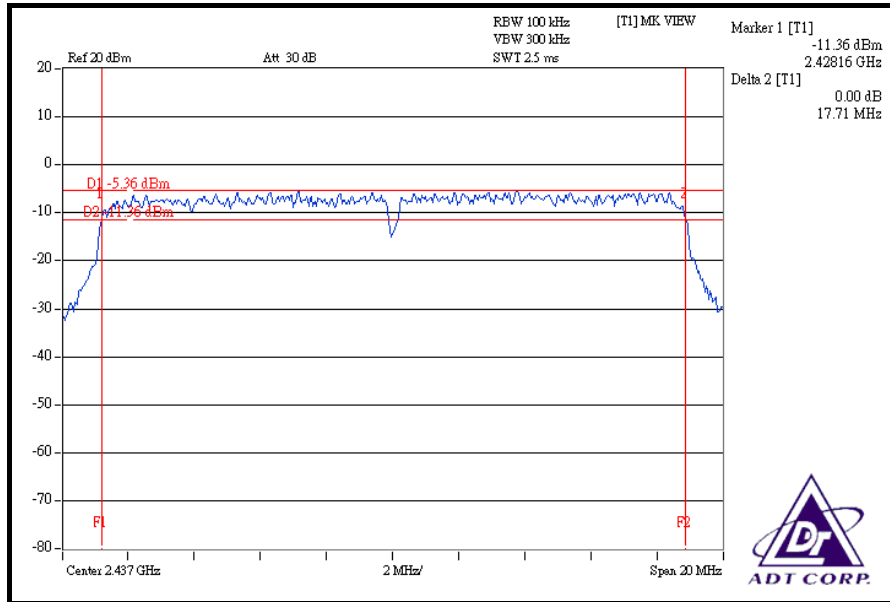

### CH 11

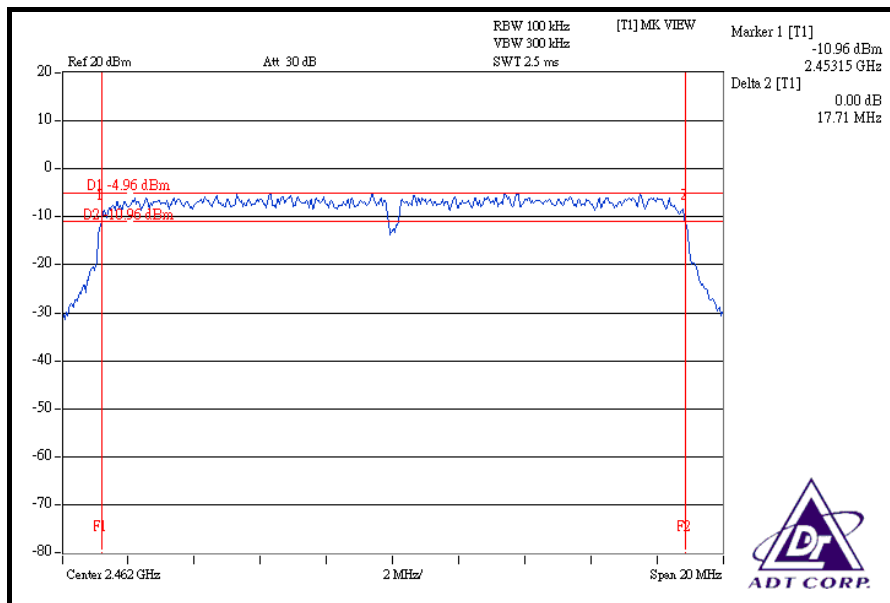







**DRAFT 802.11n (40MHz) OFDM MODULATION**

<b>MODULATION TYPE</b>	BPSK	<b>TRANSFER RATE</b>	15.0Mbps
<b>INPUT POWER</b>	120Vac, 60Hz	<b>ENVIRONMENTAL CONDITIONS</b>	25 deg.C, 65 %RH, 1010hPa
<b>TESTED BY</b>	Brad Wu		

CHANNEL	CHANNEL FREQUENCY (MHz)	6dB BANDWIDTH (MHz)		MINIMUM LIMIT (MHz)	PASS / FAIL
		CHAIN 0	CHAIN 1		
1	2422	36.20	36.49	0.5	PASS
4	2437	36.43	36.53	0.5	PASS
7	2452	36.51	36.53	0.5	PASS

**FOR CHAIN 0: CH 1**

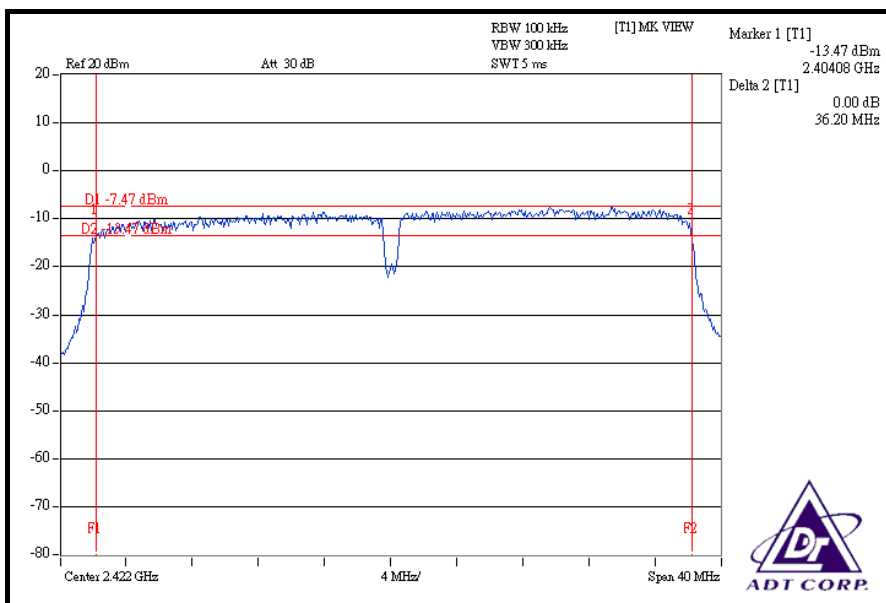

### CH 4

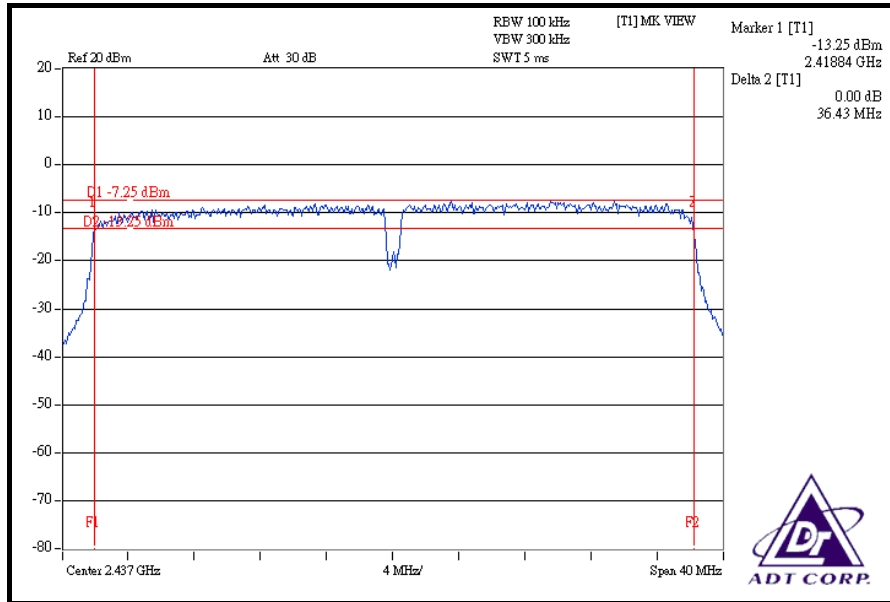

### CH 7

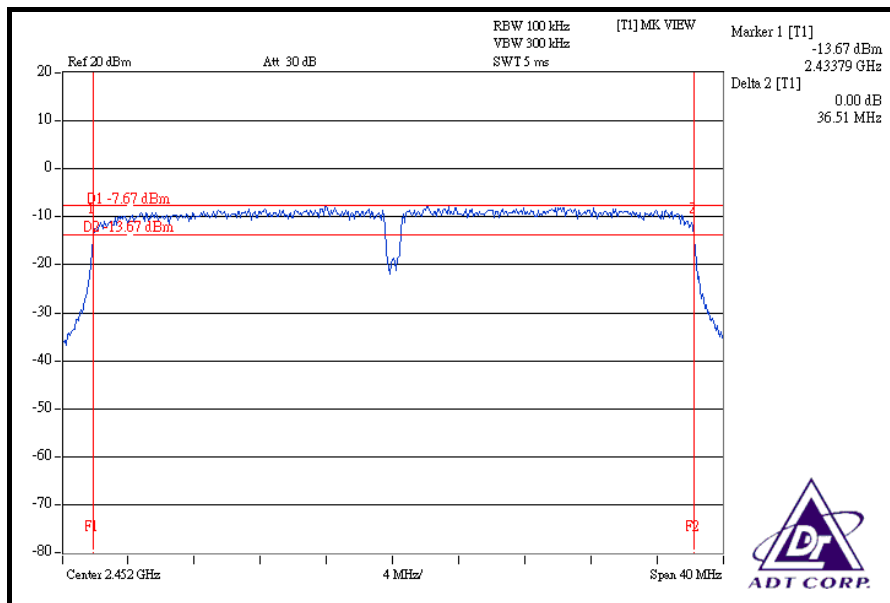



### FOR CHAIN 1: CH 1

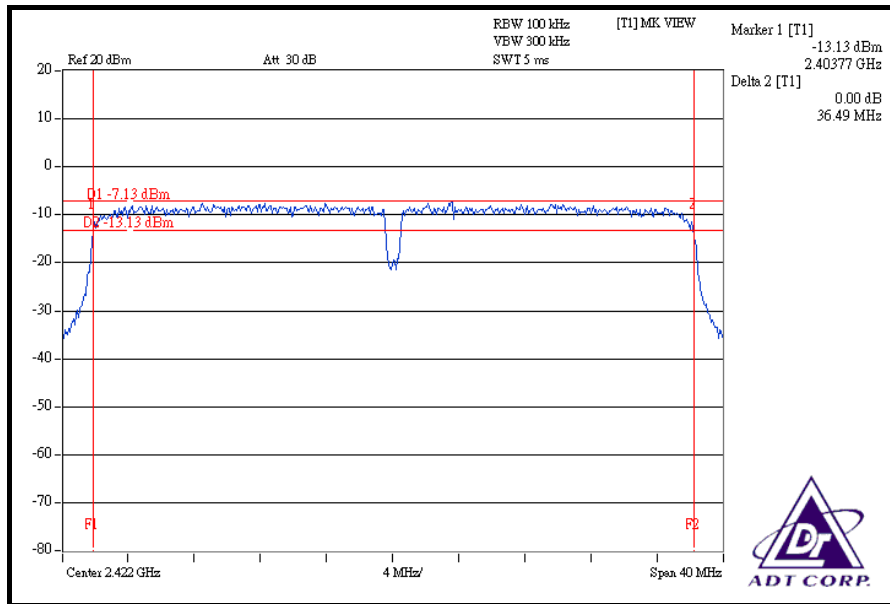

### CH 4

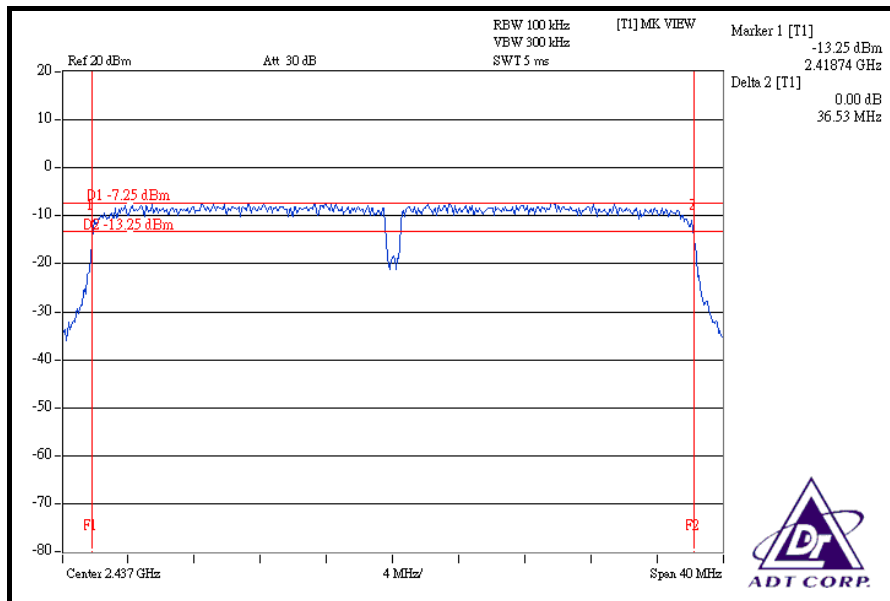





#### 4.4 MAXIMUM PEAK OUTPUT POWER

##### 4.4.1 LIMITS OF MAXIMUM PEAK OUTPUT POWER MEASUREMENT

The Maximum Peak Output Power Measurement is 30dBm.

##### 4.4.2 INSTRUMENTS

DESCRIPTION & MANUFACTURER	MODEL NO.	SERIAL NO.	CALIBRATED UNTIL
SPECTRUM ANALYZER	FSP40	100040	Apr. 21, 2009
AGILENT SYNTHESIZED SIGNAL GENERATOR	E8257C	MY43320668	Dec. 25, 2008
DIGITAL RT OSCILLOSCOPE	TDS1012	C037299	Nov. 21, 2008
NARDA DETECTOR	4503A	FSCM99899	NA

**NOTE:** The calibration interval of the above test instruments is 12 months and the calibrations are traceable to NML/ROC and NIST/USA.

##### 4.4.3 TEST PROCEDURES

- a. A detector was used on the output port of the EUT. An oscilloscope was used to read the response of the detector.
- b. Replaced the EUT by the signal generator. The center frequency of the S.G was adjusted to the center frequency of the measured channel.
- c. Adjusted the power to have the same reading on oscilloscope. Record the power level.

#### 4.4.4 DEVIATION FROM TEST STANDARD

No deviation.

#### 4.4.5 TEST SETUP



#### 4.4.6 EUT OPERATING CONDITIONS

Same as Item 4.3.6.



#### 4.4.7 TEST RESULTS

##### 802.11b DSSS MODULATION

<b>MODULATION TYPE</b>	DBPSK	<b>TRANSFER RATE</b>	1.0Mbps
<b>INPUT POWER</b>	120Vac, 60Hz	<b>ENVIRONMENTAL CONDITIONS</b>	25 deg.C, 65 %RH, 1010hPa
<b>TESTED BY</b>	Brad Wu		

CHANNEL	CHANNEL FREQUENCY (MHz)	PEAK POWER OUTPUT (mW)	PEAK POWER OUTPUT (dBm)	PEAK POWER LIMIT (dBm)	PASS / FAIL
1	2412	44.668	16.50	30	PASS
6	2437	50.119	17.00	30	PASS
11	2462	50.234	17.01	30	PASS

##### 802.11g OFDM MODULATION

<b>MODULATION TYPE</b>	BPSK	<b>TRANSFER RATE</b>	6.0Mbps
<b>INPUT POWER</b>	120Vac, 60Hz	<b>ENVIRONMENTAL CONDITIONS</b>	25 deg.C, 65 %RH, 1010hPa
<b>TESTED BY</b>	Brad Wu		

CHANNEL	CHANNEL FREQUENCY (MHz)	PEAK POWER OUTPUT (mW)	PEAK POWER OUTPUT (dBm)	PEAK POWER LIMIT (dBm)	PASS / FAIL
1	2412	40.272	16.05	30	PASS
6	2437	40.926	16.12	30	PASS
11	2462	40.272	16.05	30	PASS



**DRAFT 802.11n (20MHz) OFDM MODULATION**

<b>MODULATION TYPE</b>	BPSK	<b>TRANSFER RATE</b>	7.2Mbps
<b>INPUT POWER</b>	120Vac, 60Hz	<b>ENVIRONMENTAL CONDITIONS</b>	25 deg.C, 65 %RH, 1010hPa
<b>TESTED BY</b>	Brad Wu		

CHAN.	CHAN. FREQ. (MHz)	PEAK POWER OUTPUT (dBm)		TOTAL PEAK POWER (mW)	TOTAL PEAK POWER (dBm)	PEAK POWER LIMIT (dBm)	PASS / FAIL
		CHAIN 0	CHAIN 1				
1	2412	13.04	13.13	40.696	16.10	30	PASS
6	2437	13.04	13.13	40.696	16.10	30	PASS
11	2462	13.08	13.06	40.554	16.08	30	PASS

**DRAFT 802.11n (40MHz) OFDM MODULATION**

<b>MODULATION TYPE</b>	BPSK	<b>TRANSFER RATE</b>	15.0Mbps
<b>INPUT POWER</b>	120Vac, 60Hz	<b>ENVIRONMENTAL CONDITIONS</b>	25 deg.C, 65 %RH, 1010hPa
<b>TESTED BY</b>	Brad Wu		

CHAN.	CHAN. FREQ. (MHz)	PEAK POWER OUTPUT (dBm)		TOTAL PEAK POWER (mW)	TOTAL PEAK POWER (dBm)	PEAK POWER LIMIT (dBm)	PASS / FAIL
		CHAIN 0	CHAIN 1				
1	2422	13.09	13.13	40.929	16.12	30	PASS
4	2437	13.12	13.05	40.695	16.10	30	PASS
7	2452	13.00	13.09	40.323	16.06	30	PASS



## 4.5 POWER SPECTRAL DENSITY MEASUREMENT

### 4.5.1 LIMITS OF POWER SPECTRAL DENSITY MEASUREMENT

The Maximum of Power Spectral Density Measurement is 8dBm.

### 4.5.2 TEST INSTRUMENTS

DESCRIPTION & MANUFACTURER	MODEL NO.	SERIAL NO.	CALIBRATED UNTIL
R&S SPECTRUM ANALYZER	FSP40	100041	Apr. 21, 2009

**NOTE:** The calibration interval of the above test instruments is 12 months and the calibrations are traceable to NML/ROC and NIST/USA.

### 4.5.3 TEST PROCEDURE

The transmitter output was connected to the spectrum analyzer through an attenuator, the bandwidth of the fundamental frequency was measured with the spectrum analyzer using 3kHz RBW and 30kHz VBW, set sweep time = span/3kHz. The power spectral density was measured and recorded.

The sweep time is allowed to be longer than span/3kHz for a full response of the mixer in the spectrum analyzer.

#### 4.5.4 DEVIATION FROM TEST STANDARD

No deviation

#### 4.5.5 TEST SETUP

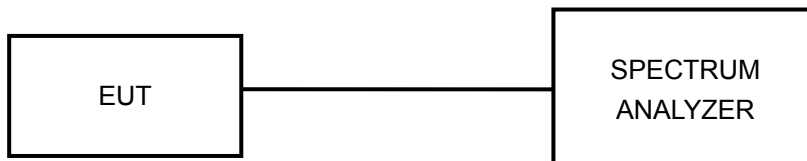

#### 4.5.6 EUT OPERATING CONDITION

Same as Item 4.3.6













**DRAFT 802.11n (20MHz) OFDM MODULATION**

<b>MODULATION TYPE</b>	BPSK	<b>TRANSFER RATE</b>	7.2Mbps
<b>INPUT POWER</b>	120Vac, 60Hz	<b>ENVIRONMENTAL CONDITIONS</b>	25 deg.C, 65 %RH, 1010hPa
<b>TESTED BY</b>	Brad Wu		

CHAN.	CHAN. FREQ. (MHz)	RF POWER LEVEL IN 3kHz BW (dBm)		TOTAL POWER DENSITY (mW)	TOTAL POWER DENSITY (dBm)	MAX. LIMIT (dBm)	PASS / FAIL
		CHAIN 0	CHAIN 1				
1	2412	-18.84	-18.07	0.029	-15.43	30	PASS
6	2437	-18.94	-18.31	0.028	-15.60	30	PASS
11	2462	-18.63	-18.14	0.029	-15.37	30	PASS

**FOR CHAIN 0: CH 1**

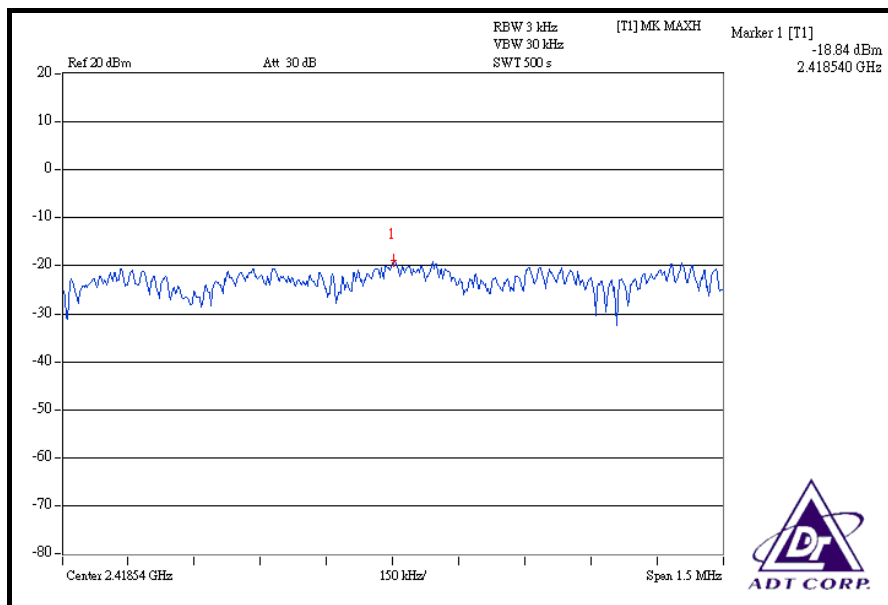





### CH 11

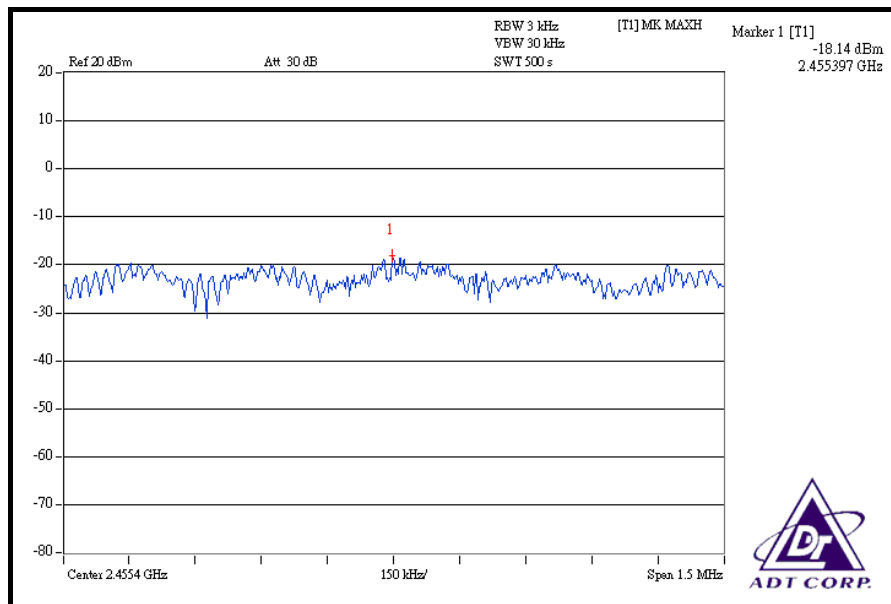





**DRAFT 802.11n (40MHz) OFDM MODULATION**

<b>MODULATION TYPE</b>	BPSK	<b>TRANSFER RATE</b>	15.0Mbps
<b>INPUT POWER</b>	120Vac, 60Hz	<b>ENVIRONMENTAL CONDITIONS</b>	25 deg.C, 65 %RH, 1010hPa
<b>TESTED BY</b>	Brad Wu		

CHAN.	CHAN. FREQ. (MHz)	RF POWER LEVEL IN 3kHz BW (dBm)		TOTAL POWER DENSITY (mW)	TOTAL POWER DENSITY (dBm)	MAX. LIMIT (dBm)	PASS / FAIL
		CHAIN 0	CHAIN 1				
1	2422	-19.41	-18.97	0.024	-16.17	30	PASS
4	2437	-19.58	-18.88	0.024	-16.21	30	PASS
7	2452	-19.42	-18.87	0.024	-16.13	30	PASS

**FOR CHAIN 0: CH 1**

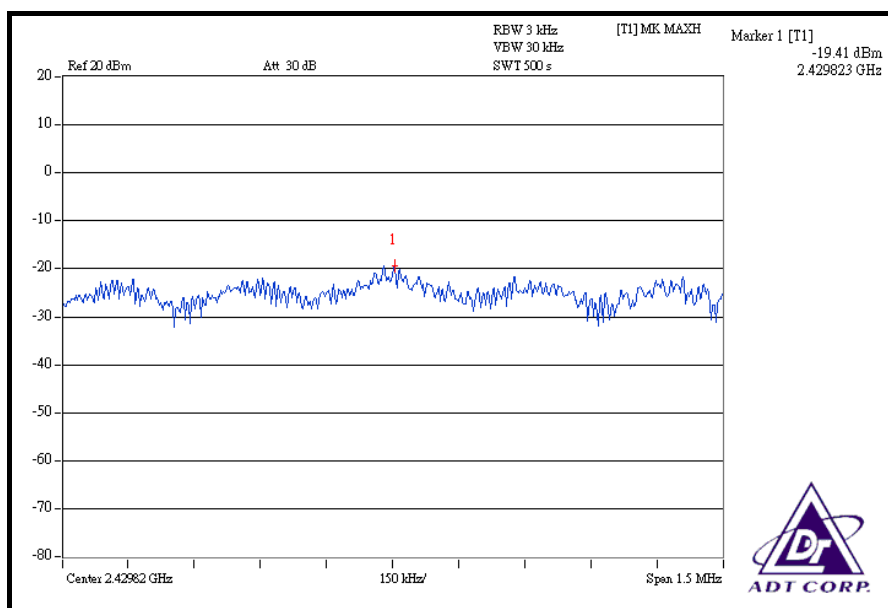

### CH 4

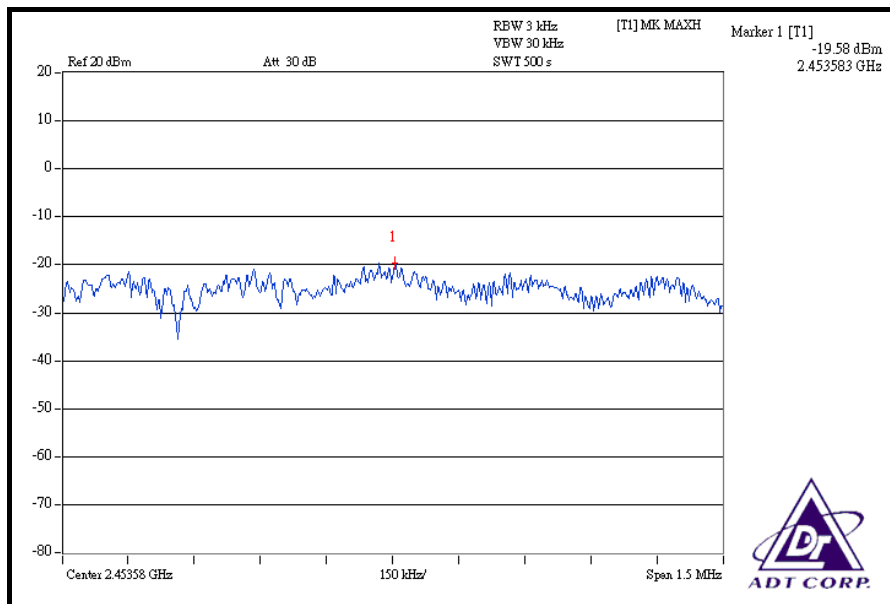

### CH 7

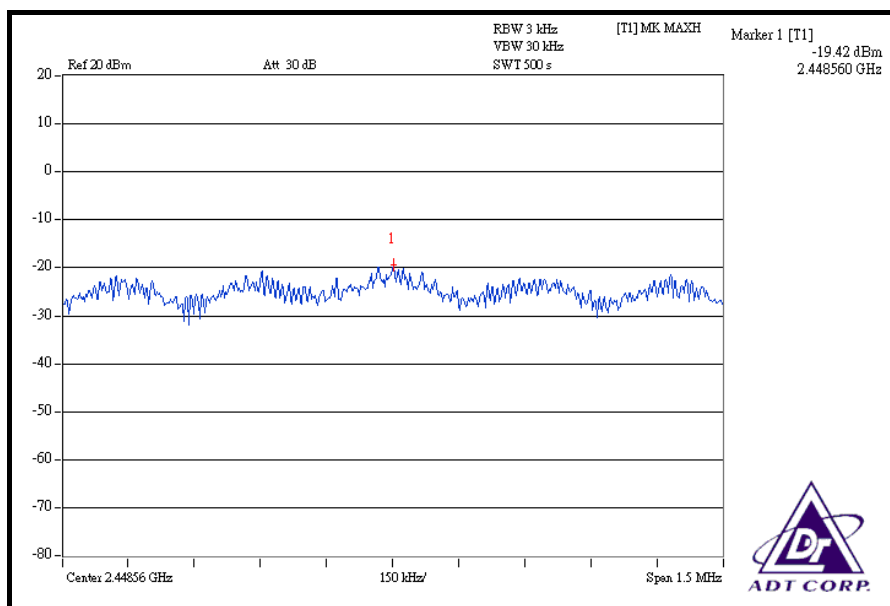



### CH 7

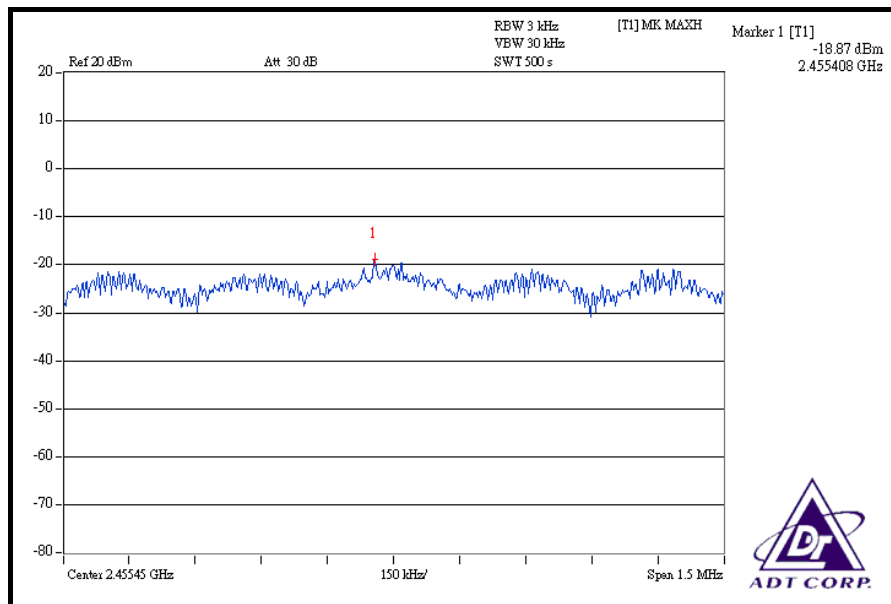



## 4.6 BAND EDGES MEASUREMENT

### 4.6.1 LIMITS OF BAND EDGES MEASUREMENT

Below -20dB of the highest emission level of operating band (in 100kHz Resolution Bandwidth).

### 4.6.2 TEST INSTRUMENTS

DESCRIPTION & MANUFACTURER	MODEL NO.	SERIAL NO.	CALIBRATED UNTIL
<b>FOR CONDUCTED MEASUREMENT:</b>			
R&S SPECTRUM ANALYZER	FSP40	100041	Apr. 21, 2009
<b>FOR RADIATED MEASUREMENT:</b>			
Spectrum Analyzer ROHDE & SCHWARZ	FSP40	100039	Dec. 02, 2008
HORN Antenna SCHWARZBECK	BBHA 9120D	9120D-408	Jan. 21, 2009
HORN Antenna SCHWARZBECK	BBHA 9170	BBHA9170242	Jan. 06, 2009
RF signal cable HUBER+SUHNNER	SUCOFLEX 104	274397/4	Nov. 07, 2008
RF signal cable HUBER+SUHNNER	SUCOFLEX 104	283401/4	Nov. 07, 2008
Software ADT.	ADT_Radiated_V7.6	NA	NA
Antenna Tower inn-co GmbH	MA 4000	010303	NA
Antenna Tower Controller inn-co GmbH	CO2000	019303	NA
Turn Table ADT.	TT100.	TT93021704	NA
Turn Table Controller ADT.	SC100.	SC93021704	NA

**NOTE:** The calibration interval of the above test instruments is 12 months and the calibrations are traceable to NML/ROC and NIST/USA.

### 4.6.3 TEST PROCEDURE

#### FOR CONDUCTED MEASUREMENT:

The transmitter output was connected to the spectrum analyzer via a low loss cable. Set both RBW and VBW of spectrum analyzer to 100kHz and 300kHz with suitable frequency span including 100MHz bandwidth from band edge. The band edges was measured and recorded.

The spectrum plots (Peak RBW = 100kHz, VBW = 300kHz) are attached on the following pages.

#### FOR RADIATED MEASUREMENT:

- a. The EUT was placed on the top of a rotating table 0.8 meters above the ground at a 3 meter semi-anechoic chamber. The table was rotated 360 degrees to determine the position of the highest radiation.
- b. The EUT was set 3 meters away from the interference-receiving antenna, which was mounted on the top of a variable-height antenna tower.
- c. The antenna is a broadband antenna, and its height is varied from one meter to four meters above the ground to determine the maximum value of the field strength. Both horizontal and vertical polarizations of the antenna are set to make the measurement.
- d. For each suspected emission, the EUT was arranged to its worst case and then the antenna was tuned to heights from 1 meter to 4 meters and the rotatable table was turned from 0 degrees to 360 degrees to find the maximum reading.
- e. Set both RBW and VBW of spectrum analyzer to 100kHz and 300kHz with suitable frequency span including 100MHz bandwidth from band edge. The band edges was measured and recorded.

The spectrum plots (Peak RBW = 100kHz, VBW = 300kHz) are attached on the following pages.

**NOTE:** The resolution bandwidth of test receiver/spectrum analyzer is 1MHz and the video bandwidth is 10Hz for Average detection (AV) at frequency above 1GHz.

#### 4.6.4 DEVIATION FROM TEST STANDARD

No deviation.

#### 4.6.5 EUT OPERATING CONDITION

Same as Item 4.3.6.

#### 4.6.6 TEST RESULTS

The spectrum plots are attached on the following pages. D1 line indicates the highest level, and D2 line indicates the 20dB offset below D1. It shows compliance with the requirement in part 15.247(d).

#### 802.11b DSSS MODULATION

**NOTE 1:** The band edge emission plot on the next page shows 51.29dBc between carrier maximum power and local maximum emission in restrict band (2.38980GHz). The emission of carrier strength list in the test result of channel 1 at the item 4.2.7 is 103.29dBuV/m (Peak), so the maximum field strength in restrict band is  $103.29 - 51.29 = 52.00$ dBuV/m which is under 74dBuV/m limit.

The band edge emission plot of on the next page shows 56.54dBc between carrier maximum power and local maximum emission in restrict band (2.38620GHz). The emission of carrier strength list in the test result of channel 1 at the item 4.2.7 is 98.72dBuV/m (Average), so the maximum field strength in restrict band is  $98.72 - 56.54 = 42.18$ dBuV/m which is under 54dBuV/m limit.

**NOTE 2:** The band edge emission plot on the next second page shows 51.10dBc between carrier maximum power and local maximum emission in restrict band (2.48520GHz). The emission of carrier strength list in the test result of channel 11 at the item 4.2.7 is 103.91dBuV/m (Peak), so the maximum field strength in restrict band is  $103.91 - 51.10 = 52.81$ dBuV/m which is under 74dBuV/m limit.

The band edge emission plot on the next third page shows 58.39dBc between carrier maximum power and local maximum emission in restrict band (2.48400GHz). The emission of carrier strength list in the test result of channel 11 at the item 4.2.7 is 100.50dBuV/m (Average), so the maximum field strength in restrict band is  $100.50 - 58.39 = 42.11$ dBuV/m which is under 54dBuV/m limit.



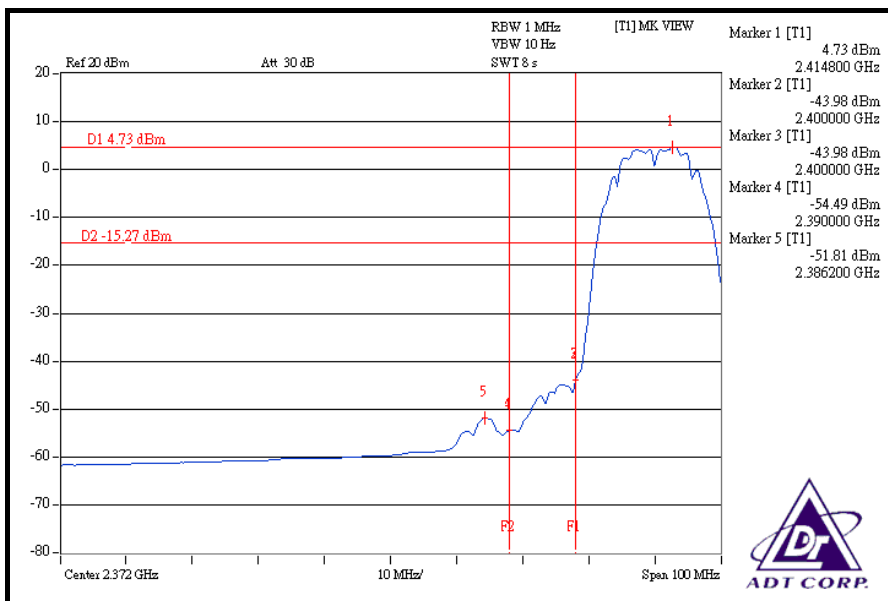
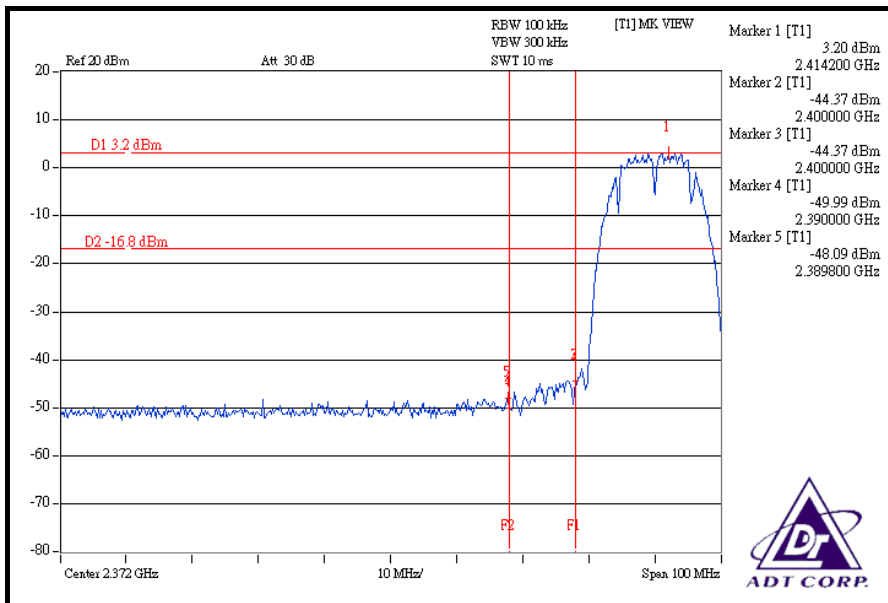

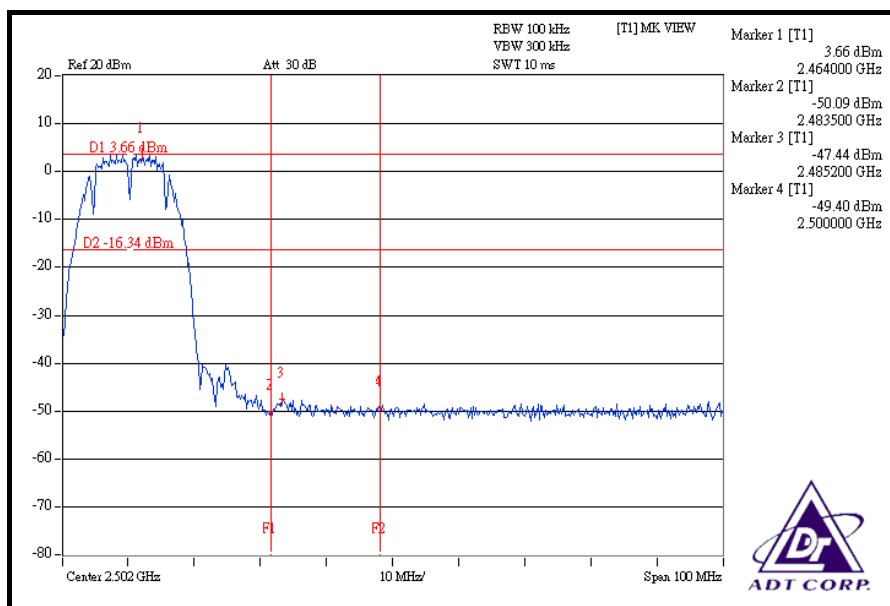
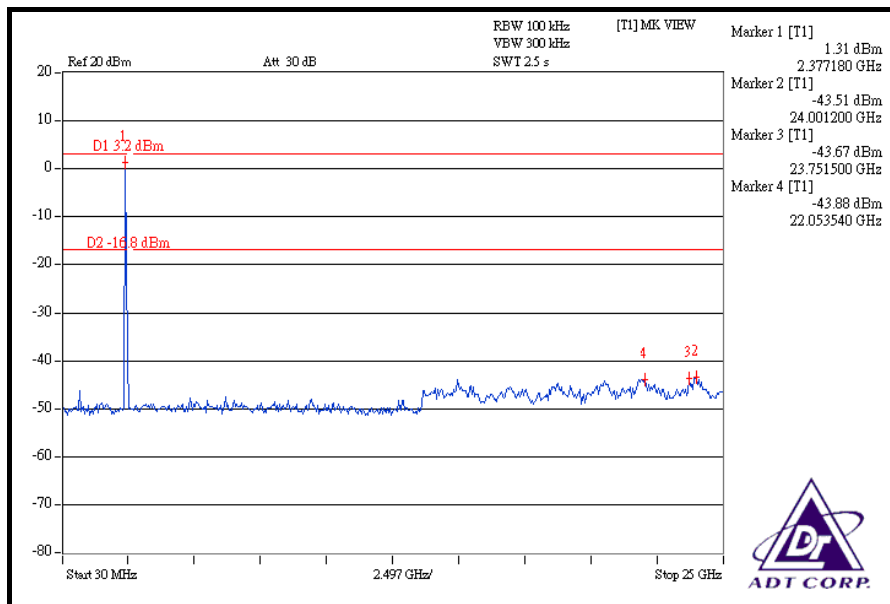

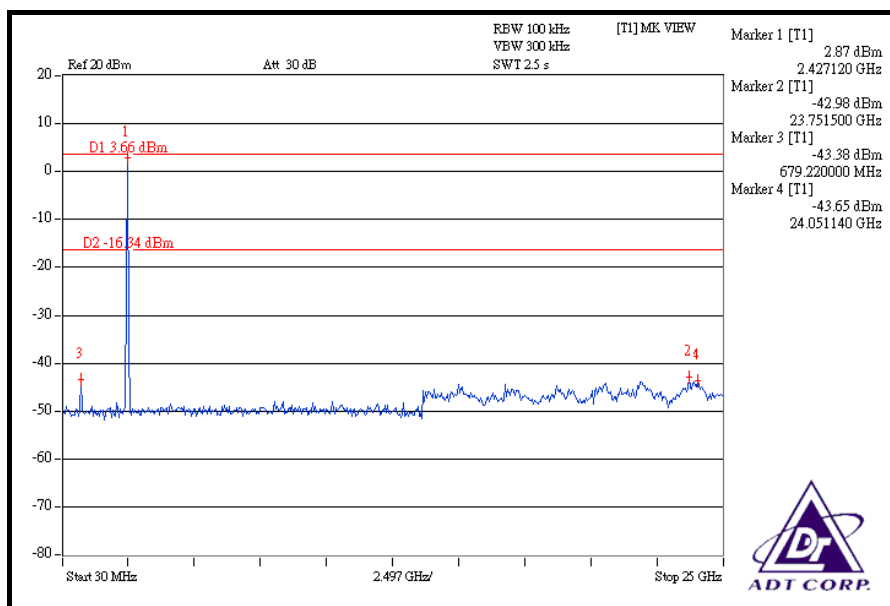
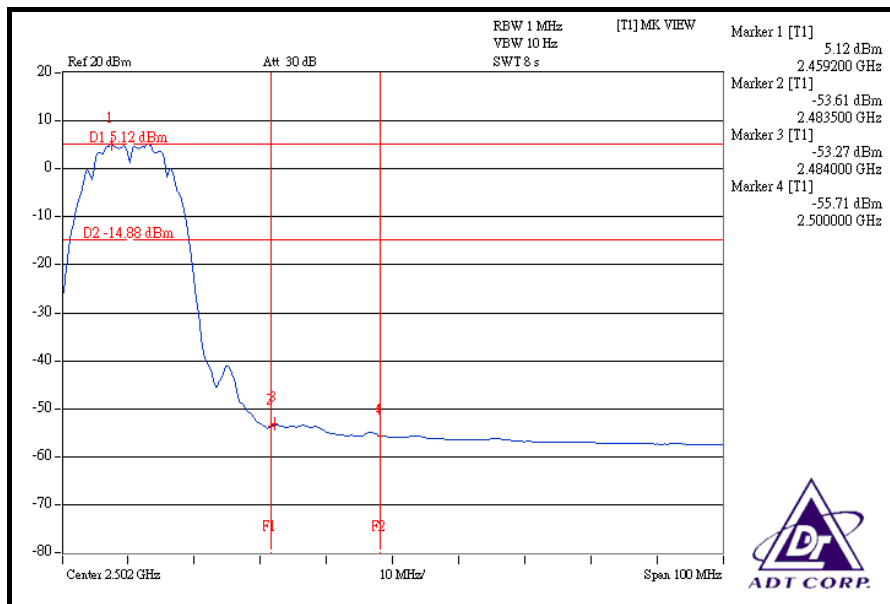

## 802.11g OFDM MODULATION

**NOTE 1:** The band edge emission plot on the next page shows 45.55dBc between carrier maximum power and local maximum emission in restrict band (2.38000GHz). The emission of carrier strength list in the test result of channel 1 at the item 4.2.7 is 100.10dBuV/m (Peak), so the maximum field strength in restrict band is  $100.10 - 45.55 = 54.55$ dBuV/m which is under 74dBuV/m limit.

The band edge emission plot of on the next page shows 52.68dBc between carrier maximum power and local maximum emission in restrict band (2.39000GHz). The emission of carrier strength list in the test result of channel 1 at the item 4.2.7 is 89.60dBuV/m (Average), so the maximum field strength in restrict band is  $89.60 - 52.68 = 36.92$ dBuV/m which is under 54dBuV/m limit.

**NOTE 2:** The band edge emission plot on the next second page shows 45.20dBc between carrier maximum power and local maximum emission in restrict band (2.49960GHz). The emission of carrier strength list in the test result of channel 11 at the item 4.2.7 is 100.52dBuV/m (Peak), so the maximum field strength in restrict band is  $100.52 - 45.20 = 55.32$ dBuV/m which is under 74dBuV/m limit.

The band edge emission plot on the next third page shows 52.04dBc between carrier maximum power and local maximum emission in restrict band (2.48350GHz). The emission of carrier strength list in the test result of channel 11 at the item 4.2.7 is 90.29dBuV/m (Average), so the maximum field strength in restrict band is  $90.29 - 52.04 = 38.25$ dBuV/m which is under 54dBuV/m limit.

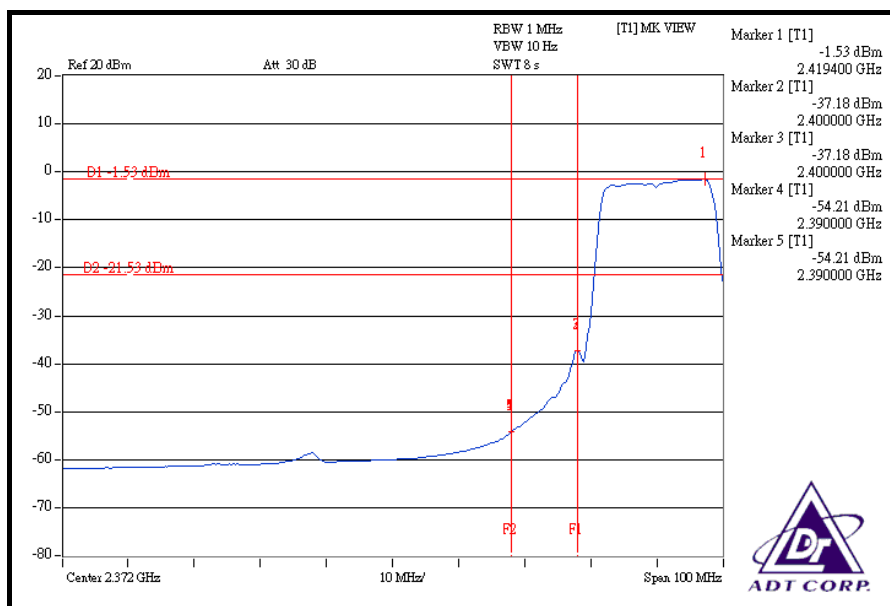
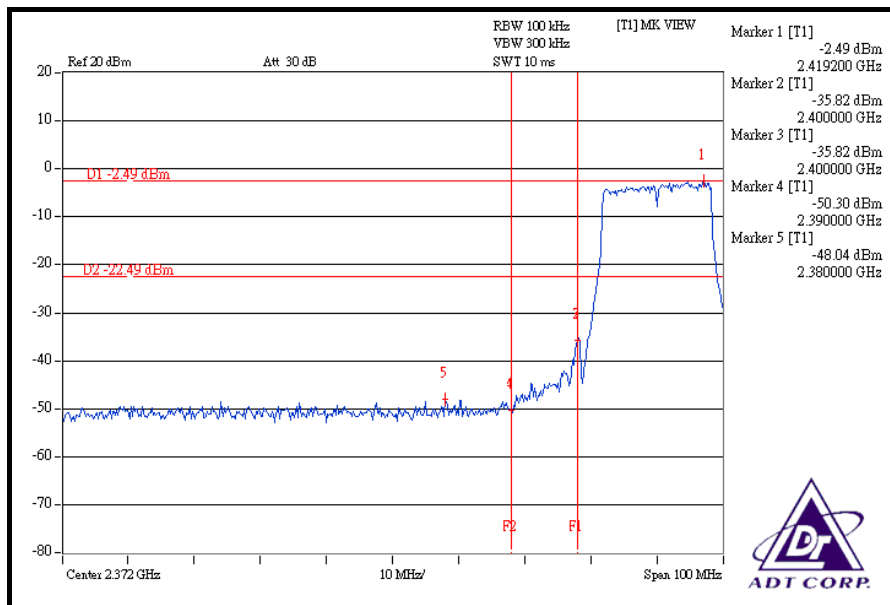

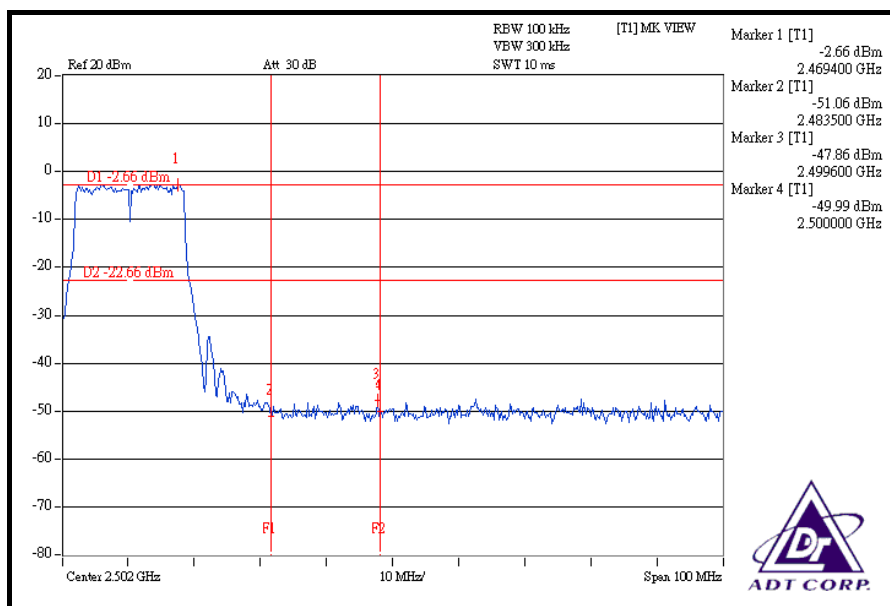
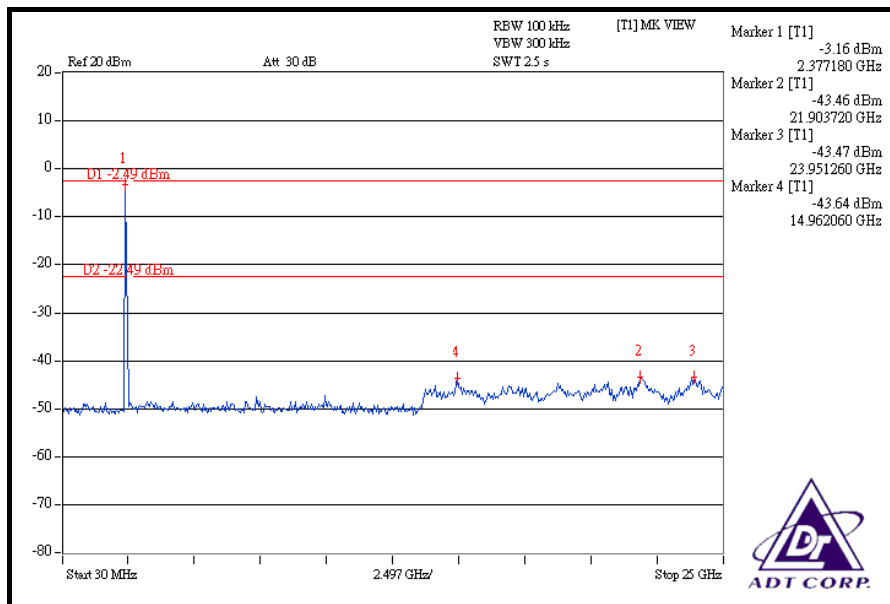

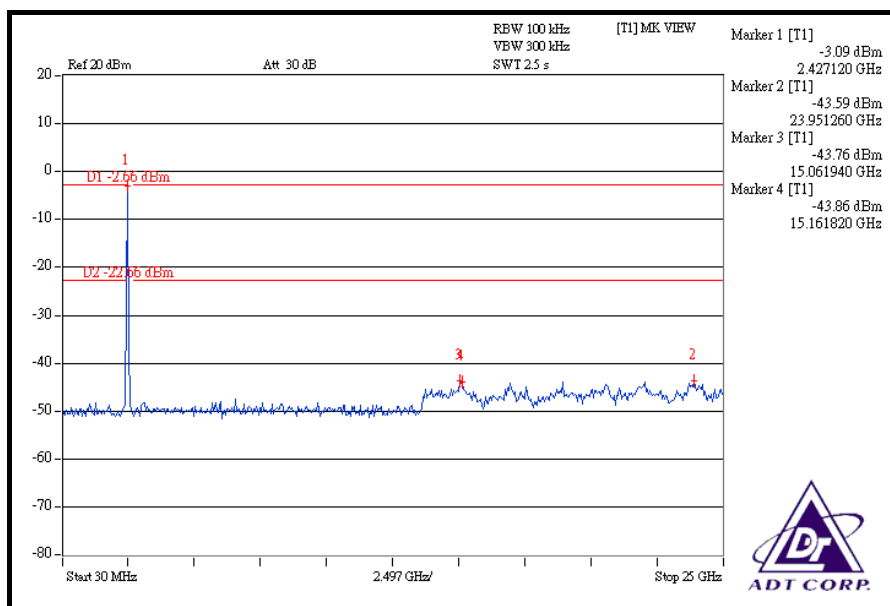
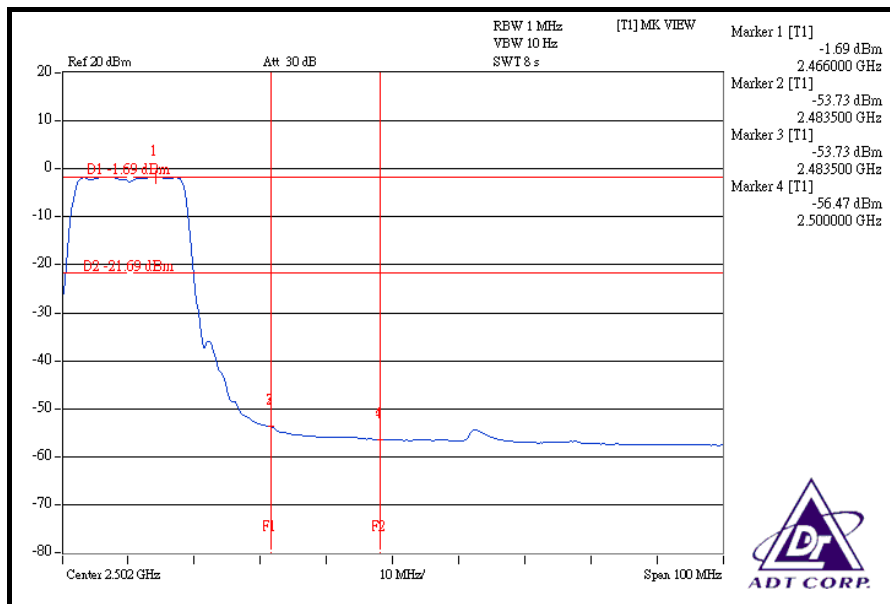

## DRAFT 802.11n (20MHz) OFDM MODULATION

**NOTE 1:** The band edge emission plot on the next page shows 40.40dBc between carrier maximum power and local maximum emission in restrict band (2.35900GHz). The emission of carrier strength list in the test result of channel 1 at the item 4.2.7 is 100.27dBuV/m (Peak), so the maximum field strength in restrict band is  $100.27 - 40.40 = 59.87$ dBuV/m which is under 74dBuV/m limit.

The band edge emission plot of on the next page shows 49.71dBc between carrier maximum power and local maximum emission in restrict band (2.39000GHz). The emission of carrier strength list in the test result of channel 1 at the item 4.2.7 is 89.78dBuV/m (Average), so the maximum field strength in restrict band is  $89.78 - 49.71 = 40.07$ dBuV/m which is under 54dBuV/m limit.

**NOTE 2:** The band edge emission plot on the next second page shows 40.11dBc between carrier maximum power and local maximum emission in restrict band (2.48580GHz). The emission of carrier strength list in the test result of channel 11 at the item 4.2.7 is 100.74dBuV/m (Peak), so the maximum field strength in restrict band is  $100.74 - 40.11 = 60.63$ dBuV/m which is under 74dBuV/m limit.

The band edge emission plot on the next third page shows 48.08dBc between carrier maximum power and local maximum emission in restrict band (2.48350GHz). The emission of carrier strength list in the test result of channel 11 at the item 4.2.7 is 91.41dBuV/m (Average), so the maximum field strength in restrict band is  $91.41 - 48.08 = 43.33$ dBuV/m which is under 54dBuV/m limit.



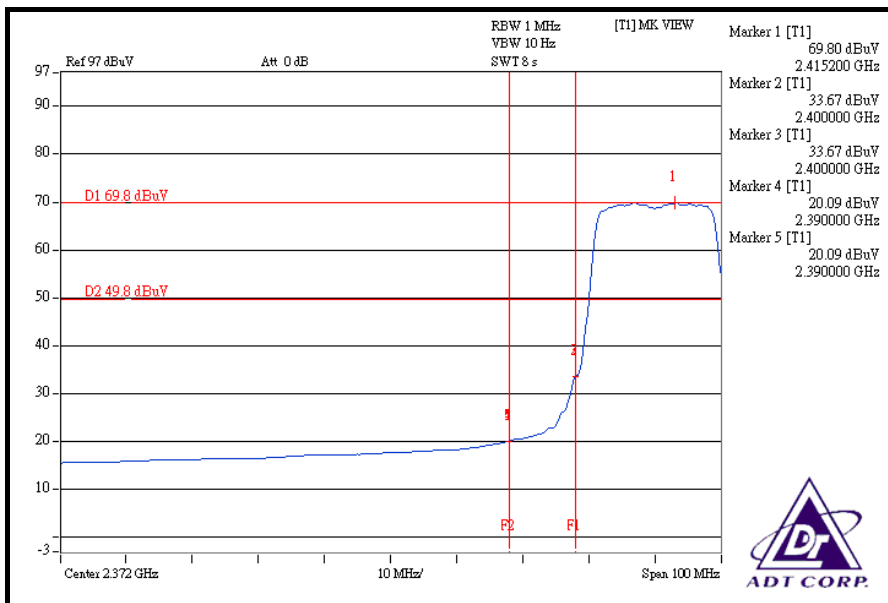
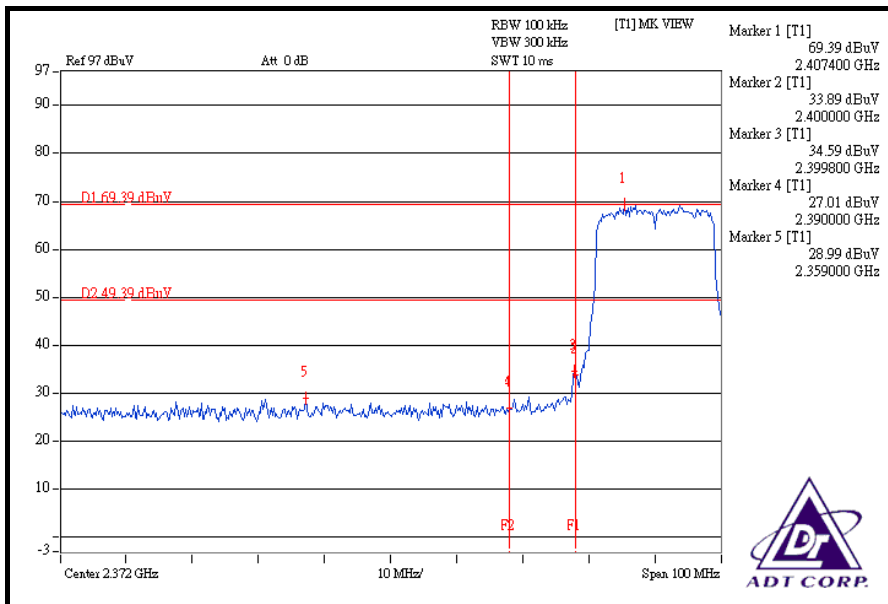

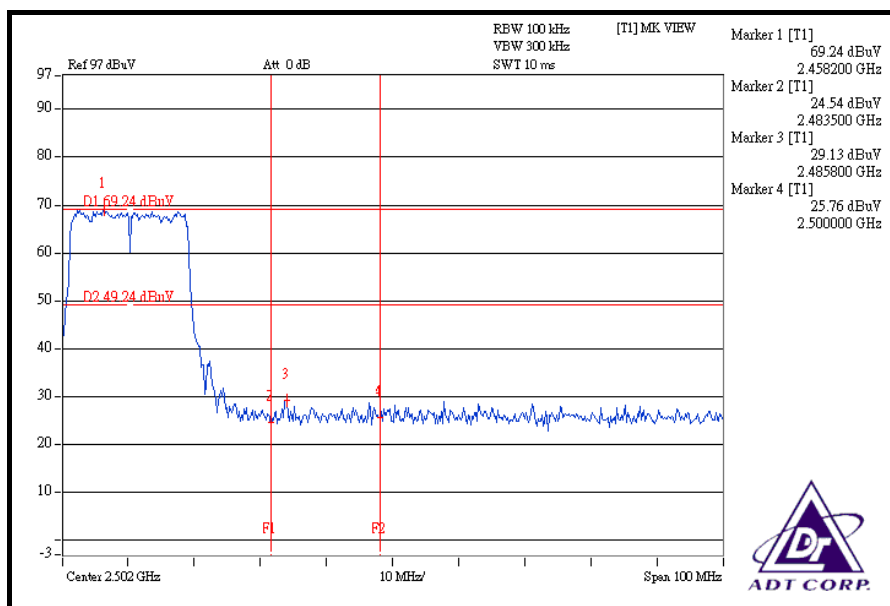
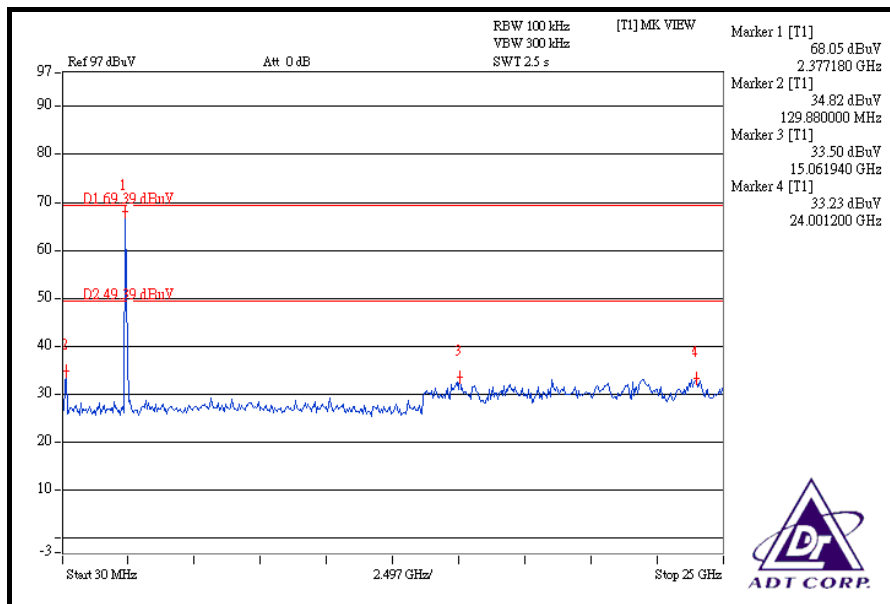

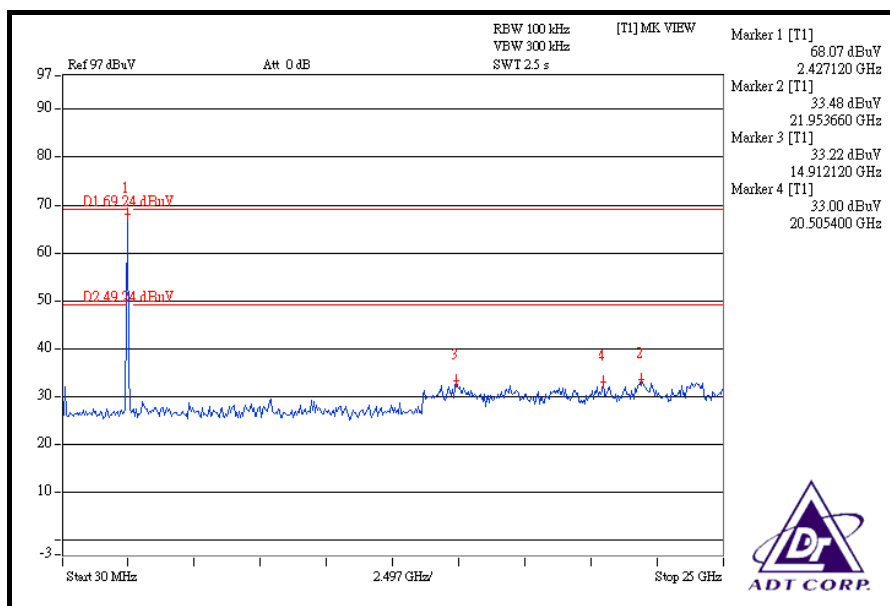
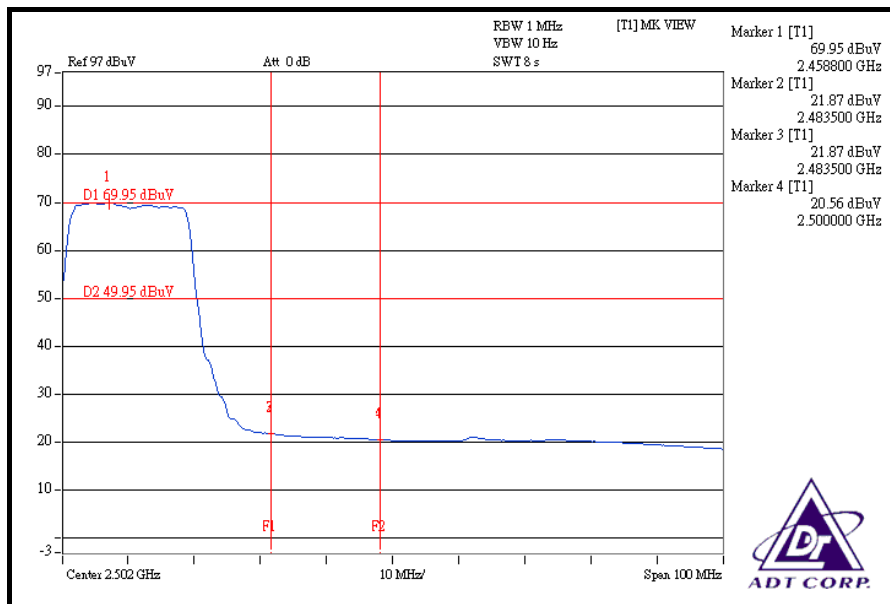

## DRAFT 802.11n (40MHz) OFDM MODULATION

**NOTE 1:** The band edge emission plot on the next page shows 36.78dBc between carrier maximum power and local maximum emission in restrict band (2.38920GHz). The emission of carrier strength list in the test result of channel 1 at the item 4.2.7 is 99.05dBuV/m (Peak), so the maximum field strength in restrict band is  $99.05 - 36.78 = 62.27$ dBuV/m which is under 74dBuV/m limit.

The band edge emission plot of on the next page shows 43.61dBc between carrier maximum power and local maximum emission in restrict band (2.39000GHz). The emission of carrier strength list in the test result of channel 1 at the item 4.2.7 is 89.04dBuV/m (Average), so the maximum field strength in restrict band is  $89.04 - 43.61 = 45.43$ dBuV/m which is under 54dBuV/m limit.

**NOTE 2:** The band edge emission plot on the next second page shows 38.42dBc between carrier maximum power and local maximum emission in restrict band (2.49120GHz). The emission of carrier strength list in the test result of channel 7 at the item 4.2.7 is 107.24dBuV/m (Peak), so the maximum field strength in restrict band is  $100.35 - 38.42 = 61.93$ dBuV/m which is under 74dBuV/m limit.

The band edge emission plot on the next third page shows 44.68dBc between carrier maximum power and local maximum emission in restrict band (2.48400GHz). The emission of carrier strength list in the test result of channel 7 at the item 4.2.7 is 89.79dBuV/m (Average), so the maximum field strength in restrict band is  $89.79 - 44.68 = 45.11$ dBuV/m which is under 54dBuV/m limit.

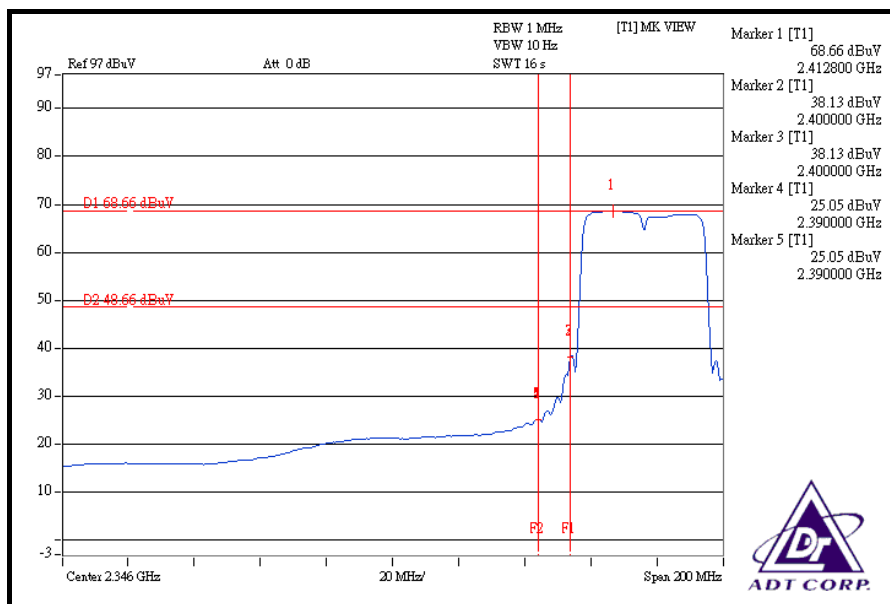
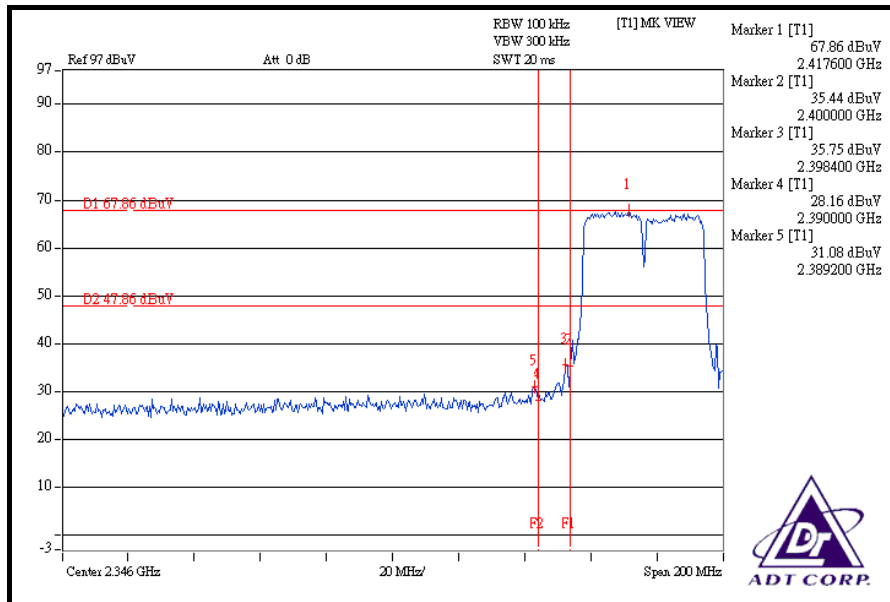

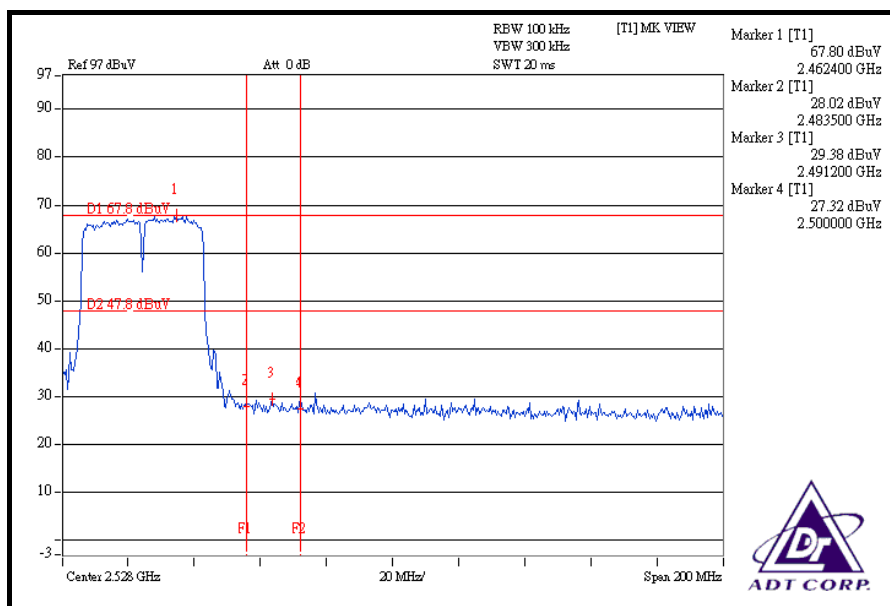
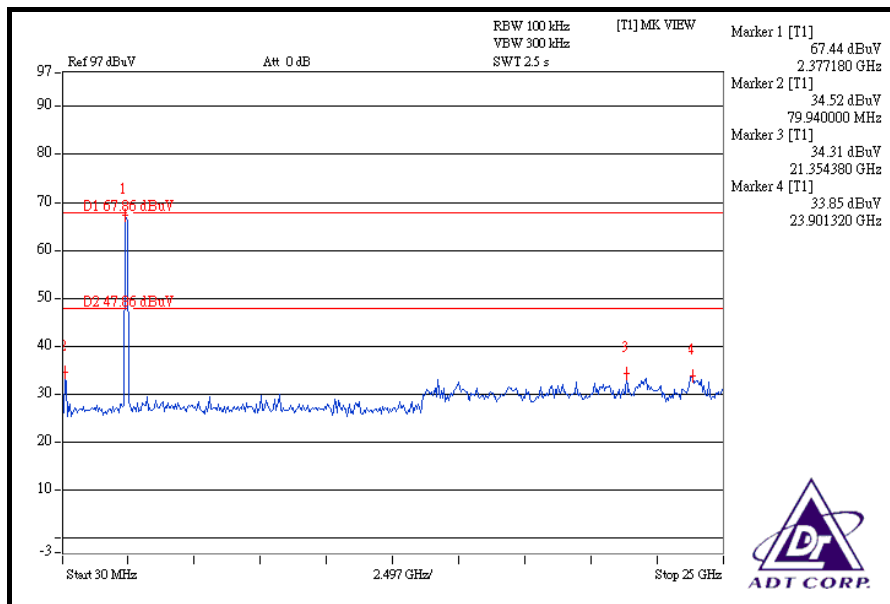

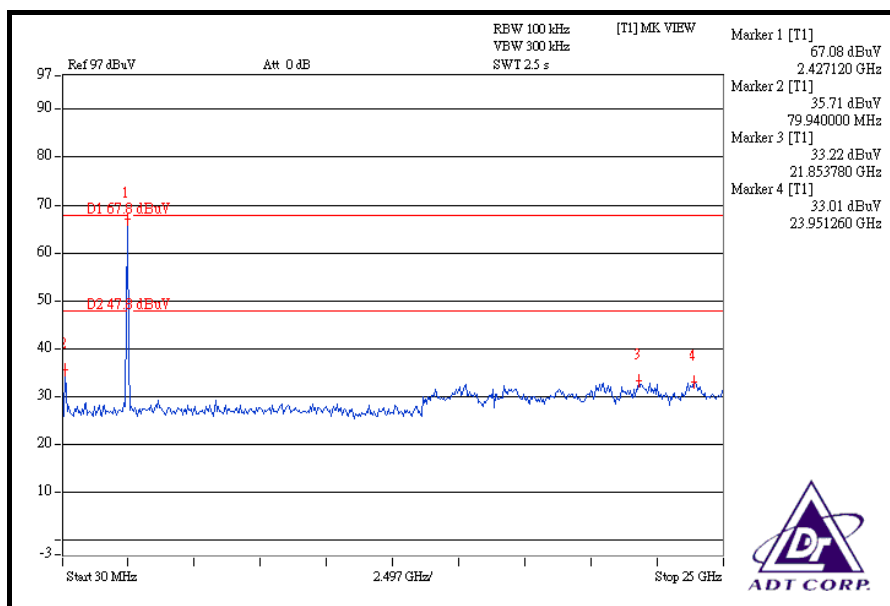
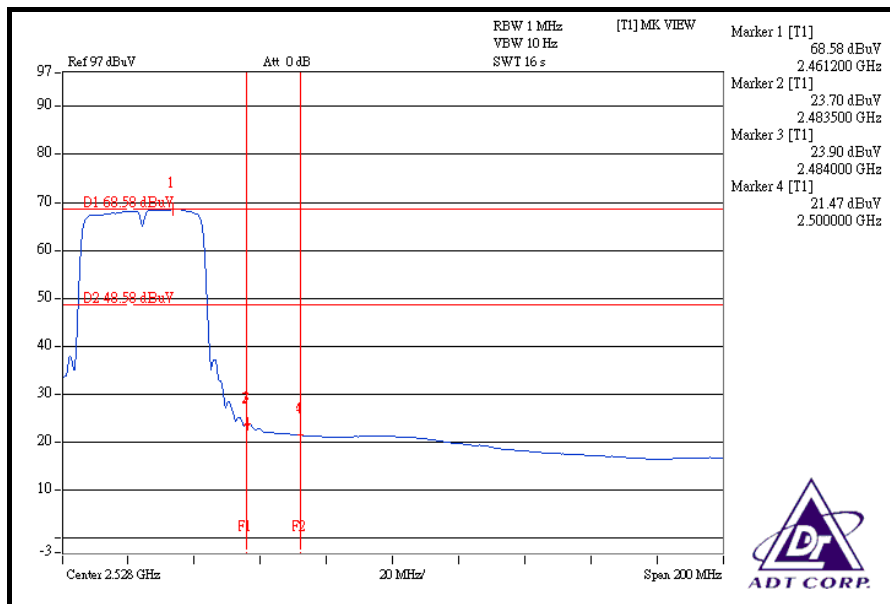



## **4.7 ANTENNA REQUIREMENT**

### **4.7.1 STANDARD APPLICABLE**

For intentional device, according to FCC 47 CFR Section 15.203, an intentional radiator shall be designed to ensure that no antenna other than that furnished by the responsible party shall be used with the device.

And according to FCC 47 CFR Section 15.247 (b), if transmitting antennas of directional gain greater than 6dBi are used, the power shall be reduced by the amount in dB that the directional gain of the antenna exceeds 6dBi.

### **4.7.2 ANTENNA CONNECTED CONSTRUCTION**

The antenna used in this product is PIFA antenna without connector. The maximum gain of the antenna is 2dBi.



## 5. PHOTOGRAPHS OF THE TEST CONFIGURATION

Please refer to the attached file (Test Setup Photo).



## 6. INFORMATION ON THE TESTING LABORATORIES

We, ADT Corp., were founded in 1988 to provide our best service in EMC, Radio, Telecom and Safety consultation. Our laboratories are accredited and approved by the following approval agencies according to ISO/IEC 17025.

<b>USA</b>	FCC, UL
<b>Germany</b>	TUV Rheinland
<b>Japan</b>	VCCI
<b>Norway</b>	NEMKO
<b>Canada</b>	INDUSTRY CANADA , CSA
<b>R.O.C.</b>	TAF, BSMI, NCC
<b>Netherlands</b>	Telefication
<b>Singapore</b>	GOST-ASIA(MOU)
<b>Russia</b>	CERTIS(MOU)

Copies of accreditation certificates of our laboratories obtained from approval agencies can be downloaded from our web site:

[www.adt.com.tw/index.5/phtml](http://www.adt.com.tw/index.5/phtml). If you have any comments, please feel free to contact us at the following:

**Linko EMC/RF Lab:**

Tel: 886-2-26052180

Fax: 886-2-26051924

**Hsin Chu EMC/RF Lab:**

Tel: 886-3-5935343

Fax: 886-3-5935342

**Hwa Ya EMC/RF/Safety Telecom Lab:**

Tel: 886-3-3183232

Fax: 886-3-3185050

**Web Site:** [www.adt.com.tw](http://www.adt.com.tw)

The address and road map of all our labs can be found in our web site also.

## **7. APPENDIX A - MODIFICATIONS RECORDERS FOR ENGINEERING CHANGES TO THE EUT BY THE LAB**

No any modifications are made to the EUT by the lab during the test.

**---END---**