



**Specific Absorption Rate (SAR) Test Report**  
for  
**Belkin International, Inc.**  
on the  
**N Wireless Notebook Card**

Report No. : FA790504-1-2-01  
Trade Name : Belkin  
Model Name : F5D8013 v3  
FCC ID : K7SF5D8013C  
Date of Testing : Sep. 14, 2007  
Date of Report : Sep. 28, 2007  
Date of Review : Sep. 28, 2007

- The test results refer exclusively to the presented test model / sample only.
- Without written approval of SPORTON International Inc., the test report shall not be reproduced except in full.
- Report Version: Rev. 01

***SPORTON International Inc.***

6F, No.106, Sec. 1, Hsin Tai Wu Rd., Hsi Chih, Taipei Hsien, Taiwan, R.O.C.



# Table of Contents

- 1. **Statement of Compliance** ..... 1
- 2. **Administration Data** ..... 2
  - 2.1 Testing Laboratory ..... 2
  - 2.2 Detail of Applicant ..... 2
  - 2.3 Detail of Manufacturer ..... 2
  - 2.4 Application Detail ..... 2
- 3. **Scope** ..... 3
  - 3.1 Description of Device Under Test (DUT) ..... 3
  - 3.2 Product Photo ..... 4
  - 3.3 Applied Standards: ..... 5
  - 3.4 Device Category and SAR Limits ..... 6
  - 3.5 Test Conditions ..... 6
    - 3.5.1 Ambient Condition: ..... 6
    - 3.5.2 Test Configuration: ..... 6
- 4. **Specific Absorption Rate (SAR)** ..... 7
  - 4.1 Introduction ..... 7
  - 4.2 SAR Definition ..... 7
- 5. **SAR Measurement Setup** ..... 8
  - 5.1 DASY4 E-Field Probe System ..... 9
    - 5.1.1 ET3DV6 E-Field Probe Specification ..... 10
    - 5.1.2 ET3DV6 E-Field Probe Calibration ..... 10
  - 5.2 DATA Acquisition Electronics (DAE) ..... 11
  - 5.3 Robot ..... 12
  - 5.4 Measurement Server ..... 12
  - 5.5 SAM Twin Phantom ..... 12
  - 5.6 Data Storage and Evaluation ..... 14
    - 5.6.1 Data Storage ..... 14
    - 5.6.2 Data Evaluation ..... 14
  - 5.7 Test Equipment List ..... 17
- 6. **Tissue Simulating Liquids** ..... 18
- 7. **Uncertainty Assessment** ..... 20
- 8. **SAR Measurement Evaluation** ..... 22
  - 8.1 Purpose of System Performance check ..... 22
  - 8.2 System Setup ..... 22
  - 8.3 Validation Results ..... 24
- 9. **Description for DUT Testing Position** ..... 25
- 10. **Measurement Procedures** ..... 26
  - 10.1 Spatial Peak SAR Evaluation ..... 26
  - 10.2 Scan Procedures ..... 27
  - 10.3 SAR Averaged Methods ..... 27
- 11. **SAR Test Results** ..... 28
  - 11.1 Dell D400 Notebook Bottom Touch ..... 28
  - 11.2 Dell D500 Notebook Bottom Touch ..... 28
  - 11.3 Dell M2300 Notebook Bottom Touch ..... 28
- 12. **Reference** ..... 29

- Appendix A - System Performance Check Data
- Appendix B - SAR Measurement Data
- Appendix C - Calibration Data
- Appendix D - Product Photo
- Appendix E - Setup Photo



## **1. Statement of Compliance**

The Specific Absorption Rate (SAR) maximum result found during testing for the Belkin International, Inc. N Wireless Notebook Card Belkin F5D8013 v3 is 0.454 W/Kg on the WLAN 2.4GHz band body SAR with expanded uncertainty 20.6%. It is in compliance with Specific Absorption Rate (SAR) for general population/uncontrolled exposure limits specified in FCC 47 CFR part 2 (2.1093) and ANSI/IEEE C95.1-1999 and had been tested in accordance with the measurement methods and procedures specified in OET Bulletin 65 Supplement C (Edition 01-01).

Approved by

A handwritten signature in blue ink that reads 'Jones Tsai'.

---

Jones Tsai  
Manager



## **2. Administration Data**

### **2.1 Testing Laboratory**

**Company Name :** Sporton International Inc.  
**Department :** Antenna Design/SAR  
**Address :** No.52, Hwa-Ya 1<sup>st</sup> RD., Hwa Ya Technology Park, Kwei-Shan Hsiang, TaoYuan Hsien, Taiwan, R.O.C.  
**Telephone Number :** + 886-3-327-3456  
**Fax Number :** + 886-3-327-0973

### **2.2 Detail of Applicant**

**Company Name :** Belkin International, Inc.  
**Address :** 501 West Walnut Street, Compton, CA 90220-5221, U.S.A.

### **2.3 Detail of Manufacturer**

**Company Name :** Arcadyan Technology Corporation  
**Address :** 4F, No.9, Park Avenue II, Science-based Industrial Park, Hsinchu 300, Taiwan, R.O.C.

### **2.4 Application Detail**

**Date of reception of application:** Sep. 05, 2007  
**Start of test :** Sep. 14, 2007  
**End of test :** Sep. 14, 2007



### 3. Scope

#### 3.1 Description of Device Under Test (DUT)

|  |  |
|--|--|
| <b>DUT Type :</b>                          | N Wireless Notebook Card   |
| <b>Trade Name :</b>                        | Belkin   |
| <b>Model Name :</b>                        | F5D8013 v3   |
| <b>FCC ID :</b>                            | K7SF5D8013C  |
| <b>Type of Modulation :</b>                | DSSS / OFDM  |
| <b>Frequency Range :</b>                   | 2400 ~ 2483.5 MHz  |
| <b>Number of Channels :</b>                | 11 for 20MHz bandwidth<br>7 for 40MHz bandwidth  |
| <b>Carrier Frequency of Each Channel :</b> | $2412 + (n - 1) * 5 \text{ MHz}; n = 1 \sim 11$  |
| <b>Maximum Output Power to Antenna :</b>   | 802.11b : 17.92 dBm<br>802.11g : 17.55 dBm<br>802.11n (BW 20MHz) : 17.53 dBm<br>802.11n (BW 40MHz) : 17.98 dBm |
| <b>Antenna Type :</b>                      | PCB Printed  |
| <b>Antenna Gain :</b>                      | 2 dBi  |



### **3.2 Product Photo**

Please refer to Appendix D



**3.3 Applied Standards:**

The Specific Absorption Rate (SAR) testing specification, method and procedure for this N Wireless Notebook Card is in accordance with the following standards:

47 CFR Part 2 (2.1093),  
IEEE C95.1-1999,  
IEEE C95.3-2002,  
IEEE P1528 -2003, and  
OET Bulletin 65 Supplement C (Edition 01-01)



**3.4 Device Category and SAR Limits**

This device belongs to portable device category because its radiating structure is allowed to be used within 20 centimeters of the body of the user.

Limit for General Population/Uncontrolled exposure should be applied for this device, it is 1.6 W/kg as averaged over any 1 gram of tissue.

**3.5 Test Conditions**

**3.5.1 Ambient Condition:**

|  |          |
|--|----------|
| <b>Item</b>                                      | MSL 2450 |
| <b>Ambient Temperature (°C)</b>                  | 20 ~ 24  |
| <b>Tissue simulating liquid temperature (°C)</b> | 21.5     |
| <b>Humidity (%)</b>                              | < 60%    |

**3.5.2 Test Configuration:**

The data rates for SAR testing are 1Mbps for 802.11b, 6Mbps for 802.11g and 6.5Mbps for 802.11n. Engineering testing software installed on the EUT can provide continuous transmitting RF signal. This RF signal utilized in SAR measurement has almost 100% duty cycle and its crest factor is 1. The measurements were performed on the lowest, middle, and highest channel, i.e. channel 1, channel 6, and channel 11 for BW 20MHz; channel 3, channel 6, channel 9 for BW 40MHz. However, measurements were performed only on the middle channel if the SAR is below 3 dB of limit.





#### 4. Specific Absorption Rate (SAR)

##### 4.1 Introduction

SAR is related to the rate at which energy is absorbed per unit mass in an object exposed to a radio field. The SAR distribution in a biological body is complicated and is usually carried out by experimental techniques or numerical modeling. The FCC recommends limits for two tiers of groups, occupational/controlled and general population/uncontrolled, based on a person’s awareness and ability to exercise control over his or her exposure. In general, occupational/controlled exposure limits are higher than the limits for general population/uncontrolled.

##### 4.2 SAR Definition

The SAR definition is the time derivative (rate) of the incremental energy (dW) absorbed by (dissipated in) an incremental mass (dm) contained in a volume element (dv) of a given density.

). The equation description is as below:

$$\mathbf{SAR} = \frac{d}{dt} \left( \frac{dW}{dm} \right) = \frac{d}{dt} \left( \frac{dW}{\rho dv} \right)$$

*SAR is expressed in units of Watts per kilogram (W/kg)*

SAR measurement can be either related to the temperature elevation in tissue by

$$\mathbf{SAR} = C \frac{\delta T}{\delta t}$$

, where C is the specific heat capacity,  $\delta T$  is the temperature rise and  $\delta t$  the exposure duration,

or related to the electrical field in the tissue by

$$\mathbf{SAR} = \frac{\sigma |E|^2}{\rho}$$

, where  $\sigma$  is the conductivity of the tissue,  $\rho$  is the mass density of the tissue and  $E$  is the rms electrical field strength.

However for evaluating SAR of low power transmitter, electrical field measurement is typically applied.

### 5. SAR Measurement Setup

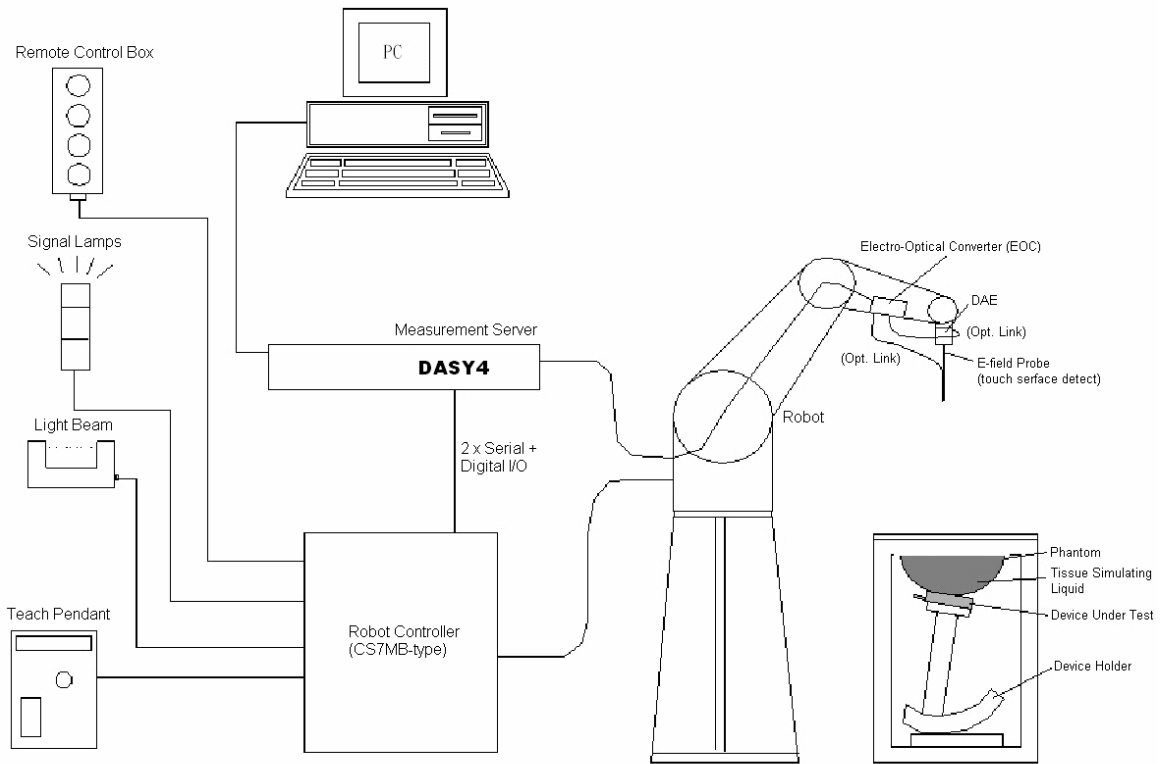

**Fig. 5.1 DASY4 system**



The DASY4 system for performance compliance tests is illustrated above graphically. This system consists of the following items:

- A standard high precision 6-axis robot with controller, a teach pendant and software
- A data acquisition electronic (DAE) attached to the robot arm extension
- A dosimetric probe equipped with an optical surface detector system
- The electro-optical converter (ECO) performs the conversion between optical and electrical signals
- A measurement server performs the time critical tasks such as signal filtering, control of the robot operation and fast movement interrupts.
- A probe alignment unit which improves the accuracy of the probe positioning
- A computer operating Windows XP
- DASY4 software
- Remote control with teach pendant and additional circuitry for robot safety such as warning lamps, etc.
- The SAM twin phantom
- A device holder
- Tissue simulating liquid
- Dipole for evaluating the proper functioning of the system

Some of the components are described in details in the following sub-sections.

### **5.1 DASY4 E-Field Probe System**

The SAR measurement is conducted with the dosimetric probe ET3DV6 (manufactured by SPEAG). The probe is specially designed and calibrated for use in liquid with high permittivity. The dosimetric probe has special calibration in liquid at different frequency. This probe has a built in optical surface detection system to prevent from collision with phantom.

**5.1.1 ET3DV6 E-Field Probe Specification**

|                          |  |
|--------------------------|--|
| <b>Construction</b>      | Symmetrical design with triangular core<br>Built-in optical fiber for surface detection system<br>Built-in shielding against static charges<br>PEEK enclosure material (resistant to organic solvents) |
| <b>Calibration</b>       | Simulating tissue at frequencies of 900MHz, 1.8GHz and 2.45GHz for brain and muscle (accuracy $\pm 8\%$ )  |
| <b>Frequency</b>         | 10 MHz to > 3 GHz  |
| <b>Directivity</b>       | $\pm 0.2$ dB in brain tissue (rotation around probe axis)<br>$\pm 0.4$ dB in brain tissue (rotation perpendicular to probe axis)   |
| <b>Dynamic Range</b>     | 5 $\mu$ W/g to > 100mW/g; Linearity: $\pm 0.2$ dB  |
| <b>Surface Detection</b> | $\pm 0.2$ mm repeatability in air and clear liquids on reflecting surface  |
| <b>Dimensions</b>        | Overall length: 330mm<br>Tip length: 16mm<br>Body diameter: 12mm<br>Tip diameter: 6.8mm<br>Distance from probe tip to dipole centers: 2.7mm  |
| <b>Application</b>       | General dosimetry up to 3GHz<br>Compliance tests for mobile phones and Wireless LAN<br>Fast automatic scanning in arbitrary phantoms   |



**Fig. 5.2 Probe setup on robot**

**5.1.2 ET3DV6 E-Field Probe Calibration**

Each probe needs to be calibrated according to a dosimetric assessment procedure with accuracy better than  $\pm 10\%$ . The spherical isotropy shall be evaluated and within  $\pm 0.25$ dB. The sensitivity parameters (NormX, NormY, and NormZ), the diode compression parameter (DCP) and the conversion factor (ConvF) of the probe are tested. The calibration data are as below:



> ET3DV6 sn1787

|                                 |                        |                       |                       |               |
|---------------------------------|------------------------|-----------------------|-----------------------|---------------|
| <b>Sensitivity</b>              | X axis : 1.63 $\mu$ V  | Y axis : 1.66 $\mu$ V | Z axis : 2.08 $\mu$ V |               |
| <b>Diode compression point</b>  | X axis : 92 mV         | Y axis : 96 mV        | Z axis : 91 mV        |               |
| <b>Conversion factor (Body)</b> | <b>Frequency (MHz)</b> | <b>X axis</b>         | <b>Y axis</b>         | <b>Z axis</b> |
|                                 | 2350~2550              | 4.02                  | 4.02                  | 4.02          |
| <b>Boundary effect (Body)</b>   | <b>Frequency (MHz)</b> | <b>Alpha</b>          | <b>Depth</b>          |               |
|                                 | 2350~2550              | 0.65                  | 2.15                  |               |

NOTE:

1. The probe parameters have been calibrated by the SPEAG.

**5.2 DATA Acquisition Electronics (DAE)**

The data acquisition electronics (DAE4) consists of a highly sensitive electrometer-grade preamplifier with auto-zeroing, a channel and gain-switching multiplexer, a fast 16 bit AD-converter and a command decoder and control logic unit. Transmission to the measurement server is accomplished through an optical downlink for data and status information as well as an optical uplink for commands and the clock.

The mechanical probe mounting device includes two different sensor systems for frontal and sideways probe contacts. They are used for mechanical surface detection and probe collision detection.

The input impedance of the DAE4 is 200M Ohm; the inputs are symmetrical and floating. Common mode rejection is above 80dB.



### **5.3 Robot**

The DASY4 system uses the high precision robots RX90BL type out of the newer series from Stäubli SA (France). For the 6-axis controller DASYS system, the CS7MB robot controller version from Stäubli is used. The RX robot series have many features that are important for our application:

- High precision (repeatability 0.02 mm)
- High reliability (industrial design)
- Jerk-free straight movements
- Low ELF interference (the closed metallic construction shields against motor control fields)
- 6-axis controller

### **5.4 Measurement Server**

The DASY4 measurement server is based on a PC/104 CPU board with  
166 MHz CPU  
32 MB chipset and  
64 MB RAM.

Communication with  
the DAE4 electronic box  
the 16-bit AD-converter system for optical detection and digital I/O interface.

The measurement server performs all the real-time data evaluation for field measurements and surface detection, controls robot movements and handles safety operations.

### **5.5 SAM Twin Phantom**

The SAM twin phantom is a fiberglass shell phantom with 2mm shell thickness (except the ear region where shell thickness increases to 6mm). It has three measurement areas:

- Left head
- Right head
- Flat phantom

The bottom plate contains three pair of bolts for locking the device holder. The device holder positions are adjusted to the standard measurement positions in the three sections.

A white cover is provided to tap the phantom during off-periods to prevent water evaporation and changes in the liquid parameters.

On the phantom top, three reference markers are provided to identify the phantom position with respect to the robot.

The phantom can be used with the following tissue simulating liquids:

- \*Water-sugar based liquid
- \*Glycol based liquids

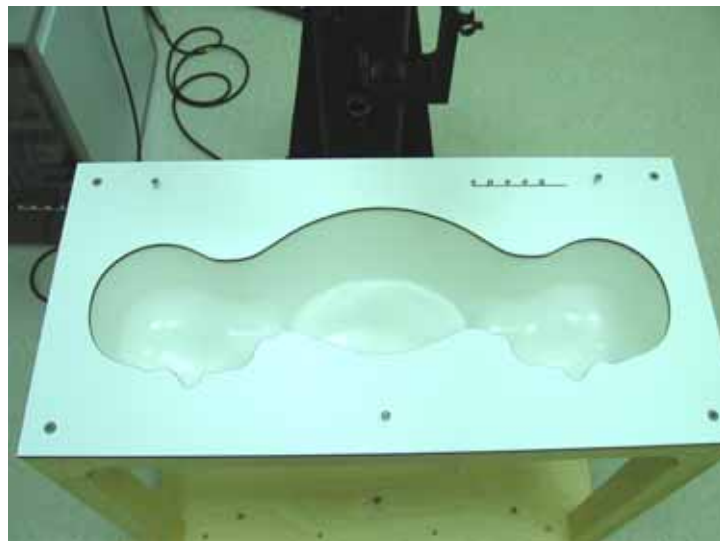

**Fig. 5.3 Top view of twin phantom**



**Fig. 5.4 Bottom view of twin phantom**



## 5.6 Data Storage and Evaluation

### 5.6.1 Data Storage

The DASY4 software stores the assessed data from the data acquisition electronics as raw data (in microvolt readings from the probe sensors), together with all the necessary software parameters for the data evaluation (probe calibration data, liquid parameters and device frequency and modulation data) in measurement files with the extension .DA4. The post-processing software evaluates the desired unit and format for output each time the data is visualized or exported. This allows verification of the complete software setup even after the measurement and allows correction of erroneous parameter settings. For example, if a measurement has been performed with an incorrect crest factor parameter in the device setup, the parameter can be corrected afterwards and the data can be reevaluated.

The measured data can be visualized or exported in different units or formats, depending on the selected probe type (e.g., [V/m], [A/m], [mW/g]). Some of these units are not available in certain situations or give meaningless results, e.g., a SAR-output in a non-louse media, will always be zero. Raw data can also be exported to perform the evaluation with other software packages.

### 5.6.2 Data Evaluation

The DASY4 post-processing software (SEMCAD) automatically executes the following procedures to calculate the field units from the microvolt readings at the probe connector. The parameters used in the evaluation are stored in the configuration modules of the software :

|                            |                           |   |
|----------------------------|---------------------------|---|
| <b>Probe parameters :</b>  | - Sensitivity             | Norm <sub>i</sub> , a <sub>i0</sub> , a <sub>i1</sub> , a <sub>i2</sub> |
|                            | - Conversion factor       | ConvF <sub>i</sub>  |
|                            | - Diode compression point | dcp <sub>i</sub>  |
| <b>Device parameters :</b> | - Frequency               | f   |
|                            | - Crest factor            | cf  |
| <b>Media parameters :</b>  | - Conductivity            |   |
|                            | - Density                 |   |

These parameters must be set correctly in the software. They can be found in the component documents or they can be imported into the software from the configuration files issued for the DASY components. In the direct measuring mode of the multi-meter option, the parameters of the actual system setup are used. In the scan visualization and export modes, the parameters stored in the corresponding document files are used.

The first step of the evaluation is a linearization of the filtered input signal to account for the compression characteristics of the detector diode. The compensation depends on the input signal, the diode type and the DC-transmission factor from the diode to the evaluation electronics. If the exciting field is pulsed, the crest factor of the signal must be known to correctly compensate for peak power.





The formula for each channel can be given as :

$$V_i = U_i + U_i^2 \cdot \frac{cf}{dcp_i}$$

with  $V_i$  = compensated signal of channel  $i$  ( $i = x, y, z$ )  
 $U_i$  = input signal of channel  $i$  ( $i = x, y, z$ )  
 $cf$  = crest factor of exciting field (DASY parameter)  
 $dcp_i$  = diode compression point (DASY parameter)

From the compensated input signals, the primary field data for each channel can be evaluated :

$$\text{E-field probes : } E_i = \sqrt{\frac{V_i}{Norm_i ConvF}}$$

$$\text{H-field probes : } H_i = \frac{\sqrt{V_i} \cdot a_{i0} + a_{i1}f + a_{i2}f^2}{f}$$

with  $V_i$  = compensated signal of channel  $i$  ( $i = x, y, z$ )  
 $Norm_i$  = sensor sensitivity of channel  $i$  ( $i = x, y, z$ )  
 $\mu V/(V/m)^2$  for E-field Probes  
 $ConvF$  = sensitivity enhancement in solution  
 $a_{ij}$  = sensor sensitivity factors for H-field probes  
 $f$  = carrier frequency [GHz]  
 $E_i$  = electric field strength of channel  $i$  in V/m  
 $H_i$  = magnetic field strength of channel  $i$  in A/m

The RSS value of the field components gives the total field strength (Hermitian magnitude) :

$$E_{tot} = \sqrt{E_x^2 + E_y^2 + E_z^2}$$

The primary field data are used to calculate the derived field units.

$$SAR = E_{tot}^2 \cdot \frac{\sigma}{\rho \cdot 1000}$$

with  $SAR$  = local specific absorption rate in mW/g  
 $E_{tot}$  = total field strength in V/m  
= conductivity in [mho/m] or [Siemens/m]  
= equivalent tissue density in g/ cm<sup>3</sup>



\* Note that the density is set to 1, to account for actual head tissue density rather than the density of the tissue simulating liquid.

The power flow density is calculated assuming the excitation field to be a free space field.

$$P_{pwe} = \frac{E_{tot}^2}{3770} \quad \text{or} \quad P_{pwe} = H_{tot}^2 \cdot 37.7$$

with  $P_{pwe}$  = equivalent power density of a plane wave in mW/cm<sup>2</sup>  
 $E_{tot}$  = total electric field strength in V/m  
 $H_{tot}$  = total magnetic field strength in A/m



**5.7 Test Equipment List**

| Manufacture | Name of Equipment               | Type/Model               | Serial Number   | Calibration   |               |
|-------------|---------------------------------|--------------------------|-----------------|---------------|---------------|
|             |                                 |                          |                 | Last Cal.     | Due Date      |
| SPEAG       | Dosimetric E-Filed Probe        | ET3DV6                   | 1787            | Aug. 28, 2007 | Aug. 28, 2008 |
| SPEAG       | 2450MHz System Validation Kit   | D2450V2                  | 736             | Jul. 12, 2007 | Jul. 12, 2009 |
| SPEAG       | Data Acquisition Electronics    | DAE3                     | 577             | Nov. 21, 2006 | Nov. 21, 2007 |
| SPEAG       | Device Holder                   | N/A                      | N/A             | NCR           | NCR           |
| SPEAG       | Phantom                         | QD 000 P40 C             | TP-1150         | NCR           | NCR           |
| SPEAG       | Robot                           | Staubli RX90BL           | F03/5W15A1/A/01 | NCR           | NCR           |
| SPEAG       | Software                        | DASY4<br>V4.7 Build 53   | N/A             | NCR           | NCR           |
| SPEAG       | Software                        | SEMCAD<br>V1.8 Build 172 | N/A             | NCR           | NCR           |
| SPEAG       | Measurement Server              | SE UMS 001 BA            | 1021            | NCR           | NCR           |
| Agilent     | ENA Series Network Analyzer     | E5071C                   | MY46100746      | Feb. 21, 2007 | Feb. 21, 2008 |
| Agilent     | Wireless Communication Test Set | E5515C                   | GB46311322      | Dec. 22, 2006 | Dec. 22, 2008 |
| Agilent     | Dielectric Probe Kit            | 85070D                   | US01440205      | NCR           | NCR           |
| Agilent     | Dual Directional Coupler        | 778D                     | 50422           | NCR           | NCR           |
| Agilent     | Power Amplifier                 | 8449B                    | 3008A01917      | NCR           | NCR           |
| Agilent     | Power Meter                     | E4416A                   | GB41292344      | Feb. 08, 2007 | Feb. 08, 2008 |
| Agilent     | Power Sensor                    | E9327A                   | US40441548      | Feb. 08, 2007 | Feb. 08, 2008 |
| Agilent     | Signal Generator                | E8247C                   | MY43320596      | Mar. 01, 2006 | Mar. 01, 2008 |

**Table 5.1 Test Equipment List**



### 6. Tissue Simulating Liquids

For the measurement of the field distribution inside the SAM phantom with DASY4, the phantom must be filled with around 25 liters of homogeneous body tissue simulating liquid. The liquid height from the bottom of the phantom body is 15.2 centimeters, which is shown in Fig. 6.1.

The following ingredients for tissue simulating liquid are used:

- **Water:** deionized water (pure H<sub>2</sub>O), resistivity 16M $\Omega$  - as basis for the liquid
- **Sugar:** refined sugar in crystals, as available in food shops – to reduce relative permittivity
- **Salt:** pure NaCl – to increase conductivity
- **Cellulose:** Hydroxyethyl-cellulose, medium viscosity (75-125 mPa.s, 2% in water, 20°C), CAS#54290-to increase viscosity and to keep sugar in solution.
- **Preservative:** Preventol D-7 Bayer AG, D-51368 Leverkusen, CAS#55965-84-9- to prevent the spread of bacteria and molds.
- **DGMBE:** Deithlenglycol-monobuthyl ether (DGMBE), Fluka Chemie GmbH, CAS#112-34-5 – to reduce relative permittivity.

Table 6.1 gives the recipes for one liter of tissue simulating liquid for frequency band 2450 MHz.

|                                     |  |
|-------------------------------------|--|
| <b>Ingredient</b>                   | MSL-2450   |
| <b>Water</b>                        | 698.3 ml   |
| <b>DGMBE</b>                        | 301.7 ml   |
| <b>Total amount</b>                 | 1 liter (1.0 kg)   |
| <b>Dielectric Parameters at 22°</b> | f = 2450MHz<br>$\epsilon_r = 52.7 \pm 5\%$ , $\sigma = 1.95 \pm 5\%$ S/m |

**Table 6.1 Recipes of tissue Simulating Liquid**

The dielectric parameters of the liquids were verified prior to the SAR evaluation using an Agilent 85070D Dielectric Probe Kit and an Agilent Network Analyzer.

Table 6.2 shows the measuring results for muscle simulating liquid.

| Bands    | Frequency(MHz) | Permittivity ( $\epsilon_r$ ) | Conductivity ( $\sigma$ ) | Measurement date |
|----------|----------------|-------------------------------|---------------------------|------------------|
| 2450 MHz | 2412           | 53.0                          | 1.92                      | Sep. 14, 2007    |
|          | 2437           | 53.0                          | 1.95                      |                  |
|          | 2462           | 52.9                          | 1.99                      |                  |

**Table 6.2 Measuring Results for Muscle Simulating Liquid**

The measuring data are consistent with  $\epsilon_r = 52.7 \pm 5\%$  and  $\sigma = 1.95 \pm 5\%$ .



**Fig 6.1 Liquid height from the bottom of the phantom body is 15.2 centimeters**



### 7. Uncertainty Assessment

The component of uncertainty may generally be categorized according to the methods used to evaluate them. The evaluation of uncertainty by the statistical analysis of a series of observations is termed a Type A evaluation of uncertainty. The evaluation of uncertainty by means other than the statistical analysis of a series of observation is termed a Type B evaluation of uncertainty. Each component of uncertainty, however evaluated, is represented by an estimated standard deviation, termed standard uncertainty, which is determined by the positive square root of the estimated variance.

A Type A evaluation of standard uncertainty may be based on any valid statistical method for treating data. This includes calculating the standard deviation of the mean of a series of independent observations; using the method of least squares to fit a curve to the data in order to estimate the parameter of the curve and their standard deviations; or carrying out an analysis of variance in order to identify and quantify random effects in certain kinds of measurement.

A type B evaluation of standard uncertainty is typically based on scientific judgment using all of the relevant information available. These may include previous measurement data, experience and knowledge of the behavior and properties of relevant materials and instruments, manufacture’s specification, data provided in calibration reports and uncertainties assigned to reference data taken from handbooks. Broadly speaking, the uncertainty is either obtained from an outdoor source or obtained from an assumed distribution, such as the normal distribution, rectangular or triangular distributions indicated in Table 7.1

| Uncertainty Distributions         | Normal             | Rectangular | Triangular | U-shape |
|-----------------------------------|--------------------|-------------|------------|---------|
| Multiplying factor <sup>(a)</sup> | 1/k <sup>(b)</sup> | 1/ 3        | 1/ 6       | 1/ 2    |

- (a) standard uncertainty is determined as the product of the multiplying factor and the estimated range of variations in the measured quantity
- (b) is the coverage factor

**Table 7.1 Standard Uncertainty for Assumed Distribution**

The combined standard uncertainty of the measurement result represents the estimated standard deviation of the result. It is obtained by combining the individual standard uncertainties of both Type A and Type B evaluation using the usual “root-sum-squares” (RSS) methods of combining standard deviations by taking the positive square root of the estimated variances.

Expanded uncertainty is a measure of uncertainty that defines an interval about the measurement result within which the measured value is confidently believed to lie. It is obtained by multiplying the combined standard uncertainty by a coverage factor. Typically, the coverage factor ranges from 2 to 3. Using a coverage factor allows the true value of a measured quantity to be specified with a defined probability within the specified uncertainty range. For purpose of this document, a coverage factor two is used, which corresponds to confidence interval of about 95 %. The DASY4 uncertainty Budget is showed in Table 7.2.



| Error Description  | Uncertainty Value $\pm$ % | Probability Distribution | Divisor                | $C_i$<br>$1g$ | Standard Unc. (1-g)          | $v_i$<br>or<br>$V_{eff}$ |
|--|---------------------------|--------------------------|------------------------|---------------|------------------------------|--------------------------|
| <b>Measurement System</b>  |                           |                          |                        |               |                              |                          |
| Probe Calibration  | $\pm 4.8$                 | Normal                   | 1                      | 1             | $\pm 4.8$                    |                          |
| Axial Isotropy   | $\pm 4.7$                 | Rectangular              | $\sqrt{3}$             | 0.7           | $\pm 1.9$                    |                          |
| Hemispherical Isotropy   | $\pm 9.6$                 | Rectangular              | $\sqrt{3}$             | 0.7           | $\pm 3.9$                    |                          |
| Boundary Effect  | $\pm 1.0$                 | Rectangular              | $\sqrt{3}$             | 1             | $\pm 0.6$                    |                          |
| Linearity  | $\pm 4.7$                 | Rectangular              | $\sqrt{3}$             | 1             | $\pm 2.7$                    |                          |
| System Detection Limit   | $\pm 1.0$                 | Rectangular              | $\sqrt{3}$             | 1             | $\pm 0.6$                    |                          |
| Readout Electronics  | $\pm 1.0$                 | Normal                   | 1                      | 1             | $\pm 1.0$                    |                          |
| Response Time  | $\pm 0.8$                 | Rectangular              | $\sqrt{3}$             | 1             | $\pm 0.5$                    |                          |
| Integration time   | $\pm 2.6$                 | Rectangular              | $\sqrt{3}$             | 1             | $\pm 1.5$                    |                          |
| RF Ambient Conditions  | $\pm 3.0$                 | Rectangular              | $\sqrt{3}$             | 1             | $\pm 1.7$                    |                          |
| Probe Positioner Mech. Tolerance                                   | $\pm 0.4$                 | Rectangular              | $\sqrt{3}$             | 1             | $\pm 0.2$                    |                          |
| Probe Positioning with respect to Phantom Shell                    | $\pm 2.9$                 | Rectangular              | $\sqrt{3}$             | 1             | $\pm 1.7$                    |                          |
| Extrapolation and Interpolation Algorithms for Max. SAR Evaluation | $\pm 1.0$                 | Rectangular              | $\sqrt{3}$             | 1             | $\pm 0.6$                    |                          |
| <b>Test sample Related</b>   |                           |                          |                        |               |                              |                          |
| Test sample Positioning  | $\pm 2.9$                 | Normal                   | 1                      | 1             | $\pm 2.9$                    | 145                      |
| Device Holder Uncertainty  | $\pm 3.6$                 | Normal                   | 1                      | 1             | $\pm 3.6$                    | 5                        |
| Output Power Variation-SAR drift measurement                       | $\pm 5.0$                 | Rectangular              | $\sqrt{3}$             | 1             | $\pm 2.9$                    |                          |
| <b>Phantom and Setup</b>   |                           |                          |                        |               |                              |                          |
| Phantom uncertainty(Including shape and thickness tolerances)      | $\pm 4.0$                 | Rectangular              | $\sqrt{3}$             | 1             | $\pm 2.3$                    |                          |
| Liquid Conductivity Target tolerance                               | $\pm 5.0$                 | Rectangular              | $\sqrt{3}$             | 0.64          | $\pm 1.8$                    |                          |
| Liquid Conductivity measurement uncertainty                        | $\pm 2.5$                 | Normal                   | 1                      | 0.64          | $\pm 1.6$                    |                          |
| Liquid Permittivity Target tolerance                               | $\pm 5.0$                 | Rectangular              | $\sqrt{3}$             | 0.6           | $\pm 1.7$                    |                          |
| Liquid Permittivity measurement uncertainty                        | $\pm 2.5$                 | Normal                   | 1                      | 0.6           | $\pm 1.5$                    |                          |
| <b>Combined standard uncertainty</b>                               |                           |                          |                        |               | <b><math>\pm 10.3</math></b> | <b>330</b>               |
| <b>Coverage Factor for 95 %</b>                                    |                           | <b><math>K=2</math></b>  |                        |               |                              |                          |
| <b>Expanded uncertainty (Coverage factor = 2)</b>                  |                           |                          | <b>Normal (k=2) 27</b> |               | <b><math>\pm 20.6</math></b> |                          |

Table 7.2 Uncertainty Budget of DASYS

## 8. SAR Measurement Evaluation

Each DASY system is equipped with one or more system validation kits. These units, together with the predefined measurement procedures within the DASY software, enable the user to conduct the system performance check and system validation. System validation kit includes a dipole, tripod holder to fix it underneath the flat phantom and a corresponding distance holder.

### 8.1 Purpose of System Performance check

The system performance check verifies that the system operates within its specifications. System and operator errors can be detected and corrected. It is recommended that the system performance check be performed prior to any usage of the system in order to guarantee reproducible results. The system performance check uses normal SAR measurements in a simplified setup with a well characterized source. This setup was selected to give a high sensitivity to all parameters that might fail or vary over time. The system check does not intend to replace the calibration of the components, but indicates situations where the system uncertainty is exceeded due to drift or failure.

### 8.2 System Setup

In the simplified setup for system evaluation, the DUT is replaced by a calibrated dipole and the power source is replaced by a continuous wave which comes from a signal generator at frequency 2450 MHz. The calibrated dipole must be placed beneath the flat phantom section of the SAM twin phantom with the correct distance holder. The distance holder should touch the phantom surface with a light pressure at the reference marking and be oriented parallel to the long side of the phantom. The equipment setup is shown below:

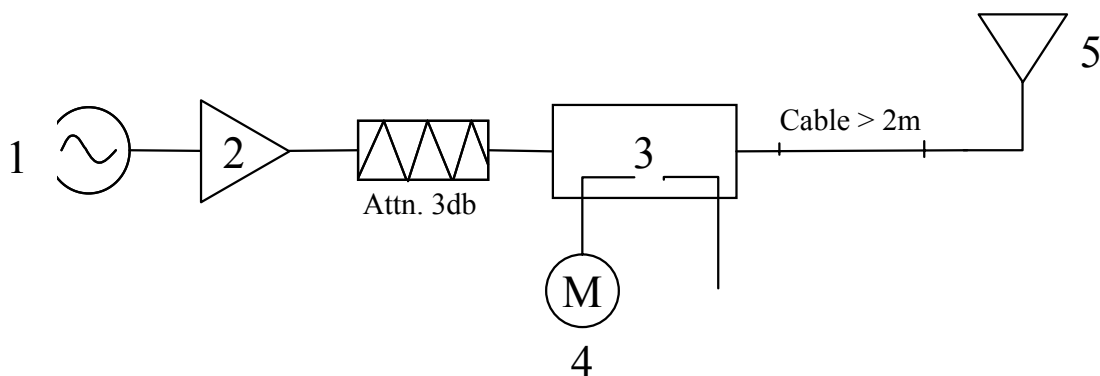

Fig. 8.1 System Setup for System Evaluation



1. Signal Generator
2. Amplifier
3. Directional Coupler
4. Power Meter
5. 2450 MHz Dipole

The output power on dipole port must be calibrated to 100 mW (20 dBm) before dipole is connected.



**Fig 8.2 Dipole Setup**



**8.3 Validation Results**

Comparing to the original SAR value provided by Speag, the validation data should within its specification of 10 %. Table 8.1 shows the target SAR and measured SAR after normalized to 1W input power.

| Band     | SAR       | Target (W/kg) | Measurement data (W/kg) | Variation | Measurement date |
|----------|-----------|---------------|-------------------------|-----------|------------------|
| 2450 MHz | SAR (1g)  | 52.5          | 53.1                    | 1.1 %     | Sep. 14, 2007    |
|          | SAR (10g) | 24.4          | 25.2                    | 3.3 %     |                  |

**Table 8.1 Target and Measured SAR after Normalization**

The table above indicates the system performance check can meet the variation criterion.



## **9. Description for DUT Testing Position**

This DUT was tested in 3 different positions. They are “Dell D400 Notebook Bottom Touch”, “Dell D500 Notebook Bottom Touch”, and “Dell M2300 Notebook Bottom Touch”..

Remark: Please refer to Appendix E for the test setup photo.



## **10. Measurement Procedures**

The measurement procedures are as follows:

- Using engineering software to transmit RF power continuously (continuous Tx) in the low channel
- Placing the DUT in the positions described in the last section
- Setting scan area, grid size and other setting on the DASY4 software
- Taking data for the low channel
- Repeat the previous steps for the middle and high channels.

According to the IEEE P1528 draft standard, the recommended procedure for assessing the peak spatial-average SAR value consists of the following steps:

- Power reference measurement
- Area scan
- Zoom scan
- Power reference measurement

### **10.1 Spatial Peak SAR Evaluation**

The procedure for spatial peak SAR evaluation has been implemented according to the IEEE1528-2003 standard. It can be conducted for 1g and 10g, as well as for user-specific masses. The DASY4 software includes all numerical procedures necessary to evaluate the spatial peak SAR value.

Base on the Draft: SCC-34, SC-2, WG-2-Computational Dosimetry, P1528/D1.2 (Recommended Practice for Determining the Peak Spatial-Average Specific Absorption Rate (SAR) in the Human Head from Wireless Communications Devices: Measurement Techniques), a new algorithm has been implemented. The spatial-peak SAR can be computed over any required mass.

The base for the evaluation is a "cube" measurement. The measured volume must include the 1g and 10g cubes with the highest averaged SAR values. For that purpose, the center of the measured volume is aligned to the interpolated peak SAR value of a previously performed area scan.



The entire evaluation of the spatial peak values is performed within the postprocessing engine (SEMCAD). The system always gives the maximum values for the 1g and 10g cubes. The algorithm to find the cube with highest averaged SAR is divided into the following stages:

- extraction of the measured data (grid and values) from the Zoom Scan
- calculation of the SAR value at every measurement point based on all stored data (A/D values and measurement parameters)
- generation of a high-resolution mesh within the measured volume
- interpolation of all measured values from the measurement grid to the high-resolution grid
- extrapolation of the entire 3-D field distribution to the phantom surface over the distance from sensor to surface
- calculation of the averaged SAR within masses of 1g and 10g

### **10.2 Scan Procedures**

First Area Scan is used to locate the approximate location(s) of the local peak SAR value(s). The measurement grid within an Area Scan is defined by the grid extent, grid step size and grid offset. Next, in order to determine the EM field distribution in a three-dimensional spatial extension, Zoom Scan is required. The Zoom Scan measures 5x5x7 points with step size 8, 8 and 5 mm. The Zoom Scan is performed around the highest E-field value to determine the averaged SAR-distribution over 1 g.

### **10.3 SAR Averaged Methods**

In DASY4, the interpolation and extrapolation are both based on the modified Quadratic Shepard's method. The interpolation scheme combines a least-square fitted function method and a weighted average method which are the two basic types of computational interpolation and approximation.

Extrapolation routines are used to obtain SAR values between the lowest measurement points and the inner phantom surface. The extrapolation distance is determined by the surface detection distance and the probe sensor offset. The uncertainty increases with the extrapolation distance. To keep the uncertainty within 1% for the 1 g and 10 g cubes, the extrapolation distance should not be larger than 5 mm.



### 11. SAR Test Results

#### 11.1 Dell D400 Notebook Bottom Touch

| Mode                | Chan. | Freq (MHz) | Modulation type | Conducted Power (dBm) | Power Drift (dB) | Measured 1g SAR (W/kg) | Limits (W/Kg) | Results |
|---------------------|-------|------------|-----------------|-----------------------|------------------|------------------------|---------------|---------|
| 802.11b             | 1     | 2412(Low)  | CCK             | 17.60                 | -                | -                      | -             | -       |
|                     | 6     | 2437(Mid)  | CCK             | 17.35                 | -0.042           | 0.449                  | 1.6           | Pass    |
|                     | 11    | 2462(High) | CCK             | 17.92                 | -                | -                      | -             | -       |
| 802.11g             | 1     | 2412(Low)  | OFDM            | 15.04                 | -0.134           | 0.307                  | 1.6           | Pass    |
|                     | 6     | 2437(Mid)  | OFDM            | 17.55                 | -0.048           | 0.454                  | 1.6           | Pass    |
|                     | 11    | 2462(High) | OFDM            | 16.76                 | -0.109           | 0.303                  | 1.6           | Pass    |
| 802.11n<br>(BW 20M) | 1     | 2412(Low)  | OFDM            | 15.27                 | -                | -                      | -             | -       |
|                     | 6     | 2437(Mid)  | OFDM            | 17.53                 | 0.055            | 0.416                  | 1.6           | Pass    |
|                     | 11    | 2462(High) | OFDM            | 16.59                 | -                | -                      | -             | -       |
| 802.11n<br>(BW 40M) | 3     | 2422(Low)  | OFDM            | 14.95                 | -                | -                      | -             | -       |
|                     | 6     | 2437(Mid)  | OFDM            | 17.98                 | -0.055           | 0.419                  | 1.6           | Pass    |
|                     | 9     | 2452(High) | OFDM            | 15.84                 | -                | -                      | -             | -       |

#### 11.2 Dell D500 Notebook Bottom Touch

| Mode                | Chan. | Freq (MHz) | Modulation type | Conducted Power (dBm) | Power Drift (dB) | Measured 1g SAR (W/kg) | Limits (W/Kg) | Results |
|---------------------|-------|------------|-----------------|-----------------------|------------------|------------------------|---------------|---------|
| 802.11b             | 1     | 2412(Low)  | CCK             | 17.60                 | -                | -                      | -             | -       |
|                     | 6     | 2437(Mid)  | CCK             | 17.35                 | -                | -                      | -             | -       |
|                     | 11    | 2462(High) | CCK             | 17.92                 | -                | -                      | -             | -       |
| 802.11g             | 1     | 2412(Low)  | OFDM            | 15.04                 | -                | -                      | -             | -       |
|                     | 6     | 2437(Mid)  | OFDM            | 17.55                 | -0.084           | 0.149                  | 1.6           | Pass    |
|                     | 11    | 2462(High) | OFDM            | 16.76                 | -                | -                      | -             | -       |
| 802.11n<br>(BW 20M) | 1     | 2412(Low)  | OFDM            | 15.27                 | -                | -                      | -             | -       |
|                     | 6     | 2437(Mid)  | OFDM            | 17.53                 | -                | -                      | -             | -       |
|                     | 11    | 2462(High) | OFDM            | 16.59                 | -                | -                      | -             | -       |
| 802.11n<br>(BW 40M) | 3     | 2422(Low)  | OFDM            | 14.95                 | -                | -                      | -             | -       |
|                     | 6     | 2437(Mid)  | OFDM            | 17.98                 | -                | -                      | -             | -       |
|                     | 9     | 2452(High) | OFDM            | 15.84                 | -                | -                      | -             | -       |

#### 11.3 Dell M2300 Notebook Bottom Touch

| Mode                | Chan. | Freq (MHz) | Modulation type | Conducted Power (dBm) | Power Drift (dB) | Measured 1g SAR (W/kg) | Limits (W/Kg) | Results |
|---------------------|-------|------------|-----------------|-----------------------|------------------|------------------------|---------------|---------|
| 802.11b             | 1     | 2412(Low)  | CCK             | 17.60                 | -                | -                      | -             | -       |
|                     | 6     | 2437(Mid)  | CCK             | 17.35                 | -                | -                      | -             | -       |
|                     | 11    | 2462(High) | CCK             | 17.92                 | -                | -                      | -             | -       |
| 802.11g             | 1     | 2412(Low)  | OFDM            | 15.04                 | -                | -                      | -             | -       |
|                     | 6     | 2437(Mid)  | OFDM            | 17.55                 | -0.125           | 0.099                  | 1.6           | Pass    |
|                     | 11    | 2462(High) | OFDM            | 16.76                 | -                | -                      | -             | -       |
| 802.11n<br>(BW 20M) | 1     | 2412(Low)  | OFDM            | 15.27                 | -                | -                      | -             | -       |
|                     | 6     | 2437(Mid)  | OFDM            | 17.53                 | -                | -                      | -             | -       |
|                     | 11    | 2462(High) | OFDM            | 16.59                 | -                | -                      | -             | -       |
| 802.11n<br>(BW 40M) | 3     | 2422(Low)  | OFDM            | 14.95                 | -                | -                      | -             | -       |
|                     | 6     | 2437(Mid)  | OFDM            | 17.98                 | -                | -                      | -             | -       |
|                     | 9     | 2452(High) | OFDM            | 15.84                 | -                | -                      | -             | -       |

Test Engineer : Jason Wang



## **12. Reference**

- [1] FCC 47 CFR Part 2 “Frequency Allocations and Radio Treaty Matters; General Rules and Regulations”
- [2] IEEE Std. P1528-2003, “Recommended Practice for Determining the Peak Spatial-Average Specific Absorption Rate (SAR) in the Human Head from Wireless Communications Devices: Measurement Techniques”, April 21,2003.
- [3] Supplement C (Edition 01-01) to OET Bulletin 65 (Edition 97-01), “Additional Information for Evaluating Compliance of Mobile and Portable Devices with FCC Limits for Human Exposure to RF Emissions”, June 2001
- [4] IEEE Std. C95.3-2002, “IEEE Recommended Practice for the Measurement of Potentially Hazardous Electromagnetic Fields-RF and Microwave”, 2002
- [5] IEEE Std. C95.1-1999, “IEEE Standard for Safety Levels with Respect to Human Exposure to Radio Frequency Electromagnetic Fields, 3 kHz to 300 GHz”, 1999
- [6] Robert J. Renka, “Multivariate Interpolation Of Large Sets Of Scattered Data”, University of North Texas ACM Transactions on Mathematical Software, vol. 14, no. 2, June 1988, pp. 139-148
- [7] DAYS4 System Handbook



### Appendix A - System Performance Check Data

Test Laboratory: Sporton International Inc. SAR Testing Lab

Date : 2007/9/14

#### System Check\_Body\_2450MHz

##### DUT: Dipole 2450 MHz

Communication System: CW; Frequency: 2450 MHz; Duty Cycle: 1:1

Medium: MSL\_2450 Medium parameters used:  $f = 2450$  MHz;  $\sigma = 1.97$  mho/m;  $\epsilon_r = 53$ ;  $\rho = 1000$  kg/m<sup>3</sup>

Ambient Temperature : 22.9 °C; Liquid Temperature : 21.5 °C

##### DASY4 Configuration:

- Probe: ET3DV6 - SN1787; ConvF(4.02, 4.02, 4.02); Calibrated: 2007/8/28
- Sensor-Surface: 4mm (Mechanical And Optical Surface Detection) Sensor-Surface: 4mm (Mechanical Surface Detection)
- Electronics: DAE3 Sn577; Calibrated: 2006/11/21
- Phantom: SAM-B; Type: QD 000 P40 C; Serial: TP-1383
- Measurement SW: DASY4, V4.7 Build 53; Postprocessing SW: SEMCAD, V1.8 Build 172

**Pin=100mW/Area Scan (91x91x1):** Measurement grid: dx=10mm, dy=10mm

Maximum value of SAR (interpolated) = 6.22 mW/g

**Pin=100mW/Zoom Scan (7x7x7)/Cube 0:** Measurement grid: dx=5mm, dy=5mm, dz=5mm

Reference Value = 58.4 V/m; Power Drift = 0.007 dB

Peak SAR (extrapolated) = 11.3 W/kg

**SAR(1 g) = 5.31 mW/g; SAR(10 g) = 2.52 mW/g**

Maximum value of SAR (measured) = 5.97 mW/g

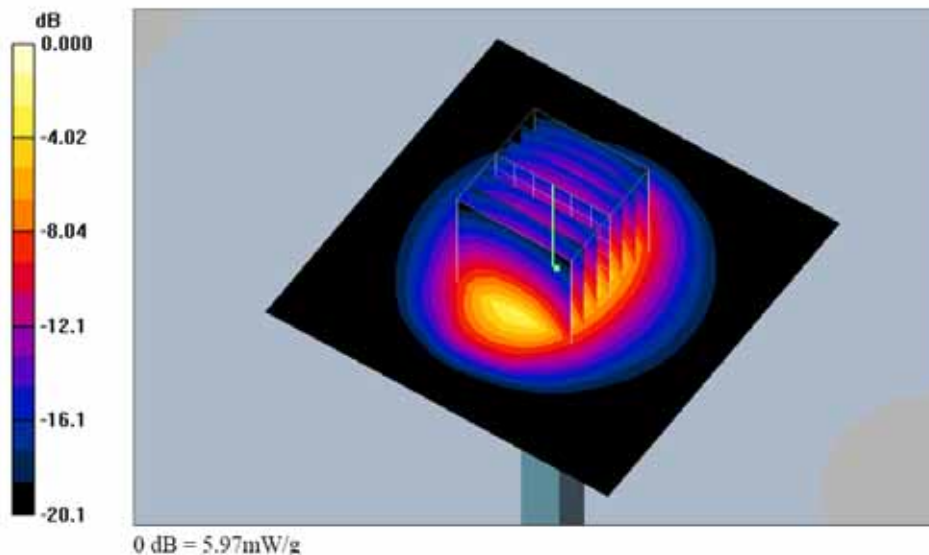





### Appendix B - SAR Measurement Data

Test Laboratory: Sporton International Inc. SAR Testing Lab

Date: 2007/9/14

**Body\_802.11b Ch6\_Notebook Bottom Touch\_Dell D400\_BW20M**

**DUT: 790504**

Communication System: 802.11b ; Frequency: 2437 MHz;Duty Cycle: 1:1

Medium: MSL\_2450 Medium parameters used:  $f = 2437$  MHz;  $\sigma = 1.95$  mho/m;  $\epsilon_r = 53$ ;  $\rho = 1000$  kg/m<sup>3</sup>

Ambient Temperature : 22.9 °C ; Liquid Temperature : 21.5 °C

DASY4 Configuration:

- Probe: ET3DV6 - SN1787; ConvF(4.02, 4.02, 4.02); Calibrated: 2007/8/28
- Sensor-Surface: 4mm (Mechanical Surface Detection)
- Electronics: DAE3 Sn577; Calibrated: 2006/11/21
- Phantom: SAM-B; Type: QD 000 P40 C; Serial: TP-1383
- Measurement SW: DASY4, V4.7 Build 53; Postprocessing SW: SEMCAD, V1.8 Build 172

**Ch6/Area Scan (61x51x1):** Measurement grid: dx=15mm, dy=15mm

Maximum value of SAR (interpolated) = 0.499 mW/g

**Ch6/Zoom Scan (5x5x7)/Cube 0:** Measurement grid: dx=8mm, dy=8mm, dz=5mm

Reference Value = 11.7 V/m; Power Drift = -0.042 dB

Peak SAR (extrapolated) = 0.898 W/kg

**SAR(1 g) = 0.449 mW/g; SAR(10 g) = 0.238 mW/g**

Maximum value of SAR (measured) = 0.480 mW/g

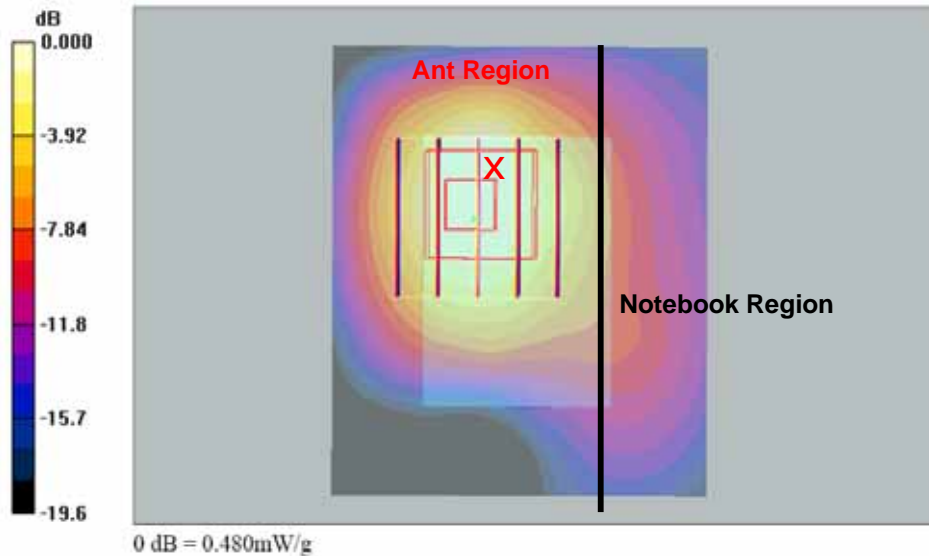



Test Laboratory: Sporton International Inc. SAR Testing Lab

Date : 2007/9/14

**Body\_802.11g Ch6\_Notebook Bottom Touch\_Dell D400\_BW20M**

**DUT: 790504**

Communication System: 802.11g; Frequency: 2437 MHz; Duty Cycle: 1:1

Medium: MSL\_2450 Medium parameters used:  $f = 2437$  MHz;  $\sigma = 1.95$  mho/m;  $\epsilon_r = 53$ ;  $\rho = 1000$  kg/m<sup>3</sup>

Ambient Temperature : 22.9 °C; Liquid Temperature : 21.5 °C

DASY4 Configuration:

- Probe: ET3DV6 - SN1787; ConvF(4.02, 4.02, 4.02); Calibrated: 2007/8/28
- Sensor-Surface: 4mm (Mechanical Surface Detection)
- Electronics: DAE3 Sn577; Calibrated: 2006/11/21
- Phantom: SAM-B; Type: QD 000 P40 C; Serial: TP-1383
- Measurement SW: DASY4, V4.7 Build 53; Postprocessing SW: SEMCAD, V1.8 Build 172

**Ch6/Area Scan (61x51x1):** Measurement grid: dx=15mm, dy=15mm

Maximum value of SAR (interpolated) = 0.509 mW/g

**Ch6/Zoom Scan (5x5x7)/Cube 0:** Measurement grid: dx=8mm, dy=8mm, dz=5mm

Reference Value = 11.1 V/m; Power Drift = -0.048 dB

Peak SAR (extrapolated) = 0.937 W/kg

**SAR(1 g) = 0.454 mW/g; SAR(10 g) = 0.237 mW/g**

Maximum value of SAR (measured) = 0.489 mW/g

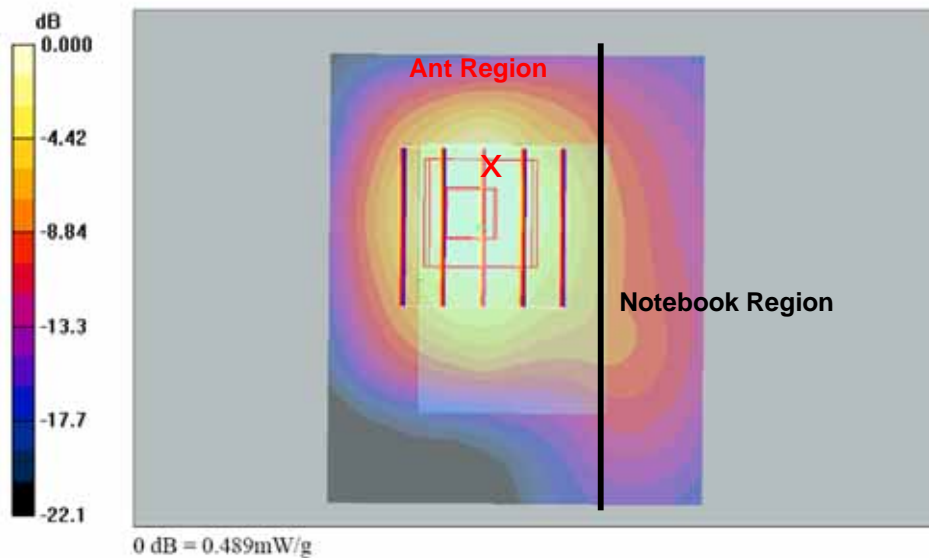



Test Laboratory: Sporton International Inc. SAR Testing Lab

Date : 2007/9/14

**Body\_802.11n\_Ch6\_Notebook Bottom Touch\_Dell D400\_BW20M**

**DUT: 790504**

Communication System: 802.11n; Frequency: 2437 MHz; Duty Cycle: 1:1

Medium: MSL\_2450 Medium parameters used:  $f = 2437$  MHz;  $\sigma = 1.95$  mho/m;  $\epsilon_r = 53$ ;  $\rho = 1000$  kg/m<sup>3</sup>

Ambient Temperature : 22.9 °C; Liquid Temperature : 21.5 °C

DASY4 Configuration:

- Probe: ET3DV6 - SN1787; ConvF(4.02, 4.02, 4.02); Calibrated: 2007/8/28
- Sensor-Surface: 4mm (Mechanical Surface Detection)
- Electronics: DAE3 Sn577; Calibrated: 2006/11/21
- Phantom: SAM-B; Type: QD 000 P40 C; Serial: TP-1383
- Measurement SW: DASY4, V4.7 Build 53; Postprocessing SW: SEMCAD, V1.8 Build 172

**Ch6/Area Scan (61x51x1):** Measurement grid: dx=15mm, dy=15mm

Maximum value of SAR (interpolated) = 0.467 mW/g

**Ch6/Zoom Scan (5x5x7)/Cube 0:** Measurement grid: dx=8mm, dy=8mm, dz=5mm

Reference Value = 11.0 V/m; Power Drift = 0.055 dB

Peak SAR (extrapolated) = 0.839 W/kg

**SAR(1 g) = 0.416 mW/g; SAR(10 g) = 0.219 mW/g**

Maximum value of SAR (measured) = 0.448 mW/g

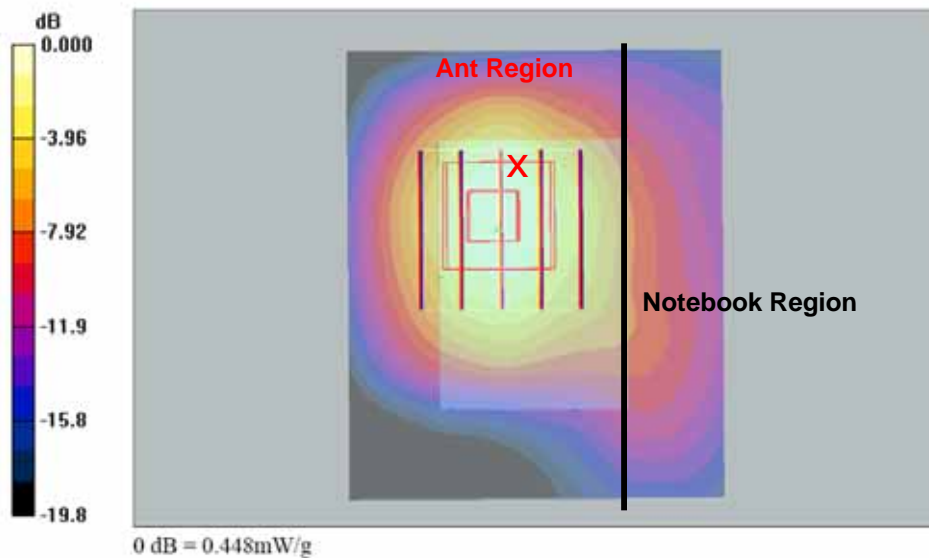



Test Laboratory: Sporton International Inc. SAR Testing Lab

Date : 2007/9/14

**Body\_802.11n Ch6\_Notebook Bottom Touch\_Dell D400\_BW20M\_BW40M**

**DUT: 790504**

Communication System: 802.11n; Frequency: 2437 MHz; Duty Cycle: 1:1

Medium: MSL\_2450 Medium parameters used:  $f = 2437$  MHz;  $\sigma = 1.95$  mho/m;  $\epsilon_r = 53$ ;  $\rho = 1000$  kg/m<sup>3</sup>

Ambient Temperature : 22.9 °C; Liquid Temperature : 21.5 °C

DASY4 Configuration:

- Probe: ET3DV6 - SN1787; ConvF(4.02, 4.02, 4.02); Calibrated: 2007/8/28
- Sensor-Surface: 4mm (Mechanical Surface Detection)
- Electronics: DAE3 Sn577; Calibrated: 2006/11/21
- Phantom: SAM-B; Type: QD 000 P40 C; Serial: TP-1383
- Measurement SW: DASY4, V4.7 Build 53; Postprocessing SW: SEMCAD, V1.8 Build 172

**Ch6/Area Scan (61x51x1):** Measurement grid: dx=15mm, dy=15mm

Maximum value of SAR (interpolated) = 0.463 mW/g

**Ch6/Zoom Scan (5x5x7)/Cube 0:** Measurement grid: dx=8mm, dy=8mm, dz=5mm

Reference Value = 10.9 V/m; Power Drift = -0.055 dB

Peak SAR (extrapolated) = 0.849 W/kg

**SAR(1 g) = 0.419 mW/g; SAR(10 g) = 0.219 mW/g**

Maximum value of SAR (measured) = 0.446 mW/g

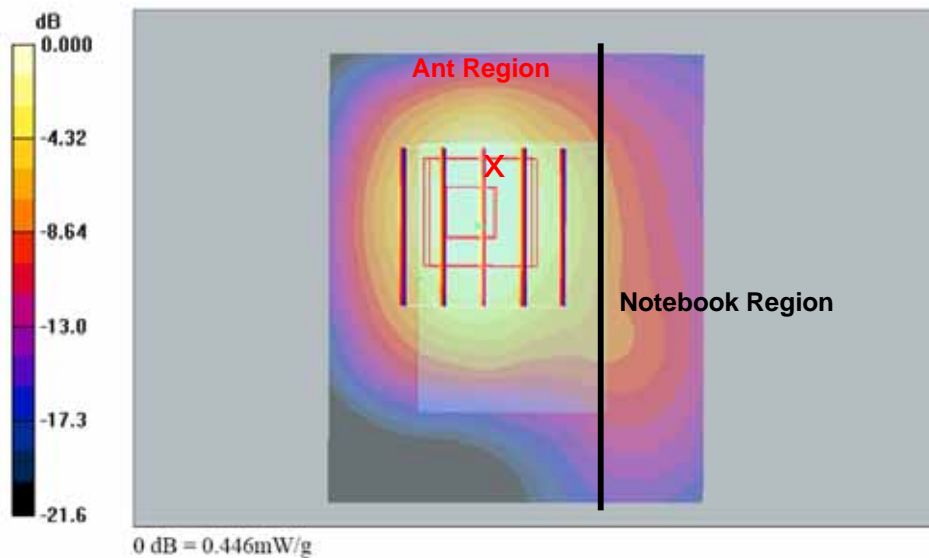



Test Laboratory: Sporton International Inc. SAR Testing Lab

Date: 2007/9/14

**Body\_802.11g Ch6\_Notebook Bottom Touch\_Dell D500\_BW20M**

**DUT: 790504**

Communication System: 802.11g; Frequency: 2437 MHz; Duty Cycle: 1:1

Medium: MSL\_2450 Medium parameters used:  $f = 2437$  MHz;  $\sigma = 1.95$  mho/m;  $\epsilon_r = 53$ ;  $\rho = 1000$  kg/m<sup>3</sup>

Ambient Temperature : 22.9 °C; Liquid Temperature : 21.5 °C

DASY4 Configuration:

- Probe: ET3DV6 - SN1787; ConvF(4.02, 4.02, 4.02); Calibrated: 2007/8/28
- Sensor-Surface: 4mm (Mechanical Surface Detection)
- Electronics: DAE3 Sn577; Calibrated: 2006/11/21
- Phantom: SAM-B; Type: QD 000 P40 C; Serial: TP-1383
- Measurement SW: DASY4, V4.7 Build 53; Postprocessing SW: SEMCAD, V1.8 Build 172

**Ch6/Area Scan (61x51x1):** Measurement grid: dx=15mm, dy=15mm

Maximum value of SAR (interpolated) = 0.179 mW/g

**Ch6/Zoom Scan (5x5x7)/Cube 0:** Measurement grid: dx=8mm, dy=8mm, dz=5mm

Reference Value = 7.84 V/m; Power Drift = -0.084 dB

Peak SAR (extrapolated) = 0.278 W/kg

**SAR(1 g) = 0.149 mW/g; SAR(10 g) = 0.084 mW/g**

Maximum value of SAR (measured) = 0.160 mW/g

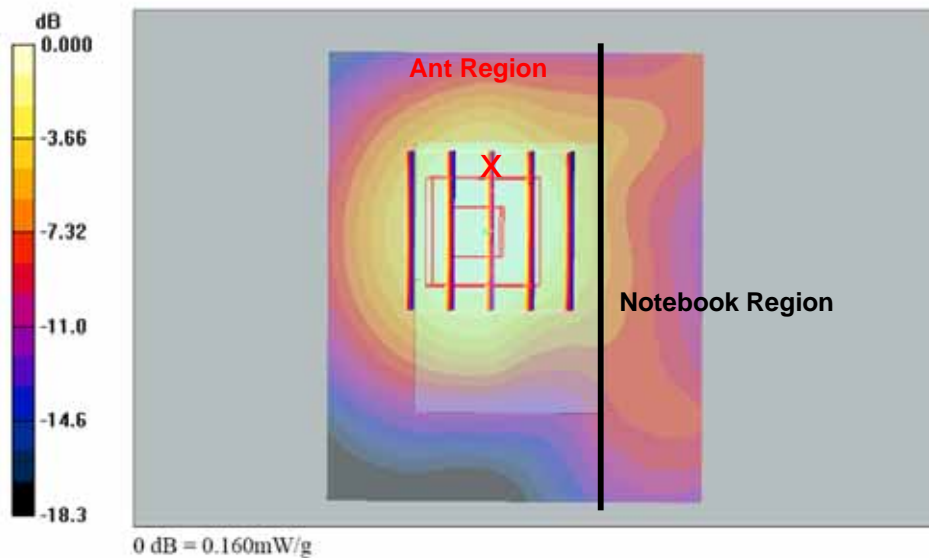



Test Laboratory: Sporton International Inc. SAR Testing Lab

Date : 2007/9/14

**Body\_802.11g Ch6\_Notebook Bottom Touch\_Dell M2300\_BW20M**

**DUT: 790504**

Communication System: 802.11g; Frequency: 2437 MHz; Duty Cycle: 1:1

Medium: MSL\_2450 Medium parameters used:  $f = 2437$  MHz;  $\sigma = 1.95$  mho/m;  $\epsilon_r = 53$ ;  $\rho = 1000$  kg/m<sup>3</sup>

Ambient Temperature : 22.9 °C; Liquid Temperature : 21.5 °C

DASY4 Configuration:

- Probe: ET3DV6 - SN1787; ConvF(4.02, 4.02, 4.02); Calibrated: 2007/8/28
- Sensor-Surface: 4mm (Mechanical Surface Detection)
- Electronics: DAE3 Sn577; Calibrated: 2006/11/21
- Phantom: SAM-B; Type: QD 000 P40 C; Serial: TP-1383
- Measurement SW: DASY4, V4.7 Build 53; Postprocessing SW: SEMCAD, V1.8 Build 172

**Ch6/Area Scan (61x51x1):** Measurement grid: dx=15mm, dy=15mm

Maximum value of SAR (interpolated) = 0.115 mW/g

**Ch6/Zoom Scan (5x5x7)/Cube 0:** Measurement grid: dx=8mm, dy=8mm, dz=5mm

Reference Value = 6.82 V/m; Power Drift = -0.125 dB

Peak SAR (extrapolated) = 0.184 W/kg

SAR(1 g) = 0.099 mW/g; SAR(10 g) = 0.057 mW/g

Maximum value of SAR (measured) = 0.108 mW/g

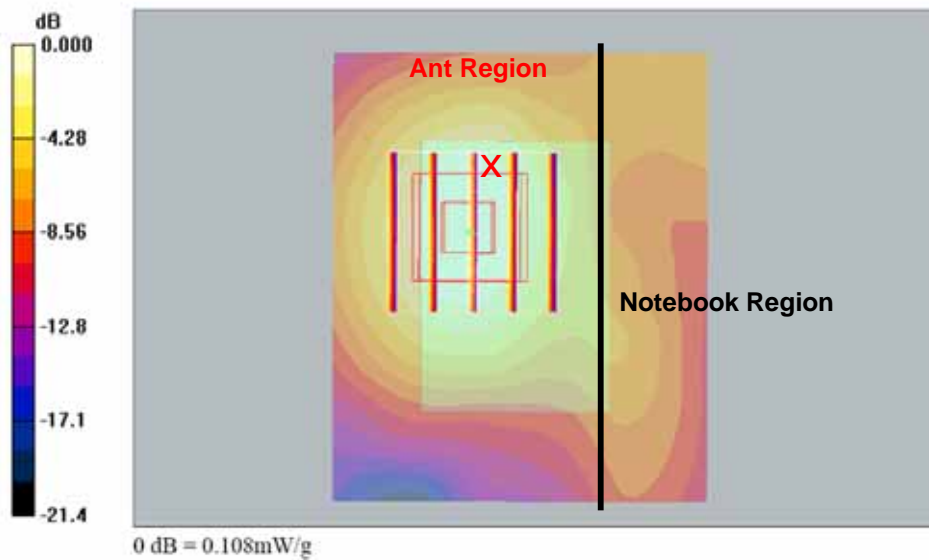



Test Laboratory: Sporton International Inc. SAR Testing Lab

Date: 2007/9/14

**Body\_802.11g\_Ch6\_Notebook Bottom Touch\_Dell D400\_BW20M\_2D**

**DUT: 790504**

Communication System: 802.11g; Frequency: 2437 MHz; Duty Cycle: 1:1

Medium: MSL\_2450 Medium parameters used:  $f = 2437$  MHz;  $\sigma = 1.95$  mho/m;  $\epsilon_r = 53$ ;  $\rho = 1000$  kg/m<sup>3</sup>

Ambient Temperature : 22.9 °C; Liquid Temperature : 21.5 °C

DASY4 Configuration:

- Probe: ET3DV6 - SN1787; ConvF(4.02, 4.02, 4.02); Calibrated: 2007/8/28
- Sensor-Surface: 4mm (Mechanical Surface Detection)
- Electronics: DAE3 Sn577; Calibrated: 2006/11/21
- Phantom: SAM-B; Type: QD 000 P40 C; Serial: TP-1383
- Measurement SW: DASY4, V4.7 Build 53; Postprocessing SW: SEMCAD, V1.8 Build 172

**Ch6/Area Scan (61x51x1):** Measurement grid: dx=15mm, dy=15mm

Maximum value of SAR (interpolated) = 0.509 mW/g

**Ch6/Zoom Scan (5x5x7)/Cube 0:** Measurement grid: dx=8mm, dy=8mm, dz=5mm

Reference Value = 11.1 V/m; Power Drift = -0.048 dB

Peak SAR (extrapolated) = 0.937 W/kg

**SAR(1 g) = 0.454 mW/g; SAR(10 g) = 0.237 mW/g**

Maximum value of SAR (measured) = 0.489 mW/g

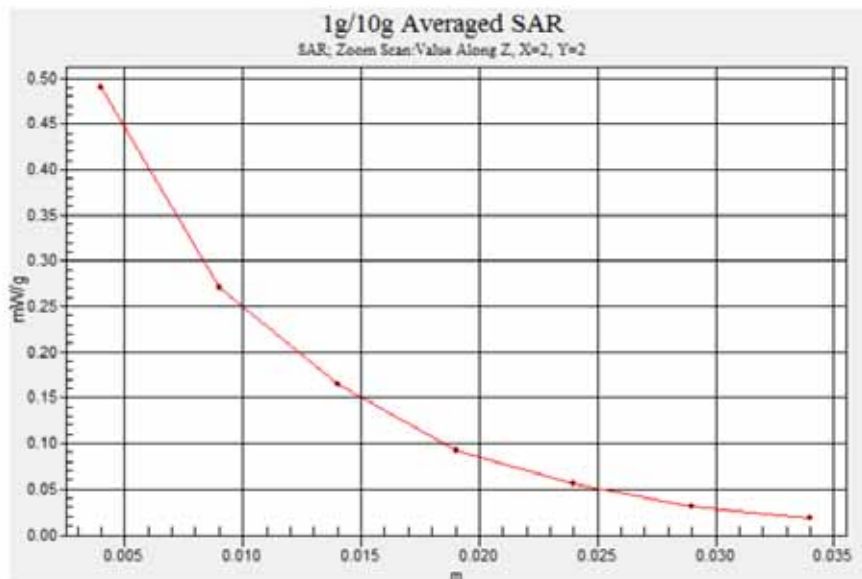



Appendix C – Calibration Data

Calibration Laboratory of Schmid & Partner Engineering AG



S Schweizerischer Kalibrierdienst
C Service suisse d'etalonnage
S Servizio svizzero di taratura
S Swiss Calibration Service

Accredited by the Swiss Federal Office of Metrology and Accreditation
The Swiss Accreditation Service is one of the signatories to the EA Multilateral Agreement for the recognition of calibration certificates

Accreditation No.: SCS 108

Client Sporton (Auden)

Certificate No: D2450V2-736\_Jul07

CALIBRATION CERTIFICATE

Object: D2450V2 - SN: 736
Calibration procedure(s): QA CAL-05.v6
Calibration procedure for dipole validation kits
Calibration date: July 12, 2007
Condition of the calibrated item: In Tolerance

This calibration certificate documents the traceability to national standards, which realize the physical units of measurements (SI).
The measurements and the uncertainties with confidence probability are given on the following pages and are part of the certificate.

All calibrations have been conducted in the closed laboratory facility; environment temperature (22 ± 3)°C and humidity < 70%.

Calibration Equipment used (M&TE critical for calibration)

Table with 4 columns: Primary Standards, ID #, Cal Date (Calibrated by, Certificate No.), Scheduled Calibration. Lists various power meters, sensors, and attenuators with their respective IDs and calibration dates.

Calibrated by: Mika Mell (Laboratory Technician)
Approved by: Katja Pokovic (Technical Manager)
Signature: [Handwritten signatures]
Issued: July 12, 2007





Calibration Laboratory of  
Schmid & Partner  
Engineering AG  
Zeughausstrasse 43, 8004 Zurich, Switzerland



S Schweizerischer Kalibrierdienst  
C Service suisse d'étalonnage  
S Servizio svizzero di taratura  
S Swiss Calibration Service

Accredited by the Swiss Federal Office of Metrology and Accreditation  
The Swiss Accreditation Service is one of the signatories to the EA  
Multilateral Agreement for the recognition of calibration certificates

Accreditation No.: SCS 108

**Glossary:**

TSL tissue simulating liquid  
ConvF sensitivity in TSL / NORM x,y,z  
N/A not applicable or not measured

**Calibration is Performed According to the Following Standards:**

- a) IEEE Std 1528-2003, "IEEE Recommended Practice for Determining the Peak Spatial-Averaged Specific Absorption Rate (SAR) in the Human Head from Wireless Communications Devices: Measurement Techniques", December 2003
- b) IEC 62209-1, "Procedure to measure the Specific Absorption Rate (SAR) for hand-held devices used in close proximity to the ear (frequency range of 300 MHz to 3 GHz)", February 2005
- c) Federal Communications Commission Office of Engineering & Technology (FCC OET), "Evaluating Compliance with FCC Guidelines for Human Exposure to Radiofrequency Electromagnetic Fields; Additional Information for Evaluating Compliance of Mobile and Portable Devices with FCC Limits for Human Exposure to Radiofrequency Emissions", Supplement C (Edition 01-01) to Bulletin 65

**Additional Documentation:**

- d) DASY4 System Handbook

**Methods Applied and Interpretation of Parameters:**

- *Measurement Conditions:* Further details are available from the Validation Report at the end of the certificate. All figures stated in the certificate are valid at the frequency indicated.
- *Antenna Parameters with TSL:* The dipole is mounted with the spacer to position its feed point exactly below the center marking of the flat phantom section, with the arms oriented parallel to the body axis.
- *Feed Point Impedance and Return Loss:* These parameters are measured with the dipole positioned under the liquid filled phantom. The impedance stated is transformed from the measurement at the SMA connector to the feed point. The Return Loss ensures low reflected power. No uncertainty required.
- *Electrical Delay:* One-way delay between the SMA connector and the antenna feed point. No uncertainty required.
- *SAR measured:* SAR measured at the stated antenna input power.
- *SAR normalized:* SAR as measured, normalized to an input power of 1 W at the antenna connector.
- *SAR for nominal TSL parameters:* The measured TSL parameters are used to calculate the nominal SAR result.



**Measurement Conditions**

DASY system configuration, as far as not given on page 1.

|                              |                           |             |
|------------------------------|---------------------------|-------------|
| DASY Version                 | DASY4                     | V4.7        |
| Extrapolation                | Advanced Extrapolation    |             |
| Phantom                      | Modular Flat Phantom V5.0 |             |
| Distance Dipole Center - TSL | 10 mm                     | with Spacer |
| Zoom Scan Resolution         | dx, dy, dz = 5 mm         |             |
| Frequency                    | 2450 MHz ± 1 MHz          |             |

**Head TSL parameters**

The following parameters and calculations were applied.

|                                  | Temperature     | Permittivity | Conductivity     |
|----------------------------------|-----------------|--------------|------------------|
| Nominal Head TSL parameters      | 22.0 °C         | 39.2         | 1.80 mho/m       |
| Measured Head TSL parameters     | (22.0 ± 0.2) °C | 38.6 ± 6 %   | 1.81 mho/m ± 6 % |
| Head TSL temperature during test | (22.0 ± 0.2) °C | -----        | -----            |

**SAR result with Head TSL**

| SAR averaged over 1 cm <sup>3</sup> (1 g) of Head TSL | condition          |                                   |
|---|--------------------|-----------------------------------|
| SAR measured  | 250 mW input power | 13.3 mW / g                       |
| SAR normalized  | normalized to 1W   | 53.2 mW / g                       |
| SAR for nominal Head TSL parameters <sup>1</sup>      | normalized to 1W   | <b>52.7 mW / g ± 17.0 % (k=2)</b> |

| SAR averaged over 10 cm <sup>3</sup> (10 g) of Head TSL | condition          |                                   |
|---|--------------------|-----------------------------------|
| SAR measured  | 250 mW input power | 6.17 mW / g                       |
| SAR normalized  | normalized to 1W   | 24.7 mW / g                       |
| SAR for nominal Head TSL parameters <sup>1</sup>        | normalized to 1W   | <b>24.5 mW / g ± 16.5 % (k=2)</b> |

<sup>1</sup> Correction to nominal TSL parameters according to d), chapter "SAR Sensitivities"



Body TSL parameters

The following parameters and calculations were applied.

|                                  | Temperature     | Permittivity | Conductivity     |
|----------------------------------|-----------------|--------------|------------------|
| Nominal Body TSL parameters      | 22.0 °C         | 52.7         | 1.95 mho/m       |
| Measured Body TSL parameters     | (22.0 ± 0.2) °C | 53.5 ± 6 %   | 1.94 mho/m ± 6 % |
| Body TSL temperature during test | (22.0 ± 0.2) °C | -----        | -----            |

SAR result with Body TSL

| SAR averaged over 1 cm <sup>3</sup> (1 g) of Body TSL | Condition          |                                   |
|---|--------------------|-----------------------------------|
| SAR measured  | 250 mW input power | 13.0 mW / g                       |
| SAR normalized  | normalized to 1W   | 62.0 mW / g                       |
| SAR for nominal Body TSL parameters <sup>2</sup>      | normalized to 1W   | <b>52.5 mW / g ± 17.0 % (k=2)</b> |

| SAR averaged over 10 cm <sup>3</sup> (10 g) of Body TSL | Condition          |                                   |
|---|--------------------|-----------------------------------|
| SAR measured  | 250 mW input power | 6.05 mW / g                       |
| SAR normalized  | normalized to 1W   | 24.2 mW / g                       |
| SAR for nominal Body TSL parameters <sup>2</sup>        | normalized to 1W   | <b>24.4 mW / g ± 15.5 % (k=2)</b> |

<sup>2</sup> Correction to nominal TSL parameters according to d), chapter "SAR Sensitivities"



**Appendix**

**Antenna Parameters with Head TSL**

|                                      |                             |
|--------------------------------------|-----------------------------|
| Impedance, transformed to feed point | $53.1 \Omega + 3.0 j\Omega$ |
| Return Loss                          | - 27.6 dB                   |

**Antenna Parameters with Body TSL**

|                                      |                             |
|--------------------------------------|-----------------------------|
| Impedance, transformed to feed point | $48.7 \Omega + 4.6 j\Omega$ |
| Return Loss                          | - 26.3 dB                   |

**General Antenna Parameters and Design**

|                                  |          |
|----------------------------------|----------|
| Electrical Delay (one direction) | 1.158 ns |
|----------------------------------|----------|

After long term use with 100W radiated power, only a slight warming of the dipole near the feedpoint can be measured.

The dipole is made of standard semirigid coaxial cable. The center conductor of the feeding line is directly connected to the second arm of the dipole. The antenna is therefore short-circuited for DC-signals.  
No excessive force must be applied to the dipole arms, because they might bend or the soldered connections near the feedpoint may be damaged.

**Additional EUT Data**

|                 |                 |
|-----------------|-----------------|
| Manufactured by | SPEAG           |
| Manufactured on | August 26, 2003 |



DASY4 Validation Report for Head TSL

Date/Time: 12.07.2007 11:00:03

Test Laboratory: SPEAG, Zurich, Switzerland

DUT: Dipole 2450 MHz; Type: D2450V2; Serial: D2450V2 - SN736

Communication System: CW-2450; Frequency: 2450 MHz; Duty Cycle: 1:1

Medium: HSL U10 BB;

Medium parameters used:  $f = 2450$  MHz;  $\sigma = 1.81$  mho/m;  $\epsilon_r = 38.6$ ;  $\rho = 1000$  kg/m<sup>3</sup>

Phantom section: Flat Section

Measurement Standard: DASY4 (High Precision Assessment)

DASY4 Configuration:

- Probe: ES3DV2 - SN3025 (HF); ConvP(4.5, 4.5, 4.5); Calibrated: 19.10.2006
- Sensor-Surface: 4mm (Mechanical Surface Detection)
- Electronics: DAE4 Sn601; Calibrated: 30.01.2007
- Phantom: Flat Phantom 5.0 (front); Type: QD000P50AA
- Measurement SW: DASY4, V4.7 Build 53; Postprocessing SW: SEMCAD, V1.8 Build 172

Pin = 250 mW; d = 10 mm/Zoom Scan (7x7x7)/Cube 0:

Measurement grid: dx=5mm, dy=5mm, dz=5mm

Reference Value = 93.0 V/m; Power Drift = -0.004 dB

Peak SAR (extrapolated) = 28.1 W/kg

SAR(1 g) = 13.3 mW/g; SAR(10 g) = 6.17 mW/g

Maximum value of SAR (measured) = 15.0 mW/g

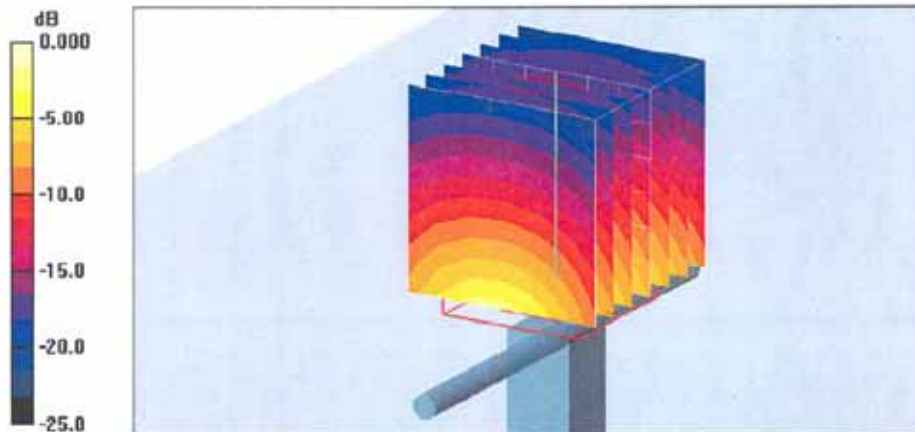

0 dB = 15.0mW/g



Impedance Measurement Plot for Head TSL

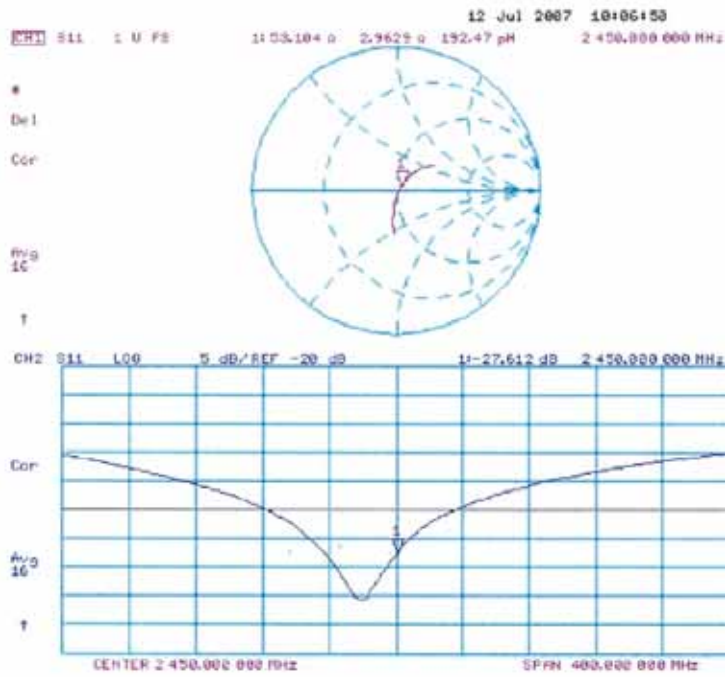



DASY4 Validation Report for Body TSL

Date/Time: 12.07.2007 12:28:49

Test Laboratory: SPEAG, Zurich, Switzerland

DUT: Dipole 2450 MHz; Type: D2450V2; Serial: D2450V2 - SN736

Communication System: CW-2450; Frequency: 2450 MHz; Duty Cycle: 1:1

Medium: MSL U10 BB;

Medium parameters used:  $f = 2450$  MHz;  $\sigma = 1.94$  mho/m;  $\epsilon_r = 53.5$ ;  $\rho = 1000$  kg/m<sup>3</sup>

Phantom section: Flat Section

Measurement Standard: DASY4 (High Precision Assessment)

DASY4 Configuration:

- Probe: ES3DV2 - SN3025 (JHF); ConvF(4.16, 4.16, 4.16); Calibrated: 19.10.2006
- Sensor-Surface: 4mm (Mechanical Surface Detection)
- Electronics: DAE4 Sn601; Calibrated: 30.01.2007
- Phantom: Flat Phantom 5.0 (back); Type: QD000P50AA
- Measurement SW: DASY4, V4.7 Build 53; Postprocessing SW: SEMCAD, V1.8 Build 172

Pin = 250 mW; d = 10 mm/Zoom Scan (7x7x7)/Cube 0:

Measurement grid: dx=5mm, dy=5mm, dz=5mm

Reference Value = 88.6 V/m; Power Drift = 0.005 dB

Peak SAR (extrapolated) = 27.0 W/kg

SAR(1 g) = 13 mW/g; SAR(10 g) = 6.05 mW/g

Maximum value of SAR (measured) = 14.8 mW/g

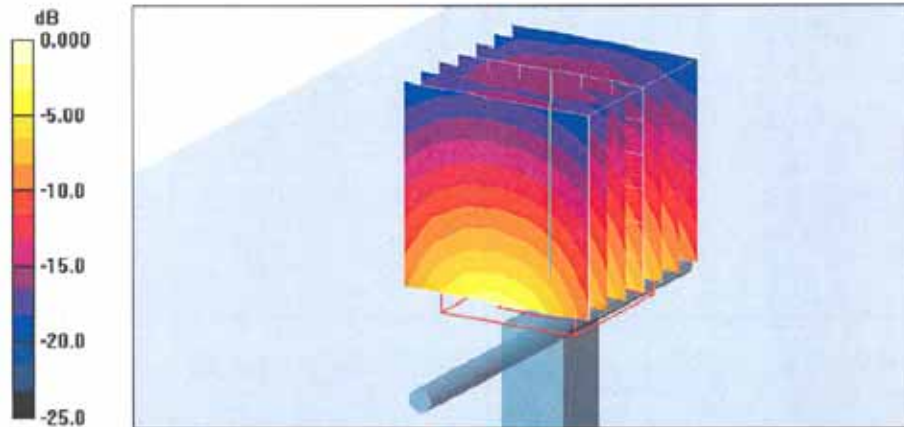



Impedance Measurement Plot for Body TSL

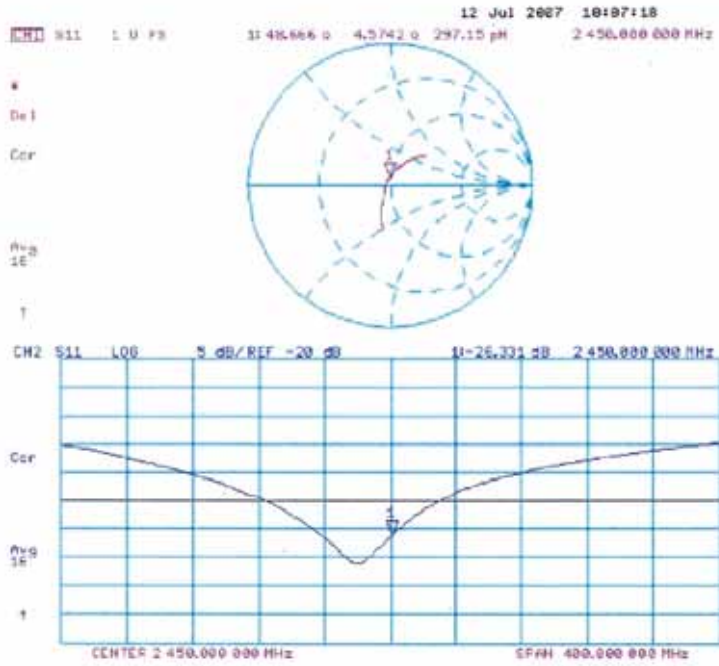





Calibration Laboratory of Schmid & Partner Engineering AG



S Schweizerischer Kalibrierdienst
C Service suisse d'étalonnage
S Servizio svizzero di taratura
S Swiss Calibration Service

Accredited by the Swiss Federal Office of Metrology and Accreditation
The Swiss Accreditation Service is one of the signatories to the EA Multilateral Agreement for the recognition of calibration certificates

Accreditation No.: SCS 108

Client Sporton (Auden)

Certificate No. ET3-1787\_Aug07

CALIBRATION CERTIFICATE

Object: ET3DV6 - SN:1787
Calibration procedure(s): QA CAL-01.v6
Calibration procedure for dosimetric E-field probes
Calibration date: August 28, 2007
Condition of the calibrated item: In Tolerance

This calibration certificate documents the traceability to national standards, which realize the physical units of measurements (SI). The measurements and the uncertainties with confidence probability are given on the following pages and are part of the certificate.

All calibrations have been conducted in the closed laboratory facility, environment temperature (22 ± 3)°C and humidity < 70%.

Calibration Equipment used (M&TC critical for calibration)

Table with 4 columns: Primary Standards, ID #, Cal Date (Calibrated by, Certificate No.), Scheduled Calibration. Lists various power meters, sensors, attenuators, and probes with their respective IDs and calibration dates.

Table with 4 columns: Secondary Standards, ID #, Check Date (in house), Scheduled Check. Lists RF generator and Network Analyzer with their IDs and check dates.

Calibrated by: Katja Pokovic, Technical Manager
Approved by: Niko Kuster, Quality Manager

Handwritten signatures of Katja Pokovic and Niko Kuster.

Issued August 29, 2007

This calibration certificate shall not be reproduced except in full without written approval of the laboratory



Calibration Laboratory of Schmid & Partner Engineering AG Zeughausstrasse 43, 8004 Zurich, Switzerland



S Schweizerischer Kalibrierdienst
C Service suisse d'etalonnage
S Servizio svizzero di taratura
S Swiss Calibration Service

Accredited by the Swiss Federal Office of Metrology and Accreditation
The Swiss Accreditation Service is one of the signatories to the EA
Multilateral Agreement for the recognition of calibration certificates

Accreditation No.: SCS 108

Glossary:

- TSL tissue simulating liquid
NORMx,y,z sensitivity in free space
ConF sensitivity in TSL / NORMx,y,z
DCP diode compression point
Polarization phi phi rotation around probe axis
Polarization theta theta rotation around an axis that is in the plane normal to probe axis (at measurement center), i.e., theta = 0 is normal to probe axis

Calibration is Performed According to the Following Standards:

- a) IEEE Std 1528-2003, "IEEE Recommended Practice for Determining the Peak Spatial-Averaged Specific Absorption Rate (SAR) in the Human Head from Wireless Communications Devices: Measurement Techniques", December 2003
b) IEC 62209-1, "Procedure to measure the Specific Absorption Rate (SAR) for hand-held devices used in close proximity to the ear (frequency range of 300 MHz to 3 GHz)", February 2005

Methods Applied and Interpretation of Parameters:

- NORMx,y,z: Assessed for E-field polarization theta = 0 (f <= 900 MHz in TEM-cell; f > 1800 MHz: R22 waveguide). NORMx,y,z are only intermediate values, i.e., the uncertainties of NORMx,y,z does not effect the E^2-field uncertainty inside TSL (see below ConvF).
NORM(f)x,y,z = NORMx,y,z \* frequency\_response (see Frequency Response Chart). This linearization is implemented in DASY4 software versions later than 4.2. The uncertainty of the frequency response is included in the stated uncertainty of ConvF.
DCPx,y,z: DCP are numerical linearization parameters assessed based on the data of power sweep (no uncertainty required). DCP does not depend on frequency nor media.
ConvF and Boundary Effect Parameters: Assessed in flat phantom using E-field (or Temperature Transfer Standard for f <= 800 MHz) and inside waveguide using analytical field distributions based on power measurements for f > 800 MHz. The same setups are used for assessment of the parameters applied for boundary compensation (alpha, depth) of which typical uncertainty values are given. These parameters are used in DASY4 software to improve probe accuracy close to the boundary. The sensitivity in TSL corresponds to NORMx,y,z \* ConvF whereby the uncertainty corresponds to that given for ConvF. A frequency dependent ConvF is used in DASY version 4.4 and higher which allows extending the validity from +/- 50 MHz to +/- 100 MHz.
Spherical isotropy (3D deviation from isotropy): in a field of low gradients realized using a flat phantom exposed by a patch antenna.
Sensor Offset: The sensor offset corresponds to the offset of virtual measurement center from the probe tip (on probe axis). No tolerance required.



ET3DV6 SN:1787

August 28, 2007

# Probe ET3DV6

## SN:1787

|                  |                 |
|------------------|-----------------|
| Manufactured:    | May 28, 2003    |
| Last calibrated: | May 31, 2006    |
| Recalibrated:    | August 28, 2007 |

Calibrated for DASY Systems

(Note: non-compatible with DASY2 system!)



ET3DV6 SN:1787

August 28, 2007

DASY - Parameters of Probe: ET3DV6 SN:1787

Sensitivity in Free Space<sup>A</sup>

Diode Compression<sup>B</sup>

|       |              |                 |       |       |
|-------|--------------|-----------------|-------|-------|
| NormX | 1.63 ± 10.1% | $\mu V/(V/m)^2$ | DCP X | 92 mV |
| NormY | 1.66 ± 10.1% | $\mu V/(V/m)^2$ | DCP Y | 96 mV |
| NormZ | 2.08 ± 10.1% | $\mu V/(V/m)^2$ | DCP Z | 91 mV |

Sensitivity in Tissue Simulating Liquid (Conversion Factors)

Please see Page 8.

Boundary Effect

TSL 900 MHz Typical SAR gradient: 5 % per mm

|   |                              |        |        |
|---|------------------------------|--------|--------|
| Sensor Center to Phantom Surface Distance |                              | 3.7 mm | 4.7 mm |
| SAR <sub>tip</sub> [%]                    | Without Correction Algorithm | 4.7    | 2.0    |
| SAR <sub>tip</sub> [%]                    | With Correction Algorithm    | 0.1    | 0.0    |

TSL 1810 MHz Typical SAR gradient: 10 % per mm

|   |                              |        |        |
|---|------------------------------|--------|--------|
| Sensor Center to Phantom Surface Distance |                              | 3.7 mm | 4.7 mm |
| SAR <sub>tip</sub> [%]                    | Without Correction Algorithm | 11.8   | 7.0    |
| SAR <sub>tip</sub> [%]                    | With Correction Algorithm    | 0.2    | 0.4    |

Sensor Offset

Probe Tip to Sensor Center 2.7 mm

The reported uncertainty of measurement is stated as the standard uncertainty of measurement multiplied by the coverage factor k=2, which for a normal distribution corresponds to a coverage probability of approximately 95%.

<sup>A</sup> The uncertainties of NormX,Y,Z do not affect the E<sup>2</sup>-field uncertainty inside TSL (see Page 8).

<sup>B</sup> Numerical linearization parameter; uncertainty not required.



ET3DV6 SN:1787

August 28, 2007

### Frequency Response of E-Field

(TEM-Cell:if110 EXX, Waveguide: R22)

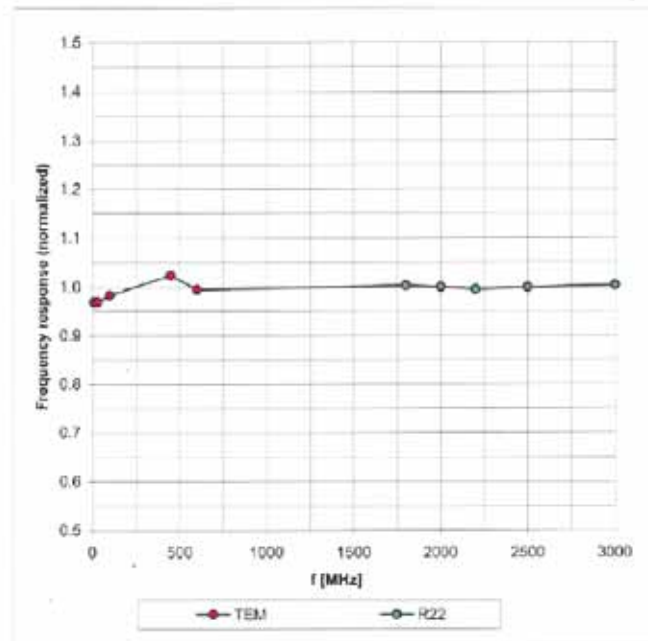

Uncertainty of Frequency Response of E-field:  $\pm 6.3\%$  (k=2)



ET3DV6 SN:1787

August 28, 2007

Receiving Pattern ( $\phi$ ),  $\vartheta = 0^\circ$

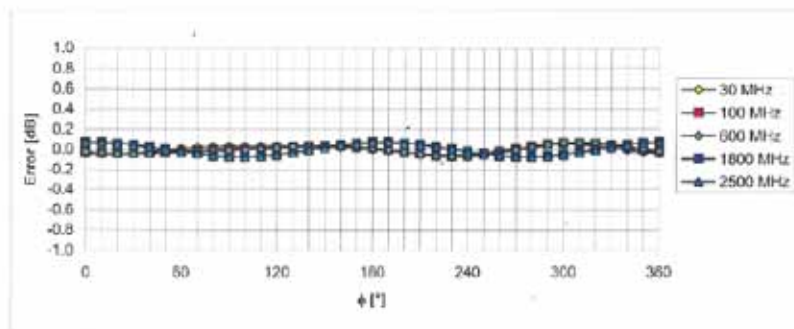
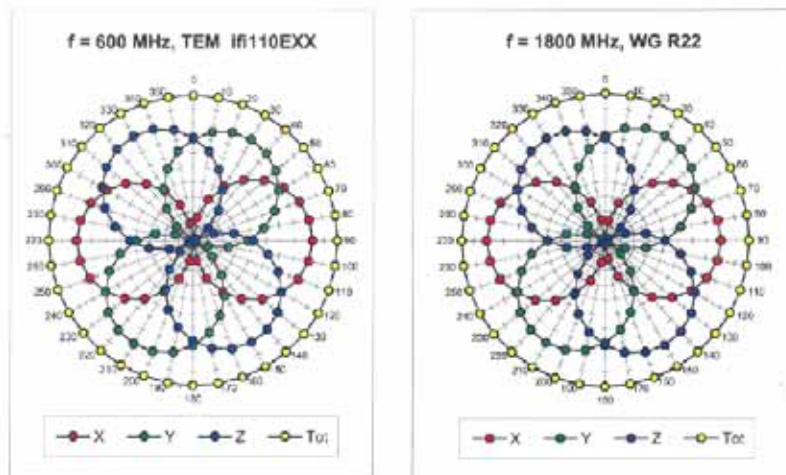

Uncertainty of Axial Isotropy Assessment:  $\pm 0.5\%$  ( $k=2$ )



ET3DV6 SN:1787

August 28, 2007

### Dynamic Range f(SAR<sub>head</sub>) (Waveguide R22, f = 1800 MHz)

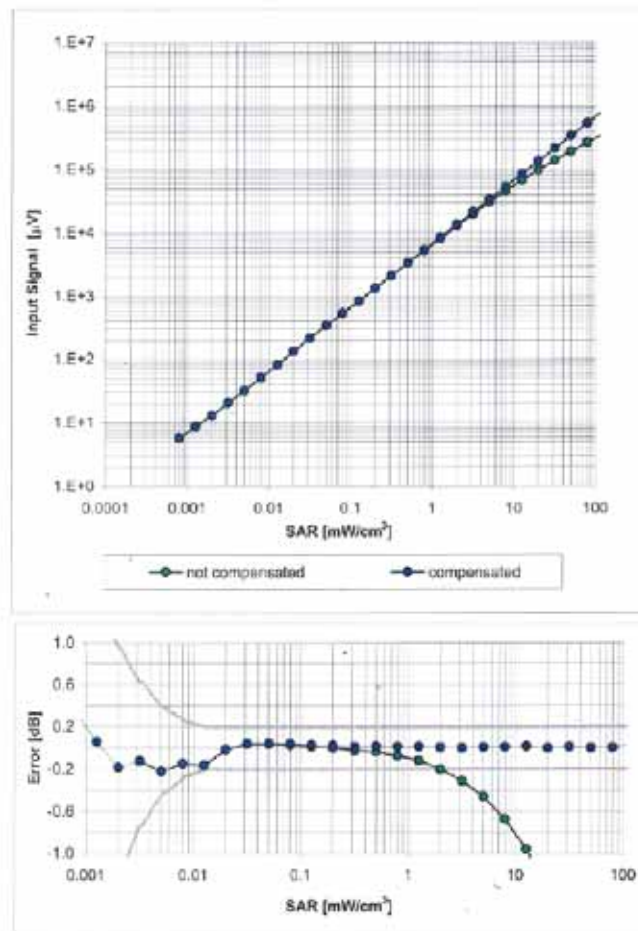

Uncertainty of Linearity Assessment: ± 0.6% (k=2)



ET3DV6 SN:1787

August 28, 2007

### Conversion Factor Assessment

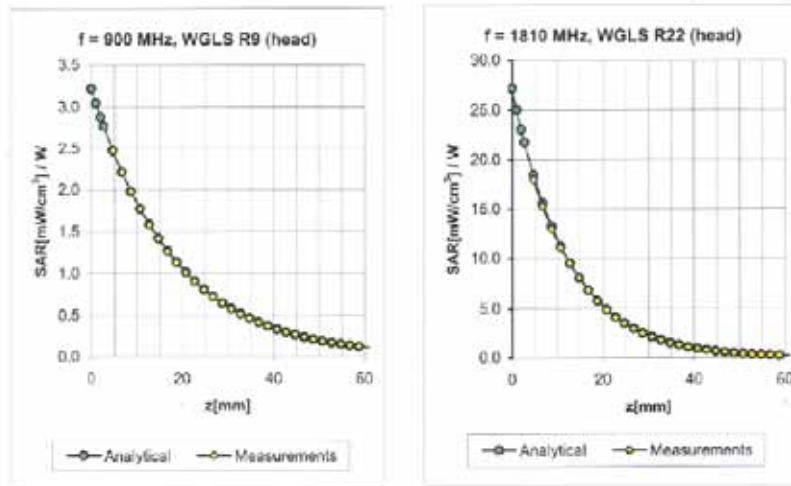

| f [MHz] | Validity [MHz] <sup>2</sup> | TSL  | Permittivity | Conductivity | Alpha | Depth | ConvF Uncertainty  |
|---------|-----------------------------|------|--------------|--------------|-------|-------|--------------------|
| 900     | ± 50 / ± 100                | Head | 41.5 ± 5%    | 0.97 ± 5%    | 0.32  | 2.42  | 6.58 ± 11.0% (k=2) |
| 1810    | ± 50 / ± 100                | Head | 40.0 ± 5%    | 1.40 ± 5%    | 0.50  | 2.61  | 5.16 ± 11.0% (k=2) |
| 2000    | ± 50 / ± 100                | Head | 40.0 ± 5%    | 1.40 ± 5%    | 0.55  | 2.45  | 4.80 ± 11.0% (k=2) |
| 2450    | ± 50 / ± 100                | Head | 39.2 ± 5%    | 1.80 ± 5%    | 0.67  | 1.81  | 4.50 ± 11.8% (k=2) |
| 900     | ± 50 / ± 100                | Body | 55.0 ± 5%    | 1.05 ± 5%    | 0.36  | 2.52  | 6.10 ± 11.0% (k=2) |
| 1810    | ± 50 / ± 100                | Body | 53.3 ± 5%    | 1.52 ± 5%    | 0.61  | 2.56  | 4.68 ± 11.0% (k=2) |
| 2000    | ± 50 / ± 100                | Body | 53.3 ± 5%    | 1.52 ± 5%    | 0.60  | 2.40  | 4.30 ± 11.0% (k=2) |
| 2450    | ± 50 / ± 100                | Body | 52.7 ± 5%    | 1.95 ± 5%    | 0.65  | 2.15  | 4.02 ± 11.8% (k=2) |

<sup>2</sup> The validity of ± 100 MHz only applies for DASV v4.4 and higher (see Page 2). The uncertainty is the RSS of the ConvF uncertainty at calibration frequency and the uncertainty for the indicated frequency band.





ET3DV6 SN:1787

August 28, 2007

### Deviation from Isotropy in HSL

Error ( $\phi, \theta$ ),  $f = 900$  MHz

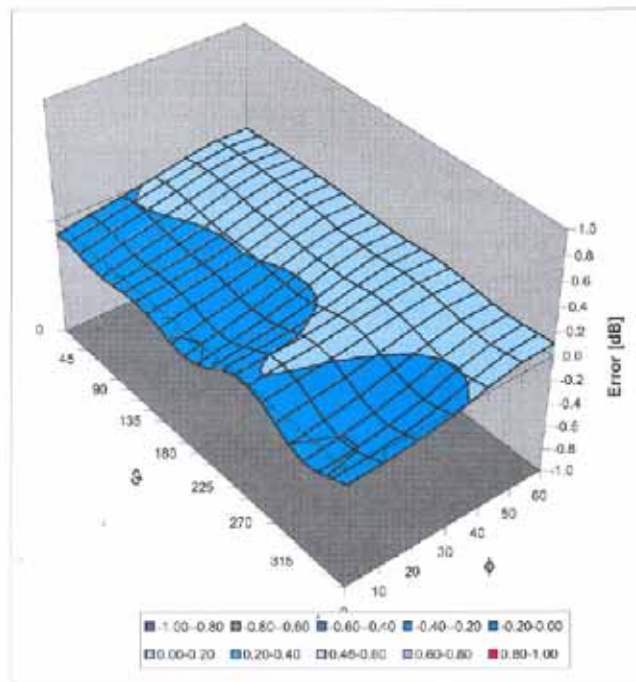

Uncertainty of Spherical Isotropy Assessment:  $\pm 2.6\%$  ( $k=2$ )



Calibration Laboratory of Schmid & Partner Engineering AG, Zeughausstrasse 43, 8004 Zurich, Switzerland



S Schweizerischer Kalibrierdienst, C Service suisse d'étalonnage, S Servizio svizzero di taratura, S Swiss Calibration Service

Accredited by the Swiss Federal Office of Metrology and Accreditation. The Swiss Accreditation Service is one of the signatories to the EA Multilateral Agreement for the recognition of calibration certificates

Accreditation No.: SCS 108

Client: Sporton (Auden)

Certificate No: DAE3-577\_Nov06

CALIBRATION CERTIFICATE

Object: DAE3 - SD 000 D03 AA - SN: 577
Calibration procedure(s): QA CAL-06.v12 Calibration procedure for the data acquisition electronics (DAE)
Calibration date: November 21, 2006
Condition of the calibrated item: In Tolerance

This calibration certificate documents the traceability to national standards, which realize the physical units of measurements (SI). The measurements and the uncertainties with confidence probability are given on the following pages and are part of the certificate.

All calibrations have been conducted in the closed laboratory facility; environment temperature: (22 ± 3)°C and humidity < 70%.

Calibration Equipment used (M&TE critical for calibration)

Table with 4 columns: Primary Standards, ID #, Cal Date (Calibrated by, Certificate No.), Scheduled Calibration. Includes entries for Fluke Process Calibrator Type 702 and Keithley Multimeter Type 2001.

Table with 4 columns: Secondary Standards, ID #, Check Date (in house), Scheduled Check. Includes entry for Calibrator Box V1.1.

Calibrated by: Eric Hainfeld, Technician
Approved by: Fin Bornholt, R&D Director

Issued: November 21, 2006

This calibration certificate shall not be reproduced except in full without written approval of the laboratory.



Calibration Laboratory of  
Schmid & Partner  
Engineering AG  
Zoughausstrasse 43, 8004 Zurich, Switzerland



S Schweizerischer Kalibrierdienst  
C Service suisse d'étalonnage  
S Servizio svizzero di taratura  
S Swiss Calibration Service

Accredited by the Swiss Federal Office of Metrology and Accreditation  
The Swiss Accreditation Service is one of the signatories to the EA  
Multilateral Agreement for the recognition of calibration certificates

Accreditation No.: SCS 108

### Glossary

DAE data acquisition electronics  
Connector angle information used in DASY system to align probe sensor X to the robot coordinate system.

### Methods Applied and Interpretation of Parameters

- **DC Voltage Measurement:** Calibration Factor assessed for use in DASY system by comparison with a calibrated instrument traceable to national standards. The figure given corresponds to the full scale range of the voltmeter in the respective range.
- **Connector angle:** The angle of the connector is assessed measuring the angle mechanically by a tool inserted. Uncertainty is not required.
- The following parameters contain technical information as a result from the performance test and require no uncertainty.
- **DC Voltage Measurement Linearity:** Verification of the Linearity at +10% and -10% of the nominal calibration voltage. Influence of offset voltage is included in this measurement.
- **Common mode sensitivity:** Influence of a positive or negative common mode voltage on the differential measurement.
- **Channel separation:** Influence of a voltage on the neighbor channels not subject to an input voltage.
- **AD Converter Values with Inputs shorted:** Values on the internal AD converter corresponding to zero input voltage
- **Input Offset Measurement:** Output voltage and statistical results over a large number of zero voltage measurements.
- **Input Offset Current:** Typical value for information; Maximum channel input offset current, not considering the input resistance.
- **Input resistance:** DAE input resistance at the connector, during internal auto-zeroing and during measurement.
- **Low Battery Alarm Voltage:** Typical value for information. Below this voltage, a battery alarm signal is generated.
- **Power consumption:** Typical value for information. Supply currents in various operating modes.



**DC Voltage Measurement**

A/D - Converter Resolution nominal

High Range: 1LSB = 6.1µV , full range = -100...+300 mV

Low Range: 1LSB = 61nV , full range = -1.....+3mV

DASY measurement parameters: Auto Zero Time: 3 sec; Measuring time: 3 sec

| Calibration Factors | X                    | Y                    | Z                    |
|---------------------|----------------------|----------------------|----------------------|
| High Range          | 404.355 ± 0.1% (k=2) | 403.806 ± 0.1% (k=2) | 404.276 ± 0.1% (k=2) |
| Low Range           | 3.92854 ± 0.7% (k=2) | 3.93862 ± 0.7% (k=2) | 3.93591 ± 0.7% (k=2) |

**Connector Angle**

|   |             |
|---|-------------|
| Connector Angle to be used in DASY system | 268 ° ± 1 ° |
|---|-------------|



Appendix

1. DC Voltage Linearity

| High Range        | Input (µV) | Reading (µV) | Error (%) |
|-------------------|------------|--------------|-----------|
| Channel X + Input | 200000     | 199999.5     | 0.00      |
| Channel X + Input | 20000      | 20005.87     | 0.03      |
| Channel X - Input | 20000      | -19998.71    | -0.01     |
| Channel Y + Input | 200000     | 200000       | 0.00      |
| Channel Y + Input | 20000      | 20004.22     | 0.02      |
| Channel Y - Input | 20000      | -20003.23    | 0.02      |
| Channel Z + Input | 200000     | 200000.8     | 0.00      |
| Channel Z + Input | 20000      | 20005.24     | 0.03      |
| Channel Z - Input | 20000      | -20001.80    | 0.01      |

| Low Range         | Input (µV) | Reading (µV) | Error (%) |
|-------------------|------------|--------------|-----------|
| Channel X + Input | 2000       | 1999.9       | 0.00      |
| Channel X + Input | 200        | 200.27       | 0.13      |
| Channel X - Input | 200        | -200.73      | 0.36      |
| Channel Y + Input | 2000       | 2000.1       | 0.00      |
| Channel Y + Input | 200        | 199.22       | -0.39     |
| Channel Y - Input | 200        | -200.86      | 0.43      |
| Channel Z + Input | 2000       | 1999.9       | 0.00      |
| Channel Z + Input | 200        | 199.28       | -0.36     |
| Channel Z - Input | 200        | -200.94      | 0.47      |

2. Common mode sensitivity

DASY measurement parameters: Auto Zero Time: 3 sec; Measuring time: 3 sec

|           | Common mode Input Voltage (mV) | High Range Average Reading (µV) | Low Range Average Reading (µV) |
|-----------|--------------------------------|---------------------------------|--------------------------------|
| Channel X | 200                            | 14.24                           | 12.49                          |
|           | -200                           | -12.13                          | -12.62                         |
| Channel Y | 200                            | -6.51                           | -7.06                          |
|           | -200                           | 6.05                            | 5.81                           |
| Channel Z | 200                            | 1.09                            | 0.88                           |
|           | -200                           | -2.86                           | -2.63                          |

3. Channel separation

DASY measurement parameters: Auto Zero Time: 3 sec; Measuring time: 3 sec

|           | Input Voltage (mV) | Channel X (µV) | Channel Y (µV) | Channel Z (µV) |
|-----------|--------------------|----------------|----------------|----------------|
| Channel X | 200                | -              | 2.51           | 0.09           |
| Channel Y | 200                | 0.43           | -              | 3.37           |
| Channel Z | 200                | -0.55          | 0.98           | -              |



4. AD-Converter Values with inputs shorted

DASY measurement parameters: Auto Zero Time: 3 sec; Measuring time: 3 sec

|           | High Range (LSB) | Low Range (LSB) |
|-----------|------------------|-----------------|
| Channel X | 15970            | 16306           |
| Channel Y | 15851            | 16305           |
| Channel Z | 16208            | 17088           |

5. Input Offset Measurement

DASY measurement parameters: Auto Zero Time: 3 sec; Measuring time: 3 sec

Input 10M $\Omega$

|           | Average ( $\mu$ V) | min. Offset ( $\mu$ V) | max. Offset ( $\mu$ V) | Std. Deviation ( $\mu$ V) |
|-----------|--------------------|------------------------|------------------------|---------------------------|
| Channel X | -0.51              | -1.55                  | 0.47                   | 0.50                      |
| Channel Y | -2.06              | -4.32                  | -0.65                  | 0.60                      |
| Channel Z | -1.63              | -2.56                  | -0.15                  | 0.35                      |

6. Input Offset Current

Nominal input circuitry offset current on all channels: <25fA

7. Input Resistance

|           | Zeroing (MOhm) | Measuring (MOhm) |
|-----------|----------------|------------------|
| Channel X | 0.2000         | 199.8            |
| Channel Y | 0.2000         | 200.7            |
| Channel Z | 0.2000         | 199.8            |

8. Low Battery Alarm Voltage (verified during pre test)

| Typical values | Alarm Level (VDC) |
|----------------|-------------------|
| Supply (+ Vcc) | +7.9              |
| Supply (- Vcc) | -7.6              |

9. Power Consumption (verified during pre test)

| Typical values | Switched off (mA) | Stand by (mA) | Transmitting (mA) |
|----------------|-------------------|---------------|-------------------|
| Supply (+ Vcc) | +0.0              | +8            | +14               |
| Supply (- Vcc) | -0.01             | -8            | -9                |



**Appendix D - Product Photo**

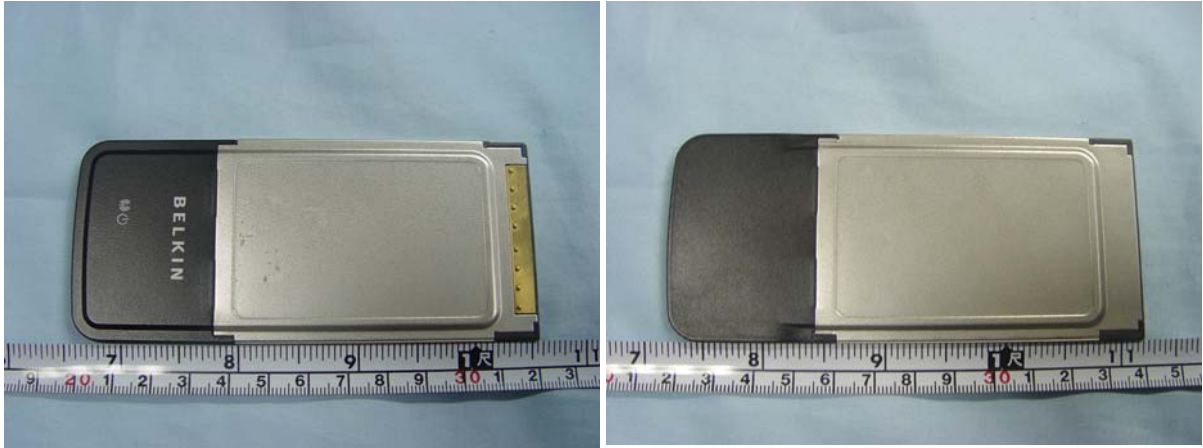



**Appendix E - Test Setup Photo**



**Fig. 9.1 Dell D400 Notebook Bottom Touch**



**Fig. 9.2 Dell D500 Notebook Bottom Touch**





**Fig. 9.3 Dell M2300 Notebook Bottom Touch**