



FCC TEST REPORT

REPORT NO.: RF950403L10

MODEL NO.: F5D8011

RECEIVED: Apr. 24, 2006

TESTED: Apr. 25, ~ Apr. 26, 2006

ISSUED: Apr. 28, 2006

APPLICANT: Belkin Corporation

ADDRESS: 501 West Walnut Avenue, Compton, CA 90220,
U.S.A.

ISSUED BY: Advance Data Technology Corporation

LAB ADDRESS: 47 14th Lin, Chiapau Tsun, Linko, Taipei, Taiwan,
R.O.C.

TEST LOCATION: No. 19, Hwa Ya 2nd Rd., Kueishan, Taoyuan,
Taiwan, R.O.C.

This test report consists of 113 pages in total. It may be duplicated completely for legal use with the approval of the applicant. It should not be reproduced except in full, without the written approval of our laboratory. The client should not use it to claim product endorsement by CNLA, A2LA or any government agencies. The test results in the report only apply to the tested sample.



No. 2177-01



0528



TABLE OF CONTENTS

1.	CERTIFICATION	4
2.	SUMMARY OF TEST RESULTS	5
2.1	MEASUREMENT UNCERTAINTY	5
3.	GENERAL INFORMATION	6
3.1	GENERAL DESCRIPTION OF EUT	6
3.2	DESCRIPTION OF TEST MODES	7
3.2.1	CONFIGURATION OF SYSTEM UNDER TEST	7
3.2.2	TEST MODE APPLICABILITY AND TESTED CHANNEL DETAIL	8
3.3	GENERAL DESCRIPTION OF APPLIED STANDARDS	10
3.4	DESCRIPTION OF SUPPORT UNITS	10
4.	TEST TYPES AND RESULTS	11
4.1	CONDUCTED EMISSION MEASUREMENT	11
4.1.1	LIMITS OF CONDUCTED EMISSION MEASUREMENT	11
4.1.2	TEST INSTRUMENTS	11
4.1.3	TEST PROCEDURES	12
4.1.4	DEVIATION FROM TEST STANDARD	12
4.1.5	TEST SETUP	13
4.1.6	EUT OPERATING CONDITIONS	13
4.1.7	TEST RESULTS	14
4.2	RADIATED EMISSION MEASUREMENT	32
4.2.1	LIMITS OF RADIATED EMISSION MEASUREMENT	32
4.2.2	TEST INSTRUMENTS	33
4.2.3	TEST PROCEDURES	34
4.2.4	DEVIATION FROM TEST STANDARD	34
4.2.5	TEST SETUP	35
4.2.6	EUT OPERATING CONDITIONS	35
4.2.7	TEST RESULTS	36
4.3	6dB BANDWIDTH MEASUREMENT	51
4.3.1	LIMITS OF 6dB BANDWIDTH MEASUREMENT	51
4.3.2	TEST INSTRUMENTS	51
4.3.3	TEST PROCEDURE	51
4.3.4	DEVIATION FROM TEST STANDARD	51
4.3.5	TEST SETUP	52
4.3.6	EUT OPERATING CONDITIONS	52
4.3.7	TEST RESULTS	53
4.4	MAXIMUM PEAK OUTPUT POWER	69
4.4.1	LIMITS OF MAXIMUM PEAK OUTPUT POWER MEASUREMENT	69
4.4.2	INSTRUMENTS	69
4.4.3	TEST PROCEDURES	69



4.4.4	DEVIATION FROM TEST STANDARD	69
4.4.5	TEST SETUP	70
4.4.6	EUT OPERATING CONDITIONS.....	70
4.4.7	TEST RESULTS	71
4.5	POWER SPECTRAL DENSITY MEASUREMENT	73
4.5.1	LIMITS OF POWER SPECTRAL DENSITY MEASUREMENT.....	73
4.5.2	TEST INSTRUMENTS	73
4.5.3	TEST PROCEDURE	73
4.5.4	DEVIATION FROM TEST STANDARD	73
4.5.5	TEST SETUP	74
4.5.6	EUT OPERATING CONDITION	74
4.5.7	TEST RESULTS	75
4.6	BAND EDGES MEASUREMENT	91
4.6.1	LIMITS OF BAND EDGES MEASUREMENT	91
4.6.2	TEST INSTRUMENTS	91
4.6.3	TEST PROCEDURE	92
4.6.4	DEVIATION FROM TEST STANDARD	92
4.6.5	EUT OPERATING CONDITION	92
4.6.6	TEST RESULTS	93
4.7	ANTENNA REQUIREMENT	109
4.7.1	STANDARD APPLICABLE	109
4.7.2	ANTENNA CONNECTED CONSTRUCTION	109
5.	PHOTOGRAPHS OF THE TEST CONFIGURATION	110
6.	INFORMATION ON THE TESTING LABORATORIES.....	112
	APPENDIX-A.....	A-1

2. SUMMARY OF TEST RESULTS

The EUT has been tested according to the following specifications:

APPLIED STANDARD: FCC Part 15, Subpart C			
STANDARD SECTION	TEST TYPE AND LIMIT	RESULT	REMARK
15.207	AC Power Conducted Emission	PASS	Meet the requirement of limit. Minimum passing margin is -15.73dB at 0.197MHz.
15.247(a)(2)	Spectrum Bandwidth of a Direct Sequence Spread Spectrum System Limit : min. 500kHz	PASS	Meet the requirement of limit.
15.247(b)	Maximum Peak Output Power Limit: max. 30dBm	PASS	Meet the requirement of limit.
15.247(d)	Transmitter Radiated Emissions Limit: Table 15.209	PASS	Meet the requirement of limit. Minimum passing margin is -1.04dB at 2390.00MHz.
15.247(e)	Power Spectral Density Limit: max. 8dBm	PASS	Meet the requirement of limit.
15.247(d)	Band Edge Measurement Limit: 20dB less than the peak value of fundamental frequency	PASS	Meet the requirement of limit.

2.1 MEASUREMENT UNCERTAINTY

Where relevant, the following measurement uncertainty levels have been estimated for tests performed on the EUT as specified in CISPR 16-4:

MEASUREMENT	FREQUENCY	UNCERTAINTY
Conducted emissions	9kHz ~ 30MHz	2.44dB
Radiated emissions	30MHz ~ 200MHz	3.63 dB
	200MHz ~1000MHz	3.65 dB
	1GHz ~ 18GHz	2.20 dB
	18GHz ~ 40GHz	1.88 dB

This uncertainty represents an expanded uncertainty expressed at approximately the 95% confidence level using a coverage factor of $k = 2$.

3. GENERAL INFORMATION

3.1 GENERAL DESCRIPTION OF EUT

PRODUCT	N1 Wireless Notebook Card
MODEL NO.	F5D8011
FCC ID	K7SF5D8011
POWER SUPPLY	3.3Vdc from host equipment
MODULATION TYPE	CCK, DQPSK, DBPSK for DSSS 64QAM, 16QAM, QPSK, BPSK for OFDM
MODULATION TECHNOLOGY	DSSS, OFDM
TRANSFER RATE	802.11b: 11.0/ 5.5/ 2.0/ 1.0Mbps 802.11g: 54.0/ 48.0/ 36.0/ 24.0/ 18.0/ 12.0/ 9.0/ 6.0Mbps Draft 802.11n (20MHz): 144.44/ 130.00/ 115.56/ 86.67/ 57.78/ 43.33/ 28.89/ 14.44/ 72.2/ 65.0/ 57.8/ 43.3/ 28.9/ 21.7/ 14.4/ 7.2Mbps Draft 802.11n (40MHz): 300.0/ 270.0/ 240.0/ 180.0/ 120.0/ 90.0/ 60.0/ 30.0/ 150.0/ 135.0/ 120.0/ 90.0/ 60.0/ 45.0/ 30.0/ 15.0Mbps
FREQUENCY RANGE	2412MHz ~ 2462MHz
NUMBER OF CHANNEL	11 for 802.11b, 802.11g, draft 802.11n (20MHz) 7 for draft 802.11n (40MHz)
MAXIMUM OUTPUT POWER	202.783mW
ANTENNA TYPE	PIFA antenna with -0.5dBi gain Printed antenna with 0dBi gain (for receiver only)
DATA CABLE	NA
I/O PORTS	NA

NOTE:

1. The EUT incorporates a MIMO function with 802.11b, 802.11g, draft 802.11n. Physically, the card provides two completed transmit and three receivers.
2. The EUT is 2 * 3 spatial MIMO (2Tx & 3Rx) without beam forming function that only operate dual chain configuration (chain 0 and chain 1 transceivers are operational).
3. When the EUT operating in 802.11b, 802.11g, the software operation, which is defined by manufacturer, only set dual Tx.
4. When the EUT operating in draft 802.11n, the software operation, which is defined by manufacturer, only set 0 ~ 15 of "MCS" (MCS: Modulation and Coding Schemes) for dual Tx.
5. The EUT complies with draft 802.11n standards and backwards compatible with 802.11b, 802.11g products.
5. The EUT operates in the 2.4GHz frequency spectrum with throughput of up to 300Mbps.
6. The above EUT information was declared by manufacturer and for more detailed features description, please refer to the manufacturer's specifications or user's manual.

3.2 DESCRIPTION OF TEST MODES

Eleven channels are provided for 802.11b, 802.11g, draft 802.11n (20MHz):

CHANNEL	FREQUENCY	CHANNEL	FREQUENCY
1	2412MHz	7	2442MHz
2	2417MHz	8	2447MHz
3	2422MHz	9	2452MHz
4	2427MHz	10	2457MHz
5	2432MHz	11	2462MHz
6	2437MHz		

Seven channels are provided for draft 802.11n (40MHz):

CHANNEL	FREQUENCY	CHANNEL	FREQUENCY
1	2422MHz	5	2442MHz
2	2427MHz	6	2447MHz
3	2432MHz	7	2452MHz
4	2437MHz		

3.2.1 CONFIGURATION OF SYSTEM UNDER TEST

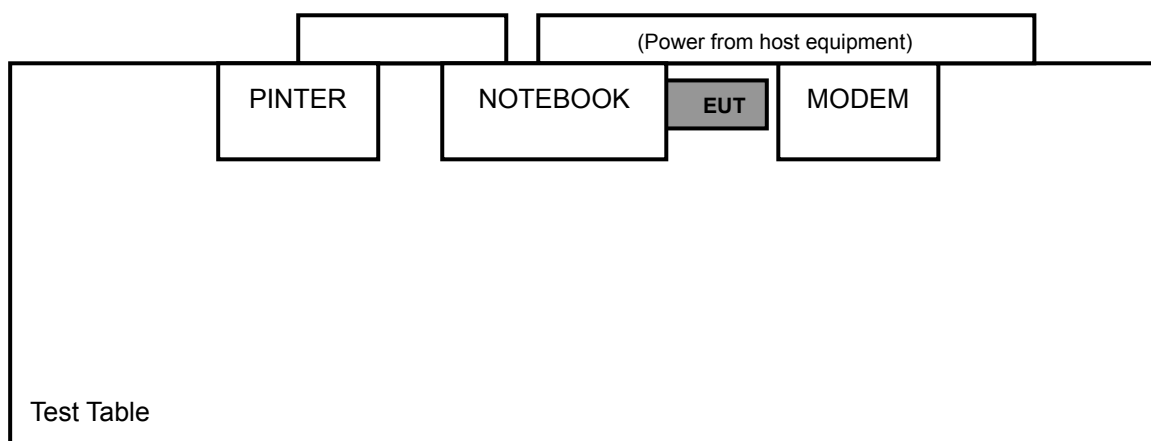

3.2.2 TEST MODE APPLICABILITY AND TESTED CHANNEL DETAIL

EUT CONFIGURE MODE	APPLICABLE TO				DESCRIPTION
	PLC	RE < 1G	RE ≥ 1G	APCM	
-	√	√	√	√	-

Where **PLC**: Power Line Conducted Emission **RE < 1G**: Radiated Emission below 1GHz
RE ≥ 1G: Radiated Emission above 1GHz **APCM**: Antenna Port Conducted Measurement

POWER LINE CONDUCTED EMISSION TEST:

- Pre-Scan has been conducted to determine the worst-case mode from all possible combinations between available modulations, data rates and antenna ports (if EUT with antenna diversity architecture).
- Following channel(s) was (were) selected for the final test as listed below.

MODE	AVAILABLE CHANNEL	TESTED CHANNEL	MODULATION TECHNOLOGY	MODULATION TYPE	DATA RATE (Mbps)
802.11g	1 to 11	1, 6, 11	OFDM	BPSK	6.0
Draft 802.11n (20MHz)	1 to 11	1, 6, 11	OFDM	BPSK	7.2
Draft 802.11n (40MHz)	1 to 7	1, 4, 7	OFDM	BPSK	15.0

RADIATED EMISSION TEST (BELOW 1 GHz):

- Pre-Scan has been conducted to determine the worst-case mode from all possible combinations between available modulations, data rates and antenna ports (if EUT with antenna diversity architecture).
- Following channel(s) was (were) selected for the final test as listed below.

MODE	AVAILABLE CHANNEL	TESTED CHANNEL	MODULATION TECHNOLOGY	MODULATION TYPE	DATA RATE (Mbps)
802.11g	1 to 11	1	OFDM	BPSK	6.0
Draft 802.11n (20MHz)	1 to 11	1	OFDM	BPSK	7.2
Draft 802.11n (40MHz)	1 to 7	1	OFDM	BPSK	15.0



RADIATED EMISSION TEST (ABOVE 1 GHz):

- Pre-Scan has been conducted to determine the worst-case mode from all possible combinations between available modulations, data rates and antenna ports (if EUT with antenna diversity architecture).
- Following channel(s) was (were) selected for the final test as listed below.

MODE	AVAILABLE CHANNEL	TESTED CHANNEL	MODULATION TECHNOLOGY	MODULATION TYPE	DATA RATE (Mbps)
802.11b	1 to 11	1, 6, 11	DSSS	DBPSK	1.0
802.11g	1 to 11	1, 6, 11	OFDM	BPSK	6.0
Draft 802.11n (20MHz)	1 to 11	1, 6, 11	OFDM	BPSK	7.2
Draft 802.11n (40MHz)	1 to 7	1, 4, 7	OFDM	BPSK	15.0

BANDEDGE MEASUREMENT:

- Pre-Scan has been conducted to determine the worst-case mode from all possible combinations between available modulations, data rates and antenna ports (if EUT with antenna diversity architecture).
- Following channel(s) was (were) selected for the final test as listed below.

MODE	AVAILABLE CHANNEL	TESTED CHANNEL	MODULATION TECHNOLOGY	MODULATION TYPE	DATA RATE (Mbps)
802.11b	1 to 11	1, 11	DSSS	DBPSK	1.0
802.11g	1 to 11	1, 11	OFDM	BPSK	6.0
Draft 802.11n (20MHz)	1 to 11	1, 11	OFDM	BPSK	7.2
Draft 802.11n (40MHz)	1 to 7	1, 7	OFDM	BPSK	15.0

ANTENNA PORT CONDUCTED MEASUREMENT:

- Pre-Scan has been conducted to determine the worst-case mode from all possible combinations between available modulations, data rates and antenna ports (if EUT with antenna diversity architecture).
- Following channel(s) was (were) selected for the final test as listed below.

MODE	AVAILABLE CHANNEL	TESTED CHANNEL	MODULATION TECHNOLOGY	MODULATION TYPE	DATA RATE (Mbps)
802.11b	1 to 11	1, 6, 11	DSSS	DBPSK	1.0
802.11g	1 to 11	1, 6, 11	OFDM	BPSK	6.0
Draft 802.11n (20MHz)	1 to 11	1, 6, 11	OFDM	BPSK	7.2
Draft 802.11n (40MHz)	1 to 7	1, 4, 7	OFDM	BPSK	15.0



3.3 GENERAL DESCRIPTION OF APPLIED STANDARDS

The EUT is a RF product. According to the specifications of the manufacturer, it must comply with the requirements of the following standards:

FCC Part 15, Subpart C. (15.247)

ANSI C63.4-2003

All test items have been performed and recorded as per the above standards.

NOTE: The EUT is also considered as a kind of computer peripheral, because the connection to computer is necessary for typical use. It has been verified to comply with the requirements of FCC Part 15, Subpart B, Class B (DoC). The test report has been issued separately.

3.4 DESCRIPTION OF SUPPORT UNITS

The EUT has been tested as an independent unit together with other necessary accessories or support units. The following support units or accessories were used to form a representative test configuration during the tests.

NO.	PRODUCT	BRAND	MODEL NO.	SERIAL NO.	FCC ID
1	NOTEBOOK COMPUTER	DELL	PP05L	9954115984	E2K24CLNS
2	MODEM	ACEEX	1414V/3	0401008260	IFAXDM1414
3	PRINTER	EPSON	LQ-300+	DCGY054146	FCC DoC Approved

NO.	SIGNAL CABLE DESCRIPTION OF THE ABOVE SUPPORT UNITS
1	NA
2	1.2m shielded cable
3	1.2m shielded cable

NOTE: All power cords of the above support units are non-shielded (1.8m).



4. TEST TYPES AND RESULTS

4.1 CONDUCTED EMISSION MEASUREMENT

4.1.1 LIMITS OF CONDUCTED EMISSION MEASUREMENT

FREQUENCY OF EMISSION (MHz)	CONDUCTED LIMIT (dB μ V)	
	Quasi-peak	Average
0.15-0.5	66 to 56	56 to 46
0.5-5	56	46
5-30	60	50

- NOTE:**
1. The lower limit shall apply at the transition frequencies.
 2. The limit decreases in line with the logarithm of the frequency in the range of 0.15 to 0.50 MHz.
 3. All emanations from a class A/B digital device or system, including any network of conductors and apparatus connected thereto, shall not exceed the level of field strengths specified above.

4.1.2 TEST INSTRUMENTS

DESCRIPTION & MANUFACTURER	MODEL NO.	SERIAL NO.	CALIBRATED UNTIL
Test Receiver ROHDE & SCHWARZ	ESCS30	100291	Nov. 11, 2006
RF signal cable Woken	5D-FB	Cable-HYC01-01	Jan. 06, 2007
LISN ROHDE & SCHWARZ	ESH3-Z5	100312	Feb. 15, 2007
LISN ROHDE & SCHWARZ	ESH2-Z5	100104	Feb. 07, 2007
Software ADT	ADT_Cond_V3	NA	NA

- NOTE:**
1. The calibration interval of the above test instruments is 12 months and the calibrations are traceable to NML/ROC and NIST/USA.
 2. The test was performed in HwaYa Shielded Room 1.
 3. The VCCI Site Registration No. is C-2040.

4.1.3 TEST PROCEDURES

- a. The EUT was placed 0.4 meters from the conducting wall of the shielded room with EUT being connected to the power mains through a line impedance stabilization network (LISN). Other support units were connected to the power mains through another LISN. The two LISNs provide 50 ohm/ 50uH of coupling impedance for the measuring instrument.
- b. Both lines of the power mains connected to the EUT were checked for maximum conducted interference.
- c. The frequency range from 150kHz to 30MHz was searched. Emission levels under (Limit - 20dB) was not recorded.

4.1.4 DEVIATION FROM TEST STANDARD

No deviation

4.1.5 TEST SETUP

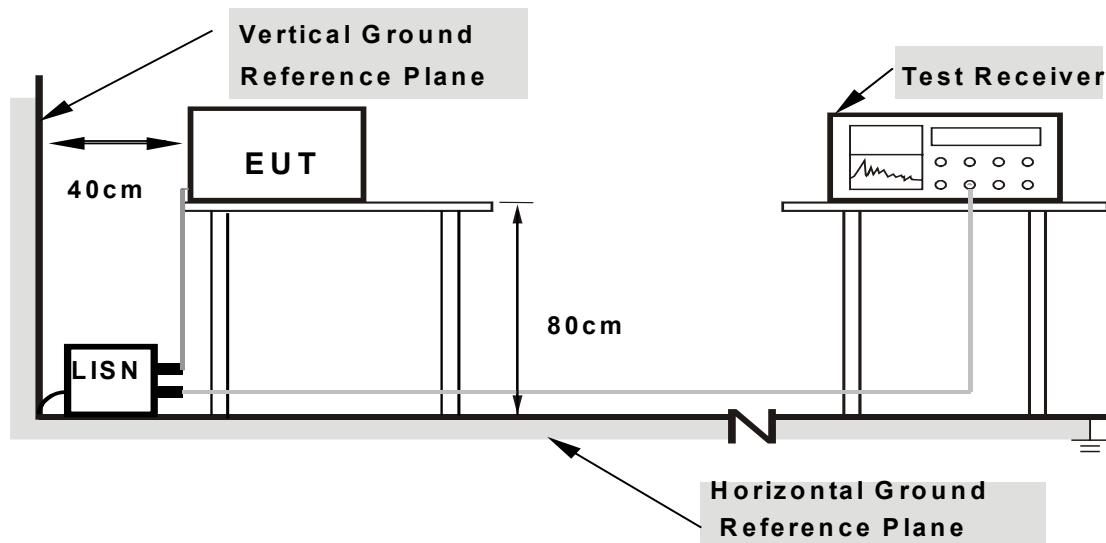

Note: 1. Support units were connected to second LISN.

2. Both of LISNs (AMN) are 80 cm from EUT and at least 80 from other units and other metal planes

For the actual test configuration, please refer to the related item – Photographs of the Test Configuration.

4.1.6 EUT OPERATING CONDITIONS

- a. Plugged EUT in notebook system and placed on a testing table.
- b. The notebook system ran a test program (provided by manufacturer) to enable EUT under transmission condition continuously at specific channel frequency.
- c. The notebook system sent "H" messages to its screen.
- d. The notebook system show "H" messages to modem.
- e. The notebook system sent "H" messages to printer and the printer prints them on paper.
- f. Repeated item c ~e.

4.1.7 TEST RESULTS

CONDUCTED WORST-CASE DATA: 802.11g OFDM MODULATION:

EUT TEST CONDITION		MEASUREMENT DETAIL	
CHANNEL	Channel 1	PHASE	Line 1
MODULATION TYPE	BPSK	6dB BANDWIDTH	9 kHz
TRANSFER RATE	6.0Mbps	INPUT POWER (SYSTEM)	120Vac, 60 Hz
ENVIRONMENTAL CONDITIONS	20deg. C, 70% RH, 991hPa	TESTED BY	Brad Wu

No	FREQ. [MHz]	CORR. Factor (dB)	READING VALUE [dB (uV)]		EMISSION LEVEL [dB (uV)]		LIMIT [dB (uV)]		MARGIN (dB)	
			Q.P.	AV.	Q.P.	AV.	Q.P.	AV.	Q.P.	AV.
			1	0.193	0.10	32.06	-	32.16	-	63.91
2	0.232	0.10	42.75	-	42.85	-	62.38	52.38	-19.53	-
3	0.576	0.13	24.04	-	24.17	-	56.00	46.00	-31.83	-
4	1.746	0.20	30.58	-	30.78	-	56.00	46.00	-25.22	-
5	3.734	0.43	25.95	-	26.38	-	56.00	46.00	-29.62	-
6	10.168	0.47	36.05	-	36.52	-	60.00	50.00	-23.48	-

- REMARKS:**
1. Q.P. and AV. are abbreviations of quasi-peak and average individually.
 2. "-": The Quasi-peak reading value also meets average limit and measurement with the average detector is unnecessary.
 3. The emission levels of other frequencies were very low against the limit.
 4. Margin value = Emission level - Limit value
 5. Correction factor = Insertion loss + Cable loss
 6. Emission Level = Correction Factor + Reading Value.

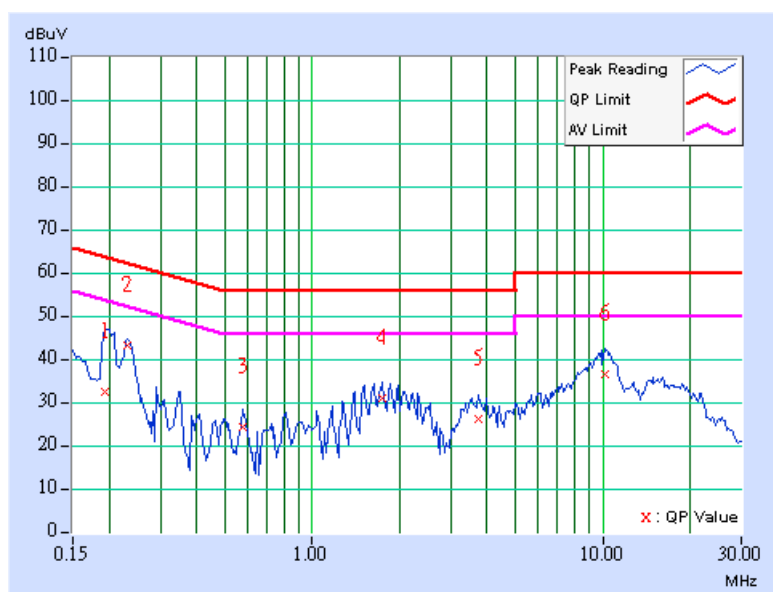

EUT TEST CONDITION		MEASUREMENT DETAIL	
CHANNEL	Channel 1	PHASE	Line 2
MODULATION TYPE	BPSK	6dB BANDWIDTH	9 kHz
TRANSFER RATE	6.0Mbps	INPUT POWER (SYSTEM)	120Vac, 60 Hz
ENVIRONMENTAL CONDITIONS	20deg. C, 70% RH, 991hPa	TESTED BY	Brad Wu

No	FREQ. [MHz]	CORR. Factor (dB)	READING VALUE [dB (uV)]		EMISSION LEVEL [dB (uV)]		LIMIT [dB (uV)]		MARGIN (dB)	
			Q.P.	AV.	Q.P.	AV.	Q.P.	AV.	Q.P.	AV.
1	0.177	0.10	45.13	-	45.23	-	64.61	54.61	-19.38	-
2	0.197	0.10	47.91	-	48.01	-	63.74	53.74	-15.73	-
3	0.408	0.10	27.24	-	27.34	-	57.69	47.69	-30.35	-
4	1.855	0.19	29.23	-	29.42	-	56.00	46.00	-26.58	-
5	10.047	0.46	36.18	-	36.64	-	60.00	50.00	-23.36	-
6	15.367	0.54	30.10	-	30.64	-	60.00	50.00	-29.36	-

- REMARKS:**
1. Q.P. and AV. are abbreviations of quasi-peak and average individually.
 2. "-": The Quasi-peak reading value also meets average limit and measurement with the average detector is unnecessary.
 3. The emission levels of other frequencies were very low against the limit.
 4. Margin value = Emission level - Limit value
 5. Correction factor = Insertion loss + Cable loss
 6. Emission Level = Correction Factor + Reading Value.

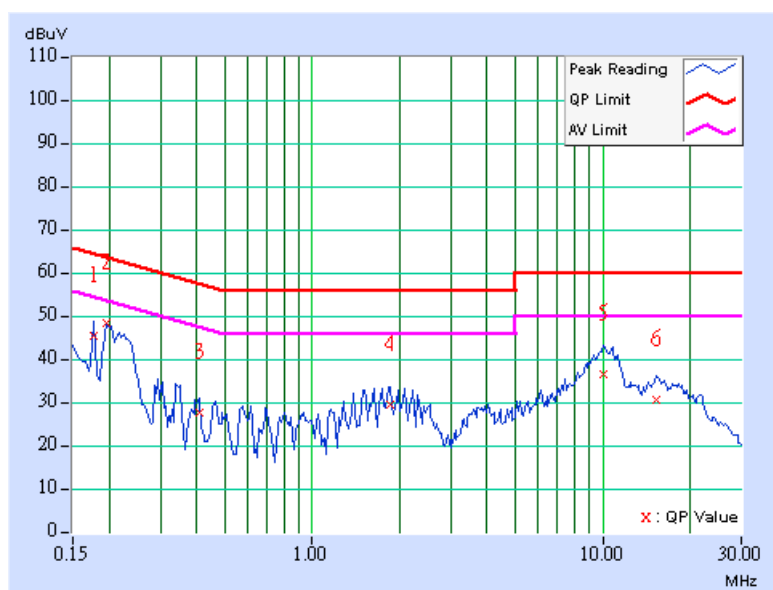

EUT TEST CONDITION		MEASUREMENT DETAIL	
CHANNEL	Channel 6	PHASE	Line 1
MODULATION TYPE	BPSK	6dB BANDWIDTH	9 kHz
TRANSFER RATE	6.0Mbps	INPUT POWER (SYSTEM)	120Vac, 60 Hz
ENVIRONMENTAL CONDITIONS	20deg. C, 70% RH, 991hPa	TESTED BY	Brad Wu

No	FREQ. [MHz]	CORR. Factor (dB)	READING VALUE [dB (uV)]		EMISSION LEVEL [dB (uV)]		LIMIT [dB (uV)]		MARGIN (dB)	
			Q.P.	AV.	Q.P.	AV.	Q.P.	AV.	Q.P.	AV.
1	0.197	0.10	34.97	-	35.07	-	63.74	53.74	-28.67	-
2	0.228	0.10	38.72	-	38.82	-	62.52	52.52	-23.70	-
3	1.746	0.20	29.50	-	29.70	-	56.00	46.00	-26.30	-
4	3.492	0.40	24.82	-	25.22	-	56.00	46.00	-30.78	-
5	10.336	0.47	36.30	-	36.77	-	60.00	50.00	-23.23	-
6	17.695	0.74	29.20	-	29.94	-	60.00	50.00	-30.06	-

- REMARKS:**
1. Q.P. and AV. are abbreviations of quasi-peak and average individually.
 2. "-": The Quasi-peak reading value also meets average limit and measurement with the average detector is unnecessary.
 3. The emission levels of other frequencies were very low against the limit.
 4. Margin value = Emission level - Limit value
 5. Correction factor = Insertion loss + Cable loss
 6. Emission Level = Correction Factor + Reading Value.

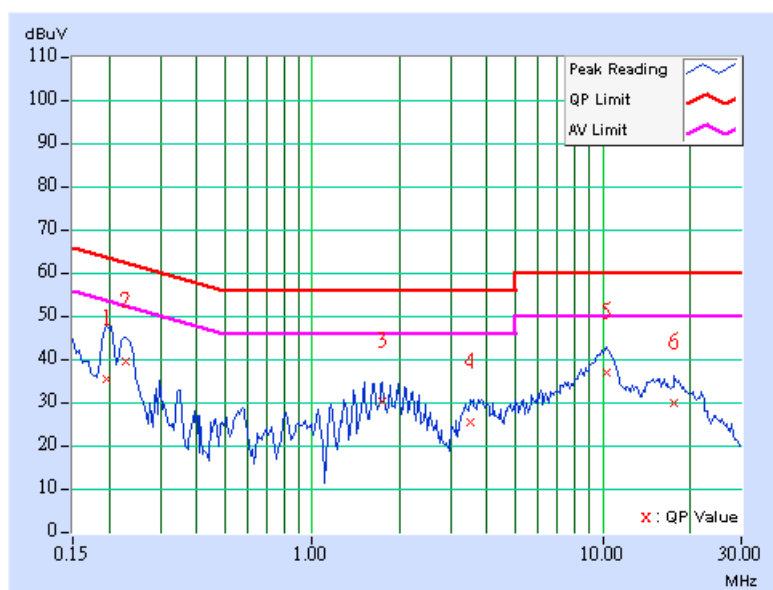

EUT TEST CONDITION		MEASUREMENT DETAIL	
CHANNEL	Channel 6	PHASE	Line 2
MODULATION TYPE	BPSK	6dB BANDWIDTH	9 kHz
TRANSFER RATE	6.0Mbps	INPUT POWER (SYSTEM)	120Vac, 60 Hz
ENVIRONMENTAL CONDITIONS	20deg. C, 70% RH, 991hPa	TESTED BY	Brad Wu

No	FREQ. [MHz]	CORR. Factor [dB]	READING VALUE [dB (uV)]		EMISSION LEVEL [dB (uV)]		LIMIT [dB (uV)]		MARGIN (dB)	
			Q.P.	AV.	Q.P.	AV.	Q.P.	AV.	Q.P.	AV.
1	0.197	0.10	41.12	-	41.22	-	63.74	53.74	-22.52	-
2	0.232	0.10	42.73	-	42.83	-	62.38	52.38	-19.55	-
3	0.345	0.10	29.10	-	29.20	-	59.07	49.07	-29.87	-
4	1.734	0.17	29.23	-	29.40	-	56.00	46.00	-26.60	-
5	10.633	0.47	36.21	-	36.68	-	60.00	50.00	-23.32	-
6	15.367	0.54	30.20	-	30.74	-	60.00	50.00	-29.26	-

- REMARKS:**
1. Q.P. and AV. are abbreviations of quasi-peak and average individually.
 2. "-": The Quasi-peak reading value also meets average limit and measurement with the average detector is unnecessary.
 3. The emission levels of other frequencies were very low against the limit.
 4. Margin value = Emission level - Limit value
 5. Correction factor = Insertion loss + Cable loss
 6. Emission Level = Correction Factor + Reading Value.

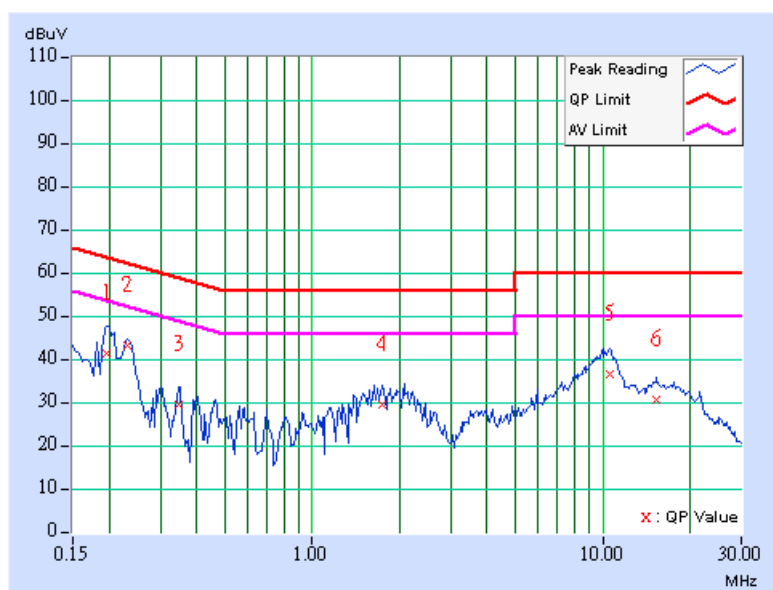

EUT TEST CONDITION		MEASUREMENT DETAIL	
CHANNEL	Channel 11	PHASE	Line 1
MODULATION TYPE	BPSK	6dB BANDWIDTH	9 kHz
TRANSFER RATE	6.0Mbps	INPUT POWER (SYSTEM)	120Vac, 60 Hz
ENVIRONMENTAL CONDITIONS	20deg. C, 70% RH, 991hPa	TESTED BY	Brad Wu

No	FREQ. [MHz]	CORR. Factor (dB)	READING VALUE [dB (uV)]		EMISSION LEVEL [dB (uV)]		LIMIT [dB (uV)]		MARGIN (dB)	
			Q.P.	AV.	Q.P.	AV.	Q.P.	AV.	Q.P.	AV.
1	0.150	0.10	37.20	-	37.30	-	66.00	56.00	-28.70	-
2	0.201	0.10	36.39	-	36.49	-	63.58	53.58	-27.09	-
3	0.584	0.13	23.06	-	23.19	-	56.00	46.00	-32.81	-
4	1.863	0.20	28.19	-	28.39	-	56.00	46.00	-27.61	-
5	9.898	0.46	35.35	-	35.81	-	60.00	50.00	-24.19	-
6	15.219	0.64	30.02	-	30.66	-	60.00	50.00	-29.34	-

- REMARKS:**
1. Q.P. and AV. are abbreviations of quasi-peak and average individually.
 2. "-": The Quasi-peak reading value also meets average limit and measurement with the average detector is unnecessary.
 3. The emission levels of other frequencies were very low against the limit.
 4. Margin value = Emission level - Limit value
 5. Correction factor = Insertion loss + Cable loss
 6. Emission Level = Correction Factor + Reading Value.

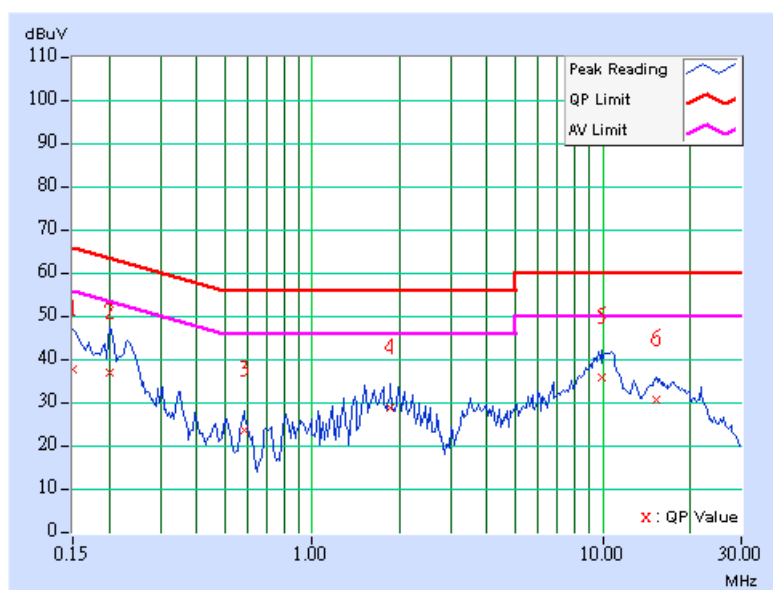

EUT TEST CONDITION		MEASUREMENT DETAIL	
CHANNEL	Channel 11	PHASE	Line 2
MODULATION TYPE	BPSK	6dB BANDWIDTH	9 kHz
TRANSFER RATE	6.0Mbps	INPUT POWER (SYSTEM)	120Vac, 60 Hz
ENVIRONMENTAL CONDITIONS	20deg. C, 70% RH, 991hPa	TESTED BY	Brad Wu

No	FREQ. [MHz]	CORR. Factor [dB]	READING VALUE [dB (uV)]		EMISSION LEVEL [dB (uV)]		LIMIT [dB (uV)]		MARGIN (dB)	
			Q.P.	AV.	Q.P.	AV.	Q.P.	AV.	Q.P.	AV.
1	0.150	0.10	37.76	-	37.86	-	66.00	56.00	-28.14	-
2	0.213	0.10	32.68	-	32.78	-	63.11	53.11	-30.33	-
3	1.863	0.19	28.07	-	28.26	-	56.00	46.00	-27.74	-
4	3.883	0.36	21.72	-	22.08	-	56.00	46.00	-33.92	-
5	10.254	0.46	36.35	-	36.81	-	60.00	50.00	-23.19	-
6	15.363	0.54	30.08	-	30.62	-	60.00	50.00	-29.38	-

- REMARKS:**
1. Q.P. and AV. are abbreviations of quasi-peak and average individually.
 2. "-": The Quasi-peak reading value also meets average limit and measurement with the average detector is unnecessary.
 3. The emission levels of other frequencies were very low against the limit.
 4. Margin value = Emission level - Limit value
 5. Correction factor = Insertion loss + Cable loss
 6. Emission Level = Correction Factor + Reading Value.

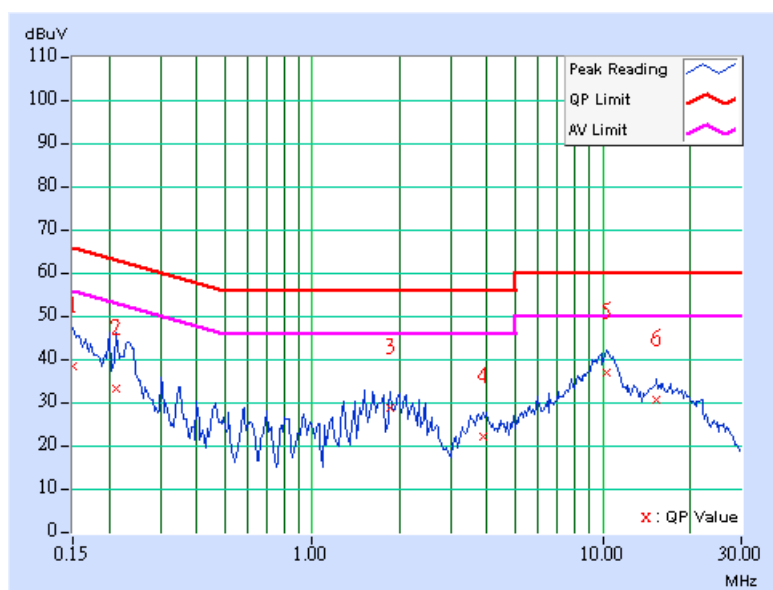

DRAFT 802.11n (20MHz) OFDM MODULATION:

EUT TEST CONDITION		MEASUREMENT DETAIL	
CHANNEL	Channel 1	PHASE	Line 1
MODULATION TYPE	BPSK	6dB BANDWIDTH	9 kHz
TRANSFER RATE	7.2Mbps	INPUT POWER (SYSTEM)	120Vac, 60 Hz
ENVIRONMENTAL CONDITIONS	20deg. C, 70% RH, 991hPa	TESTED BY	Brad Wu

No	FREQ.	CORR.	READING VALUE		EMISSION LEVEL		LIMIT		MARGIN	
	[MHz]	Factor	[dB (uV)]		[dB (uV)]		[dB (uV)]		(dB)	
		(dB)	Q.P.	AV.	Q.P.	AV.	Q.P.	AV.	Q.P.	AV.
1	0.181	0.10	32.17	-	32.27	-	64.43	54.43	-32.16	-
2	0.232	0.10	42.71	-	42.81	-	62.38	52.38	-19.57	-
3	0.584	0.13	23.82	-	23.95	-	56.00	46.00	-32.05	-
4	1.902	0.20	30.83	-	31.03	-	56.00	46.00	-24.97	-
5	3.711	0.43	26.48	-	26.91	-	56.00	46.00	-29.09	-
6	10.566	0.48	36.03	-	36.51	-	60.00	50.00	-23.49	-

- REMARKS:**
1. Q.P. and AV. are abbreviations of quasi-peak and average individually.
 2. "-": The Quasi-peak reading value also meets average limit and measurement with the average detector is unnecessary.
 3. The emission levels of other frequencies were very low against the limit.
 4. Margin value = Emission level - Limit value
 5. Correction factor = Insertion loss + Cable loss
 6. Emission Level = Correction Factor + Reading Value.

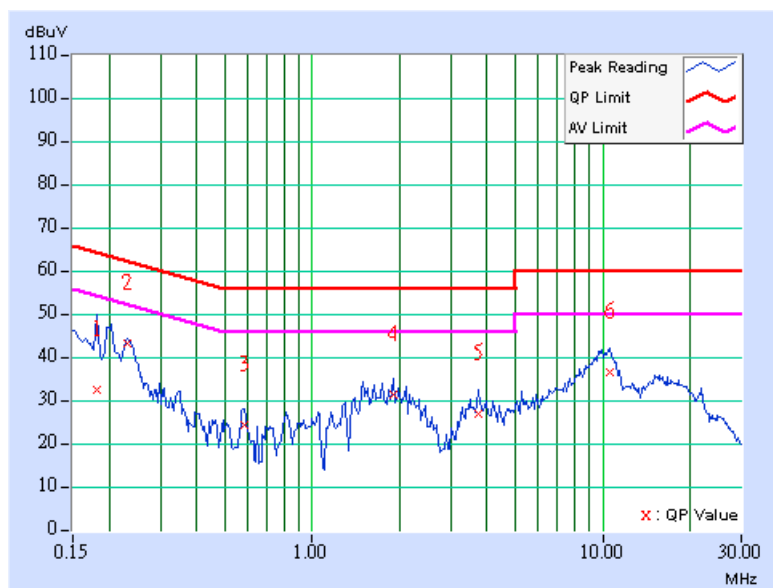

EUT TEST CONDITION		MEASUREMENT DETAIL	
CHANNEL	Channel 1	PHASE	Line 2
MODULATION TYPE	BPSK	6dB BANDWIDTH	9 kHz
TRANSFER RATE	7.2Mbps	INPUT POWER (SYSTEM)	120Vac, 60 Hz
ENVIRONMENTAL CONDITIONS	20deg. C, 70% RH, 991hPa	TESTED BY	Brad Wu

No	FREQ. [MHz]	CORR. Factor (dB)	READING VALUE [dB (uV)]		EMISSION LEVEL [dB (uV)]		LIMIT [dB (uV)]		MARGIN (dB)	
			Q.P.	AV.	Q.P.	AV.	Q.P.	AV.	Q.P.	AV.
1	0.201	0.10	33.42	-	33.52	-	63.58	53.58	-30.06	-
2	0.232	0.10	41.25	-	41.35	-	62.38	52.38	-21.03	-
3	0.705	0.10	24.34	-	24.44	-	56.00	46.00	-31.56	-
4	2.004	0.20	27.62	-	27.82	-	56.00	46.00	-28.18	-
5	10.094	0.46	36.17	-	36.63	-	60.00	50.00	-23.37	-
6	16.770	0.57	28.42	-	28.99	-	60.00	50.00	-31.01	-

- REMARKS:**
1. Q.P. and AV. are abbreviations of quasi-peak and average individually.
 2. "-": The Quasi-peak reading value also meets average limit and measurement with the average detector is unnecessary.
 3. The emission levels of other frequencies were very low against the limit.
 4. Margin value = Emission level - Limit value
 5. Correction factor = Insertion loss + Cable loss
 6. Emission Level = Correction Factor + Reading Value.

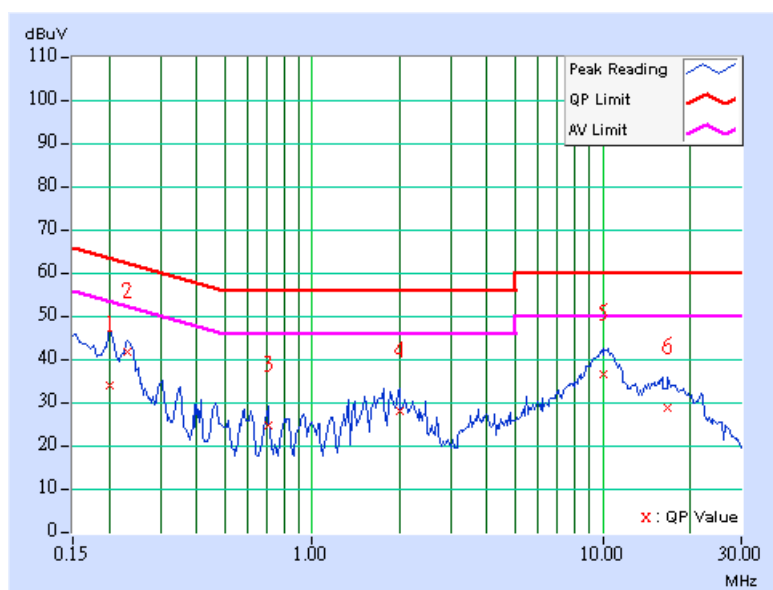

EUT TEST CONDITION		MEASUREMENT DETAIL	
CHANNEL	Channel 6	PHASE	Line 1
MODULATION TYPE	BPSK	6dB BANDWIDTH	9 kHz
TRANSFER RATE	7.2Mbps	INPUT POWER (SYSTEM)	120Vac, 60 Hz
ENVIRONMENTAL CONDITIONS	20deg. C, 70% RH, 991hPa	TESTED BY	Brad Wu

No	FREQ. [MHz]	CORR. Factor (dB)	READING VALUE [dB (uV)]		EMISSION LEVEL [dB (uV)]		LIMIT [dB (uV)]		MARGIN (dB)	
			Q.P.	AV.	Q.P.	AV.	Q.P.	AV.	Q.P.	AV.
1	0.150	0.10	37.16	-	37.26	-	66.00	56.00	-28.74	-
2	0.185	0.10	30.54	-	30.64	-	64.25	54.25	-33.61	-
3	1.734	0.20	27.67	-	27.87	-	56.00	46.00	-28.13	-
4	3.594	0.42	22.28	-	22.70	-	56.00	46.00	-33.30	-
5	10.113	0.46	35.79	-	36.25	-	60.00	50.00	-23.75	-
6	15.078	0.63	29.73	-	30.36	-	60.00	50.00	-29.64	-

- REMARKS:**
1. Q.P. and AV. are abbreviations of quasi-peak and average individually.
 2. "-": The Quasi-peak reading value also meets average limit and measurement with the average detector is unnecessary.
 3. The emission levels of other frequencies were very low against the limit.
 4. Margin value = Emission level - Limit value
 5. Correction factor = Insertion loss + Cable loss
 6. Emission Level = Correction Factor + Reading Value.

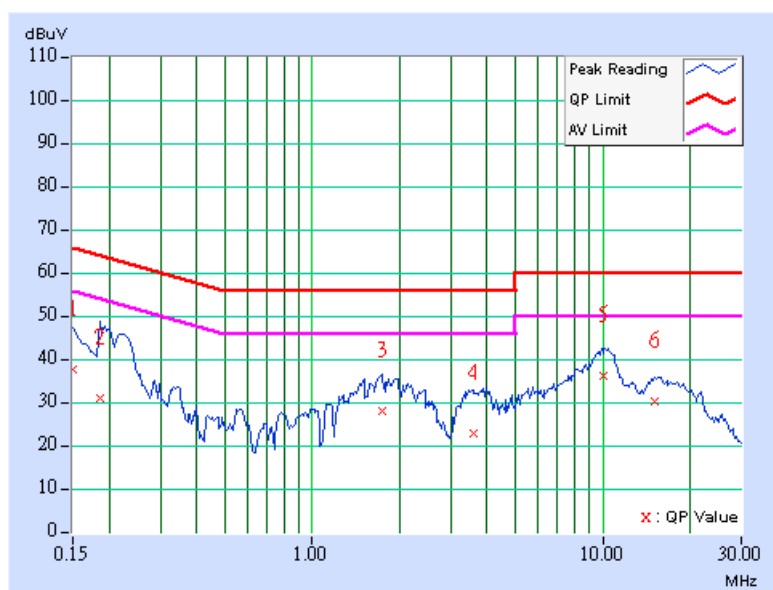

EUT TEST CONDITION		MEASUREMENT DETAIL	
CHANNEL	Channel 6	PHASE	Line 2
MODULATION TYPE	BPSK	6dB BANDWIDTH	9 kHz
TRANSFER RATE	7.2Mbps	INPUT POWER (SYSTEM)	120Vac, 60 Hz
ENVIRONMENTAL CONDITIONS	20deg. C, 70% RH, 991hPa	TESTED BY	Brad Wu

No	FREQ. [MHz]	CORR. Factor (dB)	READING VALUE [dB (uV)]		EMISSION LEVEL [dB (uV)]		LIMIT [dB (uV)]		MARGIN (dB)	
			Q.P.	AV.	Q.P.	AV.	Q.P.	AV.	Q.P.	AV.
1	0.150	0.10	36.96	-	37.06	-	66.00	56.00	-28.94	-
2	0.201	0.10	33.56	-	33.66	-	63.58	53.58	-29.92	-
3	1.906	0.19	22.94	-	23.13	-	56.00	46.00	-32.87	-
4	3.801	0.35	21.37	-	21.72	-	56.00	46.00	-34.28	-
5	10.094	0.46	36.27	-	36.73	-	60.00	50.00	-23.27	-
6	15.465	0.54	30.17	-	30.71	-	60.00	50.00	-29.29	-

- REMARKS:**
1. Q.P. and AV. are abbreviations of quasi-peak and average individually.
 2. "-": The Quasi-peak reading value also meets average limit and measurement with the average detector is unnecessary.
 3. The emission levels of other frequencies were very low against the limit.
 4. Margin value = Emission level - Limit value
 5. Correction factor = Insertion loss + Cable loss
 6. Emission Level = Correction Factor + Reading Value.

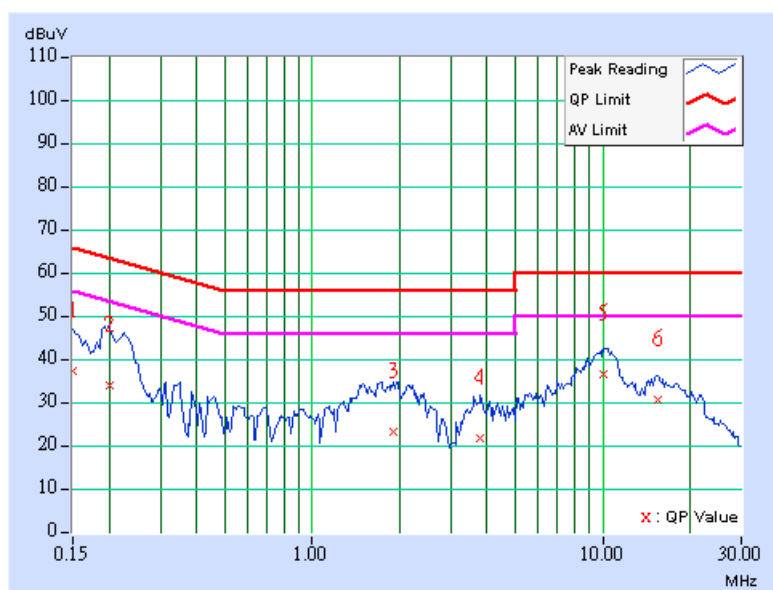

EUT TEST CONDITION		MEASUREMENT DETAIL	
CHANNEL	Channel 11	PHASE	Line 1
MODULATION TYPE	BPSK	6dB BANDWIDTH	9 kHz
TRANSFER RATE	7.2Mbps	INPUT POWER (SYSTEM)	120Vac, 60 Hz
ENVIRONMENTAL CONDITIONS	20deg. C, 70% RH, 991hPa	TESTED BY	Brad Wu

No	FREQ. [MHz]	CORR. Factor (dB)	READING VALUE [dB (uV)]		EMISSION LEVEL [dB (uV)]		LIMIT [dB (uV)]		MARGIN (dB)	
			Q.P.	AV.	Q.P.	AV.	Q.P.	AV.	Q.P.	AV.
1	0.150	0.10	37.34	-	37.44	-	66.00	56.00	-28.56	-
2	0.189	0.10	31.02	-	31.12	-	64.08	54.08	-32.96	-
3	1.844	0.20	25.87	-	26.07	-	56.00	46.00	-29.93	-
4	3.746	0.44	26.05	-	26.49	-	56.00	46.00	-29.51	-
5	10.324	0.47	36.32	-	36.79	-	60.00	50.00	-23.21	-
6	15.219	0.64	30.28	-	30.92	-	60.00	50.00	-29.08	-

- REMARKS:**
1. Q.P. and AV. are abbreviations of quasi-peak and average individually.
 2. "-": The Quasi-peak reading value also meets average limit and measurement with the average detector is unnecessary.
 3. The emission levels of other frequencies were very low against the limit.
 4. Margin value = Emission level - Limit value
 5. Correction factor = Insertion loss + Cable loss
 6. Emission Level = Correction Factor + Reading Value.

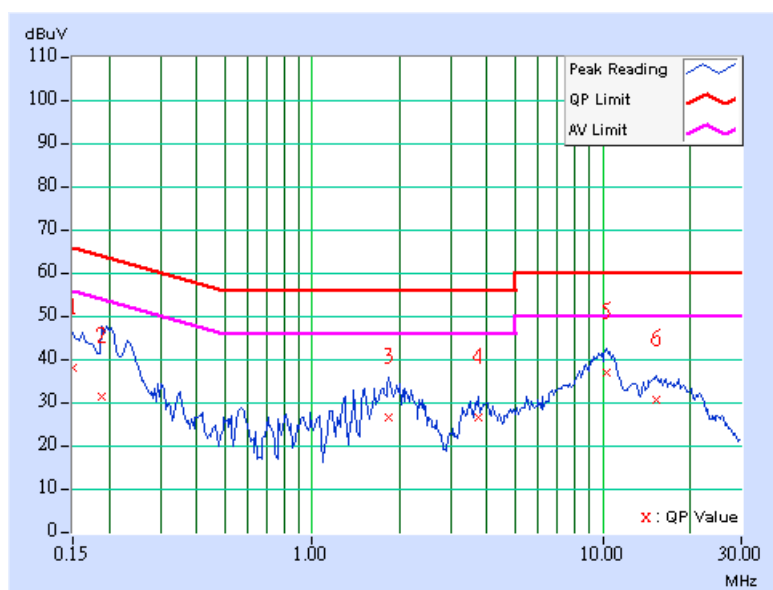

EUT TEST CONDITION		MEASUREMENT DETAIL	
CHANNEL	Channel 11	PHASE	Line 2
MODULATION TYPE	BPSK	6dB BANDWIDTH	9 kHz
TRANSFER RATE	7.2Mbps	INPUT POWER (SYSTEM)	120Vac, 60 Hz
ENVIRONMENTAL CONDITIONS	20deg. C, 70% RH, 991hPa	TESTED BY	Brad Wu

No	FREQ. [MHz]	CORR. Factor [dB]	READING VALUE [dB (uV)]		EMISSION LEVEL [dB (uV)]		LIMIT [dB (uV)]		MARGIN (dB)	
			Q.P.	AV.	Q.P.	AV.	Q.P.	AV.	Q.P.	AV.
1	0.154	0.10	35.50	-	35.60	-	65.79	55.79	-30.19	-
2	0.193	0.10	32.62	-	32.72	-	63.91	53.91	-31.19	-
3	1.512	0.15	27.94	-	28.09	-	56.00	46.00	-27.91	-
4	3.953	0.37	22.63	-	23.00	-	56.00	46.00	-33.00	-
5	10.023	0.46	36.49	-	36.95	-	60.00	50.00	-23.05	-
6	15.754	0.55	30.27	-	30.82	-	60.00	50.00	-29.18	-

- REMARKS:**
1. Q.P. and AV. are abbreviations of quasi-peak and average individually.
 2. "-": The Quasi-peak reading value also meets average limit and measurement with the average detector is unnecessary.
 3. The emission levels of other frequencies were very low against the limit.
 4. Margin value = Emission level - Limit value
 5. Correction factor = Insertion loss + Cable loss
 6. Emission Level = Correction Factor + Reading Value.

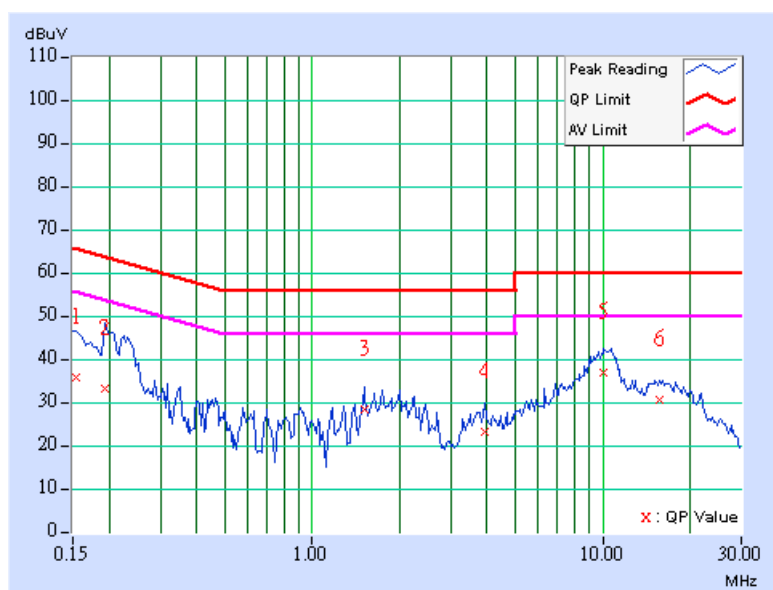

DRAFT 802.11n (40MHz) OFDM MODULATION:

EUT TEST CONDITION		MEASUREMENT DETAIL	
CHANNEL	Channel 1	PHASE	Line 1
MODULATION TYPE	BPSK	6dB BANDWIDTH	9 kHz
TRANSFER RATE	15.0Mbps	INPUT POWER (SYSTEM)	120Vac, 60 Hz
ENVIRONMENTAL CONDITIONS	20deg. C, 70% RH, 991hPa	TESTED BY	Brad Wu

No	FREQ. [MHz]	CORR. Factor (dB)	READING VALUE [dB (uV)]		EMISSION LEVEL [dB (uV)]		LIMIT [dB (uV)]		MARGIN (dB)	
			Q.P.	AV.	Q.P.	AV.	Q.P.	AV.	Q.P.	AV.
1	0.150	0.10	38.28	-	38.38	-	66.00	56.00	-27.62	-
2	0.213	0.10	32.82	-	32.92	-	63.11	53.11	-30.19	-
3	1.754	0.20	30.69	-	30.89	-	56.00	46.00	-25.11	-
4	3.664	0.42	22.80	-	23.22	-	56.00	46.00	-32.78	-
5	10.578	0.48	35.69	-	36.17	-	60.00	50.00	-23.83	-
6	15.148	0.64	29.16	-	29.80	-	60.00	50.00	-30.20	-

- REMARKS:**
1. Q.P. and AV. are abbreviations of quasi-peak and average individually.
 2. "-": The Quasi-peak reading value also meets average limit and measurement with the average detector is unnecessary.
 3. The emission levels of other frequencies were very low against the limit.
 4. Margin value = Emission level - Limit value
 5. Correction factor = Insertion loss + Cable loss
 6. Emission Level = Correction Factor + Reading Value.

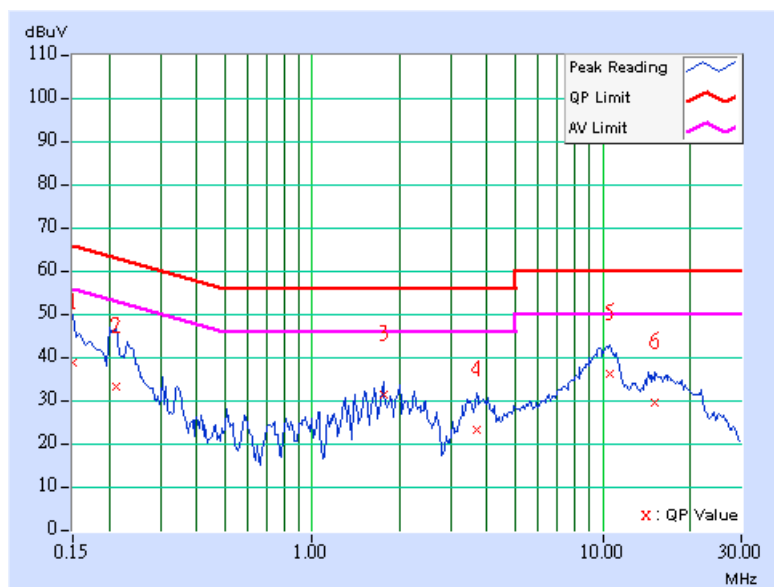

EUT TEST CONDITION		MEASUREMENT DETAIL	
CHANNEL	Channel 1	PHASE	Line 2
MODULATION TYPE	BPSK	6dB BANDWIDTH	9 kHz
TRANSFER RATE	15.0Mbps	INPUT POWER (SYSTEM)	120Vac, 60 Hz
ENVIRONMENTAL CONDITIONS	20deg. C, 70% RH, 991hPa	TESTED BY	Brad Wu

No	FREQ. [MHz]	CORR. Factor [dB]	READING VALUE [dB (uV)]		EMISSION LEVEL [dB (uV)]		LIMIT [dB (uV)]		MARGIN (dB)	
			Q.P.	AV.	Q.P.	AV.	Q.P.	AV.	Q.P.	AV.
1	0.150	0.10	37.34	-	37.44	-	66.00	56.00	-28.56	-
2	0.201	0.10	33.30	-	33.40	-	63.58	53.58	-30.18	-
3	2.000	0.20	29.95	-	30.15	-	56.00	46.00	-25.85	-
4	3.891	0.36	21.80	-	22.16	-	56.00	46.00	-33.84	-
5	10.465	0.47	36.32	-	36.79	-	60.00	50.00	-23.21	-
6	17.453	0.58	28.98	-	29.56	-	60.00	50.00	-30.44	-

- REMARKS:**
1. Q.P. and AV. are abbreviations of quasi-peak and average individually.
 2. "-": The Quasi-peak reading value also meets average limit and measurement with the average detector is unnecessary.
 3. The emission levels of other frequencies were very low against the limit.
 4. Margin value = Emission level - Limit value
 5. Correction factor = Insertion loss + Cable loss
 6. Emission Level = Correction Factor + Reading Value.

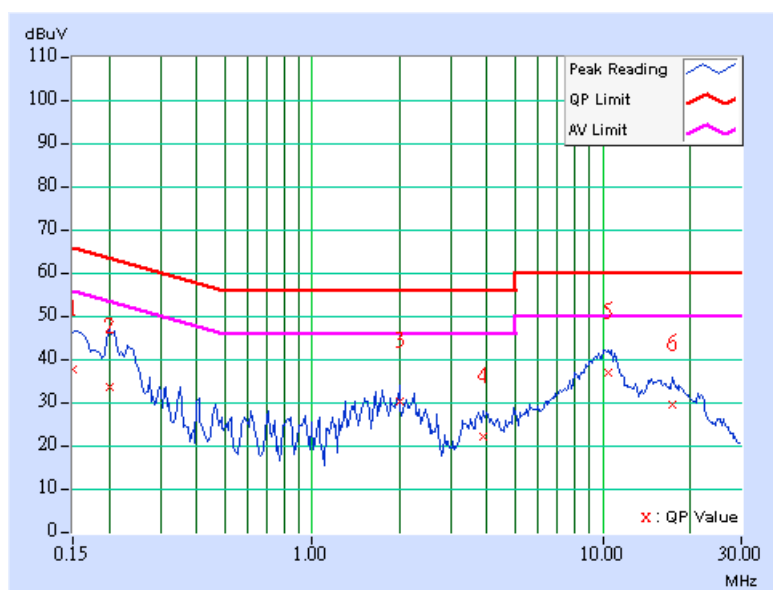

EUT TEST CONDITION		MEASUREMENT DETAIL	
CHANNEL	Channel 4	PHASE	Line 1
MODULATION TYPE	BPSK	6dB BANDWIDTH	9 kHz
TRANSFER RATE	15.0Mbps	INPUT POWER (SYSTEM)	120Vac, 60 Hz
ENVIRONMENTAL CONDITIONS	20deg. C, 70% RH, 991hPa	TESTED BY	Brad Wu

No	FREQ. [MHz]	CORR. Factor (dB)	READING VALUE [dB (uV)]		EMISSION LEVEL [dB (uV)]		LIMIT [dB (uV)]		MARGIN (dB)	
			Q.P.	AV.	Q.P.	AV.	Q.P.	AV.	Q.P.	AV.
1	0.150	0.10	37.86	-	37.96	-	66.00	56.00	-28.04	-
2	0.197	0.10	32.24	-	32.34	-	63.74	53.74	-31.40	-
3	1.996	0.20	30.54	-	30.74	-	56.00	46.00	-25.26	-
4	3.852	0.45	22.12	-	22.57	-	56.00	46.00	-33.43	-
5	10.313	0.47	36.42	-	36.89	-	60.00	50.00	-23.11	-
6	16.480	0.69	29.38	-	30.07	-	60.00	50.00	-29.93	-

- REMARKS:**
1. Q.P. and AV. are abbreviations of quasi-peak and average individually.
 2. "-": The Quasi-peak reading value also meets average limit and measurement with the average detector is unnecessary.
 3. The emission levels of other frequencies were very low against the limit.
 4. Margin value = Emission level - Limit value
 5. Correction factor = Insertion loss + Cable loss
 6. Emission Level = Correction Factor + Reading Value.

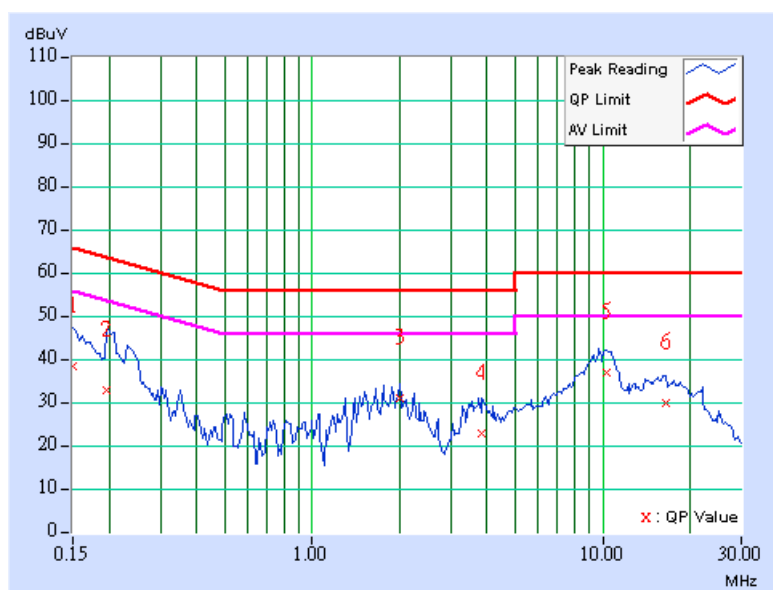

EUT TEST CONDITION		MEASUREMENT DETAIL	
CHANNEL	Channel 4	PHASE	Line 2
MODULATION TYPE	BPSK	6dB BANDWIDTH	9 kHz
TRANSFER RATE	15.0Mbps	INPUT POWER (SYSTEM)	120Vac, 60 Hz
ENVIRONMENTAL CONDITIONS	20deg. C, 70% RH, 991hPa	TESTED BY	Brad Wu

No	FREQ. [MHz]	CORR. Factor (dB)	READING VALUE [dB (uV)]		EMISSION LEVEL [dB (uV)]		LIMIT [dB (uV)]		MARGIN (dB)	
			Q.P.	AV.	Q.P.	AV.	Q.P.	AV.	Q.P.	AV.
1	0.150	0.10	37.68	-	37.78	-	66.00	56.00	-28.22	-
2	0.201	0.10	31.50	-	31.60	-	63.58	53.58	-31.98	-
3	1.758	0.18	30.18	-	30.36	-	56.00	46.00	-25.64	-
4	3.746	0.35	23.62	-	23.97	-	56.00	46.00	-32.03	-
5	9.949	0.46	36.24	-	36.70	-	60.00	50.00	-23.30	-
6	14.883	0.53	29.43	-	29.96	-	60.00	50.00	-30.04	-

- REMARKS:**
1. Q.P. and AV. are abbreviations of quasi-peak and average individually.
 2. "-": The Quasi-peak reading value also meets average limit and measurement with the average detector is unnecessary.
 3. The emission levels of other frequencies were very low against the limit.
 4. Margin value = Emission level - Limit value
 5. Correction factor = Insertion loss + Cable loss
 6. Emission Level = Correction Factor + Reading Value.

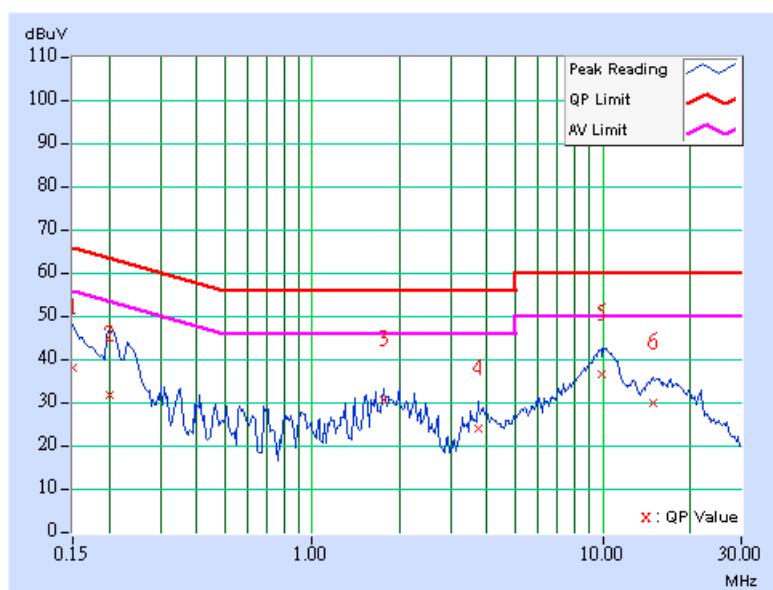

EUT TEST CONDITION		MEASUREMENT DETAIL	
CHANNEL	Channel 7	PHASE	Line 1
MODULATION TYPE	BPSK	6dB BANDWIDTH	9 kHz
TRANSFER RATE	15.0Mbps	INPUT POWER (SYSTEM)	120Vac, 60 Hz
ENVIRONMENTAL CONDITIONS	20deg. C, 70% RH, 991hPa	TESTED BY	Brad Wu

No	FREQ. [MHz]	CORR. Factor [dB]	READING VALUE [dB (uV)]		EMISSION LEVEL [dB (uV)]		LIMIT [dB (uV)]		MARGIN (dB)	
			Q.P.	AV.	Q.P.	AV.	Q.P.	AV.	Q.P.	AV.
1	0.150	0.10	38.06	-	38.16	-	66.00	56.00	-27.84	-
2	0.209	0.10	33.08	-	33.18	-	63.26	53.26	-30.08	-
3	1.754	0.20	30.62	-	30.82	-	56.00	46.00	-25.18	-
4	3.730	0.43	25.59	-	26.02	-	56.00	46.00	-29.98	-
5	10.586	0.48	35.79	-	36.27	-	60.00	50.00	-23.73	-
6	15.461	0.65	30.41	-	31.06	-	60.00	50.00	-28.94	-

- REMARKS:**
1. Q.P. and AV. are abbreviations of quasi-peak and average individually.
 2. "-": The Quasi-peak reading value also meets average limit and measurement with the average detector is unnecessary.
 3. The emission levels of other frequencies were very low against the limit.
 4. Margin value = Emission level - Limit value
 5. Correction factor = Insertion loss + Cable loss
 6. Emission Level = Correction Factor + Reading Value.

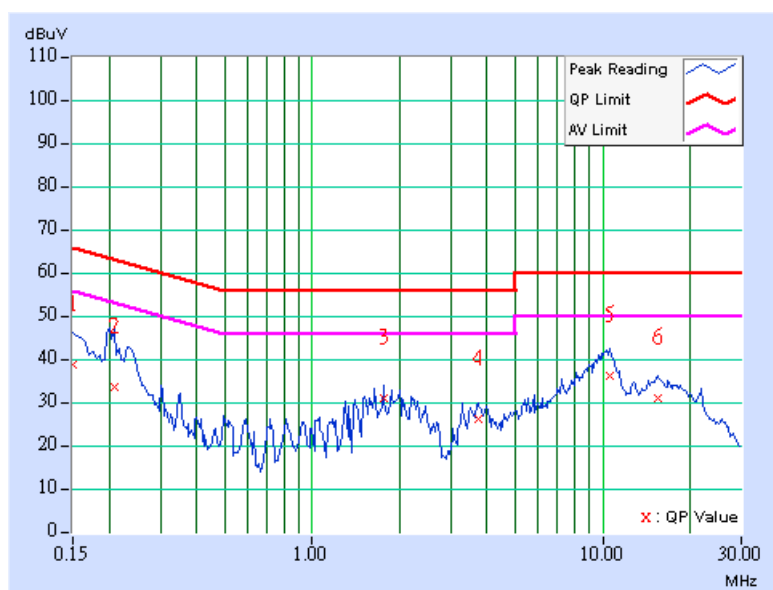

EUT TEST CONDITION		MEASUREMENT DETAIL	
CHANNEL	Channel 7	PHASE	Line 2
MODULATION TYPE	BPSK	6dB BANDWIDTH	9 kHz
TRANSFER RATE	15.0Mbps	INPUT POWER (SYSTEM)	120Vac, 60 Hz
ENVIRONMENTAL CONDITIONS	20deg. C, 70% RH, 991hPa	TESTED BY	Brad Wu

No	FREQ. [MHz]	CORR. Factor [dB]	READING VALUE [dB (uV)]		EMISSION LEVEL [dB (uV)]		LIMIT [dB (uV)]		MARGIN (dB)	
			Q.P.	AV.	Q.P.	AV.	Q.P.	AV.	Q.P.	AV.
1	0.150	0.10	38.02	-	38.12	-	66.00	56.00	-27.88	-
2	0.209	0.10	32.48	-	32.58	-	63.26	53.26	-30.68	-
3	0.349	0.10	29.69	-	29.79	-	58.98	48.98	-29.19	-
4	1.867	0.19	28.35	-	28.54	-	56.00	46.00	-27.46	-
5	10.328	0.46	35.38	-	35.84	-	60.00	50.00	-24.16	-
6	15.465	0.54	29.97	-	30.51	-	60.00	50.00	-29.49	-

- REMARKS:**
1. Q.P. and AV. are abbreviations of quasi-peak and average individually.
 2. "-": The Quasi-peak reading value also meets average limit and measurement with the average detector is unnecessary.
 3. The emission levels of other frequencies were very low against the limit.
 4. Margin value = Emission level - Limit value
 5. Correction factor = Insertion loss + Cable loss
 6. Emission Level = Correction Factor + Reading Value.

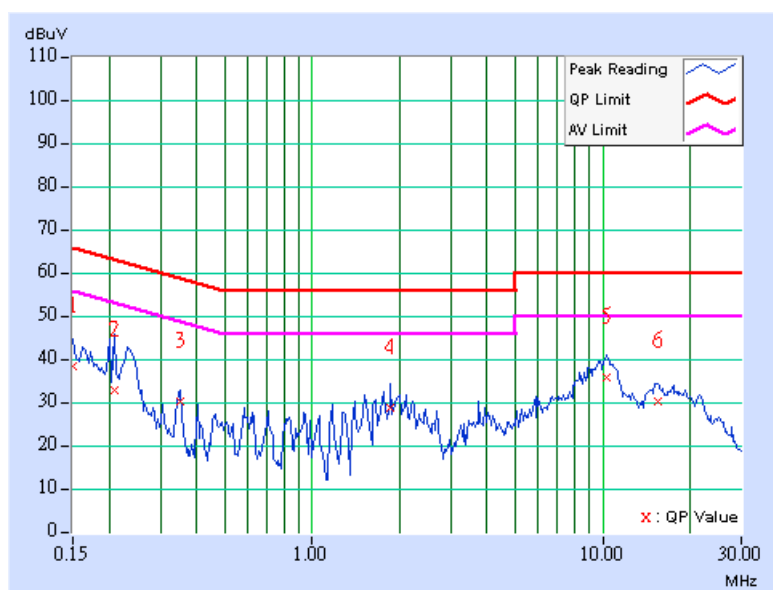

4.2 RADIATED EMISSION MEASUREMENT

4.2.1 LIMITS OF RADIATED EMISSION MEASUREMENT

Emissions radiated outside of the specified bands, shall be according to the general radiated limits in 15.209 as following:

FREQUENCIES (MHz)	FIELD STRENGTH (microvolts/meter)	MEASUREMENT DISTANCE (meters)
0.009 ~ 0.490	2400 / F(kHz)	300
0.490 ~ 1.705	24000 / F(kHz)	30
1.705 ~ 30.0	30	30
30 ~ 88	100	3
88 ~ 216	150	3
216 ~ 960	200	3
Above 960	500	3

NOTE:

1. The lower limit shall apply at the transition frequencies.
2. Emission level (dBuV/m) = 20 log Emission level (uV/m).
3. As shown in 15.35(b), for frequencies above 1000MHz, the field strength limits are based on average detector, however, the peak field strength of any emission shall not exceed the maximum permitted average limits, specified above by more than 20dB under any condition of modulation.

4.2.2 TEST INSTRUMENTS

DESCRIPTION & MANUFACTURER	MODEL NO.	SERIAL NO.	CALIBRATED UNTIL
Test Receiver ROHDE & SCHWARZ	ESI7	838496/016	Jan. 01, 2007
Spectrum Analyzer ROHDE & SCHWARZ	FSP40	100041	Dec. 04, 2006
BILOG Antenna SCHWARZBECK	VULB9168	9168-155	Jan. 15, 2007
HORN Antenna SCHWARZBECK	BBHA 9120D	9120D-404	Jan. 01, 2007
HORN Antenna SCHWARZBECK	BBHA 9170	BBHA9170242	Jan. 19, 2007
Preamplifier Agilent	8449B	3008A01960	Nov. 09, 2006
RF signal cable HUBER+SUHNNER	SUCOFLEX 104	219268/4	Dec. 20, 2006
RF signal cable HUBER+SUHNNER	SUCOFLEX 104	230129/4	Dec. 20, 2006
Software ADT.	ADT_Radiated_V5.14	NA	NA
Antenna Tower inn-co GmbH	MA 4000	010303	NA
Antenna Tower Controller inn-co GmbH	CO2000	019303	NA
Turn Table ADT.	TT100.	TT93021704	NA
Turn Table Controller ADT.	SC100.	SC93021704	NA

- NOTE:**
1. The calibration interval of the above test instruments is 12 months and the calibrations are traceable to NML/ROC and NIST/USA.
 2. The test was performed in HwaYa Chamber 3.
 3. The horn antenna and HP preamplifier (model: 8449B) are used only for the measurement of emission frequency above 1GHz if tested.
 4. The IC Site Registration No. is IC4924-4.

4.2.3 TEST PROCEDURES

- a. The EUT was placed on the top of a rotating table 0.8 meters above the ground at a 3 meters semi-anechoic chamber. The table was rotated 360 degrees to determine the position of the highest radiation.
- b. The EUT was set 3 meters away from the interference-receiving antenna, which was mounted on the top of a variable-height antenna tower.
- c. The antenna is a broadband antenna, and its height is varied from one meter to four meters above the ground to determine the maximum value of the field strength. Both horizontal and vertical polarizations of the antenna are set to make the measurement.
- d. For each suspected emission, the EUT was arranged to its worst case and then the antenna was tuned to heights from 1 meter to 4 meters and the rotatable table was turned from 0 degrees to 360 degrees to find the maximum reading.
- e. The test-receiver system was set to Peak Detect Function and Specified Bandwidth with Maximum Hold Mode.
- f. If the emission level of the EUT in peak mode was lower than the limit specified, then testing could be stopped and the peak values of the EUT would be reported. Otherwise the emissions would be re-tested one by one using peak, quasi-peak or average method as specified and then reported in a data sheet.

NOTE:

1. The resolution bandwidth and video bandwidth of test receiver/spectrum analyzer is 120kHz for Peak detection (PK) and Quasi-peak detection (QP) at frequency below 1GHz.
2. The resolution bandwidth and video bandwidth of test receiver/spectrum analyzer is 1 MHz for Peak detection at frequency above 1GHz.
3. The resolution bandwidth of test receiver/spectrum analyzer is 1MHz and the video bandwidth is 10Hz for Average detection (AV) at frequency above 1GHz.

4.2.4 DEVIATION FROM TEST STANDARD

No deviation

4.2.5 TEST SETUP

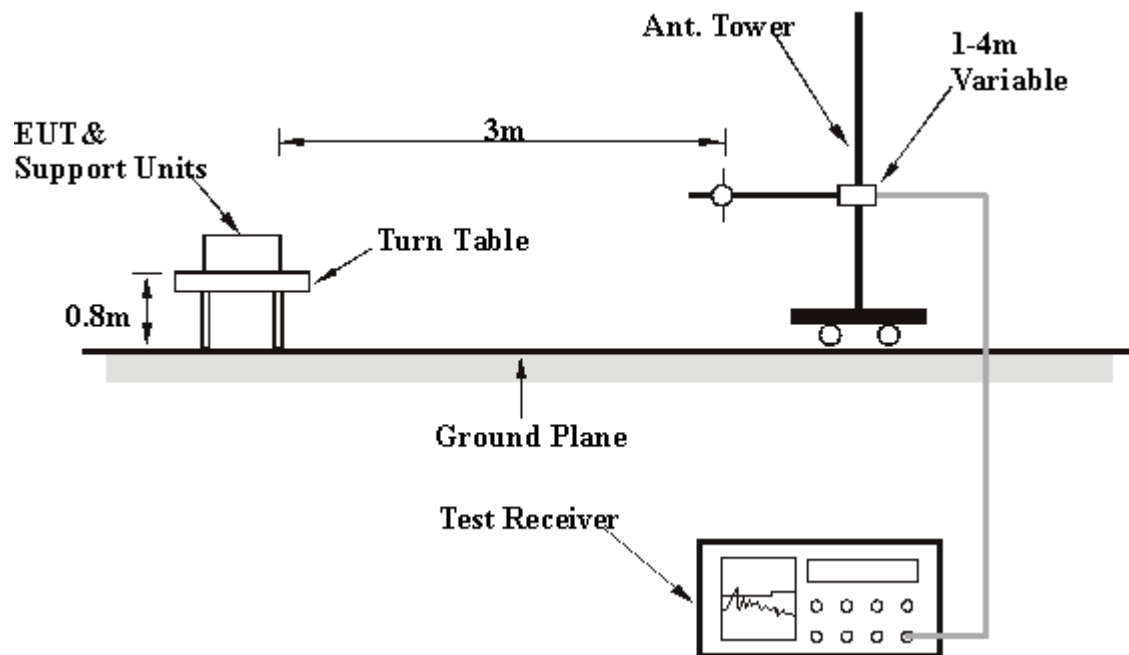

For the actual test configuration, please refer to the related item – Photographs of the Test Configuration.

4.2.6 EUT OPERATING CONDITIONS

Same as 4.1.6

4.2.7 TEST RESULTS

BELOW 1GHz WORST-CASE DATA:

EUT TEST CONDITION		MEASUREMENT DETAIL	
CHANNEL	Channel 1	FREQUENCY RANGE	Below 1000MHz
MODULATION TYPE	BPSK for 802.11g	INPUT POWER (SYSTEM)	120Vac, 60 Hz
TRANSFER RATE	6.0Mbps	DETECTOR FUNCTION	Quasi-Peak
ENVIRONMENTAL CONDITIONS	22deg. C, 64% RH, 991hPa	TESTED BY	Brad Wu

ANTENNA POLARITY & TEST DISTANCE: HORIZONTAL AT 3 M								
NO.	FREQ. (MHz)	EMISSION LEVEL (dBuV/m)	LIMIT (dBuV/m)	MARGIN (dB)	ANTENNA HEIGHT (m)	TABLE ANGLE (Degree)	RAW VALUE (dBuV)	CORRECTION FACTOR (dB/m)
1	164.13	30.14 QP	43.50	-13.36	1.00 H	346	17.16	12.97
2	331.30	36.80 QP	46.00	-9.20	1.00 H	208	20.94	15.86
3	397.39	39.48 QP	46.00	-6.52	1.25 H	325	21.77	17.71
4	467.37	33.43 QP	46.00	-12.57	1.50 H	355	14.30	19.13
5	665.65	35.65 QP	46.00	-10.35	1.25 H	241	12.21	23.44
6	930.02	38.63 QP	46.00	-7.37	1.75 H	256	9.77	28.85

ANTENNA POLARITY & TEST DISTANCE: VERTICAL AT 3 M								
NO.	FREQ. (MHz)	EMISSION LEVEL (dBuV/m)	LIMIT (dBuV/m)	MARGIN (dB)	ANTENNA HEIGHT (m)	TABLE ANGLE (Degree)	RAW VALUE (dBuV)	CORRECTION FACTOR (dB/m)
1	125.25	29.09 QP	43.50	-14.41	1.00 V	163	17.55	11.54
2	166.07	29.60 QP	43.50	-13.90	1.25 V	106	16.77	12.83
3	397.39	33.03 QP	46.00	-12.97	1.50 V	268	15.32	17.71
4	663.71	33.89 QP	46.00	-12.11	1.00 V	19	10.49	23.40
5	729.80	36.57 QP	46.00	-9.43	1.50 V	73	11.46	25.12
6	930.02	36.40 QP	46.00	-9.60	1.00 V	82	7.55	28.85

- REMARKS:**
1. Emission level (dBuV/m) = Raw Value (dBuV) + Correction Factor (dB/m).
 2. Correction Factor (dB/m) = Antenna Factor (dB/m) + Cable Factor (dB).
 3. The other emission levels were very low against the limit.
 4. Margin value = Emission level – Limit value.



EUT TEST CONDITION		MEASUREMENT DETAIL	
CHANNEL	Channel 1	FREQUENCY RANGE	Below 1000MHz
MODULATION TYPE	BPSK for draft 802.11n (20MHz)	INPUT POWER (SYSTEM)	120Vac, 60 Hz
TRANSFER RATE	7.2Mbps	DETECTOR FUNCTION	Quasi-Peak
ENVIRONMENTAL CONDITIONS	22deg. C, 64% RH, 991hPa	TESTED BY	Brad Wu

ANTENNA POLARITY & TEST DISTANCE: HORIZONTAL AT 3 M								
NO.	FREQ. (MHz)	EMISSION LEVEL (dBuV/m)	LIMIT (dBuV/m)	MARGIN (dB)	ANTENNA HEIGHT (m)	TABLE ANGLE (Degree)	RAW VALUE (dBuV)	CORRECTION FACTOR (dB/m)
1	164.13	31.65 QP	43.50	-11.85	1.75 H	25	18.68	12.97
2	331.30	36.45 QP	46.00	-9.55	1.25 H	187	20.59	15.86
3	399.34	39.01 QP	46.00	-6.99	1.75 H	25	21.24	17.78
4	467.37	36.74 QP	46.00	-9.26	1.75 H	67	17.61	19.13
5	663.71	34.54 QP	46.00	-11.46	1.25 H	250	11.14	23.40
6	733.69	31.99 QP	46.00	-14.01	1.25 H	241	6.75	25.25

ANTENNA POLARITY & TEST DISTANCE: VERTICAL AT 3 M								
NO.	FREQ. (MHz)	EMISSION LEVEL (dBuV/m)	LIMIT (dBuV/m)	MARGIN (dB)	ANTENNA HEIGHT (m)	TABLE ANGLE (Degree)	RAW VALUE (dBuV)	CORRECTION FACTOR (dB/m)
1	123.31	30.54 QP	43.50	-12.96	1.00 V	67	19.25	11.28
2	333.25	27.15 QP	46.00	-18.85	1.00 V	292	11.27	15.89
3	397.39	31.54 QP	46.00	-14.46	1.00 V	253	13.83	17.71
4	545.13	31.31 QP	46.00	-14.69	1.00 V	13	10.41	20.90
5	663.71	32.15 QP	46.00	-13.85	1.00 V	37	8.75	23.40
6	733.69	33.34 QP	46.00	-12.66	1.00 V	283	8.09	25.25

- REMARKS:**
1. Emission level (dBuV/m) = Raw Value (dBuV) + Correction Factor (dB/m).
 2. Correction Factor (dB/m) = Antenna Factor (dB/m) + Cable Factor (dB).
 3. The other emission levels were very low against the limit.
 4. Margin value = Emission level – Limit value.

EUT TEST CONDITION		MEASUREMENT DETAIL	
CHANNEL	Channel 1	FREQUENCY RANGE	Below 1000MHz
MODULATION TYPE	BPSK for draft 802.11n (40MHz)	INPUT POWER (SYSTEM)	120Vac, 60 Hz
TRANSFER RATE	15.0Mbps	DETECTOR FUNCTION	Quasi-Peak
ENVIRONMENTAL CONDITIONS	22deg. C, 63%RH, 991hPa	TESTED BY	Brad Wu

ANTENNA POLARITY & TEST DISTANCE: HORIZONTAL AT 3 M								
NO.	FREQ. (MHz)	EMISSION LEVEL (dBuV/m)	LIMIT (dBuV/m)	MARGIN (dB)	ANTENNA HEIGHT (m)	TABLE ANGLE (Degree)	RAW VALUE (dBuV)	CORRECTION FACTOR (dB/m)
1	131.08	30.57 QP	43.50	-12.93	1.50 H	52	18.27	12.30
2	333.25	39.21 QP	46.00	-6.79	1.00 H	334	23.32	15.89
3	399.34	37.35 QP	46.00	-8.65	1.00 H	265	19.58	17.78
4	665.65	32.22 QP	46.00	-13.78	1.00 H	319	8.78	23.44
5	733.69	33.61 QP	46.00	-12.39	1.00 H	34	8.37	25.25
6	928.08	35.27 QP	46.00	-10.73	1.25 H	43	6.51	28.76

ANTENNA POLARITY & TEST DISTANCE: VERTICAL AT 3 M								
NO.	FREQ. (MHz)	EMISSION LEVEL (dBuV/m)	LIMIT (dBuV/m)	MARGIN (dB)	ANTENNA HEIGHT (m)	TABLE ANGLE (Degree)	RAW VALUE (dBuV)	CORRECTION FACTOR (dB/m)
1	123.31	28.60 QP	43.50	-14.90	1.25 V	73	17.32	11.28
2	333.25	27.65 QP	46.00	-18.35	1.00 V	355	11.77	15.89
3	397.39	32.44 QP	46.00	-13.56	1.00 V	310	14.73	17.71
4	543.19	30.92 QP	46.00	-15.08	1.00 V	304	10.06	20.86
5	572.34	31.22 QP	46.00	-14.78	1.00 V	106	9.52	21.69
6	729.80	31.10 QP	46.00	-14.90	1.25 V	253	5.98	25.12

- REMARKS:**
1. Emission level (dBuV/m) = Raw Value (dBuV) + Correction Factor (dB/m).
 2. Correction Factor (dB/m) = Antenna Factor (dB/m) + Cable Factor (dB).
 3. The other emission levels were very low against the limit.
 4. Margin value = Emission level – Limit value.

802.11b DSSS MODULATION:

EUT TEST CONDITION		MEASUREMENT DETAIL	
CHANNEL	Channel 1	FREQUENCY RANGE	1 ~ 25GHz
MODULATION TYPE	DBPSK	INPUT POWER (SYSTEM)	120Vac, 60 Hz
TRANSFER RATE	1.0Mbps	DETECTOR FUNCTION	Peak(PK) Average (AV)
ENVIRONMENTAL CONDITIONS	22deg. C, 64% RH, 991hPa	TESTED BY	Brad Wu

ANTENNA POLARITY & TEST DISTANCE: HORIZONTAL AT 3 M								
NO.	FREQ. (MHz)	EMISSION LEVEL (dBuV/m)	LIMIT (dBuV/m)	MARGIN (dB)	ANTENNA HEIGHT (m)	TABLE ANGLE (Degree)	RAW VALUE (dBuV)	CORRECTION FACTOR (dB/m)
1	2390.00	56.95 PK	74.00	-17.05	1.32 H	272	24.84	32.11
1	2390.00	52.60 AV	54.00	-1.40	1.32 H	272	20.49	32.11
2	*2412.00	115.31 PK			1.32 H	272	83.12	32.19
2	*2412.00	110.96 AV			1.32 H	272	78.77	32.19
3	4824.00	52.20 PK	74.00	-21.80	1.49 H	307	13.55	38.65
3	4824.00	43.13 AV	54.00	-10.87	1.49 H	307	4.48	38.65
4	7236.00	55.68 PK	95.31	-39.63	1.36 H	195	10.47	45.21
4	7236.00	43.40 AV	90.96	-47.56	1.36 H	195	-1.81	45.21

ANTENNA POLARITY & TEST DISTANCE: VERTICAL AT 3 M								
NO.	FREQ. (MHz)	EMISSION LEVEL (dBuV/m)	LIMIT (dBuV/m)	MARGIN (dB)	ANTENNA HEIGHT (m)	TABLE ANGLE (Degree)	RAW VALUE (dBuV)	CORRECTION FACTOR (dB/m)
1	2390.00	48.83 PK	74.00	-25.17	1.04 V	105	16.72	32.11
1	2390.00	44.72 AV	54.00	-9.28	1.04 V	105	12.61	32.11
2	*2412.00	107.19 PK			1.04 V	105	75.00	32.19
2	*2412.00	103.08 AV			1.04 V	105	70.89	32.19
3	4824.00	52.54 PK	74.00	-21.46	1.08 V	228	13.89	38.65
3	4824.00	45.47 AV	54.00	-8.53	1.08 V	228	6.82	38.65
4	7236.00	58.09 PK	87.19	-29.10	1.09 V	239	12.88	45.21
4	7236.00	48.60 AV	83.08	-34.48	1.09 V	239	3.39	45.21

- REMARKS:**
1. Emission level (dBuV/m) = Raw Value (dBuV) + Correction Factor (dB/m).
 2. Correction Factor (dB/m) = Antenna Factor (dB/m) + Cable Factor (dB).
 3. The other emission levels were very low against the limit.
 4. Margin value = Emission level – Limit value.
 5. The limit value is defined as per 15.247.
 6. “ * “: Fundamental frequency.



EUT TEST CONDITION		MEASUREMENT DETAIL	
CHANNEL	Channel 6	FREQUENCY RANGE	1 ~ 25GHz
MODULATION TYPE	DBPSK	INPUT POWER (SYSTEM)	120Vac, 60 Hz
TRANSFER RATE	1.0Mbps	DETECTOR FUNCTION	Peak(PK) Average (AV)
ENVIRONMENTAL CONDITIONS	22deg. C, 64% RH, 991hPa	TESTED BY	Brad Wu

ANTENNA POLARITY & TEST DISTANCE: HORIZONTAL AT 3 M								
NO.	FREQ. (MHz)	EMISSION LEVEL (dBuV/m)	LIMIT (dBuV/m)	MARGIN (dB)	ANTENNA HEIGHT (m)	TABLE ANGLE (Degree)	RAW VALUE (dBuV)	CORRECTION FACTOR (dB/m)
1	2356.00	64.33 PK	74.00	-9.67	1.31 H	261	32.35	31.98
1	2356.00	52.89 AV	54.00	-1.11	1.31 H	261	20.91	31.98
2	*2437.00	115.50 PK			1.31 H	261	83.21	32.29
2	*2437.00	111.36 AV			1.31 H	261	79.07	32.29
3	4874.00	54.03 PK	74.00	-19.97	1.09 H	232	15.24	38.79
3	4874.00	47.49 AV	54.00	-6.51	1.09 H	232	8.70	38.79
4	7310.00	56.54 PK	74.00	-17.46	1.00 H	200	11.14	45.41
4	7310.00	44.77 AV	54.00	-9.23	1.00 H	200	-0.63	45.41

ANTENNA POLARITY & TEST DISTANCE: VERTICAL AT 3 M								
NO.	FREQ. (MHz)	EMISSION LEVEL (dBuV/m)	LIMIT (dBuV/m)	MARGIN (dB)	ANTENNA HEIGHT (m)	TABLE ANGLE (Degree)	RAW VALUE (dBuV)	CORRECTION FACTOR (dB/m)
1	*2437.00	108.17 PK			1.00 V	105	75.88	32.29
1	*2437.00	103.54 AV			1.00 V	105	71.25	32.29
2	4874.00	53.89 PK	74.00	-20.11	1.06 V	255	15.10	38.79
2	4874.00	47.55 AV	54.00	-6.45	1.06 V	255	8.76	38.79
3	7310.00	59.35 PK	74.00	-14.65	1.00 V	242	13.95	45.41
3	7310.00	48.86 AV	54.00	-5.14	1.00 V	242	3.45	45.41

- REMARKS:**
1. Emission level (dBuV/m) = Raw Value (dBuV) + Correction Factor (dB/m).
 2. Correction Factor (dB/m) = Antenna Factor (dB/m) + Cable Factor (dB).
 3. The other emission levels were very low against the limit.
 4. Margin value = Emission level – Limit value.
 5. The limit value is defined as per 15.247.
 6. “ * “: Fundamental frequency.



EUT TEST CONDITION		MEASUREMENT DETAIL	
CHANNEL	Channel 11	FREQUENCY RANGE	1 ~ 25GHz
MODULATION TYPE	DBPSK	INPUT POWER (SYSTEM)	120Vac, 60 Hz
TRANSFER RATE	1.0Mbps	DETECTOR FUNCTION	Peak(PK) Average (AV)
ENVIRONMENTAL CONDITIONS	22deg. C, 64% RH, 991hPa	TESTED BY	Brad Wu

ANTENNA POLARITY & TEST DISTANCE: HORIZONTAL AT 3 M								
NO.	FREQ. (MHz)	EMISSION LEVEL (dBuV/m)	LIMIT (dBuV/m)	MARGIN (dB)	ANTENNA HEIGHT (m)	TABLE ANGLE (Degree)	RAW VALUE (dBuV)	CORRECTION FACTOR (dB/m)
1	*2462.00	114.50 PK			1.33 H	273	82.12	32.38
1	*2462.00	110.16 AV			1.33 H	273	77.78	32.38
2	2483.50	56.86 PK	74.00	-17.14	1.33 H	273	24.40	32.46
2	2483.50	52.52 AV	54.00	-1.48	1.33 H	273	20.06	32.46
3	4924.00	51.58 PK	74.00	-22.42	1.10 H	358	12.66	38.92
3	4924.00	41.79 AV	54.00	-12.21	1.10 H	358	2.87	38.92
4	7386.00	57.13 PK	74.00	-16.87	1.00 H	174	11.53	45.59
4	7386.00	45.59 AV	54.00	-8.41	1.00 H	174	-0.01	45.59

ANTENNA POLARITY & TEST DISTANCE: VERTICAL AT 3 M								
NO.	FREQ. (MHz)	EMISSION LEVEL (dBuV/m)	LIMIT (dBuV/m)	MARGIN (dB)	ANTENNA HEIGHT (m)	TABLE ANGLE (Degree)	RAW VALUE (dBuV)	CORRECTION FACTOR (dB/m)
1	*2462.00	106.51 PK			1.00 V	106	74.13	32.38
1	*2462.00	102.43 AV			1.00 V	106	70.05	32.38
2	2483.50	48.87 PK	74.00	-25.13	1.00 V	106	16.41	32.46
2	2483.50	44.79 AV	54.00	-9.21	1.00 V	106	12.33	32.46
3	4924.00	51.38 PK	74.00	-22.62	1.17 V	235	12.46	38.92
3	4924.00	41.55 AV	54.00	-12.45	1.17 V	235	2.63	38.92
4	7386.00	60.66 PK	74.00	-13.34	1.00 V	230	15.06	45.59
4	7386.00	51.95 AV	54.00	-2.05	1.00 V	230	6.35	45.59

- REMARKS:**
1. Emission level (dBuV/m) = Raw Value (dBuV) + Correction Factor (dB/m).
 2. Correction Factor (dB/m) = Antenna Factor (dB/m) + Cable Factor (dB).
 3. The other emission levels were very low against the limit.
 4. Margin value = Emission level – Limit value.
 5. The limit value is defined as per 15.247.
 6. “ * “: Fundamental frequency.

802.11g OFDM MODULATION:

EUT TEST CONDITION		MEASUREMENT DETAIL	
CHANNEL	Channel 1	FREQUENCY RANGE	1 ~ 25GHz
MODULATION TYPE	BPSK	INPUT POWER (SYSTEM)	120Vac, 60 Hz
TRANSFER RATE	6.0Mbps	DETECTOR FUNCTION	Peak(PK) Average (AV)
ENVIRONMENTAL CONDITIONS	22deg. C, 64% RH, 991hPa	TESTED BY	Brad Wu

ANTENNA POLARITY & TEST DISTANCE: HORIZONTAL AT 3 M								
NO.	FREQ. (MHz)	EMISSION LEVEL (dBuV/m)	LIMIT (dBuV/m)	MARGIN (dB)	ANTENNA HEIGHT (m)	TABLE ANGLE (Degree)	RAW VALUE (dBuV)	CORRECTION FACTOR (dB/m)
1	2390.00	71.95 PK	74.00	-2.05	1.34 H	273	39.84	32.11
1	2390.00	52.96 AV	54.00	-1.04	1.34 H	273	20.85	32.11
2	*2412.00	114.40 PK			1.33 H	270	82.21	32.19
2	*2412.00	102.85 AV			1.33 H	270	70.66	32.19
3	4824.00	50.29 PK	74.00	-23.71	1.03 H	214	11.64	38.65
3	4824.00	37.54 AV	54.00	-16.46	1.03 H	214	-1.11	38.65
4	7236.00	53.15 PK	94.40	-41.25	1.00 H	18	7.94	45.21
4	7236.00	40.62 AV	82.85	-42.23	1.00 H	18	-4.59	45.21

ANTENNA POLARITY & TEST DISTANCE: VERTICAL AT 3 M								
NO.	FREQ. (MHz)	EMISSION LEVEL (dBuV/m)	LIMIT (dBuV/m)	MARGIN (dB)	ANTENNA HEIGHT (m)	TABLE ANGLE (Degree)	RAW VALUE (dBuV)	CORRECTION FACTOR (dB/m)
1	2390.00	63.47 PK	74.00	-10.53	1.36 V	212	31.36	32.11
1	2390.00	44.24 AV	54.00	-9.76	1.36 V	212	12.13	32.11
2	*2412.00	105.92 PK			1.36 V	212	73.73	32.19
2	*2412.00	94.13 AV			1.36 V	212	61.94	32.19
3	4824.00	52.37 PK	74.00	-21.63	1.10 V	165	13.72	38.65
3	4824.00	39.69 AV	54.00	-14.31	1.10 V	165	1.04	38.65
4	7236.00	55.23 PK	85.92	-30.69	1.06 V	29	10.02	45.21
4	7236.00	42.70 AV	74.13	-31.43	1.06 V	29	-2.51	45.21

- REMARKS:**
1. Emission level (dBuV/m) = Raw Value (dBuV) + Correction Factor (dB/m).
 2. Correction Factor (dB/m) = Antenna Factor (dB/m) + Cable Factor (dB).
 3. The other emission levels were very low against the limit.
 4. Margin value = Emission level – Limit value.
 5. The limit value is defined as per 15.247.
 6. “ * “: Fundamental frequency.



EUT TEST CONDITION		MEASUREMENT DETAIL	
CHANNEL	Channel 6	FREQUENCY RANGE	1 ~ 25GHz
MODULATION TYPE	BPSK	INPUT POWER (SYSTEM)	120Vac, 60 Hz
TRANSFER RATE	6.0Mbps	DETECTOR FUNCTION	Peak(PK) Average (AV)
ENVIRONMENTAL CONDITIONS	22deg. C, 64% RH, 991hPa	TESTED BY	Brad Wu

ANTENNA POLARITY & TEST DISTANCE: HORIZONTAL AT 3 M								
NO.	FREQ. (MHz)	EMISSION LEVEL (dBuV/m)	LIMIT (dBuV/m)	MARGIN (dB)	ANTENNA HEIGHT (m)	TABLE ANGLE (Degree)	RAW VALUE (dBuV)	CORRECTION FACTOR (dB/m)
1	2390.00	65.08 PK	74.00	-8.92	1.33 H	271	32.97	32.11
1	2390.00	52.31 AV	54.00	-1.69	1.33 H	271	20.20	32.11
2	*2437.00	117.41 PK			1.31 H	273	85.12	32.29
2	*2437.00	106.01 AV			1.31 H	273	73.72	32.29
3	4874.00	51.74 PK	74.00	-22.26	1.05 H	226	12.95	38.79
3	4874.00	39.02 AV	54.00	-14.98	1.05 H	226	0.23	38.79
4	7311.00	54.38 PK	74.00	-19.62	1.05 H	27	8.97	45.41
4	7311.00	41.95 AV	54.00	-12.05	1.05 H	27	-3.46	45.41

ANTENNA POLARITY & TEST DISTANCE: VERTICAL AT 3 M								
NO.	FREQ. (MHz)	EMISSION LEVEL (dBuV/m)	LIMIT (dBuV/m)	MARGIN (dB)	ANTENNA HEIGHT (m)	TABLE ANGLE (Degree)	RAW VALUE (dBuV)	CORRECTION FACTOR (dB/m)
1	*2437.00	108.97 PK			1.35 V	211	76.68	32.29
1	*2437.00	97.22 AV			1.35 V	211	64.93	32.29
2	4874.00	54.86 PK	74.00	-19.14	1.07 V	159	16.07	38.79
2	4874.00	41.87 AV	54.00	-12.13	1.07 V	159	3.08	38.79
3	7311.00	57.42 PK	74.00	-16.58	1.04 V	36	12.01	45.41
3	7311.00	44.81 AV	54.00	-9.19	1.04 V	36	-0.60	45.41

- REMARKS:**
1. Emission level (dBuV/m) = Raw Value (dBuV) + Correction Factor (dB/m).
 2. Correction Factor (dB/m) = Antenna Factor (dB/m) + Cable Factor (dB).
 3. The other emission levels were very low against the limit.
 4. Margin value = Emission level – Limit value.
 5. The limit value is defined as per 15.247.
 6. “ * “: Fundamental frequency.

EUT TEST CONDITION		MEASUREMENT DETAIL	
CHANNEL	Channel 11	FREQUENCY RANGE	1 ~ 25GHz
MODULATION TYPE	BPSK	INPUT POWER (SYSTEM)	120Vac, 60 Hz
TRANSFER RATE	6.0Mbps	DETECTOR FUNCTION	Peak(PK) Average (AV)
ENVIRONMENTAL CONDITIONS	22deg. C, 64% RH, 991hPa	TESTED BY	Brad Wu

ANTENNA POLARITY & TEST DISTANCE: HORIZONTAL AT 3 M								
NO.	FREQ. (MHz)	EMISSION LEVEL (dBuV/m)	LIMIT (dBuV/m)	MARGIN (dB)	ANTENNA HEIGHT (m)	TABLE ANGLE (Degree)	RAW VALUE (dBuV)	CORRECTION FACTOR (dB/m)
1	*2462.00	115.06 PK			1.30 H	270	82.68	32.38
1	*2462.00	103.20 AV			1.30 H	270	70.82	32.38
2	2483.50	71.38 PK	74.00	-2.62	1.30 H	270	38.92	32.46
2	2483.50	52.67 AV	54.00	-1.33	1.30 H	270	20.21	32.46
3	4924.00	50.67 PK	74.00	-23.33	1.06 H	267	11.75	38.92
3	4924.00	37.98 AV	54.00	-16.02	1.06 H	267	-0.94	38.92
4	7386.00	53.27 PK	74.00	-20.73	1.03 H	27	7.68	45.59
4	7386.00	40.74 AV	54.00	-13.26	1.03 H	27	-4.85	45.59

ANTENNA POLARITY & TEST DISTANCE: VERTICAL AT 3 M								
NO.	FREQ. (MHz)	EMISSION LEVEL (dBuV/m)	LIMIT (dBuV/m)	MARGIN (dB)	ANTENNA HEIGHT (m)	TABLE ANGLE (Degree)	RAW VALUE (dBuV)	CORRECTION FACTOR (dB/m)
1	*2462.00	106.35 PK			1.35 V	213	73.97	32.38
1	*2462.00	94.56 AV			1.35 V	213	62.18	32.38
2	2483.50	62.57 PK	74.00	-11.43	1.35 V	213	30.11	32.46
2	2483.50	44.03 AV	54.00	-9.97	1.35 V	213	11.57	32.46
3	4924.00	51.64 PK	74.00	-22.36	1.13 V	146	12.72	38.92
3	4924.00	38.92 AV	54.00	-15.08	1.13 V	146	0.00	38.92
4	7386.00	54.19 PK	74.00	-19.81	1.04 V	56	8.59	45.59
4	7386.00	41.58 AV	54.00	-12.42	1.04 V	56	-4.02	45.59

- REMARKS:**
1. Emission level (dBuV/m) = Raw Value (dBuV) + Correction Factor (dB/m).
 2. Correction Factor (dB/m) = Antenna Factor (dB/m) + Cable Factor (dB).
 3. The other emission levels were very low against the limit.
 4. Margin value = Emission level – Limit value.
 5. The limit value is defined as per 15.247.
 6. “ * “: Fundamental frequency.

DRAFT 802.11n (20MHz) OFDM MODULATION:

EUT TEST CONDITION		MEASUREMENT DETAIL	
CHANNEL	Channel 1	FREQUENCY RANGE	1 ~ 25GHz
MODULATION TYPE	BPSK	INPUT POWER (SYSTEM)	120Vac, 60 Hz
TRANSFER RATE	7.2Mbps	DETECTOR FUNCTION	Peak(PK) Average (AV)
ENVIRONMENTAL CONDITIONS	22deg. C, 64% RH, 991hPa	TESTED BY	Brad Wu

ANTENNA POLARITY & TEST DISTANCE: HORIZONTAL AT 3 M								
NO.	FREQ. (MHz)	EMISSION LEVEL (dBuV/m)	LIMIT (dBuV/m)	MARGIN (dB)	ANTENNA HEIGHT (m)	TABLE ANGLE (Degree)	RAW VALUE (dBuV)	CORRECTION FACTOR (dB/m)
1	2390.00	66.66 PK	74.00	-7.34	1.00 H	195	34.55	32.11
1	2390.00	52.78 AV	54.00	-1.22	1.00 H	195	20.67	32.11
2	*2412.00	112.87 PK			1.38 H	272	80.68	32.19
2	*2412.00	101.69 AV			1.38 H	272	69.50	32.19
3	4824.00	48.80 PK	74.00	-25.20	1.00 H	125	10.15	38.65
3	4824.00	36.97 AV	54.00	-17.03	1.00 H	125	-1.68	38.65
4	7236.00	55.87 PK	92.87	-37.00	1.00 H	221	10.66	45.21
4	7236.00	43.12 AV	81.69	-38.57	1.00 H	221	-2.09	45.21

ANTENNA POLARITY & TEST DISTANCE: VERTICAL AT 3 M								
NO.	FREQ. (MHz)	EMISSION LEVEL (dBuV/m)	LIMIT (dBuV/m)	MARGIN (dB)	ANTENNA HEIGHT (m)	TABLE ANGLE (Degree)	RAW VALUE (dBuV)	CORRECTION FACTOR (dB/m)
1	2390.00	55.53 PK	74.00	-18.47	1.27 V	203	23.42	32.11
1	2390.00	43.41 AV	54.00	-10.59	1.27 V	203	11.30	32.11
2	*2412.00	104.44 PK			1.27 V	203	72.25	32.19
2	*2412.00	92.32 AV			1.27 V	203	60.13	32.19
3	4824.00	50.92 PK	74.00	-23.08	1.02 V	135	12.27	38.65
3	4824.00	39.04 AV	54.00	-14.96	1.02 V	135	0.39	38.65
4	7236.00	57.96 PK	84.44	-26.48	1.01 V	234	12.75	45.21
4	7236.00	45.24 AV	72.32	-27.08	1.01 V	234	0.03	45.21

- REMARKS:**
1. Emission level (dBuV/m) = Raw Value (dBuV) + Correction Factor (dB/m).
 2. Correction Factor (dB/m) = Antenna Factor (dB/m) + Cable Factor (dB).
 3. The other emission levels were very low against the limit.
 4. Margin value = Emission level – Limit value.
 5. The limit value is defined as per 15.247.
 6. “ * “: Fundamental frequency.

EUT TEST CONDITION		MEASUREMENT DETAIL	
CHANNEL	Channel 6	FREQUENCY RANGE	1 ~ 25GHz
MODULATION TYPE	BPSK	INPUT POWER (SYSTEM)	120Vac, 60 Hz
TRANSFER RATE	7.2Mbps	DETECTOR FUNCTION	Peak(PK) Average (AV)
ENVIRONMENTAL CONDITIONS	22deg. C, 64% RH, 991hPa	TESTED BY	Brad Wu

ANTENNA POLARITY & TEST DISTANCE: HORIZONTAL AT 3 M								
NO.	FREQ. (MHz)	EMISSION LEVEL (dBuV/m)	LIMIT (dBuV/m)	MARGIN (dB)	ANTENNA HEIGHT (m)	TABLE ANGLE (Degree)	RAW VALUE (dBuV)	CORRECTION FACTOR (dB/m)
1	2390.00	61.99 PK	74.00	-12.01	1.36 H	273	29.88	32.11
1	2390.00	52.18 AV	54.00	-1.82	1.36 H	273	20.07	32.11
2	*2437.00	115.34 PK			1.36 H	273	83.05	32.29
2	*2437.00	104.19 AV			1.36 H	273	71.90	32.29
3	2483.50	60.01 PK	74.00	-13.99	1.36 H	273	27.55	32.46
3	2483.50	49.86 AV	54.00	-4.14	1.36 H	273	17.40	32.46
4	4874.00	49.26 PK	74.00	-24.74	1.08 H	129	10.47	38.79
4	4874.00	37.35 AV	54.00	-16.65	1.08 H	129	-1.44	38.79
5	7311.00	56.35 PK	74.00	-17.65	1.18 H	124	10.94	45.41
5	7311.00	43.98 AV	54.00	-10.02	1.18 H	124	-1.43	45.41

ANTENNA POLARITY & TEST DISTANCE: VERTICAL AT 3 M								
NO.	FREQ. (MHz)	EMISSION LEVEL (dBuV/m)	LIMIT (dBuV/m)	MARGIN (dB)	ANTENNA HEIGHT (m)	TABLE ANGLE (Degree)	RAW VALUE (dBuV)	CORRECTION FACTOR (dB/m)
1	2390.00	54.37 PK	74.00	-19.63	1.20 V	204	22.26	32.11
1	2390.00	42.26 AV	54.00	-11.74	1.20 V	204	10.15	32.11
2	*2437.00	106.38 PK			1.20 V	204	74.09	32.29
2	*2437.00	94.27 AV			1.20 V	204	61.98	32.29
3	2483.50	52.05 PK	74.00	-21.95	1.20 V	204	19.59	32.46
3	2483.50	39.94 AV	54.00	-14.06	1.20 V	204	7.48	32.46
4	4874.00	51.64 PK	74.00	-22.36	1.15 V	137	12.85	38.79
4	4874.00	39.82 AV	54.00	-14.18	1.15 V	137	1.03	38.79
5	7311.00	58.26 PK	74.00	-15.74	1.06 V	174	12.85	45.41
5	7311.00	45.89 AV	54.00	-8.11	1.06 V	174	0.48	45.41

- REMARKS:**
1. Emission level (dBuV/m) = Raw Value (dBuV) + Correction Factor (dB/m).
 2. Correction Factor (dB/m) = Antenna Factor (dB/m) + Cable Factor (dB).
 3. The other emission levels were very low against the limit.
 4. Margin value = Emission level – Limit value.
 5. The limit value is defined as per 15.247.
 6. “ * “: Fundamental frequency.



EUT TEST CONDITION		MEASUREMENT DETAIL	
CHANNEL	Channel 11	FREQUENCY RANGE	1 ~ 25GHz
MODULATION TYPE	BPSK	INPUT POWER (SYSTEM)	120Vac, 60 Hz
TRANSFER RATE	7.2Mbps	DETECTOR FUNCTION	Peak(PK) Average (AV)
ENVIRONMENTAL CONDITIONS	22deg. C, 64% RH, 991hPa	TESTED BY	Brad Wu

ANTENNA POLARITY & TEST DISTANCE: HORIZONTAL AT 3 M								
NO.	FREQ. (MHz)	EMISSION LEVEL (dBuV/m)	LIMIT (dBuV/m)	MARGIN (dB)	ANTENNA HEIGHT (m)	TABLE ANGLE (Degree)	RAW VALUE (dBuV)	CORRECTION FACTOR (dB/m)
1	*2462.00	112.79 PK			1.32 H	266	80.41	32.38
1	*2462.00	101.45 AV			1.32 H	266	69.07	32.38
2	2483.50	68.22 PK	74.00	-5.78	1.32 H	266	35.76	32.46
2	2483.50	52.81 AV	54.00	-1.19	1.32 H	266	20.35	32.46
3	4924.00	48.11 PK	74.00	-25.89	1.10 H	130	9.19	38.92
3	4924.00	36.24 AV	54.00	-17.76	1.10 H	130	-2.68	38.92
4	7386.00	55.24 PK	74.00	-18.76	1.20 H	122	9.65	45.59
4	7386.00	42.89 AV	54.00	-11.11	1.20 H	122	-2.70	45.59

ANTENNA POLARITY & TEST DISTANCE: VERTICAL AT 3 M								
NO.	FREQ. (MHz)	EMISSION LEVEL (dBuV/m)	LIMIT (dBuV/m)	MARGIN (dB)	ANTENNA HEIGHT (m)	TABLE ANGLE (Degree)	RAW VALUE (dBuV)	CORRECTION FACTOR (dB/m)
1	*2462.00	104.22 PK			1.21 V	201	71.84	32.38
1	*2462.00	92.15 AV			1.21 V	201	59.77	32.38
2	2483.50	55.58 PK	74.00	-18.42	1.21 V	201	23.12	32.46
2	2483.50	43.53 AV	54.00	-10.47	1.21 V	201	11.07	32.46
3	4924.00	50.56 PK	74.00	-23.44	1.16 V	140	11.64	38.92
3	4924.00	38.71 AV	54.00	-15.29	1.16 V	140	-0.21	38.92
4	7386.00	57.13 PK	74.00	-16.87	1.10 V	180	11.54	45.59
4	7386.00	44.92 AV	54.00	-9.08	1.10 V	180	-0.67	45.59

- REMARKS:**
1. Emission level (dBuV/m) = Raw Value (dBuV) + Correction Factor (dB/m).
 2. Correction Factor (dB/m) = Antenna Factor (dB/m) + Cable Factor (dB).
 3. The other emission levels were very low against the limit.
 4. Margin value = Emission level – Limit value.
 5. The limit value is defined as per 15.247.
 6. “ * “: Fundamental frequency.

DRAFT 802.11n (40MHz) OFDM MODULATION:

EUT TEST CONDITION		MEASUREMENT DETAIL	
CHANNEL	Channel 1	FREQUENCY RANGE	1 ~ 25GHz
MODULATION TYPE	BPSK	INPUT POWER (SYSTEM)	120Vac, 60 Hz
TRANSFER RATE	15.0Mbps	DETECTOR FUNCTION	Peak(PK) Average (AV)
ENVIRONMENTAL CONDITIONS	22deg. C, 64% RH, 991hPa	TESTED BY	Brad Wu

ANTENNA POLARITY & TEST DISTANCE: HORIZONTAL AT 3 M								
NO.	FREQ. (MHz)	EMISSION LEVEL (dBuV/m)	LIMIT (dBuV/m)	MARGIN (dB)	ANTENNA HEIGHT (m)	TABLE ANGLE (Degree)	RAW VALUE (dBuV)	CORRECTION FACTOR (dB/m)
1	2390.00	70.36 PK	74.00	-3.64	1.35 H	272	38.25	32.11
1	2390.00	52.50 AV	54.00	-1.50	1.35 H	272	20.39	32.11
2	*2422.00	109.76 PK			1.35 H	272	77.53	32.23
2	*2422.00	96.15 AV			1.35 H	272	63.92	32.23
3	4844.00	48.26 PK	74.00	-25.74	1.22 H	152	9.56	38.70
3	4844.00	36.15 AV	54.00	-17.85	1.22 H	152	-2.55	38.70
4	7266.00	55.36 PK	74.00	-18.64	1.10 H	143	10.07	45.29
4	7266.00	42.68 AV	54.00	-11.32	1.10 H	143	-2.61	45.29

ANTENNA POLARITY & TEST DISTANCE: VERTICAL AT 3 M								
NO.	FREQ. (MHz)	EMISSION LEVEL (dBuV/m)	LIMIT (dBuV/m)	MARGIN (dB)	ANTENNA HEIGHT (m)	TABLE ANGLE (Degree)	RAW VALUE (dBuV)	CORRECTION FACTOR (dB/m)
1	2390.00	61.94 PK	74.00	-12.06	1.58 V	203	29.83	32.11
1	2390.00	43.42 AV	54.00	-10.58	1.58 V	203	11.31	32.11
2	*2422.00	101.34 PK			1.58 V	203	69.11	32.23
2	*2422.00	88.07 AV			1.58 V	203	55.84	32.23
3	4844.00	50.19 PK	74.00	-23.81	1.36 V	195	11.49	38.70
3	4844.00	38.33 AV	54.00	-15.67	1.36 V	195	-0.37	38.70
4	7266.00	56.98 PK	74.00	-17.02	1.10 V	68	11.69	45.29
4	7266.00	44.67 AV	54.00	-9.33	1.10 V	68	-0.62	45.29

- REMARKS:**
1. Emission level (dBuV/m) = Raw Value (dBuV) + Correction Factor (dB/m).
 2. Correction Factor (dB/m) = Antenna Factor (dB/m) + Cable Factor (dB).
 3. The other emission levels were very low against the limit.
 4. Margin value = Emission level – Limit value.
 5. The limit value is defined as per 15.247.
 6. “ * “: Fundamental frequency.



EUT TEST CONDITION		MEASUREMENT DETAIL	
CHANNEL	Channel 4	FREQUENCY RANGE	1 ~ 25GHz
MODULATION TYPE	BPSK	INPUT POWER (SYSTEM)	120Vac, 60 Hz
TRANSFER RATE	15.0Mbps	DETECTOR FUNCTION	Peak(PK) Average (AV)
ENVIRONMENTAL CONDITIONS	22deg. C, 64% RH, 991hPa	TESTED BY	Brad Wu

ANTENNA POLARITY & TEST DISTANCE: HORIZONTAL AT 3 M								
NO.	FREQ. (MHz)	EMISSION LEVEL (dBuV/m)	LIMIT (dBuV/m)	MARGIN (dB)	ANTENNA HEIGHT (m)	TABLE ANGLE (Degree)	RAW VALUE (dBuV)	CORRECTION FACTOR (dB/m)
1	2390.00	68.49 PK	74.00	-5.51	1.38 H	276	36.38	32.11
1	2390.00	52.39 AV	54.00	-1.61	1.38 H	276	20.28	32.11
2	*2437.00	111.81 PK			1.38 H	276	79.52	32.29
2	*2437.00	99.38 AV			1.38 H	276	67.09	32.29
3	2483.50	64.76 PK	74.00	-9.24	1.38 H	276	32.30	32.46
3	2483.50	49.71 AV	54.00	-4.29	1.38 H	276	17.25	32.46
4	4874.00	48.78 PK	74.00	-25.22	1.10 H	153	9.99	38.79
4	4874.00	36.67 AV	54.00	-17.33	1.10 H	153	-2.12	38.79
5	7311.00	55.89 PK	74.00	-18.11	1.20 H	130	10.48	45.41
5	7311.00	43.17 AV	54.00	-10.83	1.20 H	130	-2.24	45.41

ANTENNA POLARITY & TEST DISTANCE: VERTICAL AT 3 M								
NO.	FREQ. (MHz)	EMISSION LEVEL (dBuV/m)	LIMIT (dBuV/m)	MARGIN (dB)	ANTENNA HEIGHT (m)	TABLE ANGLE (Degree)	RAW VALUE (dBuV)	CORRECTION FACTOR (dB/m)
1	2390.00	59.02 PK	74.00	-14.98	1.62 V	199	26.91	32.11
1	2390.00	42.35 AV	54.00	-11.65	1.62 V	199	10.24	32.11
2	*2437.00	102.34 PK			1.62 V	199	70.05	32.29
2	*2437.00	89.34 AV			1.62 V	199	57.05	32.29
3	2483.50	55.29 PK	74.00	-18.71	1.62 V	199	22.83	32.46
3	2483.50	39.67 AV	54.00	-14.33	1.62 V	199	7.21	32.46
4	4874.00	51.23 PK	74.00	-22.77	1.15 V	162	12.44	38.79
4	4874.00	39.41 AV	54.00	-14.59	1.15 V	162	0.62	38.79
5	7311.00	57.96 PK	74.00	-16.04	1.08 V	165	12.55	45.41
5	7311.00	45.63 AV	54.00	-8.37	1.08 V	165	0.22	45.41

- REMARKS:**
1. Emission level (dBuV/m) = Raw Value (dBuV) + Correction Factor (dB/m).
 2. Correction Factor (dB/m) = Antenna Factor (dB/m) + Cable Factor (dB).
 3. The other emission levels were very low against the limit.
 4. Margin value = Emission level – Limit value.
 5. The limit value is defined as per 15.247.
 6. “ * “: Fundamental frequency.



EUT TEST CONDITION		MEASUREMENT DETAIL	
CHANNEL	Channel 7	FREQUENCY RANGE	1 ~ 25GHz
MODULATION TYPE	BPSK	INPUT POWER (SYSTEM)	120Vac, 60 Hz
TRANSFER RATE	15.0Mbps	DETECTOR FUNCTION	Peak(PK) Average (AV)
ENVIRONMENTAL CONDITIONS	22deg. C, 64% RH, 991hPa	TESTED BY	Brad Wu

ANTENNA POLARITY & TEST DISTANCE: HORIZONTAL AT 3 M								
NO.	FREQ. (MHz)	EMISSION LEVEL (dBuV/m)	LIMIT (dBuV/m)	MARGIN (dB)	ANTENNA HEIGHT (m)	TABLE ANGLE (Degree)	RAW VALUE (dBuV)	CORRECTION FACTOR (dB/m)
1	*2452.00	109.25 PK			1.36 H	273	76.91	32.34
1	*2452.00	96.04 AV			1.36 H	273	63.70	32.34
2	2483.50	71.28 PK	74.00	-2.72	1.36 H	273	38.82	32.46
2	2483.50	52.61 AV	54.00	-1.39	1.36 H	273	20.15	32.46
3	4904.00	48.13 PK	74.00	-25.87	1.20 H	149	9.26	38.87
3	4904.00	36.04 AV	54.00	-17.96	1.20 H	149	-2.83	38.87
4	7356.00	55.21 PK	74.00	-18.79	1.09 H	142	9.69	45.52
4	7356.00	42.53 AV	54.00	-11.47	1.09 H	142	-2.99	45.52

ANTENNA POLARITY & TEST DISTANCE: VERTICAL AT 3 M								
NO.	FREQ. (MHz)	EMISSION LEVEL (dBuV/m)	LIMIT (dBuV/m)	MARGIN (dB)	ANTENNA HEIGHT (m)	TABLE ANGLE (Degree)	RAW VALUE (dBuV)	CORRECTION FACTOR (dB/m)
1	*2452.00	101.02 PK			1.56 V	202	68.68	32.34
1	*2452.00	87.75 AV			1.56 V	202	55.41	32.34
2	2483.50	62.75 PK	74.00	-11.25	1.56 V	202	30.29	32.46
2	2483.50	43.54 AV	54.00	-10.46	1.56 V	202	11.08	32.46
3	4904.00	50.24 PK	74.00	-23.76	1.34 V	201	11.37	38.87
3	4904.00	38.42 AV	54.00	-15.58	1.34 V	201	-0.45	38.87
4	7356.00	56.86 PK	74.00	-17.14	1.08 V	75	11.34	45.52
4	7356.00	44.53 AV	54.00	-9.47	1.08 V	75	-0.99	45.52

- REMARKS:**
1. Emission level (dBuV/m) = Raw Value (dBuV) + Correction Factor (dB/m).
 2. Correction Factor (dB/m) = Antenna Factor (dB/m) + Cable Factor (dB).
 3. The other emission levels were very low against the limit.
 4. Margin value = Emission level – Limit value.
 5. The limit value is defined as per 15.247.
 6. “ * “: Fundamental frequency.



4.3 6dB BANDWIDTH MEASUREMENT

4.3.1 LIMITS OF 6dB BANDWIDTH MEASUREMENT

The minimum of 6dB Bandwidth Measurement is 0.5 MHz.

4.3.2 TEST INSTRUMENTS

DESCRIPTION & MANUFACTURER	MODEL NO.	SERIAL NO.	CALIBRATED UNTIL
SPECTRUM ANALYZER	FSEK 30	100049	Aug. 14, 2006

NOTE: The calibration interval of the above test instruments is 12 months and the calibrations are traceable to NML/ROC and NIST/USA.

4.3.3 TEST PROCEDURE

The transmitter output was connected to the spectrum analyzer through an attenuator. The bandwidth of the fundamental frequency was measured by spectrum analyzer with 100kHz RBW and 100kHz VBW. The 6dB bandwidth is defined as the total spectrum the power of which is higher than peak power minus 6dB.

4.3.4 DEVIATION FROM TEST STANDARD

No deviation

4.3.5 TEST SETUP

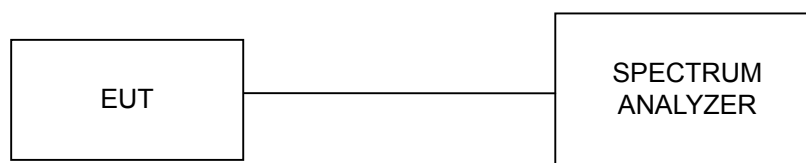

4.3.6 EUT OPERATING CONDITIONS

The software provided by client to enable the EUT under transmission condition continuously at lowest, middle and highest channel frequencies individually.

4.3.7 TEST RESULTS

802.11b DSSS MODULATION:

MODULATION TYPE	DBPSK	TRANSFER RATE	1.0Mbps
INPUT POWER (SYSTEM)	120Vac, 60 Hz	ENVIRONMENTAL CONDITIONS	25deg.C, 65% RH, 991hPa
TESTED BY	Brad Wu		

CHANNEL	CHANNEL FREQUENCY (MHz)	6dB BANDWIDTH (MHz)		MINIMUM LIMIT (MHz)	PASS / FAIL
		CHAIN 0	CHAIN 1		
1	2412	12.04	12.04	0.5	PASS
6	2437	12.60	12.12	0.5	PASS
11	2462	12.08	12.04	0.5	PASS

FOR CHAIN 0: CH 1

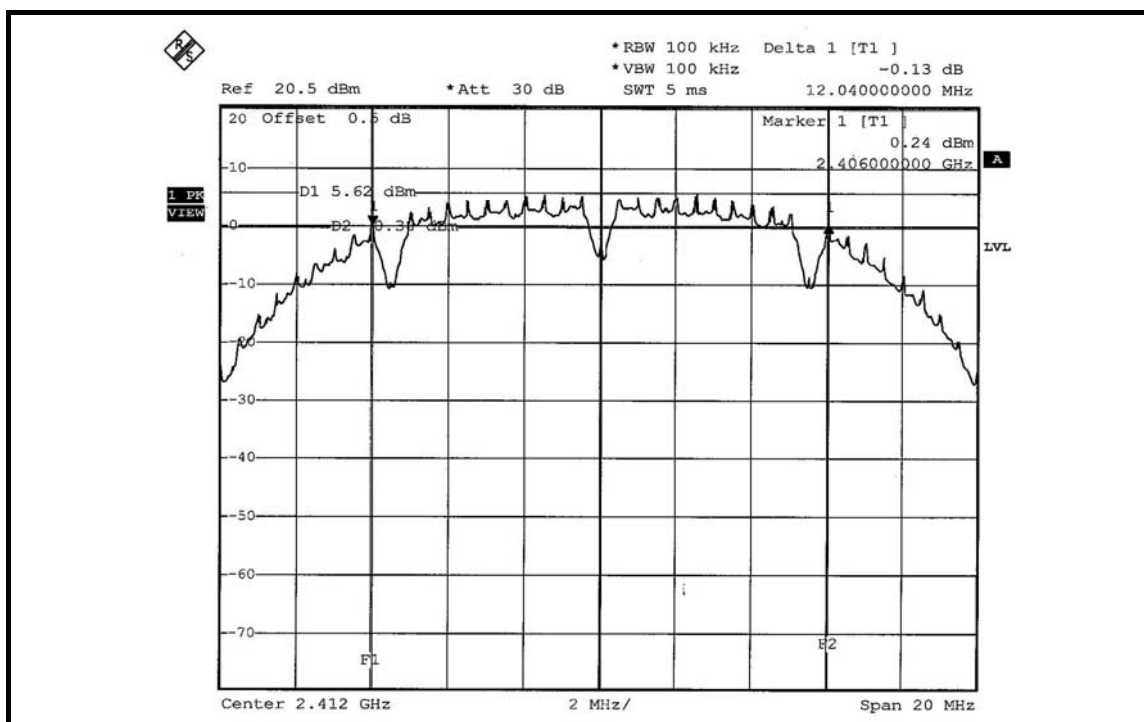

CH 6

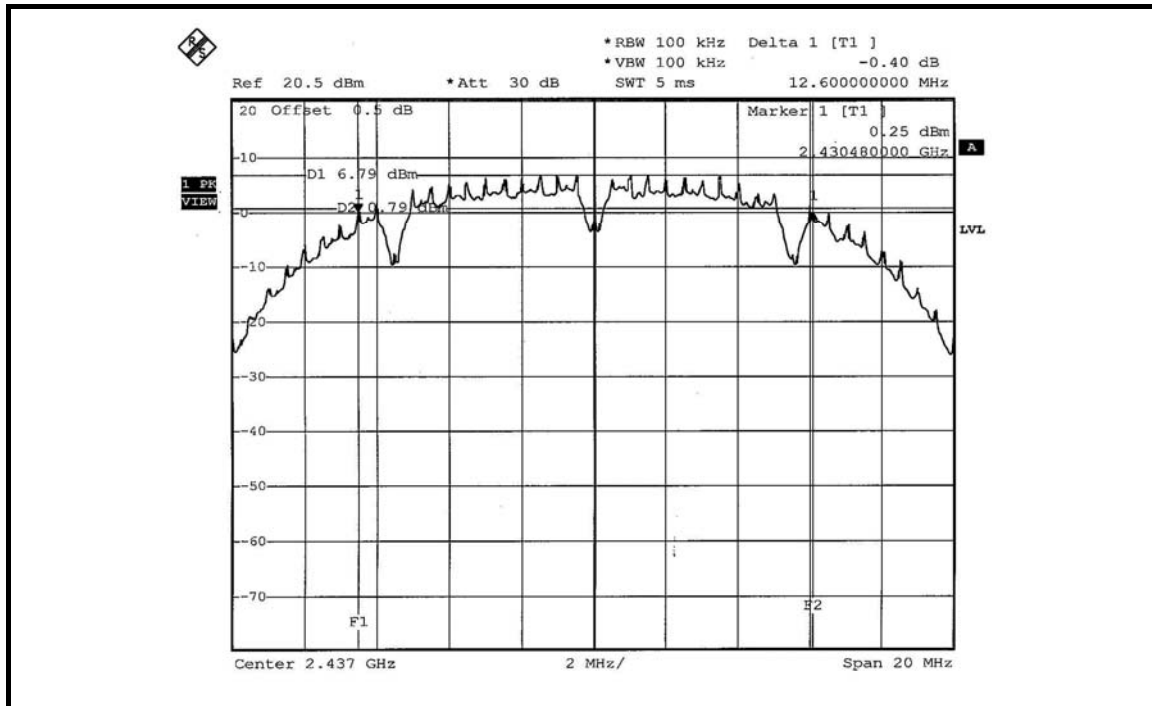

CH 11

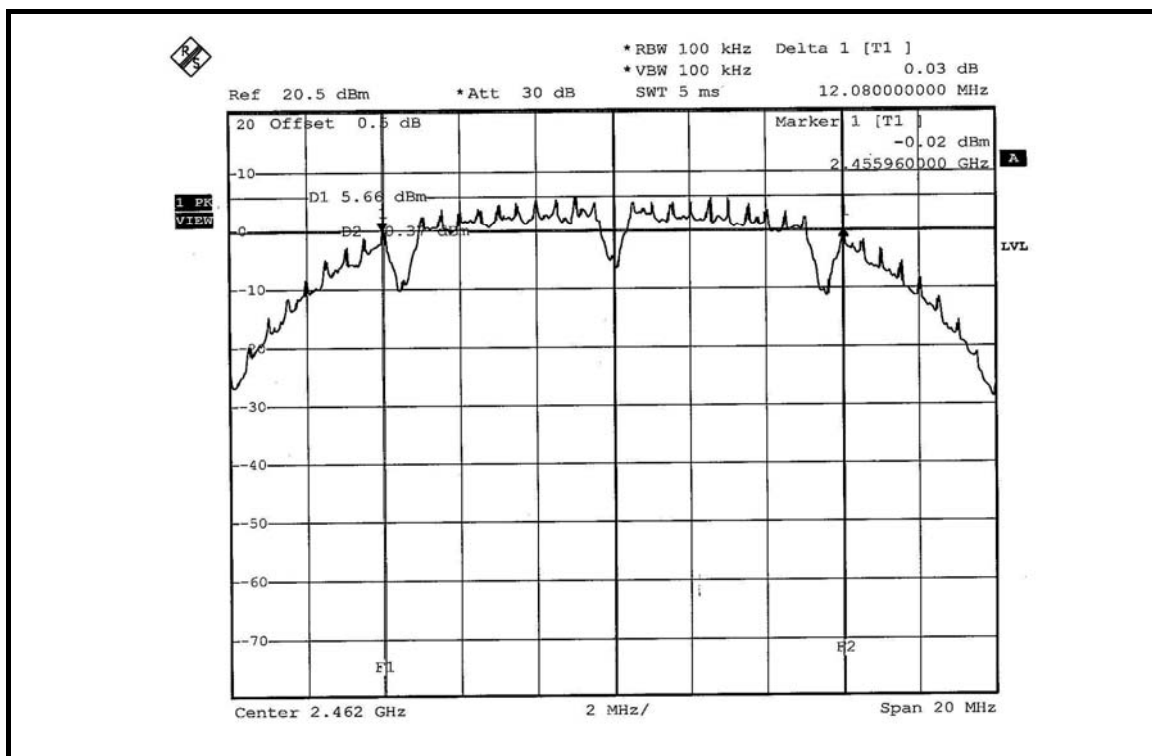

FOR CHAIN 1: CH 1

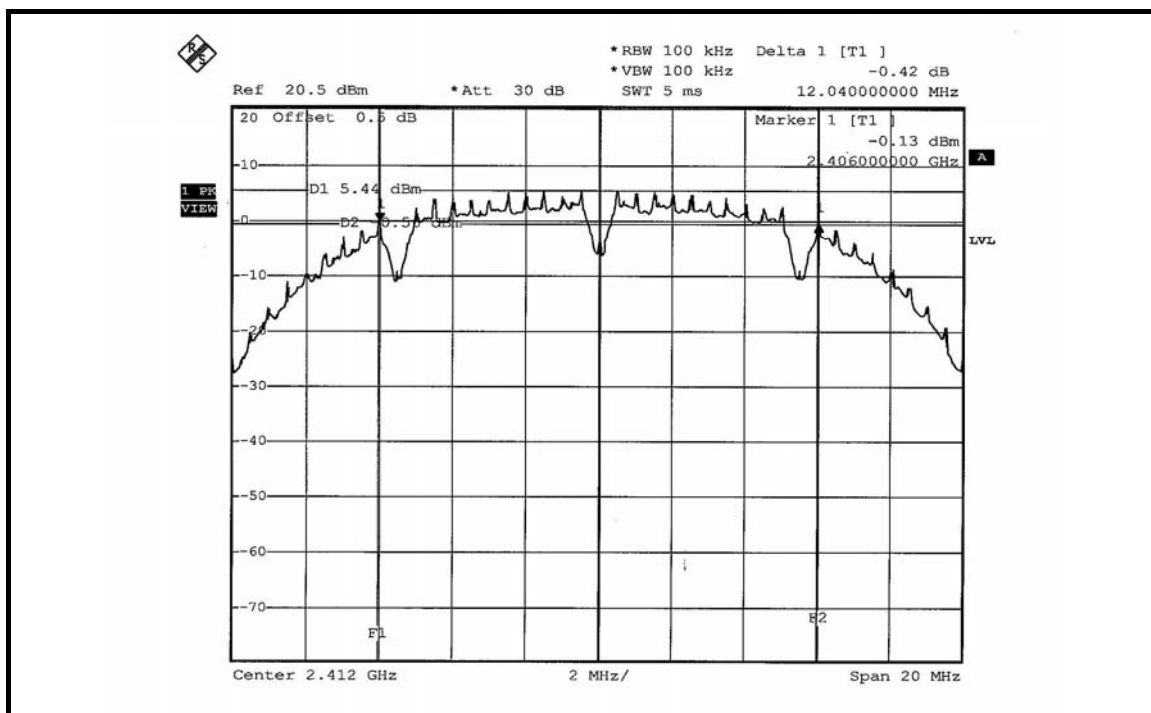

CH 6

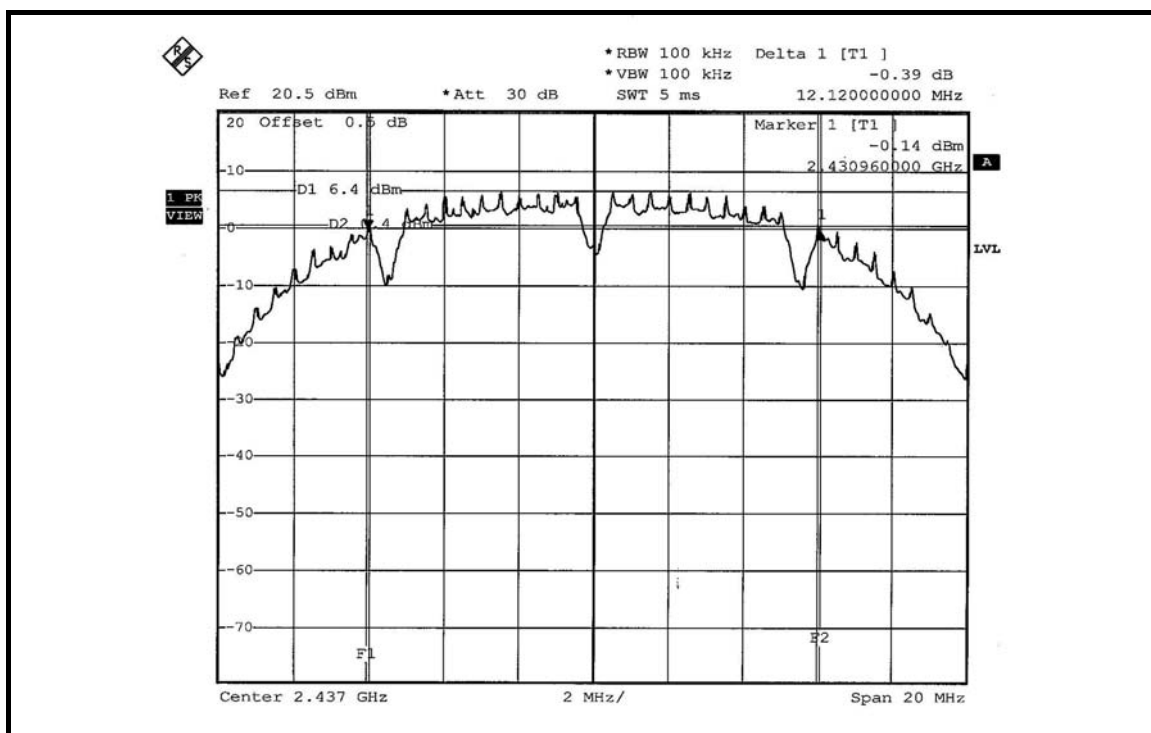

CH 11

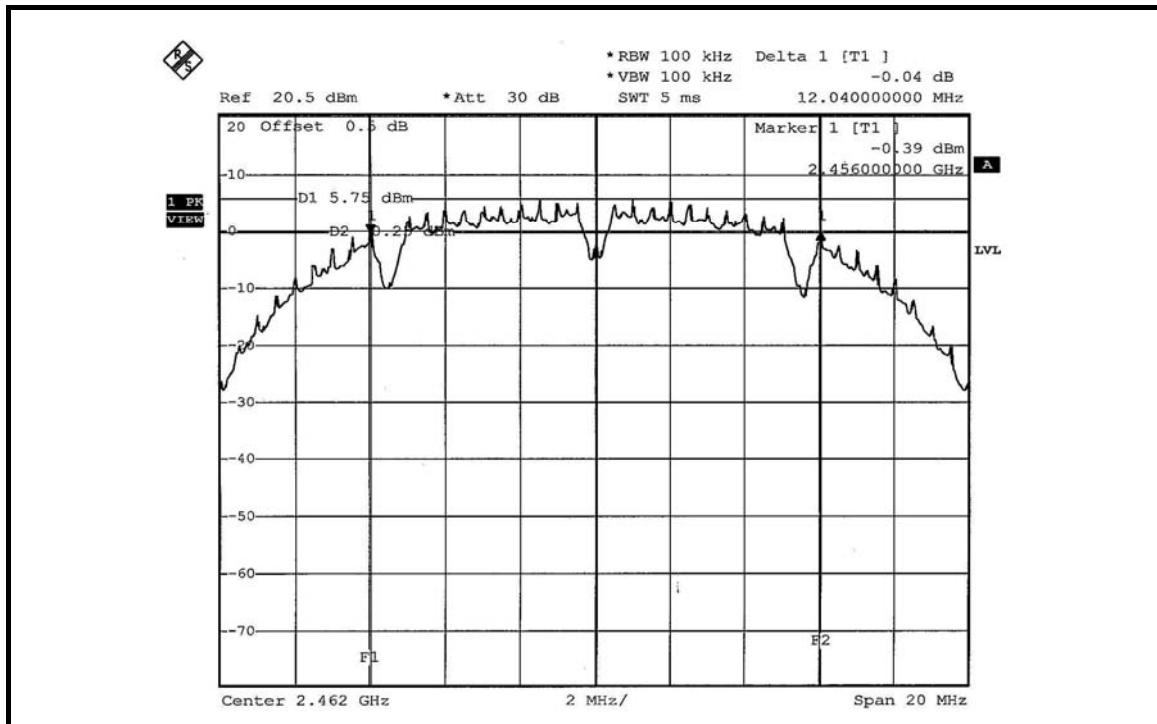



802.11g OFDM MODULATION:

MODULATION TYPE	BPSK	TRANSFER RATE	6.0Mbps
INPUT POWER (SYSTEM)	120Vac, 60 Hz	ENVIRONMENTAL CONDITIONS	25deg.C, 65% RH, 991hPa
TESTED BY	Brad Wu		

CHANNEL	CHANNEL FREQUENCY (MHz)	6dB BANDWIDTH (MHz)		MINIMUM LIMIT (MHz)	PASS / FAIL
		CHAIN 0	CHAIN 1		
1	2412	16.40	16.40	0.5	PASS
6	2437	16.44	16.44	0.5	PASS
11	2462	16.40	16.44	0.5	PASS

FOR CHAIN 0: CH 1

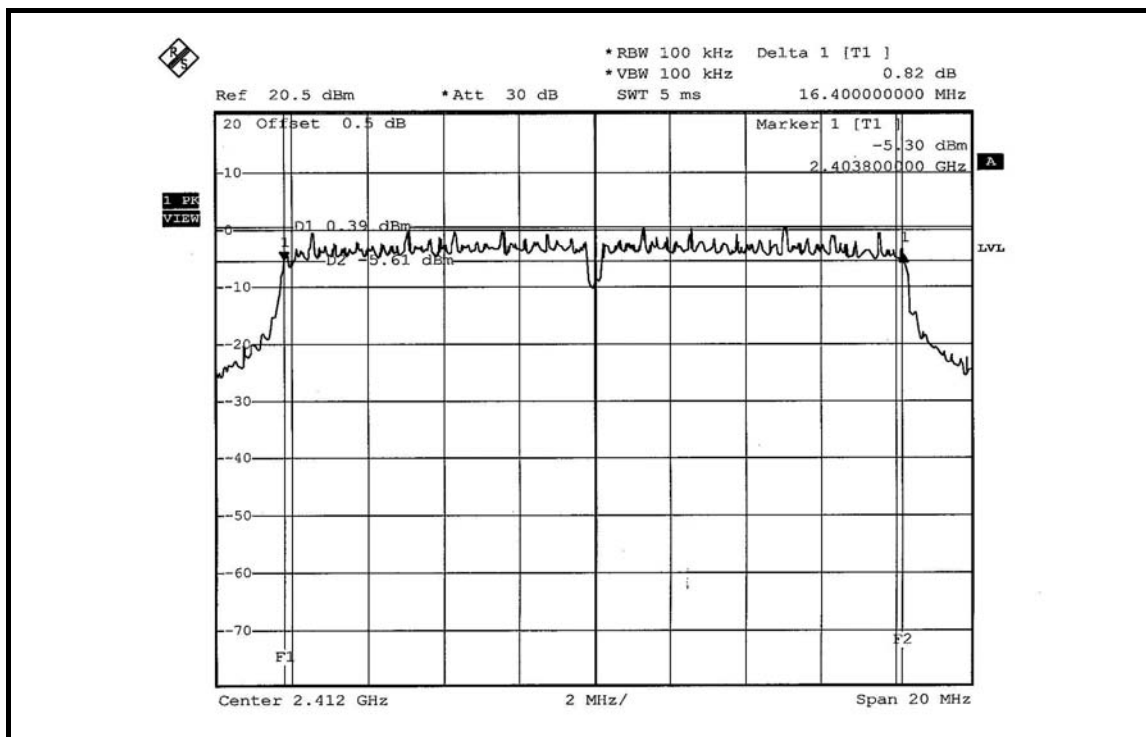

CH 6

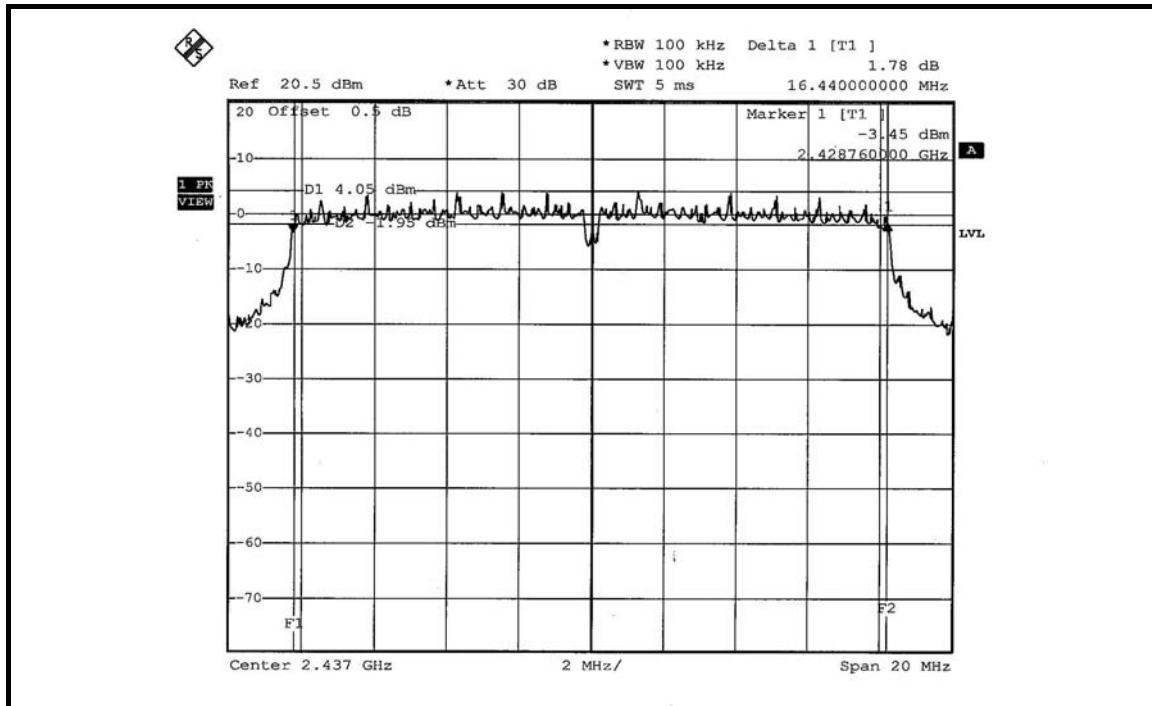

CH 11

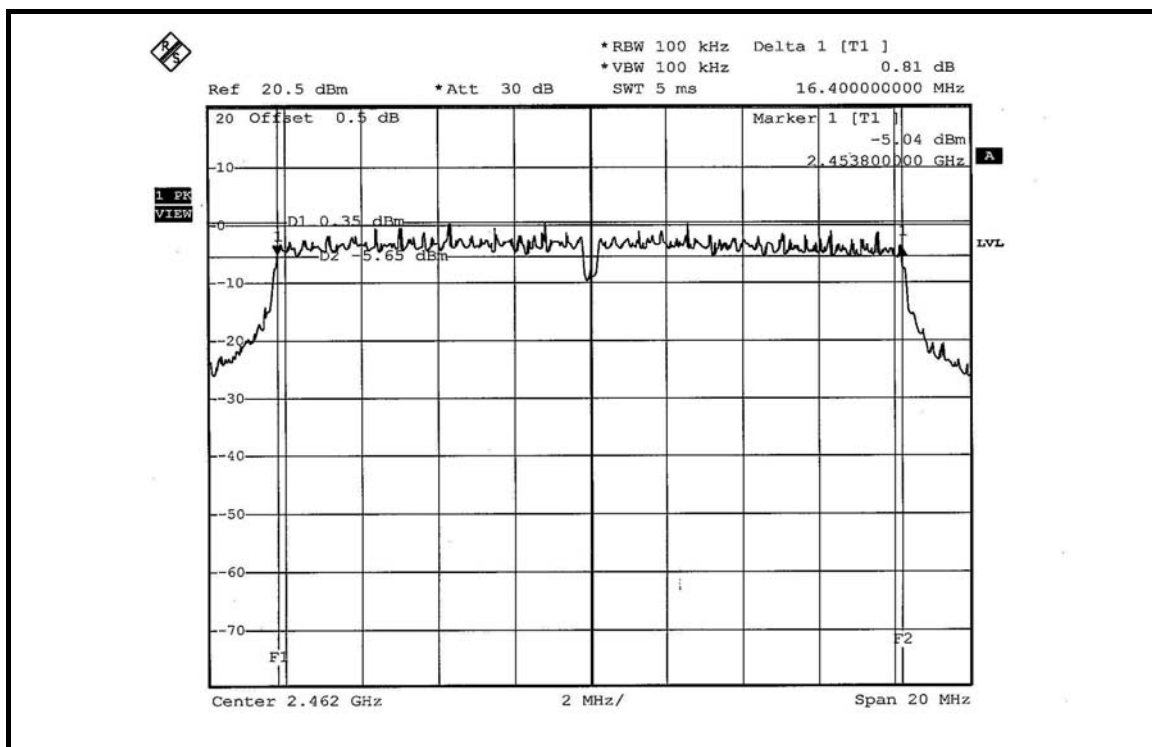

FOR CHAIN 1: CH 1

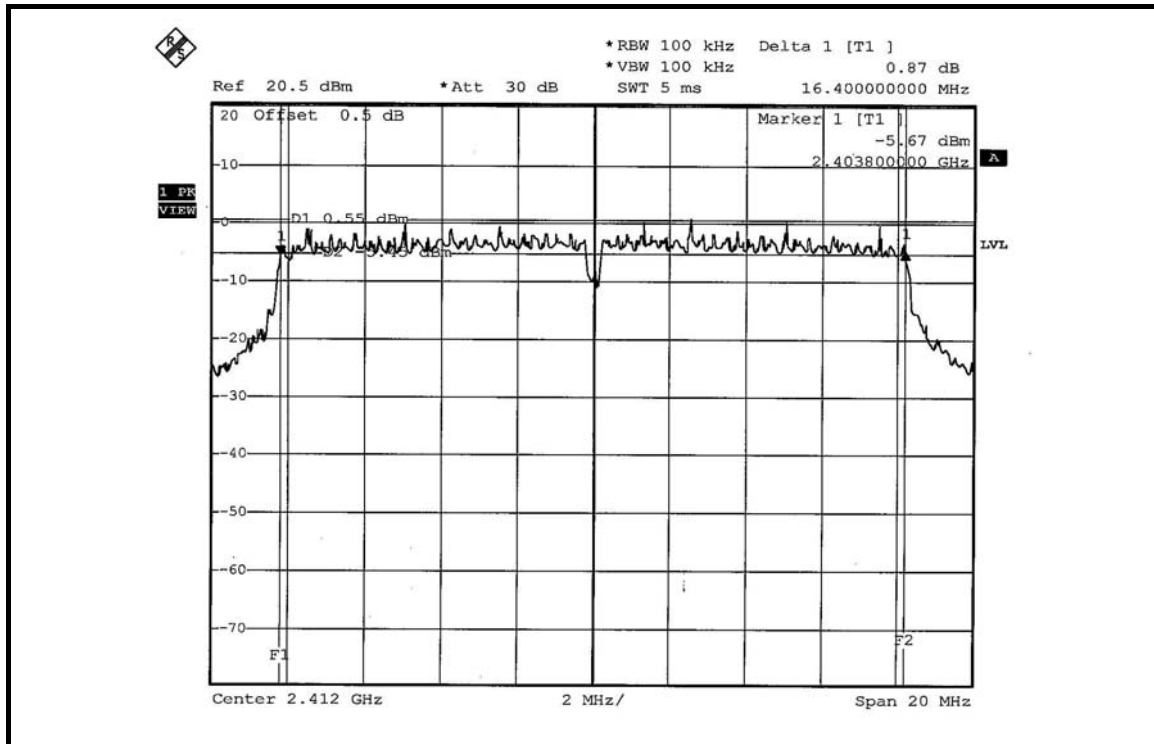

CH 6

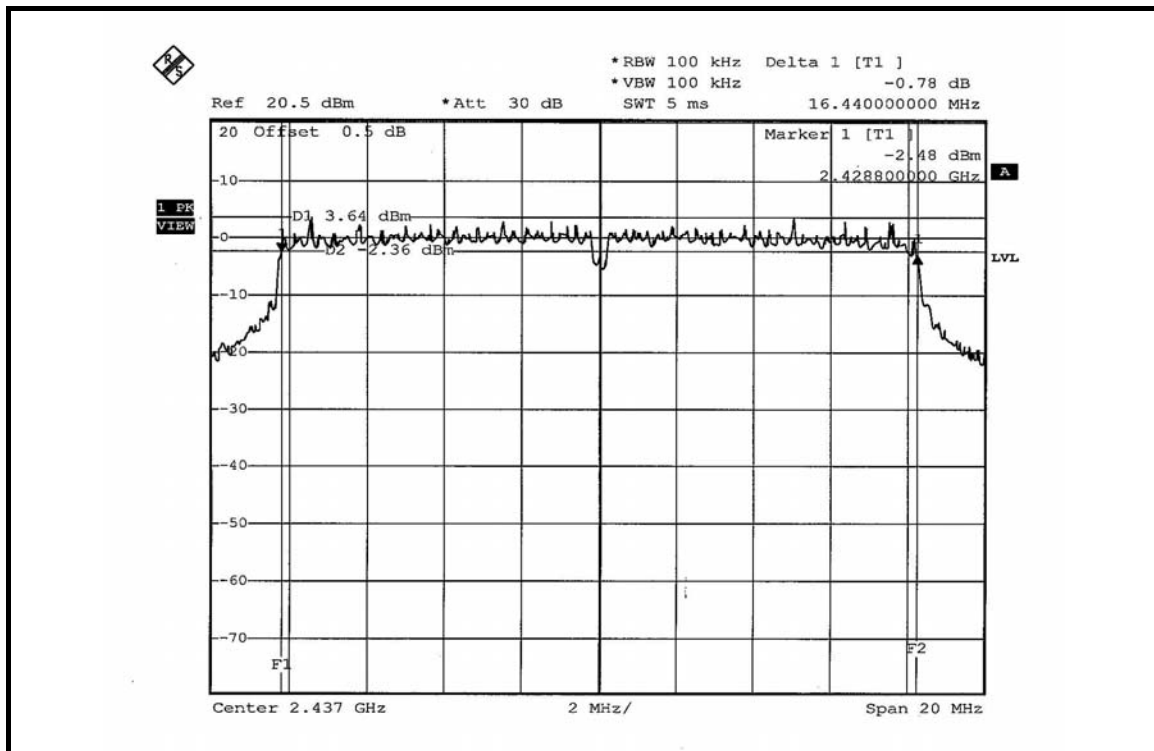

CH 11

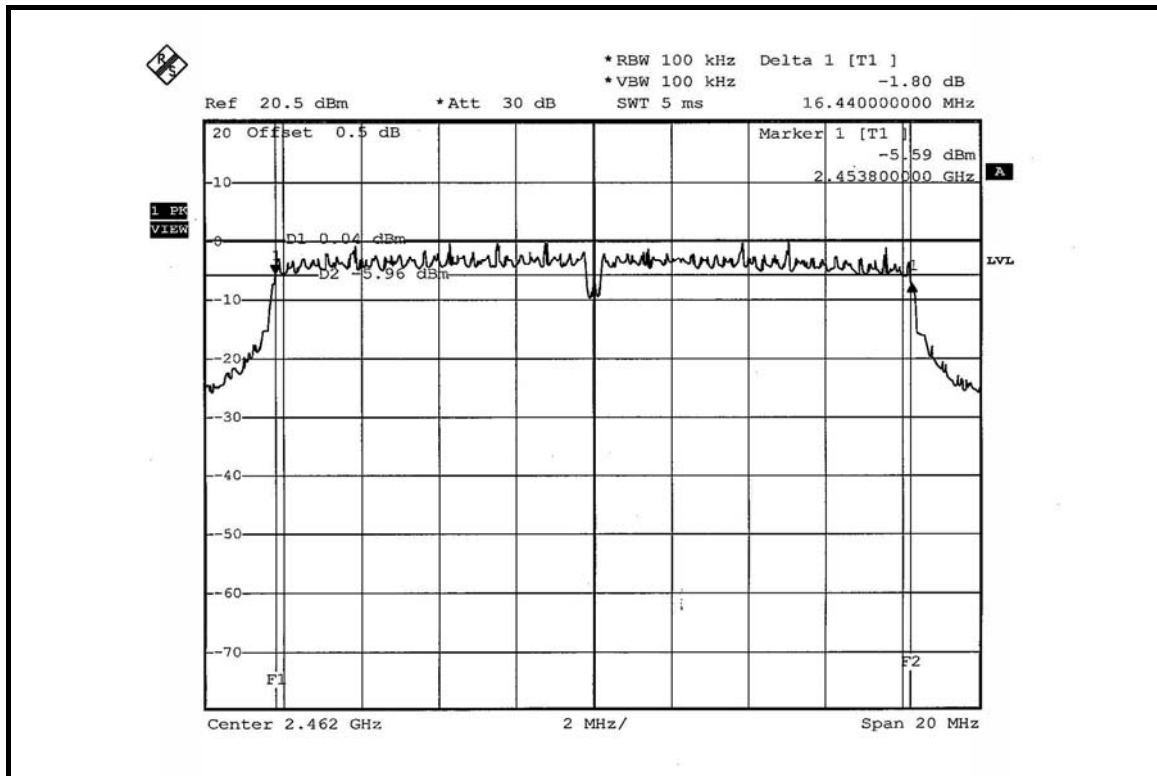



DRAFT 802.11n (20MHz) OFDM MODULATION:

MODULATION TYPE	BPSK	TRANSFER RATE	7.2Mbps
INPUT POWER (SYSTEM)	120Vac, 60 Hz	ENVIRONMENTAL CONDITIONS	25deg.C, 65% RH, 991hPa
TESTED BY	Brad Wu		

CHANNEL	CHANNEL FREQUENCY (MHz)	6dB BANDWIDTH (MHz)		MINIMUM LIMIT (MHz)	PASS / FAIL
		CHAIN 0	CHAIN 1		
1	2412	17.60	18.80	0.5	PASS
6	2437	17.64	19.24	0.5	PASS
11	2462	17.64	18.80	0.5	PASS

FOR CHAIN 0: CH 1

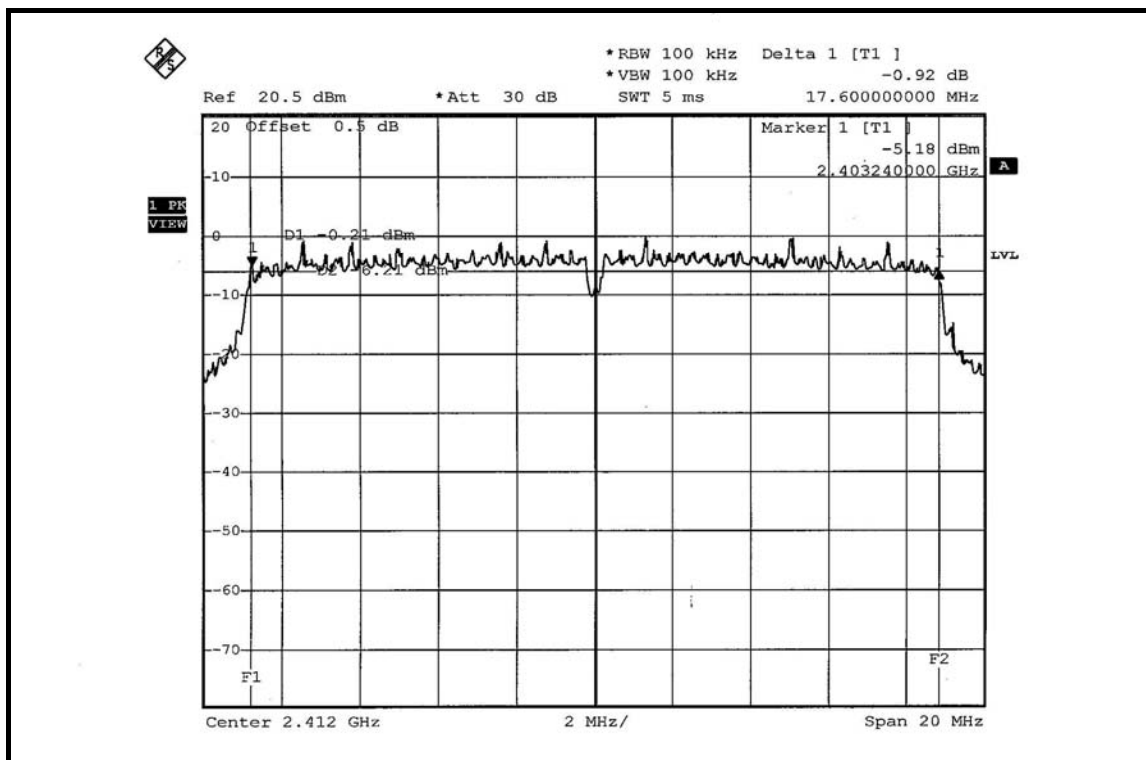

CH 6

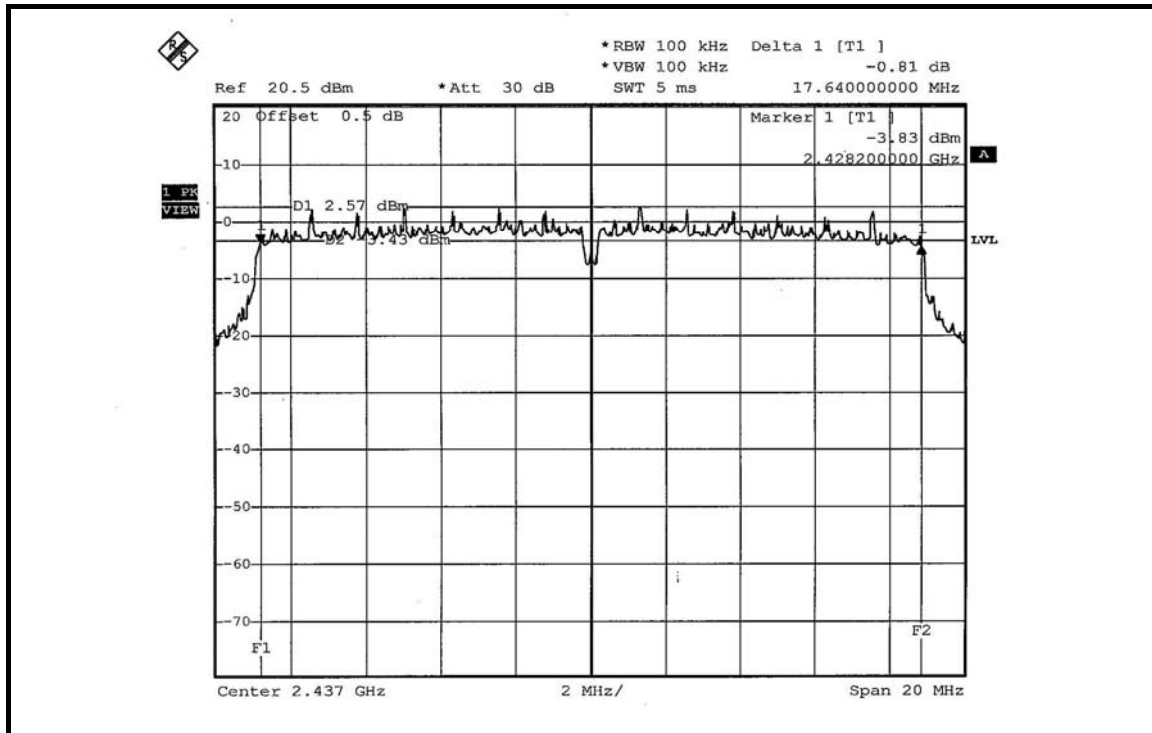

CH 11

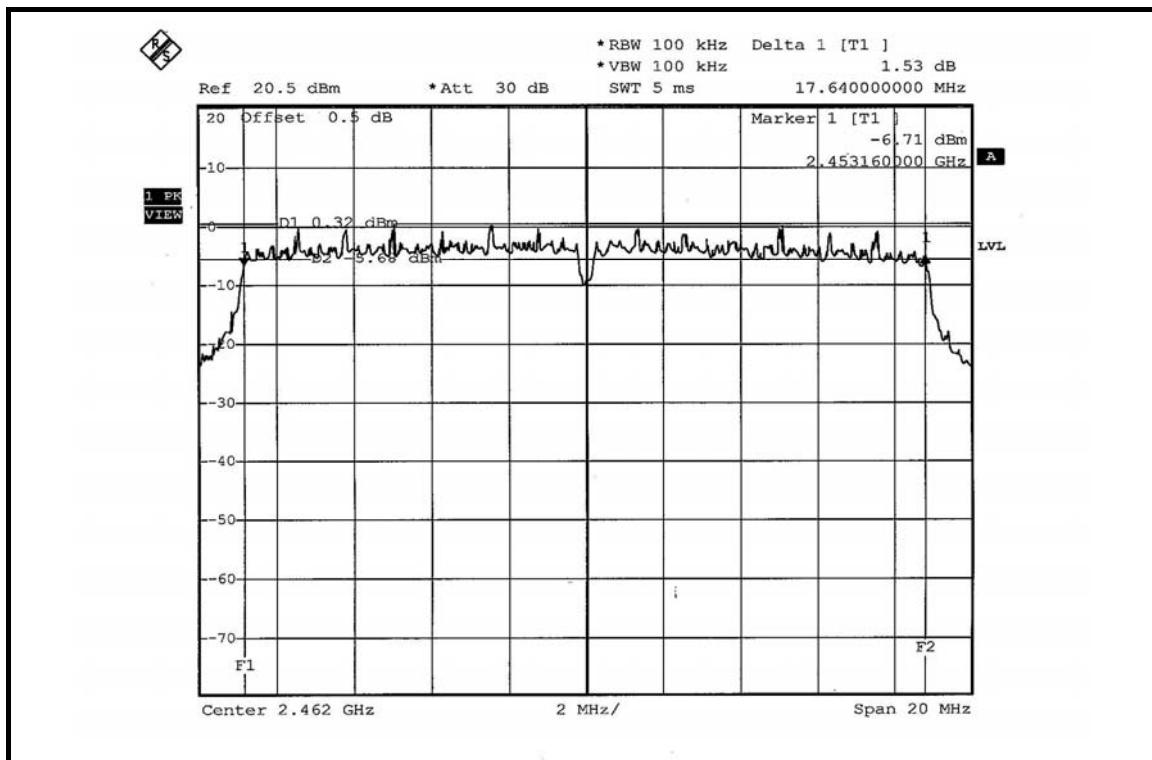

FOR CHAIN 1: CH 1

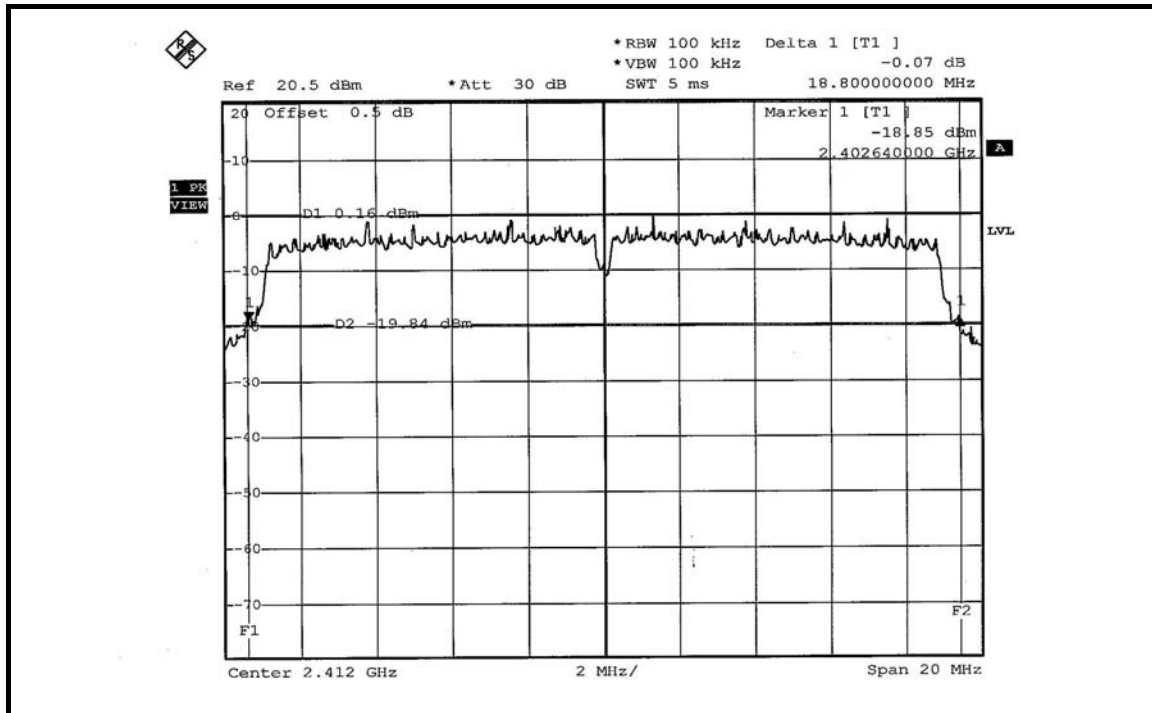

CH 6

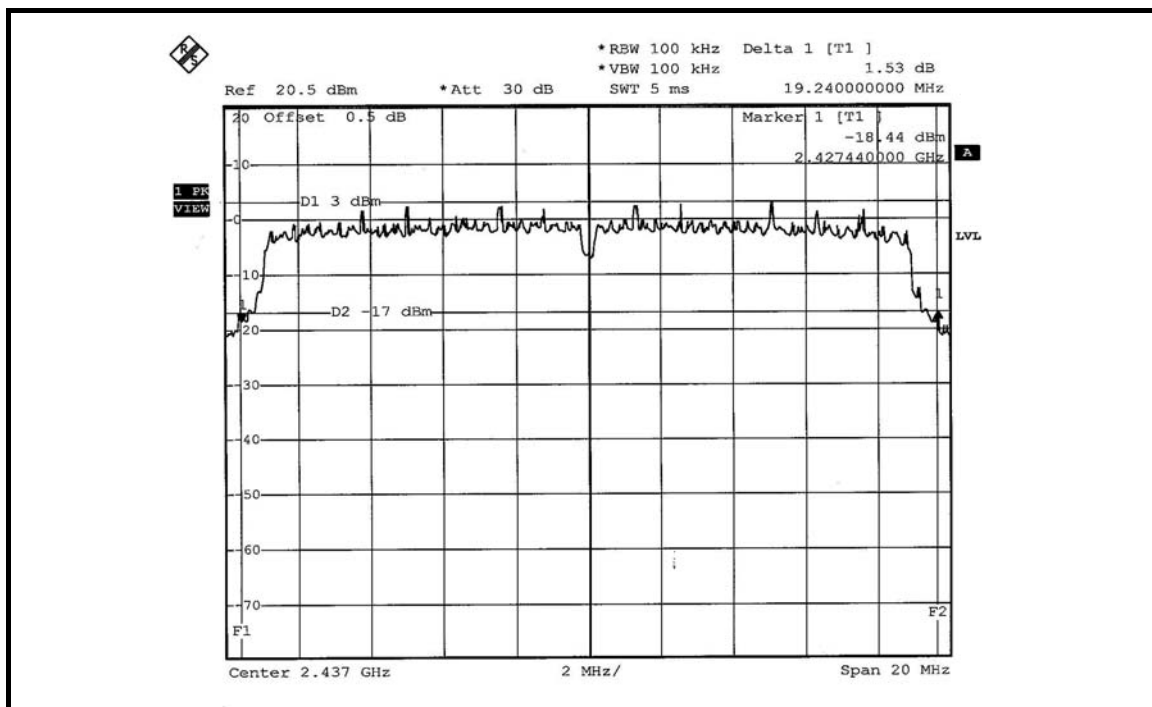

CH 11

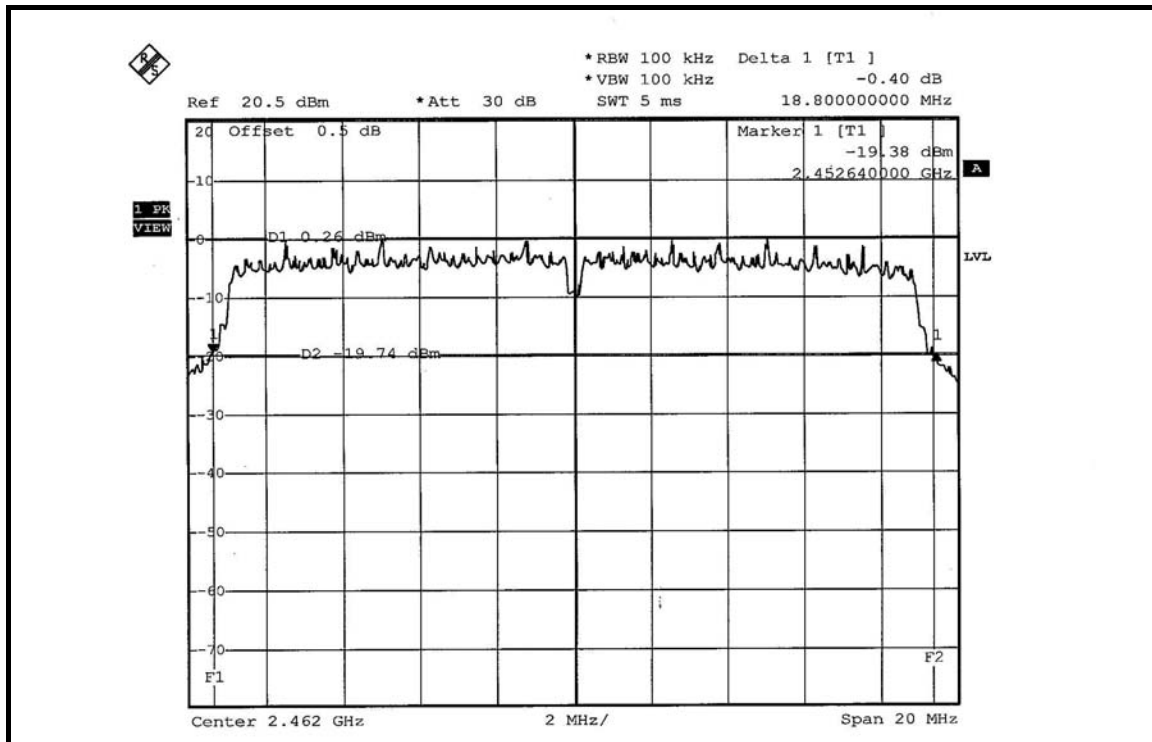



DRAFT 802.11n (40MHz) OFDM MODULATION:

MODULATION TYPE	BPSK	TRANSFER RATE	15.0Mbps
INPUT POWER (SYSTEM)	120Vac, 60 Hz	ENVIRONMENTAL CONDITIONS	25deg.C, 65% RH, 991hPa
TESTED BY	Brad Wu		

CHANNEL	CHANNEL FREQUENCY (MHz)	6dB BANDWIDTH (MHz)		MINIMUM LIMIT (MHz)	PASS / FAIL
		CHAIN 0	CHAIN 1		
1	2422	35.28	35.36	0.5	PASS
4	2437	35.28	35.12	0.5	PASS
7	2452	35.52	35.36	0.5	PASS

FOR CHAIN 0: CH 1

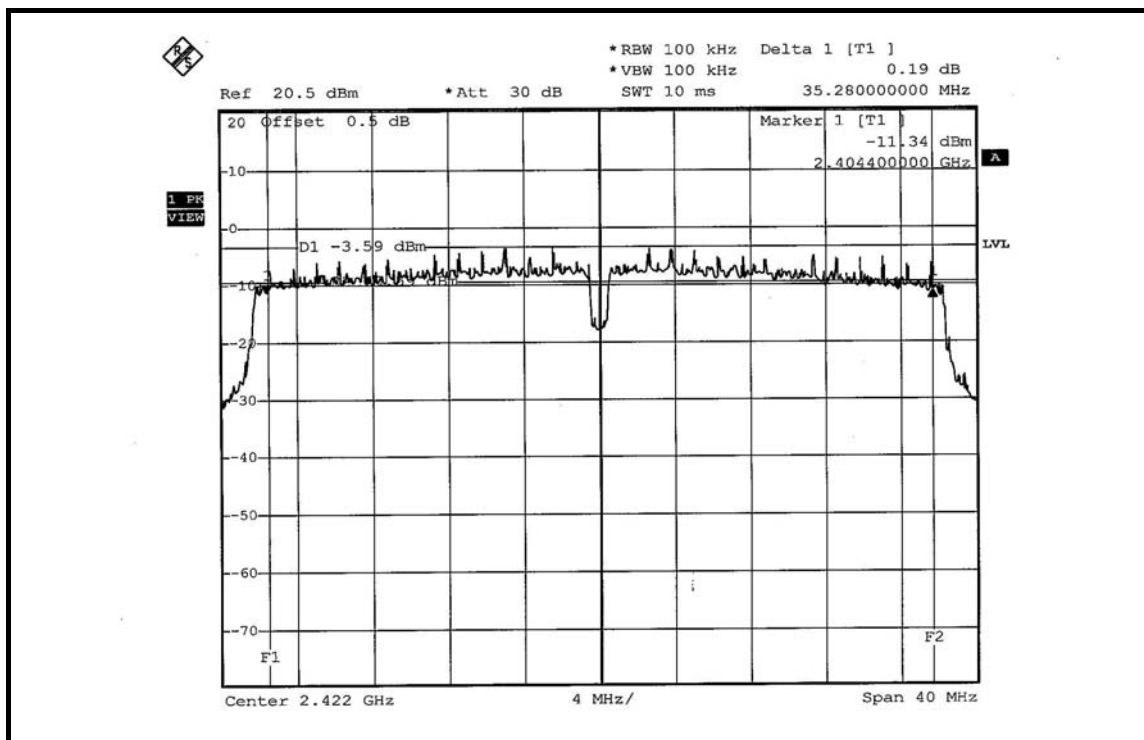

CH 4

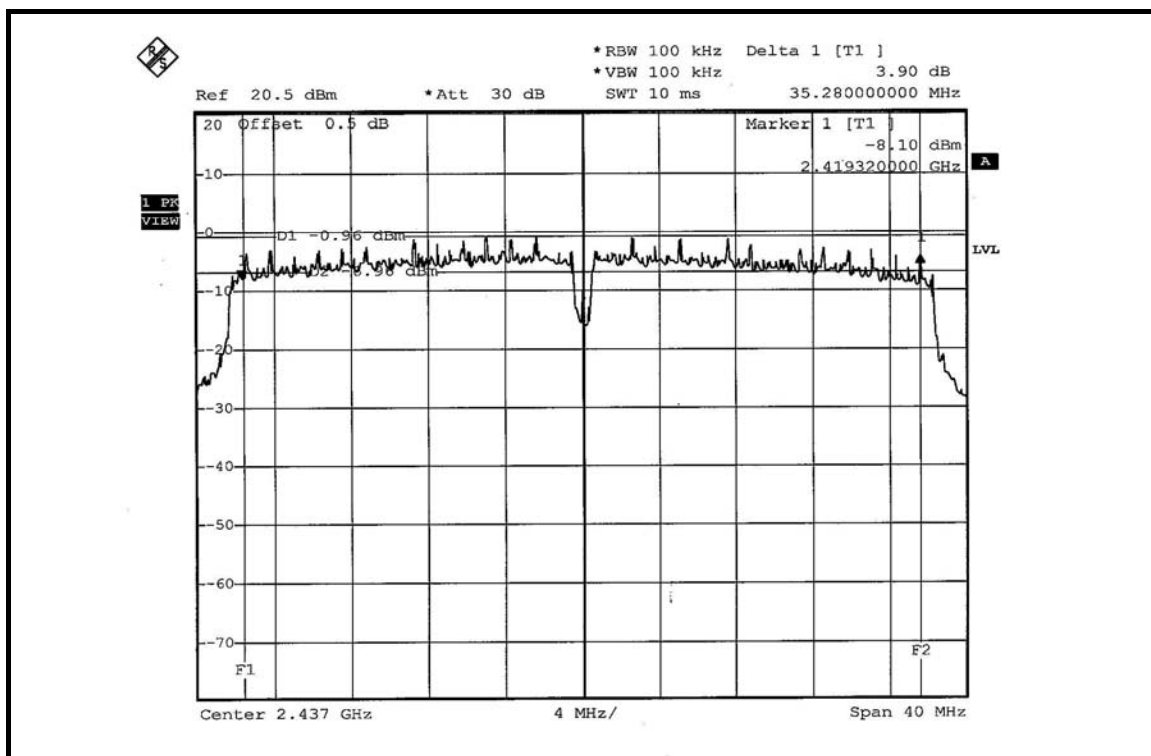

CH 7

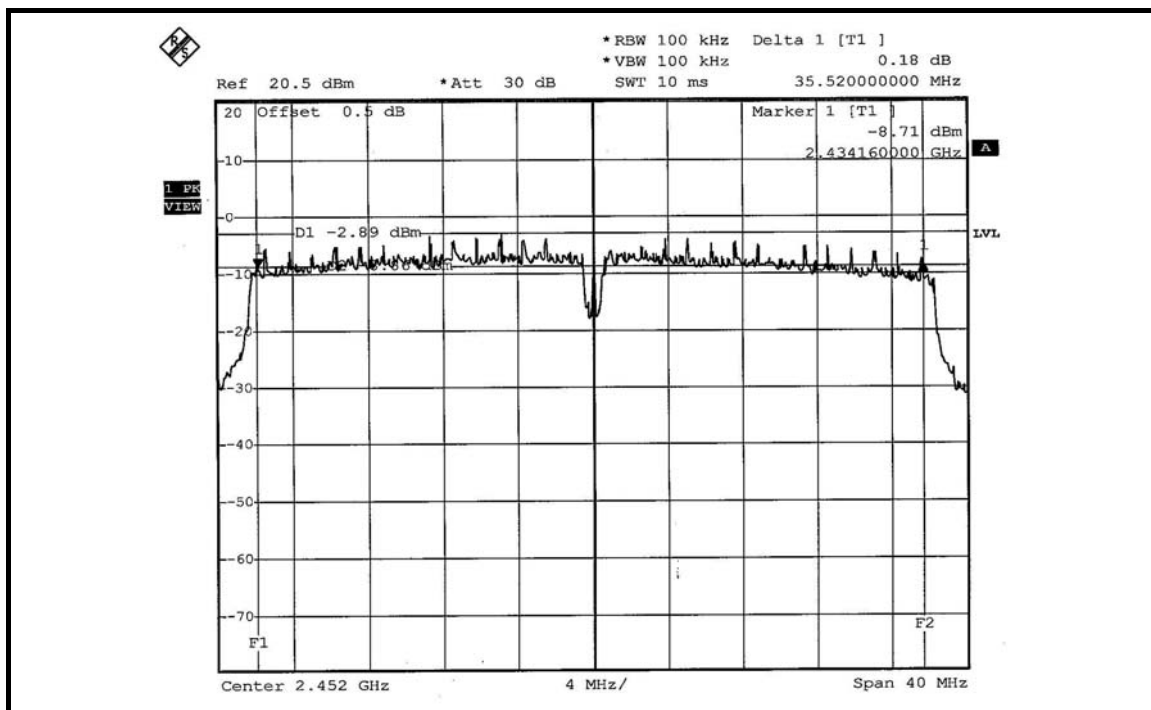

FOR CHAIN 1: CH 1

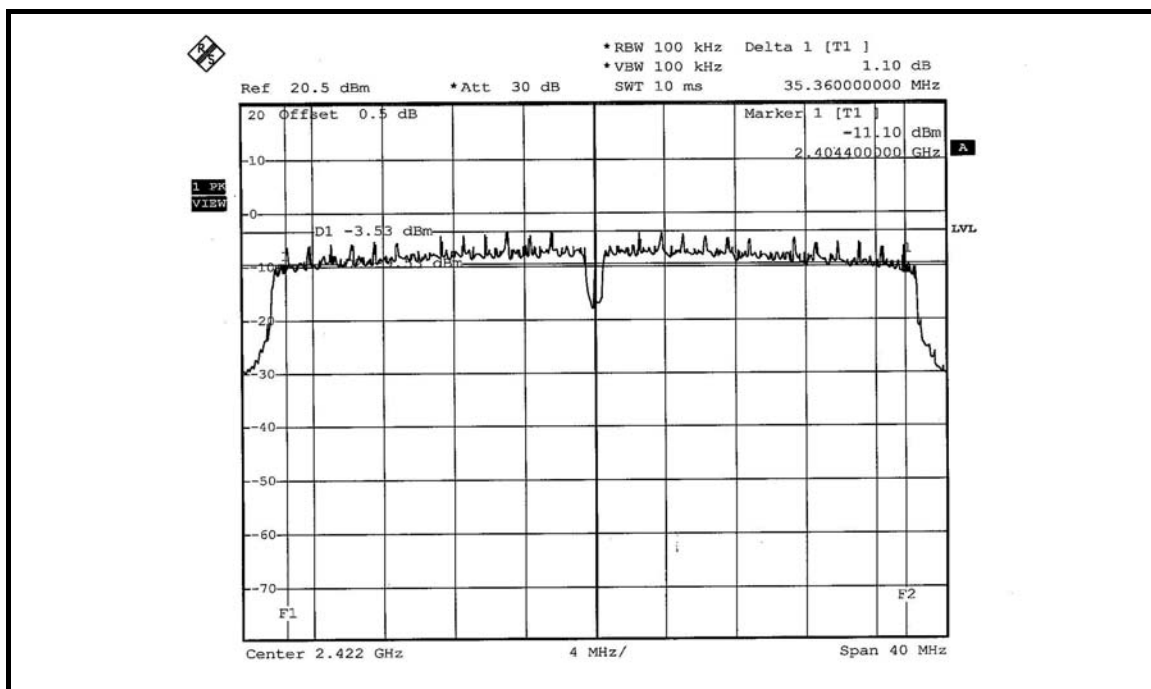

CH 4

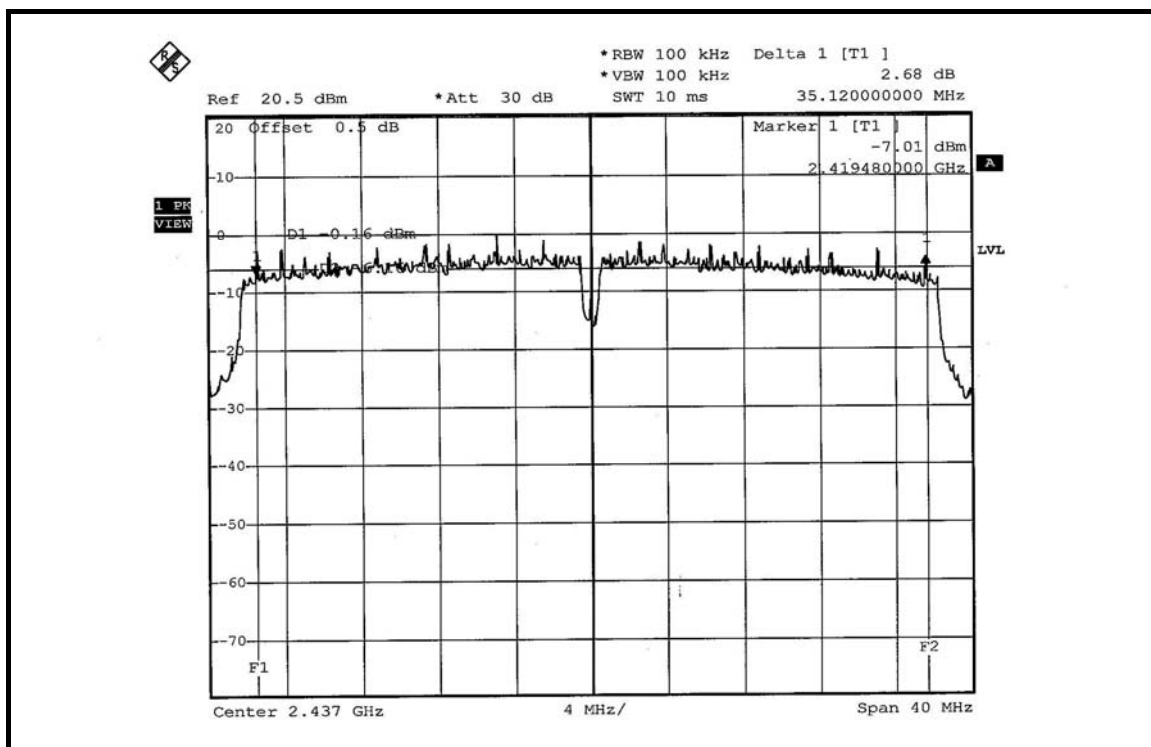

CH 7

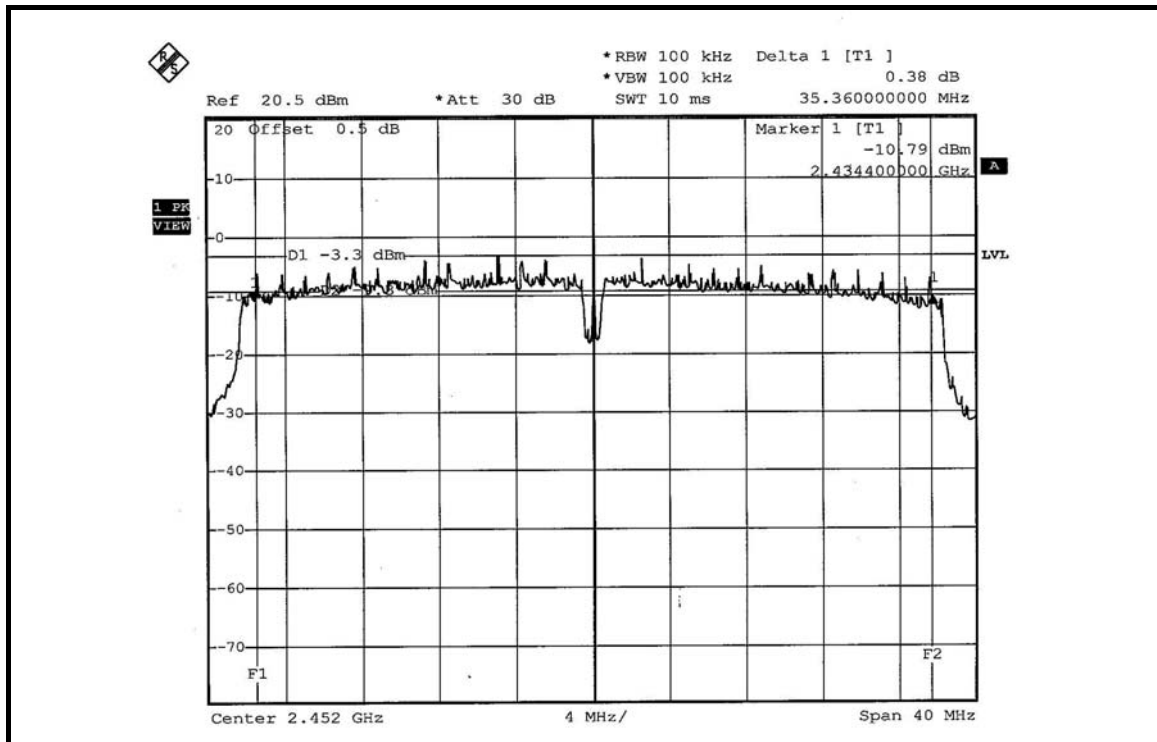



4.4 MAXIMUM PEAK OUTPUT POWER

4.4.1 LIMITS OF MAXIMUM PEAK OUTPUT POWER MEASUREMENT

The Maximum Peak Output Power Measurement is 30dBm.

4.4.2 INSTRUMENTS

DESCRIPTION & MANUFACTURER	MODEL NO.	SERIAL NO.	CALIBRATED UNTIL
R&S SPECTRUM ANALYZER	FSEK30	100049	Aug. 14, 2006
AGILENT SIGNAL GENERATOR	E8257C	MY43320668	Dec. 07, 2006
DIGITAL RT OSCILLOSCOPE	TDS1012	C037299	Nov. 28, 2006
NARDA DETECTOR	4503A	FSCM99899	NA

NOTE: The calibration interval of the above test instruments is 12 months and the calibrations are traceable to NML/ROC and NIST/USA.

4.4.3 TEST PROCEDURES

1. A detector was used on the output port of the EUT. An oscilloscope was used to read the response of the detector.
2. Replaced the EUT by the signal generator. The center frequency of the S.G was adjusted to the center frequency of the measured channel.
3. Adjusted the power to have the same reading on oscilloscope. Record the power level.

4.4.4 DEVIATION FROM TEST STANDARD

No deviation

4.4.5 TEST SETUP

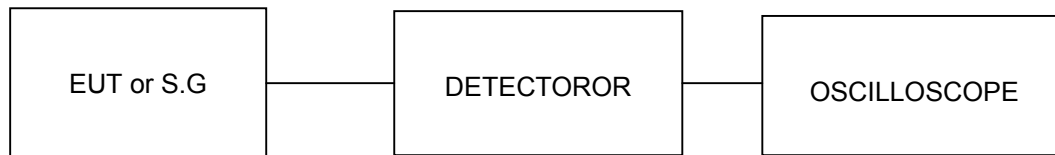

4.4.6 EUT OPERATING CONDITIONS

Same as Item 4.3.6



4.4.7 TEST RESULTS

802.11b DSSS MODULATION:

MODULATION TYPE	DBPSK	TRANSFER RATE	1.0Mbps
INPUT POWER (SYSTEM)	120Vac, 60 Hz	ENVIRONMENTAL CONDITIONS	25deg.C, 65% RH, 991hPa
TESTED BY	Brad Wu		

CHAN.	CHANNEL FREQUENCY (MHz)	PEAK POWER OUTPUT (mW)		PEAK POWER OUTPUT (dBm)		TOTAL PEAK POWER (mW)	TOTAL PEAK POWER (dBm)	PEAK POWER LIMIT (dBm)	PASS / FAIL
		CHAIN 0	CHAIN 1	CHAIN 0	CHAIN 1				
1	2412	64.121	63.533	18.07	18.03	127.654	21.06	30	PASS
6	2437	80.724	79.983	19.07	19.03	160.707	22.06	30	PASS
11	2462	64.121	63.241	18.07	18.01	127.362	21.05	30	PASS

802.11g OFDM MODULATION:

MODULATION TYPE	BPSK	TRANSFER RATE	6.0Mbps
INPUT POWER (SYSTEM)	120Vac, 60 Hz	ENVIRONMENTAL CONDITIONS	25deg.C, 65% RH, 991hPa
TESTED BY	Brad Wu		

CHAN.	CHANNEL FREQUENCY (MHz)	PEAK POWER OUTPUT (mW)		PEAK POWER OUTPUT (dBm)		TOTAL PEAK POWER (mW)	TOTAL PEAK POWER (dBm)	PEAK POWER LIMIT (dBm)	PASS / FAIL
		CHAIN 0	CHAIN 1	CHAIN 0	CHAIN 1				
1	2412	51.168	50.582	17.09	17.04	101.751	20.08	30	PASS
6	2437	101.625	101.158	20.07	20.05	202.783	23.07	30	PASS
11	2462	50.699	50.582	17.05	17.04	101.282	20.06	30	PASS



DRAFT 802.11n (20MHz) OFDM MODULATION:

MODULATION TYPE	BPSK	TRANSFER RATE	7.2Mbps
INPUT POWER (SYSTEM)	120Vac, 60 Hz	ENVIRONMENTAL CONDITIONS	25deg.C, 65% RH, 991hPa
TESTED BY	Brad Wu		

CHAN.	CHANNEL FREQUENCY (MHz)	PEAK POWER OUTPUT (mW)		PEAK POWER OUTPUT (dBm)		TOTAL PEAK POWER (mW)	TOTAL PEAK POWER (dBm)	PEAK POWER LIMIT (dBm)	PASS / FAIL
		CHAIN 0	CHAIN 1	CHAIN 0	CHAIN 1				
1	2412	40.272	40.087	16.05	16.03	80.358	19.05	30	PASS
6	2437	71.285	71.285	18.53	18.53	142.571	21.54	30	PASS
11	2462	44.978	44.875	16.53	16.52	89.853	19.54	30	PASS

DRAFT 802.11n (40MHz) OFDM MODULATION:

MODULATION TYPE	BPSK	TRANSFER RATE	15.0Mbps
INPUT POWER (SYSTEM)	120Vac, 60 Hz	ENVIRONMENTAL CONDITIONS	25deg.C, 65% RH, 991hPa
TESTED BY	Brad Wu		

CHAN.	CHANNEL FREQUENCY (MHz)	PEAK POWER OUTPUT (mW)		PEAK POWER OUTPUT (dBm)		TOTAL PEAK POWER (mW)	TOTAL PEAK POWER (dBm)	PEAK POWER LIMIT (dBm)	PASS / FAIL
		CHAIN 0	CHAIN 1	CHAIN 0	CHAIN 1				
1	2422	28.576	28.184	14.56	14.50	56.760	17.54	30	PASS
4	2437	52.000	51.523	17.16	17.12	103.522	20.15	30	PASS
7	2452	28.708	28.576	14.58	14.56	57.284	17.58	30	PASS



4.5 POWER SPECTRAL DENSITY MEASUREMENT

4.5.1 LIMITS OF POWER SPECTRAL DENSITY MEASUREMENT

The Maximum of Power Spectral Density Measurement is 8dBm.

4.5.2 TEST INSTRUMENTS

DESCRIPTION & MANUFACTURER	MODEL NO.	SERIAL NO.	CALIBRATED UNTIL
R&S SPECTRUM ANALYZER	FSEK30	100049	Aug. 14, 2006

NOTE: The calibration interval of the above test instruments is 12 months and the calibrations are traceable to NML/ROC and NIST/USA.

4.5.3 TEST PROCEDURE

The transmitter output was connected to the spectrum analyzer through an attenuator, the bandwidth of the fundamental frequency was measured with the spectrum analyzer using 3kHz RBW and 30kHz VBW, set sweep time = span/3kHz. The power spectral density was measured and recorded.

The sweep time is allowed to be longer than span/3kHz for a full response of the mixer in the spectrum analyzer.

4.5.4 DEVIATION FROM TEST STANDARD

No deviation

4.5.5 TEST SETUP

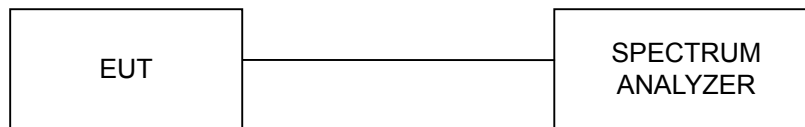

4.5.6 EUT OPERATING CONDITION

Same as Item 4.3.6

4.5.7 TEST RESULTS

802.11b DSSS MODULATION:

MODULATION TYPE	DBPSK	TRANSFER RATE	1.0Mbps
INPUT POWER (SYSTEM)	120Vac, 60 Hz	ENVIRONMENTAL CONDITIONS	25deg.C, 65% RH, 991hPa
TESTED BY	Brad Wu		

CHANNEL	CHANNEL FREQUENCY (MHz)	RF POWER LEVEL IN 3kHz BW (dBm)		MAXIMUM LIMIT (dBm)	PASS / FAIL
		CHAIN 0	CHAIN 1		
1	2412	-8.50	-8.89	8	PASS
6	2437	-7.21	-7.77	8	PASS
11	2462	-8.27	-8.48	8	PASS

FOR CHAIN 0: CH 1

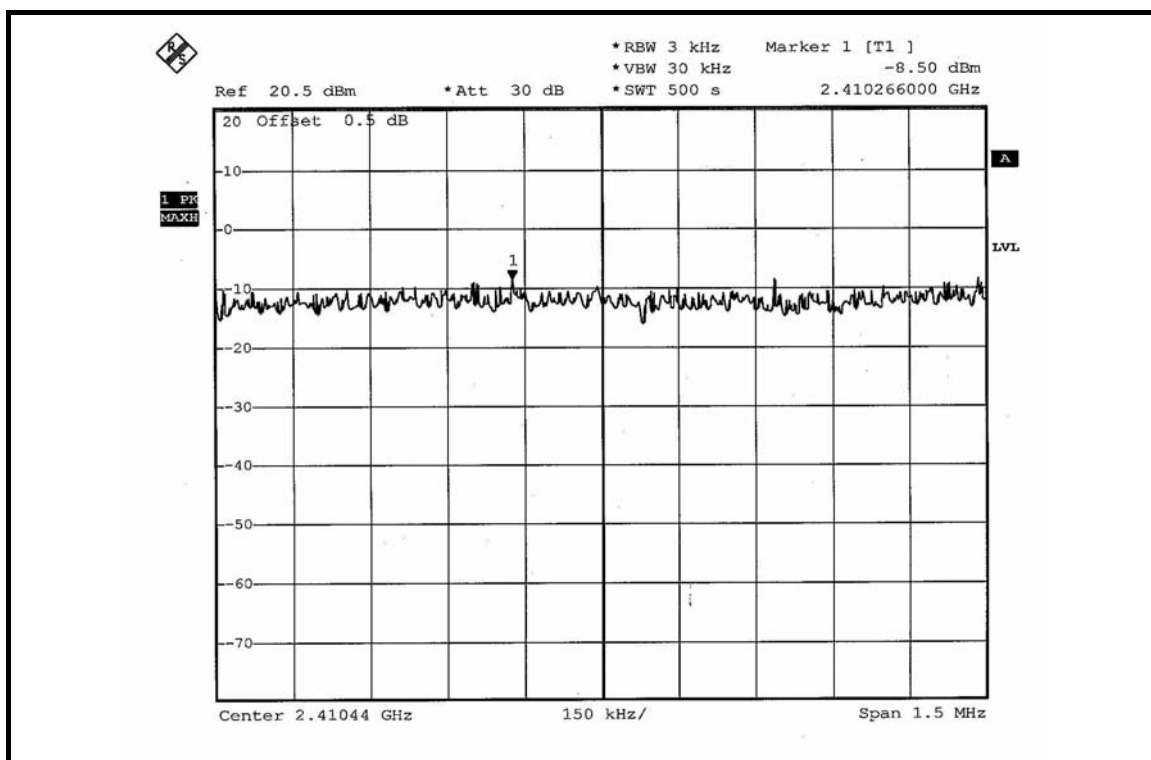

CH 6

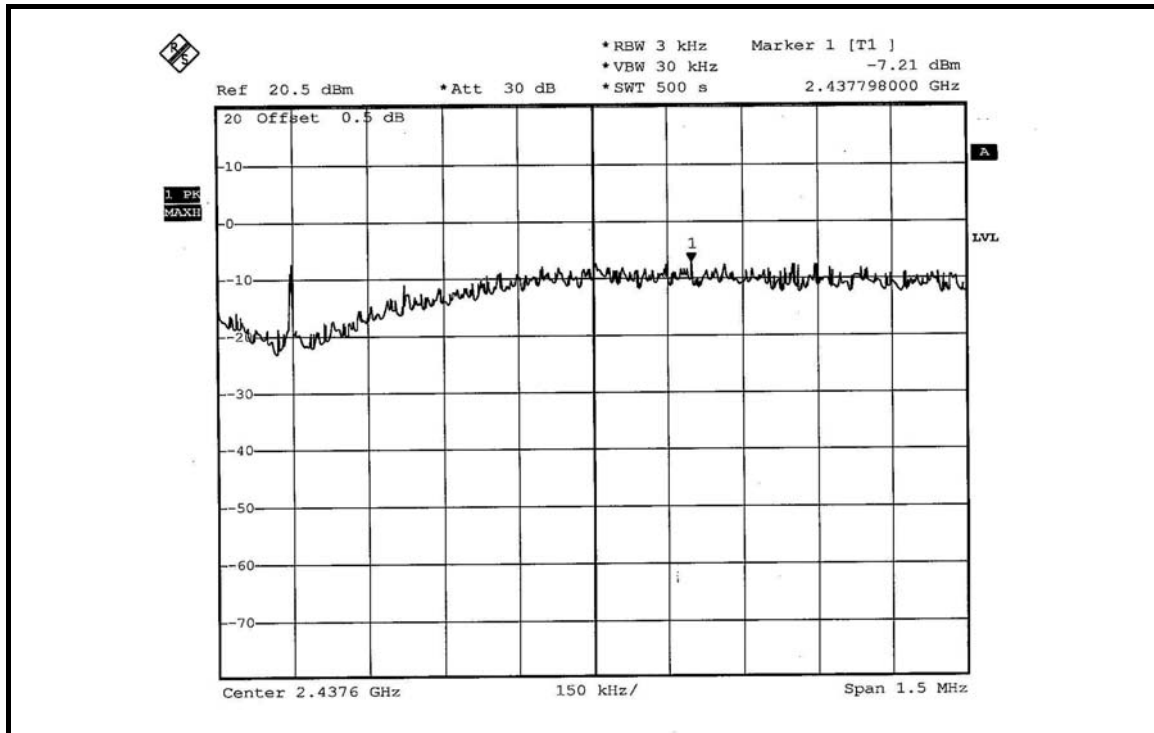

CH 11

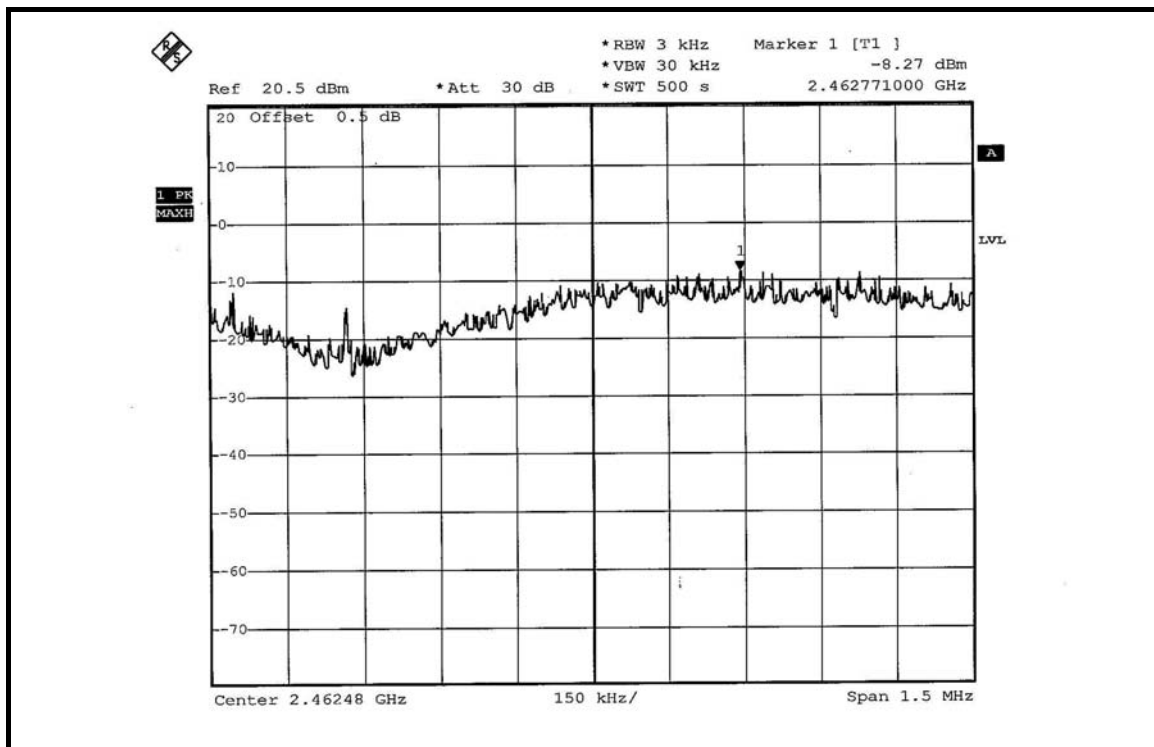

FOR CHAIN 1: CH 1

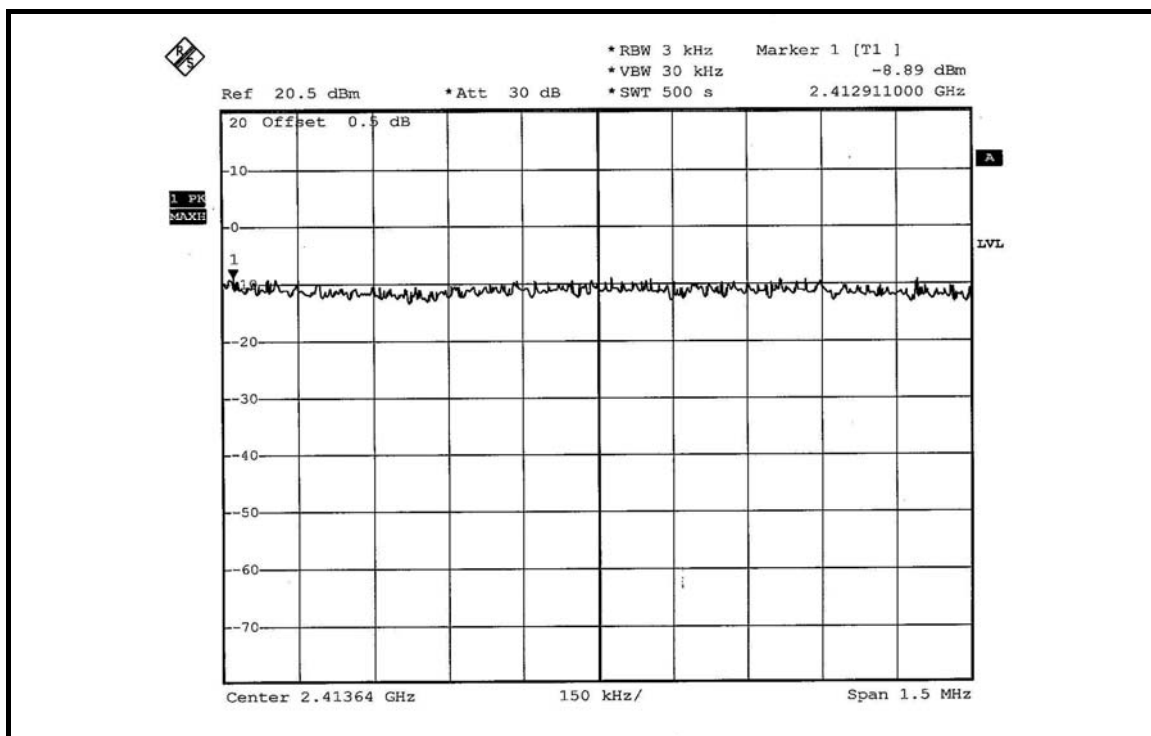

CH 6

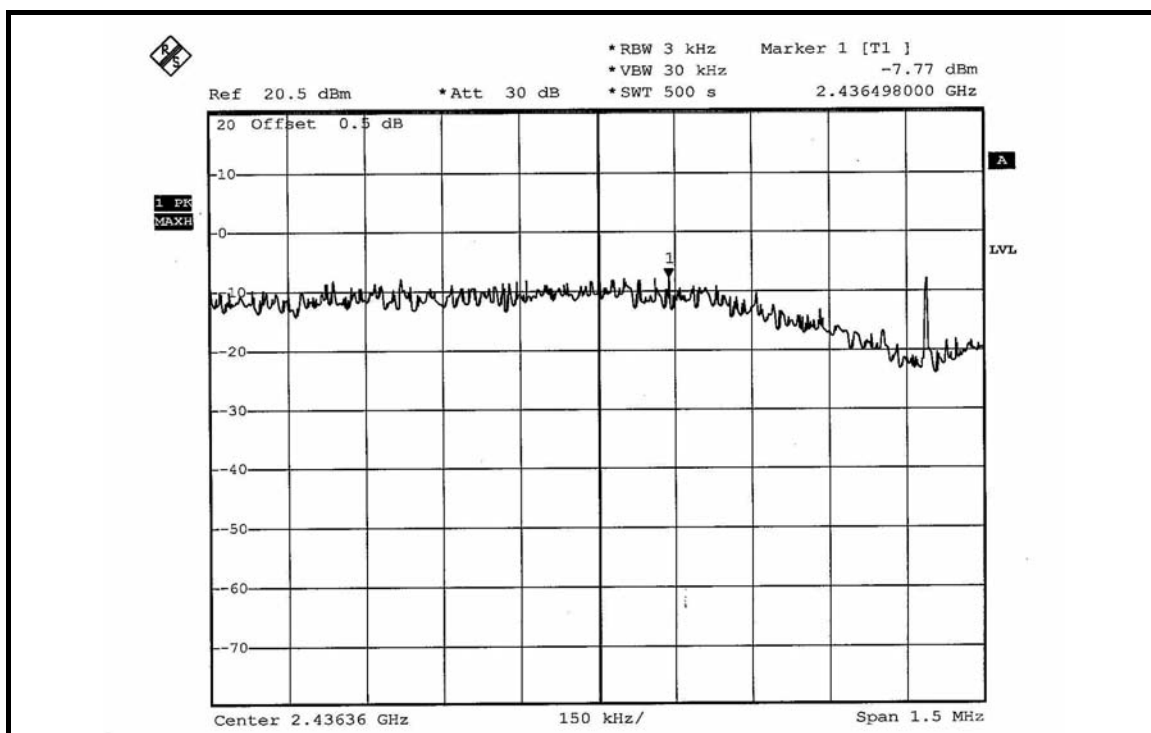

802.11g OFDM MODULATION:

MODULATION TYPE	BPSK	TRANSFER RATE	6.0Mbps
INPUT POWER (SYSTEM)	120Vac, 60 Hz	ENVIRONMENTAL CONDITIONS	25deg.C, 65% RH, 991hPa
TESTED BY	Brad Wu		

CHANNEL	CHANNEL FREQUENCY (MHz)	RF POWER LEVEL IN 3kHz BW (dBm)		MAXIMUM LIMIT (dBm)	PASS / FAIL
		CHAIN 0	CHAIN 1		
1	2412	-12.02	-12.32	8	PASS
6	2437	-9.14	-9.36	8	PASS
11	2462	-12.28	-12.34	8	PASS

FOR CHAIN 0: CH 1

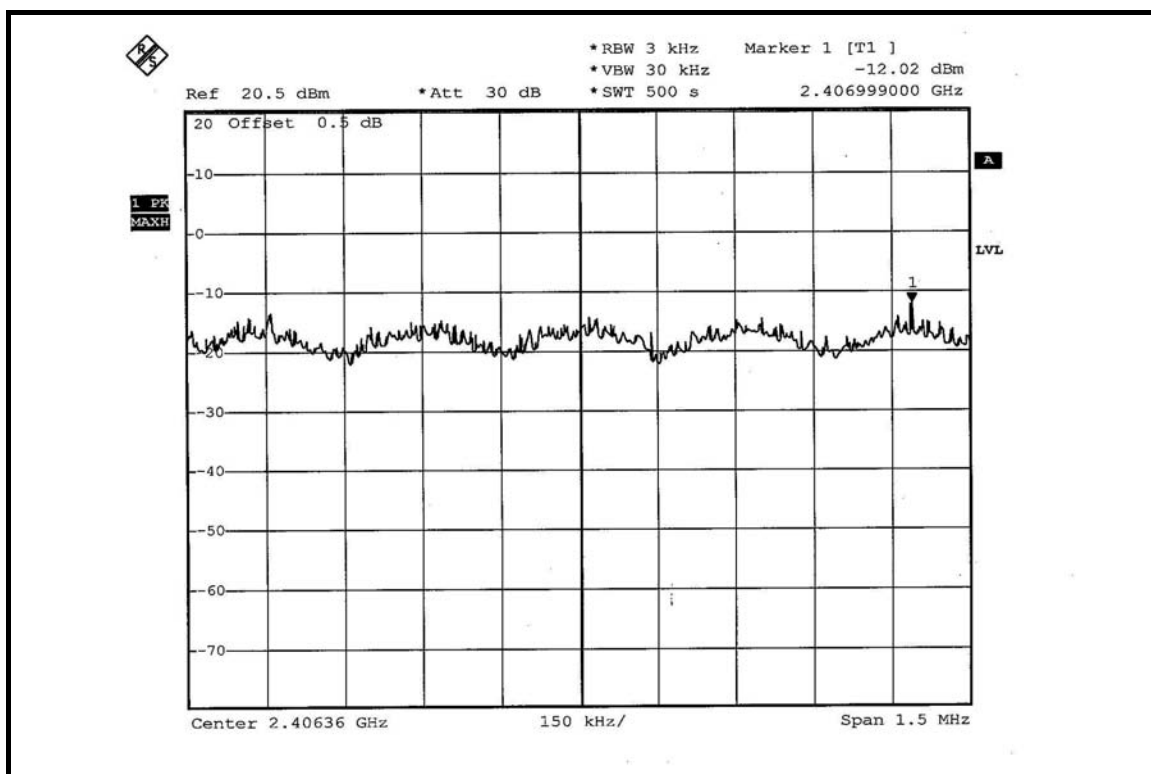

CH 6

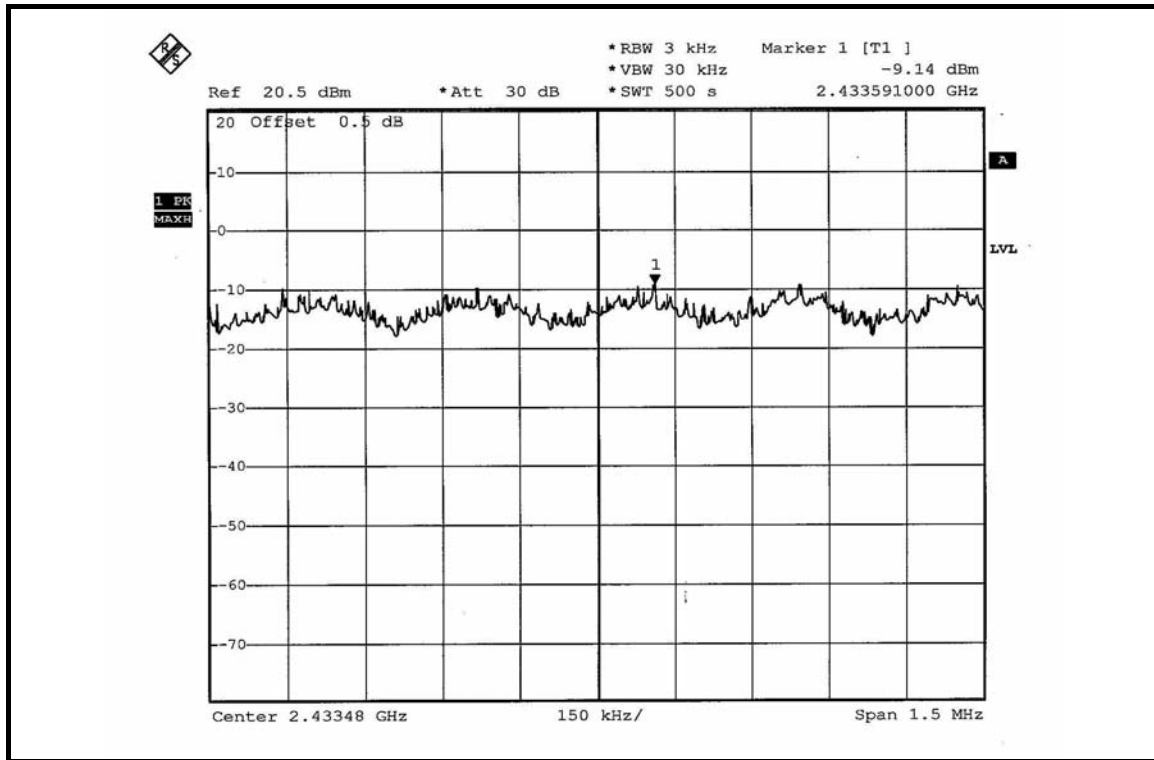

CH 11

