



FCC TEST REPORT

REPORT NO.: RF950410L19

MODEL NO.: F5D8001

RECEIVED: Apr. 19, 2006

TESTED: Apr. 19, ~ Apr. 23, 2006

ISSUED: Apr. 25, 2006

APPLICANT: Belkin Corporation

ADDRESS: 501 West Walnut Street, Compton, CA 90220,
U.S.A.

ISSUED BY: Advance Data Technology Corporation

LAB ADDRESS: 47 14th Lin, Chiapau Tsun, Linko, Taipei, Taiwan,
R.O.C.

TEST LOCATION: No. 19, Hwa Ya 2nd Rd., Kueishan, Taoyuan,
Taiwan, R.O.C.

This test report consists of 121 pages in total. It may be duplicated completely for legal use with the approval of the applicant. It should not be reproduced except in full, without the written approval of our laboratory. The client should not use it to claim product endorsement by CNLA, A2LA or any government agencies. The test results in the report only apply to the tested sample.



No. 2177-01



0528



TABLE OF CONTENTS

1.	CERTIFICATION	4
2.	SUMMARY OF TEST RESULTS	5
2.1	MEASUREMENT UNCERTAINTY	5
3.	GENERAL INFORMATION	6
3.1	GENERAL DESCRIPTION OF EUT	6
3.2	DESCRIPTION OF TEST MODES	7
3.2.1	CONFIGURATION OF SYSTEM UNDER TEST	7
3.2.2	TEST MODE APPLICABILITY AND TESTED CHANNEL DETAIL	8
3.3	GENERAL DESCRIPTION OF APPLIED STANDARDS	10
3.4	DESCRIPTION OF SUPPORT UNITS	10
4.	TEST TYPES AND RESULTS	11
4.1	CONDUCTED EMISSION MEASUREMENT	11
4.1.1	LIMITS OF CONDUCTED EMISSION MEASUREMENT	11
4.1.2	TEST INSTRUMENTS	11
4.1.3	TEST PROCEDURES	12
4.1.4	DEVIATION FROM TEST STANDARD	12
4.1.5	TEST SETUP	13
4.1.6	EUT OPERATING CONDITIONS	13
4.1.7	TEST RESULTS	14
4.2	RADIATED EMISSION MEASUREMENT	32
4.2.1	LIMITS OF RADIATED EMISSION MEASUREMENT	32
4.2.2	TEST INSTRUMENTS	33
4.2.3	TEST PROCEDURES	34
4.2.4	DEVIATION FROM TEST STANDARD	34
4.2.5	TEST SETUP	35
4.2.6	EUT OPERATING CONDITIONS	35
4.2.7	TEST RESULTS	36
4.3	6dB BANDWIDTH MEASUREMENT	51
4.3.1	LIMITS OF 6dB BANDWIDTH MEASUREMENT	51
4.3.2	TEST INSTRUMENTS	51
4.3.3	TEST PROCEDURE	51
4.3.4	DEVIATION FROM TEST STANDARD	51
4.3.5	TEST SETUP	52
4.3.6	EUT OPERATING CONDITIONS	52
4.3.7	TEST RESULTS	53
4.4	MAXIMUM PEAK OUTPUT POWER	73
4.4.1	LIMITS OF MAXIMUM PEAK OUTPUT POWER MEASUREMENT	73
4.4.2	INSTRUMENTS	73
4.4.3	TEST PROCEDURES	73



4.4.4	DEVIATION FROM TEST STANDARD	73
4.4.5	TEST SETUP	74
4.4.6	EUT OPERATING CONDITIONS	74
4.4.7	TEST RESULTS	75
4.5	POWER SPECTRAL DENSITY MEASUREMENT	77
4.5.1	LIMITS OF POWER SPECTRAL DENSITY MEASUREMENT	77
4.5.2	TEST INSTRUMENTS	77
4.5.3	TEST PROCEDURE	77
4.5.4	DEVIATION FROM TEST STANDARD	77
4.5.5	TEST SETUP	78
4.5.6	EUT OPERATING CONDITION	78
4.5.7	TEST RESULTS	79
4.6	BAND EDGES MEASUREMENT	99
4.6.1	LIMITS OF BAND EDGES MEASUREMENT	99
4.6.2	TEST INSTRUMENTS	99
4.6.3	TEST PROCEDURE	100
4.6.4	DEVIATION FROM TEST STANDARD	100
4.6.5	EUT OPERATING CONDITION	100
4.6.6	TEST RESULTS	101
4.7	ANTENNA REQUIREMENT	117
4.7.1	STANDARD APPLICABLE	117
4.7.2	ANTENNA CONNECTED CONSTRUCTION	117
5.	PHOTOGRAPHS OF THE TEST CONFIGURATION	118
6.	INFORMATION ON THE TESTING LABORATORIES	120
	APPENDIX-A	A-1



1. CERTIFICATION

PRODUCT : N1 Wireless Desktop Card
MODEL NO.: F5D8001
BRAND: Belkin
APPLICANT : Belkin Corporation
TESTED: Apr. 19, ~ Apr. 23, 2006
TEST SAMPLE: ENGINEERING SAMPLE
STANDARDS : FCC Part 15, Subpart C (Section 15.247),
ANSI C63.4-2003

The above equipment has been tested by **Advance Data Technology Corporation**, and found compliance with the requirement of the above standards. The test record, data evaluation & Equipment Under Test (EUT) configurations represented herein are true and accurate accounts of the measurements of the sample's EMC characteristics under the conditions specified in this report.

PREPARED BY :  , **DATE:** Apr. 25, 2006
Stephanie Hung

TECHNICAL ACCEPTANCE :  , **DATE:** Apr. 25, 2006
Responsible for RF Long Chen

APPROVED BY :  , **DATE:** Apr. 25, 2006
Gary Chang / Supervisor

2. SUMMARY OF TEST RESULTS

The EUT has been tested according to the following specifications:

APPLIED STANDARD: FCC Part 15, Subpart C			
STANDARD SECTION	TEST TYPE AND LIMIT	RESULT	REMARK
15.207	AC Power Conducted Emission	PASS	Meet the requirement of limit. Minimum passing margin is -13.64dB at 0.642MHz.
15.247(a)(2)	Spectrum Bandwidth of a Direct Sequence Spread Spectrum System Limit : min. 500kHz	PASS	Meet the requirement of limit.
15.247(b)	Maximum Peak Output Power Limit: max. 30dBm	PASS	Meet the requirement of limit.
15.247(d)	Transmitter Radiated Emissions Limit: Table 15.209	PASS	Meet the requirement of limit. Minimum passing margin is -1.15dB at 7311.00MHz.
15.247(e)	Power Spectral Density Limit: max. 8dBm	PASS	Meet the requirement of limit.
15.247(d)	Band Edge Measurement Limit: 20dB less than the peak value of fundamental frequency	PASS	Meet the requirement of limit.

2.1 MEASUREMENT UNCERTAINTY

Where relevant, the following measurement uncertainty levels have been estimated for tests performed on the EUT as specified in CISPR 16-4:

MEASUREMENT	FREQUENCY	UNCERTAINTY
Conducted emissions	9kHz ~ 30MHz	2.44dB
Radiated emissions	30MHz ~ 200MHz	3.73dB
	200MHz ~1000MHz	3.74dB
	1GHz ~ 18GHz	2.20dB
	18GHz ~ 40GHz	1.88dB

This uncertainty represents an expanded uncertainty expressed at approximately the 95% confidence level using a coverage factor of $k = 2$.

3. GENERAL INFORMATION

3.1 GENERAL DESCRIPTION OF EUT

PRODUCT	N1 Wireless Desktop Card
MODEL NO.	F5D8001
FCC ID	K7SF5D8001
POWER SUPPLY	3.3Vdc from host equipment
MODULATION TYPE	CCK, DQPSK, DBPSK for DSSS 64QAM, 16QAM, QPSK, BPSK for OFDM
MODULATION TECHNOLOGY	DSSS, OFDM
TRANSFER RATE	802.11b: 11/ 5.5/ 2/ 1Mbps 802.11g: 54/ 48/ 36/ 24/ 18/ 12/ 9/ 6Mbps Draft 802.11n (20MHz): 144.444/ 130.000/ 115.556/ 86.667/ 57.778/ 43.333/ 28.889/ 14.444/ 72.2/ 65.0/ 57.8/ 43.3/ 28.9/ 21.7/ 14.4/ 7.2Mbps Draft 802.11n (40MHz): 300/ 270/ 240/ 180/ 120/ 90/ 60/ 30/ 150/ 135/ 120/ 90/ 60/ 45/ 30/ 15Mbps
FREQUENCY RANGE	2412MHz ~ 2462MHz
NUMBER OF CHANNEL	11 for 802.11b, 802.11g, draft 802.11n (20MHz) 7 for draft 802.11n (40MHz)
MAXIMUM OUTPUT POWER	214.290mW
ANTENNA TYPE	Dipole antenna with 0.3dBi gain
DATA CABLE	NA
I/O PORTS	NA

NOTE:

1. The EUT incorporates a MIMO function with 802.11b, 802.11g, draft 802.11n. Physically, the card provides three completed transmit and three receivers.
2. The EUT is 3 * 3 spatial MIMO (3Tx & 3Rx) without beam forming function that only operate triple chain configuration (chain 0, chain 1 and chain 2 transceivers are operational).
3. When the EUT operating in 802.11b, 802.11g, the software operation, which is defined by manufacturer, only set triple Tx.
4. When the EUT operating in draft 802.11n, the software operation, which is defined by manufacturer, only set 0 ~ 15 of "MCS" (MCS: Modulation and Coding Schemes) for triple Tx.
5. The EUT complies with draft 802.11n standards and backwards compatible with 802.11b, 802.11g products.
5. The EUT operates in the 2.4GHz frequency spectrum with throughput of up to 300Mbps.
6. The above EUT information was declared by manufacturer and for more detailed features description, please refer to the manufacturer's specifications or user's manual.

3.2 DESCRIPTION OF TEST MODES

Eleven channels are provided for 802.11b, 802.11g, draft 802.11n (20MHz):

CHANNEL	FREQUENCY	CHANNEL	FREQUENCY
1	2412MHz	7	2442MHz
2	2417MHz	8	2447MHz
3	2422MHz	9	2452MHz
4	2427MHz	10	2457MHz
5	2432MHz	11	2462MHz
6	2437MHz		

Seven channels are provided for draft 802.11n (40MHz):

CHANNEL	FREQUENCY	CHANNEL	FREQUENCY
1	2422MHz	5	2442MHz
2	2427MHz	6	2447MHz
3	2432MHz	7	2452MHz
4	2437MHz		

3.2.1 CONFIGURATION OF SYSTEM UNDER TEST

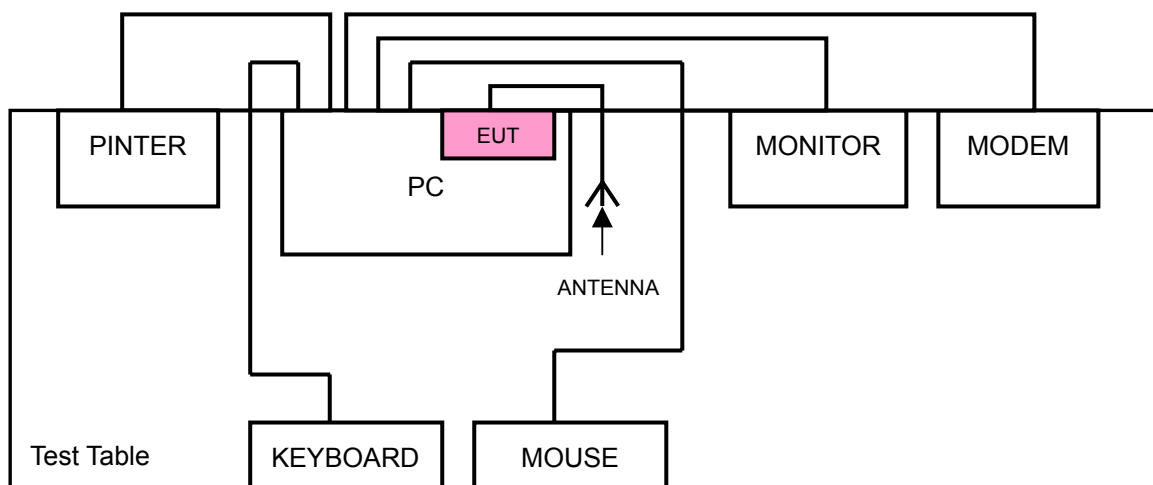

3.2.2 TEST MODE APPLICABILITY AND TESTED CHANNEL DETAIL

EUT CONFIGURE MODE	APPLICABLE TO				DESCRIPTION
	PLC	RE < 1G	RE ≥ 1G	APCM	
-	√	√	√	√	-

Where **PLC**: Power Line Conducted Emission **RE < 1G**: Radiated Emission below 1GHz
RE ≥ 1G: Radiated Emission above 1GHz **APCM**: Antenna Port Conducted Measurement

POWER LINE CONDUCTED EMISSION TEST:

- Pre-Scan has been conducted to determine the worst-case mode from all possible combinations between available modulations, data rates and antenna ports (if EUT with antenna diversity architecture).
- Following channel(s) was (were) selected for the final test as listed below.

MODE	AVAILABLE CHANNEL	TESTED CHANNEL	MODULATION TECHNOLOGY	MODULATION TYPE	DATA RATE (Mbps)
802.11g	1 to 11	1, 6, 11	OFDM	BPSK	6.0
Draft 802.11n (20MHz)	1 to 11	1, 6, 11	OFDM	BPSK	7.2
Draft 802.11n (40MHz)	1 to 7	1, 4, 7	OFDM	BPSK	15.0

RADIATED EMISSION TEST (BELOW 1 GHz):

- Pre-Scan has been conducted to determine the worst-case mode from all possible combinations between available modulations, data rates and antenna ports (if EUT with antenna diversity architecture).
- Following channel(s) was (were) selected for the final test as listed below.

MODE	AVAILABLE CHANNEL	TESTED CHANNEL	MODULATION TECHNOLOGY	MODULATION TYPE	DATA RATE (Mbps)
802.11g	1 to 11	1	OFDM	BPSK	6.0
Draft 802.11n (20MHz)	1 to 11	1	OFDM	BPSK	7.2
Draft 802.11n (40MHz)	1 to 7	1	OFDM	BPSK	15.0

RADIATED EMISSION TEST (ABOVE 1 GHz):

- Pre-Scan has been conducted to determine the worst-case mode from all possible combinations between available modulations, data rates and antenna ports (if EUT with antenna diversity architecture).
- Following channel(s) was (were) selected for the final test as listed below.

MODE	AVAILABLE CHANNEL	TESTED CHANNEL	MODULATION TECHNOLOGY	MODULATION TYPE	DATA RATE (Mbps)
802.11b	1 to 11	1, 6, 11	DSSS	DBPSK	1.0
802.11g	1 to 11	1, 6, 11	OFDM	BPSK	6.0
Draft 802.11n (20MHz)	1 to 11	1, 6, 11	OFDM	BPSK	7.2
Draft 802.11n (40MHz)	1 to 7	1, 4, 7	OFDM	BPSK	15.0

BANDEDGE MEASUREMENT:

- Pre-Scan has been conducted to determine the worst-case mode from all possible combinations between available modulations, data rates and antenna ports (if EUT with antenna diversity architecture).
- Following channel(s) was (were) selected for the final test as listed below.

MODE	AVAILABLE CHANNEL	TESTED CHANNEL	MODULATION TECHNOLOGY	MODULATION TYPE	DATA RATE (Mbps)
802.11b	1 to 11	1, 11	DSSS	DBPSK	1.0
802.11g	1 to 11	1, 11	OFDM	BPSK	6.0
Draft 802.11n (20MHz)	1 to 11	1, 11	OFDM	BPSK	7.2
Draft 802.11n (40MHz)	1 to 7	1, 7	OFDM	BPSK	15.0

ANTENNA PORT CONDUCTED MEASUREMENT:

- Pre-Scan has been conducted to determine the worst-case mode from all possible combinations between available modulations, data rates and antenna ports (if EUT with antenna diversity architecture).
- Following channel(s) was (were) selected for the final test as listed below.

MODE	AVAILABLE CHANNEL	TESTED CHANNEL	MODULATION TECHNOLOGY	MODULATION TYPE	DATA RATE (Mbps)
802.11b	1 to 11	1, 6, 11	DSSS	DBPSK	1.0
802.11g	1 to 11	1, 6, 11	OFDM	BPSK	6.0
Draft 802.11n (20MHz)	1 to 11	1, 6, 11	OFDM	BPSK	7.2
Draft 802.11n (40MHz)	1 to 7	1, 4, 7	OFDM	BPSK	15.0



3.3 GENERAL DESCRIPTION OF APPLIED STANDARDS

The EUT is a RF product. According to the specifications of the manufacturer, it must comply with the requirements of the following standards:

FCC Part 15, Subpart C. (15.247)

ANSI C63.4-2003

All test items have been performed and recorded as per the above standards.

NOTE: The EUT is also considered as a kind of computer peripheral, because the connection to computer is necessary for typical use. It has been verified to comply with the requirements of FCC Part 15, Subpart B, Class B (DoC). The test report has been issued separately.

3.4 DESCRIPTION OF SUPPORT UNITS

The EUT has been tested as an independent unit together with other necessary accessories or support units. The following support units or accessories were used to form a representative test configuration during the tests.

NO.	PRODUCT	BRAND	MODEL NO.	SERIAL NO.	FCC ID
1	PC	MSI	Hetis 865G Giga	3AS0119572	FCC DoC Approved
2	PRINTER	EPSON	LQ-300+	DCGY054146	FCC DoC Approved
3	MODEM	ACEEX	1414V/3	0401008260	IFAXDM1414
4	LCD MONITOR	ACER	AL1721	ET.L0408.010404 001F9PK00	FCC DoC Approved
5	DELL PS/2 MOUSE	DELL	M071KC	504008969	FCC DoC Approved
6	Keyboard	DELL	SK-8110	MY-05N456- 71619-4B5-1041	FCC DoC Approved

NO.	SIGNAL CABLE DESCRIPTION OF THE ABOVE SUPPORT UNITS
1	NA
2	1.2m shielded cable
3	1.2m shielded cable
4	1.8m shielded cable
5	1.5m non-shielded cable
6	1.5m non-shielded cable

NOTE: All power cords of the above support units are non-shielded (1.8m).



4. TEST TYPES AND RESULTS

4.1 CONDUCTED EMISSION MEASUREMENT

4.1.1 LIMITS OF CONDUCTED EMISSION MEASUREMENT

FREQUENCY OF EMISSION (MHz)	CONDUCTED LIMIT (dB μ V)	
	Quasi-peak	Average
0.15-0.5	66 to 56	56 to 46
0.5-5	56	46
5-30	60	50

- NOTE:**
1. The lower limit shall apply at the transition frequencies.
 2. The limit decreases in line with the logarithm of the frequency in the range of 0.15 to 0.50 MHz.
 3. All emanations from a class A/B digital device or system, including any network of conductors and apparatus connected thereto, shall not exceed the level of field strengths specified above.

4.1.2 TEST INSTRUMENTS

DESCRIPTION & MANUFACTURER	MODEL NO.	SERIAL NO.	CALIBRATED UNTIL
Test Receiver ROHDE & SCHWARZ	ESCS30	100291	Nov. 11, 2006
RF signal cable Woken	5D-FB	Cable-HYC01-01	Jan. 06, 2007
LISN SCHWARZBECK	NNBL 8226-2	8226-142	May 02, 2006
LISN ROHDE & SCHWARZ	ESH2-Z5	100104	Feb. 07, 2007
Software ADT	ADT_Cond_V3	NA	NA

- NOTE:**
1. The calibration interval of the above test instruments is 12 months and the calibrations are traceable to NML/ROC and NIST/USA.
 2. The test was performed in HwaYa Shielded Room 1.
 3. The VCCI Site Registration No. is C-2040.

4.1.3 TEST PROCEDURES

- a. The EUT was placed 0.4 meters from the conducting wall of the shielded room with EUT being connected to the power mains through a line impedance stabilization network (LISN). Other support units were connected to the power mains through another LISN. The two LISNs provide 50 ohm/ 50uH of coupling impedance for the measuring instrument.
- b. Both lines of the power mains connected to the EUT were checked for maximum conducted interference.
- c. The frequency range from 150kHz to 30MHz was searched. Emission levels under (Limit - 20dB) was not recorded.

4.1.4 DEVIATION FROM TEST STANDARD

No deviation

4.1.5 TEST SETUP

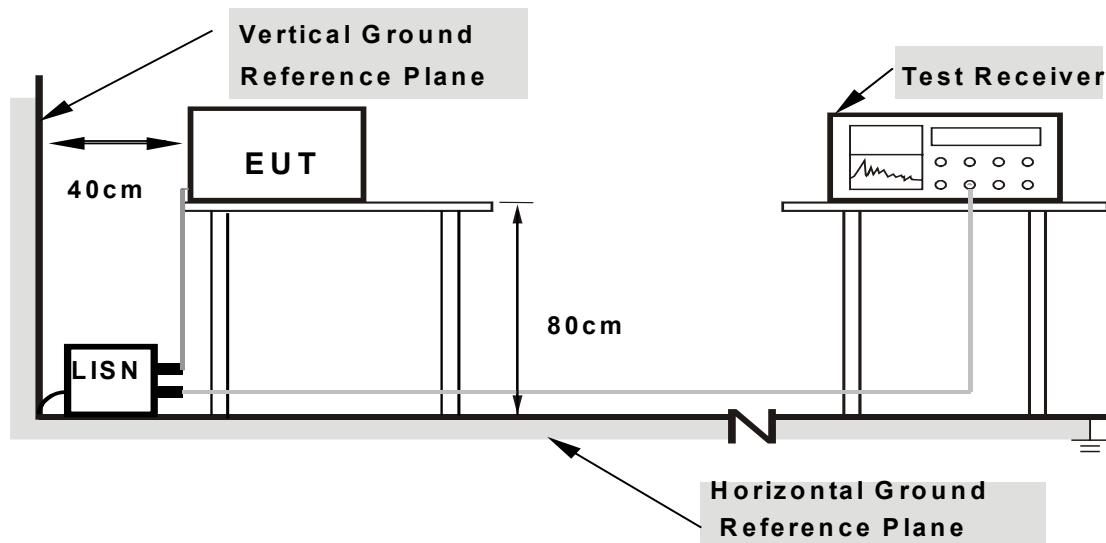

Note: 1. Support units were connected to second LISN.

2. Both of LISNs (AMN) are 80 cm from EUT and at least 80 from other units and other metal planes

For the actual test configuration, please refer to the related item – Photographs of the Test Configuration.

4.1.6 EUT OPERATING CONDITIONS

- a. Connected the EUT into the computer system and placed on a testing table.
- b. The computer system ran a test program (provided by manufacturer) to enable EUT under transmission/receiving condition continuously at specific channel frequency.
- c. The computer system sent "H" messages to monitor, and the monitor displayed them on the screen.
- d. The computer system show "H" messages to modem.
- e. The computer system sent "H" messages to printer and the printer prints them on paper.
- f. Repeated item c ~e.

4.1.7 TEST RESULTS

CONDUCTED WORST-CASE DATA: 802.11g OFDM MODULATION:

EUT TEST CONDITION		MEASUREMENT DETAIL	
CHANNEL	Channel 1	PHASE	Line 1
MODULATION TYPE	BPSK	6dB BANDWIDTH	9 kHz
TRANSFER RATE	6.0Mbps	INPUT POWER (SYSTEM)	120Vac, 60 Hz
ENVIRONMENTAL CONDITIONS	22deg. C, 62%RH, 991hPa	TESTED BY	Brad Wu

No	FREQ.	CORR.	READING VALUE		EMISSION LEVEL		LIMIT		MARGIN	
	[MHz]	Factor	[dB (uV)]		[dB (uV)]		[dB (uV)]		(dB)	
		(dB)	Q.P.	AV.	Q.P.	AV.	Q.P.	AV.	Q.P.	AV.
1	0.193	0.10	46.45	-	46.55	-	63.91	53.91	-17.36	-
2	0.255	0.10	41.03	-	41.13	-	61.58	51.58	-20.45	-
3	0.451	0.11	35.53	-	35.64	-	56.86	46.86	-21.22	-
4	2.438	0.26	35.95	-	36.21	-	56.00	46.00	-19.79	-
5	4.488	0.47	36.37	-	36.84	-	56.00	46.00	-19.16	-
6	23.094	0.95	43.02	-	43.97	-	60.00	50.00	-16.03	-

- REMARKS:**
1. Q.P. and AV. are abbreviations of quasi-peak and average individually.
 2. "-": The Quasi-peak reading value also meets average limit and measurement with the average detector is unnecessary.
 3. The emission levels of other frequencies were very low against the limit.
 4. Margin value = Emission level - Limit value
 5. Correction factor = Insertion loss + Cable loss
 6. Emission Level = Correction Factor + Reading Value.

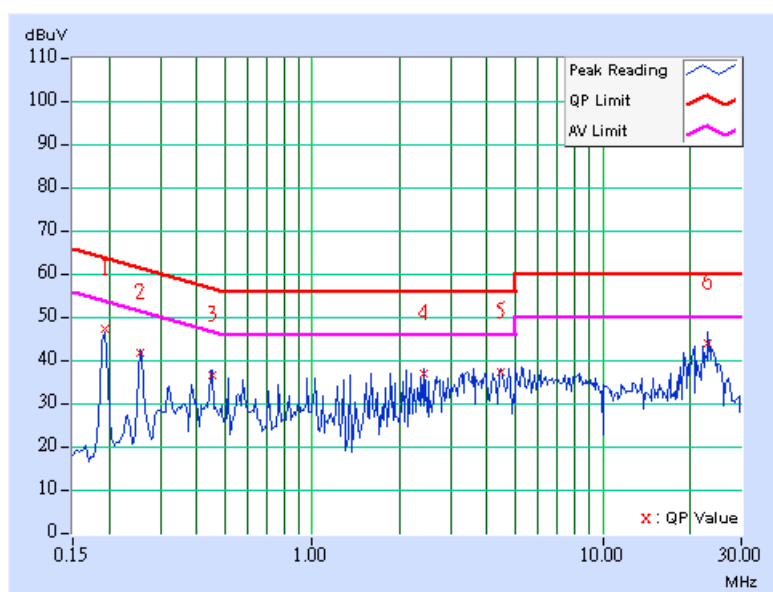

EUT TEST CONDITION		MEASUREMENT DETAIL	
CHANNEL	Channel 1	PHASE	Line 2
MODULATION TYPE	BPSK	6dB BANDWIDTH	9 kHz
TRANSFER RATE	6.0Mbps	INPUT POWER (SYSTEM)	120Vac, 60 Hz
ENVIRONMENTAL CONDITIONS	22deg. C, 62%RH, 991hPa	TESTED BY	Brad Wu

No	FREQ. [MHz]	CORR. Factor (dB)	READING VALUE [dB (uV)]		EMISSION LEVEL [dB (uV)]		LIMIT [dB (uV)]		MARGIN (dB)	
			Q.P.	AV.	Q.P.	AV.	Q.P.	AV.	Q.P.	AV.
1	0.193	0.10	44.91	-	45.01	-	63.91	53.91	-18.90	-
2	0.384	0.10	41.42	-	41.52	-	58.18	48.18	-16.66	-
3	0.642	0.10	41.92	-	42.02	-	56.00	46.00	-13.98	-
4	0.705	0.10	41.21	-	41.31	-	56.00	46.00	-14.69	-
5	3.465	0.32	35.41	-	35.73	-	56.00	46.00	-20.27	-
6	22.707	0.63	40.37	-	41.00	-	60.00	50.00	-19.00	-

- REMARKS:**
1. Q.P. and AV. are abbreviations of quasi-peak and average individually.
 2. "-": The Quasi-peak reading value also meets average limit and measurement with the average detector is unnecessary.
 3. The emission levels of other frequencies were very low against the limit.
 4. Margin value = Emission level - Limit value
 5. Correction factor = Insertion loss + Cable loss
 6. Emission Level = Correction Factor + Reading Value.

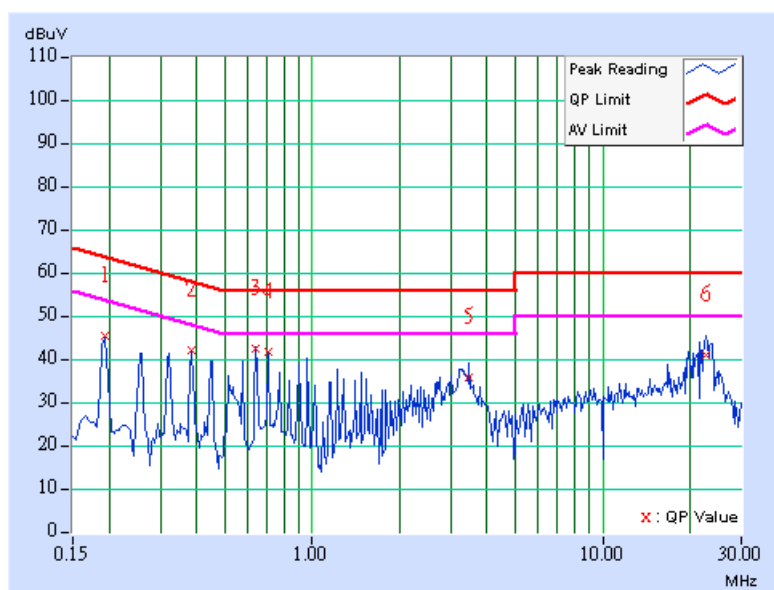

EUT TEST CONDITION		MEASUREMENT DETAIL	
CHANNEL	Channel 6	PHASE	Line 1
MODULATION TYPE	BPSK	6dB BANDWIDTH	9 kHz
TRANSFER RATE	6.0Mbps	INPUT POWER (SYSTEM)	120Vac, 60 Hz
ENVIRONMENTAL CONDITIONS	22deg. C, 62%RH, 991hPa	TESTED BY	Brad Wu

No	FREQ. [MHz]	CORR. Factor (dB)	READING VALUE [dB (uV)]		EMISSION LEVEL [dB (uV)]		LIMIT [dB (uV)]		MARGIN (dB)	
			Q.P.	AV.	Q.P.	AV.	Q.P.	AV.	Q.P.	AV.
1	0.193	0.10	31.66	-	31.76	-	63.91	53.91	-32.15	-
2	0.255	0.10	26.74	-	26.84	-	61.58	51.58	-34.74	-
3	0.451	0.11	28.12	-	28.23	-	56.86	46.86	-28.63	-
4	1.348	0.20	34.43	-	34.63	-	56.00	46.00	-21.37	-
5	3.336	0.38	27.76	-	28.14	-	56.00	46.00	-27.86	-
6	23.039	0.95	37.69	-	38.64	-	60.00	50.00	-21.36	-

- REMARKS:**
1. Q.P. and AV. are abbreviations of quasi-peak and average individually.
 2. "-": The Quasi-peak reading value also meets average limit and measurement with the average detector is unnecessary.
 3. The emission levels of other frequencies were very low against the limit.
 4. Margin value = Emission level - Limit value
 5. Correction factor = Insertion loss + Cable loss
 6. Emission Level = Correction Factor + Reading Value.

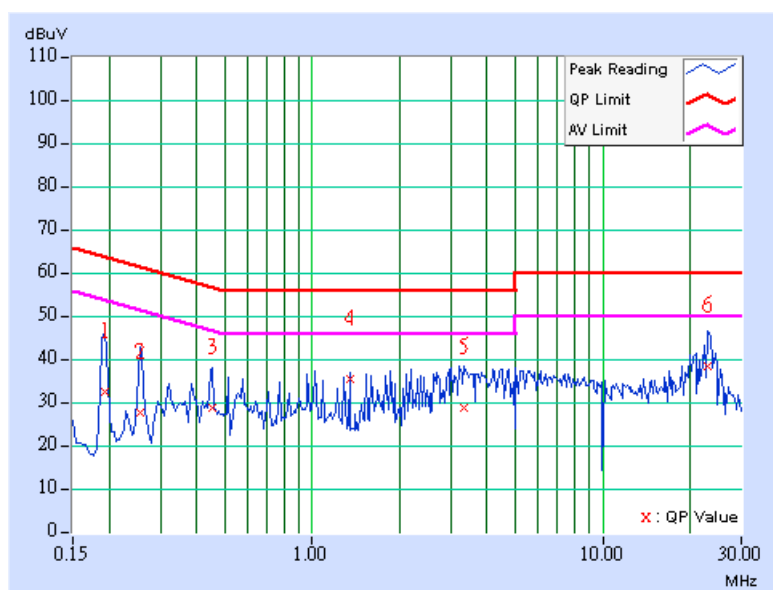

EUT TEST CONDITION		MEASUREMENT DETAIL	
CHANNEL	Channel 6	PHASE	Line 2
MODULATION TYPE	BPSK	6dB BANDWIDTH	9 kHz
TRANSFER RATE	6.0Mbps	INPUT POWER (SYSTEM)	120Vac, 60 Hz
ENVIRONMENTAL CONDITIONS	22deg. C, 62%RH, 991hPa	TESTED BY	Brad Wu

No	FREQ.	CORR.	READING VALUE		EMISSION LEVEL		LIMIT		MARGIN	
	[MHz]	Factor (dB)	Q.P. [dB (uV)]	AV. [dB (uV)]	Q.P. [dB (uV)]	AV. [dB (uV)]	Q.P. [dB (uV)]	AV. [dB (uV)]	Q.P. (dB)	AV. (dB)
1	0.193	0.10	45.13	-	45.23	-	63.91	53.91	-18.68	-
2	0.384	0.10	41.73	-	41.83	-	58.18	48.18	-16.35	-
3	0.642	0.10	42.26	-	42.36	-	56.00	46.00	-13.64	-
4	0.705	0.10	41.45	-	41.55	-	56.00	46.00	-14.45	-
5	3.402	0.32	33.97	-	34.29	-	56.00	46.00	-21.71	-
6	23.035	0.63	41.53	-	42.16	-	60.00	50.00	-17.84	-

- REMARKS:**
1. Q.P. and AV. are abbreviations of quasi-peak and average individually.
 2. "-": The Quasi-peak reading value also meets average limit and measurement with the average detector is unnecessary.
 3. The emission levels of other frequencies were very low against the limit.
 4. Margin value = Emission level - Limit value
 5. Correction factor = Insertion loss + Cable loss
 6. Emission Level = Correction Factor + Reading Value.

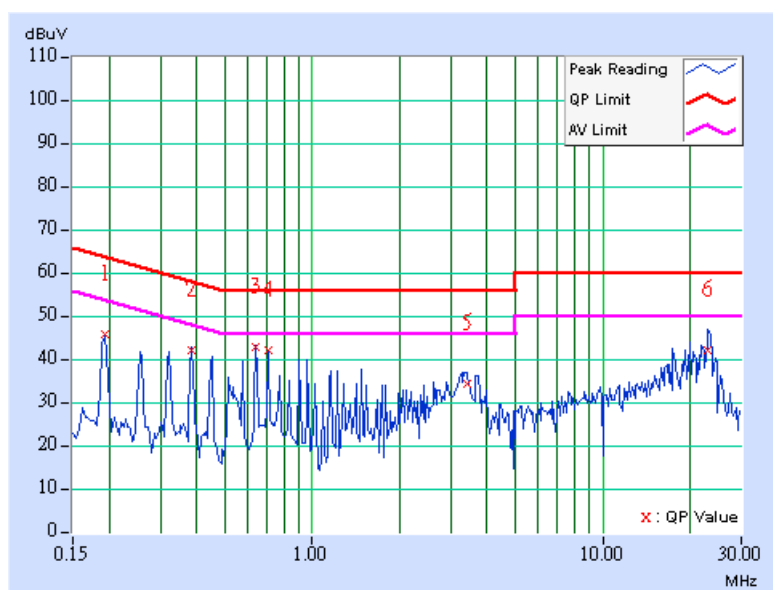

EUT TEST CONDITION		MEASUREMENT DETAIL	
CHANNEL	Channel 11	PHASE	Line 1
MODULATION TYPE	BPSK	6dB BANDWIDTH	9 kHz
TRANSFER RATE	6.0Mbps	INPUT POWER (SYSTEM)	120Vac, 60 Hz
ENVIRONMENTAL CONDITIONS	22deg. C, 62%RH, 991hPa	TESTED BY	Brad Wu

No	FREQ. [MHz]	CORR. Factor (dB)	READING VALUE [dB (uV)]		EMISSION LEVEL [dB (uV)]		LIMIT [dB (uV)]		MARGIN (dB)	
			Q.P.	AV.	Q.P.	AV.	Q.P.	AV.	Q.P.	AV.
1	0.193	0.10	46.77	-	46.87	-	63.91	53.91	-17.04	-
2	0.255	0.10	41.99	-	42.09	-	61.58	51.58	-19.49	-
3	0.451	0.11	35.10	-	35.21	-	56.86	46.86	-21.65	-
4	1.539	0.20	34.99	-	35.19	-	56.00	46.00	-20.81	-
5	4.688	0.47	37.02	-	37.49	-	56.00	46.00	-18.51	-
6	23.309	0.96	39.54	-	40.50	-	60.00	50.00	-19.50	-

- REMARKS:**
1. Q.P. and AV. are abbreviations of quasi-peak and average individually.
 2. "-": The Quasi-peak reading value also meets average limit and measurement with the average detector is unnecessary.
 3. The emission levels of other frequencies were very low against the limit.
 4. Margin value = Emission level - Limit value
 5. Correction factor = Insertion loss + Cable loss
 6. Emission Level = Correction Factor + Reading Value.

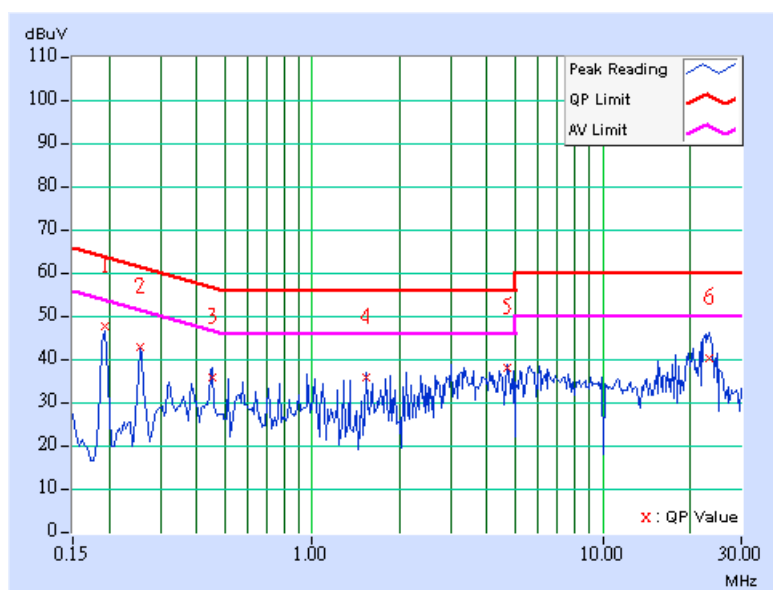

EUT TEST CONDITION		MEASUREMENT DETAIL	
CHANNEL	Channel 11	PHASE	Line 2
MODULATION TYPE	BPSK	6dB BANDWIDTH	9 kHz
TRANSFER RATE	6.0Mbps	INPUT POWER (SYSTEM)	120Vac, 60 Hz
ENVIRONMENTAL CONDITIONS	22deg. C, 62%RH, 991hPa	TESTED BY	Brad Wu

No	FREQ. [MHz]	CORR. Factor [dB]	READING VALUE [dB (uV)]		EMISSION LEVEL [dB (uV)]		LIMIT [dB (uV)]		MARGIN (dB)	
			Q.P.	AV.	Q.P.	AV.	Q.P.	AV.	Q.P.	AV.
1	0.193	0.10	44.97	-	45.07	-	63.91	53.91	-18.84	-
2	0.384	0.10	41.34	-	41.44	-	58.18	48.18	-16.74	-
3	0.642	0.10	42.02	-	42.12	-	56.00	46.00	-13.88	-
4	0.705	0.10	40.97	-	41.07	-	56.00	46.00	-14.93	-
5	3.277	0.31	36.22	-	36.53	-	56.00	46.00	-19.47	-
6	23.117	0.63	40.44	-	41.07	-	60.00	50.00	-18.93	-

- REMARKS:**
1. Q.P. and AV. are abbreviations of quasi-peak and average individually.
 2. "-": The Quasi-peak reading value also meets average limit and measurement with the average detector is unnecessary.
 3. The emission levels of other frequencies were very low against the limit.
 4. Margin value = Emission level - Limit value
 5. Correction factor = Insertion loss + Cable loss
 6. Emission Level = Correction Factor + Reading Value.

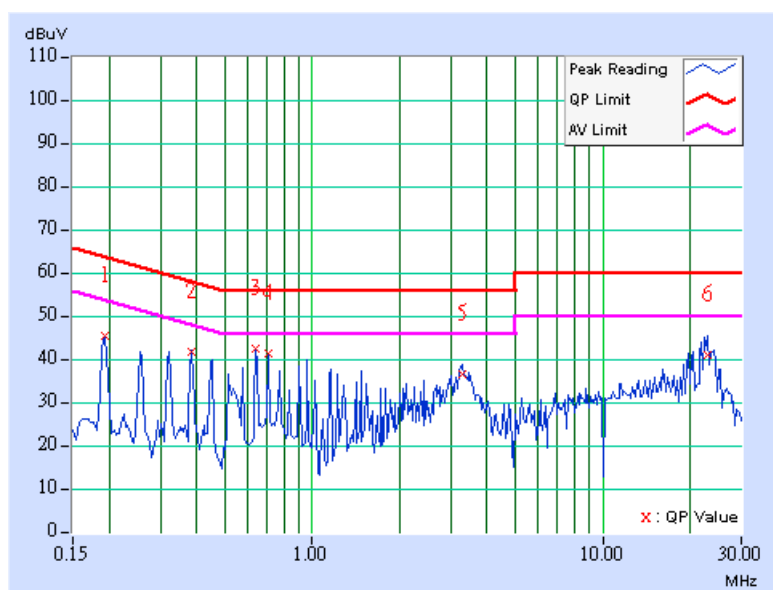

DRAFT 802.11n (20MHz) OFDM MODULATION:

EUT TEST CONDITION		MEASUREMENT DETAIL	
CHANNEL	Channel 1	PHASE	Line 1
MODULATION TYPE	BPSK	6dB BANDWIDTH	9 kHz
TRANSFER RATE	7.2Mbps	INPUT POWER (SYSTEM)	120Vac, 60 Hz
ENVIRONMENTAL CONDITIONS	22deg. C, 62%RH, 991hPa	TESTED BY	Brad Wu

No	FREQ.	CORR.	READING VALUE		EMISSION LEVEL		LIMIT		MARGIN	
	[MHz]	Factor	[dB (uV)]		[dB (uV)]		[dB (uV)]		(dB)	
		(dB)	Q.P.	AV.	Q.P.	AV.	Q.P.	AV.	Q.P.	AV.
1	0.193	0.10	46.33	-	46.43	-	63.91	53.91	-17.48	-
2	0.259	0.10	40.48	-	40.58	-	61.45	51.45	-20.87	-
3	0.451	0.11	35.69	-	35.80	-	56.86	46.86	-21.06	-
4	0.963	0.19	34.10	-	34.29	-	56.00	46.00	-21.71	-
5	5.781	0.47	36.24	-	36.71	-	60.00	50.00	-23.29	-
6	22.680	0.94	39.79	-	40.73	-	60.00	50.00	-19.27	-

- REMARKS:**
1. Q.P. and AV. are abbreviations of quasi-peak and average individually.
 2. "-": The Quasi-peak reading value also meets average limit and measurement with the average detector is unnecessary.
 3. The emission levels of other frequencies were very low against the limit.
 4. Margin value = Emission level - Limit value
 5. Correction factor = Insertion loss + Cable loss
 6. Emission Level = Correction Factor + Reading Value.

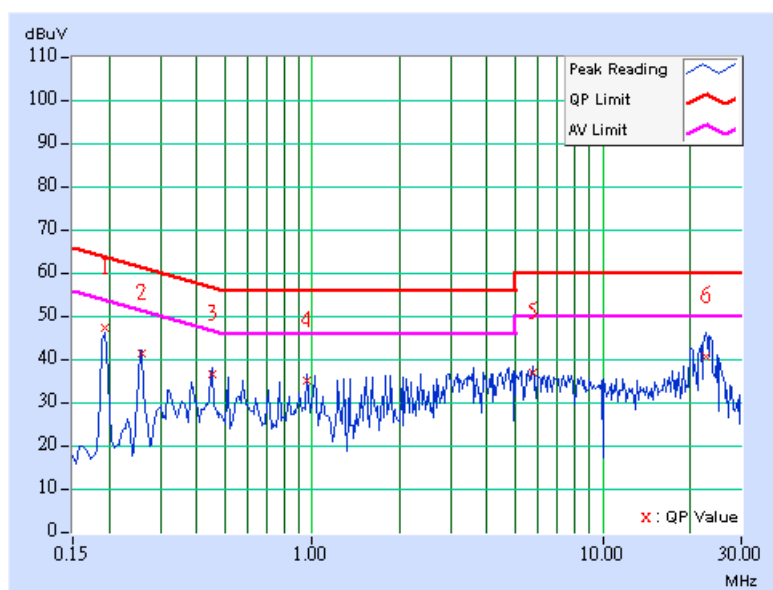

EUT TEST CONDITION		MEASUREMENT DETAIL	
CHANNEL	Channel 1	PHASE	Line 2
MODULATION TYPE	BPSK	6dB BANDWIDTH	9 kHz
TRANSFER RATE	7.2Mbps	INPUT POWER (SYSTEM)	120Vac, 60 Hz
ENVIRONMENTAL CONDITIONS	22deg. C, 62%RH, 991hPa	TESTED BY	Brad Wu

No	FREQ. [MHz]	CORR. Factor (dB)	READING VALUE [dB (uV)]		EMISSION LEVEL [dB (uV)]		LIMIT [dB (uV)]		MARGIN (dB)	
			Q.P.	AV.	Q.P.	AV.	Q.P.	AV.	Q.P.	AV.
1	0.193	0.10	44.83	-	44.93	-	63.91	53.91	-18.98	-
2	0.384	0.10	41.30	-	41.40	-	58.18	48.18	-16.78	-
3	0.642	0.10	41.86	-	41.96	-	56.00	46.00	-14.04	-
4	0.963	0.10	39.45	-	39.55	-	56.00	46.00	-16.45	-
5	3.277	0.31	37.02	-	37.33	-	56.00	46.00	-18.67	-
6	22.418	0.63	40.89	-	41.52	-	60.00	50.00	-18.48	-

- REMARKS:**
1. Q.P. and AV. are abbreviations of quasi-peak and average individually.
 2. "-": The Quasi-peak reading value also meets average limit and measurement with the average detector is unnecessary.
 3. The emission levels of other frequencies were very low against the limit.
 4. Margin value = Emission level - Limit value
 5. Correction factor = Insertion loss + Cable loss
 6. Emission Level = Correction Factor + Reading Value.

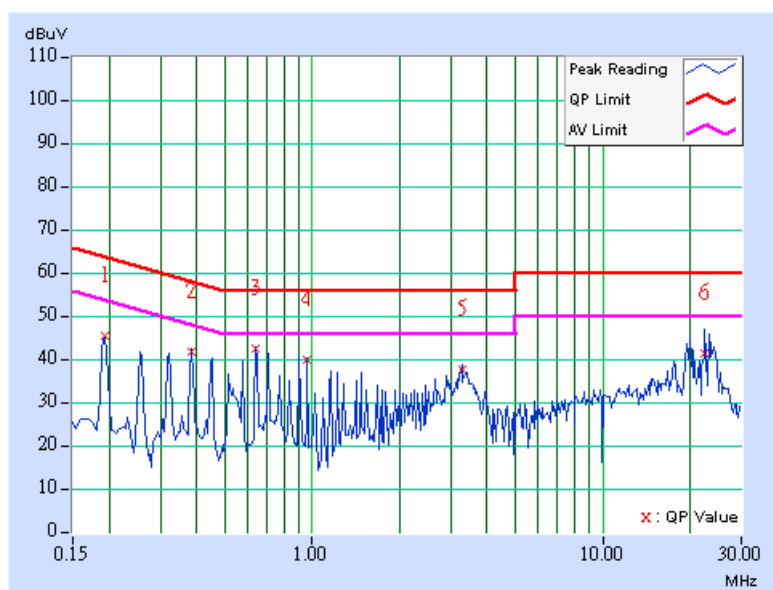

EUT TEST CONDITION		MEASUREMENT DETAIL	
CHANNEL	Channel 6	PHASE	Line 1
MODULATION TYPE	BPSK	6dB BANDWIDTH	9 kHz
TRANSFER RATE	7.2Mbps	INPUT POWER (SYSTEM)	120Vac, 60 Hz
ENVIRONMENTAL CONDITIONS	22deg. C, 62%RH, 991hPa	TESTED BY	Brad Wu

No	FREQ. [MHz]	CORR. Factor (dB)	READING VALUE [dB (uV)]		EMISSION LEVEL [dB (uV)]		LIMIT [dB (uV)]		MARGIN (dB)	
			Q.P.	AV.	Q.P.	AV.	Q.P.	AV.	Q.P.	AV.
1	0.193	0.10	46.35	-	46.45	-	63.91	53.91	-17.46	-
2	0.255	0.10	40.87	-	40.97	-	61.58	51.58	-20.61	-
3	1.027	0.20	35.85	-	36.05	-	56.00	46.00	-19.95	-
4	3.340	0.38	36.57	-	36.95	-	56.00	46.00	-19.05	-
5	8.477	0.46	34.24	-	34.70	-	60.00	50.00	-25.30	-
6	22.402	0.93	39.23	-	40.16	-	60.00	50.00	-19.84	-

- REMARKS:**
1. Q.P. and AV. are abbreviations of quasi-peak and average individually.
 2. "-": The Quasi-peak reading value also meets average limit and measurement with the average detector is unnecessary.
 3. The emission levels of other frequencies were very low against the limit.
 4. Margin value = Emission level - Limit value
 5. Correction factor = Insertion loss + Cable loss
 6. Emission Level = Correction Factor + Reading Value.

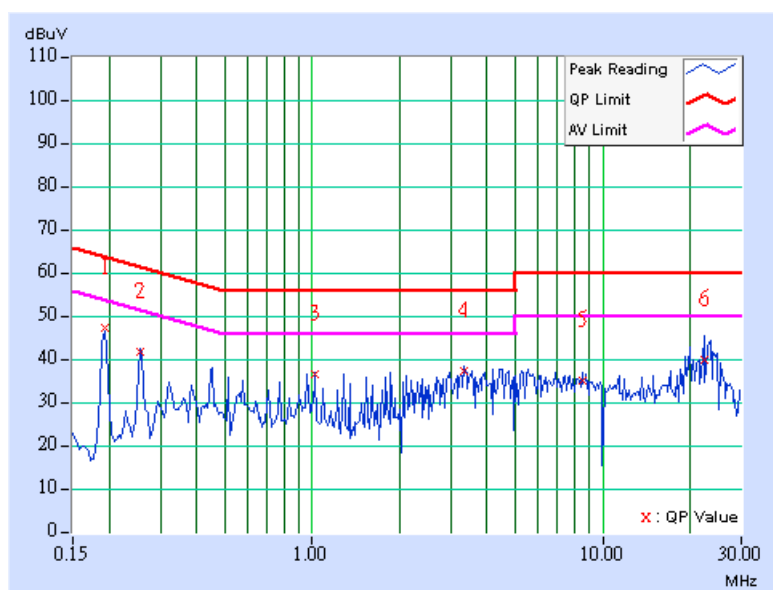

EUT TEST CONDITION		MEASUREMENT DETAIL	
CHANNEL	Channel 6	PHASE	Line 2
MODULATION TYPE	BPSK	6dB BANDWIDTH	9 kHz
TRANSFER RATE	7.2Mbps	INPUT POWER (SYSTEM)	120Vac, 60 Hz
ENVIRONMENTAL CONDITIONS	22deg. C, 62%RH, 991hPa	TESTED BY	Brad Wu

No	FREQ. [MHz]	CORR. Factor (dB)	READING VALUE [dB (uV)]		EMISSION LEVEL [dB (uV)]		LIMIT [dB (uV)]		MARGIN (dB)	
			Q.P.	AV.	Q.P.	AV.	Q.P.	AV.	Q.P.	AV.
1	0.193	0.10	44.83	-	44.93	-	63.91	53.91	-18.98	-
2	0.384	0.10	41.34	-	41.44	-	58.18	48.18	-16.74	-
3	0.642	0.10	41.88	-	41.98	-	56.00	46.00	-14.02	-
4	0.963	0.10	39.63	-	39.73	-	56.00	46.00	-16.27	-
5	3.211	0.30	36.50	-	36.80	-	56.00	46.00	-19.20	-
6	22.980	0.63	40.53	-	41.16	-	60.00	50.00	-18.84	-

- REMARKS:**
1. Q.P. and AV. are abbreviations of quasi-peak and average individually.
 2. "-": The Quasi-peak reading value also meets average limit and measurement with the average detector is unnecessary.
 3. The emission levels of other frequencies were very low against the limit.
 4. Margin value = Emission level - Limit value
 5. Correction factor = Insertion loss + Cable loss
 6. Emission Level = Correction Factor + Reading Value.

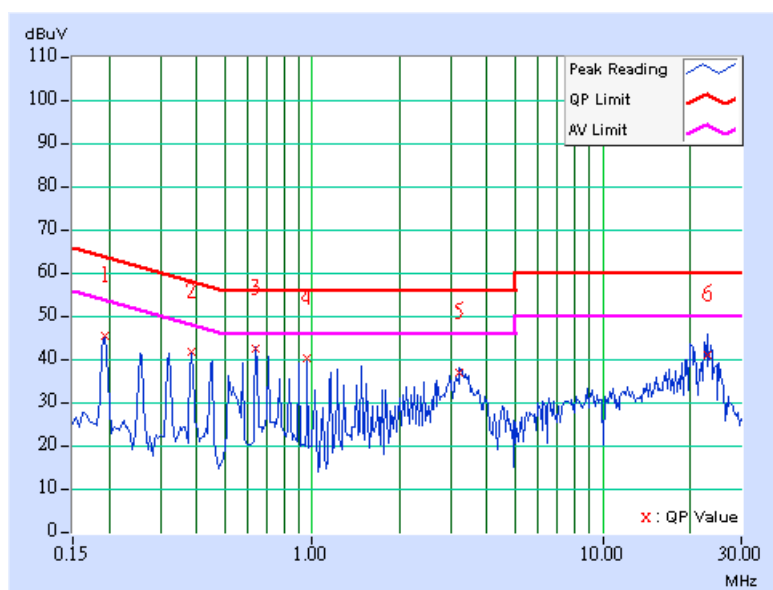

EUT TEST CONDITION		MEASUREMENT DETAIL	
CHANNEL	Channel 11	PHASE	Line 1
MODULATION TYPE	BPSK	6dB BANDWIDTH	9 kHz
TRANSFER RATE	7.2Mbps	INPUT POWER (SYSTEM)	120Vac, 60 Hz
ENVIRONMENTAL CONDITIONS	22deg. C, 62%RH, 991hPa	TESTED BY	Brad Wu

No	FREQ. [MHz]	CORR. Factor (dB)	READING VALUE [dB (uV)]		EMISSION LEVEL [dB (uV)]		LIMIT [dB (uV)]		MARGIN (dB)	
			Q.P.	AV.	Q.P.	AV.	Q.P.	AV.	Q.P.	AV.
1	0.193	0.10	46.33	-	46.43	-	63.91	53.91	-17.48	-
2	0.255	0.10	40.85	-	40.95	-	61.58	51.58	-20.63	-
3	0.451	0.11	35.71	-	35.82	-	56.86	46.86	-21.04	-
4	3.211	0.36	36.44	-	36.80	-	56.00	46.00	-19.20	-
5	15.922	0.67	32.52	-	33.19	-	60.00	50.00	-26.81	-
6	19.523	0.81	35.44	-	36.25	-	60.00	50.00	-23.75	-

- REMARKS:**
1. Q.P. and AV. are abbreviations of quasi-peak and average individually.
 2. "-": The Quasi-peak reading value also meets average limit and measurement with the average detector is unnecessary.
 3. The emission levels of other frequencies were very low against the limit.
 4. Margin value = Emission level - Limit value
 5. Correction factor = Insertion loss + Cable loss
 6. Emission Level = Correction Factor + Reading Value.

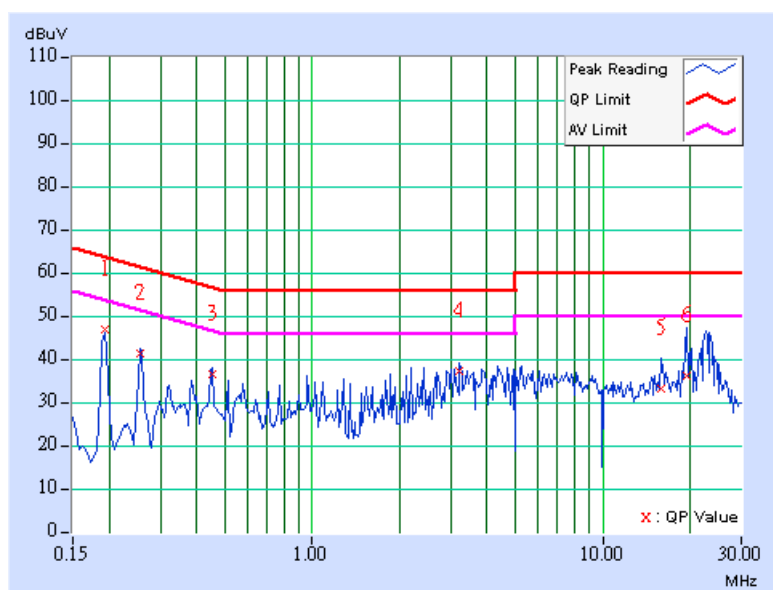

EUT TEST CONDITION		MEASUREMENT DETAIL	
CHANNEL	Channel 11	PHASE	Line 2
MODULATION TYPE	BPSK	6dB BANDWIDTH	9 kHz
TRANSFER RATE	7.2Mbps	INPUT POWER (SYSTEM)	120Vac, 60 Hz
ENVIRONMENTAL CONDITIONS	22deg. C, 62%RH, 991hPa	TESTED BY	Brad Wu

No	FREQ. [MHz]	CORR. Factor [dB]	READING VALUE [dB (uV)]		EMISSION LEVEL [dB (uV)]		LIMIT [dB (uV)]		MARGIN (dB)	
			Q.P.	AV.	Q.P.	AV.	Q.P.	AV.	Q.P.	AV.
1	0.193	0.10	44.81	-	44.91	-	63.91	53.91	-19.00	-
2	0.322	0.10	40.69	-	40.79	-	59.66	49.66	-18.87	-
3	0.642	0.10	41.72	-	41.82	-	56.00	46.00	-14.18	-
4	0.963	0.10	39.55	-	39.65	-	56.00	46.00	-16.35	-
5	2.953	0.28	35.70	-	35.98	-	56.00	46.00	-20.02	-
6	22.984	0.63	41.95	-	42.58	-	60.00	50.00	-17.42	-

- REMARKS:**
1. Q.P. and AV. are abbreviations of quasi-peak and average individually.
 2. "-": The Quasi-peak reading value also meets average limit and measurement with the average detector is unnecessary.
 3. The emission levels of other frequencies were very low against the limit.
 4. Margin value = Emission level - Limit value
 5. Correction factor = Insertion loss + Cable loss
 6. Emission Level = Correction Factor + Reading Value.

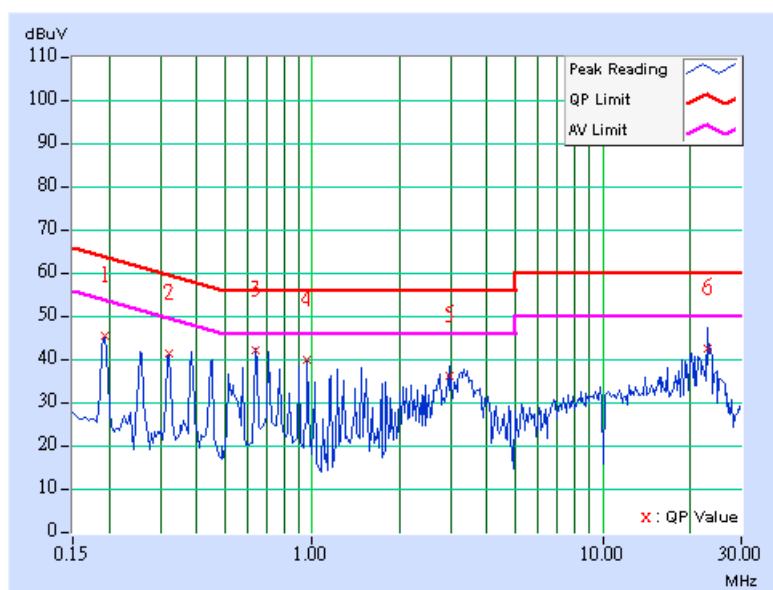

DRAFT 802.11n (40MHz) OFDM MODULATION:

EUT TEST CONDITION		MEASUREMENT DETAIL	
CHANNEL	Channel 1	PHASE	Line 1
MODULATION TYPE	BPSK	6dB BANDWIDTH	9 kHz
TRANSFER RATE	15.0Mbps	INPUT POWER (SYSTEM)	120Vac, 60 Hz
ENVIRONMENTAL CONDITIONS	22deg. C, 62%RH, 991hPa	TESTED BY	Brad Wu

No	FREQ. [MHz]	CORR. Factor (dB)	READING VALUE [dB (uV)]		EMISSION LEVEL [dB (uV)]		LIMIT [dB (uV)]		MARGIN (dB)	
			Q.P.	AV.	Q.P.	AV.	Q.P.	AV.	Q.P.	AV.
			1	0.193	0.10	46.35	-	46.45	-	63.91
2	0.255	0.10	40.75	-	40.85	-	61.58	51.58	-20.73	-
3	0.451	0.11	35.75	-	35.86	-	56.86	46.86	-21.00	-
4	1.863	0.20	36.48	-	36.68	-	56.00	46.00	-19.32	-
5	5.270	0.47	37.08	-	37.55	-	60.00	50.00	-22.45	-
6	23.324	0.96	40.41	-	41.37	-	60.00	50.00	-18.63	-

- REMARKS:**
1. Q.P. and AV. are abbreviations of quasi-peak and average individually.
 2. "-": The Quasi-peak reading value also meets average limit and measurement with the average detector is unnecessary.
 3. The emission levels of other frequencies were very low against the limit.
 4. Margin value = Emission level - Limit value
 5. Correction factor = Insertion loss + Cable loss
 6. Emission Level = Correction Factor + Reading Value.

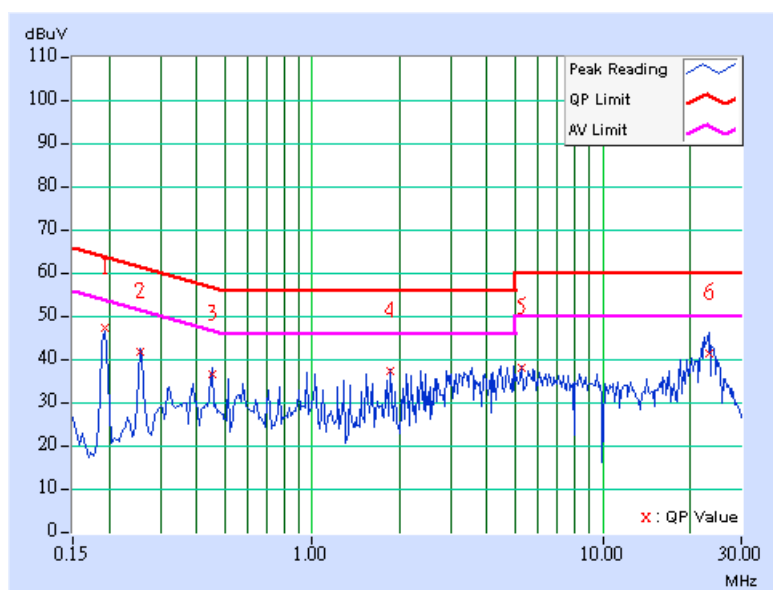

EUT TEST CONDITION		MEASUREMENT DETAIL	
CHANNEL	Channel 1	PHASE	Line 2
MODULATION TYPE	BPSK	6dB BANDWIDTH	9 kHz
TRANSFER RATE	15.0Mbps	INPUT POWER (SYSTEM)	120Vac, 60 Hz
ENVIRONMENTAL CONDITIONS	22deg. C, 62%RH, 991hPa	TESTED BY	Brad Wu

No	FREQ. [MHz]	CORR. Factor (dB)	READING VALUE [dB (uV)]		EMISSION LEVEL [dB (uV)]		LIMIT [dB (uV)]		MARGIN (dB)	
			Q.P.	AV.	Q.P.	AV.	Q.P.	AV.	Q.P.	AV.
1	0.193	0.10	44.85	-	44.95	-	63.91	53.91	-18.96	-
2	0.384	0.10	40.96	-	41.06	-	58.18	48.18	-17.12	-
3	0.642	0.10	42.02	-	42.12	-	56.00	46.00	-13.88	-
4	1.477	0.15	36.41	-	36.56	-	56.00	46.00	-19.44	-
5	3.211	0.30	35.92	-	36.22	-	56.00	46.00	-19.78	-
6	23.199	0.63	41.65	-	42.28	-	60.00	50.00	-17.72	-

- REMARKS:**
1. Q.P. and AV. are abbreviations of quasi-peak and average individually.
 2. "-": The Quasi-peak reading value also meets average limit and measurement with the average detector is unnecessary.
 3. The emission levels of other frequencies were very low against the limit.
 4. Margin value = Emission level - Limit value
 5. Correction factor = Insertion loss + Cable loss
 6. Emission Level = Correction Factor + Reading Value.

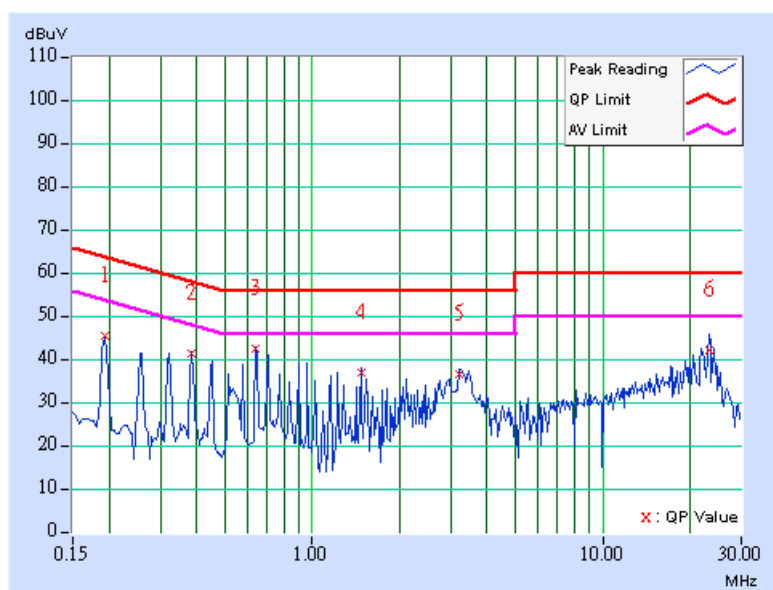

EUT TEST CONDITION		MEASUREMENT DETAIL	
CHANNEL	Channel 4	PHASE	Line 1
MODULATION TYPE	BPSK	6dB BANDWIDTH	9 kHz
TRANSFER RATE	15.0Mbps	INPUT POWER (SYSTEM)	120Vac, 60 Hz
ENVIRONMENTAL CONDITIONS	22deg. C, 62%RH, 991hPa	TESTED BY	Brad Wu

No	FREQ. [MHz]	CORR. Factor (dB)	READING VALUE [dB (uV)]		EMISSION LEVEL [dB (uV)]		LIMIT [dB (uV)]		MARGIN (dB)	
			Q.P.	AV.	Q.P.	AV.	Q.P.	AV.	Q.P.	AV.
1	0.193	0.10	46.37	-	46.47	-	63.91	53.91	-17.44	-
2	0.259	0.10	40.54	-	40.64	-	61.45	51.45	-20.81	-
3	0.451	0.11	35.79	-	35.90	-	56.86	46.86	-20.96	-
4	1.863	0.20	36.58	-	36.78	-	56.00	46.00	-19.22	-
5	3.406	0.39	36.28	-	36.67	-	56.00	46.00	-19.33	-
6	23.074	0.95	40.64	-	41.59	-	60.00	50.00	-18.41	-

- REMARKS:**
1. Q.P. and AV. are abbreviations of quasi-peak and average individually.
 2. "-": The Quasi-peak reading value also meets average limit and measurement with the average detector is unnecessary.
 3. The emission levels of other frequencies were very low against the limit.
 4. Margin value = Emission level - Limit value
 5. Correction factor = Insertion loss + Cable loss
 6. Emission Level = Correction Factor + Reading Value.

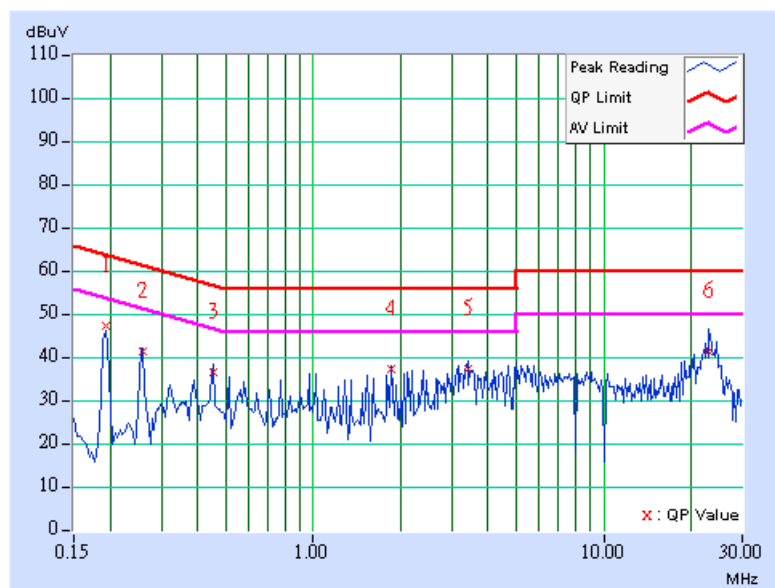

EUT TEST CONDITION		MEASUREMENT DETAIL	
CHANNEL	Channel 4	PHASE	Line 2
MODULATION TYPE	BPSK	6dB BANDWIDTH	9 kHz
TRANSFER RATE	15.0Mbps	INPUT POWER (SYSTEM)	120Vac, 60 Hz
ENVIRONMENTAL CONDITIONS	22deg. C, 62%RH, 991hPa	TESTED BY	Brad Wu

No	FREQ. [MHz]	CORR. Factor (dB)	READING VALUE [dB (uV)]		EMISSION LEVEL [dB (uV)]		LIMIT [dB (uV)]		MARGIN (dB)	
			Q.P.	AV.	Q.P.	AV.	Q.P.	AV.	Q.P.	AV.
1	0.193	0.10	45.09	-	45.19	-	63.91	53.91	-18.72	-
2	0.384	0.10	41.42	-	41.52	-	58.18	48.18	-16.66	-
3	0.642	0.10	41.84	-	41.94	-	56.00	46.00	-14.06	-
4	3.277	0.31	37.12	-	37.43	-	56.00	46.00	-18.57	-
5	19.727	0.62	37.49	-	38.11	-	60.00	50.00	-21.89	-
6	23.191	0.63	39.76	-	40.39	-	60.00	50.00	-19.61	-

- REMARKS:**
1. Q.P. and AV. are abbreviations of quasi-peak and average individually.
 2. "-": The Quasi-peak reading value also meets average limit and measurement with the average detector is unnecessary.
 3. The emission levels of other frequencies were very low against the limit.
 4. Margin value = Emission level - Limit value
 5. Correction factor = Insertion loss + Cable loss
 6. Emission Level = Correction Factor + Reading Value.

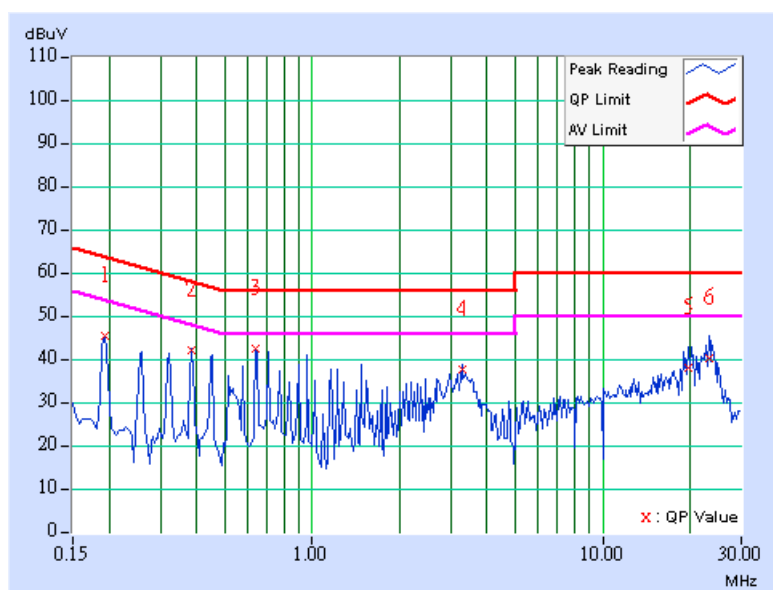

EUT TEST CONDITION		MEASUREMENT DETAIL	
CHANNEL	Channel 7	PHASE	Line 1
MODULATION TYPE	BPSK	6dB BANDWIDTH	9 kHz
TRANSFER RATE	15.0Mbps	INPUT POWER (SYSTEM)	120Vac, 60 Hz
ENVIRONMENTAL CONDITIONS	22deg. C, 62%RH, 991hPa	TESTED BY	Brad Wu

No	FREQ. [MHz]	CORR. Factor [dB]	READING VALUE [dB (uV)]		EMISSION LEVEL [dB (uV)]		LIMIT [dB (uV)]		MARGIN (dB)	
			Q.P.	AV.	Q.P.	AV.	Q.P.	AV.	Q.P.	AV.
1	0.193	0.10	46.79	-	46.89	-	63.91	53.91	-17.02	-
2	0.259	0.10	40.63	-	40.73	-	61.45	51.45	-20.72	-
3	0.451	0.11	35.31	-	35.42	-	56.86	46.86	-21.44	-
4	2.121	0.22	35.61	-	35.83	-	56.00	46.00	-20.17	-
5	2.891	0.32	34.50	-	34.82	-	56.00	46.00	-21.18	-
6	23.250	0.96	40.19	-	41.15	-	60.00	50.00	-18.85	-

- REMARKS:**
1. Q.P. and AV. are abbreviations of quasi-peak and average individually.
 2. "-": The Quasi-peak reading value also meets average limit and measurement with the average detector is unnecessary.
 3. The emission levels of other frequencies were very low against the limit.
 4. Margin value = Emission level - Limit value
 5. Correction factor = Insertion loss + Cable loss
 6. Emission Level = Correction Factor + Reading Value.

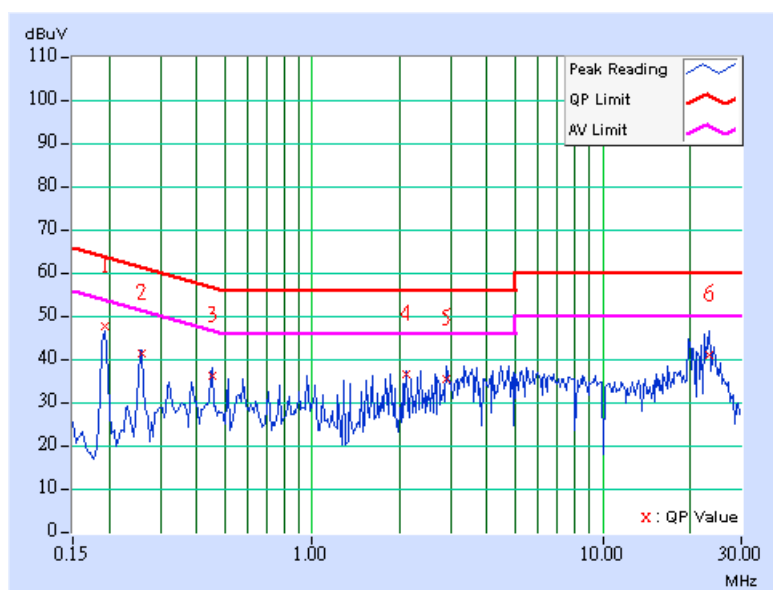

EUT TEST CONDITION		MEASUREMENT DETAIL	
CHANNEL	Channel 7	PHASE	Line 2
MODULATION TYPE	BPSK	6dB BANDWIDTH	9 kHz
TRANSFER RATE	15.0Mbps	INPUT POWER (SYSTEM)	120Vac, 60 Hz
ENVIRONMENTAL CONDITIONS	22deg. C, 62%RH, 991hPa	TESTED BY	Brad Wu

No	FREQ. [MHz]	CORR. Factor (dB)	READING VALUE [dB (uV)]		EMISSION LEVEL [dB (uV)]		LIMIT [dB (uV)]		MARGIN (dB)	
			Q.P.	AV.	Q.P.	AV.	Q.P.	AV.	Q.P.	AV.
1	0.193	0.10	44.89	-	44.99	-	63.91	53.91	-18.92	-
2	0.384	0.10	40.94	-	41.04	-	58.18	48.18	-17.14	-
3	0.642	0.10	41.72	-	41.82	-	56.00	46.00	-14.18	-
4	1.477	0.15	36.57	-	36.72	-	56.00	46.00	-19.28	-
5	3.313	0.31	33.90	-	34.21	-	56.00	46.00	-21.79	-
6	22.480	0.63	40.24	-	40.87	-	60.00	50.00	-19.13	-

- REMARKS:**
1. Q.P. and AV. are abbreviations of quasi-peak and average individually.
 2. "-": The Quasi-peak reading value also meets average limit and measurement with the average detector is unnecessary.
 3. The emission levels of other frequencies were very low against the limit.
 4. Margin value = Emission level - Limit value
 5. Correction factor = Insertion loss + Cable loss
 6. Emission Level = Correction Factor + Reading Value.

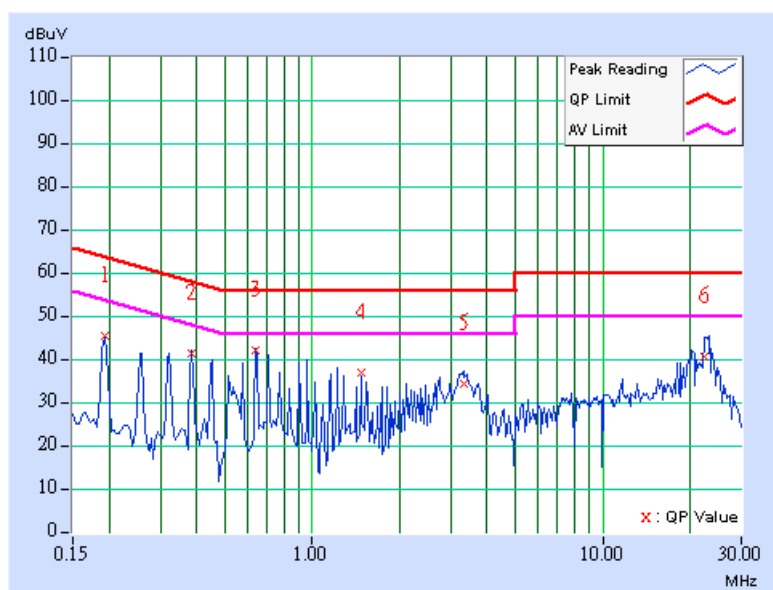

4.2 RADIATED EMISSION MEASUREMENT

4.2.1 LIMITS OF RADIATED EMISSION MEASUREMENT

Emissions radiated outside of the specified bands, shall be according to the general radiated limits in 15.209 as following:

FREQUENCIES (MHz)	FIELD STRENGTH (microvolts/meter)	MEASUREMENT DISTANCE (meters)
0.009 ~ 0.490	2400 / F(kHz)	300
0.490 ~ 1.705	24000 / F(kHz)	30
1.705 ~ 30.0	30	30
30 ~ 88	100	3
88 ~ 216	150	3
216 ~ 960	200	3
Above 960	500	3

NOTE:

1. The lower limit shall apply at the transition frequencies.
2. Emission level (dBuV/m) = 20 log Emission level (uV/m).
3. As shown in 15.35(b), for frequencies above 1000MHz, the field strength limits are based on average detector, however, the peak field strength of any emission shall not exceed the maximum permitted average limits, specified above by more than 20dB under any condition of modulation.

4.2.2 TEST INSTRUMENTS

DESCRIPTION & MANUFACTURER	MODEL NO.	SERIAL NO.	CALIBRATED UNTIL
Test Receiver ROHDE & SCHWARZ	ESI7	838496/016	Jan. 01, 2007
Spectrum Analyzer ROHDE & SCHWARZ	FSP40	100041	Dec. 04, 2006
BILOG Antenna SCHWARZBECK	VULB9168	9168-155	Jan. 15, 2007
HORN Antenna SCHWARZBECK	BBHA 9120D	9120D-404	Jan. 01, 2007
HORN Antenna SCHWARZBECK	BBHA 9170	BBHA9170242	Jan. 19, 2007
Preamplifier Agilent	8449B	3008A01960	Nov. 09, 2006
RF signal cable HUBER+SUHNNER	SUCOFLEX 104	219268/4	Dec. 20, 2006
RF signal cable HUBER+SUHNNER	SUCOFLEX 104	230129/4	Dec. 20, 2006
Software ADT.	ADT_Radiated_V5.14	NA	NA
Antenna Tower inn-co GmbH	MA 4000	010303	NA
Antenna Tower Controller inn-co GmbH	CO2000	019303	NA
Turn Table ADT.	TT100.	TT93021704	NA
Turn Table Controller ADT.	SC100.	SC93021704	NA

- NOTE:**
1. The calibration interval of the above test instruments is 12 months and the calibrations are traceable to NML/ROC and NIST/USA.
 2. The test was performed in HwaYa Chamber 3.
 3. The horn antenna and HP preamplifier (model: 8449B) are used only for the measurement of emission frequency above 1GHz if tested.
 4. The IC Site Registration No. is IC4924-4.

4.2.3 TEST PROCEDURES

- a. The EUT was placed on the top of a rotating table 0.8 meters above the ground at a 3 meters semi-anechoic chamber. The table was rotated 360 degrees to determine the position of the highest radiation.
- b. The EUT was set 3 meters away from the interference-receiving antenna, which was mounted on the top of a variable-height antenna tower.
- c. The antenna is a broadband antenna, and its height is varied from one meter to four meters above the ground to determine the maximum value of the field strength. Both horizontal and vertical polarizations of the antenna are set to make the measurement.
- d. For each suspected emission, the EUT was arranged to its worst case and then the antenna was tuned to heights from 1 meter to 4 meters and the rotatable table was turned from 0 degrees to 360 degrees to find the maximum reading.
- e. The test-receiver system was set to Peak Detect Function and Specified Bandwidth with Maximum Hold Mode.
- f. If the emission level of the EUT in peak mode was lower than the limit specified, then testing could be stopped and the peak values of the EUT would be reported. Otherwise the emissions would be re-tested one by one using peak, quasi-peak or average method as specified and then reported in a data sheet.

NOTE:

1. The resolution bandwidth and video bandwidth of test receiver/spectrum analyzer is 120kHz for Peak detection (PK) and Quasi-peak detection (QP) at frequency below 1GHz.
2. The resolution bandwidth and video bandwidth of test receiver/spectrum analyzer is 1 MHz for Peak detection at frequency above 1GHz.
3. The resolution bandwidth of test receiver/spectrum analyzer is 1MHz and the video bandwidth is 100Hz for Average detection (AV) at frequency above 1GHz.

4.2.4 DEVIATION FROM TEST STANDARD

No deviation

4.2.5 TEST SETUP

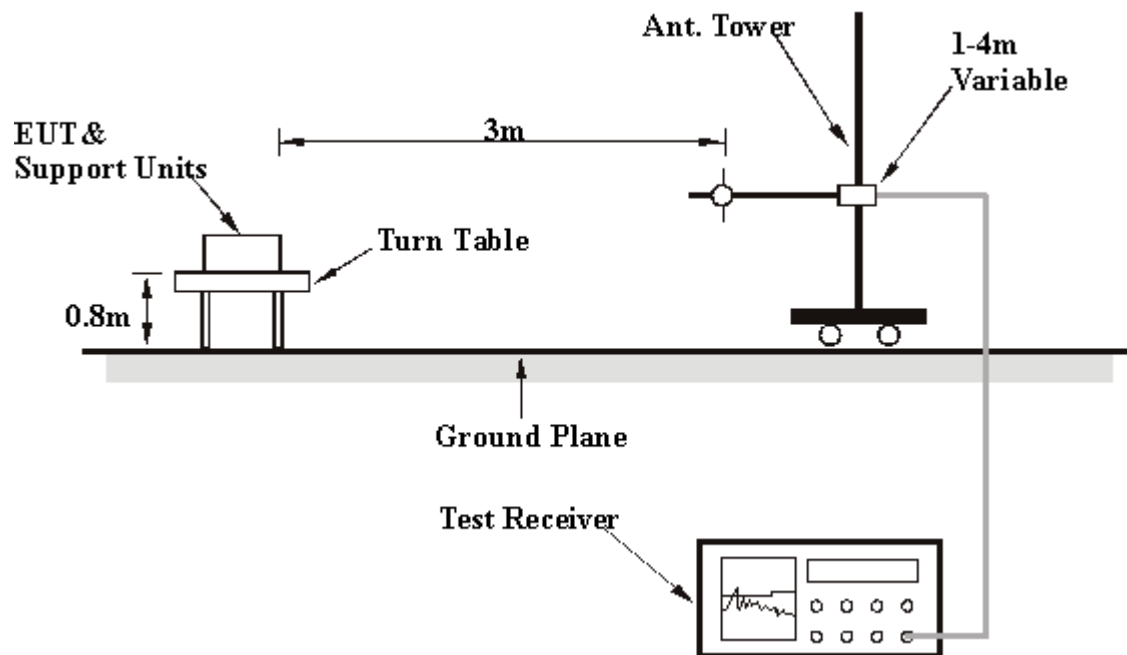

For the actual test configuration, please refer to the related item – Photographs of the Test Configuration.

4.2.6 EUT OPERATING CONDITIONS

Same as 4.1.6

4.2.7 TEST RESULTS

BELOW 1GHz WORST-CASE DATA:

EUT TEST CONDITION		MEASUREMENT DETAIL	
CHANNEL	Channel 1	FREQUENCY RANGE	Below 1000MHz
MODULATION TYPE	BPSK for 802.11g	INPUT POWER (SYSTEM)	120Vac, 60 Hz
TRANSFER RATE	6.0Mbps	DETECTOR FUNCTION	Quasi-Peak
ENVIRONMENTAL CONDITIONS	22deg. C, 63%RH, 991hPa	TESTED BY	Brad Wu

ANTENNA POLARITY & TEST DISTANCE: HORIZONTAL AT 3 M								
NO.	FREQ. (MHz)	EMISSION LEVEL (dBuV/m)	LIMIT (dBuV/m)	MARGIN (dB)	ANTENNA HEIGHT (m)	TABLE ANGLE (Degree)	RAW VALUE (dBuV)	CORRECTION FACTOR (dB/m)
1	168.02	38.35 QP	43.50	-5.15	1.50 H	43	25.65	12.70
2	298.26	36.12 QP	46.00	-9.88	1.00 H	223	20.76	15.35
3	399.34	31.88 QP	46.00	-14.12	1.00 H	241	14.10	17.78
4	440.16	31.51 QP	46.00	-14.49	1.00 H	208	12.99	18.52
5	539.30	29.39 QP	46.00	-16.61	1.75 H	265	8.61	20.78
6	838.66	31.02 QP	46.00	-14.98	1.00 H	319	4.42	26.60

ANTENNA POLARITY & TEST DISTANCE: VERTICAL AT 3 M								
NO.	FREQ. (MHz)	EMISSION LEVEL (dBuV/m)	LIMIT (dBuV/m)	MARGIN (dB)	ANTENNA HEIGHT (m)	TABLE ANGLE (Degree)	RAW VALUE (dBuV)	CORRECTION FACTOR (dB/m)
1	43.61	29.58 QP	40.00	-10.42	1.25 V	121	14.57	15.01
2	300.20	36.28 QP	46.00	-9.72	1.50 V	184	20.85	15.43
3	399.34	33.03 QP	46.00	-12.97	1.00 V	163	15.26	17.78
4	488.76	35.15 QP	46.00	-10.85	1.00 V	226	15.49	19.66
5	582.06	33.72 QP	46.00	-12.28	1.00 V	34	11.72	21.99
6	673.43	32.10 QP	46.00	-13.90	1.00 V	355	8.51	23.60

- REMARKS:**
1. Emission level (dBuV/m) = Raw Value (dBuV) + Correction Factor (dB/m).
 2. Correction Factor (dB/m) = Antenna Factor (dB/m) + Cable Factor (dB).
 3. The other emission levels were very low against the limit.
 4. Margin value = Emission level – Limit value.

EUT TEST CONDITION		MEASUREMENT DETAIL	
CHANNEL	Channel 1	FREQUENCY RANGE	Below 1000MHz
MODULATION TYPE	BPSK for draft 802.11n (20MHz)	INPUT POWER (SYSTEM)	120Vac, 60 Hz
TRANSFER RATE	7.2Mbps	DETECTOR FUNCTION	Quasi-Peak
ENVIRONMENTAL CONDITIONS	22deg. C, 63%RH, 991hPa	TESTED BY	Brad Wu

ANTENNA POLARITY & TEST DISTANCE: HORIZONTAL AT 3 M								
NO.	FREQ. (MHz)	EMISSION LEVEL (dBuV/m)	LIMIT (dBuV/m)	MARGIN (dB)	ANTENNA HEIGHT (m)	TABLE ANGLE (Degree)	RAW VALUE (dBuV)	CORRECTION FACTOR (dB/m)
1	168.02	33.82 QP	43.50	-9.68	1.00 H	220	21.12	12.70
2	302.14	38.62 QP	46.00	-7.38	1.00 H	199	23.16	15.46
3	399.34	32.34 QP	46.00	-13.66	1.00 H	148	14.57	17.78
4	488.76	28.55 QP	46.00	-17.45	1.00 H	199	8.89	19.66
5	671.48	29.98 QP	46.00	-16.02	1.00 H	163	6.42	23.56
6	879.48	28.30 QP	46.00	-17.70	1.00 H	220	1.14	27.16

ANTENNA POLARITY & TEST DISTANCE: VERTICAL AT 3 M								
NO.	FREQ. (MHz)	EMISSION LEVEL (dBuV/m)	LIMIT (dBuV/m)	MARGIN (dB)	ANTENNA HEIGHT (m)	TABLE ANGLE (Degree)	RAW VALUE (dBuV)	CORRECTION FACTOR (dB/m)
1	43.61	27.45 QP	40.00	-12.55	1.50 V	283	12.44	15.01
2	267.15	29.96 QP	46.00	-16.04	1.00 V	325	16.32	13.63
3	300.20	41.77 QP	46.00	-4.23	1.00 V	64	26.34	15.43
4	399.34	33.71 QP	46.00	-12.29	1.00 V	121	15.94	17.78
5	488.76	33.65 QP	46.00	-12.35	1.50 V	202	13.99	19.66
6	603.45	31.75 QP	46.00	-14.25	1.00 V	346	9.17	22.59

- REMARKS:**
1. Emission level (dBuV/m) = Raw Value (dBuV) + Correction Factor (dB/m).
 2. Correction Factor (dB/m) = Antenna Factor (dB/m) + Cable Factor (dB).
 3. The other emission levels were very low against the limit.
 4. Margin value = Emission level – Limit value.

EUT TEST CONDITION		MEASUREMENT DETAIL	
CHANNEL	Channel 1	FREQUENCY RANGE	Below 1000MHz
MODULATION TYPE	BPSK for draft 802.11n (40MHz)	INPUT POWER (SYSTEM)	120Vac, 60 Hz
TRANSFER RATE	15.0Mbps	DETECTOR FUNCTION	Quasi-Peak
ENVIRONMENTAL CONDITIONS	22deg. C, 63%RH, 991hPa	TESTED BY	Brad Wu

ANTENNA POLARITY & TEST DISTANCE: HORIZONTAL AT 3 M								
NO.	FREQ. (MHz)	EMISSION LEVEL (dBuV/m)	LIMIT (dBuV/m)	MARGIN (dB)	ANTENNA HEIGHT (m)	TABLE ANGLE (Degree)	RAW VALUE (dBuV)	CORRECTION FACTOR (dB/m)
1	70.82	25.65 QP	40.00	-14.35	1.25 H	328	14.11	11.54
2	168.02	34.30 QP	43.50	-9.20	1.00 H	64	21.60	12.70
3	302.14	38.35 QP	46.00	-7.65	1.00 H	205	22.89	15.46
4	399.34	33.28 QP	46.00	-12.72	1.00 H	169	15.51	17.78
5	488.76	28.50 QP	46.00	-17.50	1.00 H	214	8.84	19.66
6	737.58	28.27 QP	46.00	-17.73	1.50 H	223	2.89	25.38

ANTENNA POLARITY & TEST DISTANCE: VERTICAL AT 3 M								
NO.	FREQ. (MHz)	EMISSION LEVEL (dBuV/m)	LIMIT (dBuV/m)	MARGIN (dB)	ANTENNA HEIGHT (m)	TABLE ANGLE (Degree)	RAW VALUE (dBuV)	CORRECTION FACTOR (dB/m)
1	72.77	33.52 QP	40.00	-6.48	1.50 V	94	22.20	11.32
2	267.15	30.04 QP	46.00	-15.96	1.00 V	337	16.41	13.63
3	300.20	41.07 QP	46.00	-4.93	1.00 V	220	25.63	15.43
4	399.34	32.86 QP	46.00	-13.14	1.00 V	130	15.08	17.78
5	488.76	33.69 QP	46.00	-12.31	1.25 V	199	14.03	19.66
6	673.43	31.72 QP	46.00	-14.28	1.00 V	10	8.12	23.60

- REMARKS:**
1. Emission level (dBuV/m) = Raw Value (dBuV) + Correction Factor (dB/m).
 2. Correction Factor (dB/m) = Antenna Factor (dB/m) + Cable Factor (dB).
 3. The other emission levels were very low against the limit.
 4. Margin value = Emission level – Limit value.

802.11b DSSS MODULATION:

EUT TEST CONDITION		MEASUREMENT DETAIL	
CHANNEL	Channel 1	FREQUENCY RANGE	1 ~ 25GHz
MODULATION TYPE	DBPSK	INPUT POWER (SYSTEM)	120Vac, 60 Hz
TRANSFER RATE	1.0Mbps	DETECTOR FUNCTION	Peak(PK) Average (AV)
ENVIRONMENTAL CONDITIONS	22deg. C, 63%RH, 991hPa	TESTED BY	Brad Wu

ANTENNA POLARITY & TEST DISTANCE: HORIZONTAL AT 3 M								
NO.	FREQ. (MHz)	EMISSION LEVEL (dBuV/m)	LIMIT (dBuV/m)	MARGIN (dB)	ANTENNA HEIGHT (m)	TABLE ANGLE (Degree)	RAW VALUE (dBuV)	CORRECTION FACTOR (dB/m)
1	2390.00	48.88 PK	74.00	-25.12	1.34 H	140	16.77	32.11
1	2390.00	44.36 AV	54.00	-9.64	1.34 H	140	12.25	32.11
2	*2412.00	108.06 PK			1.34 H	140	75.87	32.19
2	*2412.00	103.54 AV			1.34 H	140	71.35	32.19
3	4824.00	51.43 PK	74.00	-22.57	1.09 H	206	12.78	38.65
3	4824.00	47.18 AV	54.00	-6.82	1.09 H	206	8.53	38.65
4	7236.00	61.14 PK	88.06	-26.92	1.45 H	344	15.93	45.21
4	7236.00	55.82 AV	83.54	-27.72	1.45 H	344	10.61	45.21

ANTENNA POLARITY & TEST DISTANCE: VERTICAL AT 3 M								
NO.	FREQ. (MHz)	EMISSION LEVEL (dBuV/m)	LIMIT (dBuV/m)	MARGIN (dB)	ANTENNA HEIGHT (m)	TABLE ANGLE (Degree)	RAW VALUE (dBuV)	CORRECTION FACTOR (dB/m)
1	2390.00	57.36 PK	74.00	-16.64	1.15 V	165	25.25	32.11
1	2390.00	52.58 AV	54.00	-1.42	1.15 V	165	20.47	32.11
2	*2412.00	116.54 PK			1.15 V	165	84.35	32.19
2	*2412.00	111.76 AV			1.15 V	165	79.57	32.19
3	4824.00	56.76 PK	74.00	-17.24	1.07 V	210	18.11	38.65
3	4824.00	52.45 AV	54.00	-1.55	1.07 V	210	13.80	38.65
4	7236.00	63.09 PK	96.54	-33.45	1.12 V	203	17.88	45.21
4	7236.00	57.71 AV	91.76	-34.05	1.12 V	203	12.50	45.21

- REMARKS:**
1. Emission level (dBuV/m) = Raw Value (dBuV) + Correction Factor (dB/m).
 2. Correction Factor (dB/m) = Antenna Factor (dB/m) + Cable Factor (dB).
 3. The other emission levels were very low against the limit.
 4. Margin value = Emission level – Limit value.
 5. The limit value is defined as per 15.247.
 6. “ * “: Fundamental frequency.



EUT TEST CONDITION		MEASUREMENT DETAIL	
CHANNEL	Channel 6	FREQUENCY RANGE	1 ~ 25GHz
MODULATION TYPE	DBPSK	INPUT POWER (SYSTEM)	120Vac, 60 Hz
TRANSFER RATE	1.0Mbps	DETECTOR FUNCTION	Peak(PK) Average (AV)
ENVIRONMENTAL CONDITIONS	22deg. C, 63%RH, 991hPa	TESTED BY	Brad Wu

ANTENNA POLARITY & TEST DISTANCE: HORIZONTAL AT 3 M								
NO.	FREQ. (MHz)	EMISSION LEVEL (dBuV/m)	LIMIT (dBuV/m)	MARGIN (dB)	ANTENNA HEIGHT (m)	TABLE ANGLE (Degree)	RAW VALUE (dBuV)	CORRECTION FACTOR (dB/m)
1	*2437.00	105.31 PK			1.35 H	141	73.02	32.29
1	*2437.00	100.83 AV			1.35 H	141	68.54	32.29
2	4874.00	48.45 PK	74.00	-25.55	1.10 H	234	9.66	38.79
2	4874.00	42.03 AV	54.00	-11.97	1.10 H	234	3.24	38.79
3	7311.00	61.39 PK	74.00	-12.61	1.50 H	343	15.98	45.41
3	7311.00	51.53 AV	54.00	-2.47	1.50 H	343	6.12	45.41

ANTENNA POLARITY & TEST DISTANCE: VERTICAL AT 3 M								
NO.	FREQ. (MHz)	EMISSION LEVEL (dBuV/m)	LIMIT (dBuV/m)	MARGIN (dB)	ANTENNA HEIGHT (m)	TABLE ANGLE (Degree)	RAW VALUE (dBuV)	CORRECTION FACTOR (dB/m)
1	*2437.00	113.74 PK			1.11 V	166	81.45	32.29
1	*2437.00	109.18 AV			1.11 V	166	76.89	32.29
2	4874.00	51.61 PK	74.00	-22.39	1.08 V	161	12.82	38.79
2	4874.00	45.21 AV	54.00	-8.79	1.08 V	161	6.42	38.79
3	7311.00	62.03 PK	74.00	-11.97	1.32 V	46	16.62	45.41
3	7311.00	52.85 AV	54.00	-1.15	1.32 V	46	7.44	45.41

- REMARKS:**
1. Emission level (dBuV/m) = Raw Value (dBuV) + Correction Factor (dB/m).
 2. Correction Factor (dB/m) = Antenna Factor (dB/m) + Cable Factor (dB).
 3. The other emission levels were very low against the limit.
 4. Margin value = Emission level – Limit value.
 5. The limit value is defined as per 15.247.
 6. “ * “: Fundamental frequency.



EUT TEST CONDITION		MEASUREMENT DETAIL	
CHANNEL	Channel 11	FREQUENCY RANGE	1 ~ 25GHz
MODULATION TYPE	DBPSK	INPUT POWER (SYSTEM)	120Vac, 60 Hz
TRANSFER RATE	1.0Mbps	DETECTOR FUNCTION	Peak(PK) Average (AV)
ENVIRONMENTAL CONDITIONS	22deg. C, 63%RH, 991hPa	TESTED BY	Brad Wu

ANTENNA POLARITY & TEST DISTANCE: HORIZONTAL AT 3 M								
NO.	FREQ. (MHz)	EMISSION LEVEL (dBuV/m)	LIMIT (dBuV/m)	MARGIN (dB)	ANTENNA HEIGHT (m)	TABLE ANGLE (Degree)	RAW VALUE (dBuV)	CORRECTION FACTOR (dB/m)
1	*2462.00	105.75 PK			1.32 H	145	73.37	32.38
1	*2462.00	101.25 AV			1.32 H	145	68.87	32.38
2	2483.50	45.85 PK	74.00	-28.15	1.32 H	145	13.39	32.46
2	2483.50	41.35 AV	54.00	-12.65	1.32 H	145	8.89	32.46
3	4924.00	47.82 PK	74.00	-26.18	1.05 H	224	8.90	38.92
3	4924.00	41.36 AV	54.00	-12.64	1.05 H	224	2.44	38.92
4	7386.00	60.97 PK	74.00	-13.03	1.42 H	309	15.37	45.59
4	7386.00	51.18 AV	54.00	-2.82	1.42 H	309	5.59	45.59

ANTENNA POLARITY & TEST DISTANCE: VERTICAL AT 3 M								
NO.	FREQ. (MHz)	EMISSION LEVEL (dBuV/m)	LIMIT (dBuV/m)	MARGIN (dB)	ANTENNA HEIGHT (m)	TABLE ANGLE (Degree)	RAW VALUE (dBuV)	CORRECTION FACTOR (dB/m)
1	*2462.00	114.15 PK			1.10 V	168	81.77	32.38
1	*2462.00	109.57 AV			1.10 V	168	77.19	32.38
2	2483.50	54.25 PK	74.00	-19.75	1.10 V	168	21.79	32.46
2	2483.50	49.67 AV	54.00	-4.33	1.10 V	168	17.21	32.46
3	4924.00	51.89 PK	74.00	-22.11	1.10 V	152	12.97	38.92
3	4924.00	45.46 AV	54.00	-8.54	1.10 V	152	6.54	38.92
4	7386.00	60.92 PK	74.00	-13.08	1.27 V	58	15.33	45.59
4	7386.00	52.09 AV	54.00	-1.91	1.27 V	58	6.50	45.59

- REMARKS:**
1. Emission level (dBuV/m) = Raw Value (dBuV) + Correction Factor (dB/m).
 2. Correction Factor (dB/m) = Antenna Factor (dB/m) + Cable Factor (dB).
 3. The other emission levels were very low against the limit.
 4. Margin value = Emission level – Limit value.
 5. The limit value is defined as per 15.247.
 6. “ * “: Fundamental frequency.

802.11g OFDM MODULATION:

EUT TEST CONDITION		MEASUREMENT DETAIL	
CHANNEL	Channel 1	FREQUENCY RANGE	1 ~ 25GHz
MODULATION TYPE	BPSK	INPUT POWER (SYSTEM)	120Vac, 60 Hz
TRANSFER RATE	6.0Mbps	DETECTOR FUNCTION	Peak(PK) Average (AV)
ENVIRONMENTAL CONDITIONS	22deg. C, 63%RH, 991hPa	TESTED BY	Brad Wu

ANTENNA POLARITY & TEST DISTANCE: HORIZONTAL AT 3 M								
NO.	FREQ. (MHz)	EMISSION LEVEL (dBuV/m)	LIMIT (dBuV/m)	MARGIN (dB)	ANTENNA HEIGHT (m)	TABLE ANGLE (Degree)	RAW VALUE (dBuV)	CORRECTION FACTOR (dB/m)
1	2390.00	60.84 PK	74.00	-13.16	1.28 H	143	28.73	32.11
1	2390.00	41.61 AV	54.00	-12.39	1.28 H	143	9.50	32.11
2	*2412.00	104.36 PK			1.28 H	143	72.17	32.19
2	*2412.00	94.16 AV			1.28 H	143	61.97	32.19
3	4824.00	47.65 PK	74.00	-26.35	1.10 H	135	9.00	38.65
3	4824.00	35.31 AV	54.00	-18.69	1.10 H	135	-3.34	38.65
4	7236.00	63.31 PK	84.36	-21.05	1.52 H	87	18.10	45.21
4	7236.00	46.87 AV	74.16	-27.29	1.52 H	87	1.66	45.21

ANTENNA POLARITY & TEST DISTANCE: VERTICAL AT 3 M								
NO.	FREQ. (MHz)	EMISSION LEVEL (dBuV/m)	LIMIT (dBuV/m)	MARGIN (dB)	ANTENNA HEIGHT (m)	TABLE ANGLE (Degree)	RAW VALUE (dBuV)	CORRECTION FACTOR (dB/m)
1	2390.00	71.08 PK	74.00	-2.92	1.12 V	168	38.97	32.11
1	2390.00	52.63 AV	54.00	-1.37	1.12 V	168	20.52	32.11
2	*2412.00	114.60 PK			1.12 V	168	82.41	32.19
2	*2412.00	105.18 AV			1.12 V	168	72.99	32.19
3	4824.00	49.78 PK	74.00	-24.22	1.12 V	121	11.13	38.65
3	4824.00	37.46 AV	54.00	-16.54	1.12 V	121	-1.19	38.65
4	7236.00	67.92 PK	94.60	-26.68	1.11 V	16	22.71	45.21
4	7236.00	51.53 AV	85.18	-33.65	1.11 V	16	6.32	45.21

- REMARKS:**
1. Emission level (dBuV/m) = Raw Value (dBuV) + Correction Factor (dB/m).
 2. Correction Factor (dB/m) = Antenna Factor (dB/m) + Cable Factor (dB).
 3. The other emission levels were very low against the limit.
 4. Margin value = Emission level – Limit value.
 5. The limit value is defined as per 15.247.
 6. “ * “: Fundamental frequency.

EUT TEST CONDITION		MEASUREMENT DETAIL	
CHANNEL	Channel 6	FREQUENCY RANGE	1 ~ 25GHz
MODULATION TYPE	BPSK	INPUT POWER (SYSTEM)	120Vac, 60 Hz
TRANSFER RATE	6.0Mbps	DETECTOR FUNCTION	Peak(PK) Average (AV)
ENVIRONMENTAL CONDITIONS	22deg. C, 63%RH, 991hPa	TESTED BY	Brad Wu

ANTENNA POLARITY & TEST DISTANCE: HORIZONTAL AT 3 M								
NO.	FREQ. (MHz)	EMISSION LEVEL (dBuV/m)	LIMIT (dBuV/m)	MARGIN (dB)	ANTENNA HEIGHT (m)	TABLE ANGLE (Degree)	RAW VALUE (dBuV)	CORRECTION FACTOR (dB/m)
1	*2437.00	105.58 PK			1.25 H	141	73.29	32.29
1	*2437.00	95.31 AV			1.25 H	141	63.02	32.29
2	4874.00	47.93 PK	74.00	-26.07	1.06 H	128	9.14	38.79
2	4874.00	35.58 AV	54.00	-18.42	1.06 H	128	-3.21	38.79
3	7311.00	63.14 PK	74.00	-10.86	1.50 H	69	17.73	45.41
3	7311.00	46.51 AV	54.00	-7.49	1.50 H	69	1.10	45.41

ANTENNA POLARITY & TEST DISTANCE: VERTICAL AT 3 M								
NO.	FREQ. (MHz)	EMISSION LEVEL (dBuV/m)	LIMIT (dBuV/m)	MARGIN (dB)	ANTENNA HEIGHT (m)	TABLE ANGLE (Degree)	RAW VALUE (dBuV)	CORRECTION FACTOR (dB/m)
1	*2437.00	115.79 PK			1.10 V	172	83.50	32.29
1	*2437.00	106.34 AV			1.10 V	172	74.05	32.29
2	4874.00	49.95 PK	74.00	-24.05	1.11 V	108	11.16	38.79
2	4874.00	37.63 AV	54.00	-16.37	1.11 V	108	-1.16	38.79
3	7311.00	68.83 PK	74.00	-5.17	1.08 V	22	23.42	45.41
3	7311.00	52.45 AV	54.00	-1.55	1.08 V	22	7.04	45.41

- REMARKS:**
1. Emission level (dBuV/m) = Raw Value (dBuV) + Correction Factor (dB/m).
 2. Correction Factor (dB/m) = Antenna Factor (dB/m) + Cable Factor (dB).
 3. The other emission levels were very low against the limit.
 4. Margin value = Emission level – Limit value.
 5. The limit value is defined as per 15.247.
 6. “ * “: Fundamental frequency.



EUT TEST CONDITION		MEASUREMENT DETAIL	
CHANNEL	Channel 11	FREQUENCY RANGE	1 ~ 25GHz
MODULATION TYPE	BPSK	INPUT POWER (SYSTEM)	120Vac, 60 Hz
TRANSFER RATE	6.0Mbps	DETECTOR FUNCTION	Peak(PK) Average (AV)
ENVIRONMENTAL CONDITIONS	22deg. C, 63%RH, 991hPa	TESTED BY	Brad Wu

ANTENNA POLARITY & TEST DISTANCE: HORIZONTAL AT 3 M								
NO.	FREQ. (MHz)	EMISSION LEVEL (dBuV/m)	LIMIT (dBuV/m)	MARGIN (dB)	ANTENNA HEIGHT (m)	TABLE ANGLE (Degree)	RAW VALUE (dBuV)	CORRECTION FACTOR (dB/m)
1	*2462.00	104.13 PK			1.25 H	141	71.75	32.38
1	*2462.00	93.98 AV			1.25 H	141	61.60	32.38
2	2483.50	60.02 PK	74.00	-13.98	1.25 H	141	27.56	32.46
2	2483.50	41.62 AV	54.00	-12.38	1.25 H	141	9.16	32.46
3	4924.00	48.73 PK	74.00	-25.27	1.06 H	143	9.81	38.92
3	4924.00	36.42 AV	54.00	-17.58	1.06 H	143	-2.50	38.92
4	7386.00	63.25 PK	74.00	-10.75	1.45 H	63	17.66	45.59
4	7386.00	46.67 AV	54.00	-7.33	1.45 H	63	1.08	45.59

ANTENNA POLARITY & TEST DISTANCE: VERTICAL AT 3 M								
NO.	FREQ. (MHz)	EMISSION LEVEL (dBuV/m)	LIMIT (dBuV/m)	MARGIN (dB)	ANTENNA HEIGHT (m)	TABLE ANGLE (Degree)	RAW VALUE (dBuV)	CORRECTION FACTOR (dB/m)
1	*2462.00	114.32 PK			1.10 V	172	81.94	32.38
1	*2462.00	104.94 AV			1.10 V	172	72.56	32.38
2	2483.50	71.21 PK	74.00	-2.79	1.10 V	172	38.75	32.46
2	2483.50	52.58 AV	54.00	-1.42	1.10 V	172	20.12	32.46
3	4924.00	50.87 PK	74.00	-23.13	1.10 V	134	11.95	38.92
3	4924.00	38.62 AV	54.00	-15.38	1.10 V	134	-0.30	38.92
4	7386.00	67.80 PK	74.00	-6.20	1.10 V	24	22.20	45.59
4	7386.00	51.44 AV	54.00	-2.56	1.10 V	24	5.84	45.59

- REMARKS:**
1. Emission level (dBuV/m) = Raw Value (dBuV) + Correction Factor (dB/m).
 2. Correction Factor (dB/m) = Antenna Factor (dB/m) + Cable Factor (dB).
 3. The other emission levels were very low against the limit.
 4. Margin value = Emission level – Limit value.
 5. The limit value is defined as per 15.247.
 6. “ * “: Fundamental frequency.

DRAFT 802.11n (20MHz) OFDM MODULATION:

EUT TEST CONDITION		MEASUREMENT DETAIL	
CHANNEL	Channel 1	FREQUENCY RANGE	1 ~ 25GHz
MODULATION TYPE	BPSK	INPUT POWER (SYSTEM)	120Vac, 60 Hz
TRANSFER RATE	7.2Mbps	DETECTOR FUNCTION	Peak(PK) Average (AV)
ENVIRONMENTAL CONDITIONS	22deg. C, 63%RH, 991hPa	TESTED BY	Brad Wu

ANTENNA POLARITY & TEST DISTANCE: HORIZONTAL AT 3 M								
NO.	FREQ. (MHz)	EMISSION LEVEL (dBuV/m)	LIMIT (dBuV/m)	MARGIN (dB)	ANTENNA HEIGHT (m)	TABLE ANGLE (Degree)	RAW VALUE (dBuV)	CORRECTION FACTOR (dB/m)
1	2390.00	62.43 PK	74.00	-11.57	1.42 H	248	30.32	32.11
1	2390.00	43.13 AV	54.00	-10.87	1.42 H	248	11.02	32.11
2	*2412.00	105.74 PK			1.42 H	248	73.55	32.19
2	*2412.00	93.44 AV			1.42 H	248	61.25	32.19
3	4824.00	47.53 PK	74.00	-26.47	1.05 H	127	8.88	38.65
3	4824.00	35.22 AV	54.00	-18.78	1.05 H	127	-3.43	38.65
4	7236.00	60.35 PK	85.74	-25.39	1.05 H	79	15.14	45.21
4	7236.00	43.82 AV	73.44	-29.62	1.05 H	79	-1.39	45.21

ANTENNA POLARITY & TEST DISTANCE: VERTICAL AT 3 M								
NO.	FREQ. (MHz)	EMISSION LEVEL (dBuV/m)	LIMIT (dBuV/m)	MARGIN (dB)	ANTENNA HEIGHT (m)	TABLE ANGLE (Degree)	RAW VALUE (dBuV)	CORRECTION FACTOR (dB/m)
1	2390.00	71.09 PK	74.00	-2.91	1.15 V	173	38.98	32.11
1	2390.00	52.67 AV	54.00	-1.33	1.15 V	173	20.56	32.11
2	*2412.00	114.50 PK			1.15 V	173	82.31	32.19
2	*2412.00	101.98 AV			1.15 V	173	69.79	32.19
3	4824.00	49.53 PK	74.00	-24.47	1.09 V	261	10.88	38.65
3	4824.00	37.21 AV	54.00	-16.79	1.09 V	261	-1.44	38.65
4	7236.00	62.84 PK	94.50	-31.66	1.16 V	52	17.63	45.21
4	7236.00	46.30 AV	81.98	-35.68	1.16 V	52	1.09	45.21

- REMARKS:**
1. Emission level (dBuV/m) = Raw Value (dBuV) + Correction Factor (dB/m).
 2. Correction Factor (dB/m) = Antenna Factor (dB/m) + Cable Factor (dB).
 3. The other emission levels were very low against the limit.
 4. Margin value = Emission level – Limit value.
 5. The limit value is defined as per 15.247.
 6. “ * “: Fundamental frequency.



EUT TEST CONDITION		MEASUREMENT DETAIL	
CHANNEL	Channel 6	FREQUENCY RANGE	1 ~ 25GHz
MODULATION TYPE	BPSK	INPUT POWER (SYSTEM)	120Vac, 60 Hz
TRANSFER RATE	7.2Mbps	DETECTOR FUNCTION	Peak(PK) Average (AV)
ENVIRONMENTAL CONDITIONS	22deg. C, 63%RH, 991hPa	TESTED BY	Brad Wu

ANTENNA POLARITY & TEST DISTANCE: HORIZONTAL AT 3 M								
NO.	FREQ. (MHz)	EMISSION LEVEL (dBuV/m)	LIMIT (dBuV/m)	MARGIN (dB)	ANTENNA HEIGHT (m)	TABLE ANGLE (Degree)	RAW VALUE (dBuV)	CORRECTION FACTOR (dB/m)
1	*2437.00	108.15 PK			1.41 H	250	75.86	32.29
1	*2437.00	95.87 AV			1.41 H	250	63.58	32.29
2	4874.00	47.92 PK	74.00	-26.08	1.11 H	102	9.13	38.79
2	4874.00	35.64 AV	54.00	-18.36	1.11 H	102	-3.15	38.79
3	7311.00	60.92 PK	74.00	-13.08	1.02 H	84	15.51	45.41
3	7311.00	44.48 AV	54.00	-9.52	1.02 H	84	-0.93	45.41

ANTENNA POLARITY & TEST DISTANCE: VERTICAL AT 3 M								
NO.	FREQ. (MHz)	EMISSION LEVEL (dBuV/m)	LIMIT (dBuV/m)	MARGIN (dB)	ANTENNA HEIGHT (m)	TABLE ANGLE (Degree)	RAW VALUE (dBuV)	CORRECTION FACTOR (dB/m)
1	*2437.00	117.25 PK			1.12 V	169	84.96	32.29
1	*2437.00	104.54 AV			1.12 V	169	72.25	32.29
2	4874.00	50.89 PK	74.00	-23.11	1.11 V	254	12.10	38.79
2	4874.00	38.42 AV	54.00	-15.58	1.11 V	254	-0.37	38.79
3	7311.00	68.57 PK	74.00	-5.43	1.29 V	57	23.16	45.41
3	7311.00	52.50 AV	54.00	-1.50	1.29 V	57	7.09	45.41

- REMARKS:**
1. Emission level (dBuV/m) = Raw Value (dBuV) + Correction Factor (dB/m).
 2. Correction Factor (dB/m) = Antenna Factor (dB/m) + Cable Factor (dB).
 3. The other emission levels were very low against the limit.
 4. Margin value = Emission level – Limit value.
 5. The limit value is defined as per 15.247.
 6. “ * “: Fundamental frequency.



EUT TEST CONDITION		MEASUREMENT DETAIL	
CHANNEL	Channel 11	FREQUENCY RANGE	1 ~ 25GHz
MODULATION TYPE	BPSK	INPUT POWER (SYSTEM)	120Vac, 60 Hz
TRANSFER RATE	7.2Mbps	DETECTOR FUNCTION	Peak(PK) Average (AV)
ENVIRONMENTAL CONDITIONS	22deg. C, 63%RH, 991hPa	TESTED BY	Brad Wu

ANTENNA POLARITY & TEST DISTANCE: HORIZONTAL AT 3 M								
NO.	FREQ. (MHz)	EMISSION LEVEL (dBuV/m)	LIMIT (dBuV/m)	MARGIN (dB)	ANTENNA HEIGHT (m)	TABLE ANGLE (Degree)	RAW VALUE (dBuV)	CORRECTION FACTOR (dB/m)
1	*2462.00	105.36 PK			1.40 H	253	72.98	32.38
1	*2462.00	93.05 AV			1.40 H	253	60.67	32.38
2	2483.50	63.40 PK	74.00	-10.60	1.40 H	253	30.94	32.46
2	2483.50	44.36 AV	54.00	-9.64	1.40 H	253	11.90	32.46
3	4924.00	47.66 PK	74.00	-26.34	1.02 H	134	8.74	38.92
3	4924.00	35.38 AV	54.00	-18.62	1.02 H	134	-3.54	38.92
4	7386.00	60.44 PK	74.00	-13.56	1.03 H	84	14.84	45.59
4	7386.00	43.94 AV	54.00	-10.06	1.03 H	84	-1.66	45.59

ANTENNA POLARITY & TEST DISTANCE: VERTICAL AT 3 M								
NO.	FREQ. (MHz)	EMISSION LEVEL (dBuV/m)	LIMIT (dBuV/m)	MARGIN (dB)	ANTENNA HEIGHT (m)	TABLE ANGLE (Degree)	RAW VALUE (dBuV)	CORRECTION FACTOR (dB/m)
1	*2462.00	113.95 PK			1.11 V	170	81.57	32.38
1	*2462.00	101.43 AV			1.11 V	170	69.05	32.38
2	2483.50	71.99 PK	74.00	-2.01	1.11 V	170	39.53	32.46
2	2483.50	52.74 AV	54.00	-1.26	1.11 V	170	20.28	32.46
3	4924.00	49.87 PK	74.00	-24.13	1.14 V	253	10.95	38.92
3	4924.00	37.52 AV	54.00	-16.48	1.14 V	253	-1.40	38.92
4	7386.00	62.97 PK	74.00	-11.03	1.12 V	45	17.37	45.59
4	7386.00	46.45 AV	54.00	-7.55	1.12 V	45	0.86	45.59

- REMARKS:**
1. Emission level (dBuV/m) = Raw Value (dBuV) + Correction Factor (dB/m).
 2. Correction Factor (dB/m) = Antenna Factor (dB/m) + Cable Factor (dB).
 3. The other emission levels were very low against the limit.
 4. Margin value = Emission level – Limit value.
 5. The limit value is defined as per 15.247.
 6. “ * “: Fundamental frequency.

DRAFT 802.11n (40MHz) OFDM MODULATION:

EUT TEST CONDITION		MEASUREMENT DETAIL	
CHANNEL	Channel 1	FREQUENCY RANGE	1 ~ 25GHz
MODULATION TYPE	BPSK	INPUT POWER (SYSTEM)	120Vac, 60 Hz
TRANSFER RATE	15.0Mbps	DETECTOR FUNCTION	Peak(PK) Average (AV)
ENVIRONMENTAL CONDITIONS	22deg. C, 63%RH, 991hPa	TESTED BY	Brad Wu

ANTENNA POLARITY & TEST DISTANCE: HORIZONTAL AT 3 M								
NO.	FREQ. (MHz)	EMISSION LEVEL (dBuV/m)	LIMIT (dBuV/m)	MARGIN (dB)	ANTENNA HEIGHT (m)	TABLE ANGLE (Degree)	RAW VALUE (dBuV)	CORRECTION FACTOR (dB/m)
1	2390.00	62.44 PK	74.00	-11.56	1.12 H	221	30.33	32.11
1	2390.00	43.36 AV	54.00	-10.64	1.12 H	221	11.25	32.11
2	*2422.00	100.81 PK			1.12 H	221	68.58	32.23
2	*2422.00	88.51 AV			1.12 H	221	56.28	32.23
3	4844.00	47.65 PK	74.00	-26.35	1.07 H	132	8.95	38.70
3	4844.00	35.36 AV	54.00	-18.64	1.07 H	132	-3.34	38.70
4	7266.00	60.22 PK	74.00	-13.78	1.03 H	84	14.93	45.29
4	7266.00	43.71 AV	54.00	-10.29	1.03 H	84	-1.58	45.29

ANTENNA POLARITY & TEST DISTANCE: VERTICAL AT 3 M								
NO.	FREQ. (MHz)	EMISSION LEVEL (dBuV/m)	LIMIT (dBuV/m)	MARGIN (dB)	ANTENNA HEIGHT (m)	TABLE ANGLE (Degree)	RAW VALUE (dBuV)	CORRECTION FACTOR (dB/m)
1	2390.00	71.29 PK	74.00	-2.71	1.13 V	170	39.18	32.11
1	2390.00	52.38 AV	54.00	-1.62	1.13 V	170	20.27	32.11
2	*2422.00	109.66 PK			1.13 V	170	77.43	32.23
2	*2422.00	97.53 AV			1.13 V	170	65.30	32.23
3	4844.00	49.37 PK	74.00	-24.63	1.10 V	253	10.67	38.70
3	4844.00	37.04 AV	54.00	-16.96	1.10 V	253	-1.66	38.70
4	7266.00	62.59 PK	74.00	-11.41	1.12 V	74	17.30	45.29
4	7266.00	46.13 AV	54.00	-7.87	1.12 V	74	0.84	45.29

- REMARKS:**
1. Emission level (dBuV/m) = Raw Value (dBuV) + Correction Factor (dB/m).
 2. Correction Factor (dB/m) = Antenna Factor (dB/m) + Cable Factor (dB).
 3. The other emission levels were very low against the limit.
 4. Margin value = Emission level – Limit value.
 5. The limit value is defined as per 15.247.
 6. “ * “: Fundamental frequency.



EUT TEST CONDITION		MEASUREMENT DETAIL	
CHANNEL	Channel 4	FREQUENCY RANGE	1 ~ 25GHz
MODULATION TYPE	BPSK	INPUT POWER (SYSTEM)	120Vac, 60 Hz
TRANSFER RATE	15.0Mbps	DETECTOR FUNCTION	Peak(PK) Average (AV)
ENVIRONMENTAL CONDITIONS	22deg. C, 63%RH, 991hPa	TESTED BY	Brad Wu

ANTENNA POLARITY & TEST DISTANCE: HORIZONTAL AT 3 M								
NO.	FREQ. (MHz)	EMISSION LEVEL (dBuV/m)	LIMIT (dBuV/m)	MARGIN (dB)	ANTENNA HEIGHT (m)	TABLE ANGLE (Degree)	RAW VALUE (dBuV)	CORRECTION FACTOR (dB/m)
1	*2437.00	103.14 PK			1.10 H	239	70.85	32.29
1	*2437.00	100.85 AV			1.10 H	239	68.56	32.29
2	4874.00	48.72 PK	74.00	-25.28	1.02 H	63	9.93	38.79
2	4874.00	36.45 AV	54.00	-17.55	1.02 H	63	-2.34	38.79
3	7311.00	63.35 PK	74.00	-10.65	1.01 H	109	17.94	45.41
3	7311.00	46.87 AV	54.00	-7.13	1.01 H	109	1.46	45.41

ANTENNA POLARITY & TEST DISTANCE: VERTICAL AT 3 M								
NO.	FREQ. (MHz)	EMISSION LEVEL (dBuV/m)	LIMIT (dBuV/m)	MARGIN (dB)	ANTENNA HEIGHT (m)	TABLE ANGLE (Degree)	RAW VALUE (dBuV)	CORRECTION FACTOR (dB/m)
1	*2437.00	112.03 PK			1.11 V	167	79.74	32.29
1	*2437.00	99.96 AV			1.11 V	167	67.67	32.29
2	4874.00	51.46 PK	74.00	-22.54	1.08 V	245	12.67	38.79
2	4874.00	39.23 AV	54.00	-14.77	1.08 V	245	0.44	38.79
3	7311.00	67.71 PK	74.00	-6.29	1.10 V	63	22.30	45.41
3	7311.00	51.29 AV	54.00	-2.71	1.10 V	63	5.88	45.41

- REMARKS:**
1. Emission level (dBuV/m) = Raw Value (dBuV) + Correction Factor (dB/m).
 2. Correction Factor (dB/m) = Antenna Factor (dB/m) + Cable Factor (dB).
 3. The other emission levels were very low against the limit.
 4. Margin value = Emission level – Limit value.
 5. The limit value is defined as per 15.247.
 6. “ * “: Fundamental frequency.

EUT TEST CONDITION		MEASUREMENT DETAIL	
CHANNEL	Channel 7	FREQUENCY RANGE	1 ~ 25GHz
MODULATION TYPE	BPSK	INPUT POWER (SYSTEM)	120Vac, 60 Hz
TRANSFER RATE	15.0Mbps	DETECTOR FUNCTION	Peak(PK) Average (AV)
ENVIRONMENTAL CONDITIONS	22deg. C, 63%RH, 991hPa	TESTED BY	Brad Wu

ANTENNA POLARITY & TEST DISTANCE: HORIZONTAL AT 3 M								
NO.	FREQ. (MHz)	EMISSION LEVEL (dBuV/m)	LIMIT (dBuV/m)	MARGIN (dB)	ANTENNA HEIGHT (m)	TABLE ANGLE (Degree)	RAW VALUE (dBuV)	CORRECTION FACTOR (dB/m)
1	*2452.00	100.63 PK			1.10 H	224	68.29	32.34
1	*2452.00	88.34 AV			1.10 H	224	56.00	32.34
2	2483.50	63.15 PK	74.00	-10.85	1.10 H	224	30.69	32.46
2	2483.50	43.78 AV	54.00	-10.22	1.10 H	224	11.32	32.46
3	4904.00	47.83 PK	74.00	-26.17	1.02 H	147	8.96	38.87
3	4904.00	35.61 AV	54.00	-18.39	1.02 H	147	-3.26	38.87
4	7356.00	60.13 PK	74.00	-13.87	1.02 H	77	14.61	45.52
4	7356.00	43.57 AV	54.00	-10.43	1.02 H	77	-1.95	45.52

ANTENNA POLARITY & TEST DISTANCE: VERTICAL AT 3 M								
NO.	FREQ. (MHz)	EMISSION LEVEL (dBuV/m)	LIMIT (dBuV/m)	MARGIN (dB)	ANTENNA HEIGHT (m)	TABLE ANGLE (Degree)	RAW VALUE (dBuV)	CORRECTION FACTOR (dB/m)
1	*2452.00	109.38 PK			1.12 V	171	77.04	32.34
1	*2452.00	97.23 AV			1.12 V	171	64.89	32.34
2	2483.50	71.90 PK	74.00	-2.10	1.12 V	171	39.44	32.46
2	2483.50	52.67 AV	54.00	-1.33	1.12 V	171	20.21	32.46
3	4904.00	50.11 PK	74.00	-23.89	1.05 V	212	11.24	38.87
3	4904.00	37.76 AV	54.00	-16.24	1.05 V	212	-1.11	38.87
4	7356.00	62.97 PK	74.00	-11.03	1.10 V	84	17.45	45.52
4	7356.00	46.51 AV	54.00	-7.49	1.10 V	84	0.99	45.52

- REMARKS:**
1. Emission level (dBuV/m) = Raw Value (dBuV) + Correction Factor (dB/m).
 2. Correction Factor (dB/m) = Antenna Factor (dB/m) + Cable Factor (dB).
 3. The other emission levels were very low against the limit.
 4. Margin value = Emission level – Limit value.
 5. The limit value is defined as per 15.247.
 6. “ * “: Fundamental frequency.



4.3 6dB BANDWIDTH MEASUREMENT

4.3.1 LIMITS OF 6dB BANDWIDTH MEASUREMENT

The minimum of 6dB Bandwidth Measurement is 0.5 MHz.

4.3.2 TEST INSTRUMENTS

DESCRIPTION & MANUFACTURER	MODEL NO.	SERIAL NO.	CALIBRATED UNTIL
SPECTRUM ANALYZER	FSEK 30	100049	Aug. 14, 2006

NOTE: The calibration interval of the above test instruments is 12 months and the calibrations are traceable to NML/ROC and NIST/USA.

4.3.3 TEST PROCEDURE

The transmitter output was connected to the spectrum analyzer through an attenuator. The bandwidth of the fundamental frequency was measured by spectrum analyzer with 100kHz RBW and 100kHz VBW. The 6dB bandwidth is defined as the total spectrum the power of which is higher than peak power minus 6dB.

4.3.4 DEVIATION FROM TEST STANDARD

No deviation

4.3.5 TEST SETUP

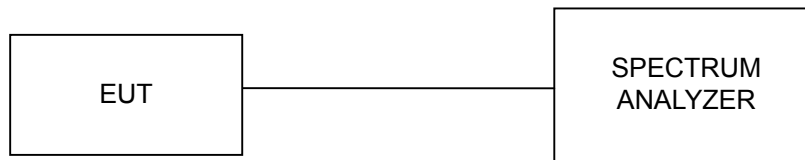

4.3.6 EUT OPERATING CONDITIONS

The software provided by client to enable the EUT under transmission condition continuously at lowest, middle and highest channel frequencies individually.

4.3.7 TEST RESULTS

802.11b DSSS MODULATION:

MODULATION TYPE	DBPSK	TRANSFER RATE	1.0Mbps
INPUT POWER (SYSTEM)	120Vac, 60 Hz	ENVIRONMENTAL CONDITIONS	25deg.C, 63%RH, 991hPa
TESTED BY	Long Chen		

CHANNEL	CHANNEL FREQUENCY (MHz)	6dB BANDWIDTH (MHz)			MINIMUM LIMIT (MHz)	PASS / FAIL
		CHAIN 0	CHAIN 1	CHAIN 2		
1	2412	12.04	12.08	12.04	0.5	PASS
6	2437	12.08	12.04	12.04	0.5	PASS
11	2462	12.08	12.08	12.00	0.5	PASS

FOR CHAIN 0: CH 1

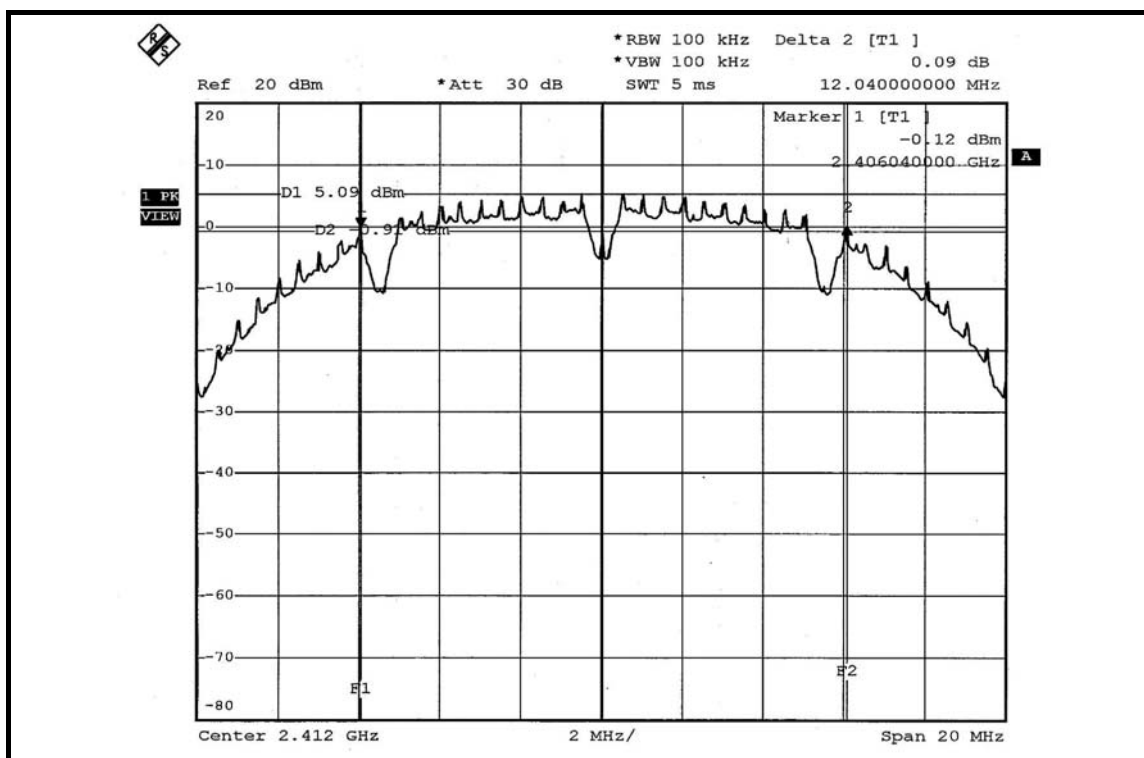

CH 6

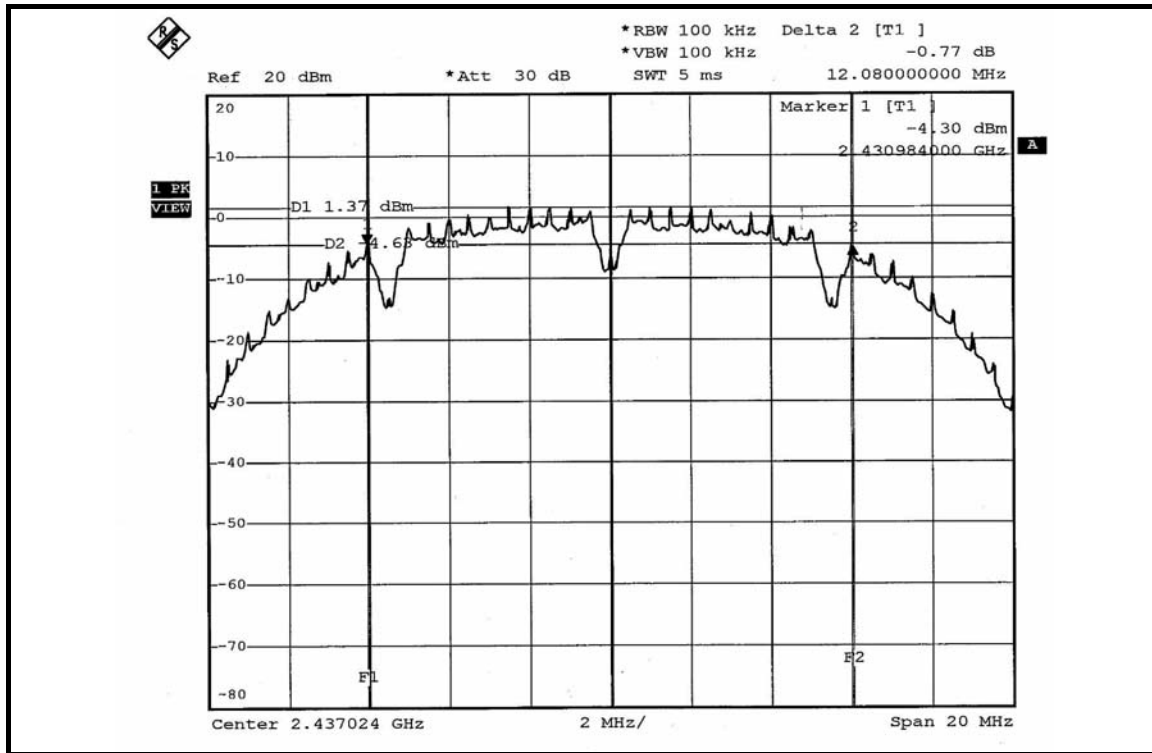

CH 11

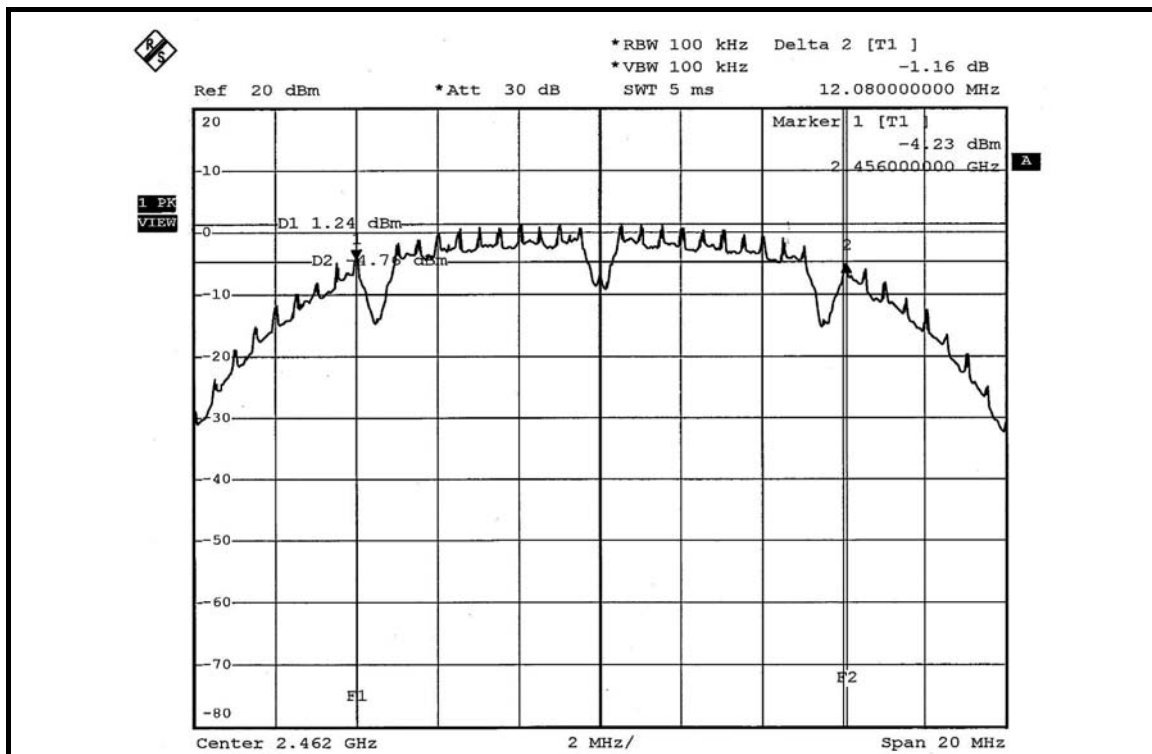

FOR CHAIN 1: CH 1

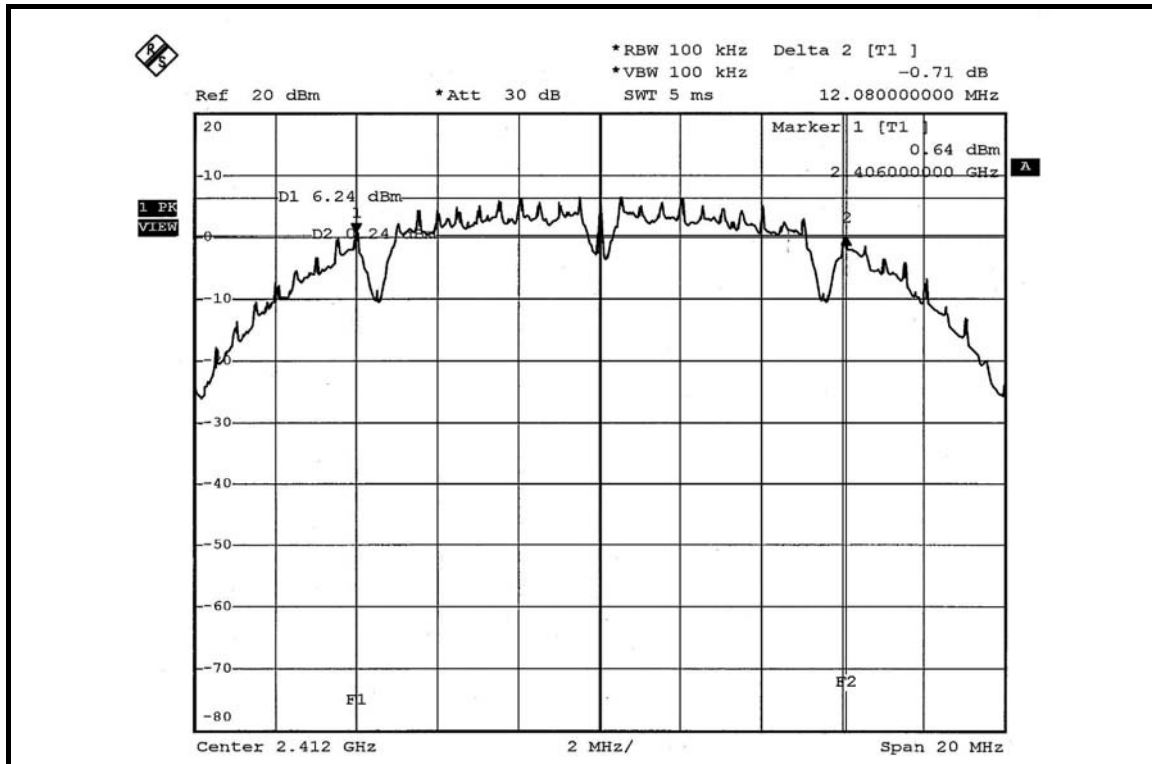

CH 6

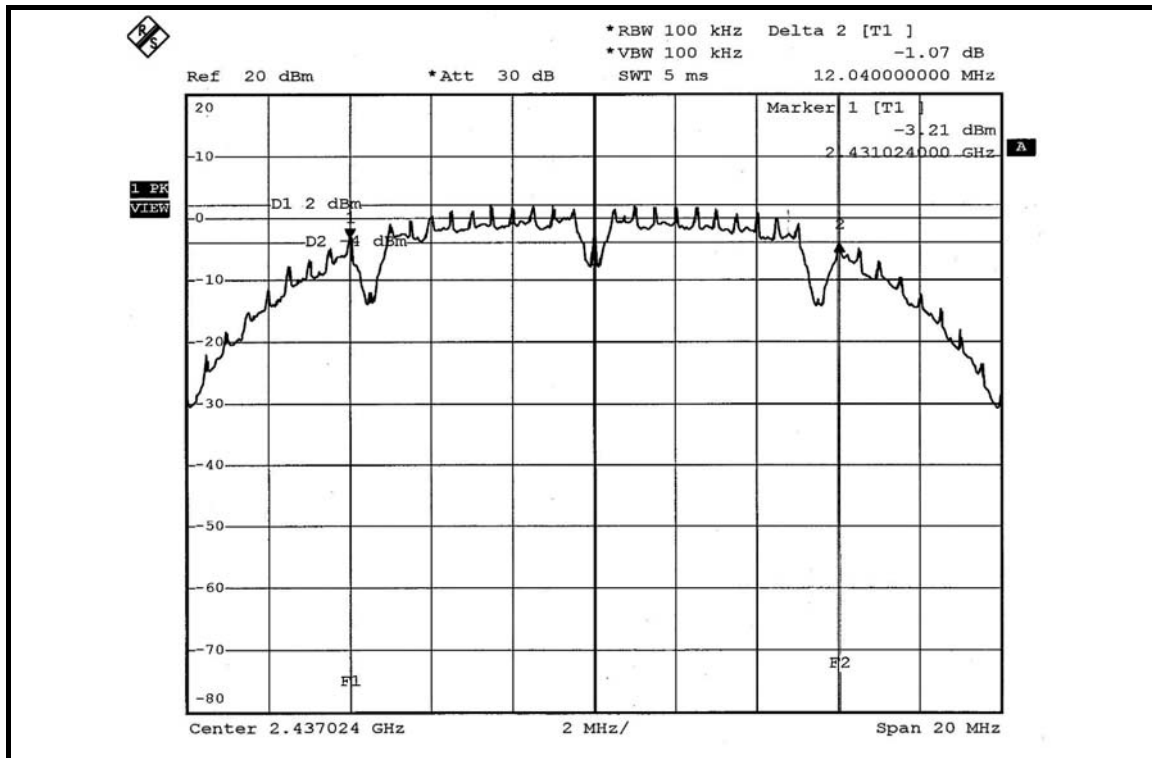

CH 11

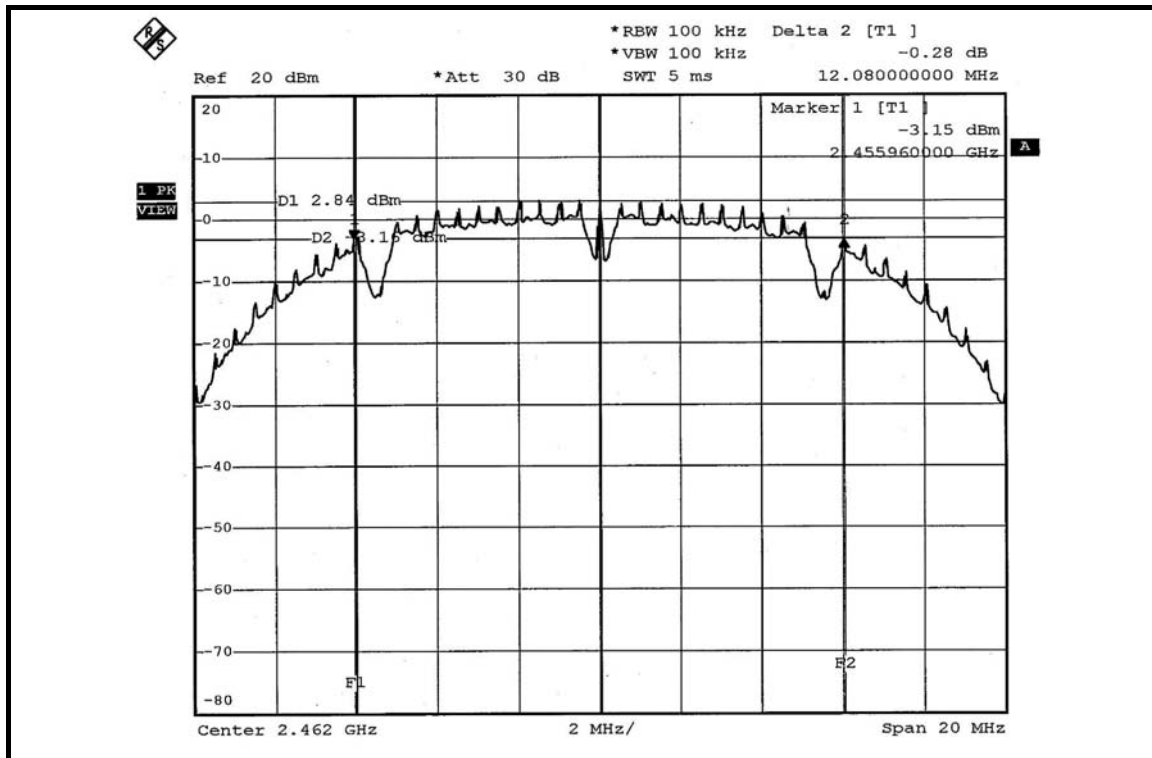

FOR CHAIN 2: CH 1

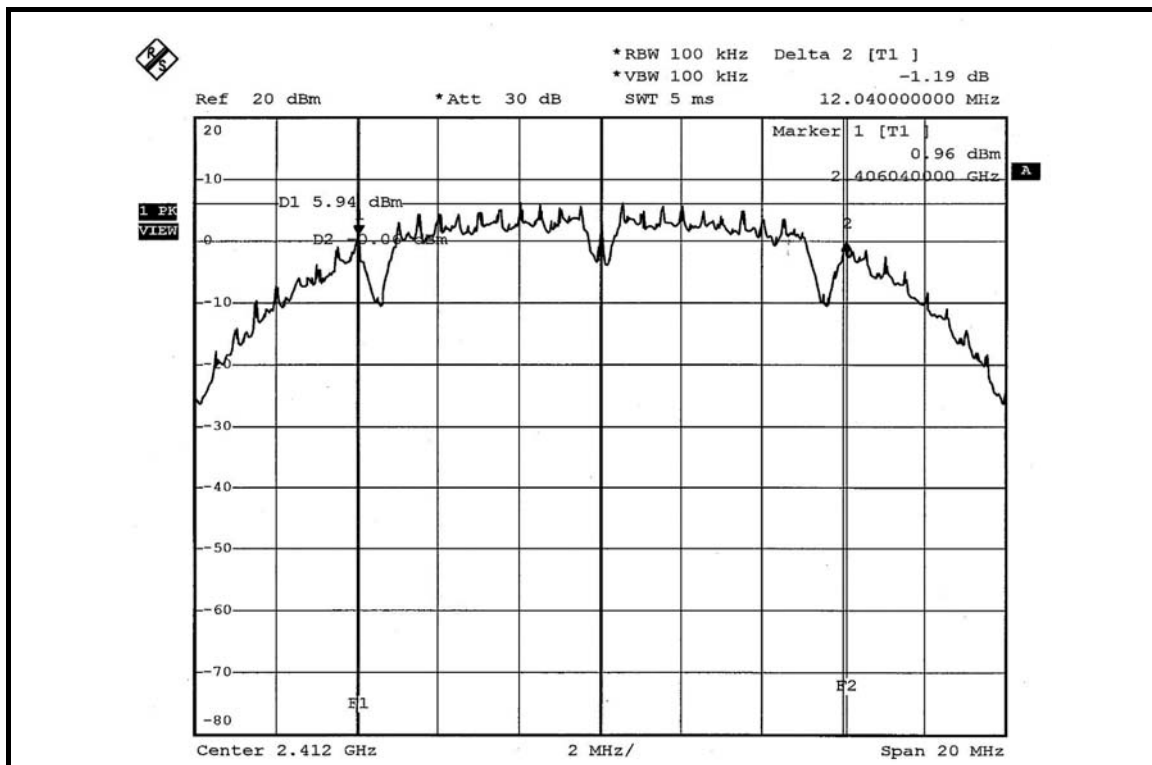

CH 6

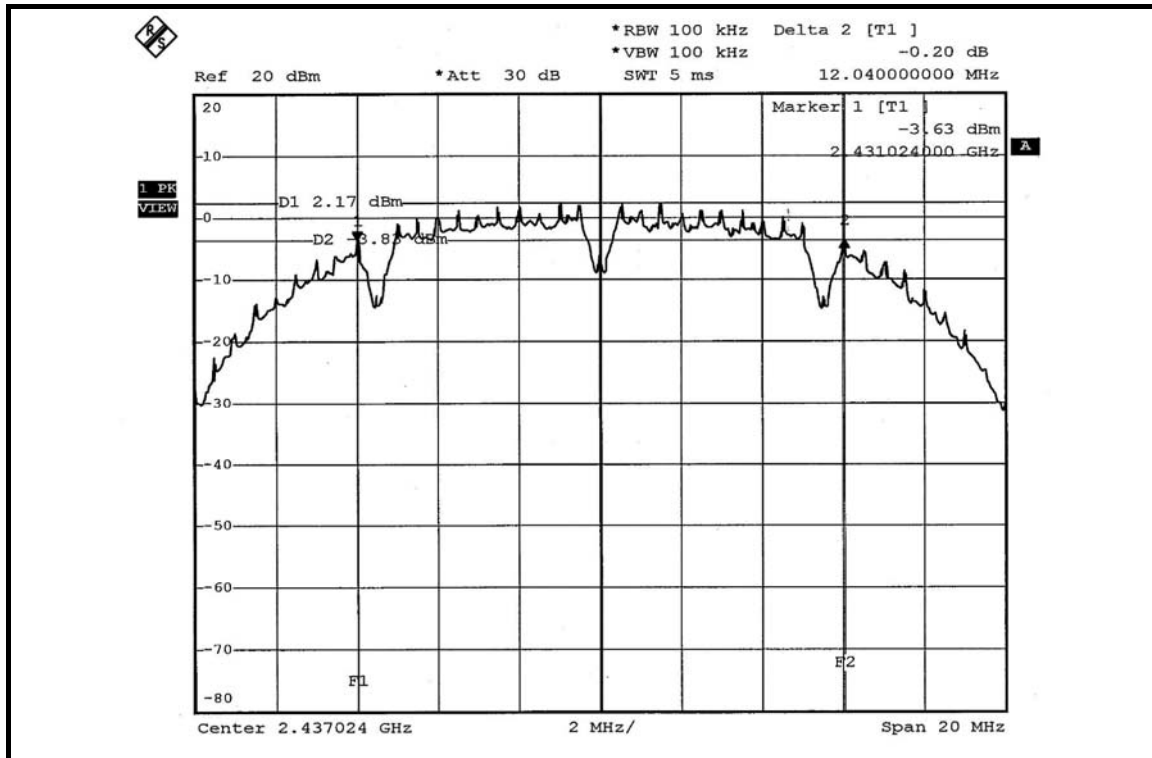

CH 11

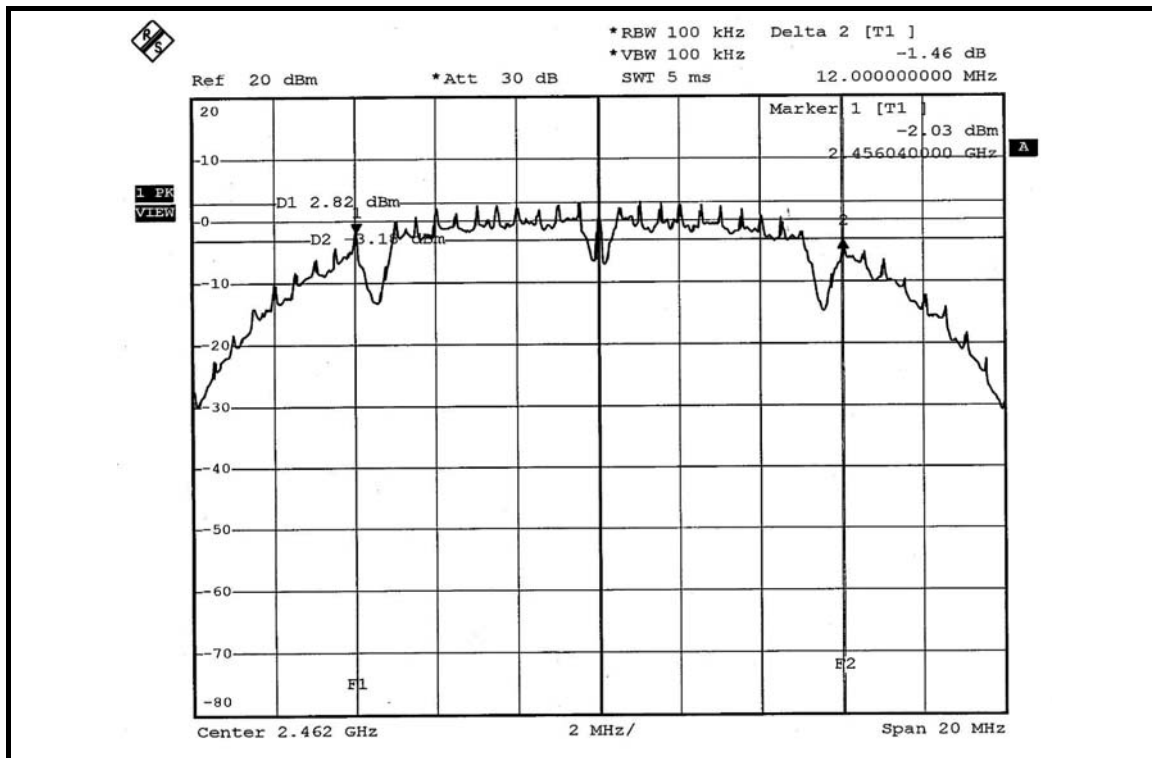



802.11g OFDM MODULATION:

MODULATION TYPE	BPSK	TRANSFER RATE	6.0Mbps
INPUT POWER (SYSTEM)	120Vac, 60 Hz	ENVIRONMENTAL CONDITIONS	25deg.C, 63%RH, 991hPa
TESTED BY	Long Chen		

CHANNEL	CHANNEL FREQUENCY (MHz)	6dB BANDWIDTH (MHz)			MINIMUM LIMIT (MHz)	PASS / FAIL
		CHAIN 0	CHAIN 1	CHAIN 2		
1	2412	16.40	16.40	16.40	0.5	PASS
6	2437	16.36	16.40	16.40	0.5	PASS
11	2462	16.36	16.36	16.36	0.5	PASS

FOR CHAIN 0: CH 1

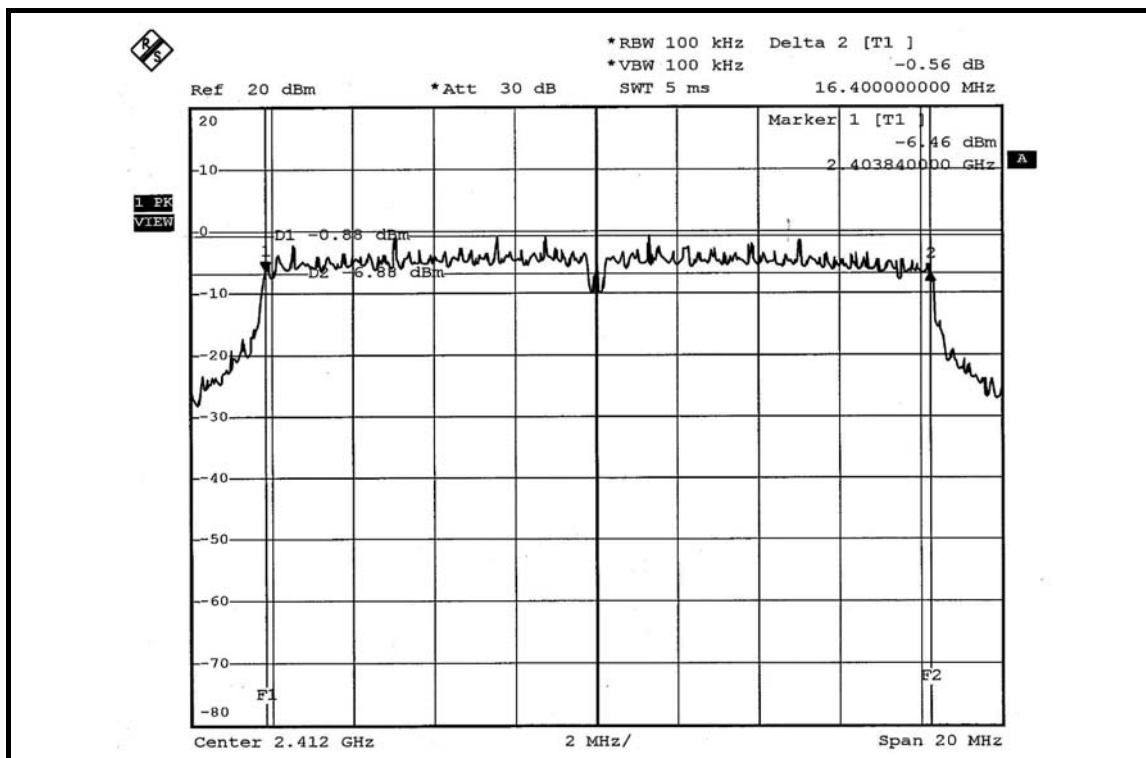

CH 6

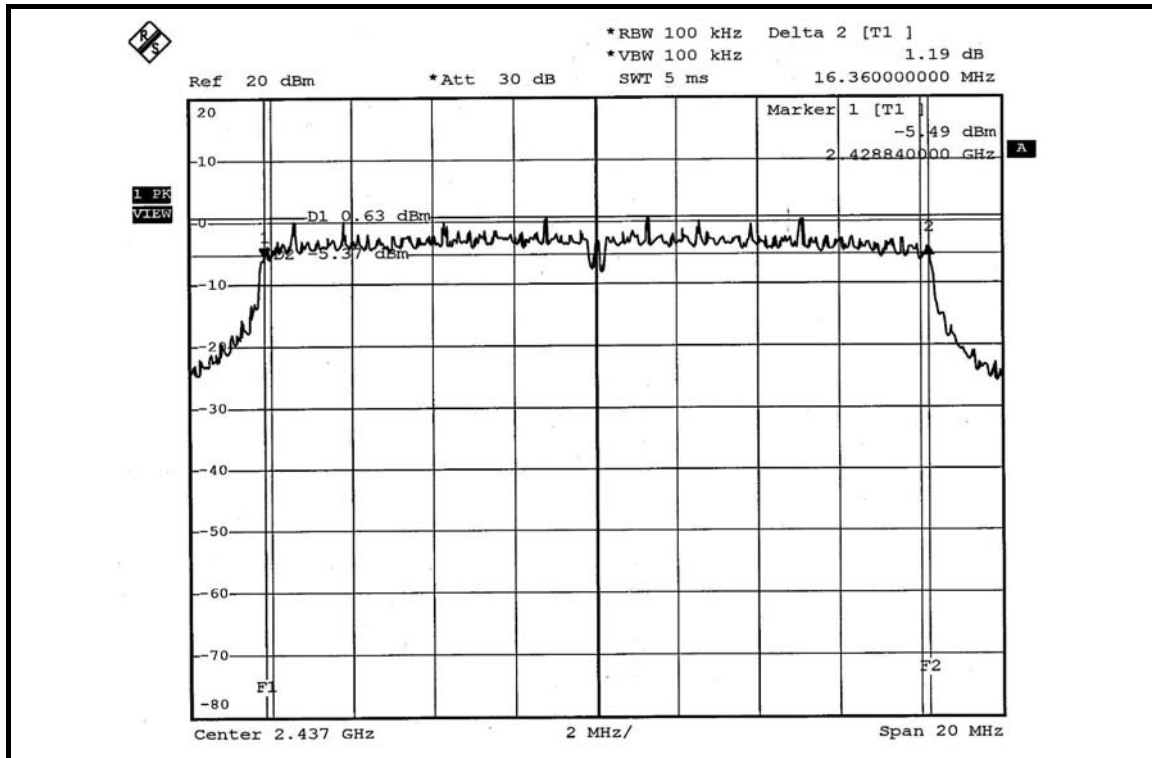

CH 11

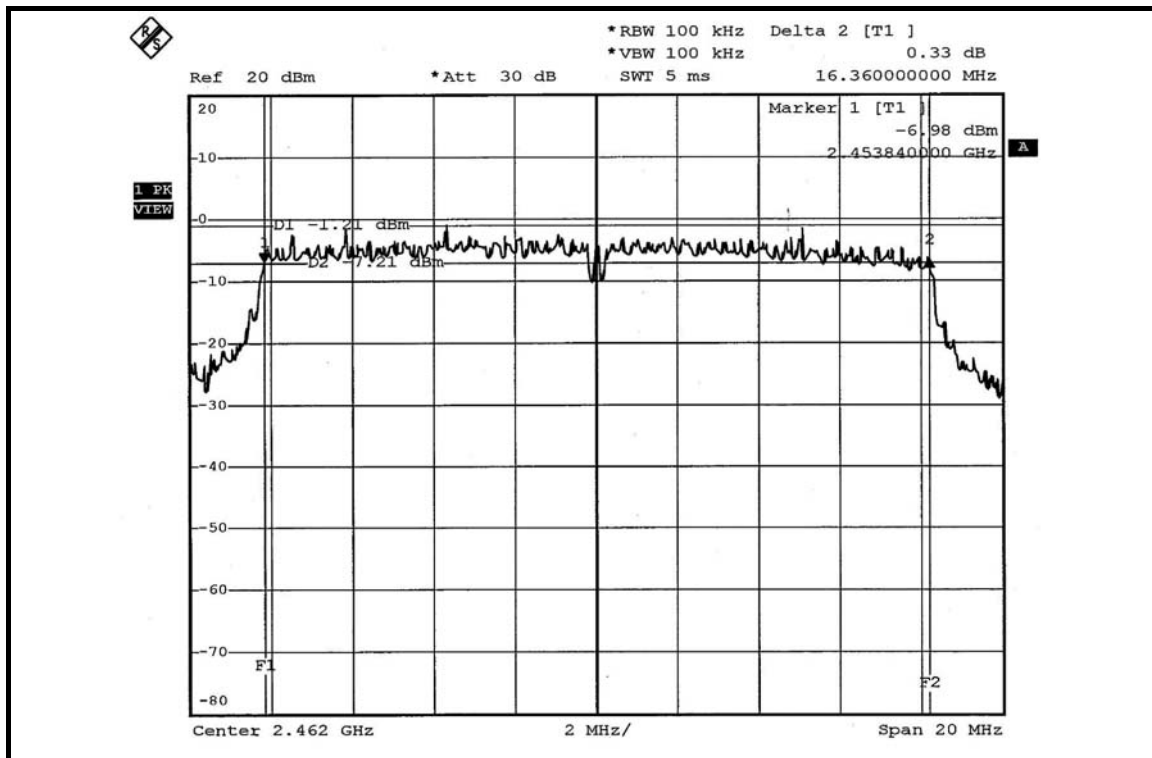

FOR CHAIN 1: CH 1

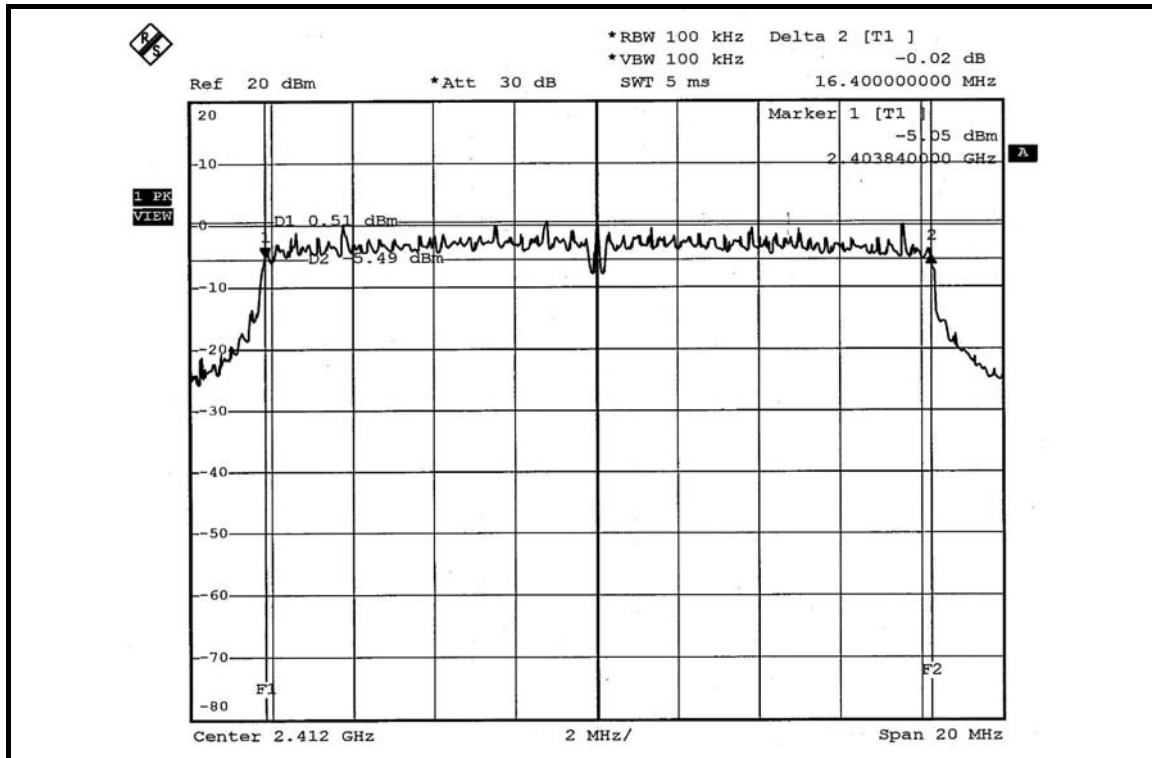

CH 6

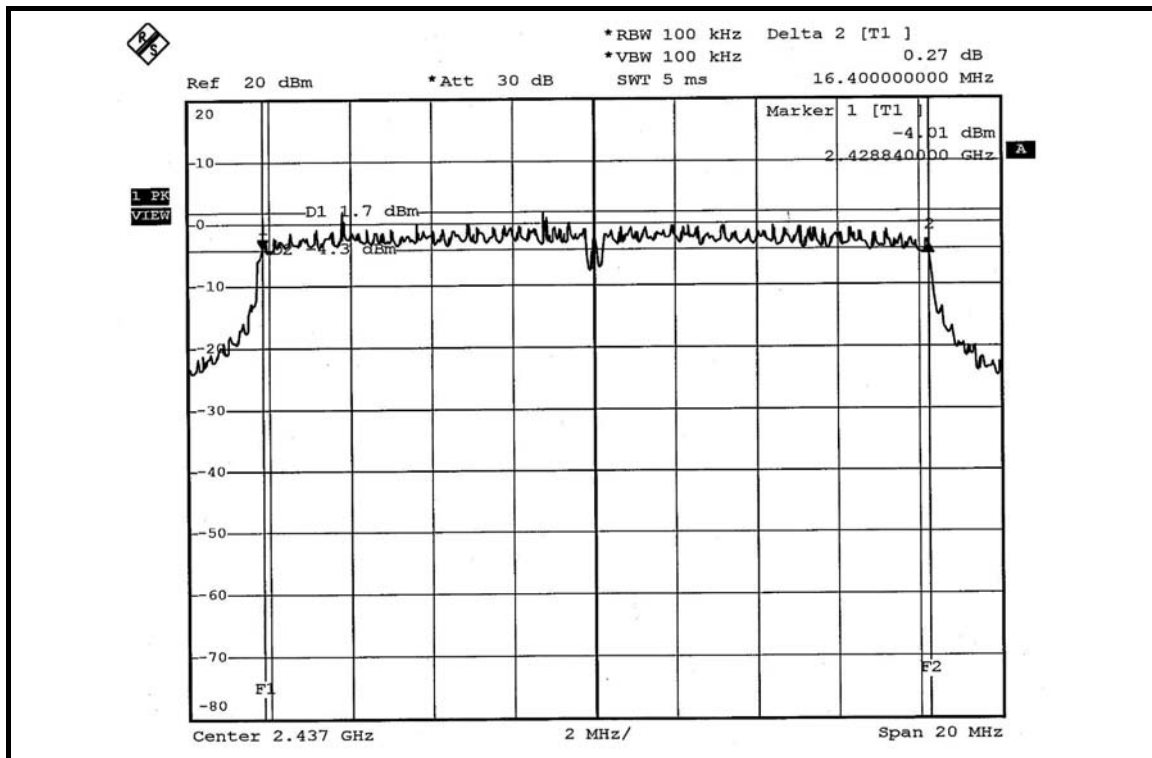

CH 11

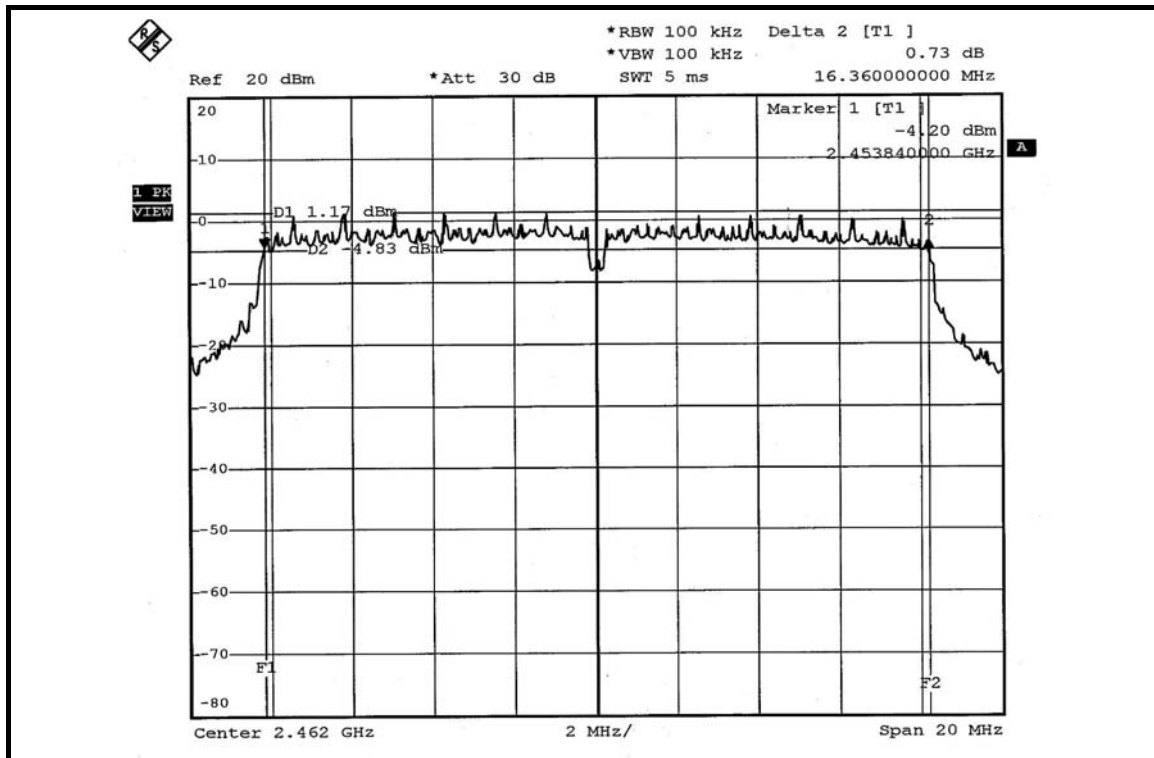

FOR CHAIN 2: CH 1

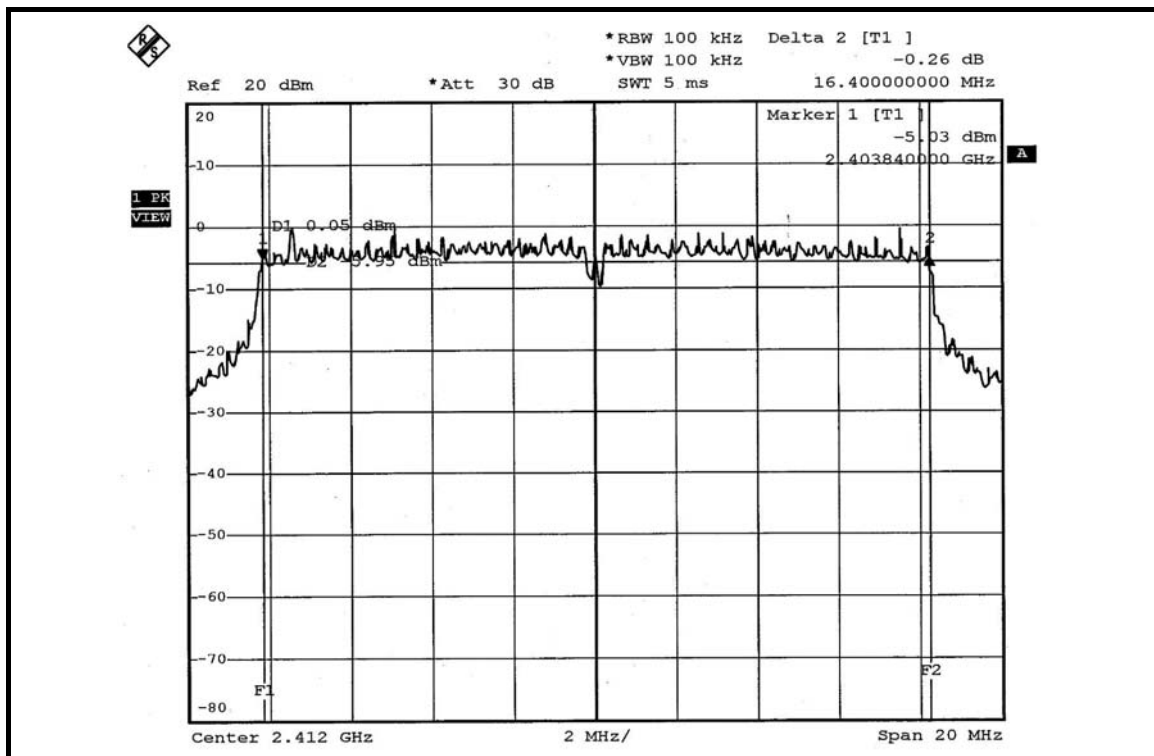

CH 6

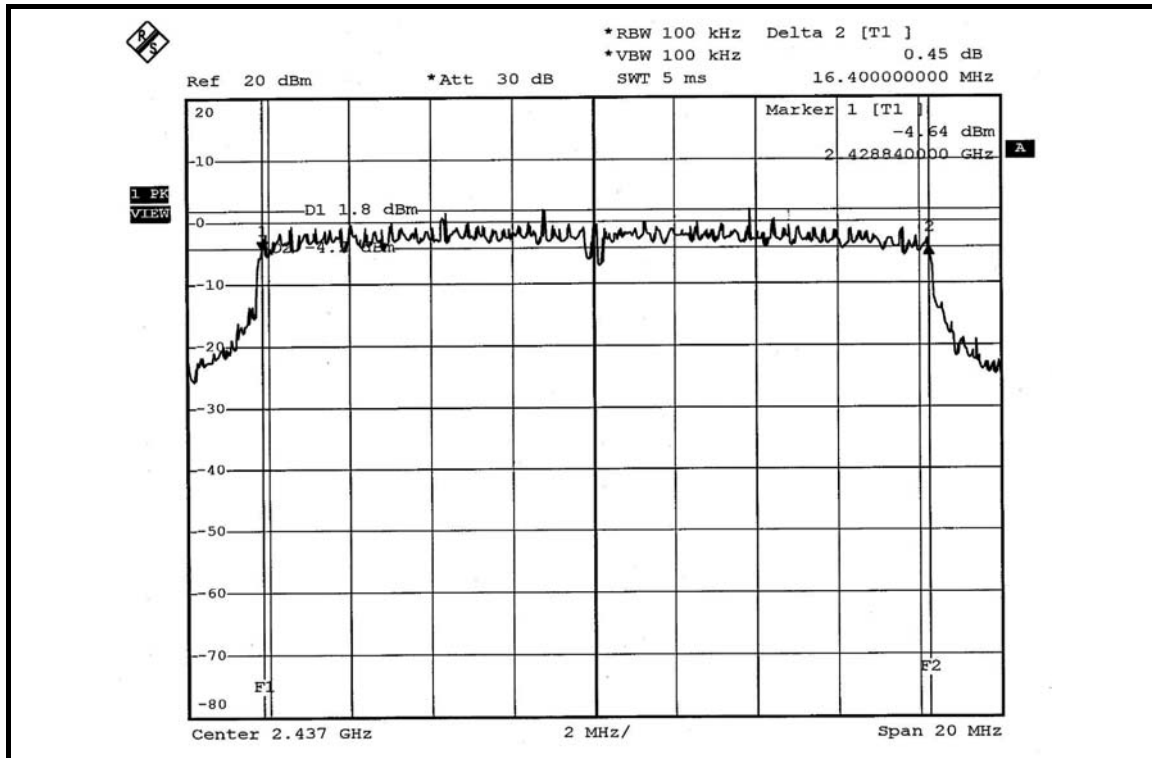

CH 11

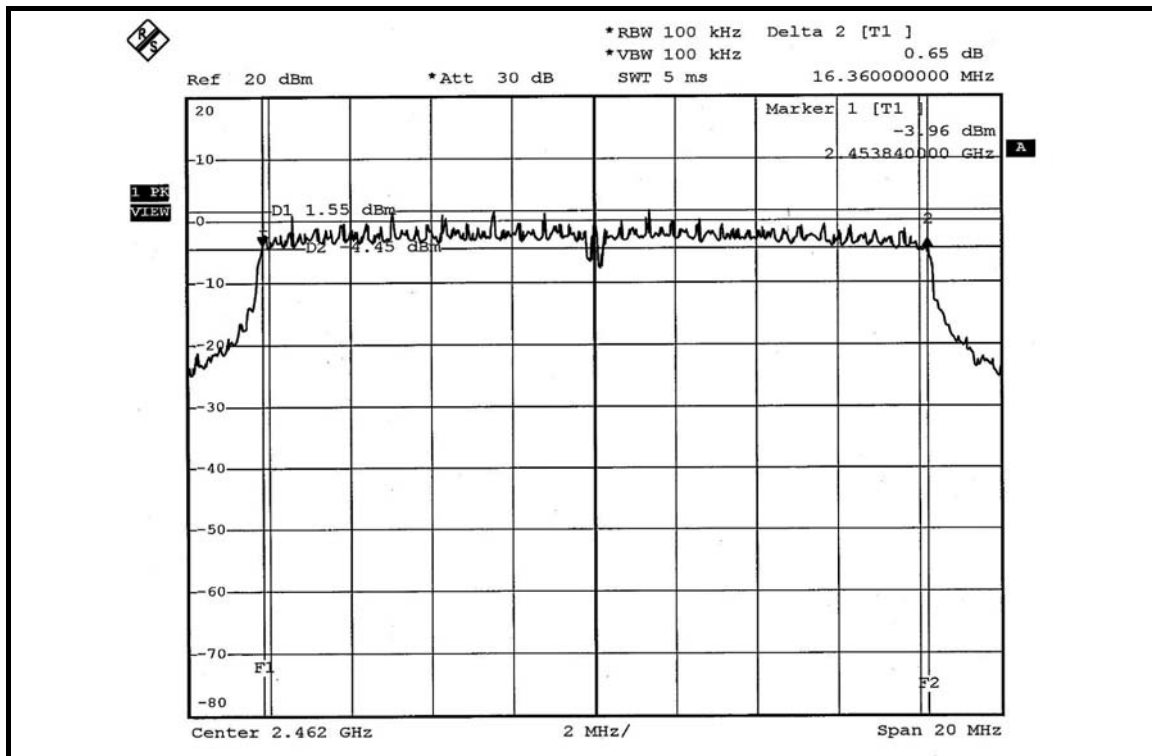

DRAFT 802.11n (20MHz) OFDM MODULATION:

MODULATION TYPE	BPSK	TRANSFER RATE	7.2Mbps
INPUT POWER (SYSTEM)	120Vac, 60 Hz	ENVIRONMENTAL CONDITIONS	25deg.C, 63%RH, 991hPa
TESTED BY	Long Chen		

CHANNEL	CHANNEL FREQUENCY (MHz)	6dB BANDWIDTH (MHz)			MINIMUM LIMIT (MHz)	PASS / FAIL
		CHAIN 0	CHAIN 1	CHAIN 2		
1	2412	17.60	17.60	17.60	0.5	PASS
6	2437	17.64	17.60	17.60	0.5	PASS
11	2462	17.56	17.60	17.60	0.5	PASS

FOR CHAIN 0: CH 1

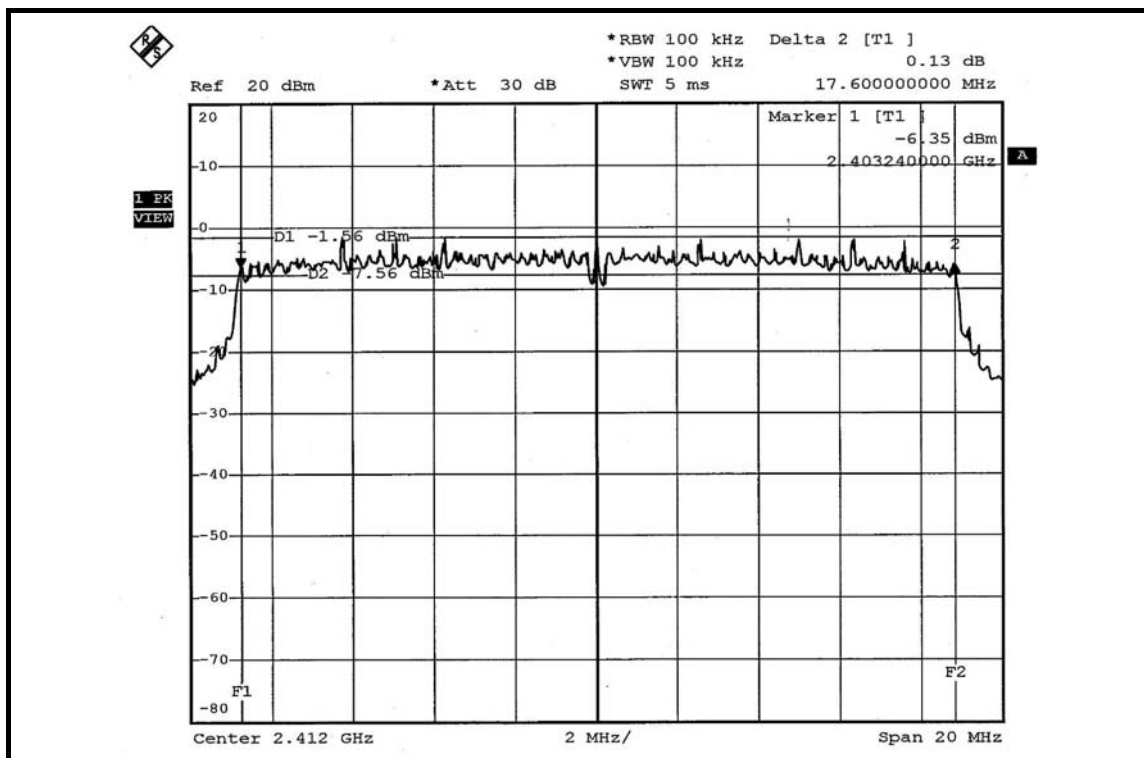

CH 6

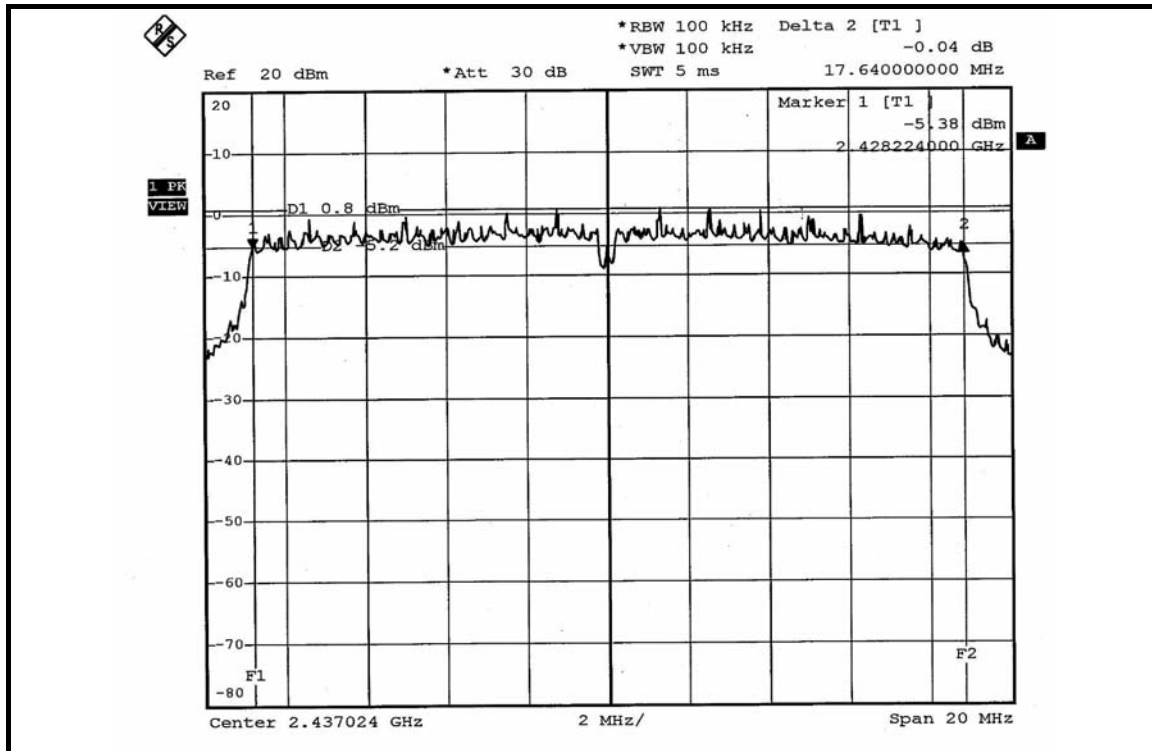

CH 11

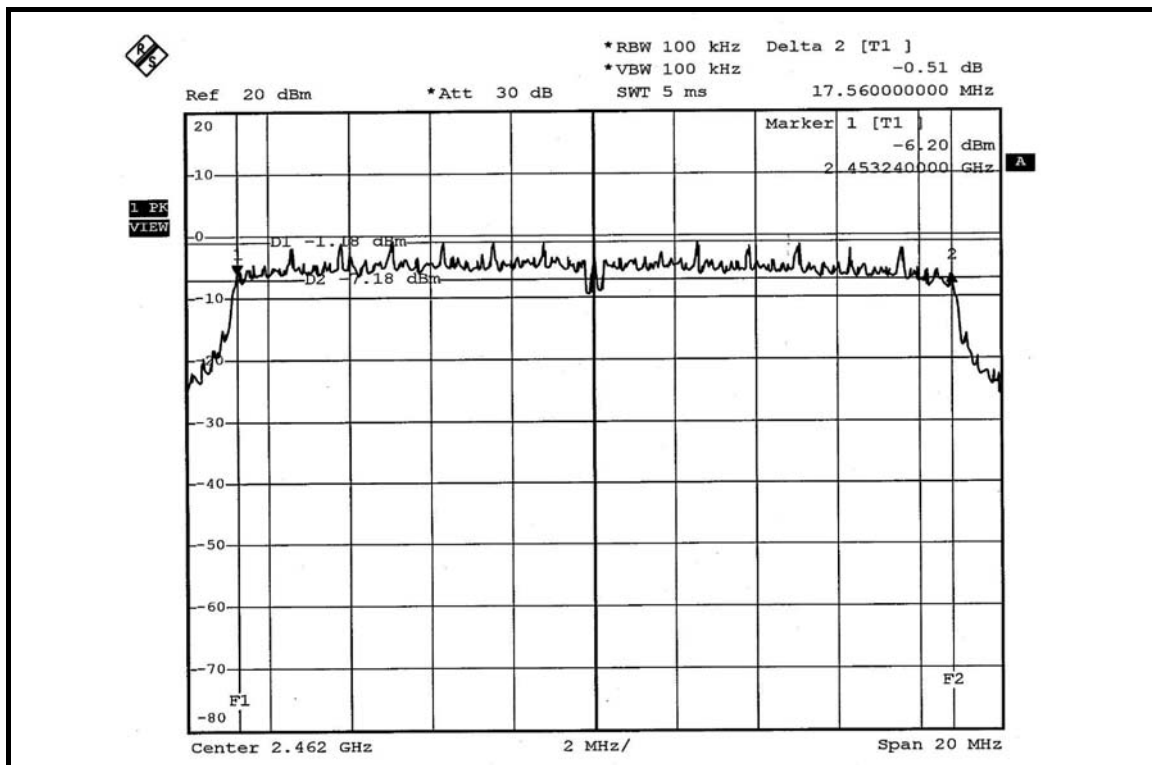

FOR CHAIN 1: CH 1

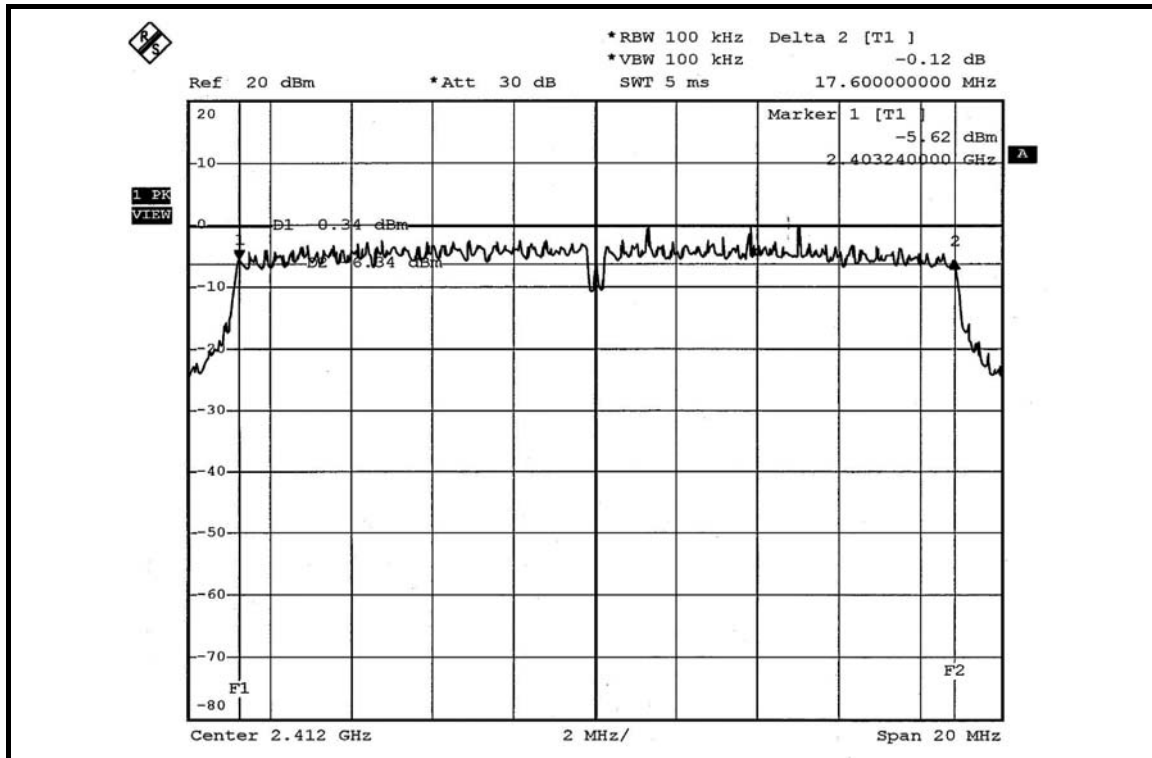

CH 6

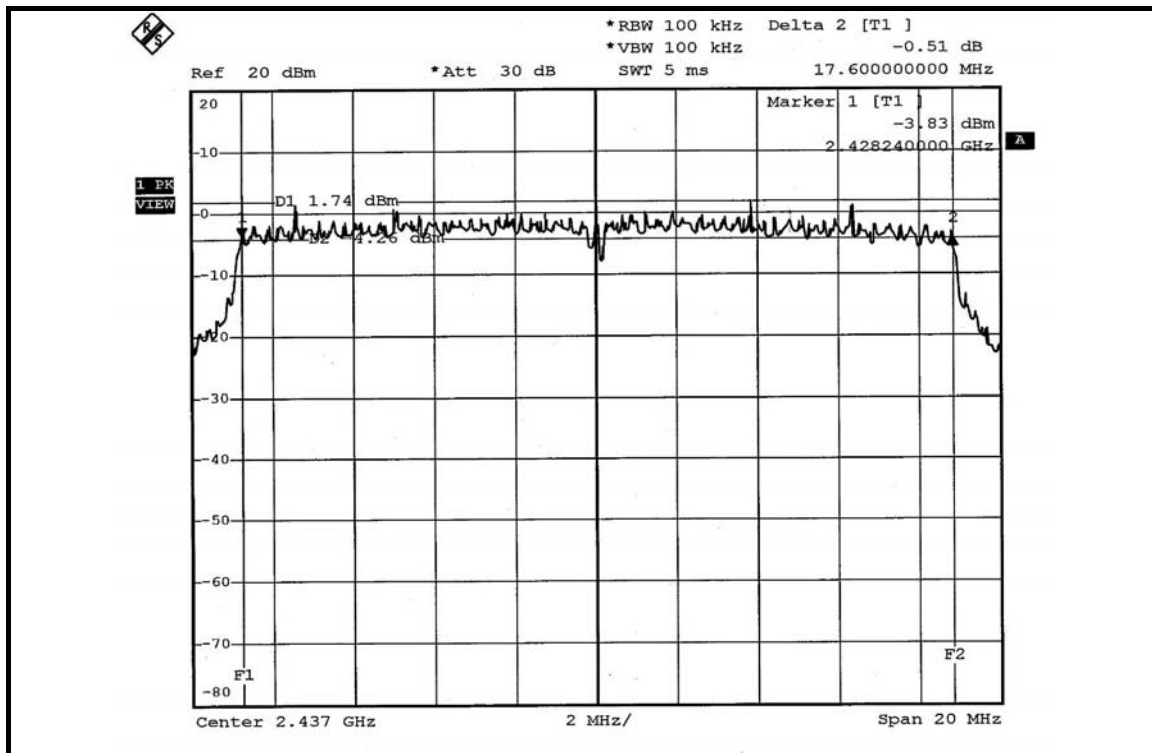

CH 11

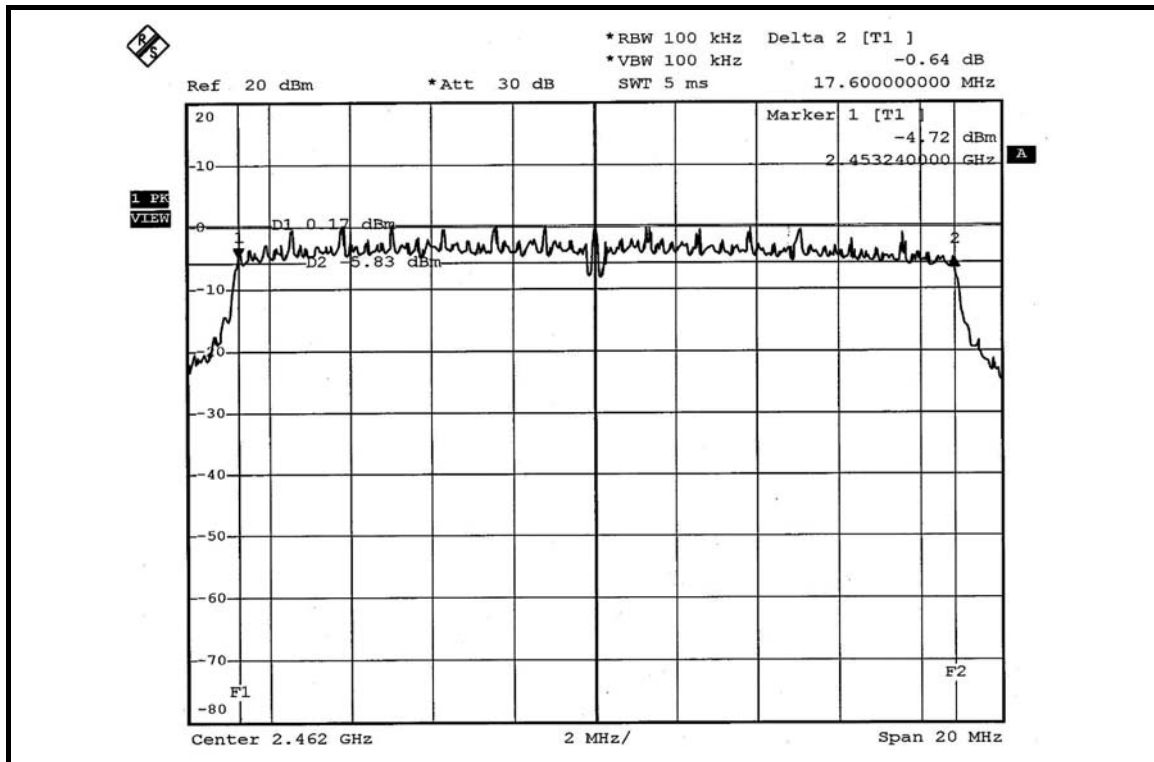

FOR CHAIN 2: CH 1

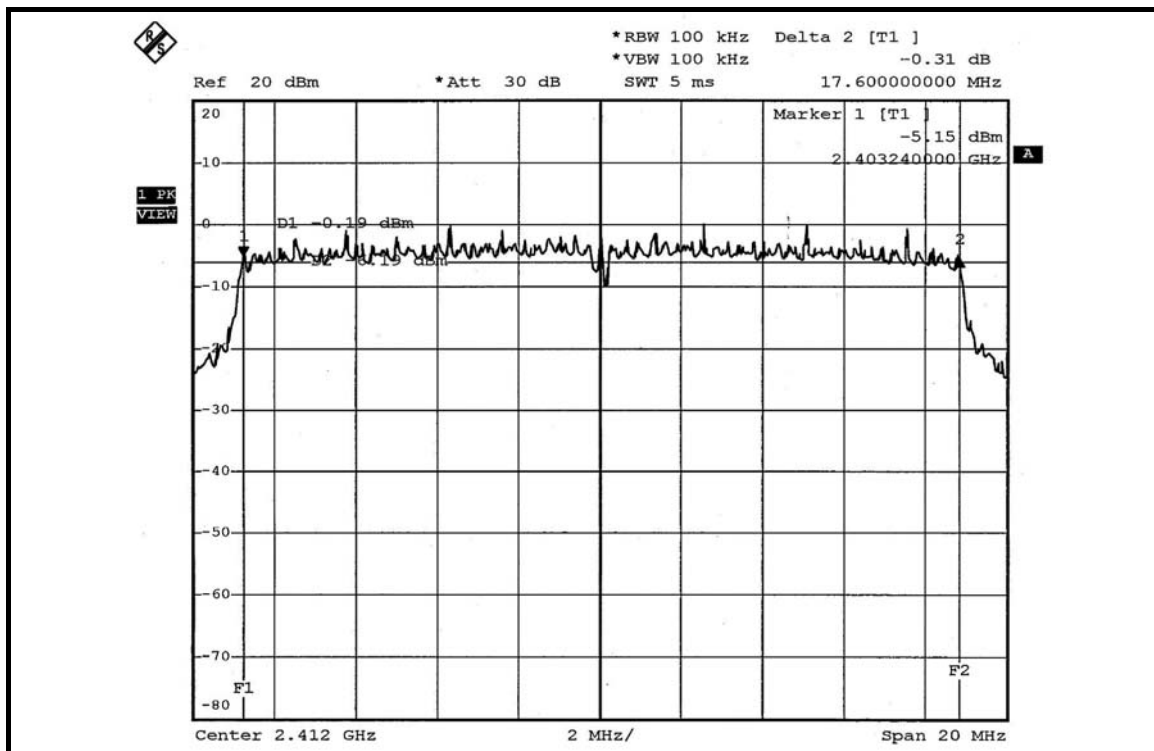

CH 6

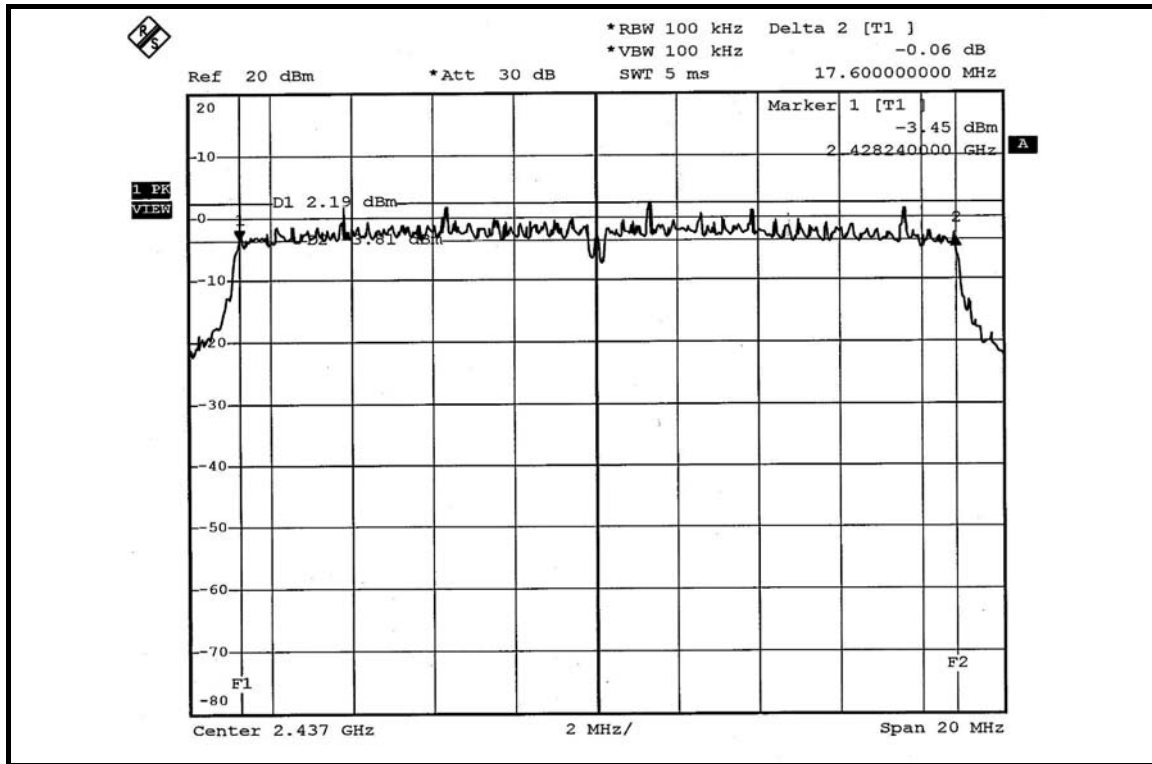

CH 11

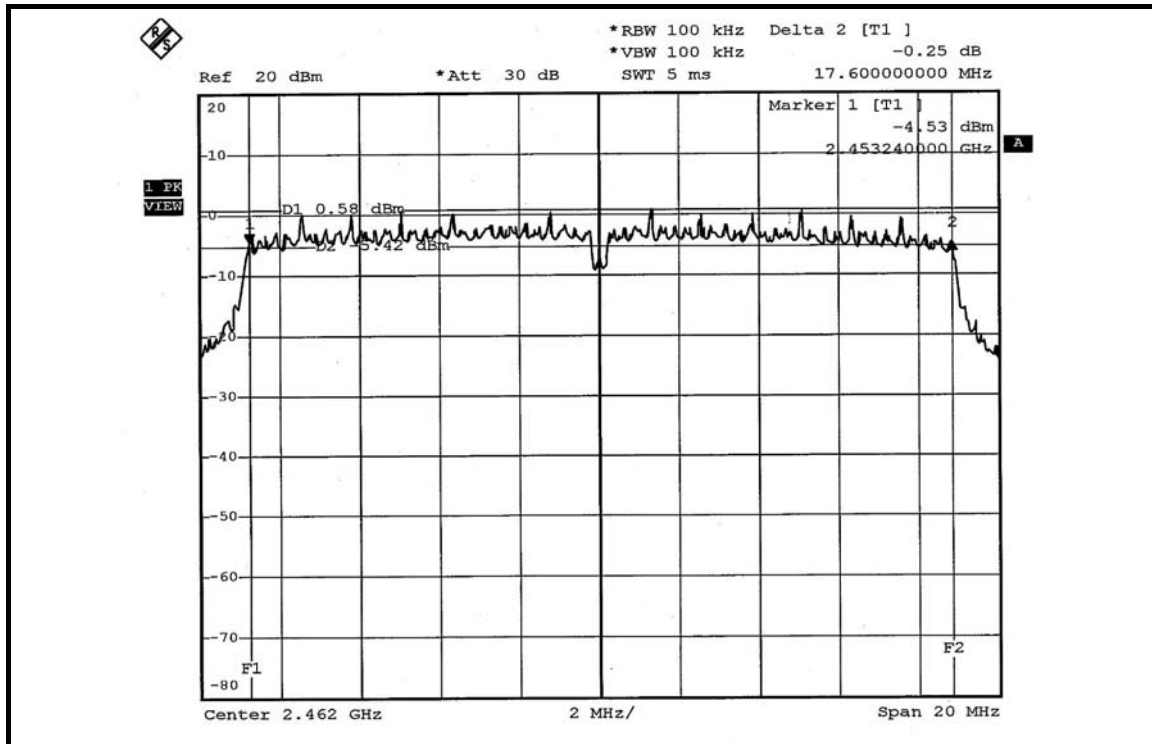

DRAFT 802.11n (40MHz) OFDM MODULATION:

MODULATION TYPE	BPSK	TRANSFER RATE	15.0Mbps
INPUT POWER (SYSTEM)	120Vac, 60 Hz	ENVIRONMENTAL CONDITIONS	25deg.C, 63%RH, 991hPa
TESTED BY	Long Chen		

CHANNEL	CHANNEL FREQUENCY (MHz)	6dB BANDWIDTH (MHz)			MINIMUM LIMIT (MHz)	PASS / FAIL
		CHAIN 0	CHAIN 1	CHAIN 2		
1	2422	35.04	35.04	34.96	0.5	PASS
4	2437	35.12	35.12	35.20	0.5	PASS
7	2452	35.20	35.20	35.12	0.5	PASS

FOR CHAIN 0: CH 1

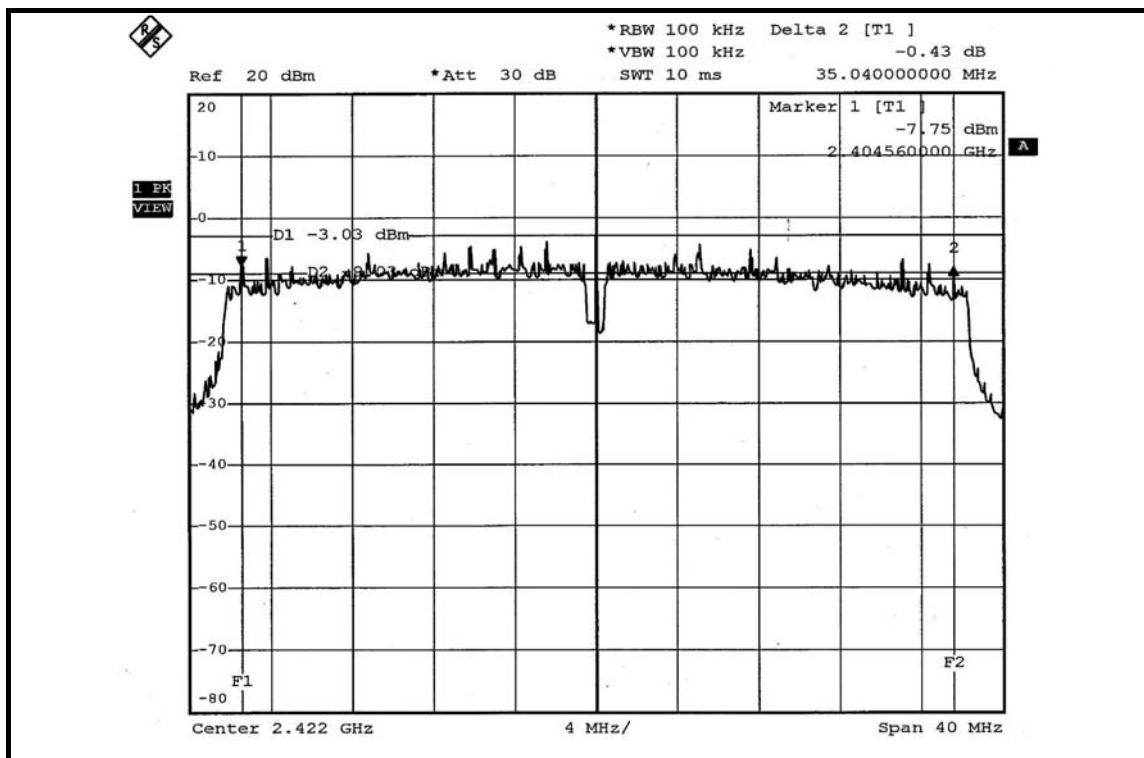

CH 4

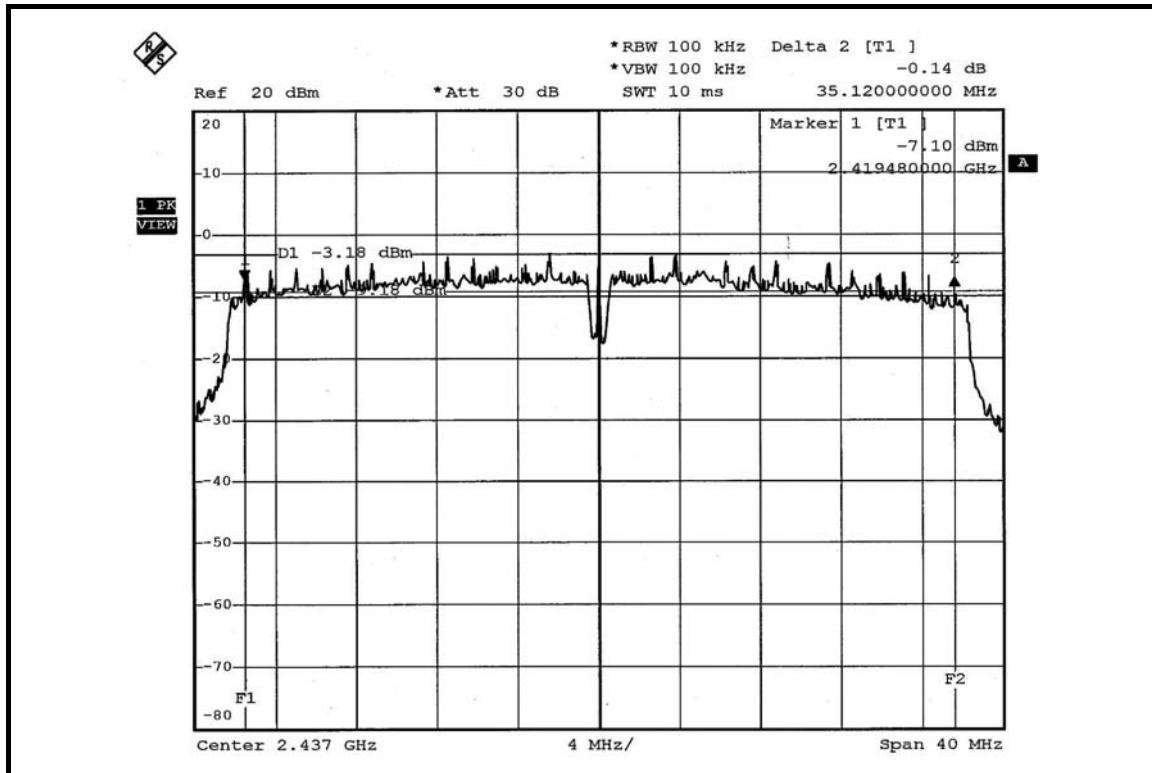

CH 7

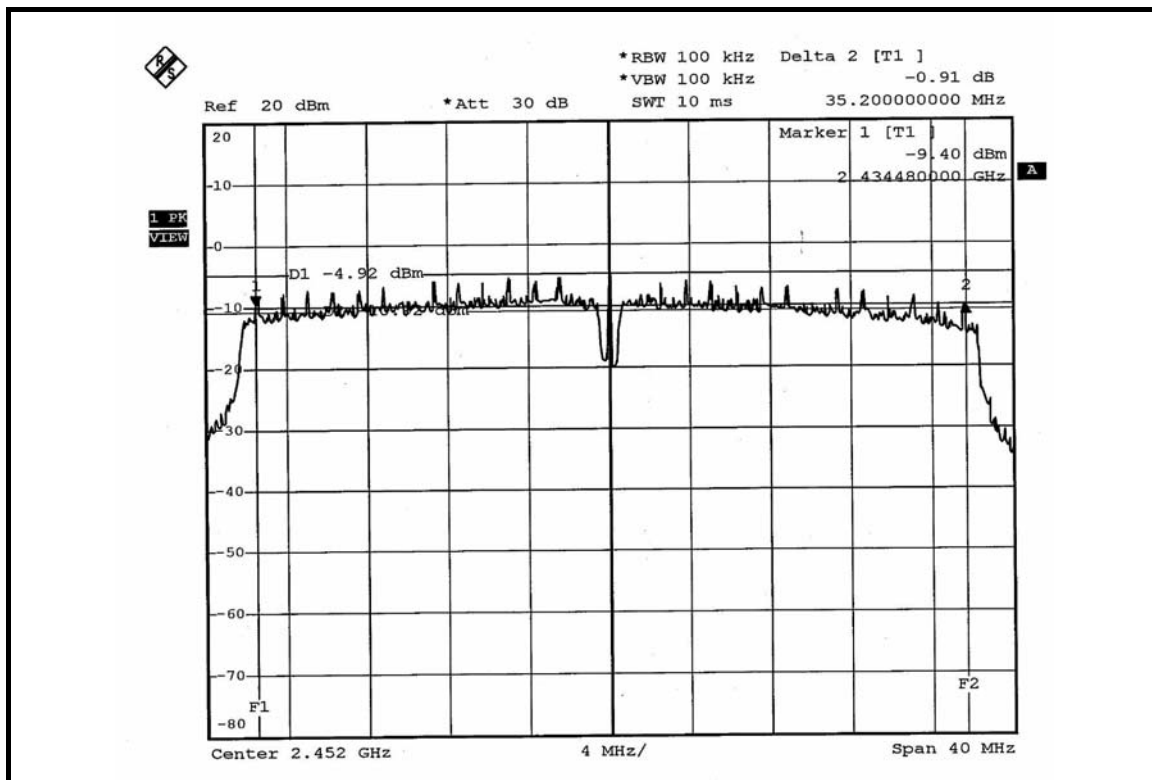

FOR CHAIN 1: CH 1

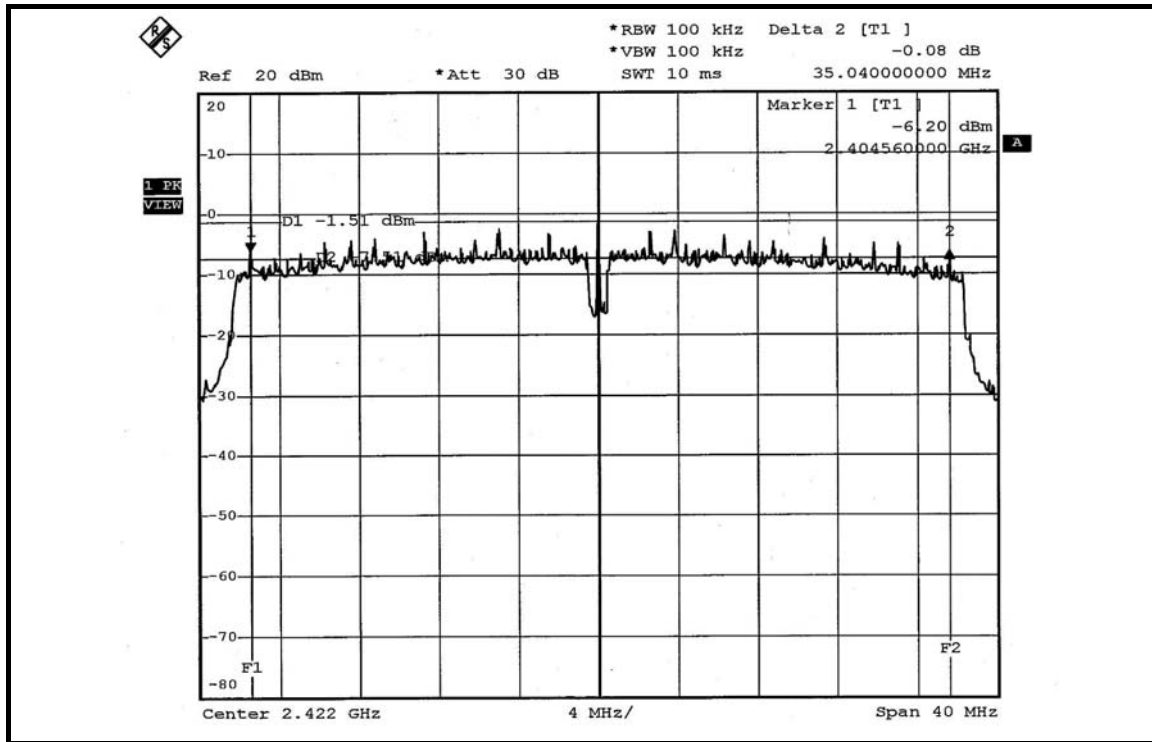

CH 4

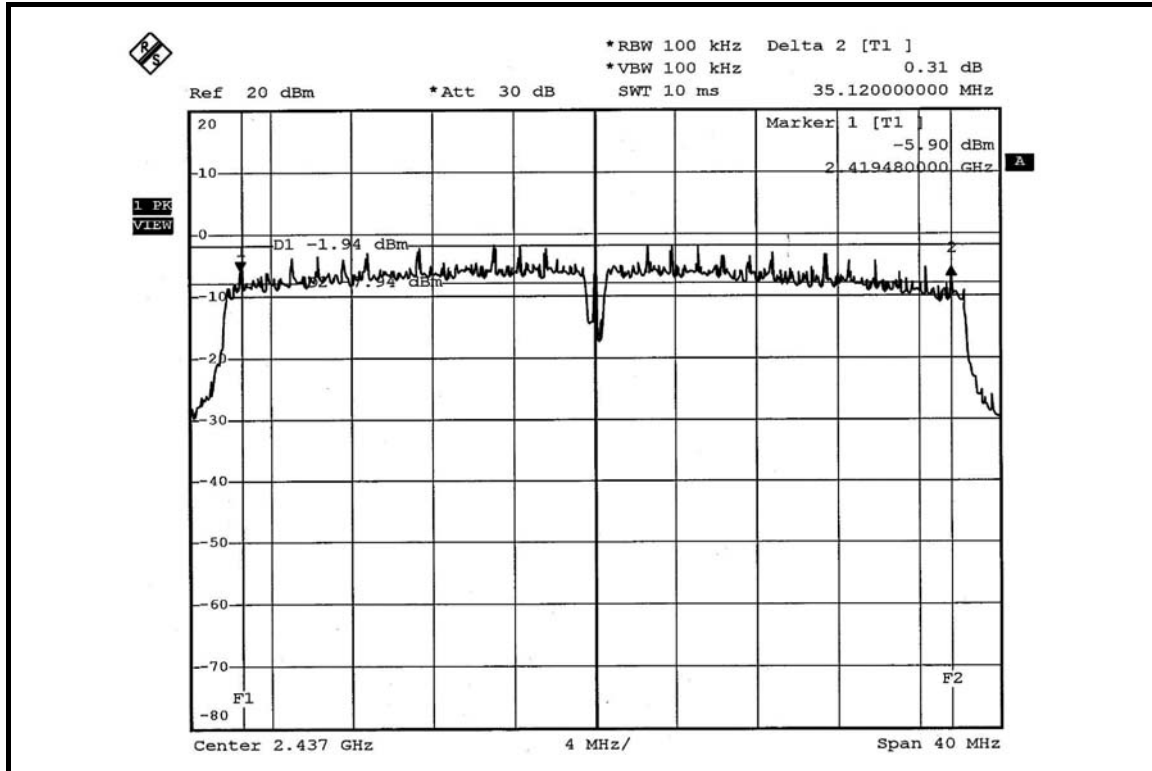

CH 7

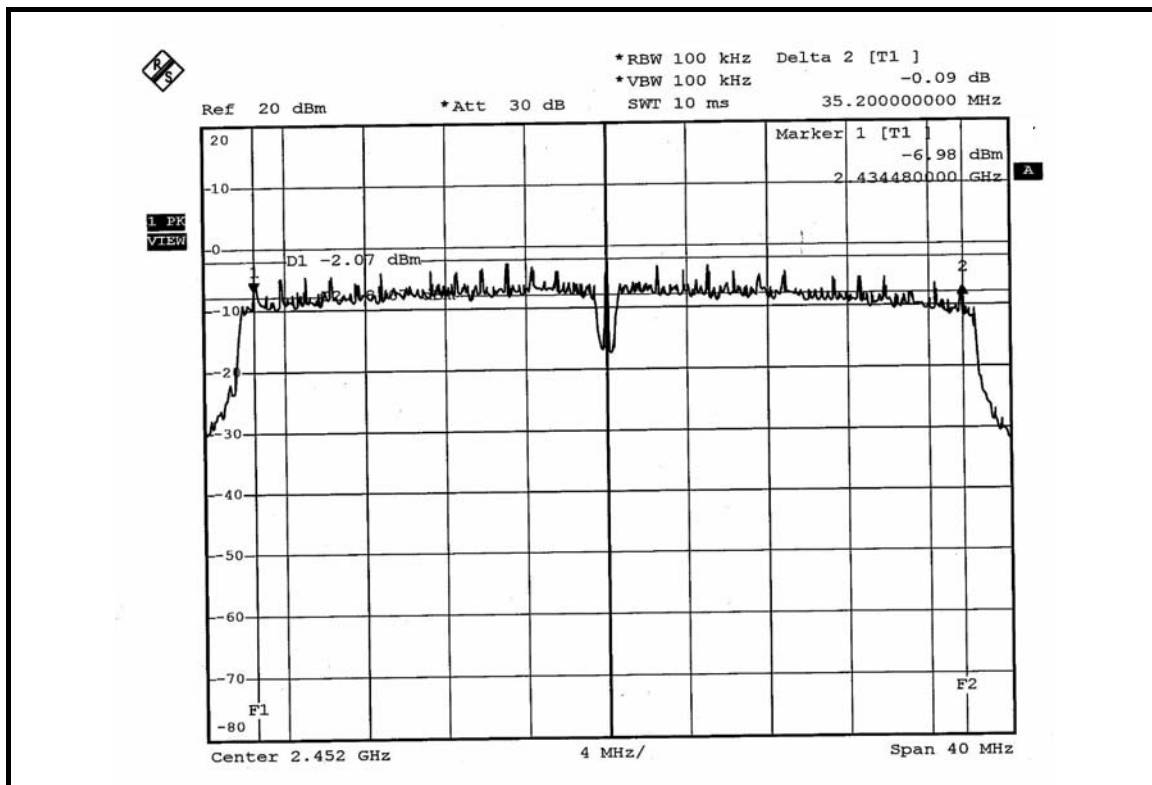

FOR CHAIN 2: CH 1

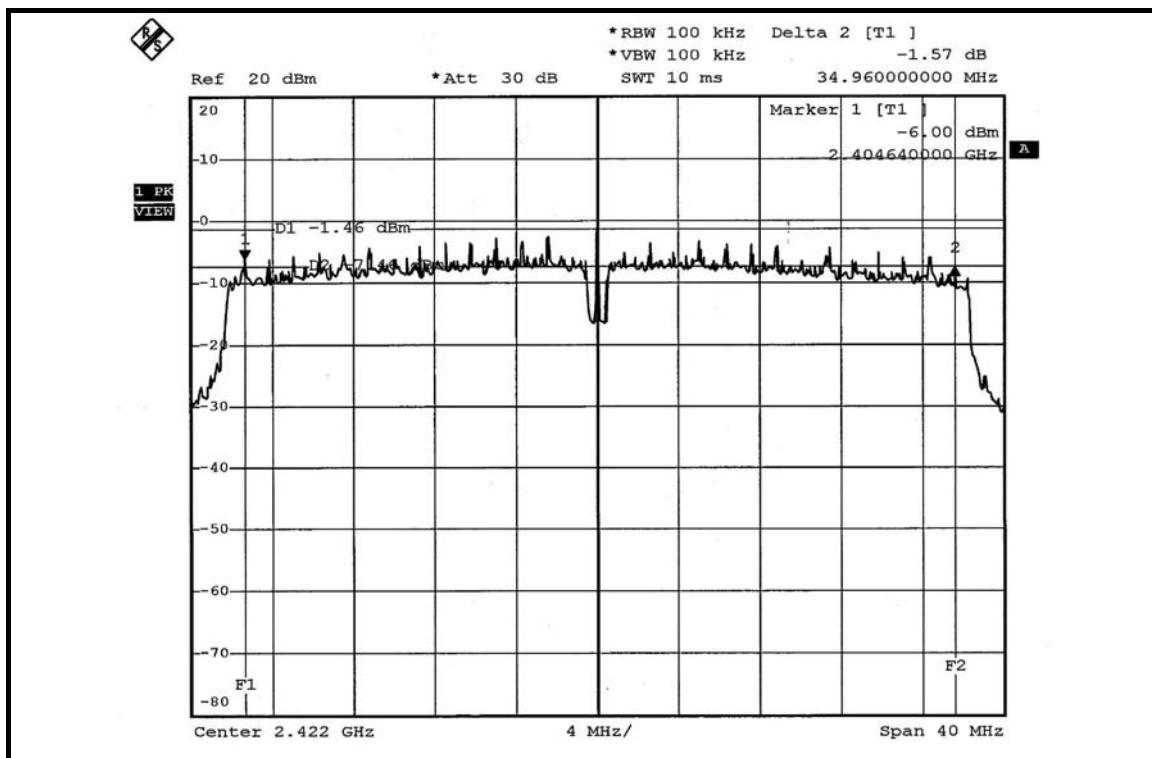

CH 4

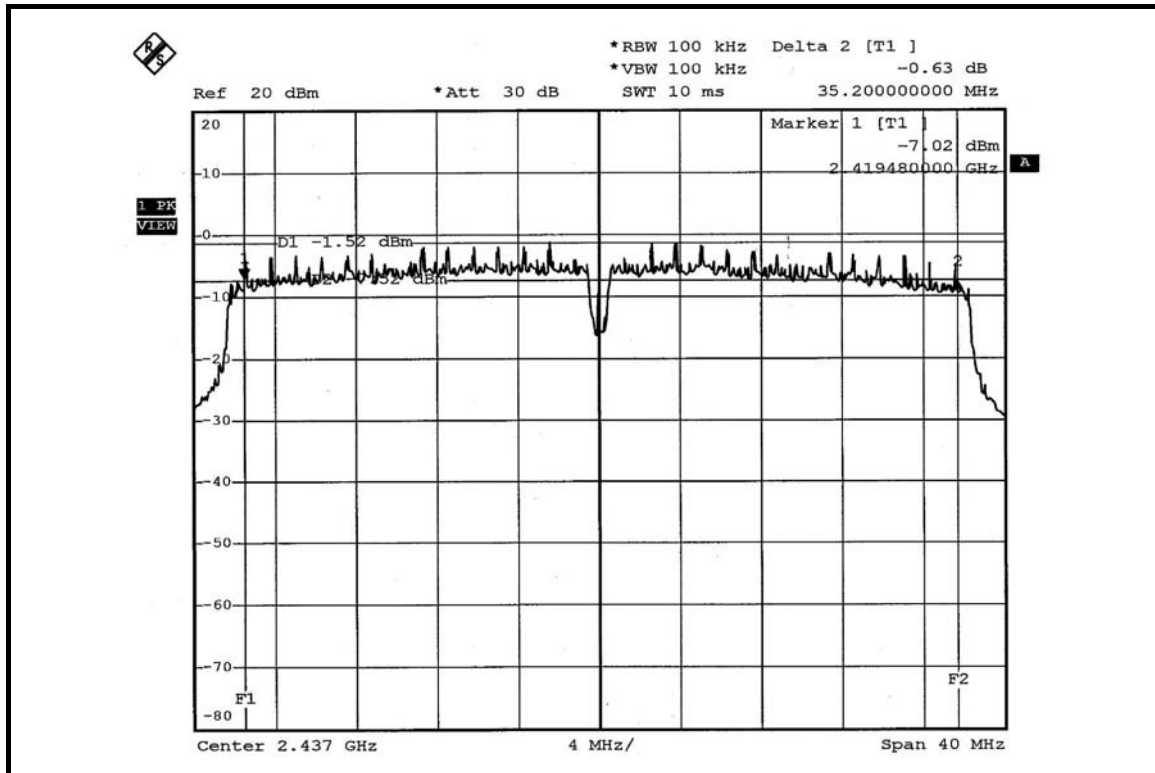

CH 7

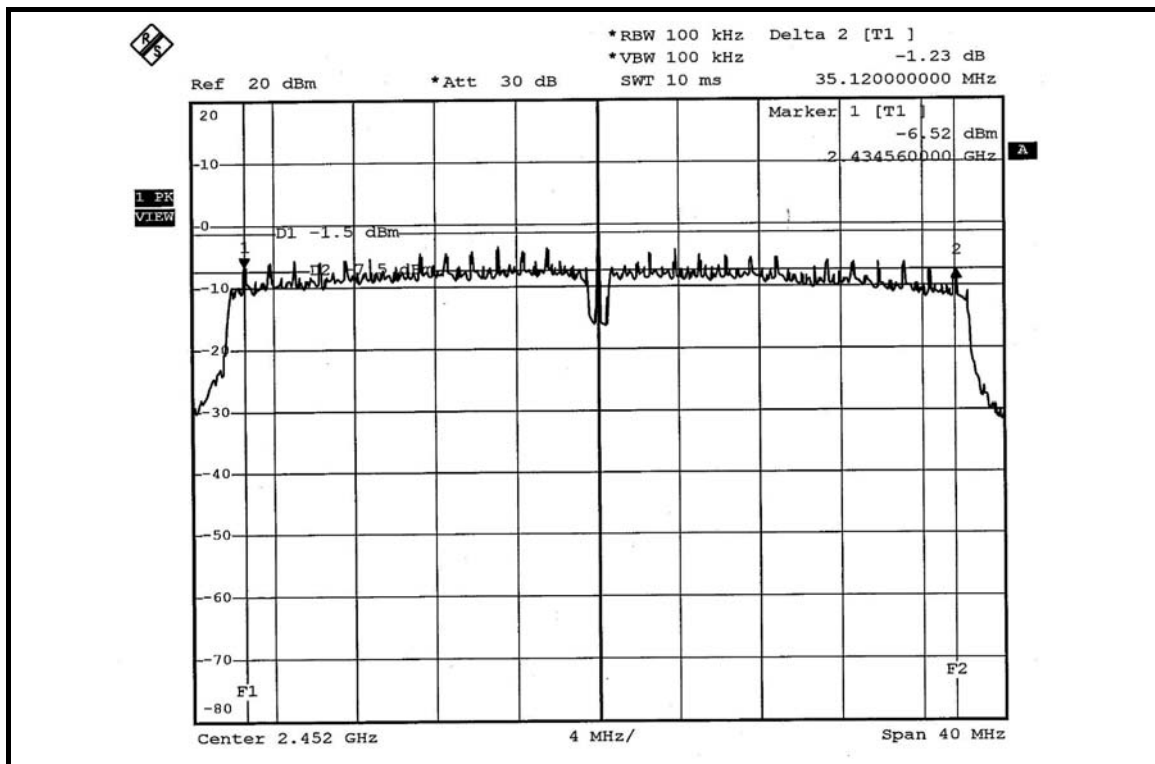



4.4 MAXIMUM PEAK OUTPUT POWER

4.4.1 LIMITS OF MAXIMUM PEAK OUTPUT POWER MEASUREMENT

The Maximum Peak Output Power Measurement is 30dBm.

4.4.2 INSTRUMENTS

DESCRIPTION & MANUFACTURER	MODEL NO.	SERIAL NO.	CALIBRATED UNTIL
R&S SPECTRUM ANALYZER	FSEK30	100049	Aug. 14, 2006
AGILENT SIGNAL GENERATOR	E8257C	MY43320668	Dec. 07, 2006
DIGITAL RT OSCILLOSCOPE	TDS1012	C037299	Nov. 28, 2006
NARDA DETECTOR	4503A	FSCM99899	NA

NOTE: The calibration interval of the above test instruments is 12 months and the calibrations are traceable to NML/ROC and NIST/USA.

4.4.3 TEST PROCEDURES

1. A detector was used on the output port of the EUT. An oscilloscope was used to read the response of the detector.
2. Replaced the EUT by the signal generator. The center frequency of the S.G was adjusted to the center frequency of the measured channel.
3. Adjusted the power to have the same reading on oscilloscope. Record the power level.

4.4.4 DEVIATION FROM TEST STANDARD

No deviation

4.4.5 TEST SETUP

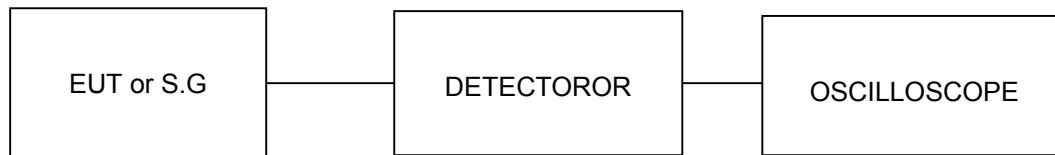

4.4.6 EUT OPERATING CONDITIONS

Same as Item 4.3.6

4.4.7 TEST RESULTS

802.11b DSSS MODULATION:

MODULATION TYPE	DBPSK	TRANSFER RATE	1.0Mbps
INPUT POWER (SYSTEM)	120Vac, 60 Hz	ENVIRONMENTAL CONDITIONS	25deg.C, 63%RH, 991hPa
TESTED BY	Long Chen		

CHAN.	CHANNEL FREQUENCY (MHz)	PEAK POWER OUTPUT (mW)			PEAK POWER OUTPUT (dBm)			TOTAL PEAK POWER (mW)	TOTAL PEAK POWER (dBm)	PEAK POWER LIMIT (dBm)	PASS / FAIL
		CHAIN 0	CHAIN 1	CHAIN 2	CHAIN 0	CHAIN 1	CHAIN 2				
1	2412	50.816	79.433	71.614	17.06	19.00	18.55	201.863	23.05	30	PASS
6	2437	22.594	31.915	31.769	13.54	15.04	15.02	86.278	19.36	30	PASS
11	2462	28.314	35.892	35.727	14.52	15.55	15.53	99.933	20.00	30	PASS

802.11g OFDM MODULATION:

MODULATION TYPE	BPSK	TRANSFER RATE	6.0Mbps
INPUT POWER (SYSTEM)	120Vac, 60 Hz	ENVIRONMENTAL CONDITIONS	25deg.C, 63%RH, 991hPa
TESTED BY	Long Chen		

CHAN.	CHANNEL FREQUENCY (MHz)	PEAK POWER OUTPUT (mW)			PEAK POWER OUTPUT (dBm)			TOTAL PEAK POWER (mW)	TOTAL PEAK POWER (dBm)	PEAK POWER LIMIT (dBm)	PASS / FAIL
		CHAIN 0	CHAIN 1	CHAIN 2	CHAIN 0	CHAIN 1	CHAIN 2				
1	2412	50.582	63.973	57.280	17.04	18.06	17.58	171.836	22.35	30	PASS
6	2437	63.533	79.799	70.958	18.03	19.02	18.51	214.290	23.31	30	PASS
11	2462	45.290	63.533	64.269	16.56	18.03	18.08	173.092	22.38	30	PASS

DRAFT 802.11n (20MHz) OFDM MODULATION:

MODULATION TYPE	BPSK	TRANSFER RATE	7.2Mbps
INPUT POWER (SYSTEM)	120Vac, 60 Hz	ENVIRONMENTAL CONDITIONS	25deg.C, 63%RH, 991hPa
TESTED BY	Long Chen		

CHAN.	CHANNEL FREQUENCY (MHz)	PEAK POWER OUTPUT (mW)			PEAK POWER OUTPUT (dBm)			TOTAL PEAK POWER (mW)	TOTAL PEAK POWER (dBm)	PEAK POWER LIMIT (dBm)	PASS / FAIL
		CHAIN 0	CHAIN 1	CHAIN 2	CHAIN 0	CHAIN 1	CHAIN 2				
1	2412	35.645	50.350	50.350	15.52	17.02	17.02	136.345	21.35	30	PASS
6	2437	50.350	71.614	71.450	17.02	18.55	18.54	193.414	22.86	30	PASS
11	2462	40.644	56.234	57.280	16.09	17.50	17.58	154.158	21.88	30	PASS

DRAFT 802.11n (40MHz) OFDM MODULATION:

MODULATION TYPE	BPSK	TRANSFER RATE	15.0Mbps
INPUT POWER (SYSTEM)	120Vac, 60 Hz	ENVIRONMENTAL CONDITIONS	25deg.C, 63%RH, 991hPa
TESTED BY	Long Chen		

CHAN.	CHANNEL FREQUENCY (MHz)	PEAK POWER OUTPUT (mW)			PEAK POWER OUTPUT (dBm)			TOTAL PEAK POWER (mW)	TOTAL PEAK POWER (dBm)	PEAK POWER LIMIT (dBm)	PASS / FAIL
		CHAIN 0	CHAIN 1	CHAIN 2	CHAIN 0	CHAIN 1	CHAIN 2				
1	2422	20.324	28.184	25.468	13.08	14.50	14.06	73.976	18.69	30	PASS
4	2437	28.445	35.727	35.645	14.54	15.53	15.52	99.817	19.99	30	PASS
7	2452	17.824	25.468	25.527	12.51	14.06	14.07	68.819	18.38	30	PASS



4.5 POWER SPECTRAL DENSITY MEASUREMENT

4.5.1 LIMITS OF POWER SPECTRAL DENSITY MEASUREMENT

The Maximum of Power Spectral Density Measurement is 8dBm.

4.5.2 TEST INSTRUMENTS

DESCRIPTION & MANUFACTURER	MODEL NO.	SERIAL NO.	CALIBRATED UNTIL
R&S SPECTRUM ANALYZER	FSEK30	100049	Aug. 14, 2006

NOTE: The calibration interval of the above test instruments is 12 months and the calibrations are traceable to NML/ROC and NIST/USA.

4.5.3 TEST PROCEDURE

The transmitter output was connected to the spectrum analyzer through an attenuator, the bandwidth of the fundamental frequency was measured with the spectrum analyzer using 3kHz RBW and 30kHz VBW, set sweep time = span/3kHz. The power spectral density was measured and recorded.

The sweep time is allowed to be longer than span/3kHz for a full response of the mixer in the spectrum analyzer.

4.5.4 DEVIATION FROM TEST STANDARD

No deviation

4.5.5 TEST SETUP

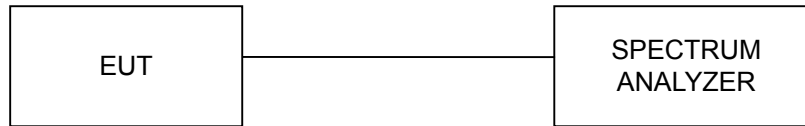

4.5.6 EUT OPERATING CONDITION

Same as Item 4.3.6

4.5.7 TEST RESULTS

802.11b DSSS MODULATION:

MODULATION TYPE	DBPSK	TRANSFER RATE	1.0Mbps
INPUT POWER (SYSTEM)	120Vac, 60 Hz	ENVIRONMENTAL CONDITIONS	25deg.C, 63%RH, 991hPa
TESTED BY	Long Chen		

CHANNEL	CHANNEL FREQUENCY (MHz)	RF POWER LEVEL IN 3kHz BW (dBm)			MAXIMUM LIMIT (dBm)	PASS / FAIL
		CHAIN 0	CHAIN 1	CHAIN 2		
1	2412	-4.57	-0.05	-0.39	8	PASS
6	2437	-7.94	-4.19	-4.24	8	PASS
11	2462	-6.76	-3.59	-3.67	8	PASS

FOR CHAIN 0: CH 1

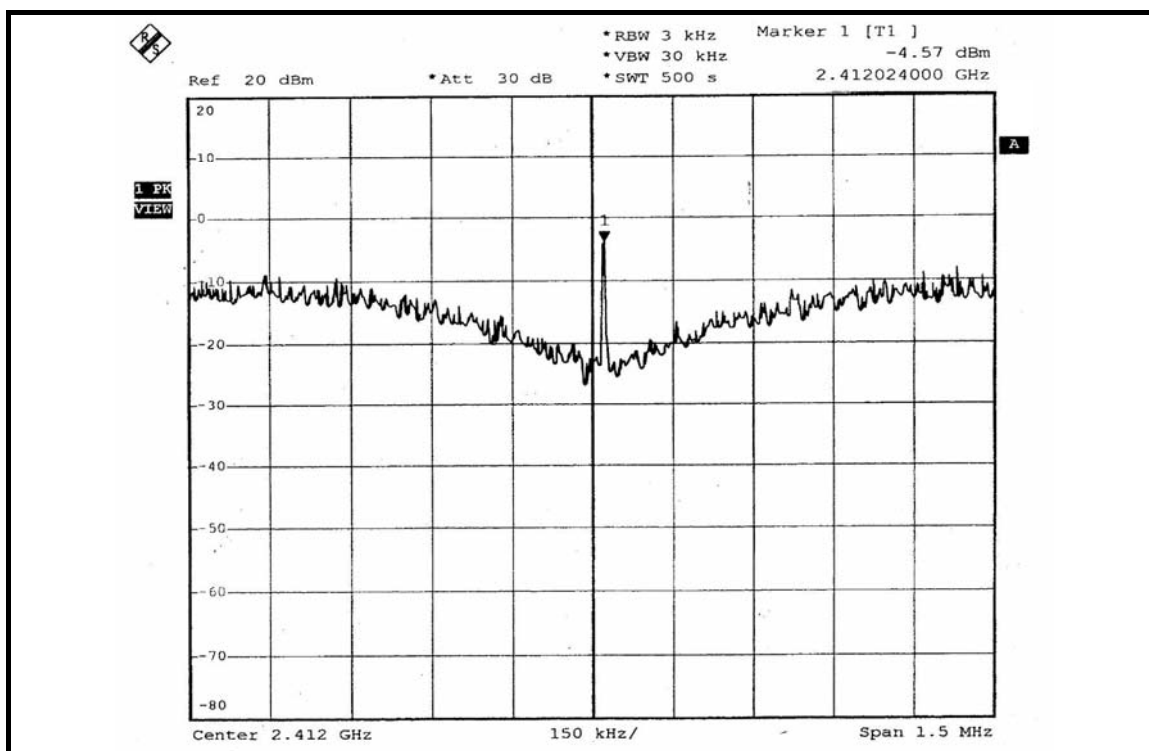

CH 6

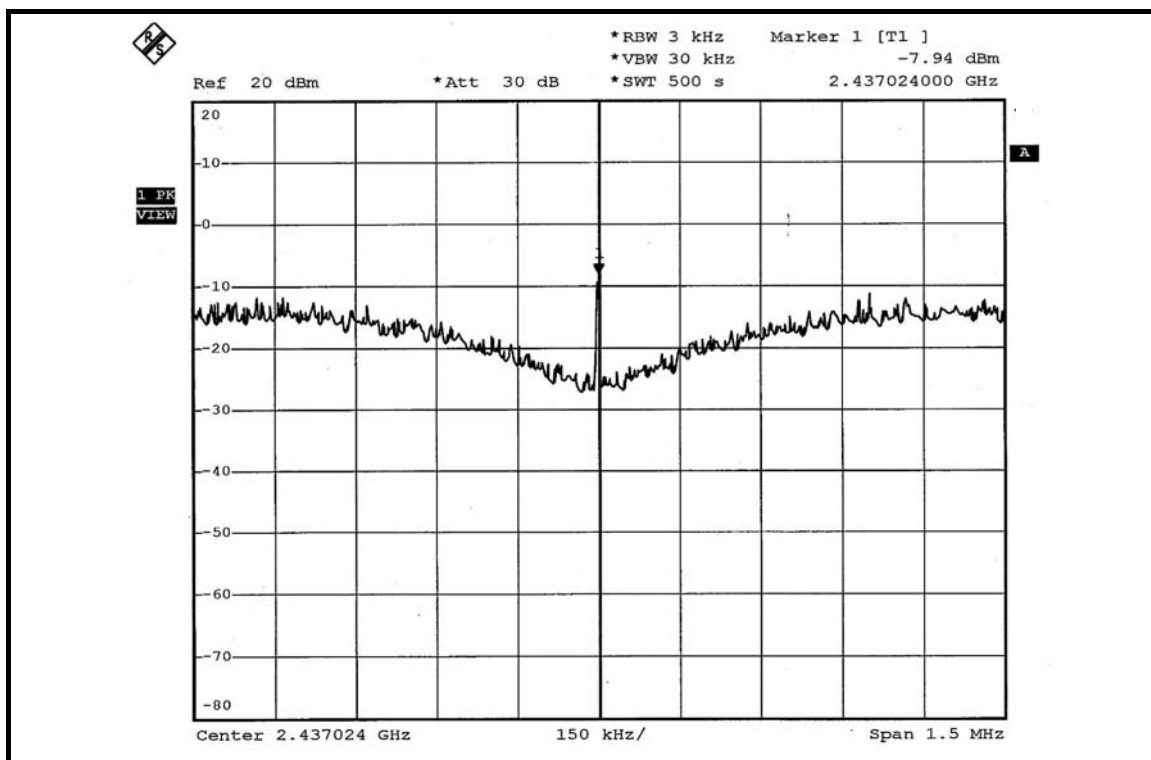

CH 11

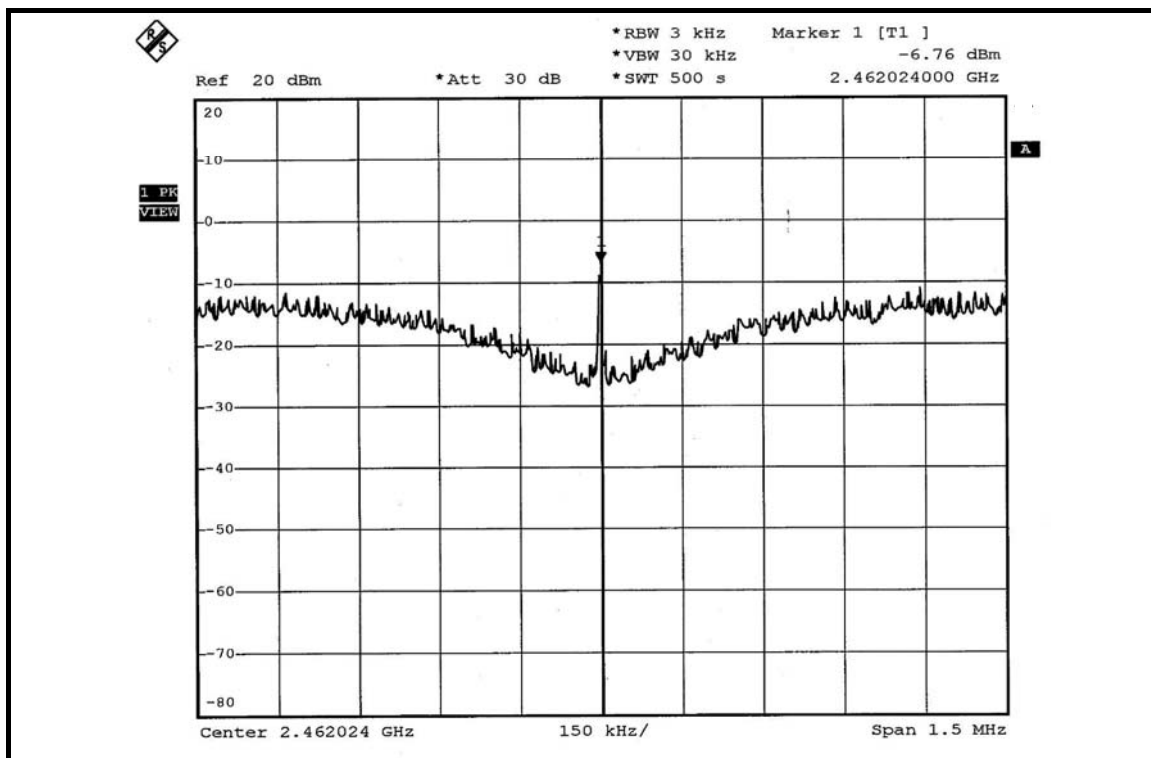

FOR CHAIN 1: CH 1

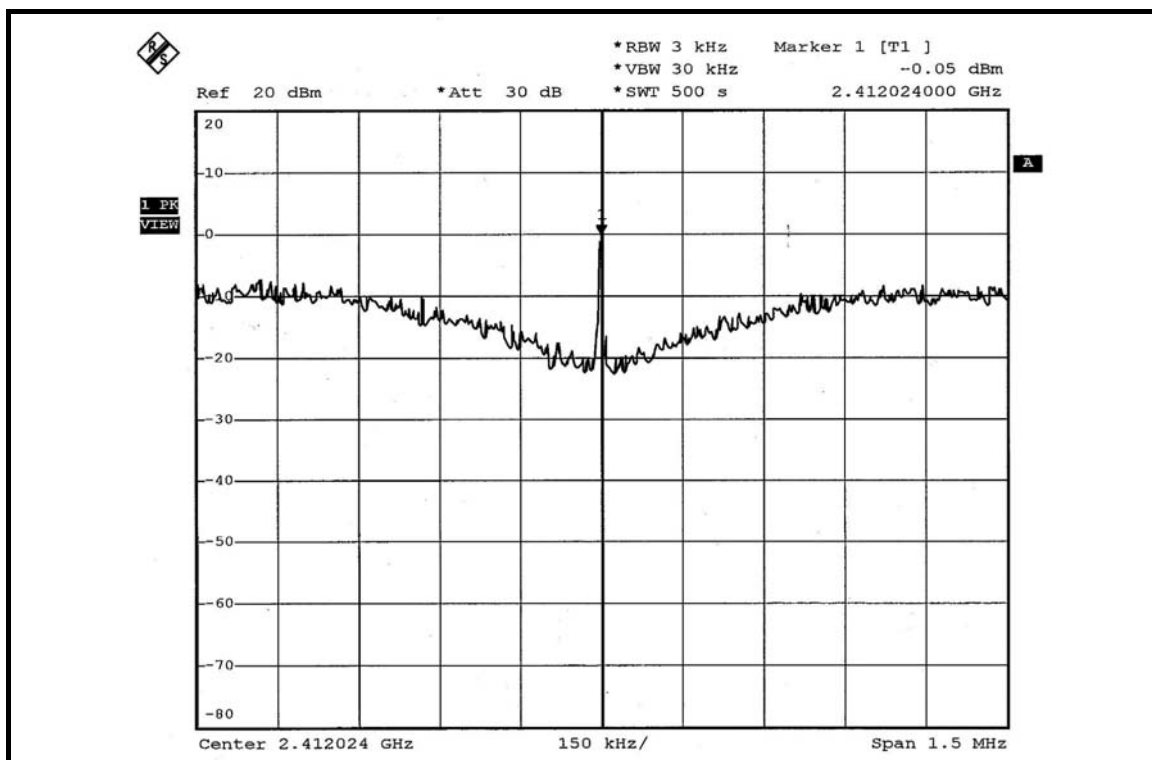

CH 6

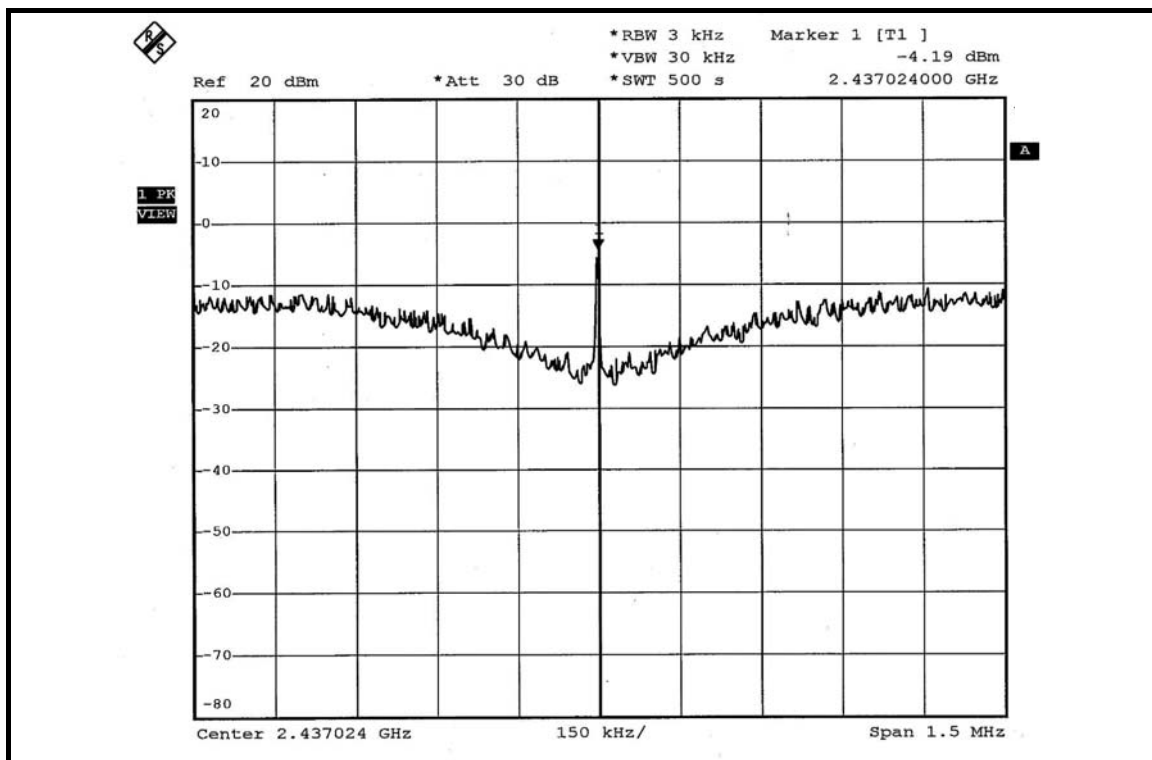

CH 11

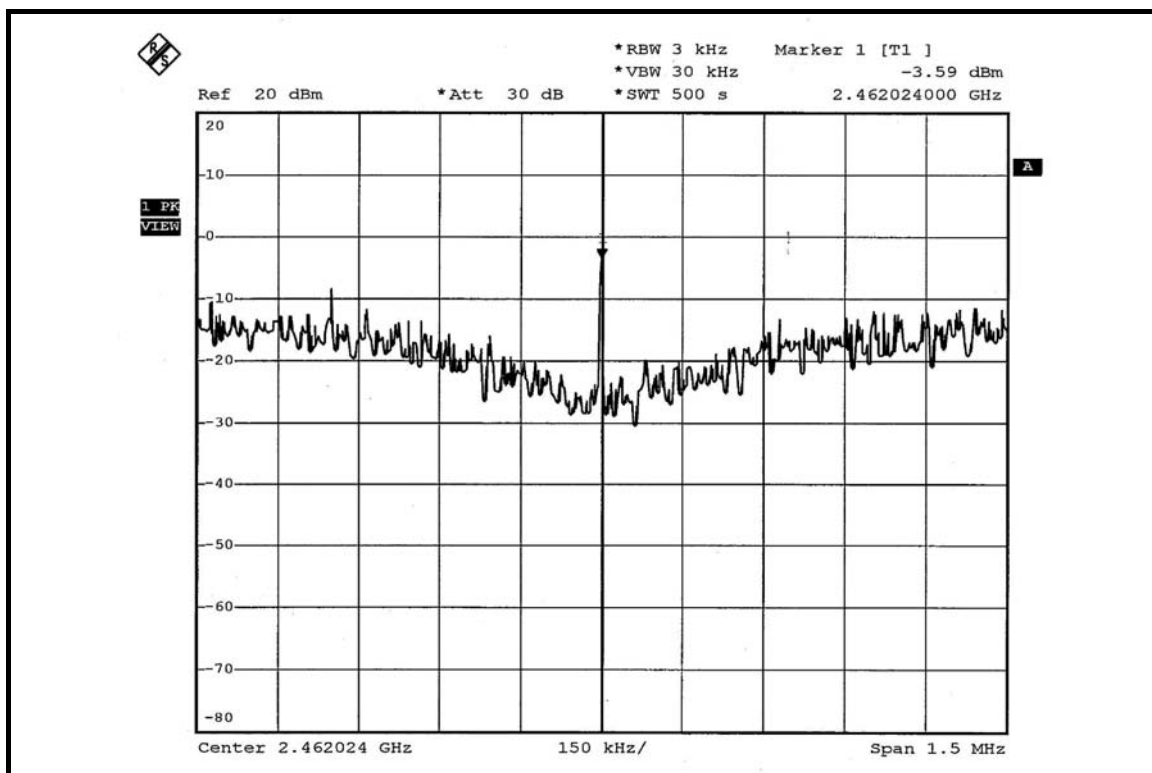

FOR CHAIN 2: CH 1

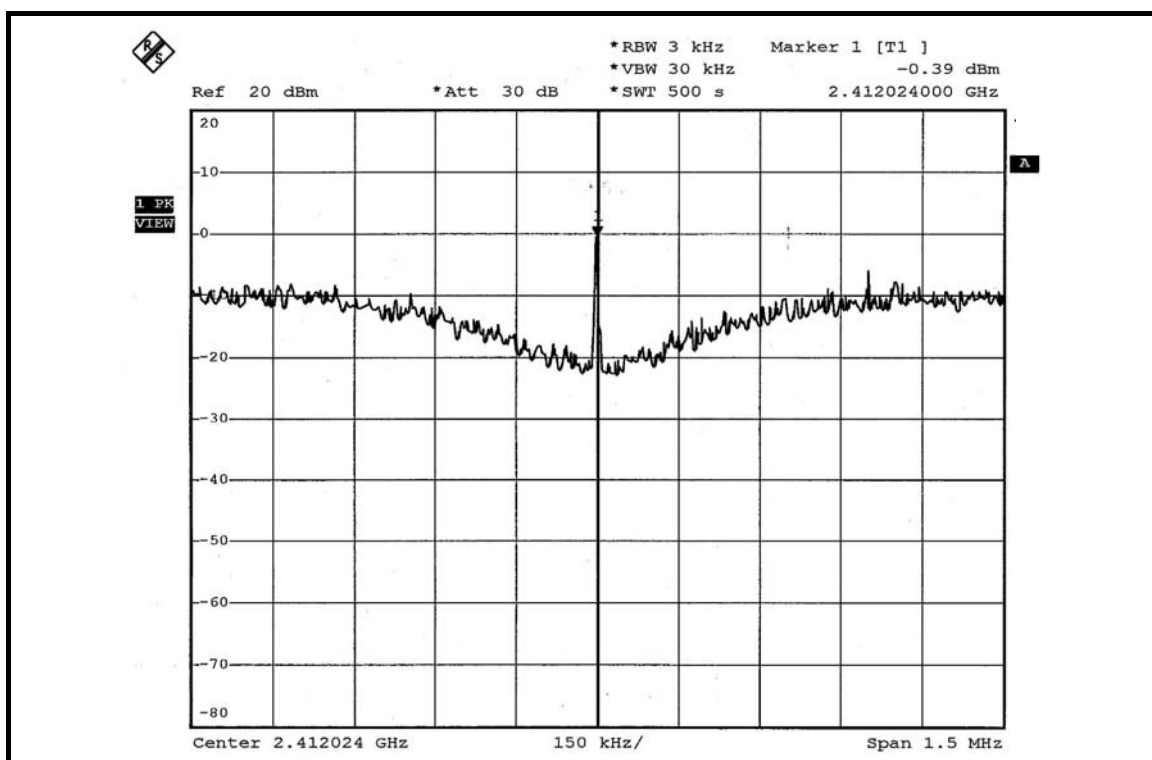

CH 6

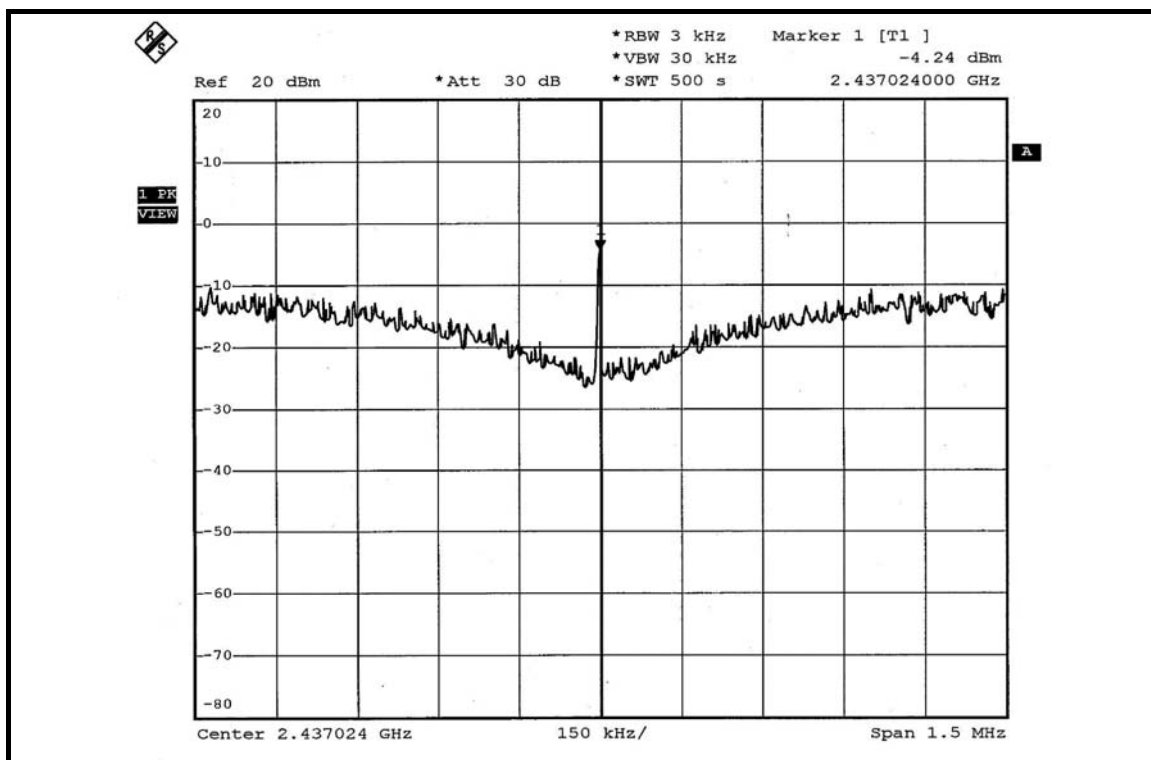

CH 11

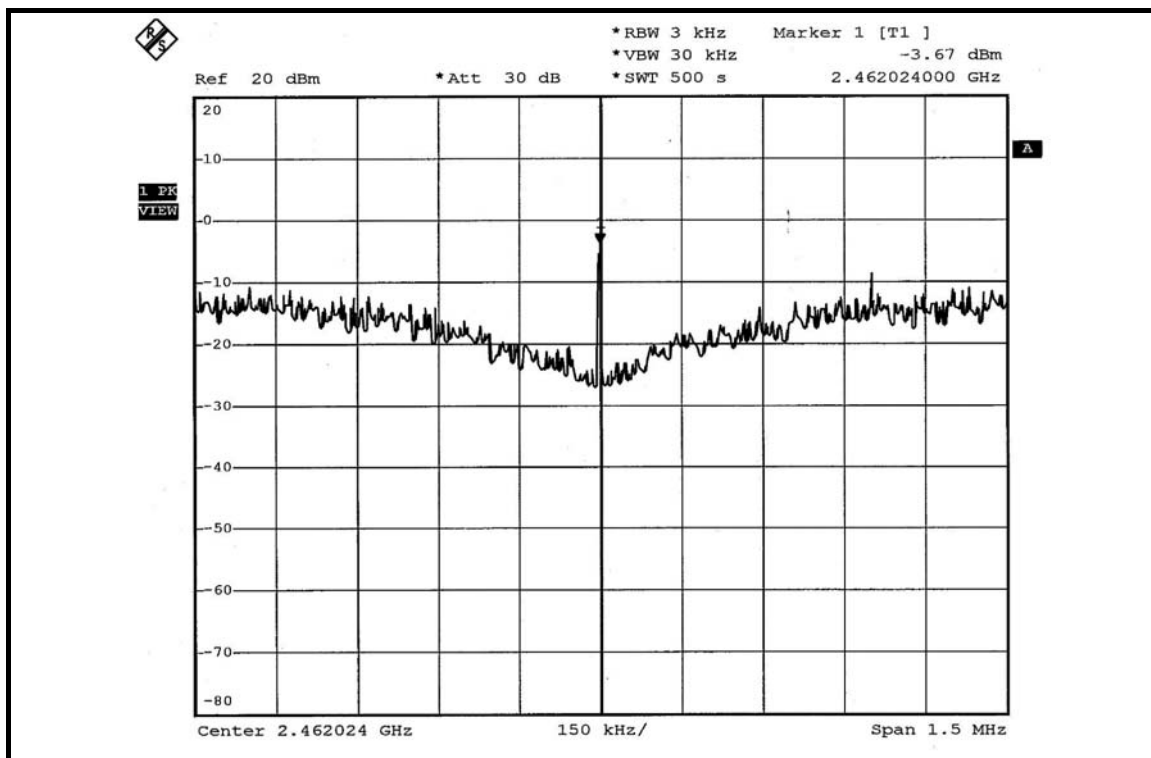

802.11g OFDM MODULATION:

MODULATION TYPE	BPSK	TRANSFER RATE	6.0Mbps
INPUT POWER (SYSTEM)	120Vac, 60 Hz	ENVIRONMENTAL CONDITIONS	25deg.C, 63%RH, 991hPa
TESTED BY	Long Chen		

CHANNEL	CHANNEL FREQUENCY (MHz)	RF POWER LEVEL IN 3kHz BW (dBm)			MAXIMUM LIMIT (dBm)	PASS / FAIL
		CHAIN 0	CHAIN 1	CHAIN 2		
1	2412	-4.03	-2.14	-3.54	8	PASS
6	2437	-3.37	-1.45	-2.35	8	PASS
11	2462	-4.76	-2.24	-2.77	8	PASS

FOR CHAIN 0: CH 1

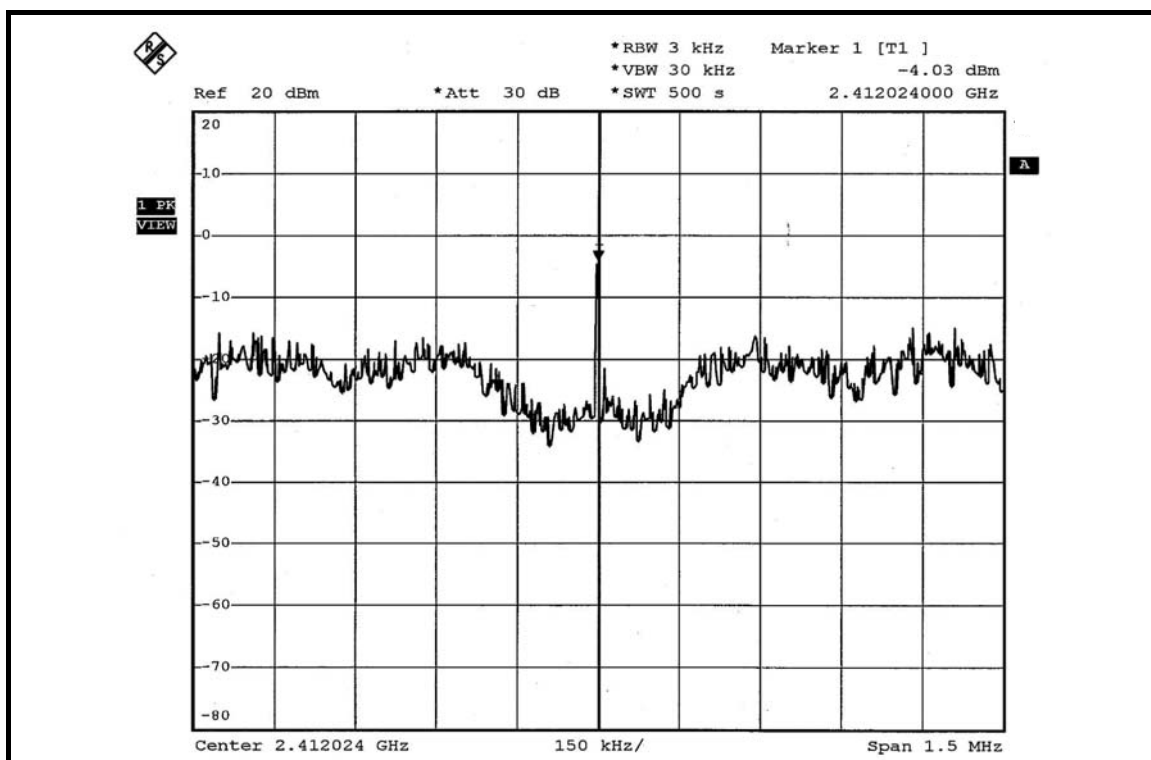

CH 6

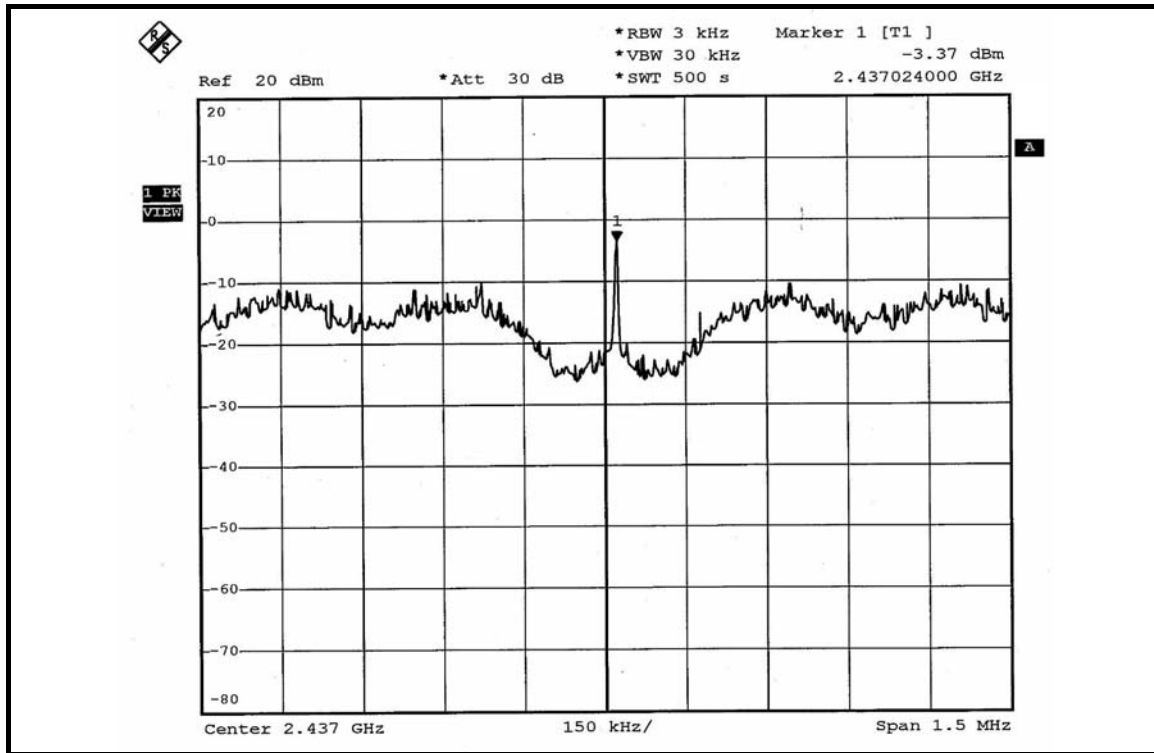

CH 11

