

FCC TEST REPORT

according to

FCC Rules and Regulations

Part 15 Subpart C

Applicant	Belkin Corporation
Address	501 West Walnut Street, Compton CA 90220-5221, USA
Equipment	Wireless G Plus Router
Model No.	F5D7231-4
FCC ID	K7SF5D7231B
Trade Name	Belkin

Laboratory Accreditation



1332

- The test result refers exclusively to the test presented test model / sample.,
- Without written approval of *Exclusive Certification Corp.* the test report shall not be reproduced except in full.
- The EUT is also considered as a kind of computer peripheral, because the connection to computer is necessary for typical use. It has been verified to comply with the requirements of FCC Part 15, Subpart B, Class B (DoC). The test report has been issued separately.

Contents

1. Report of Measurements and Examinations	5
1.1 List of Measurements and Examinations.....	5
2. Test Configuration of Equipment under Test	6
2.1 Feature of Equipment under Test.....	6
2.2 RF Specifications	6
2.3 Test Mode and Test Software.....	7
2.4 Description of Test System.....	7
2.5 Connection Diagram of Test System.....	8
2.6 General Information of Test.....	9
2.7 History of this test report	9
3. Antenna Requirements	10
3.1 Standard Applicable	10
3.2 Antenna Construction and Directional Gain.....	10
4. Test of Conducted Emission	11
4.1 Test Limit	11
4.2 Test Procedures	11
4.3 Typical Test Setup	12
4.4 Measurement equipment	12
4.5 Test Result and Data.....	13
4.6 Test Photographs	15
5. Test of Radiated Emission	16
5.1 Test Limit	16
5.2 Test Procedures	17
5.3 Typical Test Setup	18
5.4 Measurement equipment	18
5.5 Test Result and Data.....	19
5.6 Test Photographs	35
6. 6dB Bandwidth Measurement Data	36
6.1 Test Limit	36
6.2 Test Procedures	36
6.3 Test Setup Layout	36
6.4 Measurement equipment	36
6.5 Test Result and Data.....	36
7. Maximum Peak Output Power	40
7.1 Test Limit	40
7.2 Test Procedures	40
7.3 Test Setup Layout	40
7.4 Measurement equipment	40
7.5 Test Result and Data.....	40
8. Band Edges Measurement	44
8.1 Test Limit	44
8.2 Test Procedure :	44
8.3 Test Setup Layout	44
8.4 Measurement equipment	44
8.5 Test Result and Data.....	44
8.6 Restrict band emission Measurement Data.....	49

9. **Power Spectral Density**50

9.1 Test Limit50

9.2 Test Procedures50

9.3 Test Setup Layout :50

9.4 Measurement equipment50

9.5 Test Result and Data50

10. **Restricted Bands of Operation**54

10.1 Labeling Requirement54

Appendix A. Photographs of EUT.....A1 ~ A6

CERTIFICATE OF COMPLIANCE

according to

FCC Rules and Regulations

Part 15 Subpart C

Applicant	Belkin Corporation
Address	501 West Walnut Street, Compton CA 90220-5221, USA
Equipment	Wireless G Plus Router
Model No.	F5D7231-4
FCC ID	K7SF5D7231B

I HEREBY CERTIFY THAT :

The measurements shown in this test report were made in accordance with the procedures given in **ANSI C63.4** The equipment was **passed** the test performed according to **FCC Rules and Regulations Part 15 Subpart C (2003)**.

The test was carried out on Mar. 22, 2006 at **Exclusive Certification Corp.**

Signature



Eric Chan / Manager

1. Report of Measurements and Examinations

1.1 List of Measurements and Examinations

FCC Rule	Description of Test	Result
15.203	. Antenna Requirement	Pass
15.207	. Conducted Emission	Pass
15.209	. Radiated Emission	Pass
15.247(a)(2)	. 6dB Bandwidth	Pass
15.247(b)	. Maximum Peak Output Power	Pass
15.247(c)	. 100kHz Bandwidth of Frequency Band Edges	Pass
15.247(d)	. Power Spectral Density	Pass
1.1307 1.1310 2.1091 2.1093	. RF Exposure Compliance	Pass

Test engineer: _____

Jerry

2. Test Configuration of Equipment under Test

2.1 Feature of Equipment under Test

- Works with Both PCs and Mac Computers.
- Front-Panel LED Display.
- Web-Based Advanced User Interface.
- NAT IP Address Sharing.
- SPI Firewall.
- Integrated 10/100 4-Port Switch.
- Universal Plug-and-Play (UPnP) Compatibility.
- Support for VPN Pass-Through.
- Built-In Dynamic Host Configuration Protocol (DHCP).
- Easy Install Wizard.
- G Plus Mode*.
- Integrated 802.11g Wireless Access Point.
- MAC Address Filtering.

2.2 RF Specifications

Spreading 802.11b: DSSS,CCK, DQPSK, DBPSK 802.11g: OFDM(64QAM, 16QAM, QPSK, BPSK)
Frequency Range 802.11b/g: 2.4 ~ 2.4835GHz
Number of Channels USA, Canada and Taiwan: 1 ~ 11 Most European Countries: 1 ~ 13 France: 10 ~ 13
Data Rate 802.11b: 11, 5.5, 2, 1 Mbps 802.11g: 54, 48, 36, 24, 18, 12, 9, 6 Mbps
Modulation 802.11g: OFDM 802.11b: CCK, DQPSK, DBPSK
Antenna 1/2λ Dipole Peak gain: 1.8 dBi
Transmit Power FCC 802.11b: 16 ~ 18 dBm 802.11g: 12 ~ 14 dBm ETSI (E.I.R.P) 802.11b: 16 ~ 18 dBm 802.11g: 14 ~ 16 dBm

2.3 Test Mode and Test Software

The following test mode and test software was performed for conduction and radiation test:

- 802.11b (CH LO: 2412MHz) • 802.11b (CH MID: 2437MHz) • 802.11b (CH HI: 2462MHz)
- 802.11g (CH LO: 2412MHz) • 802.11g (CH MID: 2437MHz) • 802.11g (CH HI: 2462MHz)

An executive programs, "Hyperterminal.exe" Application under WIN XP.

2.4 Description of Test System

Device	Manufacturer	Model No.	Description
PC	IBM	IGV	Power Cable, Unshielding 1.8 m
Monitor	SlimAGE	510A	Power Cable, Adapter Unshielding 1.8 m Data Cable, VGA shielding 1.35 m
Keyboard	IBM	KB-0225	Data Cable, PS2 shielding 1.85 m
Mouse	IBM	MO28VO	Data Cable, USB shielding 1.85 m
Modem	ACEXX	DM-1414	Power Cable, Adapter Unshielding 1.8 m Data Cable, RS232 Unshielding 1.35 m
Printer	HP	Desk Jet400	Power Cable, Adapter Unshielding 1.8 m Data Cable, PRINT Shielding 1.6 m

Use Cable:

Cable	Description
RJ-45*4	Unshielding, 0.5m
RJ-45*1	Unshielding, 1.5m

2.5 Connection Diagram of Test System

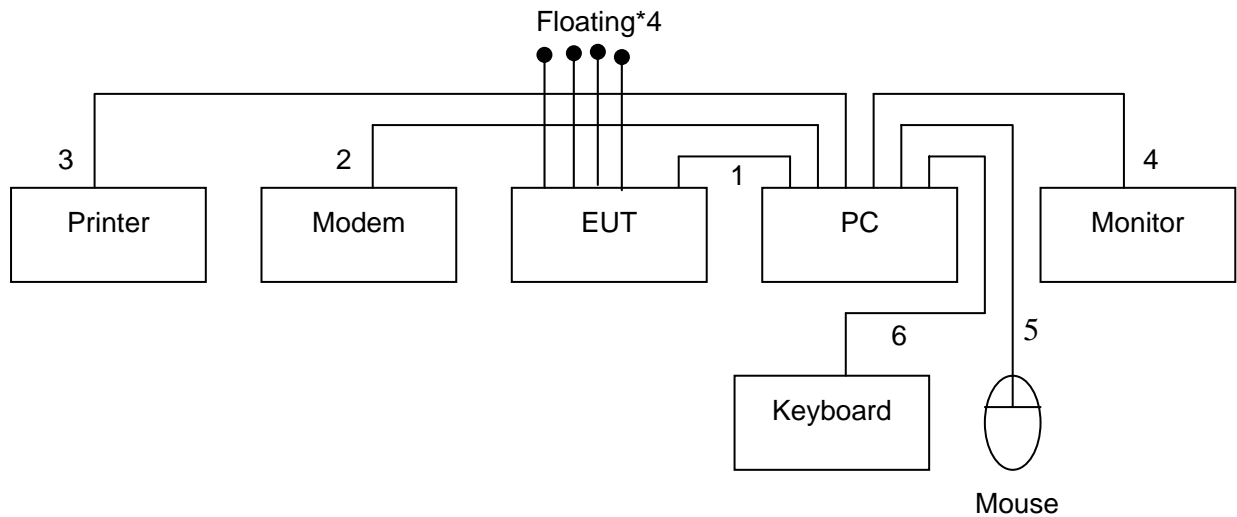

1. The RJ45 cable is connected from PC to the EUT.
2. The I/O cable is connected from PC to the Modem.
3. The I/O cable is connected from PC to the Printer.
4. The I/O cable is connected from PC to the Monitor.
5. The I/O cable is connected from PC to the Mouse.
6. The I/O cable is connected from PC to the Keyboard.
7. There cables are floating.

2.6 General Information of Test

Test Site:	Exclusive Certification Corp. 4F-2, No. 28, Lane 78, Xing-Ai Rd. Nei-hu, Taipei City 114 Taiwan R.O.C.
Test Site Location (OATS1-SD):	No.68-1, Shihbachongsi, shihding Township, Taipei City 223, Taiwan, R.O.C.
Registration Number:	632249
Test Voltage:	AC 120V/ 60Hz
Test in Compliance with:	ANSI C63.4-2003 FCC Part 15 Subpart C
Frequency Range Investigated:	Conducted: from 150kHz to 30 MHz Radiation: from 30 MHz to 24620MHz
Test Distance:	The test distance of radiated emission from antenna to EUT is 3 M.

2.7 History of this test report

ORIGINAL.

3. Antenna Requirements

3.1 Standard Applicable

For intentional device, according to FCC 47 CFR Section 15.203, an intentional radiator shall be designed to ensure that no antenna other than that furnished by the responsible party shall be used with the device.

And according to FCC 47 CFR Section 15.247 (b), if transmitting antennas of directional gain greater than 6dBi are used, the power shall be reduced by the amount in dB that the directional gain of the antenna exceeds 6dBi.

3.2 Antenna Construction and Directional Gain

Antenna type: Integral, Dipole antenna

Antenna Gain: 1.8dBi.

.

4. Test of Conducted Emission

4.1 Test Limit

Conducted Emissions were measured from 150 kHz to 30 MHz with a bandwidth of 9 KHz on the 120 VAC power and return leads of the EUT according to the methods defined in ANSI C63.4-2003 Section 3.1. The EUT was placed on a nonmetallic stand in a shielded room 0.8 meters above the ground plane as shown in section 2.2. The interface cables and equipment positioning were varied within limits of reasonable applications to determine the position produced maximum conducted emissions.

Frequency (MHz)	Quasi Peak (dB μ V)	Average (dB μ V)
0.15 – 0.5	66-56*	56-46*
0.5 – 5.0	56	46
5.0 – 30.0	60	50

*Decreases with the logarithm of the frequency.

4.2 Test Procedures

- a. The EUT was placed 0.4 meter from the conducting wall of the shielding room was kept at least 80 centimeters from any other grounded conducting surface.
- b. Connect EUT to the power mains through a line impedance stabilization network (LISN).
- c. All the support units are connecting to the other LISN.
- d. The LISN provides 50 ohm coupling impedance for the measuring instrument.
- e. The FCC states that a 50 ohm, 50 micro-Henry LISN should be used.
- f. Both sides of AC line were checked for maximum conducted interference.
- g. The frequency range from 150 kHz to 30 MHz was searched.
- h. Set the test-receiver system to Peak Detect Function and Specified Bandwidth with Maximum Hold Mode.

4.3 Typical Test Setup

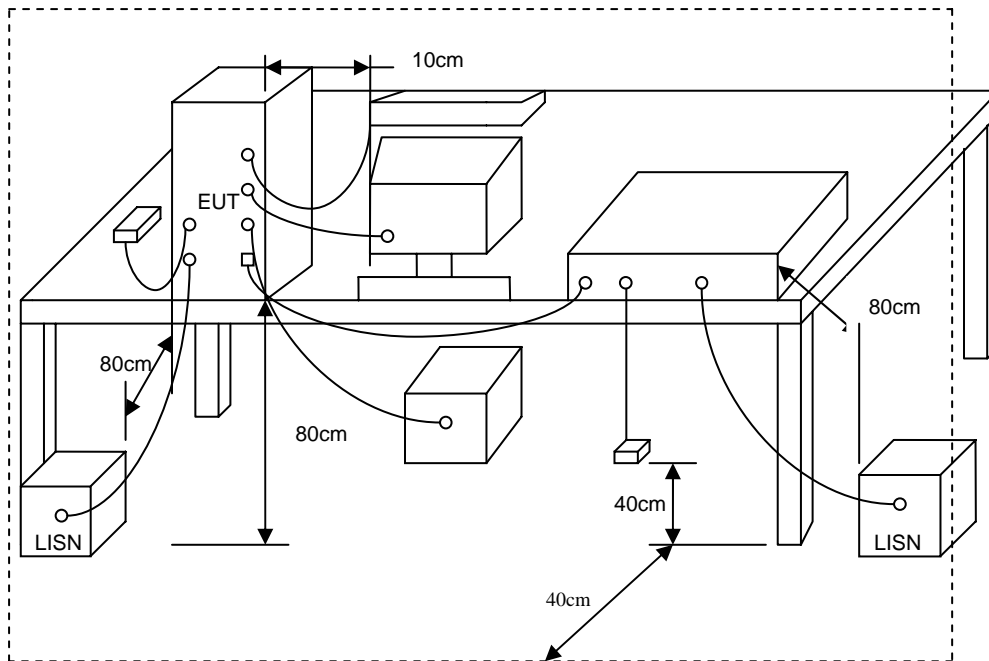

4.4 Measurement equipment

Instrument/Ancillary	Model No.	Manufacturer	Serial No.	Valid Date
Receiver	SCR3501	Schaffner	437	2006/11/03
LISN	NNB-2/16Z	MESS TEC	02/10191	2006/03/30
LISN	NNB-2/16Z	ROLF HEINE	03/10058	2006/05/01

4.5 Test Result and Data

EUT : F5D7231-4
 Power : AC 120V
 Test Mode : 802.11g CH1
 Memo : AD-041A5

Pol/Phase : NEUTRAL
 Temperature : 24 °C
 Humidity : 65 %

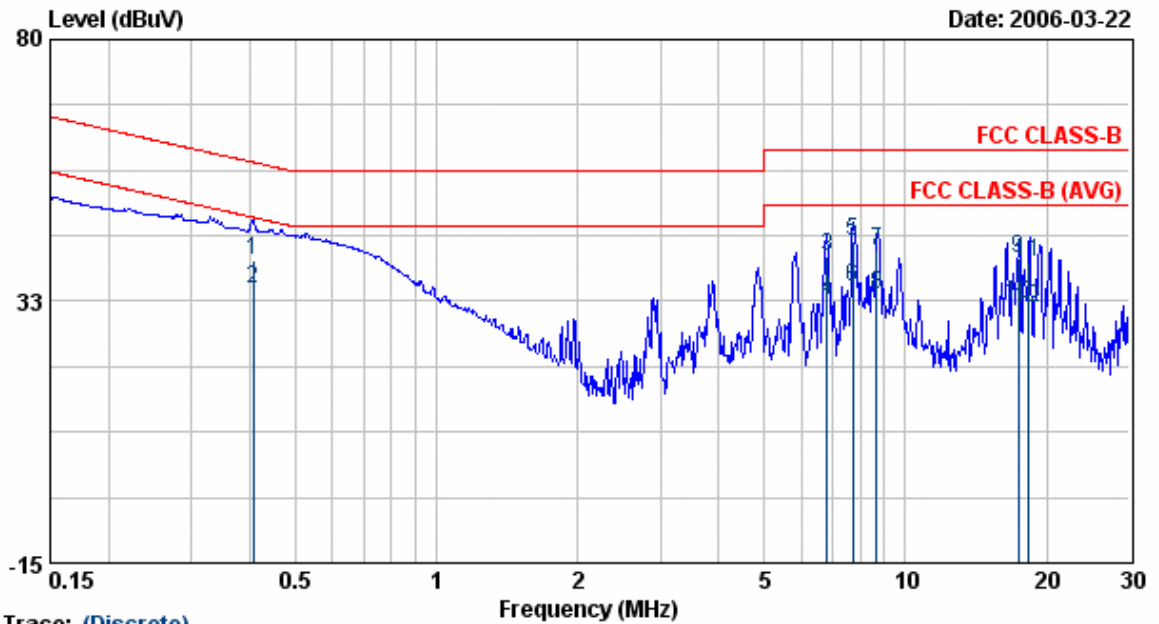

Trace: (Discrete)

Freq	Read Level	Factor	Level	Limit	Over Limit	Remark
MHz	dBuV	dB	dBuV	dBuV	dBuV	
0.41	39.33	0.50	39.83	57.73	-17.90	QP
0.41	34.15	0.50	34.65	47.73	-13.08	AVERAGE
6.80	40.03	0.60	40.63	60.00	-19.37	QP
6.80	32.04	0.60	32.64	50.00	-17.36	AVERAGE
7.72	42.90	0.60	43.50	60.00	-16.50	QP
7.72	34.55	0.60	35.15	50.00	-14.85	AVERAGE
8.69	41.07	0.60	41.67	60.00	-18.33	QP
8.69	33.07	0.60	33.67	50.00	-16.33	AVERAGE
17.39	39.39	0.85	40.24	60.00	-19.76	QP
17.39	31.18	0.85	32.03	50.00	-17.97	AVERAGE
18.36	38.91	0.83	39.74	60.00	-20.26	QP
18.36	30.61	0.83	31.44	50.00	-18.56	AVERAGE

- Remarks:
1. Level = Read Level + Factor
 2. Factor = LISN(ISN) Factor + Cable Loss
 3. All emission below 1GHz at 802.11b/g mode are all the same,so the 802.11g mode chosen as representative in final test.
 4. According to technical experiences,all spurious emission of 802.11g channel 1 was chosen as representative in final test.
 5. The data is worse case.

EUT : F5D7231-4
 Power : AC 120V
 Test Mode : 802.11g CH1
 Memo : AD-041A5

Pol/Phase : LINE
 Temperature : 24 °C
 Humidity : 65 %

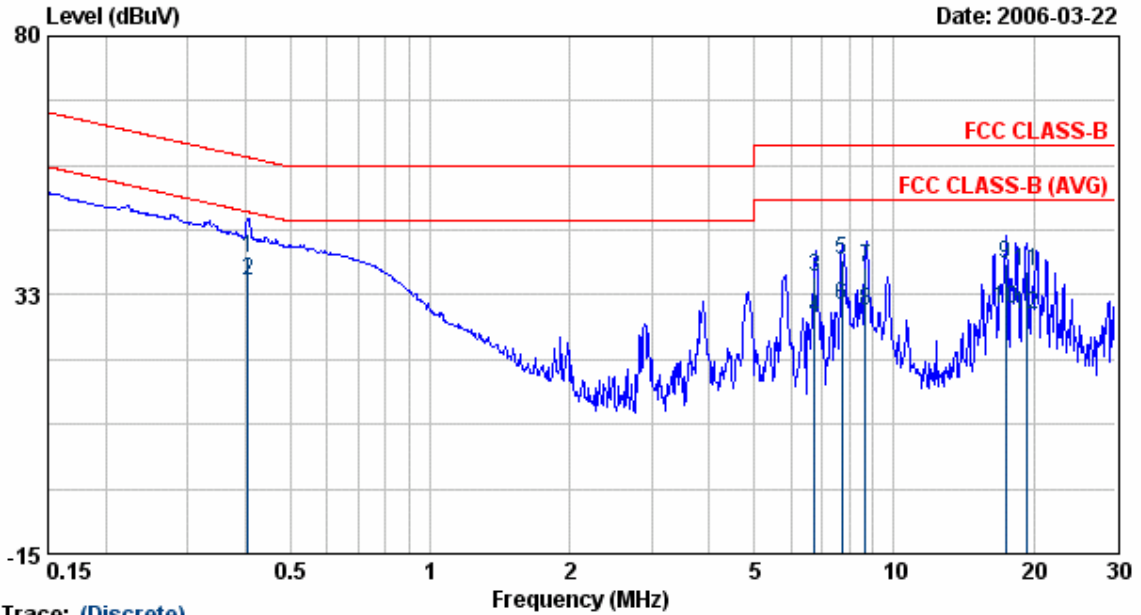

Trace: (Discrete)

Freq	Read Level	Factor	Level	Limit	Over Limit	Remark
MHz	dBuV	dB	dBuV	dBuV	dBuV	
0.40	38.60	0.60	39.20	57.77	-18.57	QP
0.40	34.62	0.60	35.22	47.77	-12.55	AVERAGE
6.75	35.31	0.64	35.95	60.00	-24.05	QP
6.75	27.37	0.64	28.01	50.00	-21.99	AVERAGE
7.73	38.42	0.63	39.05	60.00	-20.95	QP
7.73	30.07	0.63	30.70	50.00	-19.30	AVERAGE
8.70	36.94	0.62	37.56	60.00	-22.44	QP
8.70	28.79	0.62	29.41	50.00	-20.59	AVERAGE
17.38	37.44	0.75	38.19	60.00	-21.81	QP
17.38	29.10	0.75	29.85	50.00	-20.15	AVERAGE
19.32	36.34	0.64	36.98	60.00	-23.02	QP
19.32	28.21	0.64	28.85	50.00	-21.15	AVERAGE

- Remarks:
1. Level = Read Level + Factor
 2. Factor = LISN(ISN) Factor + Cable Loss
 3. All emission below 1GHz at 802.11b/g mode are all the same,so the 802.11g mode chosen as representative in final test.
 4. According to technical experiences,all spurious emission of 802.11g channel 1 was chosen as representative in final test.
 5. The data is worse case.

Test engineer: Ben

4.6 Test Photographs

Front View



Rear View



5. Test of Radiated Emission

5.1 Test Limit

Radiated emissions from 30 MHz to 25 GHz were measured according to the methods defines in ANSI C63.4-2003. The EUT was placed, 0.8 meter above the ground plane, as shown in section 5.6.3. The interface cables and equipment positions were varied within limits of reasonable applications to determine the positions producing maximum radiated emissions

For unintentional device, according to § 15.109(a), except for Class A digital devices, the field strength of radiated emissions from unintentional radiators at a distance of 3 meters shall not exceed the following values:

Frequency (MHz)	Distance Meters	Radiated (μ V / M)	Radiated (dB μ V / M)
30-88	3	100	40.0
88-216	3	150	43.5
216-960	3	200	46.0
Above 960	3	500	54.0

For unintentional device, according to CISPR PUB.22, for Class B digital devices, the general requirement of field strength of radiated emissions from intentional radiators at a distance of 10 meters shall not exceed the above table.

Frequency (MHz)	Distance Meters	Radiated (dB μ V / M)
30-230	10	30
230-1000	10	37

5.2 Test Procedures

- a. The EUT was placed on a rotatable table top 0.8 meter above ground.
- b. The EUT was set 3 meters from the interference receiving antenna which was mounted on the top of a variable height antenna tower.
- c. The table was rotated 360 degrees to determine the position of the highest radiation.
- d. The antenna is a broadband antenna and its height is varied between one meter and four meters above ground to find the maximum value of the field strength both horizontal polarization and vertical polarization of the antenna are set to make the measurement.
- e. For each suspected emission the EUT was arranged to its worst case and then tune the antenna tower (from 1 M to 4 M) and turn table (from 0 degree to 360 degrees) to find the maximum reading.
- f. Set the test-receiver system to Peak or CISPR quasi-peak Detect Function and specified bandwidth with Maximum Hold Mode.
- g. If the emission level of the EUT in peak mode was 3 dB lower than the limit specified, then testing will be stopped and peak values of EUT will be reported, otherwise, the emissions which do not have 3 dB margin will be repeated one by one using the quasi-peak method and reported.
- h. For testing above 1GHz, the emission level of the EUT in peak mode was 20dB lower than average limit (that means the emission level in peak mode also complies with the limit in average mode), then testing will be stopped and peak values of EUT will be reported, otherwise, the emissions will be measured in average mode again and reported.

5.3 Typical Test Setup

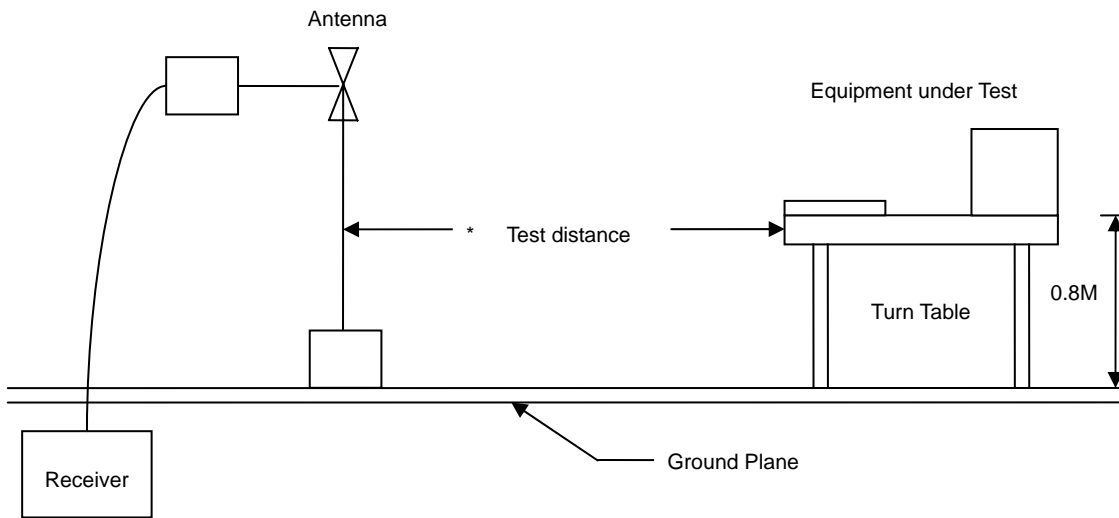

5.4 Measurement equipment

Instrument/Ancillary	Model No.	Manufacturer	Serial No.	Valid Date
EMI Receiver	8546A	HP	3807A00454	2006/04/13
Spectrum Analyzer	FSP40	R&S	10047	2007/01/16
Horn Antenna	3115	EMCO	31589	2007/02/12
Horn Antenna	3116	EMCO	31970	2007/02/09
Bilog Antenna	CBL6112B	Schaffner	2840	2006/04/11
Amplifier	8449B	Agilent	3008A01954	2007/01/08
Amplifier	8447D	Agilent	2944A10531	2006/08/09

5.5 Test Result and Data

EUT	: F5D7231-4	Pol/Phase	: HORIZONTAL
Power	: AC 120V	Temperature	: 25 °C
Test Mode	: Transmit/Receive	Humidity	: 70 %
Operation Channel	: 1	Atmospheric Pressure	: 1020 hPa
Modulation Type	: 802.11g		
Rate	: 24 Mbps		
Memo	: AD-041A5		

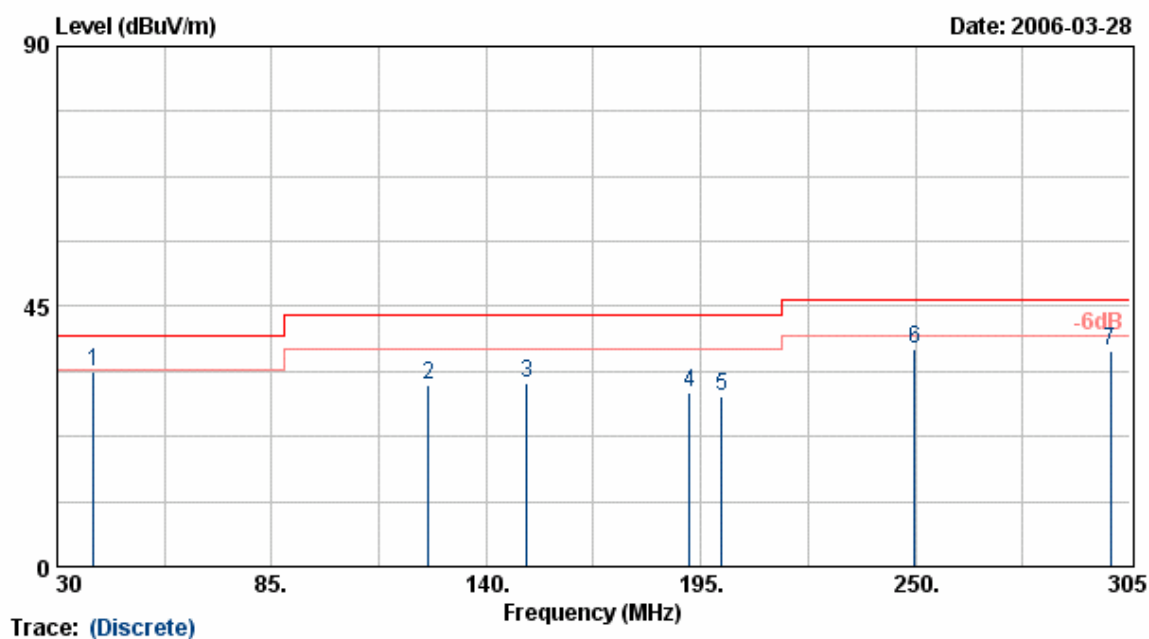

Frequency (MHz)	Meter Reading (dBuV)	Corrected Factor (dBuV/m)	Result (dBuV/m)	Limit (dB)	Margin (dB)	Remark	Table Deg.	Ant High (cm)
39.22	47.12	-13.52	33.60	40.00	-6.40	Peak	0	200
125.20	48.63	-17.21	31.42	43.50	-12.08	Peak	50	200
150.50	50.00	-18.26	31.74	43.50	-11.76	Peak	99	200
192.19	49.84	-19.80	30.04	43.50	-13.46	Peak	250	200
200.25	49.69	-20.13	29.56	43.50	-13.94	Peak	200	200
249.80	53.95	-16.42	37.53	46.00	-8.47	Peak	0	200
300.00	53.33	-15.86	37.47	46.00	-8.53	Peak	352	200

Notes:

1. Result = Meter Reading + Corrected Factor
2. Corrected Factor = Antenna Factor + Cable Loss - Amplifier
3. The resolution bandwidth of test receiver/spectrum analyzer is 120KHz and video bandwidth is 300kHz for Peak detection and Quasi-peak detection at frequency below 1GHz.
4. All emission below 1GHz at 802.11b/g mode are all the same, so the 802.11g mode chosen as representative in final test.
5. According to technical experiences, all spurious emission of 802.11g mode at channel 1,6,11 are almost the same below 1GHz, so that the channel 1 was chosen as representative in final test.
6. The data is worse case.

EUT	: F5D7231-4	Pol/Phase	: HORIZONTAL
Power	: AC 120V	Temperature	: 25 °C
Test Mode	: Transmit/Receive	Humidity	: 70 %
Operation Channel	: 1	Atmospheric Pressure	: 1020 hPa
Modulation Type	: 802.11g		
Rate	: 24 Mbps		
Memo	: AD-041A5		

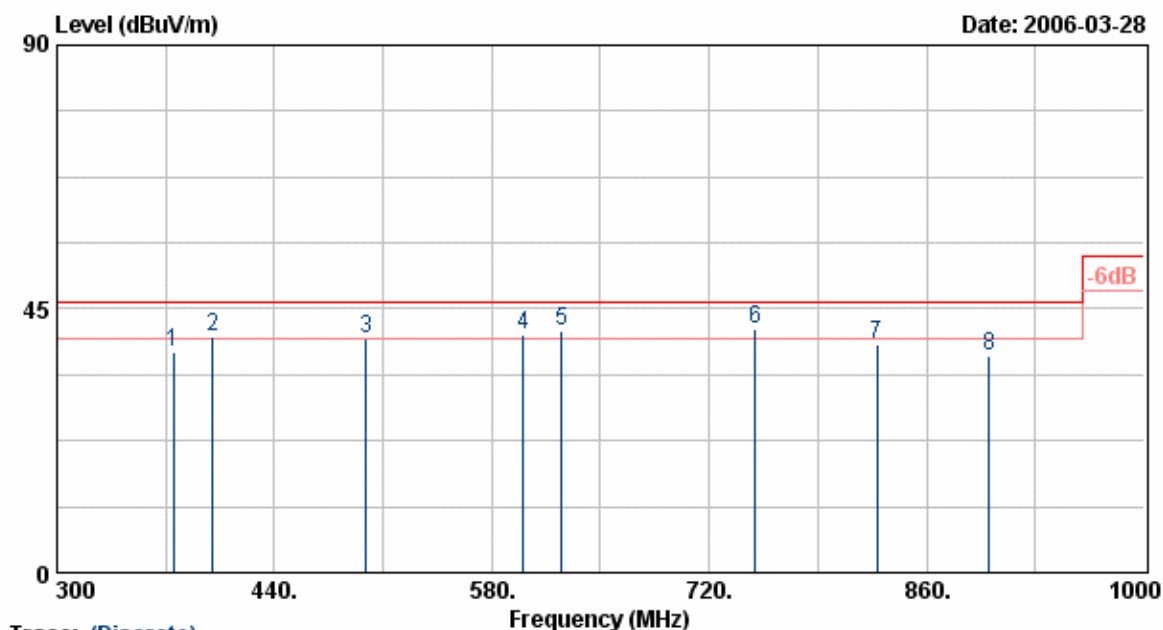

Frequency (MHz)	Meter Reading (dBuV)	Corrected Factor (dBuV/m)	Result (dBuV/m)	Limit (dB)	Margin (dB)	Remark	Table Deg.	Ant High (cm)
374.98	51.41	-13.83	37.58	46.00	-8.42	Peak	83	200
400.00	53.54	-13.22	40.32	46.00	-5.68	QP	93	200
499.00	50.21	-10.25	39.96	46.00	-6.04	QP	302	200
600.10	48.58	-7.88	40.70	46.00	-5.30	QP	360	200
625.00	48.90	-7.60	41.30	46.00	-4.70	QP	360	200
749.75	47.70	-5.98	41.72	46.00	-4.28	QP	196	200
828.00	44.74	-5.70	39.04	46.00	-6.96	Peak	222	200
900.11	42.35	-5.23	37.12	46.00	-8.88	Peak	55	200

Notes:

1. Result = Meter Reading + Corrected Factor
2. Corrected Factor = Antenna Factor + Cable Loss - Amplifier
3. The resolution bandwidth of test receiver/spectrum analyzer is 120KHz and video bandwidth is 300kHz for Peak detection and Quasi-peak detection at frequency below 1GHz.
4. All emission below 1GHz at 802.11b/g mode are all the same,so the 802.11g mode chosen as representative in final test.
5. According to technical experiences,all spurious emission of 802.11g mode at channel 1,6,11 are almost the same below 1GHz,so that the channel 1 was chosen as representative in final test.
6. The data is worse case.

EUT : F5D7231-4
 Power : AC 120V
 Test Mode : Transmit/Receive
 Operation Channel : 1
 Modulation Type : 802.11g
 Rate : 24 Mbps
 Memo : AD-041A5
 Pol/Phase : VERTICAL
 Temperature : 25 °C
 Humidity : 70 %
 Atmospheric Pressure : 1020 hPa

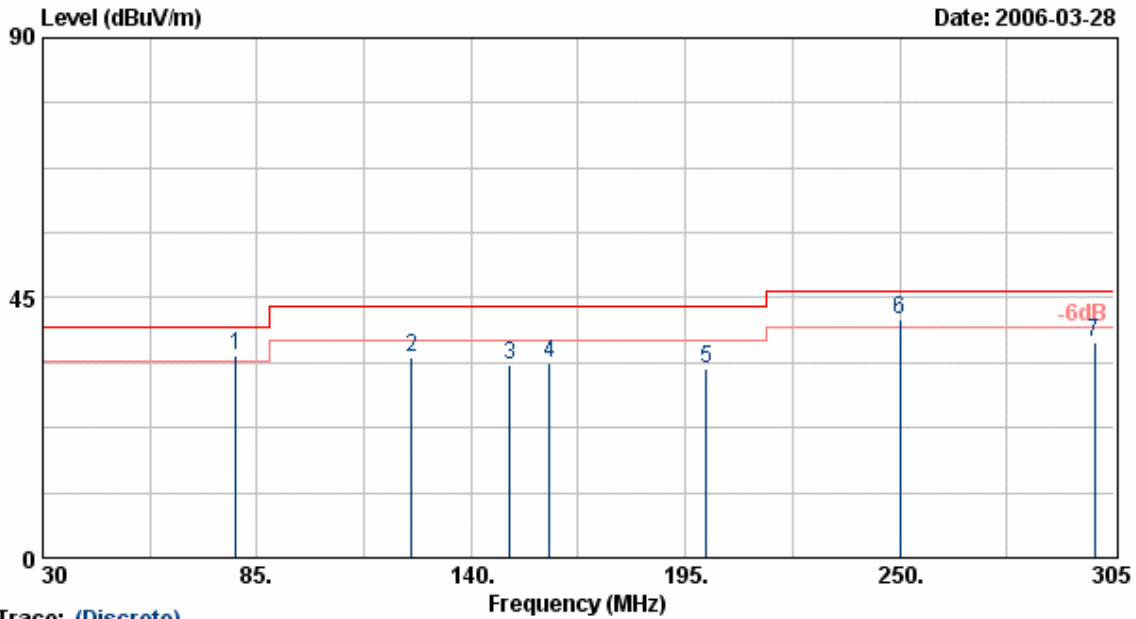

Trace: (Discrete)

Frequency (MHz)	Meter Reading (dBuV)	Corrected Factor (dBuV/m)	Result (dBuV/m)	Limit (dB)	Margin (dB)	Remark	Table Deg.	Ant High (cm)
79.50	55.79	-20.92	34.87	40.00	-5.13	QP	66	100
124.75	51.99	-17.19	34.80	43.50	-8.70	Peak	99	100
150.02	51.70	-18.25	33.45	43.50	-10.05	Peak	15	100
160.00	52.11	-18.46	33.65	43.50	-9.85	Peak	236	100
200.25	52.86	-20.13	32.73	43.50	-10.77	Peak	236	100
250.00	57.60	-16.40	41.21	46.00	-4.79	QP	333	100
300.10	53.23	-15.86	37.37	46.00	-8.63	Peak	0	100

Notes:

1. Result = Meter Reading + Corrected Factor
2. Corrected Factor = Antenna Factor + Cable Loss - Amplifier
3. The resolution bandwidth of test receiver/spectrum analyzer is 120KHz and video bandwidth is 300kHz for Peak detection and Quasi-peak detection at frequency below 1GHz.
4. All emission below 1GHz at 802.11b/g mode are all the same, so the 802.11g mode chosen as representative in final test.
5. According to technical experiences, all spurious emission of 802.11g mode at channel 1,6,11 are almost the same below 1GHz, so that the channel 1 was chosen as representative in final test.
6. The data is worse case.

EUT	: F5D7231-4	Pol/Phase	: VERTICAL
Power	: AC 120V	Temperature	: 25 °C
Test Mode	: Transmit/Receive	Humidity	: 70 %
Operation Channel	: 1	Atmospheric Pressure	: 1020 hPa
Modulation Type	: 802.11g		
Rate	: 24 Mbps		
Memo	: AD-041A5		

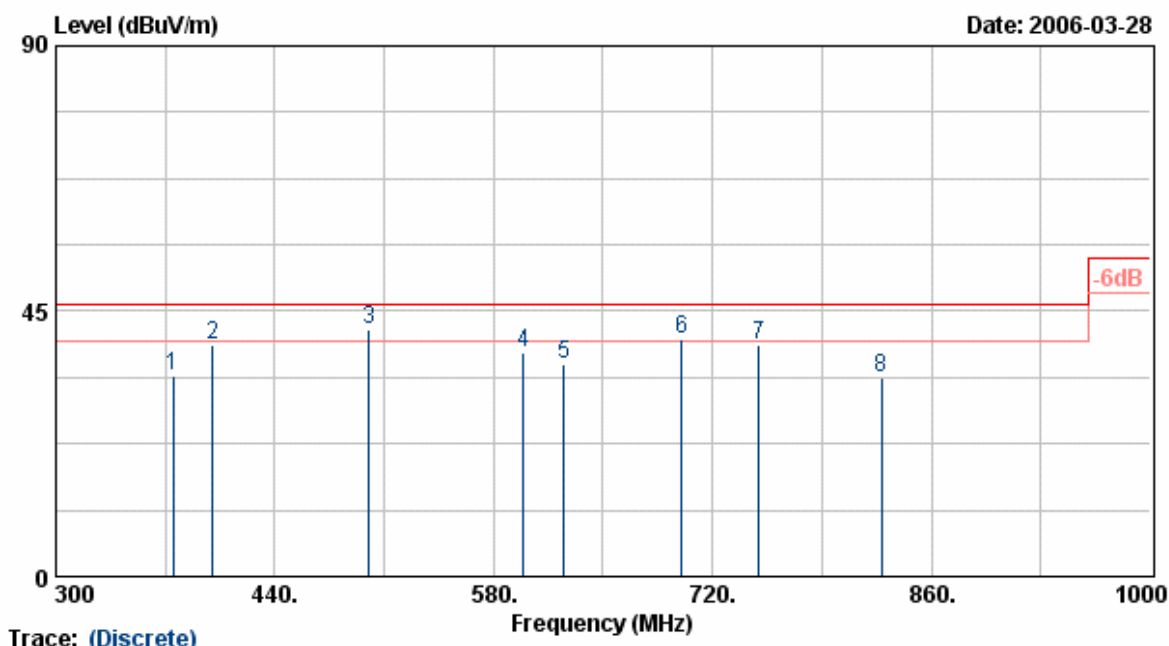

Trace: (Discrete)

Frequency (MHz)	Meter Reading (dBUV)	Corrected Factor (dBUV/m)	Result (dBUV/m)	Limit (dB)	Margin (dB)	Remark	Table Deg.	Ant High (cm)
374.99	47.85	-13.83	34.02	46.00	-11.98	Peak	88	100
400.00	52.59	-13.22	39.37	46.00	-6.63	Peak	355	100
500.02	52.05	-10.22	41.83	46.00	-4.17	QP	355	100
599.00	45.86	-7.89	37.97	46.00	-8.03	Peak	0	100
625.00	43.75	-7.60	36.15	46.00	-9.85	Peak	0	100
700.25	47.50	-7.35	40.15	46.00	-5.85	QP	12	100
749.50	45.22	-5.99	39.23	46.00	-6.77	Peak	55	100
828.00	39.36	-5.70	33.66	46.00	-12.34	Peak	111	100

Notes:

1. Result = Meter Reading + Corrected Factor
2. Corrected Factor = Antenna Factor + Cable Loss - Amplifier
3. The resolution bandwidth of test receiver/spectrum analyzer is 120KHz and video bandwidth is 300kHz for Peak detection and Quasi-peak detection at frequency below 1GHz.
4. All emission below 1GHz at 802.11b/g mode are all the same, so the 802.11g mode chosen as representative in final test.
5. According to technical experiences, all spurious emission of 802.11g mode at channel 1, 6, 11 are almost the same below 1GHz, so that the channel 1 was chosen as representative in final test.
6. The data is worse case.

EUT	: F5D7231-4	Pol/Phase	: HORIZONTAL
Power	: AC 120V	Temperature	: 22 °C
Test Mode	: Transmit/Receive	Humidity	: 65 %
Operation Channel	: 1	Atmospheric Pressure	: 1020 hPa
Modulation Type	: 802.11b		
Rate	: 11 Mbps		
Memo	: AD-041A5		

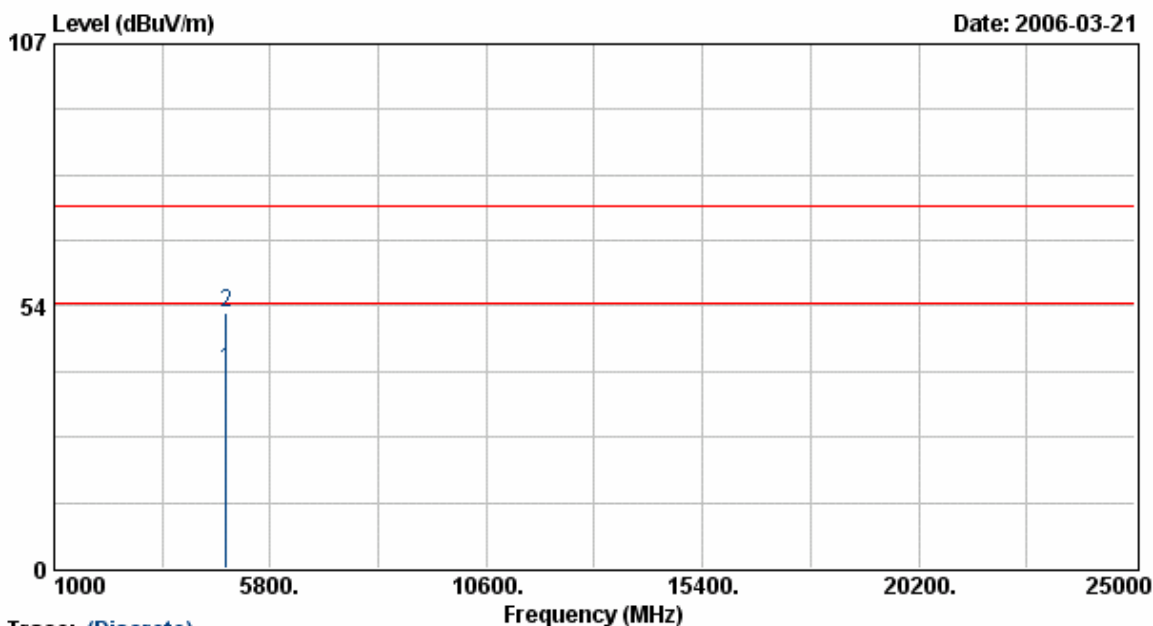

Frequency (MHz)	Meter Reading (dBuV)	Corrected Factor (dBuV/m)	Result (dBuV/m)	Limit (dB)	Margin (dB)	Remark	Table Deg.	Ant High (cm)
4823.88	34.88	5.71	40.59	54.00	-13.41	Average	234	100
4823.88	46.41	5.71	52.11	74.00	-21.89	Peak	234	100

Notes:

1. Result = Meter Reading + Corrected Factor
2. Corrected Factor = Antenna Factor + Cable Loss - Amplifier
3. The resolution bandwidth of test receiver/spectrum analyzer is 120KHz and video bandwidth is 300kHz for Peak detection and Quasi-peak detection at frequency below 1GHz.
4. All emission below 1GHz at 802.11b/g mode are all the same, so the 802.11g mode chosen as representative in final test.
5. According to technical experiences, all spurious emission of 802.11g mode at channel 1,6,11 are almost the same below 1GHz, so that the channel 1 was chosen as representative in final test.
6. The data is worse case.

```

EUT           : F5D7231-4
Power         : AC 120V
Test Mode     : Transmit/Receive
Operation Channel: 1
Modulation Type : 802.11b
Rate          : 11 Mbps
Memo         : AD-041A5

Pol/Phase     : VERTICAL
Temperature   : 22 °C
Humidity      : 65 %
Atmospheric Pressure: 1020 hPa
    
```

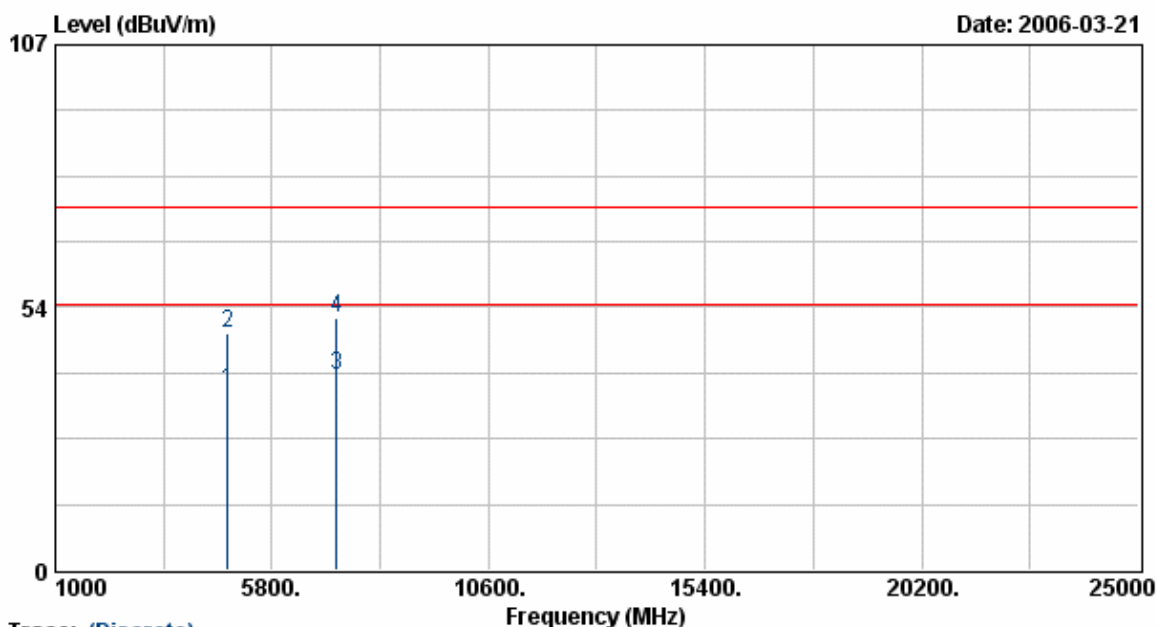

Trace: (Discrete)

Frequency (MHz)	Meter Reading (dBUV)	Corrected Factor (dBUV/m)	Result (dBUV/m)	Limit (dB)	Margin (dB)	Remark	Table Deg.	Ant High (cm)
4824.13	30.94	5.71	36.65	54.00	-17.35	Average	341	100
4824.13	42.43	5.71	48.13	74.00	-25.87	Peak	341	100
7235.38	29.41	10.21	39.62	54.00	-14.38	Average	341	100
7235.38	40.96	10.21	51.17	74.00	-22.83	Peak	341	100

Notes:

1. Result = Meter Reading + Corrected Factor
2. Corrected Factor = Antenna Factor + Cable Loss - Amplifier
3. The resolution bandwidth of test receiver/spectrum analyzer is 120KHz and video bandwidth is 300kHz for Peak detection and Quasi-peak detection at frequency below 1GHz.
4. All emission below 1GHz at 802.11b/g mode are all the same,so the 802.11g mode chosen as representative in final test.
5. According to technical experiences,all spurious emission of 802.11g mode at channel 1,6,11 are almost the same below 1GHz,so that the channel 1 was chosen as representative in final test.
6. The data is worse case.

```

EUT          : F5D7231-4
Power        : AC 120V
Test Mode    : Transmit/Receive
Operation Channel: 6
Modulation Type : 802.11b
Rate         : 11 Mbps
Memo         : AD-041A5

Pol/Phase    : HORIZONTAL
Temperature   : 22 °C
Humidity      : 65 %
Atmospheric Pressure: 1020 hPa
    
```

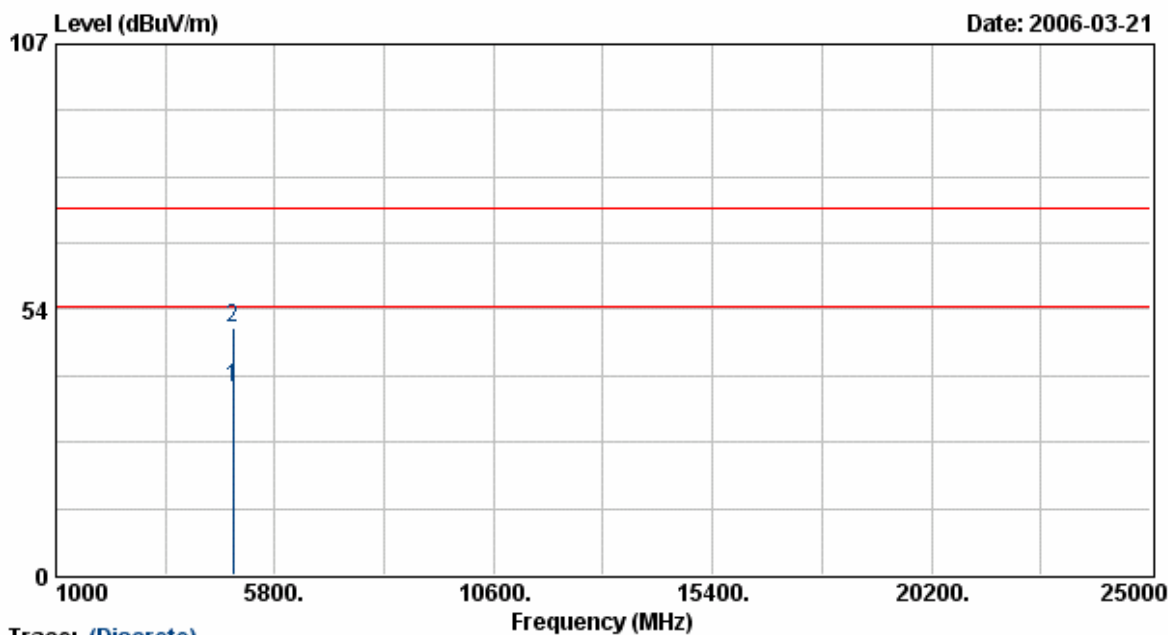

Trace: (Discrete)

Frequency (MHz)	Meter Reading (dBUV)	Corrected Factor (dBUV/m)	Result (dBUV/m)	Limit (dB)	Margin (dB)	Remark	Table Deg.	Ant High (cm)
4874.13	32.08	5.85	37.93	54.00	-16.07	Average	234	100
4874.13	43.79	5.85	49.63	74.00	-24.37	Peak	234	100

- Notes:
1. Result = Meter Reading + Corrected Factor
 2. Corrected Factor = Antenna Factor + Cable Loss - Amplifier
 3. The resolution bandwidth of test receiver/spectrum analyzer is 120KHz and video bandwidth is 300kHz for Peak detection and Quasi-peak detection at frequency below 1GHz.
 4. All emission below 1GHz at 802.11b/g mode are all the same,so the 802.11g mode chosen as representative in final test.
 5. According to technical experiences,all spurious emission of 802.11g mode at channel 1,6,11 are almost the same below 1GHz,so that the channel 1 was chosen as representative in final test.
 6. The data is worse case.

EUT : F5D7231-4
 Power : AC 120V
 Test Mode : Transmit/Receive
 Operation Channel: 6
 Modulation Type : 802.11b
 Rate : 11 Mbps
 Memo : AD-041A5
 Pol/Phase : VERTICAL
 Temperature : 22 °C
 Humidity : 65 %
 Atmospheric Pressure: 1020 hPa

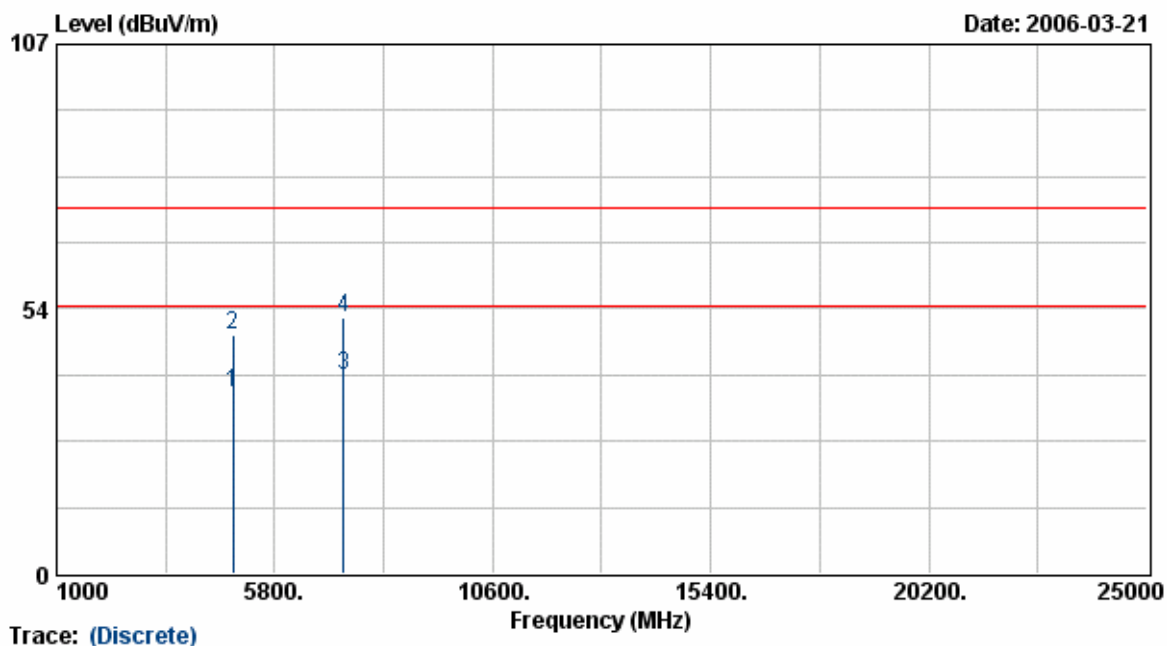

Trace: (Discrete)

Frequency (MHz)	Meter Reading (dBuV)	Corrected Factor (dBuV/m)	Result (dBuV/m)	Limit (dB)	Margin (dB)	Remark	Table Deg.	Ant High (cm)
4874.00	30.84	5.85	36.69	54.00	-17.31	Average	341	100
4874.00	42.40	5.85	48.24	74.00	-25.76	Peak	341	100
7313.88	29.61	10.44	40.05	54.00	-13.95	Average	341	100
7313.88	41.20	10.44	51.64	74.00	-22.36	Peak	341	100

Notes:

1. Result = Meter Reading + Corrected Factor
2. Corrected Factor = Antenna Factor + Cable Loss - Amplifier
3. The resolution bandwidth of test receiver/spectrum analyzer is 120KHz and video bandwidth is 300kHz for Peak detection and Quasi-peak detection at frequency below 1GHz.
4. All emission below 1GHz at 802.11b/g mode are all the same,so the 802.11g mode chosen as representative in final test.
5. According to technical experiences,all spurious emission of 802.11g mode at channel 1,6,11 are almost the same below 1GHz,so that the channel 1 was chosen as representative in final test.
6. The data is worse case.

```

EUT          : F5D7231-4
Power        : AC 120V
Test Mode    : Transmit/Receive
Operation Channel: 11
Modulation Type : 802.11b
Rate         : 11 Mbps
Memo         : AD-041A5

Pol/Phase    : HORIZONTAL
Temperature   : 22 °C
Humidity     : 65 %
Atmospheric Pressure: 1020 hPa
    
```

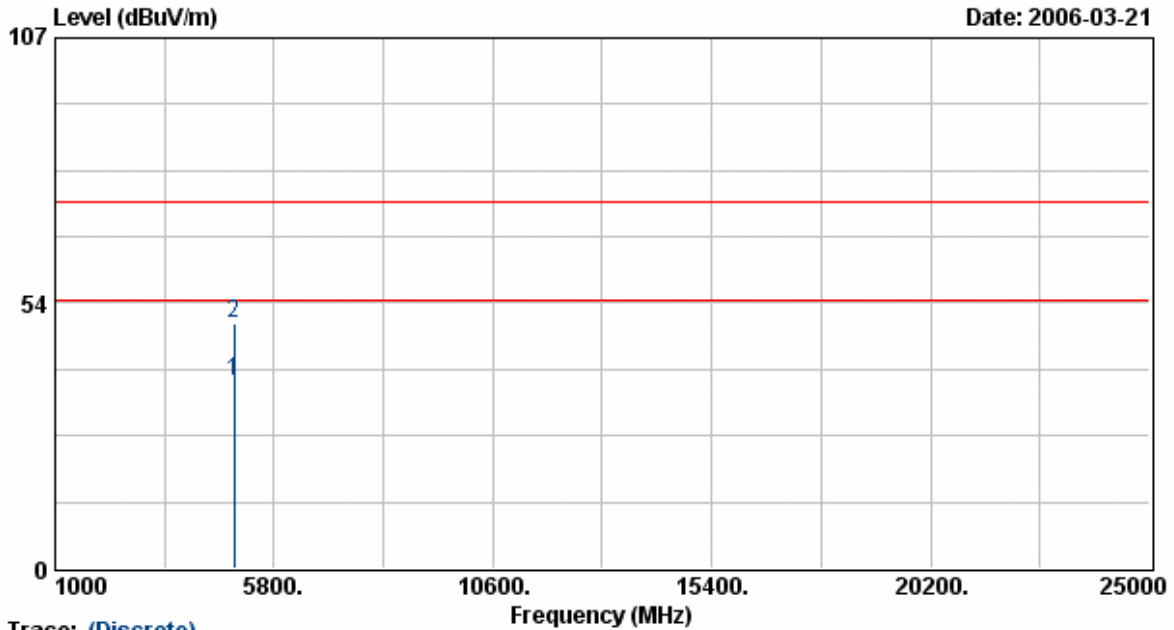

Trace: (Discrete)

Frequency (MHz)	Meter Reading (dBuV)	Corrected Factor (dBuV/m)	Result (dBuV/m)	Limit (dB)	Margin (dB)	Remark	Table Deg.	Ant High (cm)
4924.13	31.62	5.99	37.61	54.00	-16.39	Average	234	100
4924.13	43.24	5.99	49.22	74.00	-24.78	Peak	234	100

Notes:

1. Result = Meter Reading + Corrected Factor
2. Corrected Factor = Antenna Factor + Cable Loss - Amplifier
3. The resolution bandwidth of test receiver/spectrum analyzer is 120KHz and video bandwidth is 300kHz for Peak detection and Quasi-peak detection at frequency below 1GHz.
4. All emission below 1GHz at 802.11b/g mode are all the same,so the 802.11g mode chosen as representative in final test.
5. According to technical experiences,all spurious emission of 802.11g mode at channel 1,6,11 are almost the same below 1GHz,so that the channel 1 was chosen as representative in final test.
6. The data is worse case.

EUT	: F5D7231-4	Pol/Phase	: VERTICAL
Power	: AC 120V	Temperature	: 22 °C
Test Mode	: Transmit/Receive	Humidity	: 65 %
Operation Channel	: 11	Atmospheric Pressure	: 1020 hPa
Modulation Type	: 802.11b		
Rate	: 11 Mbps		
Memo	: AD-041A5		

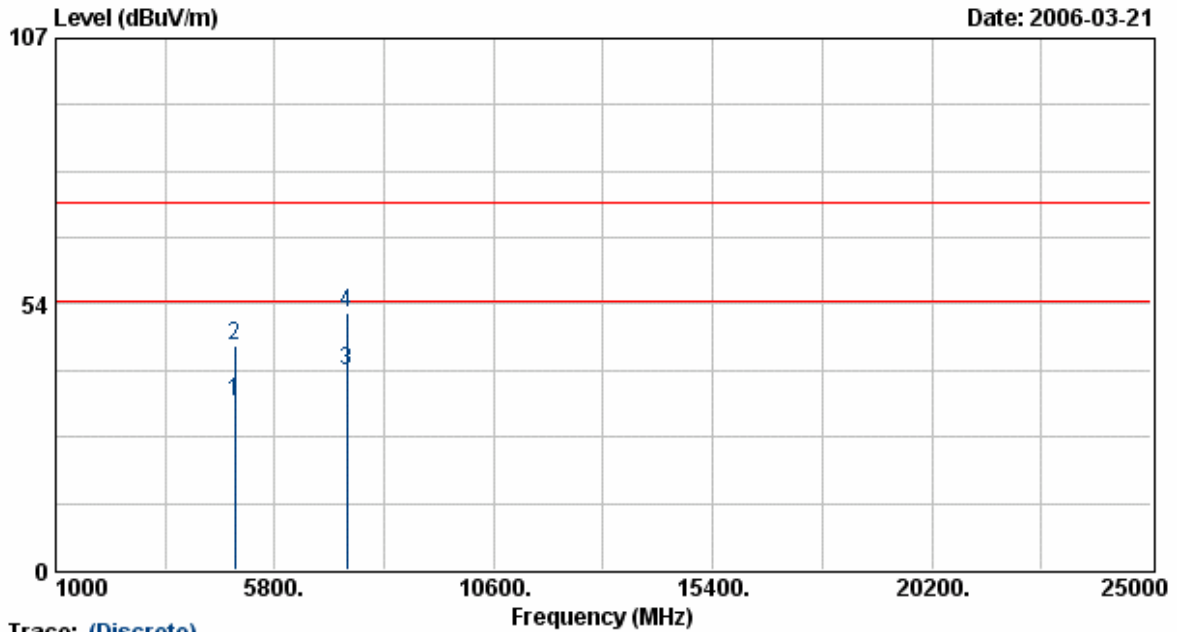

Trace: (Discrete)

Frequency (MHz)	Meter Reading (dBuV)	Corrected Factor (dBuV/m)	Result (dBuV/m)	Limit (dB)	Margin (dB)	Remark	Table Deg.	Ant High (cm)
4923.88	27.68	5.99	33.67	54.00	-20.33	Average	341	100
4923.88	39.08	5.99	45.07	74.00	-28.93	Peak	341	100
7386.88	29.46	10.66	40.12	54.00	-13.88	Average	341	100
7386.88	41.03	10.66	51.69	74.00	-22.31	Peak	341	100

Notes:

1. Result = Meter Reading + Corrected Factor
2. Corrected Factor = Antenna Factor + Cable Loss - Amplifier
3. The resolution bandwidth of test receiver/spectrum analyzer is 120KHz and video bandwidth is 300kHz for Peak detection and Quasi-peak detection at frequency below 1GHz.
4. All emission below 1GHz at 802.11b/g mode are all the same,so the 802.11g mode chosen as representative in final test.
5. According to technical experiences,all spurious emission of 802.11g mode at channel 1,6,11 are almost the same below 1GHz,so that the channel 1 was chosen as representative in final test.
6. The data is worse case.

EUT	: F5D7231-4	Pol/Phase	: HORIZONTAL
Power	: AC 120V	Temperature	: 22 °C
Test Mode	: Transmit/Receive	Humidity	: 65 %
Operation Channel	: 1	Atmospheric Pressure	: 1020 hPa
Modulation Type	: 802.11g		
Rate	: 24 Mbps		
Memo	: AD-041A5		

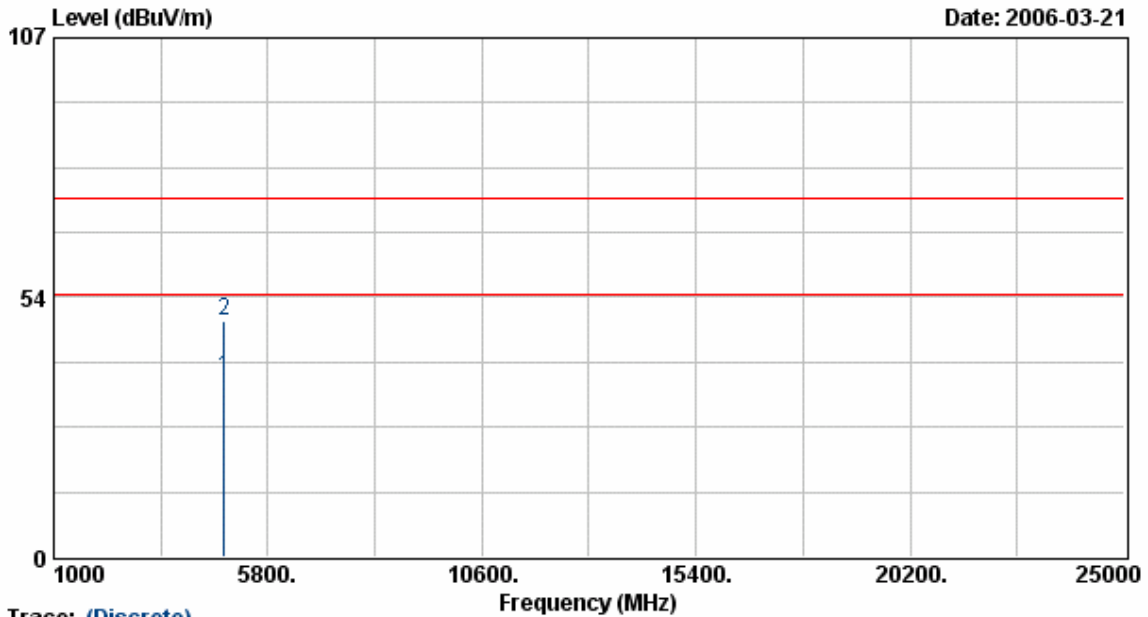

Trace: (Discrete)

Frequency (MHz)	Meter Reading (dBUV)	Corrected Factor (dBUV/m)	Result (dBUV/m)	Limit (dB)	Margin (dB)	Remark	Table Deg.	Ant High (cm)
4824.13	31.27	5.71	36.98	54.00	-17.02	Average	234	100
4824.13	42.74	5.71	48.44	74.00	-25.56	Peak	234	100

Notes:

1. Result = Meter Reading + Corrected Factor
2. Corrected Factor = Antenna Factor + Cable Loss - Amplifier
3. The resolution bandwidth of test receiver/spectrum analyzer is 120KHz and video bandwidth is 300kHz for Peak detection and Quasi-peak detection at frequency below 1GHz.
4. All emission below 1GHz at 802.11b/g mode are all the same,so the 802.11g mode chosen as representative in final test.
5. According to technical experiences,all spurious emission of 802.11g mode at channel 1,6,11 are almost the same below 1GHz,so that the channel 1 was chosen as representative in final test.
6. The data is worse case.

EUT : F5D7231-4
 Power : AC 120V
 Test Mode : Transmit/Receive
 Operation Channel: 1
 Modulation Type : 802.11g
 Rate : 24 Mbps
 Memo : AD-041A5
 Pol/Phase : VERTICAL
 Temperature : 22 °C
 Humidity : 65 %
 Atmospheric Pressure: 1020 hPa

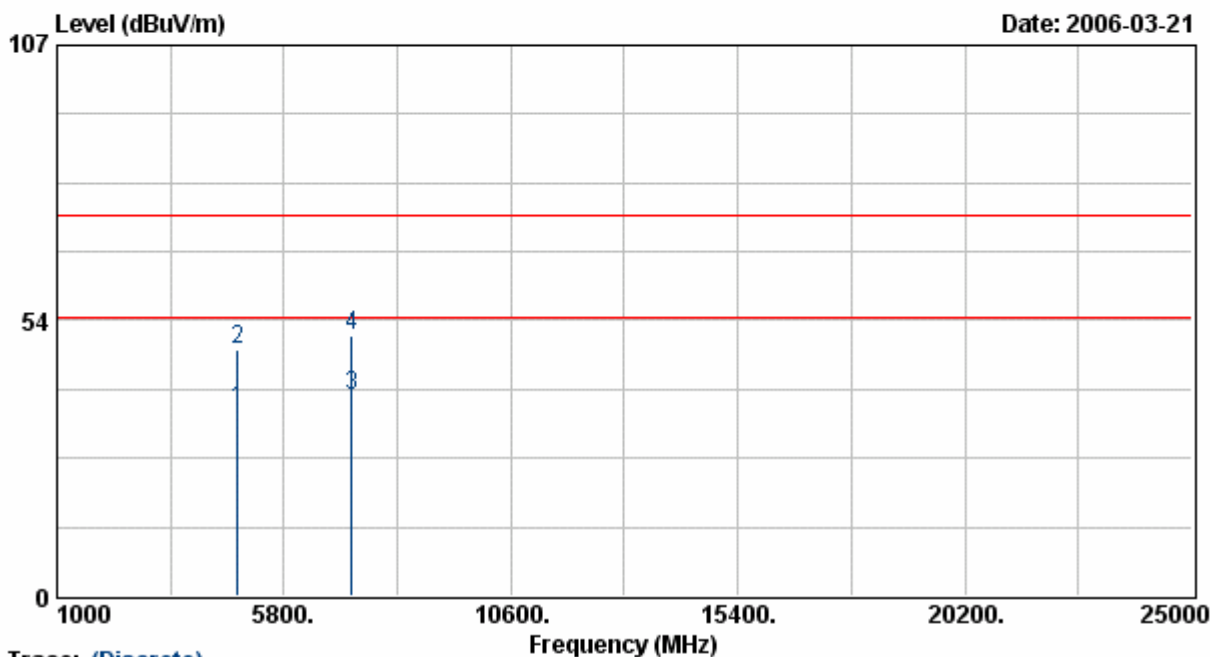

Trace: (Discrete)

Frequency (MHz)	Meter Reading (dBUV)	Corrected Factor (dBUV/m)	Result (dBUV/m)	Limit (dB)	Margin (dB)	Remark	Table Deg.	Ant High (cm)
4824.00	30.51	5.71	36.22	54.00	-17.78	Average	341	100
4824.00	42.09	5.71	47.79	74.00	-26.21	Peak	341	100
7239.13	28.81	10.22	39.03	54.00	-14.97	Average	341	100
7239.13	40.47	10.22	50.69	74.00	-23.31	Peak	341	100

Notes:

1. Result = Meter Reading + Corrected Factor
2. Corrected Factor = Antenna Factor + Cable Loss - Amplifier
3. The resolution bandwidth of test receiver/spectrum analyzer is 120KHz and video bandwidth is 300kHz for Peak detection and Quasi-peak detection at frequency below 1GHz.
4. All emission below 1GHz at 802.11g mode are all the same, so the 802.11g mode chosen as representative in final test.
5. According to technical experiences, all spurious emission of 802.11g mode at channel 1,6,11 are almost the same below 1GHz, so that the channel 1 was chosen as representative in final test.
6. The data is worse case.

EUT	: F5D7231-4	Pol/Phase	: HORIZONTAL
Power	: AC 120V	Temperature	: 22 °C
Test Mode	: Transmit/Receive	Humidity	: 65 %
Operation Channel	: 6	Atmospheric Pressure	: 1020 hPa
Modulation Type	: 802.11g		
Rate	: 24 Mbps		
Memo	: AD-041A5		

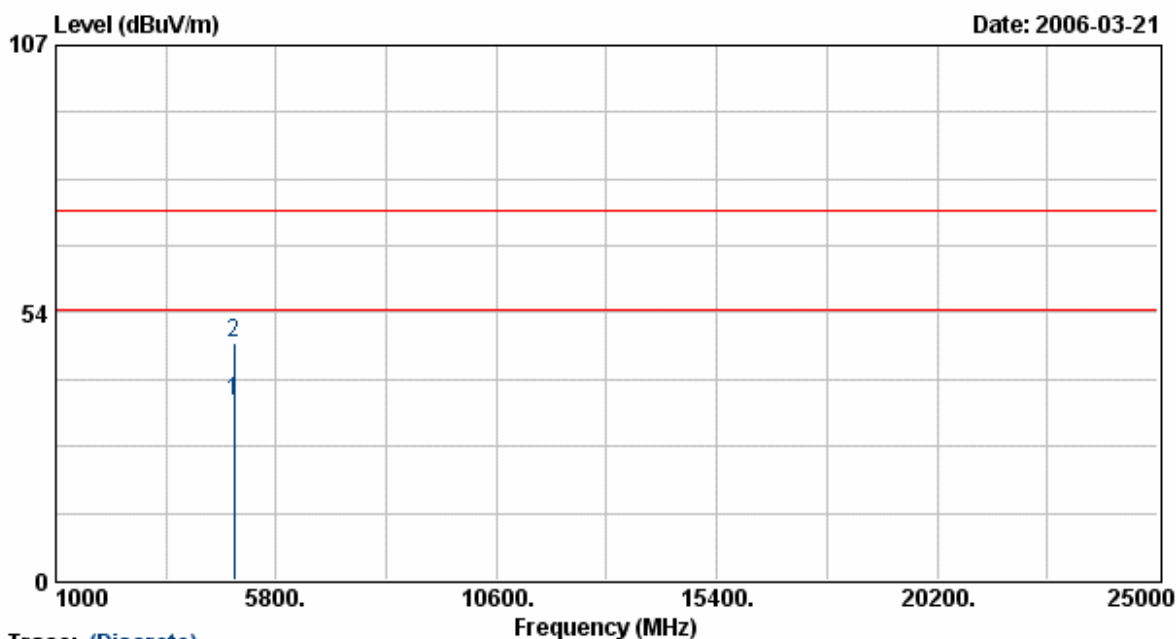

Trace: (Discrete)

Frequency (MHz)	Meter Reading (dBUV)	Corrected Factor (dBUV/m)	Result (dBUV/m)	Limit (dB)	Margin (dB)	Remark	Table Deg.	Ant High (cm)
4874.13	29.77	5.85	35.62	54.00	-18.38	Average	234	100
4874.13	41.47	5.85	47.32	74.00	-26.68	Peak	234	100

Notes:

1. Result = Meter Reading + Corrected Factor
2. Corrected Factor = Antenna Factor + Cable Loss - Amplifier
3. The resolution bandwidth of test receiver/spectrum analyzer is 120KHz and video bandwidth is 300kHz for Peak detection and Quasi-peak detection at frequency below 1GHz.
4. All emission below 1GHz at 802.11b/g mode are all the same,so the 802.11g mode chosen as representative in final test.
5. According to technical experiences,all spurious emission of 802.11g mode at channel 1,6,11 are almost the same below 1GHz,so that the channel 1 was chosen as representative in final test.
6. The data is worse case.

```

EUT           : F5D7231-4
Power         : AC 120V
Test Mode     : Transmit/Receive
Operation Channel: 6
Modulation Type : 802.11g
Rate         : 24 Mbps
Memo         : AD-041A5

Pol/Phase    : VERTICAL
Temperature   : 22 °C
Humidity     : 65 %
Atmospheric Pressure: 1020 hPa
    
```

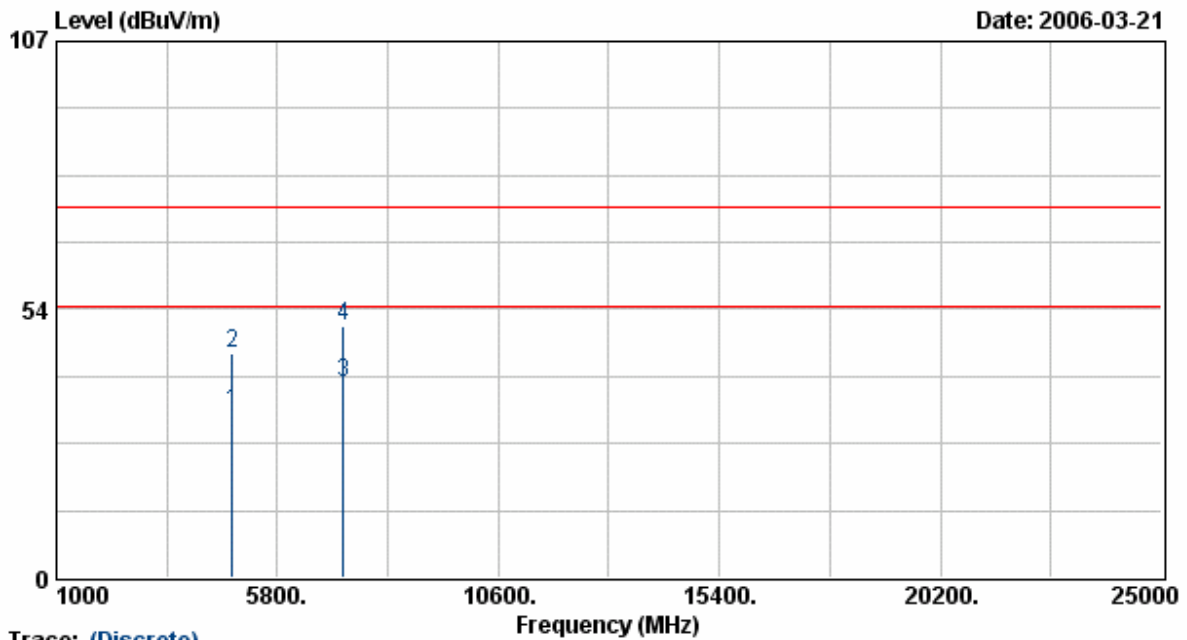

Trace: (Discrete)

Frequency (MHz)	Meter Reading (dBUV)	Corrected Factor (dBUV/m)	Result (dBUV/m)	Limit (dB)	Margin (dB)	Remark	Table Deg.	Ant High (cm)
4825.63	27.44	5.71	33.15	54.00	-20.85	Average	341	100
4825.63	38.98	5.71	44.69	74.00	-29.31	Peak	341	100
7235.88	28.64	10.21	38.85	54.00	-15.15	Average	341	100
7235.88	40.07	10.21	50.28	74.00	-23.72	Peak	341	100

Notes:

1. Result = Meter Reading + Corrected Factor
2. Corrected Factor = Antenna Factor + Cable Loss - Amplifier
3. The resolution bandwidth of test receiver/spectrum analyzer is 120KHz and video bandwidth is 300kHz for Peak detection and Quasi-peak detection at frequency below 1GHz.
4. All emission below 1GHz at 802.11b/g mode are all the same, so the 802.11g mode chosen as representative in final test.
5. According to technical experiences, all spurious emission of 802.11g mode at channel 1,6,11 are almost the same below 1GHz, so that the channel 1 was chosen as representative in final test.
6. The data is worse case.

EUT	: F5D7231-4	Pol/Phase	: HORIZONTAL
Power	: AC 120V	Temperature	: 22 °C
Test Mode	: Transmit/Receive	Humidity	: 65 %
Operation Channel	: 11	Atmospheric Pressure	: 1020 hPa
Modulation Type	: 802.11g		
Rate	: 24 Mbps		
Memo	: AD-041A5		

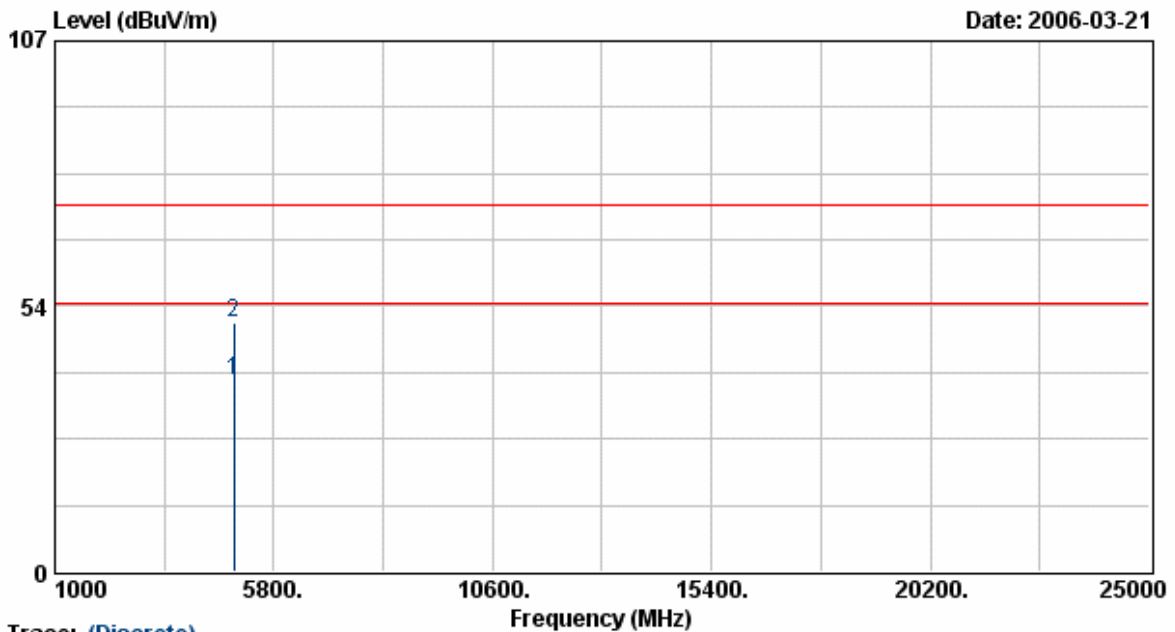

Trace: (Discrete)

Frequency (MHz)	Meter Reading (dBUV)	Corrected Factor (dBUV/m)	Result (dBUV/m)	Limit (dB)	Margin (dB)	Remark	Table Deg.	Ant High (cm)
4924.13	32.69	5.99	38.68	54.00	-15.32	Average	234	100
4924.13	44.29	5.99	50.27	74.00	-23.73	Peak	234	100

Notes:

1. Result = Meter Reading + Corrected Factor
2. Corrected Factor = Antenna Factor + Cable Loss - Amplifier
3. The resolution bandwidth of test receiver/spectrum analyzer is 120KHz and video bandwidth is 300kHz for Peak detection and Quasi-peak detection at frequency below 1GHz.
4. All emission below 1GHz at 802.11b/g mode are all the same, so the 802.11g mode chosen as representative in final test.
5. According to technical experiences, all spurious emission of 802.11g mode at channel 1,6,11 are almost the same below 1GHz, so that the channel 1 was chosen as representative in final test.
6. The data is worse case.

EUT : F5D7231-4
 Power : AC 120V
 Test Mode : Transmit/Receive
 Operation Channel: 11
 Modulation Type : 802.11g
 Rate : 24 Mbps
 Memo : AD-041A5
 Pol/Phase : VERTICAL
 Temperature : 22 °C
 Humidity : 65 %
 Atmospheric Pressure: 1020 hPa

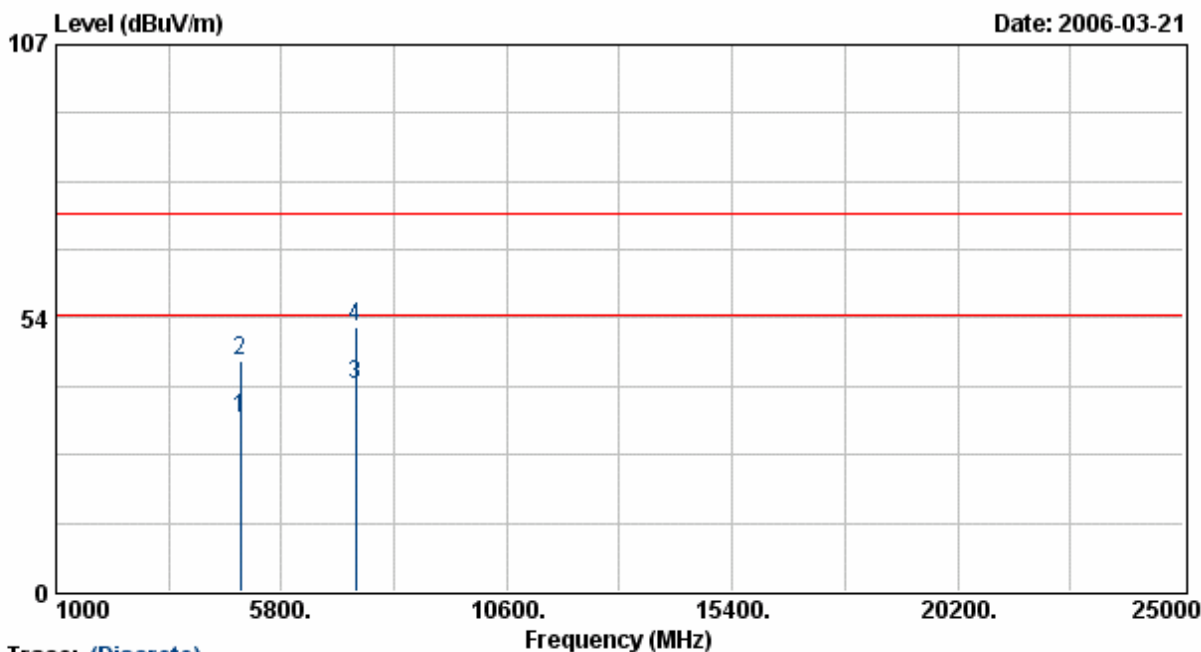

Trace: (Discrete)

Frequency (MHz)	Meter Reading (dBUV)	Corrected Factor (dBUV/m)	Result (dBUV/m)	Limit (dB)	Margin (dB)	Remark	Table Deg.	Ant High (cm)
4924.00	27.80	5.99	33.78	54.00	-20.22	Average	70	100
4924.00	39.28	5.99	45.26	74.00	-28.74	Peak	70	100
7388.88	29.71	10.67	40.37	54.00	-13.63	Average	70	100
7388.88	41.26	10.67	51.92	74.00	-22.08	Peak	70	100

Notes:

1. Result = Meter Reading + Corrected Factor
2. Corrected Factor = Antenna Factor + Cable Loss - Amplifier
3. The resolution bandwidth of test receiver/spectrum analyzer is 120KHz and video bandwidth is 300kHz for Peak detection and Quasi-peak detection at frequency below 1GHz.
4. All emission below 1GHz at 802.11b/g mode are all the same, so the 802.11g mode chosen as representative in final test.
5. According to technical experiences, all spurious emission of 802.11g mode at channel 1,6,11 are almost the same below 1GHz, so that the channel 1 was chosen as representative in final test.
6. The data is worse case.

5.6 Test Photographs

Front View



Rear View



6. 6dB Bandwidth Measurement Data

6.1 Test Limit

The minimum of 6dB Bandwidth Measurement is 0.5 MHz.

6.2 Test Procedures

- a. The transmitter output was connected to the spectrum analyzer.
- b. Set RBW of spectrum analyzer to 100 KHz and VBW to 100 KHz.
- c. The 6 dB bandwidth is defined as the total spectrum the power of which is higher than peak power minus 6 dB.

6.3 Test Setup Layout

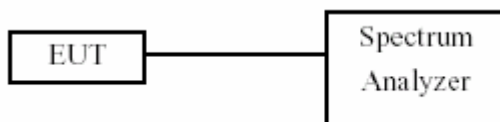

6.4 Measurement equipment

Instrument/Ancillary	Type	Manufacturer	Serial No.	Valid Date
Spectrum Analyzer	FSP40	R&S	100047	2007/01/16

6.5 Test Result and Data

(1) Modulation Standard: IEEE 802.11b (11Mbps)

Test Date: Mar. 17, 2006 Temperature: 24 Humidity: 65% Atmospheric pressure: 1021 hPa

Channel	Frequency (MHz)	6dB Bandwidth (MHz)
01	2412	11.1
06	2437	10.9
11	2462	10.8

(2) Modulation Standard: IEEE 802.11g (24Mbps)

Test Date: Mar. 17, 2006 Temperature: 24 Humidity: 65% Atmospheric pressure: 1021 hPa

Channel	Frequency (MHz)	6dB Bandwidth (MHz)
01	2412	15.5
06	2437	15.6
11	2462	15.5

Modulation Standard: 802.11b (11Mbps)
 Channel: 01

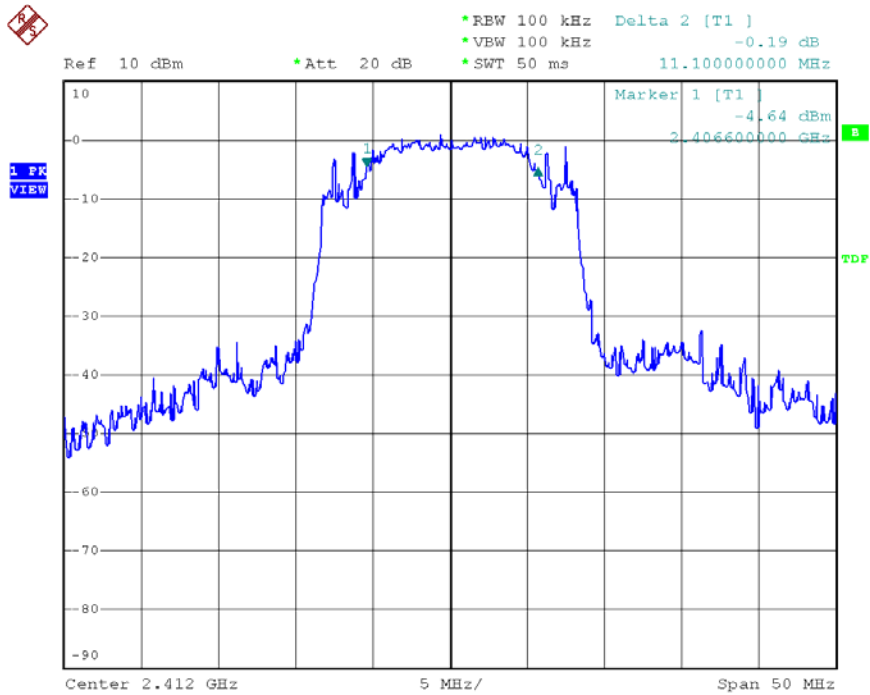

Date: 15.MAR.2006 11:23:24

Channel:06

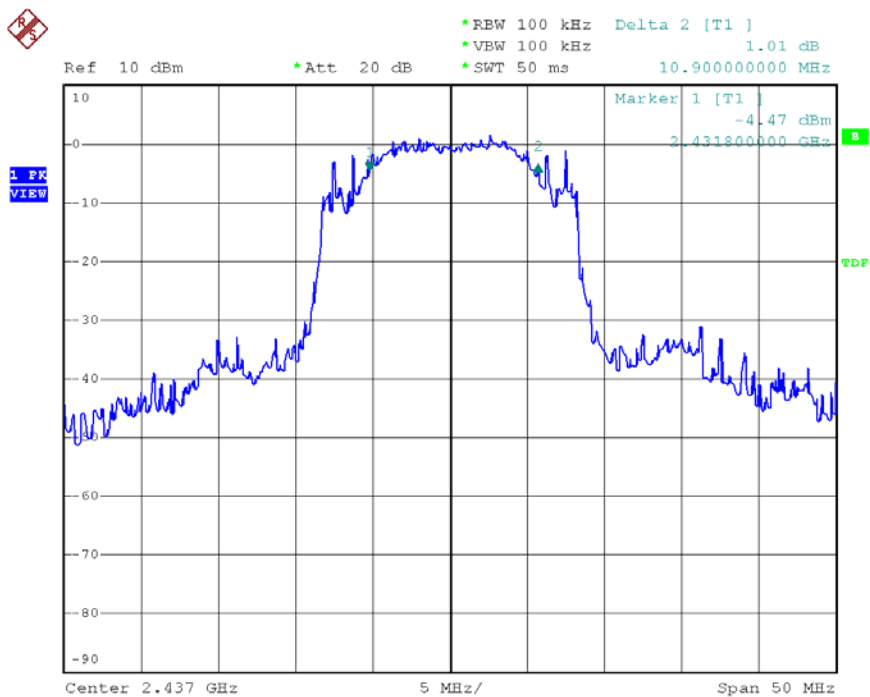

Date: 15.MAR.2006 11:25:36

Channel: 11

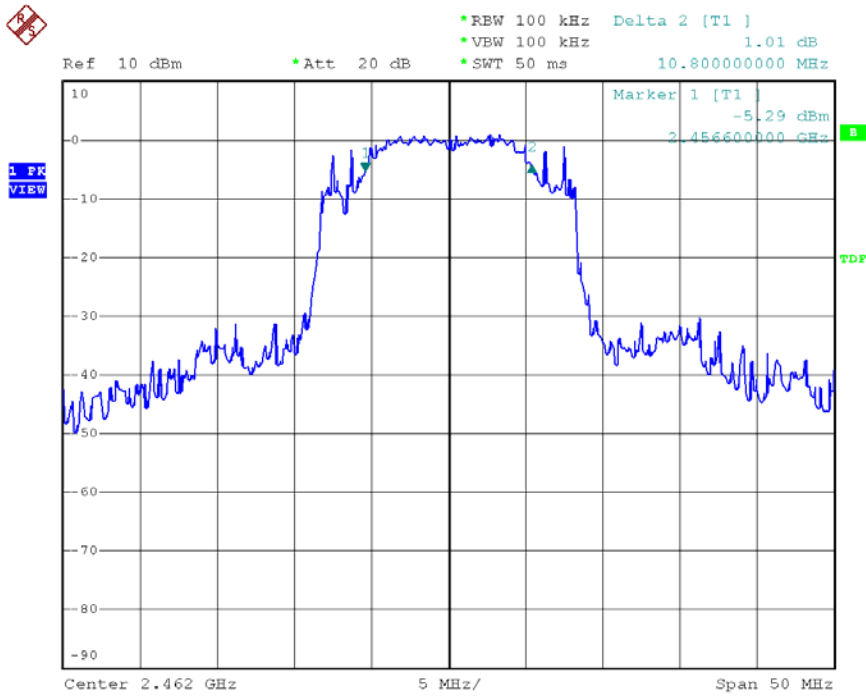

Date: 15.MAR.2006 11:27:45

Modulation Standard:802.11g (24Mbps)
 Channel:01

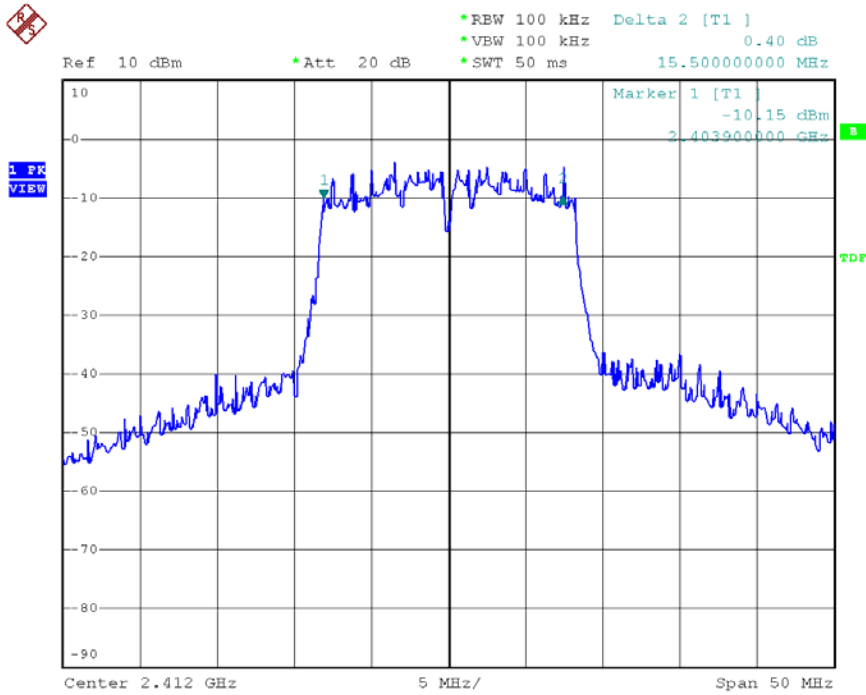

Date: 15.MAR.2006 11:40:58

Channel: 06

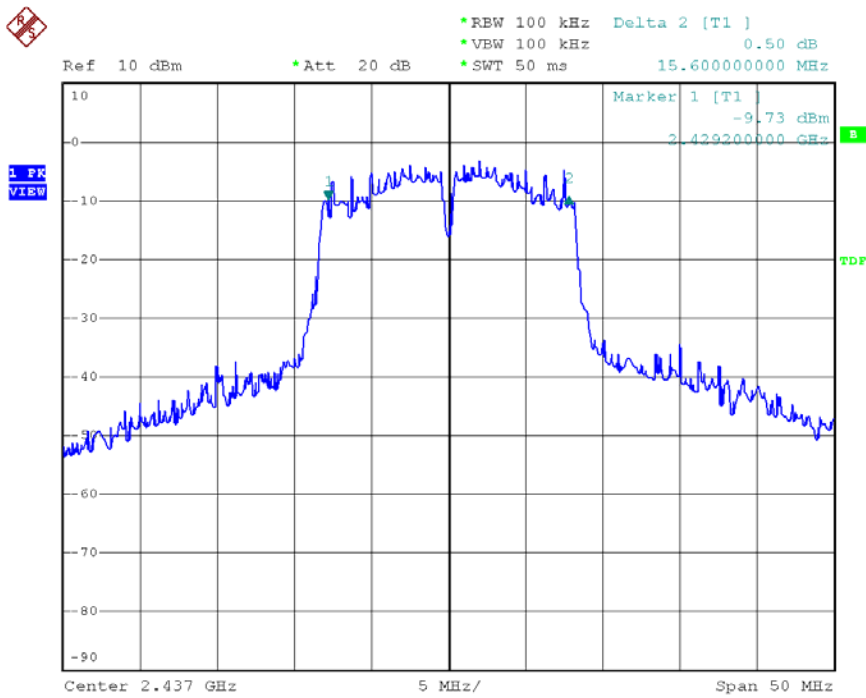

Date: 15.MAR.2006 11:34:36

Channel:11

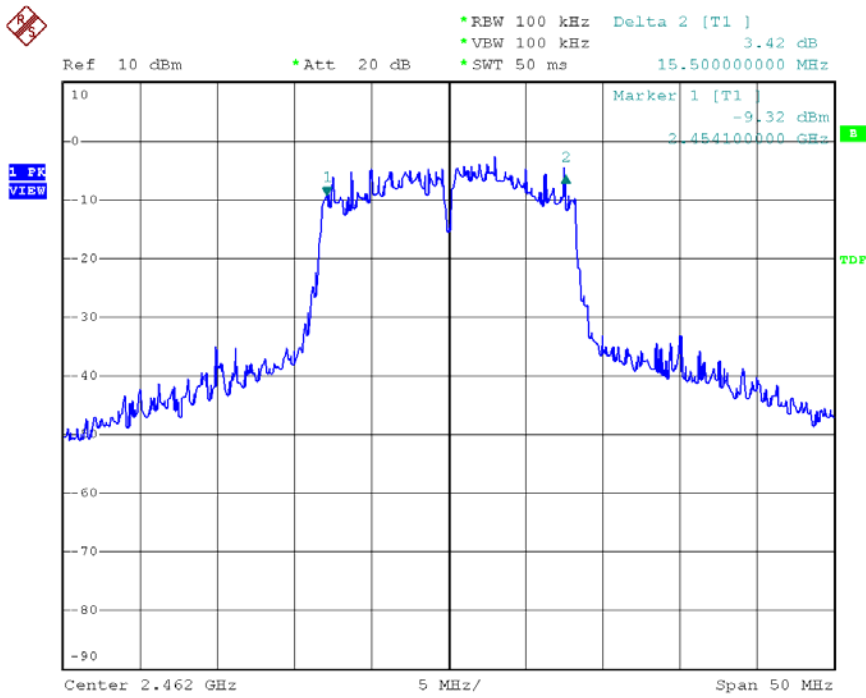

Date: 15.MAR.2006 11:31:43

7. Maximum Peak Output Power

7.1 Test Limit

The Maximum Peak Output Power Measurement is 30dBm.

7.2 Test Procedures

The antenna port (RF output) of the EUT was connected to the input (RF input) of a power meter. Power was read directly from the meter and cable loss connection was added to the reading to obtain power at the EUT antenna terminal. The EUT Output Power was set to maximum to produce the worse case test result.

7.3 Test Setup Layout

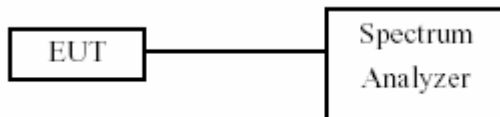

7.4 Measurement equipment

Instrument/Ancillary	Model No.	Manufacturer	Serial No.	Valid Date
Spectrum Analyzer	FSP40	R&S	100047	2007/01/16

7.5 Test Result and Data

(1) Modulation Standard: IEEE 802.11b (11Mbps)

Test Date: Mar. 17, 2006 Temperature: 24 Humidity: 65% Atmospheric pressure: 1021 hPa

Channel	Frequency (MHz)	Peak Power Output (dBm)	Peak Power Output (mW)
01	2412	17.83	60.70
06	2437	18.23	66.50
11	2462	18.22	66.40

(2) Modulation Standard: IEEE 802.11g (24Mbps)

Test Date: Mar. 17, 2006 Temperature: 24 Humidity: 65% Atmospheric pressure: 1021 hPa

Channel	Frequency (MHz)	Peak Power Output (dBm)	Peak Power Output (mW)
01	2412	14.06	25.50
06	2437	14.30	26.90
11	2462	14.41	27.60

Modulation Standard: 802.11b (11Mbps)
 Channel: 01

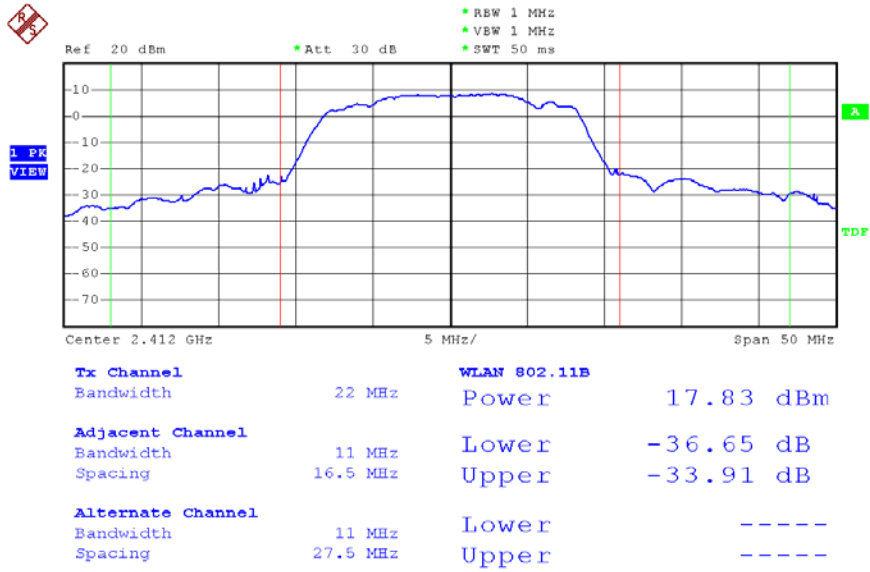

Date: 15.MAR.2006 11:16:33

Channel:06

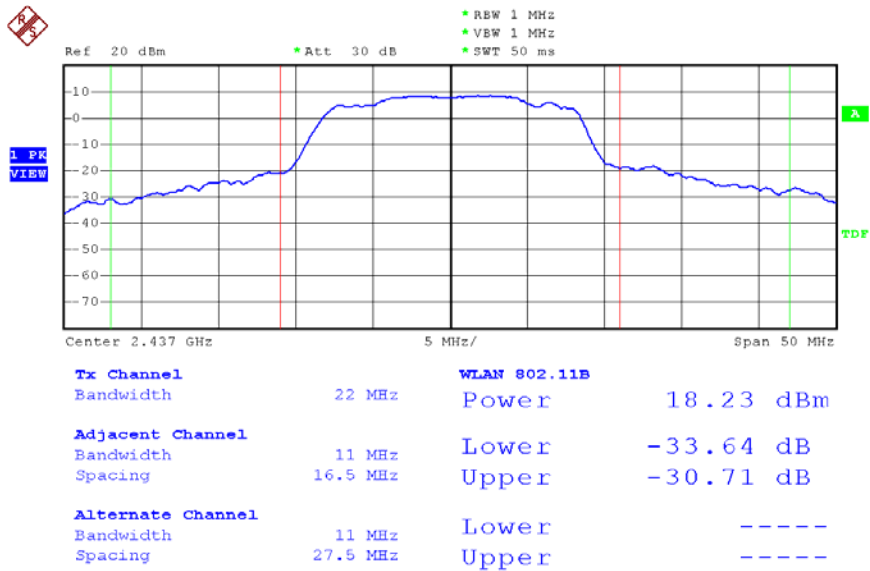

Date: 15.MAR.2006 11:15:05

Channel: 11

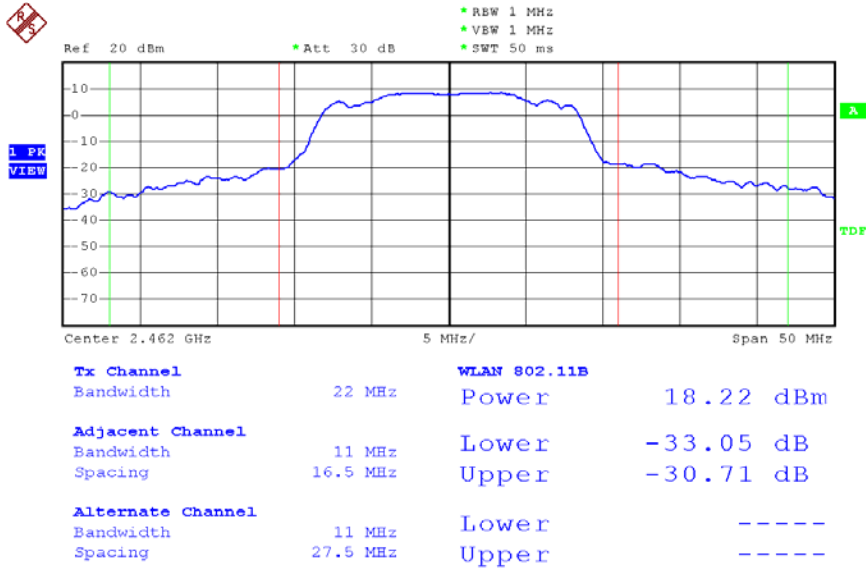

Date: 15.MAR.2006 11:12:54

Modulation Standard:802.11g (24Mbps)
Channel:01

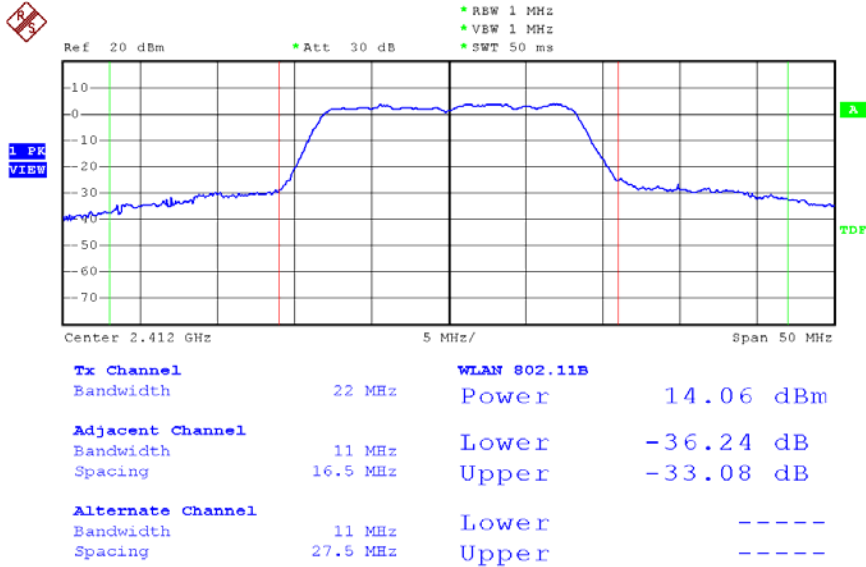

Date: 15.MAR.2006 15:07:36

Channel: 06

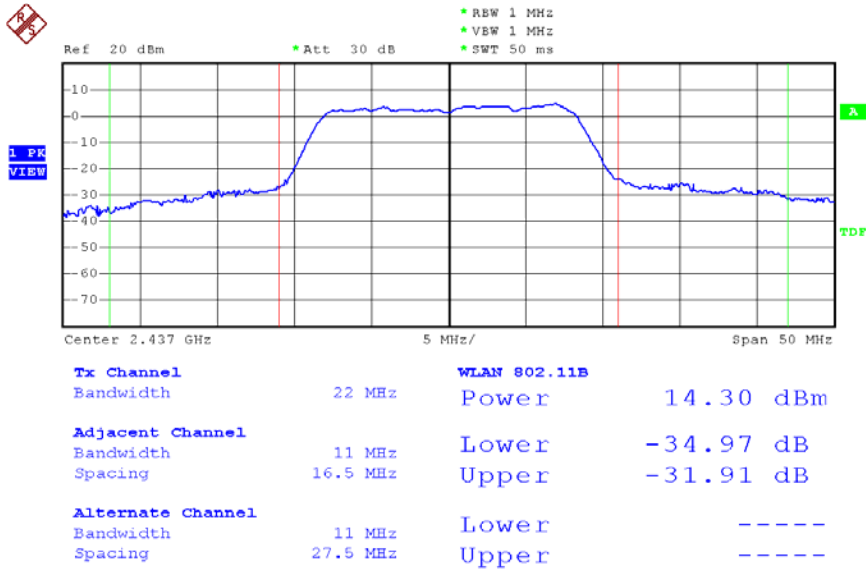

Date: 15.MAR.2006 11:02:50

Channel:11

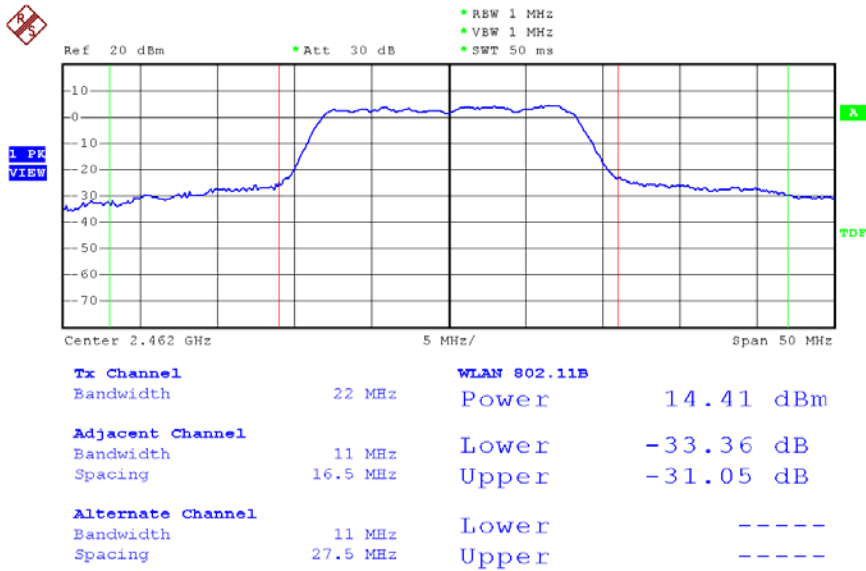

Date: 15.MAR.2006 11:00:45

8. Band Edges Measurement

8.1 Test Limit

Below -20dB of the highest emission level of operating band (in 100kHz Resolution Bandwidth).

8.2 Test Procedure :

- a. The transmitter output was connected to the spectrum analyzer via a low lose cable.
- b. Set both RBW and VBW of spectrum analyzer to 100 KHz with convenient frequency span including 100 KHz bandwidth from band edge.
- c. The band edges was measured and recorded.

8.3 Test Setup Layout

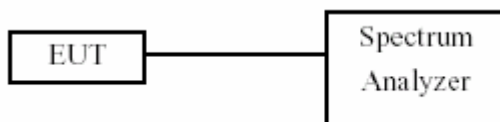

8.4 Measurement equipment

Instrument/Ancillary	Model No.	Manufacturer	Serial No.	Valid Date
Spectrum Analyzer	FSP40	R&S	100047	2007/01/16

8.5 Test Result and Data

(1) Modulation Standard: IEEE 802.11b (11Mbps)

Test Date: Mar. 17, 2006 Temperature: 24 Humidity: 65% Atmospheric pressure: 1021 hPa

Channel	Frequency	maximum value in frequency (MHz)	maximum value is (dBm)
01	2412	2398.2	-34.09
11	2462	2485.1	-37.57

(2) Modulation Standard: IEEE 802.11g (24Mbps)

Test Date: Mar. 17, 2006 Temperature: 24 Humidity: 65% Atmospheric pressure: 1021 hPa

Channel	Frequency	maximum value in frequency (MHz)	maximum value is (dBm)
01	2412	2398.2	-41.43
11	2462	2484.3	-43.93

Modulation Standard: 802.11b (11Mbps)

Channel: 01

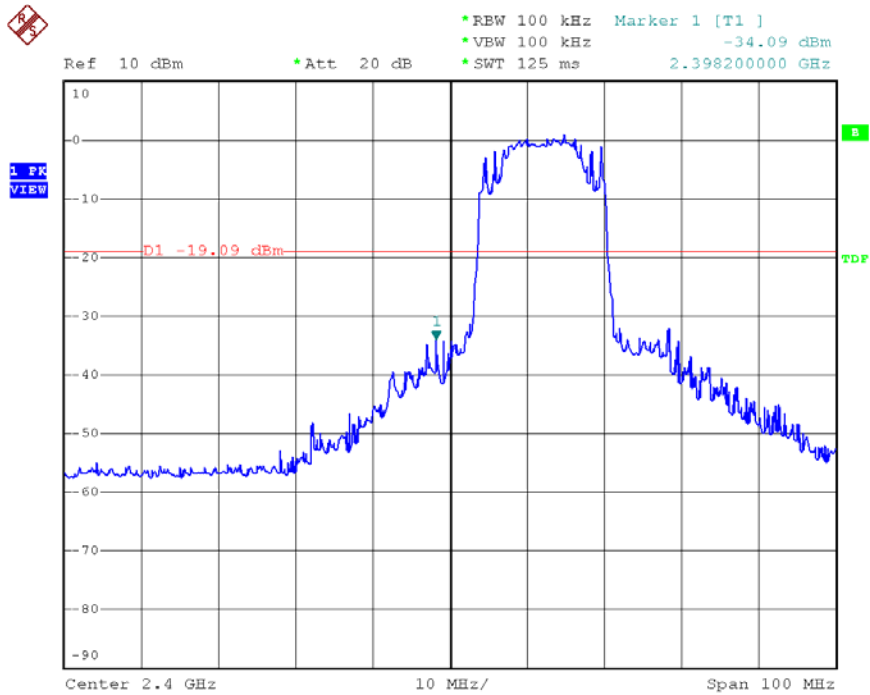

Date: 15.MAR.2006 14:35:42

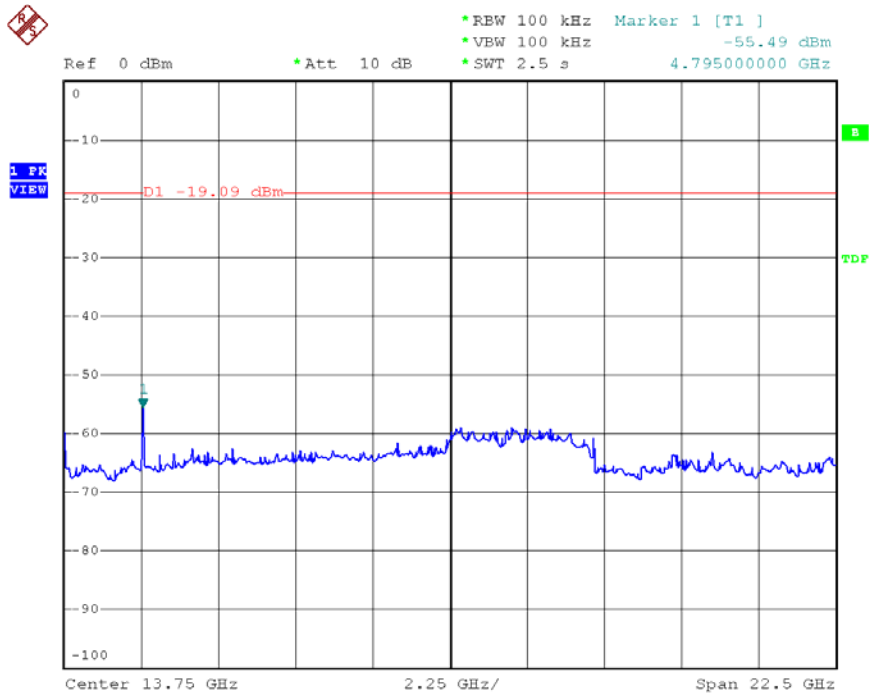

Date: 15.MAR.2006 14:37:49

Channel: 11

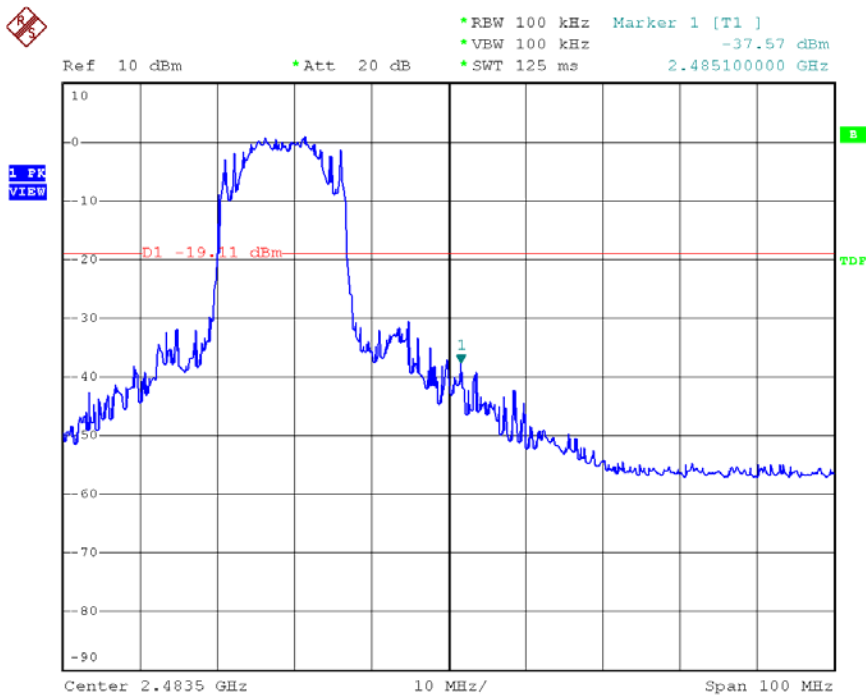

Date: 15.MAR.2006 14:41:16

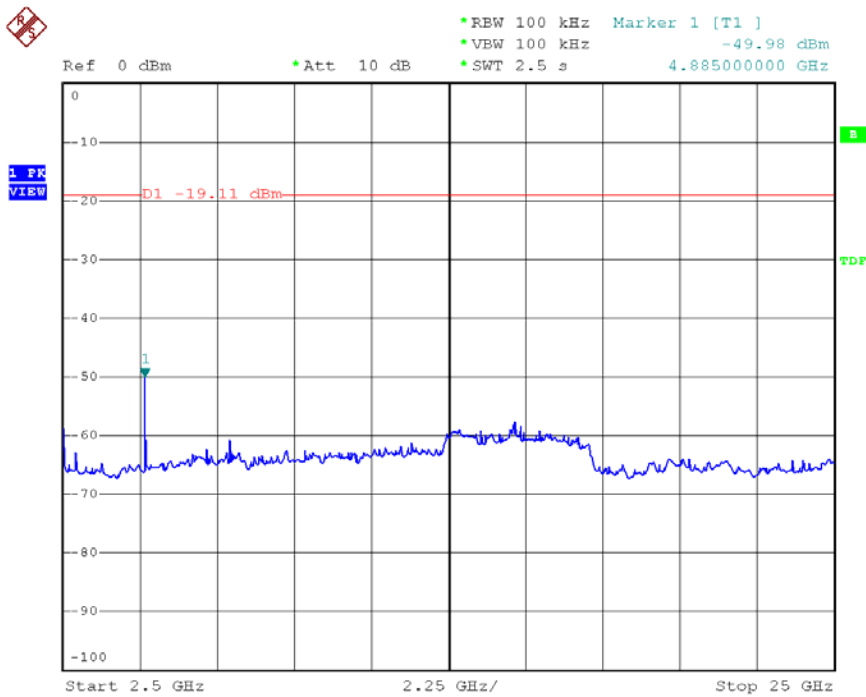

Date: 15.MAR.2006 14:42:51

Modulation Standard: 802.11g (24Mbps)

Channel: 01

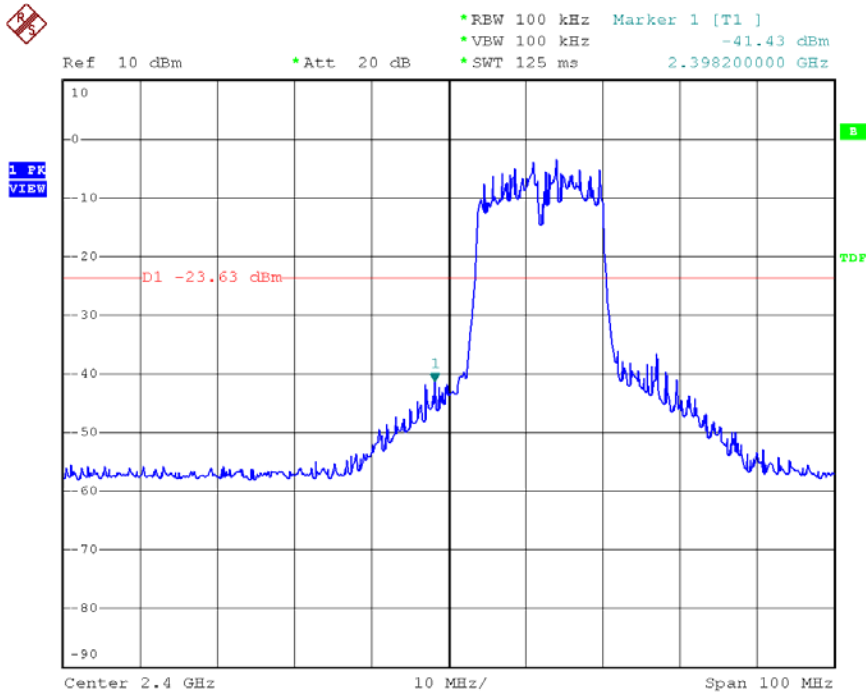

Date: 15.MAR.2006 14:48:20

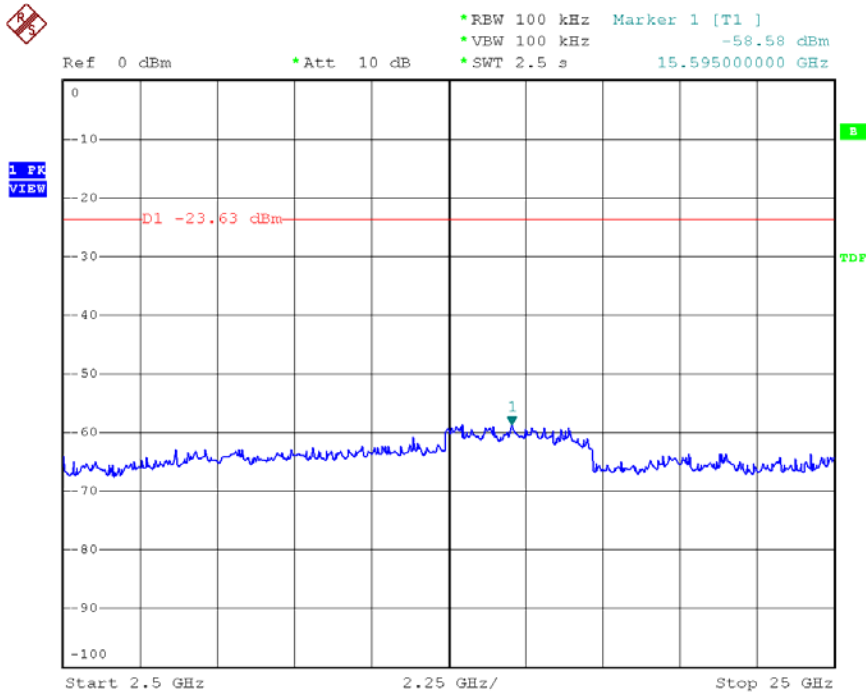

Date: 15.MAR.2006 14:49:49

Channel: 11

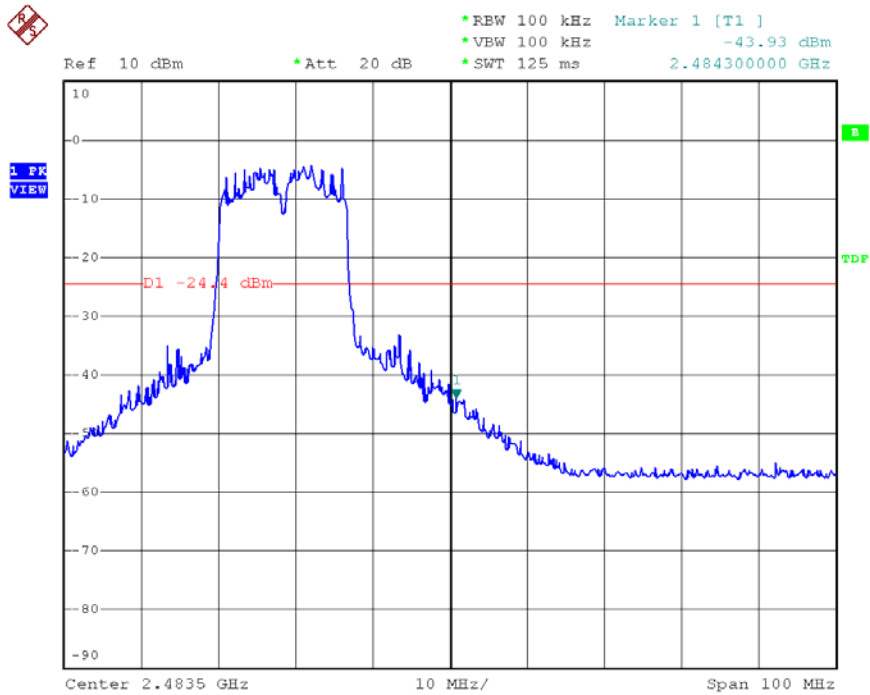

Date: 15.MAR.2006 14:52:43

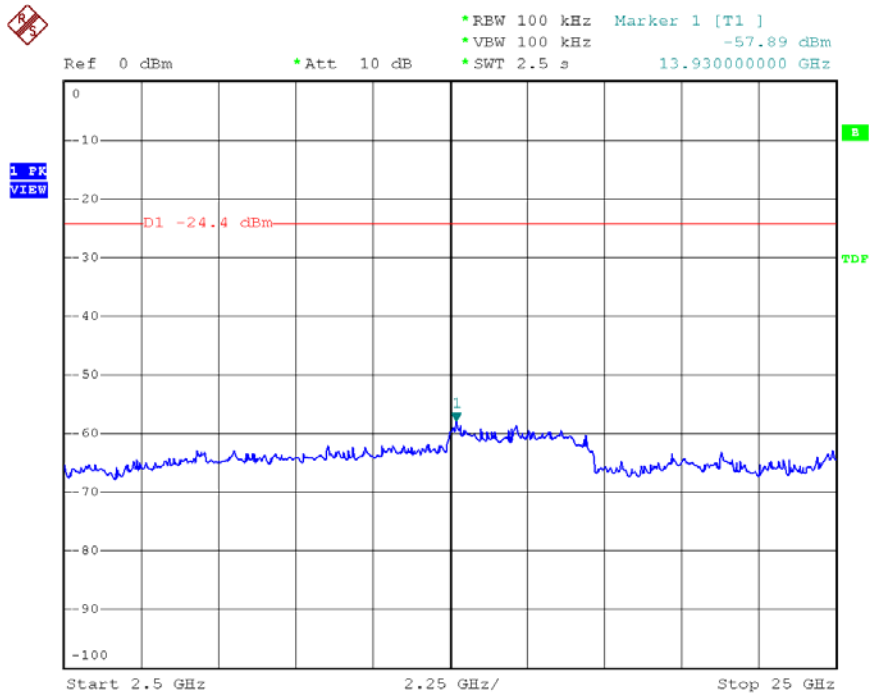

Date: 15.MAR.2006 14:54:09

8.6 Restrict band emission Measurement Data

Modulation Standard: IEEE 802.11b (11Mbps)

Test Date: Mar. 21, 2006 Temperature: 22 Humidity: 65% Atmospheric pressure: 1020 hPa

a) Channel 1

Frequency (MHz)	Ant-Pol H/V	Meter Reading	Corrected Factor	Result (dBuV/m)	Remark	Limit@3m (dBuV/m)		Margin (dB)	Table (Deg.)	Ant High (m)
						Peak	Ave.			
2389.764	H	50.13	-0.75	49.38	Peak	74	54	-24.62	235	1.1
2389.458	H	37.83	-0.75	37.08	Ave	74	54	-16.92	235	1.1
2389.254	V	54.01	-0.75	53.26	Peak	74	54	-20.74	341	1.0
2388.948	V	41.95	-0.76	41.19	Ave	74	54	-12.81	341	1.0

b) Channel 11

Frequency (MHz)	Ant-Pol H/V	Meter Reading	Corrected Factor	Result (dBuV/m)	Remark	Limit@3m (dBuV/m)		Margin (dB)	Table (Deg.)	Ant High (m)
						Peak	Ave.			
2483.736	H	50.93	-0.45	50.48	Peak	74	54	-23.52	235	1.1
2483.622	H	38.18	-0.45	37.73	Ave	74	54	-16.27	235	1.1
2484.306	V	49.77	-0.45	49.32	Peak	74	54	-24.68	341	1.0
2483.622	V	47.14	-0.45	46.69	Ave	74	54	-7.31	341	1.0

Modulation Standard: 802.11g (24Mbps)

Test Date: Mar. 21, 2006 Temperature: 22 Humidity: 65% Atmospheric pressure: 1020 hPa

a) Channel 1

Frequency (MHz)	Ant-Pol H/V	Meter Reading	Corrected Factor	Result (dBuV/m)	Remark	Limit@3m (dBuV/m)		Margin (dB)	Table (Deg.)	Ant High (m)
						Peak	Ave.			
2389.968	H	49.64	-0.75	48.89	Peak	74	54	-25.11	235	1.1
2389.254	H	37.58	-0.75	36.83	Ave	74	54	-17.17	235	1.1
2389.764	V	56.30	-0.75	55.55	Peak	74	54	-18.45	341	1.0
2389.764	V	44.33	-0.75	43.58	Ave	74	54	-10.42	341	1.0

b) Channel 11

Frequency (MHz)	Ant-Pol H/V	Meter Reading	Corrected Factor	Result (dBuV/m)	Remark	Limit@3m (dBuV/m)		Margin (dB)	Table (Deg.)	Ant High (m)
						Peak	Ave.			
2483.622	H	50.99	-0.45	50.54	Peak	74	54	-23.46	235	1.1
2483.546	H	39.00	-0.45	38.55	Ave	74	54	-15.45	235	1.1
2483.508	V	50.50	-0.45	50.05	Peak	74	54	-23.95	341	1.0
2483.736	V	48.43	-0.45	47.98	Ave	74	54	-6.02	341	1.0

Notes:

1. Result = Meter Reading + Factor
2. Factor = Antenna Factor + Cable Loss – Amplifier
3. The resolution bandwidth of test receiver/spectrum analyzer is 1 MHz and video bandwidth is 3 MHz for Peak detection at frequency above 1GHz.
4. The resolution bandwidth of test receiver/spectrum analyzer is 1MHz and video bandwidth is 10Hz for Average detection at frequency above 1GHz

9. Power Spectral Density

9.1 Test Limit

The Maximum of Power Spectral Density Measurement is 8dBm.

9.2 Test Procedures

- The transmitter output was connected to spectrum analyzer.
- The spectrum analyzer's resolution bandwidth were set at 3KHz RBW and 30KHz VBW as that of the fundamental frequency. Set the sweep time=span/3KHz.
- The power spectral density was measured and recorded.
- The Sweep time is allowed to be longer than span/3KHz for a full response of the mixer in the spectrum analyzer.

9.3 Test Setup Layout :

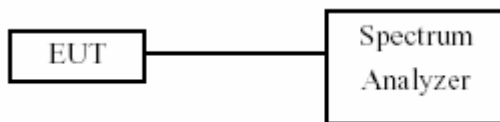

9.4 Measurement equipment

Instrument/Ancillary	Type	Manufacturer	Serial No.	Valid Date
Spectrum Analyzer	FSP40	R&S	100047	2007/01/16

9.5 Test Result and Data

(1) Modulation Standard: IEEE 802.11b (11Mbps)

Test Date: Mar. 17, 2006 Temperature: 24 Humidity: 65% Atmospheric pressure: 1021 hPa

Channel	Frequency	Maximum Power Density of 3 kHz Bandwidth (dBm)
01	2412	-13.33
06	2437	-13.48
11	2462	-12.51

(2) Modulation Standard: IEEE 802.11g (24Mbps)

Test Date: Mar. 17, 2006 Temperature: 24 Humidity: 65% Atmospheric pressure: 1021 hPa

Channel	Frequency	Maximum Power Density of 3 kHz Bandwidth (dBm)
01	2412	-18.42
06	2437	-16.97
11	2462	-16.79

Modulation Standard: 802.11b (11Mbps)
 Channel: 01

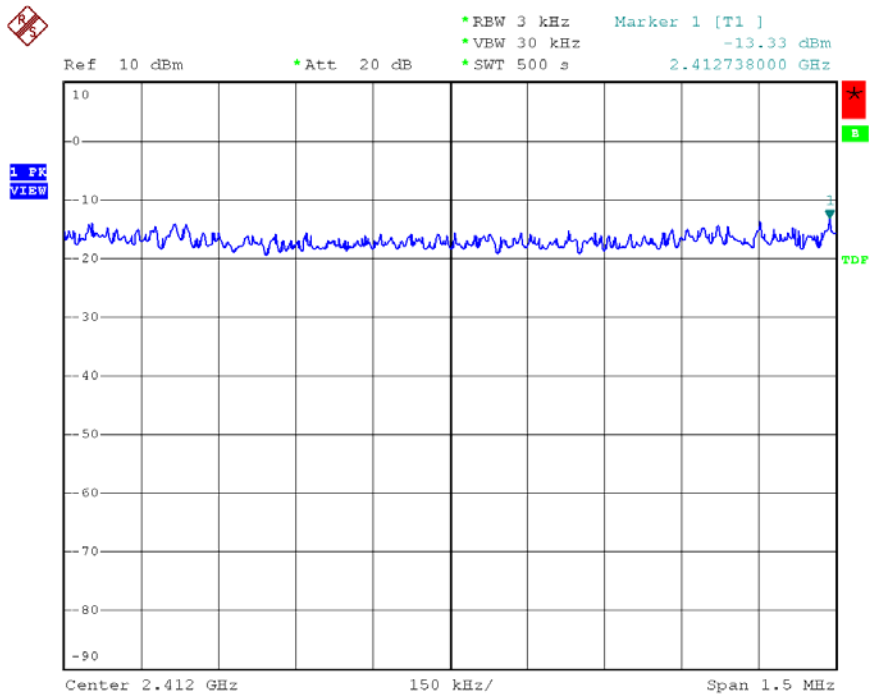

Date: 15.MAR.2006 13:28:50

Channel:06

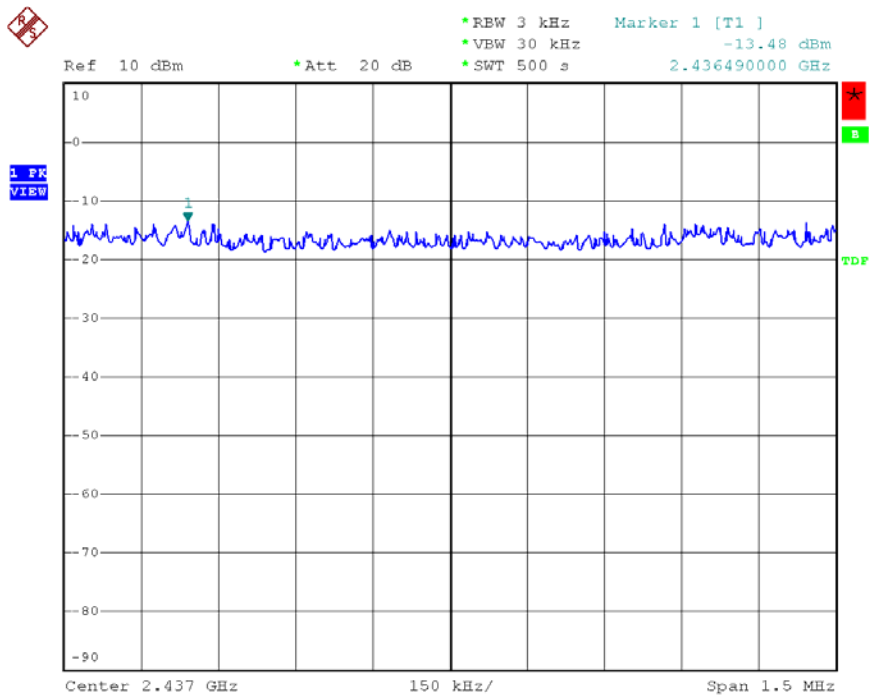

Date: 15.MAR.2006 13:39:30

Channel: 11

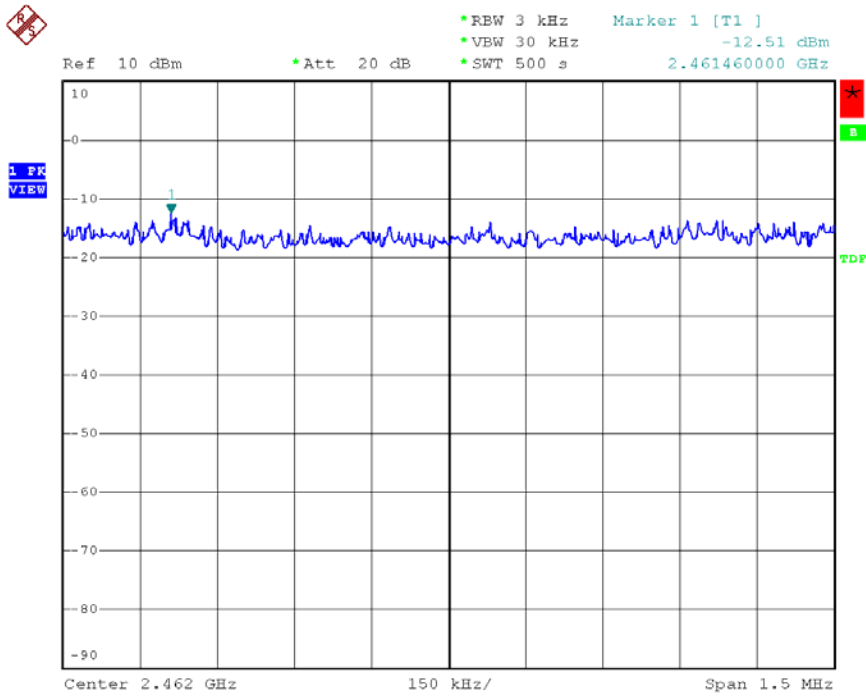

Date: 15.MAR.2006 13:49:54

Modulation Standard:802.11g (24Mbps)
Channel:01

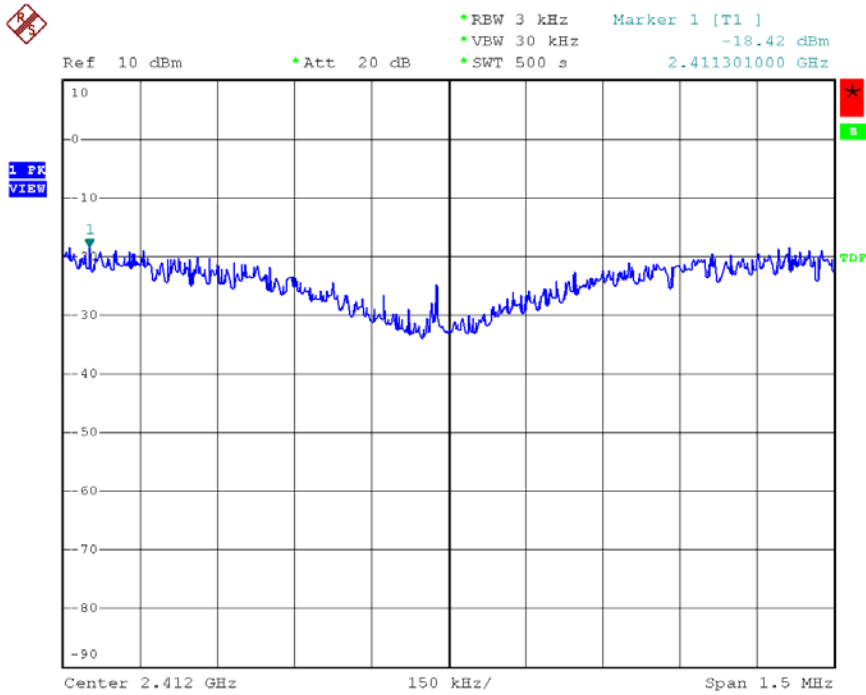

Date: 15.MAR.2006 16:03:37

Channel: 06

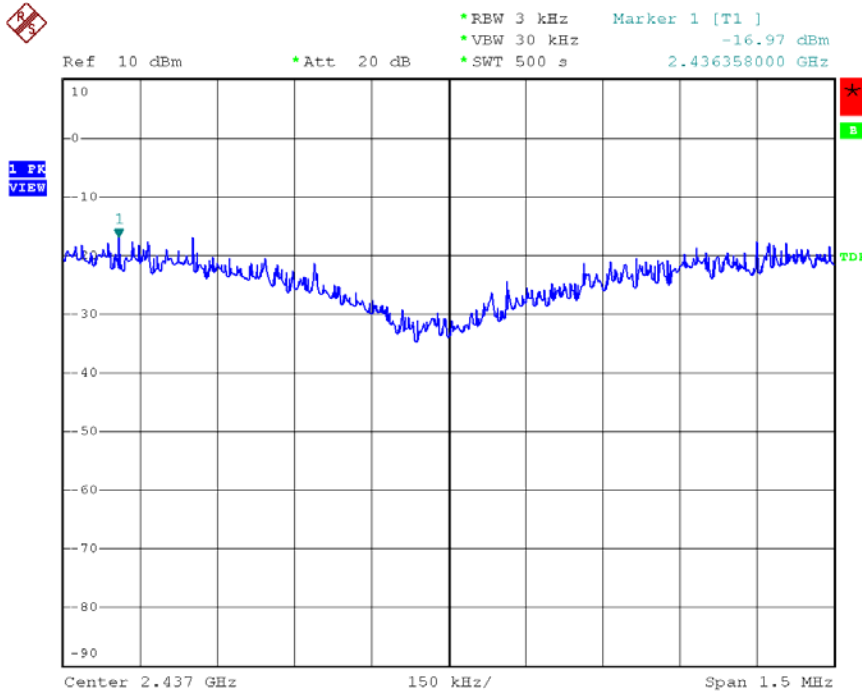

Date: 15.MAR.2006 15:53:44

Channel:11

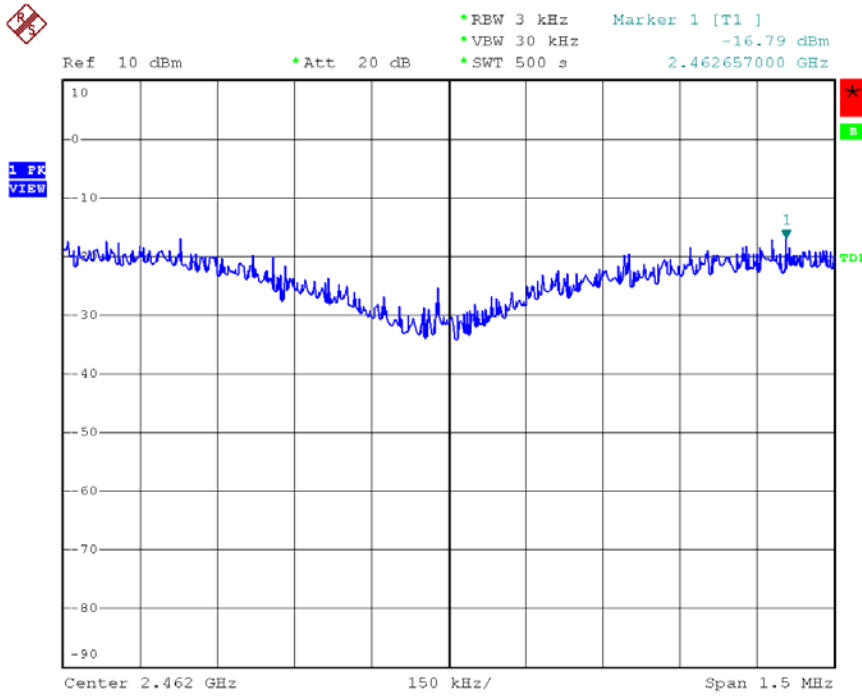

Date: 15.MAR.2006 15:40:46

10. Restricted Bands of Operation

Only spurious emissions are permitted in any of the frequency bands listed below:

MHz	MHz	MHz	GHz
0.09000 – 0.11000	16.42000 – 16.42300	399.9 – 410.0	4.500 – 5.250
0.49500 – 0.505**	16.69475 – 16.69525	608.0 – 614.0	5.350 – 5.460
2.17350 – 2.19050	16.80425 – 16.80475	960.0 – 1240.0	7.250 – 7.750
4.12500 – 4.12800	25.50000 – 25.67000	1300.0 – 1427.0	8.025 – 8.500
4.17725 – 4.17775	37.50000 – 38.25000	1435.0 – 1626.5	9.000 – 9.200
4.20725 – 4.20775	73.00000 – 74.60000	1645.5 – 1646.5	9.300 – 9.500
6.21500 – 6.21800	74.80000 – 75.20000	1660.0 – 1710.0	10.600 – 12.700
6.26775 – 6.26825	108.00000 – 121.94000	1718.8 – 1722.2	13.250 – 13.400
6.31175 – 6.31225	123.00000 – 138.00000	2200.0 – 2300.0	14.470 – 14.500
8.29100 – 8.29400	149.90000 – 150.05000	2310.0 – 2390.0	15.350 – 16.200
8.36200 – 8.36600	156.52475 – 156.52525	2483.5 – 2500.0	17.700 – 21.400
8.37625 – 8.38675	156.70000 – 156.90000	2655.0 – 2900.0	22.010 – 23.120
8.41425 – 8.41475	162.01250 – 167.17000	3260.0 – 3267.0	23.600 – 24.000
12.29000 – 12.29300	167.72000 – 173.20000	3332.0 – 3339.0	31.200 – 31.800
12.51975 – 12.52025	240.00000 – 285.00000	3345.8 – 3358.0	36.430 – 36.500
12.57675 – 12.57725	322.00000 – 335.40000	3600.0 – 4400.0	Above 38.6
13.36000 – 13.41000			

** : Until February 1, 1999, this restricted band shall be 0.490-0.510 MHz

10.1 Labeling Requirement

The device shall bear the following statement in a conspicuous location on the device:

This device complies with part 15 of the FCC Rules. Operation is subject to the following two conditions: (1) This device may not cause harmful interference, and (2) this device must accept any interference received, including interference that may cause undesired operation.