

# FCC RADIO TEST REPORT

**FCC ID** : K7S-03689  
**Equipment** : AX6600 Tri-band Mesh Router  
**Brand Name** : LINKSYS  
**Model Name** : MR7500, MR75WH  
**Applicant** : Belkin International, Inc.  
12045 East Waterfront Dr. Playa Vista CA United States Zip code: 90094  
**Standard** : 47 CFR FCC Part 15.407

The product was received on Dec. 07, 2020, and testing was started from Dec. 07, 2020 and completed on Feb. 05, 2021. We, SPORTON INTERNATIONAL INC. EMC & Wireless Communications Laboratory, would like to declare that the tested sample has been evaluated in accordance with the procedures given in ANSI C63.10-2013 and shown compliance with the applicable technical standards.

The test results in this report apply exclusively to the tested model / sample. Without written approval of SPORTON INTERNATIONAL INC. EMC & Wireless Communications Laboratory, the test report shall not be reproduced except in full.

  
Approved by: Sam Chen

**SPORTON INTERNATIONAL INC. EMC & Wireless Communications Laboratory**  
No. 52, Huaya 1st Rd., Guishan Dist., Taoyuan City, Taiwan (R.O.C.)



# Table of Contents

**History of this test report.....3**

**Summary of Test Result.....4**

**1 General Description .....5**

1.1 Information.....5

1.2 Applicable Standards .....9

1.3 Testing Location Information.....9

1.4 Measurement Uncertainty .....10

**2 Test Configuration of EUT .....11**

2.1 Test Channel Mode .....11

2.2 The Worst Case Measurement Configuration.....12

2.3 EUT Operation during Test .....14

2.4 Accessories .....14

2.5 Support Equipment.....15

2.6 Test Setup Diagram .....16

**3 Transmitter Test Result .....20**

3.1 AC Power-line Conducted Emissions .....20

3.2 Emission Bandwidth.....22

3.3 Maximum Conducted Output Power .....23

3.4 Peak Power Spectral Density.....25

3.5 Unwanted Emissions.....28

**4 Test Equipment and Calibration Data .....32**

**Appendix A. Test Results of AC Power-line Conducted Emissions**

**Appendix B. Test Results of Emission Bandwidth**

**Appendix C. Test Results of Maximum Conducted Output Power**

**Appendix D. Test Results of Peak Power Spectral Density**

**Appendix E. Test Results of Unwanted Emissions**

**Appendix F. Test Results of Radiated Emission Co-location**

**Appendix G. Test Photos**

**Photographs of EUT v01**





### Summary of Test Result

Report Clause	Ref Std. Clause	Test Items	Result (PASS/FAIL)	Remark
1.1.2	15.203	Antenna Requirement	PASS	-
3.1	15.207	AC Power-line Conducted Emissions	PASS	-
3.2	15.407(a)	Emission Bandwidth	PASS	-
3.3	15.407(a)	Maximum Conducted Output Power	PASS	-
3.4	15.407(a)	Peak Power Spectral Density	PASS	-
3.5	15.407(b)	Unwanted Emissions	PASS	-

**Declaration of Conformity:**

The test results with all measurement uncertainty excluded are presented in accordance with the regulation limits or requirements declared by manufacturers.

**Comments and Explanations:**

The declared of product specification for EUT presented in the report are provided by the manufacturer, and the manufacturer takes all the responsibilities for the accuracy of product specification.

**Reviewed by: Sam Chen**

**Report Producer: Sandy Chuang**



# 1 General Description

## 1.1 Information

### 1.1.1 RF General Information

Frequency Range (MHz)	IEEE Std. 802.11	Ch. Frequency (MHz)	Channel Number
5150-5250	a, n (HT20), ac (VHT20), ax (HEW20)	5180-5240	36-48 [4]
5725-5850		5745-5825	149-165 [5]
5150-5250	n (HT40), ac (VHT40), ax (HEW40)	5190-5230	38-46 [2]
5725-5850		5755-5795	151-159 [2]
5150-5250	ac (VHT80), ax (HEW80)	5210	42 [1]
5725-5850		5775	155 [1]

Band	Mode	BWch (MHz)	Nant
5.15-5.25GHz	802.11a	20	2
5.15-5.25GHz	802.11n HT20	20	2
5.15-5.25GHz	802.11n HT20-BF	20	2
5.15-5.25GHz	802.11ac VHT20	20	2
5.15-5.25GHz	802.11ac VHT20-BF	20	2
5.15-5.25GHz	802.11ax HEW20	20	2
5.15-5.25GHz	802.11ax HEW20-BF	20	2
5.15-5.25GHz	802.11n HT40	40	2
5.15-5.25GHz	802.11n HT40-BF	40	2
5.15-5.25GHz	802.11ac VHT40	40	2
5.15-5.25GHz	802.11ac VHT40-BF	40	2
5.15-5.25GHz	802.11ax HEW40	40	2
5.15-5.25GHz	802.11ax HEW40-BF	40	2
5.15-5.25GHz	802.11ac VHT80	80	2
5.15-5.25GHz	802.11ac VHT80-BF	80	2
5.15-5.25GHz	802.11ax HEW80	80	2
5.15-5.25GHz	802.11ax HEW80-BF	80	2
5.725-5.85GHz	802.11a	20	2
5.725-5.85GHz	802.11n HT20	20	2
5.725-5.85GHz	802.11n HT20-BF	20	2
5.725-5.85GHz	802.11ac VHT20	20	2
5.725-5.85GHz	802.11ac VHT20-BF	20	2
5.725-5.85GHz	802.11ax HEW20	20	2
5.725-5.85GHz	802.11ax HEW20-BF	20	2
5.725-5.85GHz	802.11n HT40	40	2



Band	Mode	BWch (MHz)	Nant
5.725-5.85GHz	802.11n HT40-BF	40	2
5.725-5.85GHz	802.11ac VHT40	40	2
5.725-5.85GHz	802.11ac VHT40-BF	40	2
5.725-5.85GHz	802.11ax HEW40	40	2
5.725-5.85GHz	802.11ax HEW40-BF	40	2
5.725-5.85GHz	802.11ac VHT80	80	2
5.725-5.85GHz	802.11ac VHT80-BF	80	2
5.725-5.85GHz	802.11ax HEW80	80	2
5.725-5.85GHz	802.11ax HEW80-BF	80	2

Note:

- ♦ 11a, HT20 and HT40 use a combination of OFDM-BPSK, QPSK, 16QAM, 64QAM modulation.
- ♦ VHT20, VHT40, VHT80 use a combination of OFDM-BPSK, QPSK, 16QAM, 64QAM, 256QAM modulation.
- ♦ HEW20, HEW40, HEW80 use a combination of OFDMA-BPSK, QPSK, 16QAM, 64QAM, 256QAM, 1024QAM modulation.
- ♦ BWch is the nominal channel bandwidth.



1.1.2 Antenna Information

Ant.	Port	Brand Holder	Model Name	Antenna Type	Connector	Gain (dBi)
1	1	Signal Plus Technology Co., Ltd	6239F00003	Dipole	I-PEX	Note 1
2	2	Signal Plus Technology Co., Ltd	6239F00004	Dipole	I-PEX	
3	1	Signal Plus Technology Co., Ltd	6239F00001	Dipole	I-PEX	
4	2	Signal Plus Technology Co., Ltd	6239F00001	Dipole	I-PEX	
5	3	Signal Plus Technology Co., Ltd	6239F00002	Dipole	I-PEX	
6	4	Signal Plus Technology Co., Ltd	6239F00002	Dipole	I-PEX	
7	1	Signal Plus Technology Co., Ltd	6239F00005	PIFA	N/A	

Note 1:

Ant.	Port	Gain (dBi)							Bluetooth
		WLAN 2.4GHz	WLAN 5GHz		WLAN 6GHz				
			UNII 1	UNII 3	UNII 5	UNII 6	UNII 7	UNII 8	
1	1	1.61	2.12	2.08	-	-	-	-	-
2	2	1.65	2.12	2.08	-	-	-	-	-
3	1	-	-	-	2.75	2.83	2.83	2.98	-
4	2	-	-	-	1.72	2.15	2.15	2.37	-
5	3	-	-	-	2.02	2.21	2.21	2.55	-
6	4	-	-	-	2.42	2.54	2.54	2.73	-
7	1	-	-	-	-	-	-	-	4

Note 2: The above information was declared by manufacturer.

<For WLAN 2.4GHz >

**For IEEE 802.11b/g/n/VHT/ax mode (2TX/2RX)**

Port 1 and Port 2 can be used as transmitting/receiving antenna.

Port 1 and Port 2 could transmit/receive simultaneously.

<For WLAN 5GHz Band UNII 1/UNII 3>

**For IEEE 802.11a/n/ac/ax mode (2TX/2RX)**

Port 1 and Port 2 can be used as transmitting/receiving antenna.

Port 1 and Port 2 could transmit/receive simultaneously.

<For WLAN 6GHz Band UNII 5~UNII 8>

**For IEEE 802.11ax mode (4TX/4RX)**

Port 1, Port 2, Port 3 and Port 4 can be used as transmitting/receiving antenna.

Port 1, Port 2, Port 3 and Port 4 could transmit/receive simultaneously.

<For Bluetooth> (1TX/1RX)

Only Port 1 can be used as transmitting/receiving.



### 1.1.3 Mode Test Duty Cycle

Mode	DC	DCF(dB)	T(s)	VBW(Hz) ≥ 1/T
802.11a	0.931	0.31	1.987m	1k
802.11ax HEW20-BF	0.949	0.23	1.771m	1k
802.11ax HEW40-BF	0.968	0.14	20.032m	100
802.11ax HEW80-BF	0.925	0.34	1.699m	1k

Note:

- ◆ DC is Duty Cycle.
- ◆ DCF is Duty Cycle Factor.

### 1.1.4 EUT Operational Condition

<b>EUT Power Type</b>	From Power Adapter			
<b>Beamforming Function</b>	<input checked="" type="checkbox"/> With beamforming	<input type="checkbox"/> Without beamforming		
	The product has beamforming function for n/VHT/ax in 2.4GHz, n/ac/ax in 5GHz UNII 1/UNII 3 and ax in 6GHz UNII 5~UNII 8.			
<b>Function</b>	<input type="checkbox"/> Outdoor P2M	<input checked="" type="checkbox"/> Indoor P2M		
	<input type="checkbox"/> Fixed P2P	<input type="checkbox"/> Client		
<b>Test Software Version</b>	<Non-beamforming mode> QSPR V5.0-00188 <beamforming mode>DOC V6.1.7601 \ Lantest v2.0.0.2			

Note: The above information was declared by manufacturer.

### 1.1.5 Table for Multiple Listing

Model No.	Description
MR7500, MR75WH	All the model names are identical, the difference model names served as marketing strategy.

Note 1: Model Name: MR7500 was selected as representative model for the test and its data was recorded in this report.

Note 2: The above information was declared by manufacturer.





### 1.2 Applicable Standards

According to the specifications of the manufacturer, the EUT must comply with the requirements of the following standards:

- ◆ 47 CFR FCC Part 15
- ◆ ANSI C63.10-2013
- ◆ FCC KDB 789033 D02 v02r01

The following reference test guidance is not within the scope of accreditation of TAF.

- ◆ FCC KDB 662911 D01 v02r01
- ◆ FCC KDB 412172 D01 v01r01
- ◆ FCC KDB 414788 D01 v01r01

### 1.3 Testing Location Information

Testing Location		
<input type="checkbox"/>	HWA YA	ADD : No. 52, Huaya 1st Rd., Guishan Dist., Taoyuan City, Taiwan (R.O.C.) TEL : 886-3-327-3456 FAX : 886-3-327-0973
<input checked="" type="checkbox"/>	JHUBEI	ADD : No.8, Ln. 724, Bo'ai St., Zhubei City, Hsinchu County 302, Taiwan (R.O.C.) TEL : 886-3-656-9065 FAX : 886-3-656-9085

Test Condition	Test Site No.	Test Engineer	Test Environment (°C / %)	Test Date
RF Conducted	TH01-CB	Jeff Wu	24.1-25.9 / 55-56	Dec. 25, 2020~ Jan. 26, 2021
Radiated (Above 1GHz)	03CH01-CB	Bruce Yang	21.5-22.5 / 54-57	Dec. 07, 2020~ Feb. 05, 2021
	03CH02-CB	Bruce Yang	20.4-21.4 / 55-57	
Radiated (Below 1GHz: Mode 1~Mode 5)	03CH05-CB	Bruce Yang	21.1-22.3 / 56-58	Dec. 07, 2020~ Feb. 05, 2021
Radiated (Below 1GHz: Mode 6)	03CH03-CB	Bruce Yang	22.3-23.3 / 56-58	Dec. 07, 2020~ Feb. 05, 2021
Radiated (Co-location)	03CH01-CB	Bruce Yang	21.1-22.1 / 55-57	Dec. 07, 2020~ Feb. 05, 2021
AC Conduction	CO01-CB	Peter Wu	22~23 / 62~64	Jan. 28, 2021

Test site Designation No. TW0006 with FCC.  
Test site registered number IC 4086D with Industry Canada.



### 1.4 Measurement Uncertainty

ISO/IEC 17025 requires that an estimate of the measurement uncertainties associated with the emissions test results be included in the report. The measurement uncertainties given below are based on a 95% confidence level (based on a coverage factor (k=2))

Test Items	Uncertainty	Remark
Conducted Emission (150kHz ~ 30MHz)	2.0 dB	Confidence levels of 95%
Radiated Emission (9kHz ~ 30MHz)	3.8 dB	Confidence levels of 95%
Radiated Emission (30MHz ~ 1,000MHz)	5.6 dB	Confidence levels of 95%
Radiated Emission (1GHz ~ 18GHz)	5.0 dB	Confidence levels of 95%
Radiated Emission (18GHz ~ 40GHz)	4.9 dB	Confidence levels of 95%
Conducted Emission	2.8 dB	Confidence levels of 95%
Output Power Measurement	1.4 dB	Confidence levels of 95%
Power Density Measurement	2.8 dB	Confidence levels of 95%
Bandwidth Measurement	0.4%	Confidence levels of 95%



## 2 Test Configuration of EUT

### 2.1 Test Channel Mode

Mode	Power Setting
802.11a_Nss1,(6Mbps)_2TX	-
5180MHz	23
5200MHz	26
5240MHz	26
5745MHz	27
5785MHz	27
5825MHz	27
802.11ax HEW20-BF_Nss1,(MCS0)_2TX	-
5180MHz	26
5200MHz	27
5240MHz	27
5745MHz	27
5785MHz	27
5825MHz	27
802.11ax HEW40-BF_Nss1,(MCS0)_2TX	-
5190MHz	25
5230MHz	27
5755MHz	27
5795MHz	27
802.11ax HEW80-BF_Nss1,(MCS0)_2TX	-
5210MHz	24
5775MHz	25

Note:

- ◆ The EUT supports non-beamforming and beamforming modes, after evaluating, the beamforming mode has been evaluated to be the worst case, so it was selected to test.
- ◆ Evaluated HEW20/HEW40/HEW80 mode only, due to similar modulation. The power setting of HT20/HT40/VHT20/VHT40/VHT80 mode are the same or lower than HEW20/HEW40/HEW80.



## 2.2 The Worst Case Measurement Configuration

The Worst Case Mode for Following Conformance Tests	
<b>Tests Item</b>	AC power-line conducted emissions
<b>Condition</b>	AC power-line conducted measurement for line and neutral
<b>Operating Mode</b>	Normal Link
1	EUT with Adapter 1
2	EUT with Adapter 2
3	EUT with Adapter 3
For operating mode 2 is the worst case and it was record in this test report.	

The Worst Case Mode for Following Conformance Tests	
<b>Tests Item</b>	Emission Bandwidth Maximum Conducted Output Power Peak Power Spectral Density Unwanted Emissions
<b>Test Condition</b>	Conducted measurement at transmit chains



<b>The Worst Case Mode for Following Conformance Tests</b>	
<b>Tests Item</b>	Unwanted Emissions
<b>Test Condition</b>	Radiated measurement If EUT consist of multiple antenna assembly (multiple antenna are used in EUT regardless of spatial multiplexing MIMO configuration), the radiated test should be performed with highest antenna gain of each antenna type.
<b>Operating Mode &lt; 1GHz</b>	CTX
The EUT was performed at Y axis and Z axis position for Radiated measurement<Above 1GHz>, and the worst case was found at Z axis position for 2.4GHz、5GHz UNII 1/UNII 3、Bluetooth and Y axis position for 6GHz UNII 5~UNII 8.	
1	EUT + Bluetooth with Adapter 1 in Z axis
2	EUT + Bluetooth with Adapter 2 in Z axis
3	EUT + Bluetooth with Adapter 3 in Z axis
Mode 1 has been evaluated to be the worst case among Mode 1~3, thus measurement for Mode 4 ~ 6 will follow this same test mode.	
4	EUT + WLAN 2.4GHz with Adapter 1 in Z axis
5	EUT + WLAN 5GHz UNII 1/UNII 3 with Adapter 1 in Z axis
6	EUT + WLAN 6GHz UNII 5~UNII 8 with Adapter 1 in Y axis
For operating mode 1 is the worst case and it was record in this test report.	
<b>Operating Mode &gt; 1GHz</b>	CTX
The EUT was performed at Y axis and Z axis position. The worst case was found at Z axis, thus the measurement will follow this same test configuration.	

<b>The Worst Case Mode for Following Conformance Tests</b>	
<b>Tests Item</b>	Simultaneous Transmission Analysis - Radiated Emission Co-location
<b>Test Condition</b>	Radiated measurement
<b>Operating Mode</b>	Normal Link
The EUT can be placed in Y axis and Z axis. EUT Z axis has been evaluated to be the worst case at Emissions in Radiated measurement <Above 1GHz> ; thus, the measurement will follow this same test configuration.	
1	EUT in Z axis + WLAN 2.4GHz + WLAN 5GHz UNII 1/UNII 3
Refer to Appendix F for Radiated Emission Co-location.	

<b>The Worst Case Mode for Following Conformance Tests</b>	
<b>Tests Item</b>	Simultaneous Transmission Analysis - Co-location RF Exposure Evaluation
<b>Operating Mode</b>	
1	WLAN 2.4GHz + WLAN 5GHz UNII 1/UNII 3 + WLAN 6GHz UNII 5~UNII 8 + Bluetooth
Refer to Sporton Test Report No.: FA0D0129 for Co-location RF Exposure Evaluation.	



### 2.3 EUT Operation during Test

For CTX Mode:

**<Non-beamforming mode>**

The EUT was programmed to be in continuously transmitting mode.

**<beamforming mode>**

During the test, the following programs under WIN 7 were executed.

The program was executed as follows:

1. During the test, the EUT operation to normal function.
2. Executed command fixed test channel under DOS.
3. Executed "Lantest.exe" to link with the remote workstation to transmit and receive packet by RX Device and transmit duty cycle no less than 98%.

For Normal Link Mode:

During the test, the EUT operation to normal function.

### 2.4 Accessories

Accessories			
Equipment Name	Brand Name	Model Name	Rating
Adapter 1	KTEC	KSA-36W-120300HU	Input: 100-240V~50/60Hz 1.0A Output: 12.0V, 3.0A
Adapter 2	APD	WA-36N12FU	Input: 100-240V~, 50-60Hz 0.9A Max. Output: 12V, 3A
Adapter 3 (Interchangeable)	KTEC	KSA-36W-120300D5	Input: 100-240V~50/60Hz 1.0A Output: 12.0V, 3.0A, 36.0W
Other			
Plug*1 (Use for Adapter 3)			
RJ-45 cable*1: Non-Shielded, 0.9m			



## 2.5 Support Equipment

For AC Conduction:

Support Equipment				
No.	Equipment	Brand Name	Model Name	FCC ID
A	LAN1 NB	DELL	E6430	N/A
B	WAN PC	DELL	T3400	N/A
C	2.4G NB	DELL	E6430	N/A
D	5G NB	Apple	A1278	N/A
E	Smart phone	Samsung	Galaxy J2	N/A
F	WiFi 6E Client	LINKSYS	Divo	N/A
G	WiFi 6E Client NB	DELL	E6430	N/A
H	Flash disk3.0	Transcend	JetFlash-700	N/A

For Radiated (below 1GHz):

Support Equipment				
No.	Equipment	Brand Name	Model Name	FCC ID
A	NB	DELL	E4300	N/A

For Radiated (above 1GHz) and RF Conducted:  
<Non-beamforming mode>

Support Equipment				
No.	Equipment	Brand Name	Model Name	FCC ID
A	NB	DELL	E4300	N/A

<beamforming mode>

Support Equipment				
No.	Equipment	Brand Name	Model Name	FCC ID
A	NB	DELL	E4300	N/A
B	NB	DELL	E4300	N/A
C	RX Device	Cybertan	DIVO	N/A

## 2.6 Test Setup Diagram

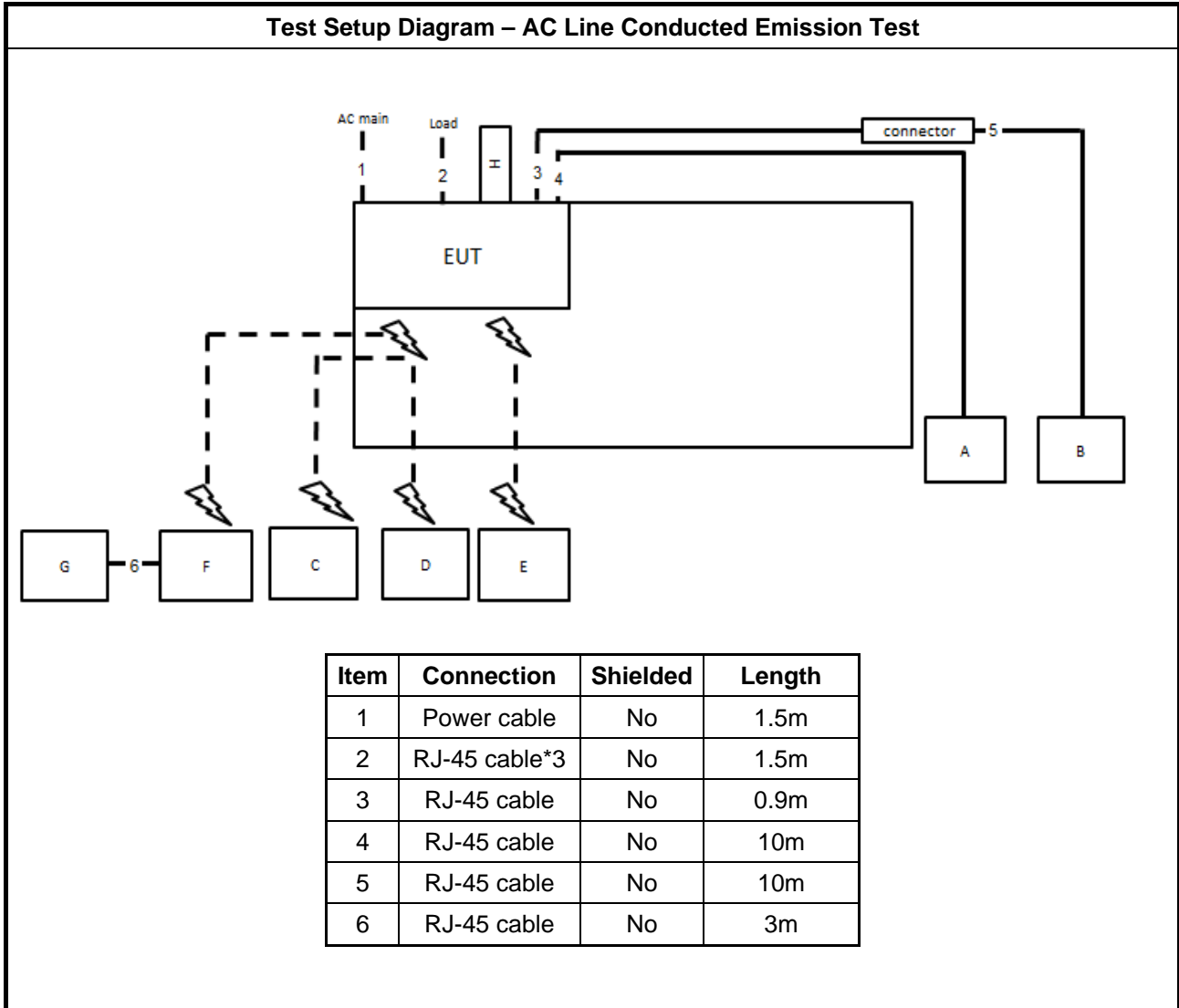





Test Setup Diagram - Radiated Test < 1GHz

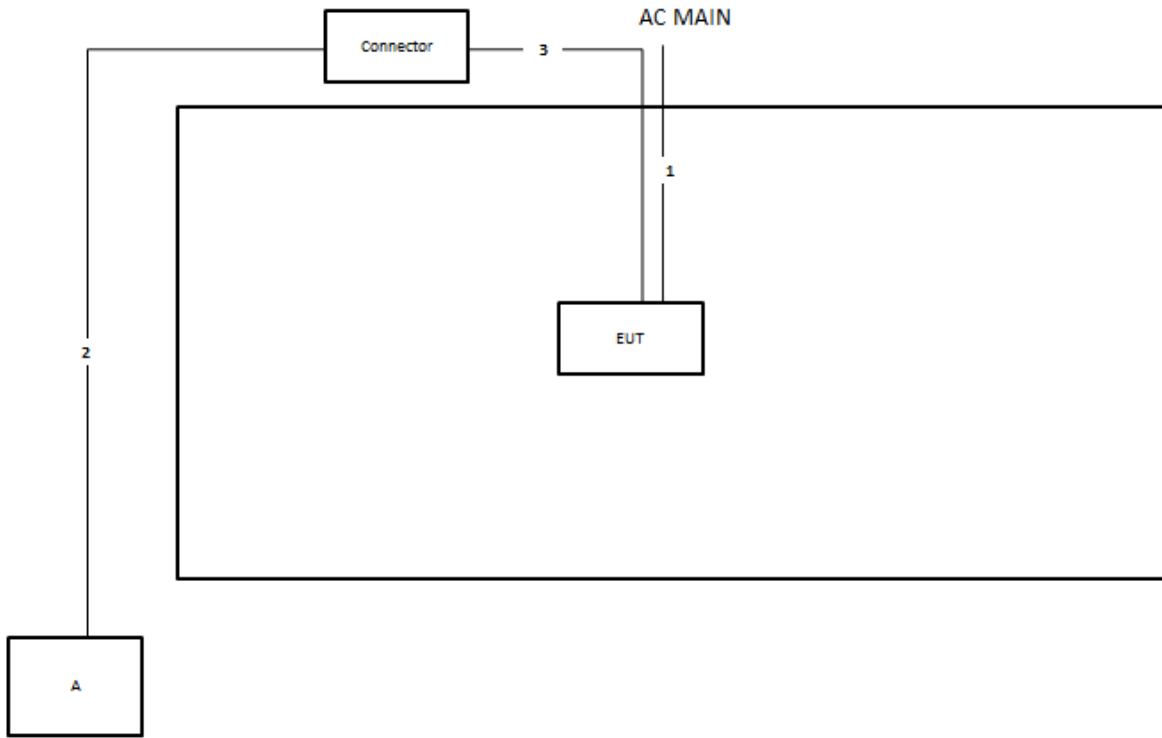

Item	Connection	Shielded	Length
1	Power cable	No	1.5m
2	RJ-45 cable	No	10m
3	RJ-45 cable	No	0.9m



Test Setup Diagram - Radiated Test > 1GHz

<Non-beamforming mode>

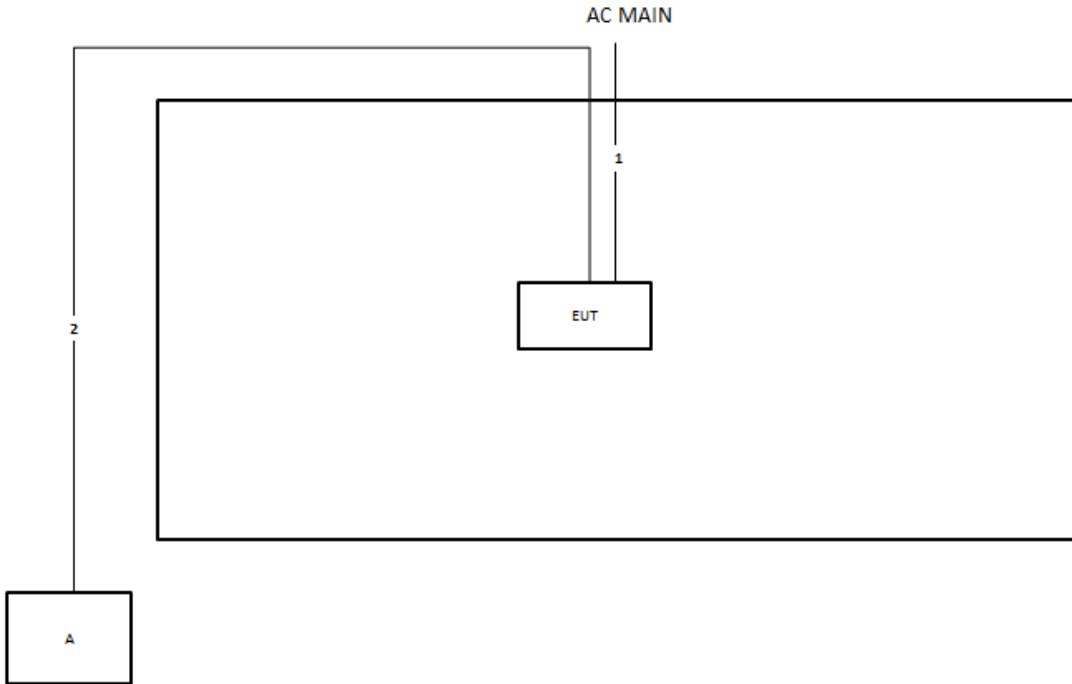

Item	Connection	Shielded	Length
1	Power cable	No	1.5m
2	RJ-45 cable	No	10m

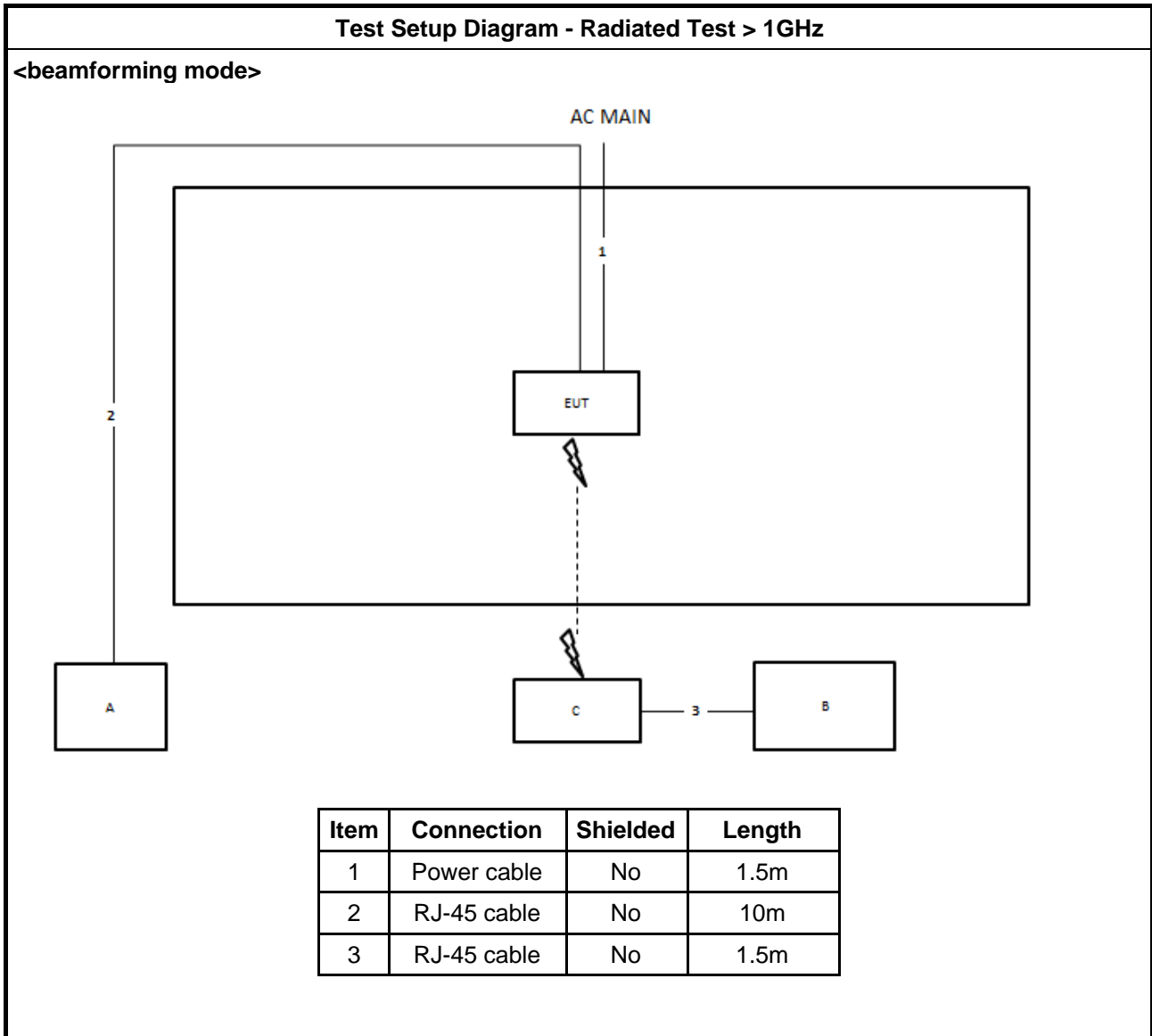



### 3 Transmitter Test Result

#### 3.1 AC Power-line Conducted Emissions

##### 3.1.1 AC Power-line Conducted Emissions Limit

AC Power-line Conducted Emissions Limit		
Frequency Emission (MHz)	Quasi-Peak	Average
0.15-0.5	66 - 56 *	56 - 46 *
0.5-5	56	46
5-30	60	50

Note 1: \* Decreases with the logarithm of the frequency.

##### 3.1.2 Measuring Instruments

Refer a test equipment and calibration data table in this test report.

##### 3.1.3 Test Procedures

Test Method
<input checked="" type="checkbox"/> Refer as ANSI C63.10-2013, clause 6.2 for AC power-line conducted emissions.

### 3.1.4 Test Setup

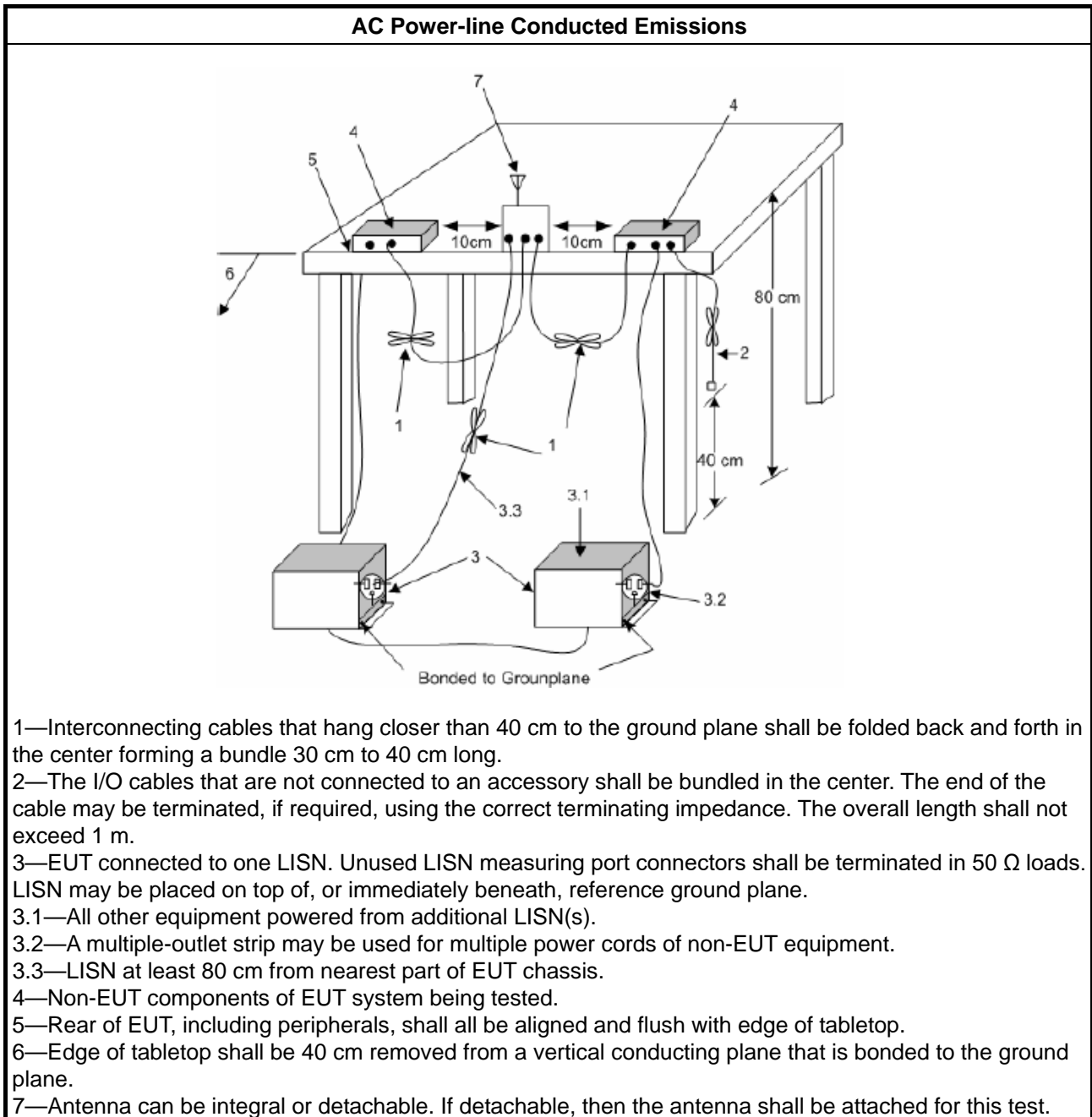

### 3.1.5 Measurement Results Calculation

The measured Level is calculated using:

- a. Corrected Reading: LISN Factor (LISN) + Attenuator (AT/AUX) + Cable Loss (CL) + Read Level (Raw) = Level
- b. Margin = -Limit + Level

### 3.1.6 Test Result of AC Power-line Conducted Emissions

Refer as Appendix A

### 3.2 Emission Bandwidth

#### 3.2.1 Emission Bandwidth Limit

Emission Bandwidth Limit	
<b>UNII Devices</b>	
<input checked="" type="checkbox"/>	For the 5.15-5.25 GHz band, N/A
<input type="checkbox"/>	For the 5.25-5.35 GHz band, the maximum conducted output power shall not exceed the lesser of 250 mW or 11 dBm + 10 log B, where B is the 26 dB emission bandwidth in MHz.
<input type="checkbox"/>	For the 5.47-5.725 GHz band, the maximum conducted output power shall not exceed the lesser of 250 mW or 11 dBm + 10 log B, where B is the 26 dB emission bandwidth in MHz.
<input checked="" type="checkbox"/>	For the 5.725-5.85 GHz band, 6 dB emission bandwidth $\geq$ 500kHz.
<b>LE-LAN Devices</b>	
<input type="checkbox"/>	For the band 5.15-5.25 GHz, the maximum e.i.r.p. shall not exceed 200 mW or 10 + 10 log B, dBm, whichever power is less. B is the 99% emission bandwidth in MHz.
<input type="checkbox"/>	For the 5.25-5.35 GHz band, the maximum e.i.r.p. shall not exceed 1.0 W or 17 + 10 log B, dBm, whichever power is less. B is the 99% emission bandwidth in MHz
<input type="checkbox"/>	For the 5.47-5.6 GHz band and 5.65-5.725 GHz band, the maximum e.i.r.p. shall not exceed 1.0 W or 17 + 10 log B, dBm, whichever power is less. B is the 99% emission bandwidth in MHz
<input type="checkbox"/>	For the 5.725-5.85 GHz band, 6 dB emission bandwidth $\geq$ 500kHz.

#### 3.2.2 Measuring Instruments

Refer a test equipment and calibration data table in this test report.

#### 3.2.3 Test Procedures

Test Method							
<ul style="list-style-type: none"> <li>▪ For the emission bandwidth shall be measured using one of the options below:           <table border="1" style="width: 100%; border-collapse: collapse;"> <tr> <td style="width: 30px;"><input checked="" type="checkbox"/></td> <td>Refer as FCC KDB 789033, clause C for EBW and clause D for OBW measurement.</td> </tr> <tr> <td><input type="checkbox"/></td> <td>Refer as ANSI C63.10, clause 6.9.1 for occupied bandwidth testing.</td> </tr> <tr> <td><input type="checkbox"/></td> <td>Refer as IC RSS-Gen, clause 4.6 for bandwidth testing.</td> </tr> </table> </li> </ul>		<input checked="" type="checkbox"/>	Refer as FCC KDB 789033, clause C for EBW and clause D for OBW measurement.	<input type="checkbox"/>	Refer as ANSI C63.10, clause 6.9.1 for occupied bandwidth testing.	<input type="checkbox"/>	Refer as IC RSS-Gen, clause 4.6 for bandwidth testing.
<input checked="" type="checkbox"/>	Refer as FCC KDB 789033, clause C for EBW and clause D for OBW measurement.						
<input type="checkbox"/>	Refer as ANSI C63.10, clause 6.9.1 for occupied bandwidth testing.						
<input type="checkbox"/>	Refer as IC RSS-Gen, clause 4.6 for bandwidth testing.						

#### 3.2.4 Test Setup

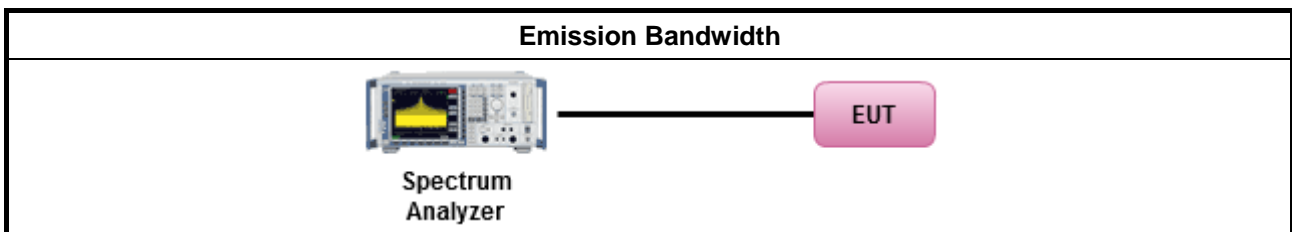

#### 3.2.5 Test Result of Emission Bandwidth

Refer as Appendix B



### 3.3 Maximum Conducted Output Power

#### 3.3.1 Maximum Conducted Output Power Limit

Maximum Conducted Output Power Limit	
<b>UNII Devices</b>	
<input checked="" type="checkbox"/> For the 5.15-5.25 GHz band:	
	<ul style="list-style-type: none"> <li>▪ Outdoor AP: the maximum conducted output power (<math>P_{Out}</math>) shall not exceed the lesser of 1 W. If <math>G_{TX} &gt; 6</math> dBi, then <math>P_{Out} = 30 - (G_{TX} - 6)</math>. e.i.r.p. at any elevation angle above 30 degrees <math>\leq 125mW</math> [21dBm]</li> <li>▪ Indoor AP: the maximum conducted output power (<math>P_{Out}</math>) shall not exceed the lesser of 1 W. If <math>G_{TX} &gt; 6</math> dBi, then <math>P_{Out} = 30 - (G_{TX} - 6)</math></li> <li>▪ Point-to-point AP: the maximum conducted output power (<math>P_{Out}</math>) shall not exceed the lesser of 1 W. If <math>G_{TX} &gt; 23</math> dBi, then <math>P_{Out} = 30 - (G_{TX} - 23)</math>.</li> <li>▪ Mobile or Portable Client: the maximum conducted output power (<math>P_{Out}</math>) shall not exceed the lesser of 250 mW. If <math>G_{TX} &gt; 6</math> dBi, then <math>P_{Out} = 24 - (G_{TX} - 6)</math>.</li> </ul>
<input type="checkbox"/> For the 5.25-5.35 GHz band, the maximum conducted output power ( $P_{Out}$ ) shall not exceed the lesser of 250 mW or 11 dBm + 10 log B, where B is the 26 dB emission bandwidth in MHz. If $G_{TX} > 6$ dBi, then $P_{Out} = 24 - (G_{TX} - 6)$ .	
<input type="checkbox"/> For the 5.47-5.725 GHz band, the maximum conducted output power ( $P_{Out}$ ) shall not exceed the lesser of 250 mW or 11 dBm + 10 log B, where B is the 26 dB emission bandwidth in MHz. If $G_{TX} > 6$ dBi, then $P_{Out} = 24 - (G_{TX} - 6)$ .	
<input checked="" type="checkbox"/> For the 5.725-5.85 GHz band:	
	<ul style="list-style-type: none"> <li>▪ Point-to-multipoint systems (P2M): the maximum conducted output power (<math>P_{Out}</math>) shall not exceed the lesser of 1 W. If <math>G_{TX} &gt; 6</math> dBi, then <math>P_{Out} = 30 - (G_{TX} - 6)</math>.</li> <li>▪ Point-to-point systems (P2P): the maximum conducted output power (<math>P_{Out}</math>) shall not exceed the lesser of 1 W.</li> </ul>
<b>LE-LAN Devices</b>	
<input type="checkbox"/> For the 5.15-5.25 GHz band, the maximum e.i.r.p. shall not exceed 200 mW or 10 + 10 log B, dBm, whichever power is less. B is the 99% emission bandwidth in MHz.	
<input type="checkbox"/> For the 5.25-5.35 GHz band, the maximum e.i.r.p. shall not exceed 1.0 W or 17 + 10 log B, dBm, whichever power is less. B is the 99% emission bandwidth in MHz	
<input type="checkbox"/> For the 5.47-5.6 GHz band and 5.65-5.725 GHz band, the maximum e.i.r.p. shall not exceed 1.0 W or 17 + 10 log B, dBm, whichever power is less. B is the 99% emission bandwidth in MHz	
<input type="checkbox"/> For the 5.725-5.85 GHz band:	
	<ul style="list-style-type: none"> <li>▪ Point-to-multipoint systems (P2M): the maximum conducted output power (<math>P_{Out}</math>) shall not exceed the lesser of 1 W. If <math>G_{TX} &gt; 6</math> dBi, then <math>P_{Out} = 30 - (G_{TX} - 6)</math>.</li> <li>▪ Point-to-point systems (P2P): the maximum conducted output power (<math>P_{Out}</math>) shall not exceed the lesser of 1 W.</li> </ul>
$P_{Out}$ = maximum conducted output power in dBm, $G_{TX}$ = the maximum transmitting antenna directional gain in dBi.	

### 3.3.2 Measuring Instruments

Refer a test equipment and calibration data table in this test report.

### 3.3.3 Test Procedures

Test Method	
<ul style="list-style-type: none"> <li>▪ Maximum Conducted Output Power</li> </ul>	
Average over on/off periods with duty factor	
<input type="checkbox"/>	Refer as FCC KDB 789033, clause E Method SA-2 (spectral trace averaging).
<input type="checkbox"/>	Refer as FCC KDB 789033, clause E Method SA-2 Alt. (RMS detection with slow sweep speed)
Wideband RF power meter and average over on/off periods with duty factor	
<input checked="" type="checkbox"/>	Refer as FCC KDB 789033, clause E Method PM-G (using an RF average power meter).
<ul style="list-style-type: none"> <li>▪ For conducted measurement.</li> </ul>	
<ul style="list-style-type: none"> <li>▪ If the EUT supports multiple transmit chains using options given below: Refer as FCC KDB 662911, In-band power measurements. Using the measure-and-sum approach, measured all transmit ports individually. Sum the power (in linear power units e.g., mW) of all ports for each individual sample and save them.</li> </ul>	
<ul style="list-style-type: none"> <li>▪ If multiple transmit chains, EIRP calculation could be following as methods:  <math>P_{total} = P_1 + P_2 + \dots + P_n</math>                      (calculated in linear unit [mW] and transfer to log unit [dBm])  <math>EIRP_{total} = P_{total} + DG</math> </li> </ul>	

### 3.3.4 Test Setup

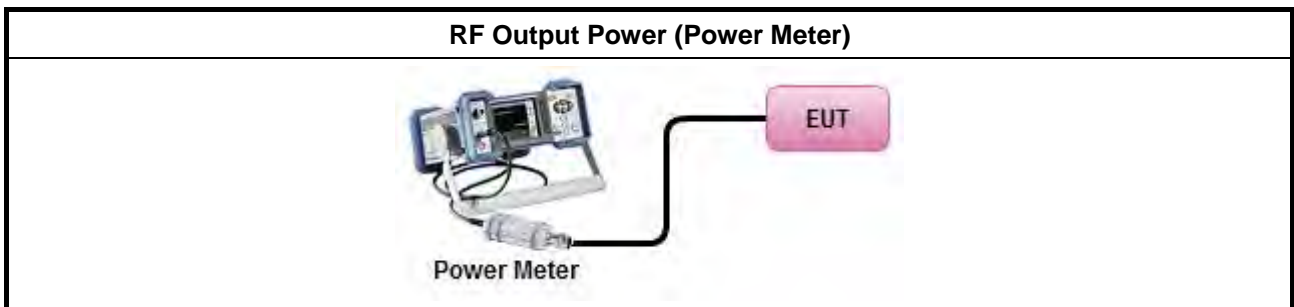

### 3.3.5 Test Result of Maximum Conducted Output Power

Refer as Appendix C





### 3.4 Peak Power Spectral Density

#### 3.4.1 Peak Power Spectral Density Limit

Peak Power Spectral Density Limit	
<b>UNII Devices</b>	
<input checked="" type="checkbox"/> For the 5.15-5.25 GHz band:	
<input type="checkbox"/>	<ul style="list-style-type: none"> <li>▪ Outdoor AP: the peak power spectral density (PPSD) shall not exceed the lesser of 17dBm/MHz. If <math>G_{TX} &gt; 6</math> dBi, then <math>P_{Out} = 17 - (G_{TX} - 6)</math>.</li> <li>▪ Indoor AP: the peak power spectral density (PPSD) shall not exceed the lesser of 17dBm/MHz. If <math>G_{TX} &gt; 6</math> dBi, then <math>P_{Out} = 17 - (G_{TX} - 6)</math>.</li> <li>▪ Point-to-point AP: the peak power spectral density (PPSD) shall not exceed the lesser of 17dBm/MHz. If <math>G_{TX} &gt; 23</math> dBi, then <math>P_{Out} = 17 - (G_{TX} - 23)</math>.</li> <li>▪ Mobile or Portable Client: the peak power spectral density (PPSD) <math>\leq 11</math> dBm/MHz. If <math>G_{TX} &gt; 6</math> dBi, then <math>PPSD = 11 - (G_{TX} - 6)</math>.</li> </ul>
<input type="checkbox"/>	For the 5.25-5.35 GHz band, the peak power spectral density (PPSD) $\leq 11$ dBm/MHz. If $G_{TX} > 6$ dBi, then $PPSD = 11 - (G_{TX} - 6)$ .
<input type="checkbox"/>	For the 5.47-5.725 GHz band, the peak power spectral density (PPSD) $\leq 11$ dBm/MHz. If $G_{TX} > 6$ dBi, then $PPSD = 11 - (G_{TX} - 6)$ .
<input checked="" type="checkbox"/> For the 5.725-5.85 GHz band:	
<input type="checkbox"/>	<ul style="list-style-type: none"> <li>▪ Point-to-multipoint systems (P2M): the peak power spectral density (PPSD) <math>\leq 30</math> dBm/500kHz. If <math>G_{TX} &gt; 6</math> dBi, then <math>PPSD = 30 - (G_{TX} - 6)</math>.</li> <li>▪ Point-to-point systems (P2P): the peak power spectral density (PPSD) <math>\leq 30</math> dBm/500kHz.</li> </ul>
<b>LE-LAN Devices</b>	
<input type="checkbox"/>	For the 5.15-5.25 GHz band, the e.i.r.p. peak power spectral density (PPSD) $\leq 10$ dBm/MHz.
<input type="checkbox"/>	For the 5.25-5.35 GHz band, the peak power spectral density (PPSD) $\leq 11$ dBm/MHz.
<input type="checkbox"/>	<ul style="list-style-type: none"> <li>▪ e.i.r.p. greater than 200 mW shall comply with the following e.i.r.p. at different elevations, where <math>\theta</math> is the angle above the local horizontal plane (of the Earth) as shown below:            -13 dBW/MHz for <math>0^\circ \leq \theta &lt; 8^\circ</math> ; -13 - 0.716 (<math>\theta-8</math>) dBW/MHz for <math>8^\circ \leq \theta &lt; 40^\circ</math>            -35.9 - 1.22 (<math>\theta-40</math>) dBW/MHz for <math>40^\circ \leq \theta \leq 45^\circ</math> ; -42 dBW/MHz for <math>\theta &gt; 45^\circ</math></li> </ul>
<input type="checkbox"/>	For the 5.47-5.6 GHz band and 5.65-5.725 GHz band, the peak power spectral density (PPSD) $\leq 11$ dBm/MHz.
<input type="checkbox"/> For the 5.725-5.85 GHz band:	
<input type="checkbox"/>	<ul style="list-style-type: none"> <li>▪ Point-to-multipoint systems (P2M): the peak power spectral density (PPSD) <math>\leq 30</math> dBm/500kHz. If <math>G_{TX} &gt; 6</math> dBi, then <math>PPSD = 30 - (G_{TX} - 6)</math>.</li> <li>▪ Point-to-point systems (P2P): the peak power spectral density (PPSD) <math>\leq 30</math> dBm/500kHz.</li> </ul>
<p><b>PPSD</b> = peak power spectral density that he same method as used to determine the conducted output power shall be used to determine the power spectral density. And power spectral density in dBm/MHz  <b>G<sub>TX</sub></b> = the maximum transmitting antenna directional gain in dBi.</p>	



### 3.4.2 Measuring Instruments

Refer a test equipment and calibration data table in this test report.

### 3.4.3 Test Procedures

Test Method	
<ul style="list-style-type: none"> <li>▪ Peak power spectral density procedures that the same method as used to determine the conducted output power shall be used to determine the peak power spectral density and use the peak search function on the spectrum analyzer to find the peak of the spectrum. For the peak power spectral density shall be measured using below options:</li> </ul>	
	<input type="checkbox"/> Refer as FCC KDB 789033, F)5) power spectral density can be measured using resolution bandwidths < 1 MHz provided that the results are integrated over 1 MHz bandwidth [duty cycle ≥ 98% or external video / power trigger]
	<input checked="" type="checkbox"/> Refer as FCC KDB 789033, clause E Method SA-1 (spectral trace averaging).
	<input type="checkbox"/> Refer as FCC KDB 789033, clause E Method SA-1 Alt. (RMS detection with slow sweep speed) duty cycle < 98% and average over on/off periods with duty factor
	<input checked="" type="checkbox"/> Refer as FCC KDB 789033, clause E Method SA-2 (spectral trace averaging).
	<input type="checkbox"/> Refer as FCC KDB 789033, clause E Method SA-2 Alt. (RMS detection with slow sweep speed)
<ul style="list-style-type: none"> <li>▪ For conducted measurement.</li> </ul>	
	<ul style="list-style-type: none"> <li>▪ If the EUT supports multiple transmit chains using options given below:</li> </ul>
	<input checked="" type="checkbox"/> Option 1: Measure and sum the spectra across the outputs. Refer as FCC KDB 662911, In-band power spectral density (PSD). Sample all transmit ports simultaneously using a spectrum analyzer for each transmit port. Where the trace bin-by-bin of each transmit port summing can be performed. (i.e., in the first spectral bin of output 1 is summed with that in the first spectral bin of output 2 and that from the first spectral bin of output 3, and so on up to the NTX output to obtain the value for the first frequency bin of the summed spectrum.). Add up the amplitude (power) values for the different transmit chains and use this as the new data trace.
	<input type="checkbox"/> Option 2: Measure and sum spectral maxima across the outputs. With this technique, spectra are measured at each output of the device at the required resolution bandwidth. The maximum value (peak) of each spectrum is determined. These maximum values are then summed mathematically in linear power units across the outputs. These operations shall be performed separately over frequency spans that have different out-of-band or spurious emission limits,
	<input type="checkbox"/> Option 3: Measure and add 10 log(N) dB, where N is the number of transmit chains. Refer as FCC KDB 662911, In-band power spectral density (PSD). Performed at each transmit chains and each transmit chains shall be compared with the limit have been reduced with 10 log(N). Or each transmit chains shall be add 10 log(N) to compared with the limit.
	<ul style="list-style-type: none"> <li>▪ If multiple transmit chains, EIRP PPSD calculation could be following as methods:  <math>PPSD_{total} = PPSD_1 + PPSD_2 + \dots + PPSD_n</math>            (calculated in linear unit [mW] and transfer to log unit [dBm])  <math>EIRP_{total} = PPSD_{total} + DG</math> </li> </ul>

### 3.4.4 Test Setup

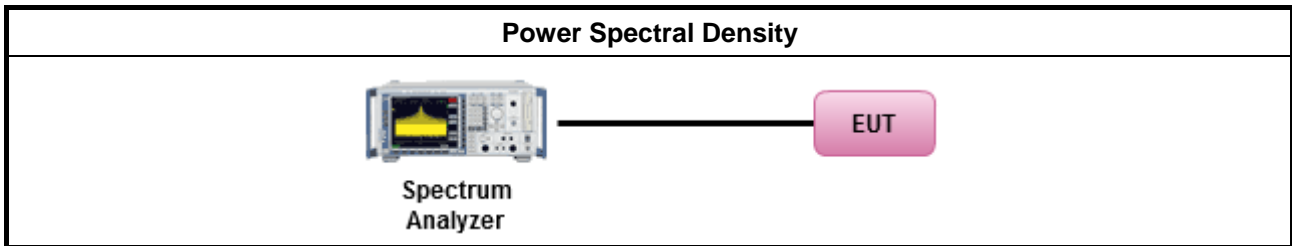

### 3.4.5 Test Result of Peak Power Spectral Density

Refer as Appendix D



### 3.5 Unwanted Emissions

#### 3.5.1 Transmitter Unwanted Emissions Limit

Unwanted emissions below 1 GHz and restricted band emissions above 1GHz limit			
Frequency Range (MHz)	Field Strength (uV/m)	Field Strength (dBuV/m)	Measure Distance (m)
0.009~0.490	2400/F(kHz)	48.5 - 13.8	300
0.490~1.705	24000/F(kHz)	33.8 - 23	30
1.705~30.0	30	29	30
30~88	100	40	3
88~216	150	43.5	3
216~960	200	46	3
Above 960	500	54	3

Note 1: Test distance for frequencies at or above 30 MHz, measurements may be performed at a distance other than the limit distance provided they are not performed in the near field and the emissions to be measured can be detected by the measurement equipment. When performing measurements at a distance other than that specified, the results shall be extrapolated to the specified distance using an extrapolation factor of 20 dB/decade (inverse of linear distance for field-strength measurements, inverse of linear distance-squared for power-density measurements).

Note 2: Test distance for frequencies at below 30 MHz, measurements may be performed at a distance closer than the EUT limit distance; however, an attempt should be made to avoid making measurements in the near field. When performing measurements below 30 MHz at a closer distance than the limit distance, the results shall be extrapolated to the specified distance by either making measurements at a minimum of two or more distances on at least one radial to determine the proper extrapolation factor or by using the square of an inverse linear distance extrapolation factor (40 dB/decade). The test report shall specify the extrapolation method used to determine compliance of the EUT.

Note 3: Using the distance of 1m during the test for above 18 GHz, and the test value to correct for the distance factor at 3m.

Un-restricted band emissions above 1GHz Limit	
Operating Band	Limit
<input checked="" type="checkbox"/> 5.15 - 5.25 GHz	e.i.r.p. -27 dBm [68.2 dBuV/m@3m]
<input type="checkbox"/> 5.25 - 5.35 GHz	e.i.r.p. -27 dBm [68.2 dBuV/m@3m]
<input type="checkbox"/> 5.47 - 5.725 GHz	e.i.r.p. -27 dBm [68.2 dBuV/m@3m]
<input checked="" type="checkbox"/> 5.725 - 5.85 GHz	all emissions shall be limited to a level of -27 dBm/MHz at 75 MHz or more above or below the band edge increasing linearly to 10 dBm/MHz at 25 MHz above or below the band edge, and from 25 MHz above or below the band edge increasing linearly to a level of 15.6 dBm/MHz at 5 MHz above or below the band edge, and from 5 MHz above or below the band edge increasing linearly to a level of 27 dBm/MHz at the band edge.

Note 1: Measurements may be performed at a distance other than the limit distance provided they are not performed in the near field and the emissions to be measured can be detected by the measurement equipment. When performing measurements at a distance other than that specified, the results shall be extrapolated to the specified distance using an extrapolation factor of 20 dB/decade (inverse of



linear distance for field-strength measurements, inverse of linear distance-squared for power-density measurements).

**3.5.2 Measuring Instruments**

Refer a test equipment and calibration data table in this test report.

**3.5.3 Test Procedures**

Test Method	
	<ul style="list-style-type: none"> <li>▪ Measurements may be performed at a distance other than the limit distance provided they are not performed in the near field and the emissions to be measured can be detected by the measurement equipment. Measurements shall not be performed at a distance greater than 30 m for frequencies above 30 MHz, unless it can be further demonstrated that measurements at a distance of 30 m or less are impractical. When performing measurements at a distance other than that specified, the results shall be extrapolated to the specified distance using an extrapolation factor of 20 dB/decade (inverse of linear distance for field-strength measurements, inverse of linear distance-squared for power-density measurements).</li> </ul>
	<ul style="list-style-type: none"> <li>▪ The average emission levels shall be measured in [duty cycle ≥ 98 or duty factor].</li> </ul>
	<ul style="list-style-type: none"> <li>▪ For the transmitter unwanted emissions shall be measured using following options below:               <ul style="list-style-type: none"> <li>▪ Refer as FCC KDB 789033, clause G)2) for unwanted emissions into non-restricted bands.</li> <li>▪ Refer as FCC KDB 789033, clause G)1) for unwanted emissions into restricted bands.                   <ul style="list-style-type: none"> <li><input type="checkbox"/> Refer as FCC KDB 789033, G)6) Method AD (Trace Averaging).</li> <li><input checked="" type="checkbox"/> Refer as FCC KDB 789033, G)6) Method VB (Reduced VBW).</li> <li><input type="checkbox"/> Refer as ANSI C63.10, clause 11.12.2.5.3 (Reduced VBW). VBW ≥ 1/T, where T is pulse time.</li> <li><input type="checkbox"/> Refer as ANSI C63.10, clause 7.5 average value of pulsed emissions.</li> <li><input checked="" type="checkbox"/> Refer as FCC KDB 789033, clause G)5) measurement procedure peak limit.</li> <li><input type="checkbox"/> Refer as ANSI C63.10, clause 4.1.4.2.2 measurement procedure peak limit.</li> </ul> </li> </ul> </li> </ul>
	<ul style="list-style-type: none"> <li>▪ For radiated measurement.               <ul style="list-style-type: none"> <li>▪ Refer as ANSI C63.10, clause 6.4 for radiated emissions below 30 MHz and test distance is 3m.</li> <li>▪ Refer as ANSI C63.10, clause 6.5 for radiated emissions 30 MHz to 1 GHz and test distance is 3m.</li> <li>▪ Refer as ANSI C63.10, clause 6.6 for radiated emissions above 1GHz.</li> </ul> </li> </ul>
	<ul style="list-style-type: none"> <li>▪ The any unwanted emissions level shall not exceed the fundamental emission level.</li> </ul>
	<ul style="list-style-type: none"> <li>▪ All amplitude of spurious emissions that are attenuated by more than 20 dB below the permissible value has no need to be reported.</li> </ul>

3.5.4 Test Setup

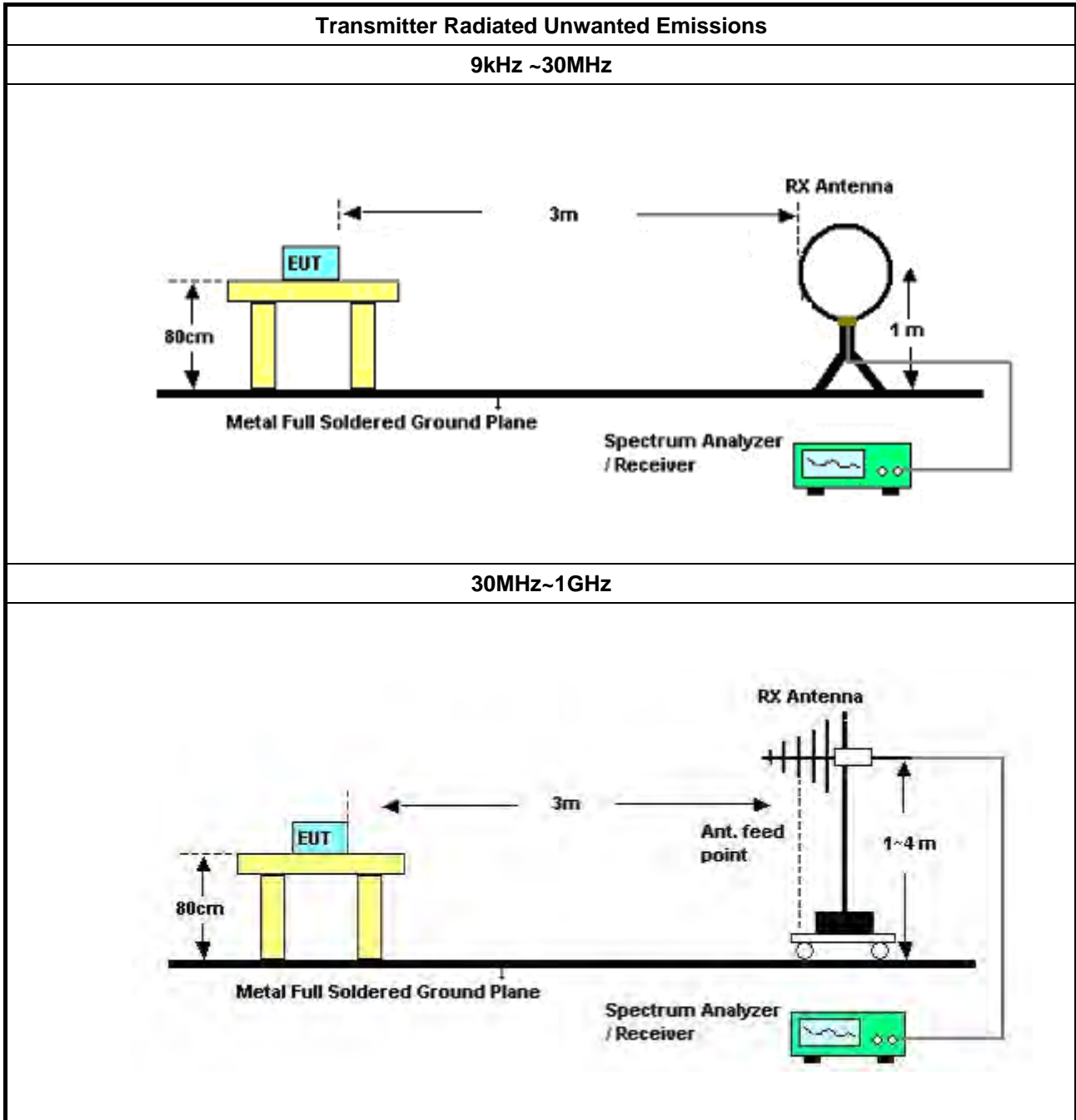

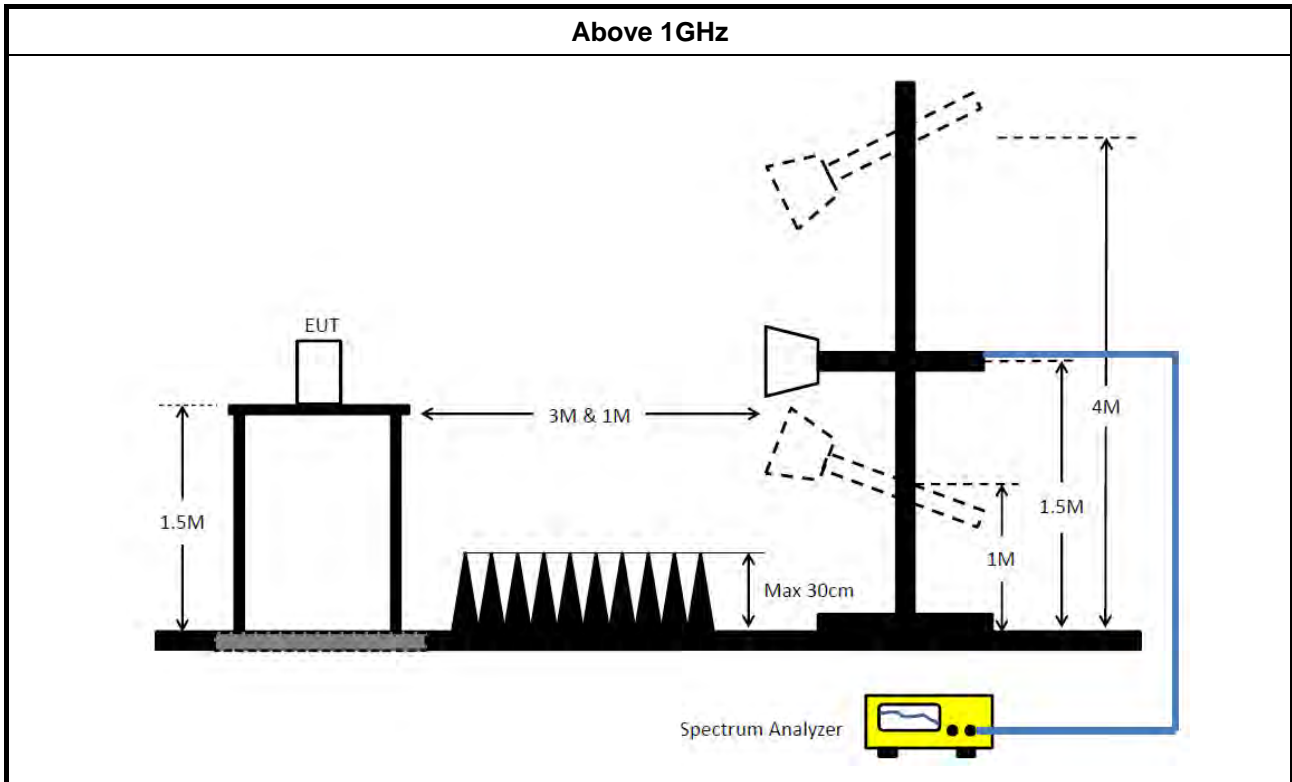

**3.5.5 Measurement Results Calculation**

The measured Level is calculated using:

Corrected Reading: Antenna factor (AF) + Cable loss (CL) + Read level (Raw) - Preamp factor (PA)(if applicable) = Level.

**3.5.6 Transmitter Unwanted Emissions (Below 30MHz)**

There is a comparison data of both open-field test site and alternative test site - semi-Anechoic chamber according to KDB414788 Radiated Test Site, and the result came out very similar.

All amplitude of spurious emissions that are attenuated by more than 20 dB below the permissible value has no need to be reported.

The radiated emissions were investigated from 9 kHz or the lowest frequency generated within the device, up to the 10th harmonic or 40 GHz, whichever is appropriate.

**3.5.7 Test Result of Transmitter Unwanted Emissions**

Refer as Appendix E



## 4 Test Equipment and Calibration Data

Instrument	Brand	Model No.	Serial No.	Characteristics	Calibration Date	Calibration Due Date	Remark
EMI Receiver	Agilent	N9038A	My52260123	9kHz ~ 8.4GHz	Feb. 26, 2020	Feb. 25, 2021	Conduction (CO01-CB)
LISN	F.C.C.	FCC-LISN-50-16-2	04083	150kHz ~ 100MHz	Jan. 06, 2021	Jan. 05, 2022	Conduction (CO01-CB)
LISN	Schwarzbeck	NSLK 8127	8127647	9kHz ~ 30MHz	Feb. 25, 2020	Feb. 24, 2021	Conduction (CO01-CB)
Pulse Limiter	Rohde&Schwarz	ESH3-Z2	100430	9kHz ~ 30MHz	Jan. 31, 2020	Jan. 30, 2021	Conduction (CO01-CB)
COND Cable	Woken	Cable	Low cable-CO01	9kHz ~ 30MHz	May 20, 2020	May 19, 2021	Conduction (CO01-CB)
Software	SPORTON	SENSE	V5.10	-	N.C.R.	N.C.R.	Conduction (CO01-CB)
3m Semi Anechoic Chamber VSWR	TDK	SAC-3M	03CH01-CB	1GHz ~18GHz 3m	May 29, 2020	May 28, 2021	Radiation (03CH01-CB)
Horn Antenna	ETS-LINDGREN	3115	00075790	750MHz ~ 18GHz	Nov. 06, 2020	Nov. 05, 2021	Radiation (03CH01-CB)
Horn Antenna	Schwarzbeck	BBHA 9170	BBHA9170252	15GHz ~ 40GHz	Jul. 21, 2020	Jul. 20, 2021	Radiation (03CH01-CB)
Pre-Amplifier	Agilent	8449B	3008A02310	1GHz ~ 26.5GHz	Jan. 08, 2020	Jan. 07, 2021	Radiation (03CH01-CB)
Pre-Amplifier	Agilent	8449B	3008A02310	1GHz ~ 26.5GHz	Jan. 07, 2021	Jan. 06, 2022	Radiation (03CH01-CB)
Pre-Amplifier	MITEQ	TTA1840-35-HG	1864479	18GHz ~ 40GHz	Jul. 08, 2020	Jul. 07, 2021	Radiation (03CH01-CB)
Spectrum Analyzer	R&S	FSP40	100056	9kHz ~ 40GHz	Apr. 16, 2020	Apr. 15, 2021	Radiation (03CH01-CB)
RF Cable-high	Woken	RG402	High Cable-16	1 GHz ~ 18 GHz	Oct. 05, 2020	Oct. 04, 2021	Radiation (03CH01-CB)
RF Cable-high	Woken	RG402	High Cable-16+17	1 GHz ~ 18 GHz	Oct. 05, 2020	Oct. 04, 2021	Radiation (03CH01-CB)
RF Cable-high	Woken	RG402	High Cable-40G#1	18GHz ~ 40 GHz	Jul. 16, 2020	Jul. 15, 2021	Radiation (03CH01-CB)
RF Cable-high	Woken	RG402	High Cable-40G#2	18GHz ~ 40 GHz	Jul. 16, 2020	Jul. 15, 2021	Radiation (03CH01-CB)
Test Software	SPORTON	SENSE	V5.10	-	N.C.R.	N.C.R.	Radiation (03CH01-CB)
3m Semi Anechoic Chamber VSWR	RIKEN	SAC-3M	03CH02-CB	1GHz ~18GHz 3m	Mar. 28, 2020	Mar. 27, 2021	Radiation (03CH02-CB)
Horn Antenna	EMCO	3115	9610-4976	1GHz ~ 18GHz	Apr. 21, 2020	Apr. 20, 2021	Radiation (03CH02-CB)
Horn Antenna	Schwarzbeck	BBHA 9170	BBHA9170252	15GHz ~ 40GHz	Jul. 21, 2020	Jul. 20, 2021	Radiation (03CH02-CB)





Instrument	Brand	Model No.	Serial No.	Characteristics	Calibration Date	Calibration Due Date	Remark
Pre-Amplifier	Agilent	83017A	MY39501305	1GHz ~ 26.5GHz	Jul. 13, 2020	Jul. 12, 2021	Radiation (03CH02-CB)
Pre-Amplifier	MITEQ	TTA1840-35-HG	1864479	18GHz ~ 40GHz	Jul. 08, 2020	Jul. 07, 2021	Radiation (03CH02-CB)
Spectrum analyzer	R&S	FSU	100015	9kHz~26GHz	Oct. 15, 2020	Oct. 14, 2021	Radiation (03CH02-CB)
RF Cable-high	Woken	RG402	High Cable-18	1GHz ~ 18GHz	Oct. 05, 2020	Oct. 04, 2021	Radiation (03CH02-CB)
RF Cable-high	Woken	RG402	High Cable-18+19	1GHz ~ 18GHz	Oct. 05, 2020	Oct. 04, 2021	Radiation (03CH02-CB)
RF Cable-high	Woken	RG402	High Cable-40G#1	18GHz ~ 40 GHz	Jul. 16, 2020	Jul. 15, 2021	Radiation (03CH02-CB)
RF Cable-high	Woken	RG402	High Cable-40G#2	18GHz ~ 40 GHz	Jul. 16, 2020	Jul. 15, 2021	Radiation (03CH02-CB)
Test Software	SPORTON	SENSE	V5.10	-	N.C.R.	N.C.R.	Radiation (03CH02-CB)
Loop Antenna	Teseq	HLA 6120	24155	9kHz - 30 MHz	Apr. 13, 2020	Apr. 12, 2021	Radiation (03CH05-CB)
3m Semi Anechoic Chamber NSA	TDK	SAC-3M	03CH05-CB	30 MHz ~ 1 GHz	Aug. 10, 2020	Aug. 09, 2021	Radiation (03CH05-CB)
Bilog Antenna with 6dB Attenuator	TESEQ & EMCI	CBL 6112D & N-6-06	35236 & AT-N0610	30MHz ~ 2GHz	Mar. 27, 2020	Mar. 26, 2021	Radiation (03CH05-CB)
Pre-Amplifier	EMCI	EMC330N	980331	20MHz ~ 3GHz	Apr. 28, 2020	Apr. 27, 2021	Radiation (03CH05-CB)
Spectrum Analyzer	R&S	FSP40	100304	9kHz ~ 40GHz	Nov. 10, 2020	Nov. 09, 2021	Radiation (03CH05-CB)
EMI Test Receiver	R&S	ESCS	826547/017	9kHz ~ 2.75GHz	May 13, 2020	May 12, 2021	Radiation (03CH05-CB)
RF Cable-low	Woken	RG402	Low Cable-04+23	30MHz~1GHz	Oct. 05, 2020	Oct. 04, 2021	Radiation (03CH05-CB)
Test Software	SPORTON	SENSE	V5.10	-	N.C.R.	N.C.R.	Radiation (03CH05-CB)
Loop Antenna	Teseq	HLA 6120	24155	9kHz - 30 MHz	Apr. 13, 2020	Apr. 12, 2021	Radiation (03CH03-CB)
3m Semi Anechoic Chamber NSA	TDK	SAC-3M	03CH03-CB	30 MHz ~ 1 GHz	Jan. 29, 2020	Jan. 28, 2021	Radiation (03CH03-CB)
3m Semi Anechoic Chamber NSA	TDK	SAC-3M	03CH03-CB	30 MHz ~ 1 GHz	Jan. 27, 2021	Jan. 26, 2022	Radiation (03CH03-CB)
Bilog Antenna with 6 dB attenuator	Schaffner & EMCI	CBL6112B & N-6-06	2928 & AT-N0608	20MHz ~ 2GHz	Feb. 28, 2020	Feb. 27, 2021	Radiation (03CH03-CB)
Pre-Amplifier	Agilent	8447D	2944A10259	9kHz ~ 1.3GHz	Jan. 15, 2020	Jan. 14, 2021	Radiation (03CH03-CB)
Pre-Amplifier	Agilent	8447D	2944A10259	9kHz ~ 1.3GHz	Jan. 11, 2021	Jan. 10, 2022	Radiation (03CH03-CB)
Spectrum Analyzer	R&S	FSP40	100019	9kHz ~ 40GHz	Jun. 09, 2020	Jun. 08, 2021	Radiation (03CH03-CB)



Instrument	Brand	Model No.	Serial No.	Characteristics	Calibration Date	Calibration Due Date	Remark
EMI Test Receiver	R&S	ESCS	826547/017	9kHz ~ 2.75GHz	May 13, 2020	May 12, 2021	Radiation (03CH03-CB)
RF Cable-low	Woken	RG402	Low Cable-02+29	30MHz ~ 1GHz	Oct. 05, 2020	Oct. 04, 2021	Radiation (03CH03-CB)
Test Software	SPORTON	SENSE	V5.10	-	N.C.R.	N.C.R.	Radiation (03CH03-CB)
Spectrum analyzer	R&S	FSV40	100979	9kHz~40GHz	May 05, 2020	May 04, 2021	Conducted (TH01-CB)
RF Cable-high	Woken	RG402	High Cable-06	1 GHz – 26.5 GHz	Oct. 05, 2020	Oct. 04, 2021	Conducted (TH01-CB)
RF Cable-high	Woken	RG402	High Cable-07	1 GHz –26.5 GHz	Oct. 05, 2020	Oct. 04, 2021	Conducted (TH01-CB)
RF Cable-high	Woken	RG402	High Cable-08	1 GHz –26.5 GHz	Oct. 05, 2020	Oct. 04, 2021	Conducted (TH01-CB)
RF Cable-high	Woken	RG402	High Cable-09	1 GHz –26.5 GHz	Oct. 05, 2020	Oct. 04, 2021	Conducted (TH01-CB)
RF Cable-high	Woken	RG402	High Cable-10	1 GHz –26.5 GHz	Oct. 05, 2020	Oct. 04, 2021	Conducted (TH01-CB)
RF Cable-high	Woken	RG402	High Cable-30	1 GHz –26.5 GHz	Oct. 05, 2020	Oct. 04, 2021	Conducted (TH01-CB)
Power Sensor	Agilent	E9327A	US40442088	50MHz~18GHz	Feb. 07, 2020	Feb. 06, 2021	Conducted (TH01-CB)
Power Meter	Agilent	E4416A	GB41291199	50MHz~18GHz	Feb. 07, 2020	Feb. 06, 2021	Conducted (TH01-CB)
Test Software	SPORTON	SENSE	V5.10	-	N.C.R.	N.C.R.	Conducted (TH01-CB)

Note: Calibration Interval of instruments listed above is one year.

NCR means Non-Calibration required.



**Summary**

Mode	Result	Type	Freq (Hz)	Level (dBuV)	Limit (dBuV)	Margin (dB)	Condition
Mode 2	Pass	QP	163.5k	54.28	65.27	-10.99	Line

Mode 2

28/01/2021

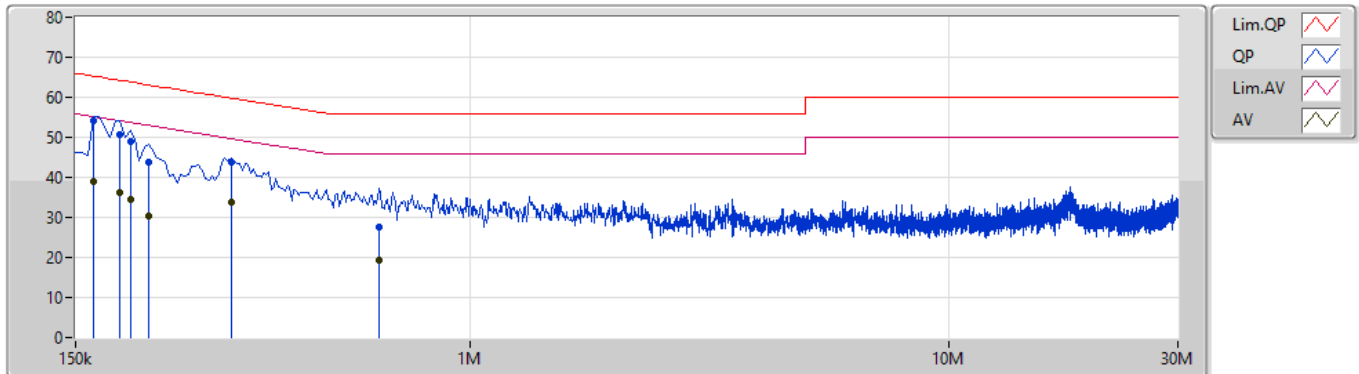

Type	Freq (Hz)	Level (dBuV)	Limit (dBuV)	Margin (dB)	Factor (dB)	Condition	Comment	Raw (dBuV)	LISN (dB)	CL (dB)	AT (dB)
QP	163.5k	54.28	65.27	-10.99	9.89	Line	"Worst"	44.39	0.05	0.03	9.81
AV	163.5k	38.88	55.27	-16.39	9.89	Line	-	28.99	0.05	0.03	9.81
QP	186k	50.65	64.20	-13.55	9.89	Line	-	40.76	0.04	0.03	9.82
AV	186k	36.36	54.20	-17.84	9.89	Line	-	26.47	0.04	0.03	9.82
QP	195k	49.06	63.82	-14.76	9.89	Line	-	39.17	0.04	0.03	9.82
AV	195k	34.42	53.82	-19.40	9.89	Line	-	24.53	0.04	0.03	9.82
QP	213k	43.88	63.09	-19.21	9.89	Line	-	33.99	0.04	0.03	9.82
AV	213k	30.36	53.09	-22.73	9.89	Line	-	20.47	0.04	0.03	9.82
QP	316.5k	43.67	59.80	-16.13	9.90	Line	-	33.77	0.04	0.03	9.83
AV	316.5k	33.92	49.80	-15.88	9.90	Line	-	24.02	0.04	0.03	9.83
QP	645k	27.56	56.00	-28.44	9.92	Line	-	17.64	0.05	0.04	9.83
AV	645k	19.40	46.00	-26.60	9.92	Line	-	9.48	0.05	0.04	9.83

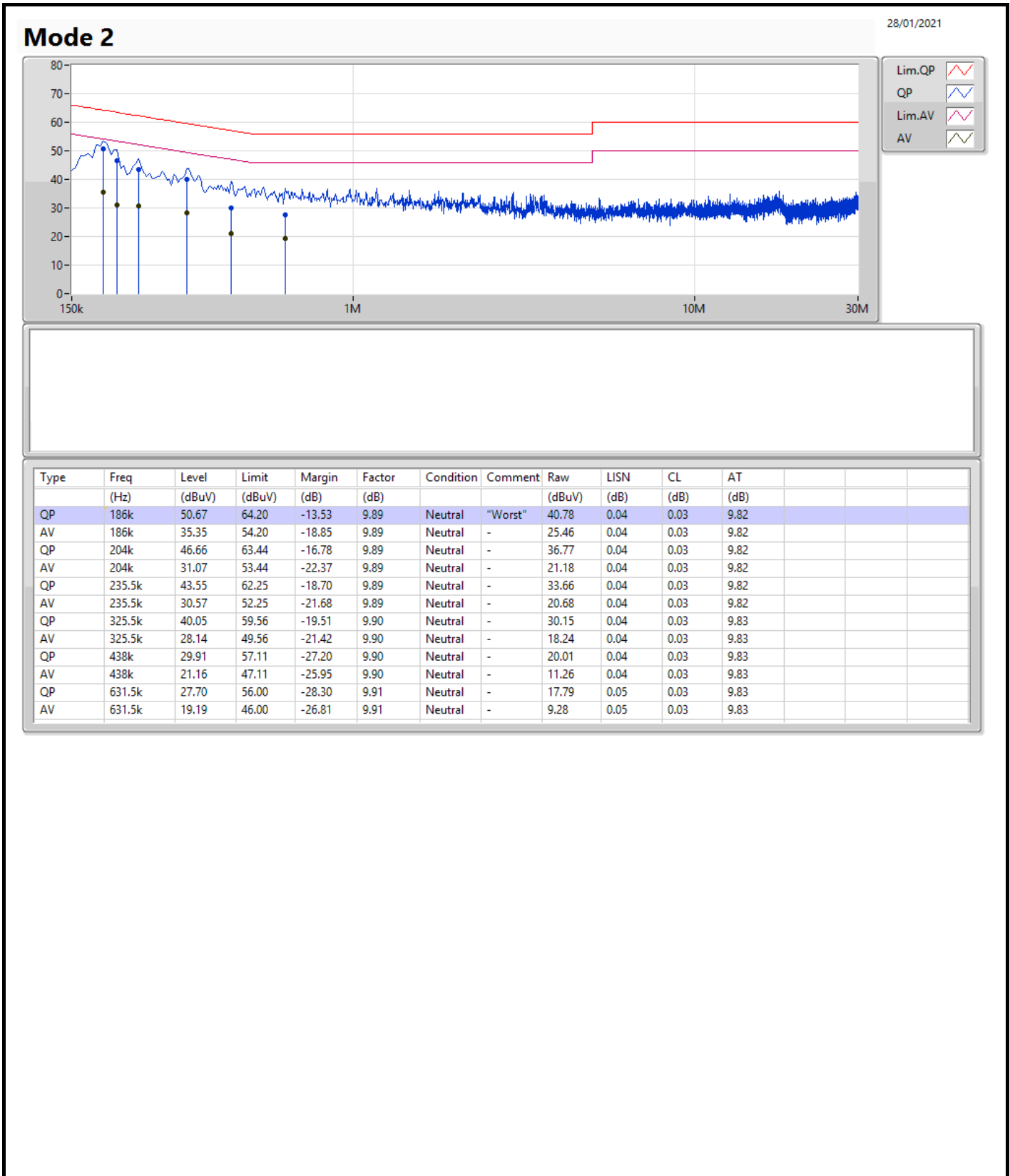



Summary

Mode	Max-N dB (Hz)	Max-OBW (Hz)	ITU-Code	Min-N dB (Hz)	Min-OBW (Hz)
5.15-5.25GHz	-	-	-	-	-
802.11a_Nss1,(6Mbps)_2TX	33.15M	19.01M	19MOD1D	19.62M	16.342M
802.11ax HEW20-BF_Nss1,(MCS0)_2TX	21.84M	18.981M	19MOD1D	21.42M	18.861M
802.11ax HEW40-BF_Nss1,(MCS0)_2TX	45.12M	37.721M	37M7D1D	41.04M	37.721M
802.11ax HEW80-BF_Nss1,(MCS0)_2TX	82.32M	77.121M	77M1D1D	81.84M	76.882M
5.725-5.85GHz	-	-	-	-	-
802.11a_Nss1,(6Mbps)_2TX	16.38M	35.172M	35M2D1D	15.66M	31.334M
802.11ax HEW20-BF_Nss1,(MCS0)_2TX	18.09M	18.951M	19MOD1D	16.71M	18.891M
802.11ax HEW40-BF_Nss1,(MCS0)_2TX	37.74M	38.201M	38M2D1D	34.86M	37.721M
802.11ax HEW80-BF_Nss1,(MCS0)_2TX	75.48M	77.121M	77M1D1D	73.8M	76.882M

**Max-N dB** = Maximum 6dB down bandwidth for 5.725-5.85GHz band / Maximum 26dB down bandwidth for other band;

**Max-OBW** = Maximum 99% occupied bandwidth;

**Min-N dB** = Minimum 6dB down bandwidth for 5.725-5.85GHz band / Maximum 26dB down bandwidth for other band;

**Min-OBW** = Minimum 99% occupied bandwidth;

**Result**

Mode	Result	Limit (Hz)	Port 1-N dB (Hz)	Port 1-OBW (Hz)	Port 2-N dB (Hz)	Port 2-OBW (Hz)
802.11a_Nss1,(6Mbps)_2TX	-	-	-	-	-	-
5180MHz	Pass	Inf	20.01M	16.342M	19.62M	16.372M
5200MHz	Pass	Inf	28.89M	17.061M	31.23M	17.691M
5240MHz	Pass	Inf	26.79M	16.792M	33.15M	19.01M
5745MHz	Pass	500k	16.35M	32.324M	16.35M	31.334M
5785MHz	Pass	500k	16.38M	32.534M	15.66M	34.363M
5825MHz	Pass	500k	16.26M	32.624M	16.29M	35.172M
802.11ax HEW20-BF_Nss1,(MCS0)_2TX	-	-	-	-	-	-
5180MHz	Pass	Inf	21.75M	18.891M	21.84M	18.891M
5200MHz	Pass	Inf	21.48M	18.891M	21.63M	18.981M
5240MHz	Pass	Inf	21.42M	18.861M	21.51M	18.861M
5745MHz	Pass	500k	17.82M	18.891M	17.94M	18.891M
5785MHz	Pass	500k	18.09M	18.921M	16.71M	18.921M
5825MHz	Pass	500k	17.64M	18.921M	16.98M	18.951M
802.11ax HEW40-BF_Nss1,(MCS0)_2TX	-	-	-	-	-	-
5190MHz	Pass	Inf	41.04M	37.721M	41.04M	37.721M
5230MHz	Pass	Inf	41.16M	37.721M	45.12M	37.721M
5755MHz	Pass	500k	34.86M	37.721M	37.62M	37.841M
5795MHz	Pass	500k	37.44M	37.961M	37.74M	38.201M
802.11ax HEW80-BF_Nss1,(MCS0)_2TX	-	-	-	-	-	-
5210MHz	Pass	Inf	82.32M	77.121M	81.84M	76.882M
5775MHz	Pass	500k	75.48M	77.121M	73.8M	76.882M

**Port X-N dB** = Port X 6dB down bandwidth for 5.725-5.85GHz band / 26dB down bandwidth for other band

**Port X-OBW** = Port X 99% occupied bandwidth;

### 802.11a\_Nss1,(6Mbps)\_2TX

EBW

5180MHz

25/12/2020

CF  
5.18GHz  
Span  
60MHz  
RBW  
200kHz  
VBW  
1MHz  
Sweep Time  
100ms  
Detector Type  
Peak

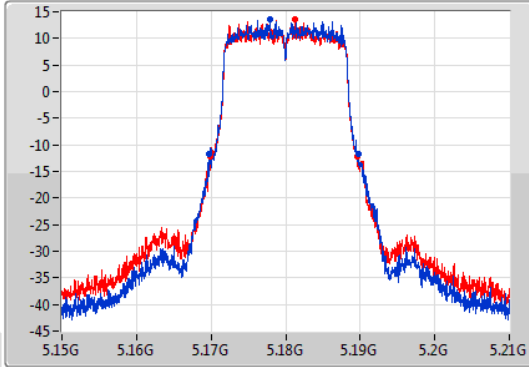

CF  
5.18GHz  
Span  
60MHz  
RBW  
200kHz  
VBW  
1MHz  
Sweep Time  
100ms  
Detector Type  
Peak

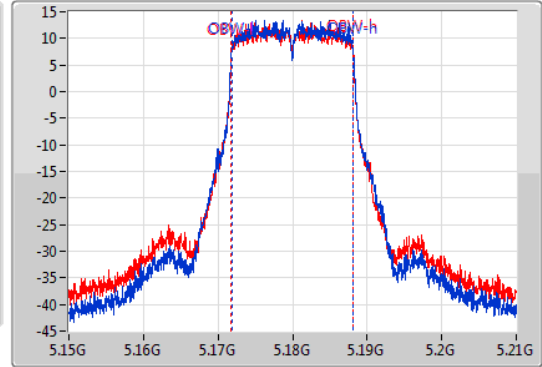

26dB(Hz)	Fl-26dB(Hz)	Fh-26dB(Hz)	OBW(Hz)	Fl-OBW(Hz)	Fh-OBW(Hz)	Limit(Hz)	Port
20.01M	5.16974G	5.18975G	16.342M	5.171814G	5.188156G	Inf	1
19.62M	5.16995G	5.18957G	16.372M	5.171784G	5.188156G	Inf	2

### 802.11a\_Nss1,(6Mbps)\_2TX

EBW

5200MHz

25/12/2020

CF  
5.2GHz  
Span  
60MHz  
RBW  
200kHz  
VBW  
1MHz  
Sweep Time  
100ms  
Detector Type  
Peak

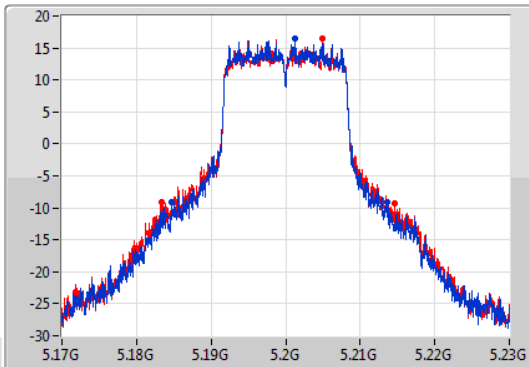

CF  
5.2GHz  
Span  
60MHz  
RBW  
200kHz  
VBW  
1MHz  
Sweep Time  
100ms  
Detector Type  
Peak

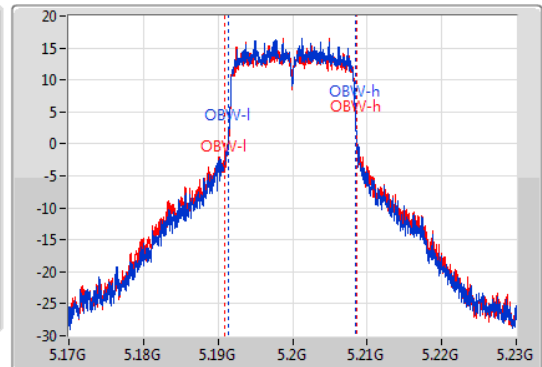

26dB(Hz)	Fl-26dB(Hz)	Fh-26dB(Hz)	OBW(Hz)	Fl-OBW(Hz)	Fh-OBW(Hz)	Limit(Hz)	Port
28.89M	5.18473G	5.21362G	17.061M	5.191364G	5.208426G	Inf	1
31.23M	5.18341G	5.21464G	17.691M	5.190855G	5.208546G	Inf	2



### 802.11a\_Nss1,(6Mbps)\_2TX

EBW

5240MHz

25/12/2020

CF  
5.24GHz  
Span  
60MHz  
RBW  
200kHz  
VBW  
1MHz  
Sweep Time  
100ms  
Detector Type  
Peak

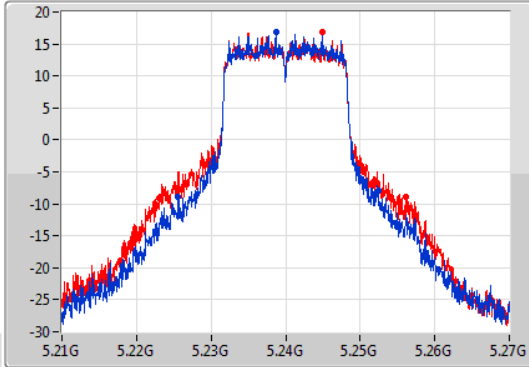

CF  
5.24GHz  
Span  
60MHz  
RBW  
200kHz  
VBW  
1MHz  
Sweep Time  
100ms  
Detector Type  
Peak

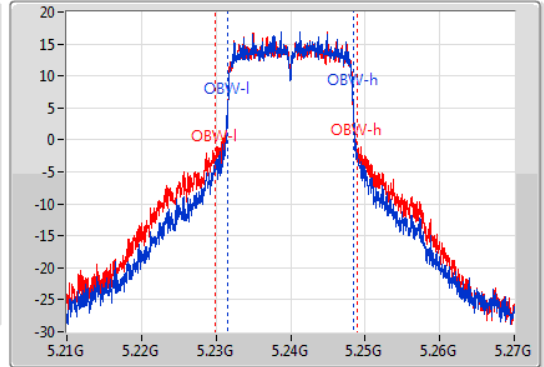

26dB(Hz)	Fl-26dB(Hz)	Fh-26dB(Hz)	OBW(Hz)	Fl-OBW(Hz)	Fh-OBW(Hz)	Limit(Hz)	Port
26.79M	5.2256G	5.25239G	16.792M	5.231574G	5.248366G	Inf	1
33.15M	5.22305G	5.2562G	19.01M	5.229925G	5.248936G	Inf	2

### 802.11a\_Nss1,(6Mbps)\_2TX

EBW

5745MHz

25/12/2020

CF  
5.745GHz  
Span  
60MHz  
RBW  
100kHz  
VBW  
300kHz  
Sweep Time  
100ms  
Detector Type  
Peak

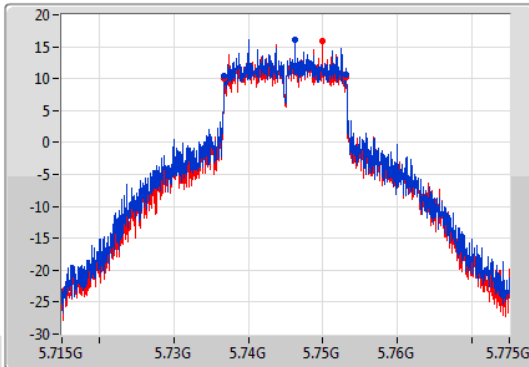

CF  
5.745GHz  
Span  
60MHz  
RBW  
200kHz  
VBW  
1MHz  
Sweep Time  
100ms  
Detector Type  
Peak

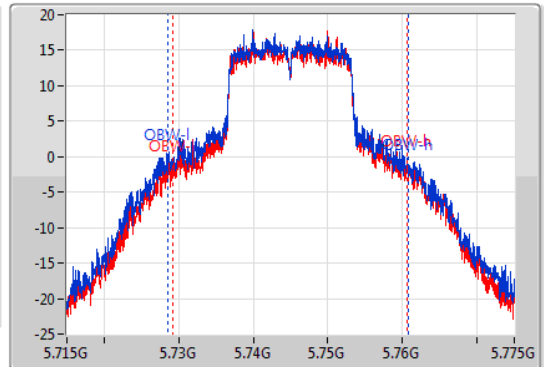

6dB(Hz)	Fl-6dB(Hz)	Fh-6dB(Hz)	OBW(Hz)	Fl-OBW(Hz)	Fh-OBW(Hz)	Limit(Hz)	Port
16.35M	5.73681G	5.75316G	32.324M	5.728478G	5.760802G	500k	1
16.35M	5.73681G	5.75316G	31.334M	5.729228G	5.760562G	500k	2

### 802.11a\_Nss1,(6Mbps)\_2TX

EBW

5785MHz

25/12/2020

CF  
5.785GHz  
Span  
60MHz  
RBW  
100kHz  
VBW  
300kHz  
Sweep Time  
100ms  
Detector Type  
Peak

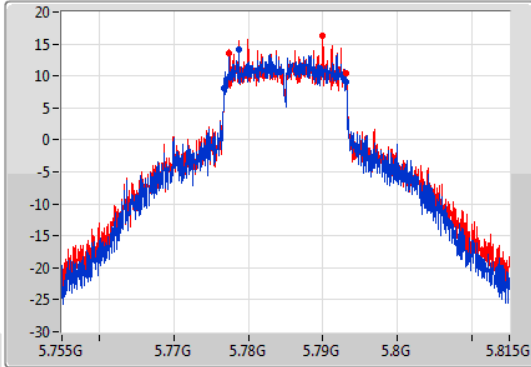

CF  
5.785GHz  
Span  
60MHz  
RBW  
200kHz  
VBW  
1MHz  
Sweep Time  
100ms  
Detector Type  
Peak

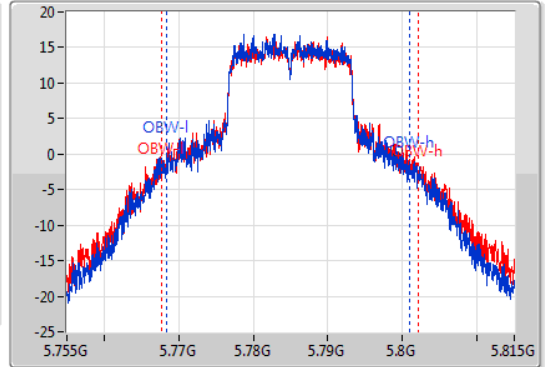

6dB(Hz)	Fl-6dB(Hz)	Fh-6dB(Hz)	OBW(Hz)	Fl-OBW(Hz)	Fh-OBW(Hz)	Limit(Hz)	Port
16.38M	5.77678G	5.79316G	32.534M	5.768388G	5.800922G	500k	1
15.66M	5.77744G	5.7931G	34.363M	5.767699G	5.802061G	500k	2

### 802.11a\_Nss1,(6Mbps)\_2TX

EBW

5825MHz

25/12/2020

CF  
5.825GHz  
Span  
60MHz  
RBW  
100kHz  
VBW  
300kHz  
Sweep Time  
100ms  
Detector Type  
Peak

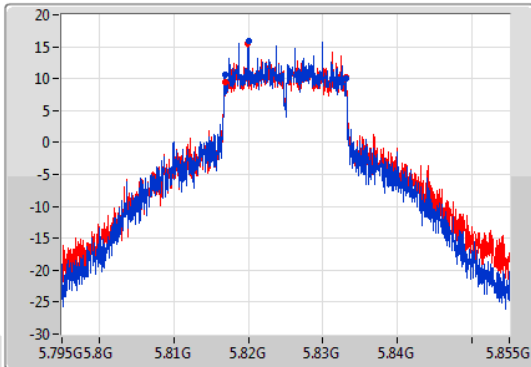

CF  
5.825GHz  
Span  
60MHz  
RBW  
200kHz  
VBW  
1MHz  
Sweep Time  
100ms  
Detector Type  
Peak

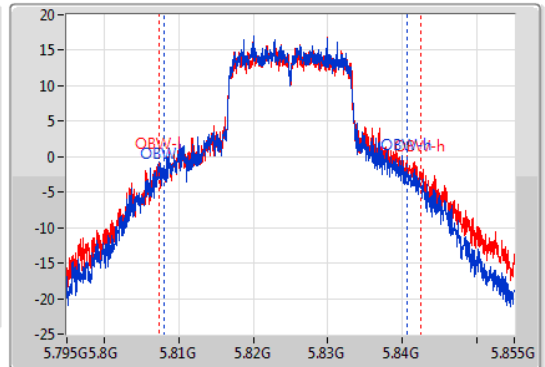

6dB(Hz)	Fl-6dB(Hz)	Fh-6dB(Hz)	OBW(Hz)	Fl-OBW(Hz)	Fh-OBW(Hz)	Limit(Hz)	Port
16.26M	5.81684G	5.8331G	32.624M	5.807969G	5.840592G	500k	1
16.29M	5.81684G	5.83313G	35.172M	5.807339G	5.842511G	500k	2

### 802.11ax HEW20-BF\_Nss1,(MCS0)\_2TX

EBW

5180MHz

25/12/2020

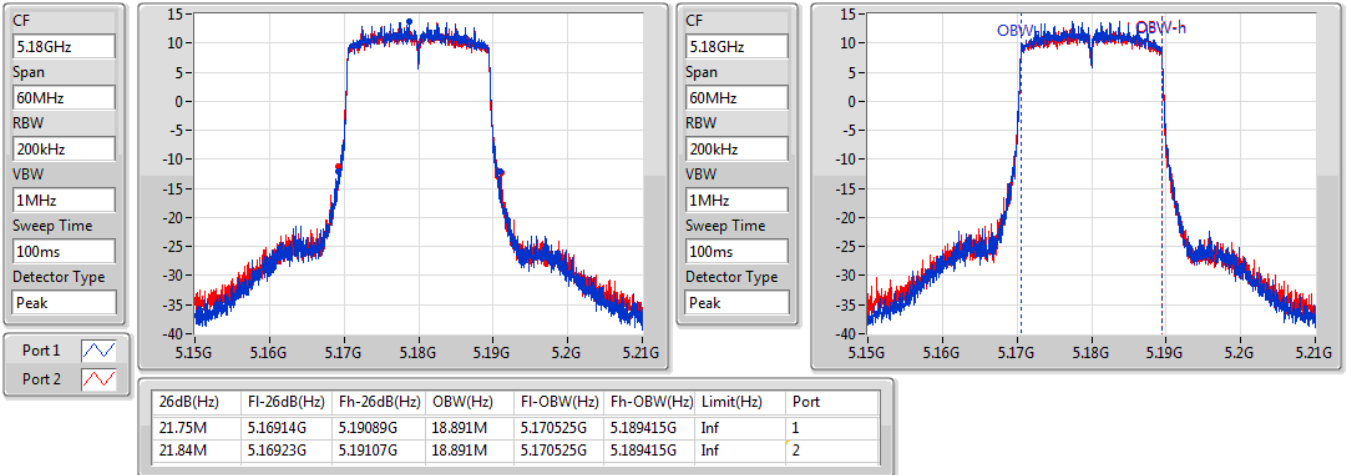

### 802.11ax HEW20-BF\_Nss1,(MCS0)\_2TX

EBW

5200MHz

25/12/2020

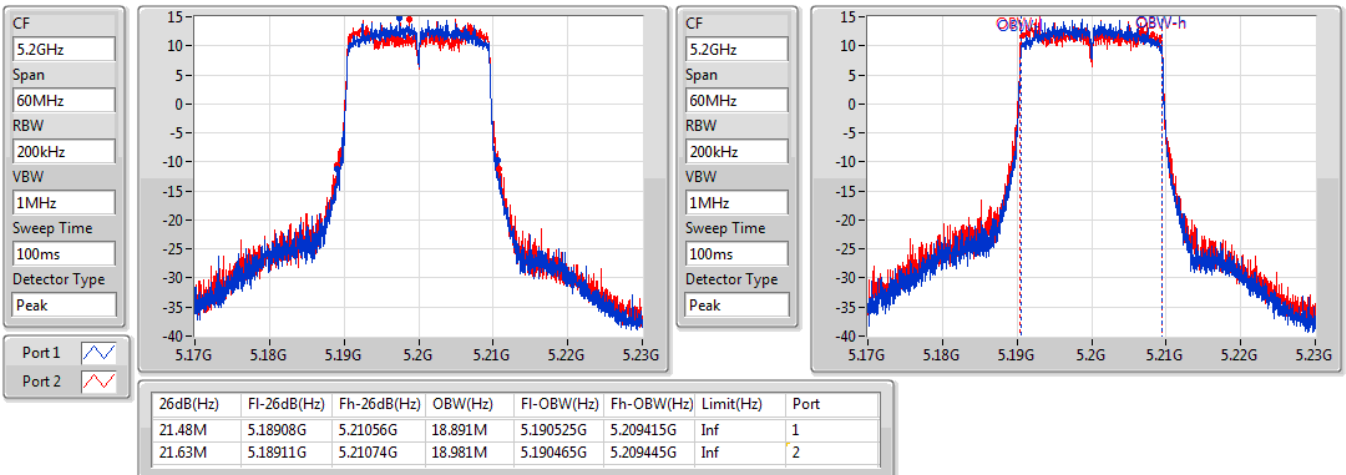

### 802.11ax HEW20-BF\_Nss1,(MCS0)\_2TX

EBW

5240MHz

25/12/2020

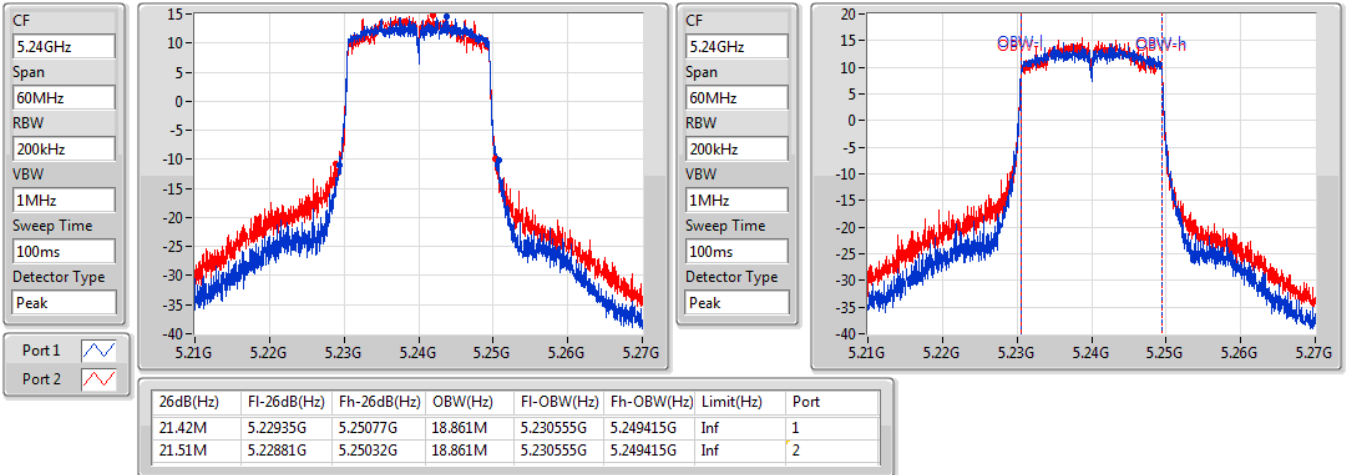

### 802.11ax HEW20-BF\_Nss1,(MCS0)\_2TX

EBW

5745MHz

25/12/2020

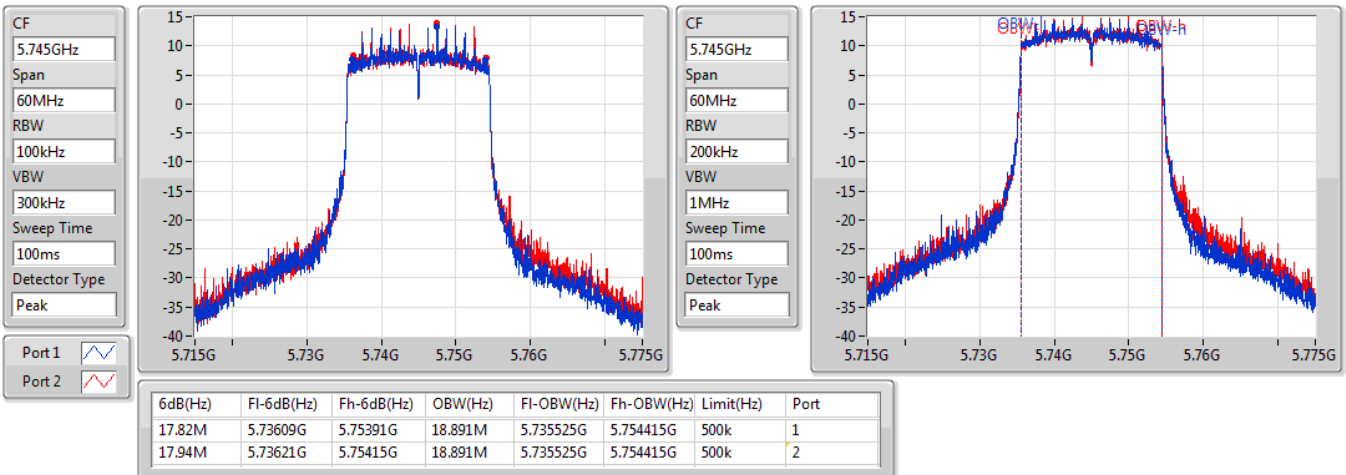

802.11ax HEW20-BF\_Nss1,(MCS0)\_2TX

EBW

5785MHz

25/12/2020

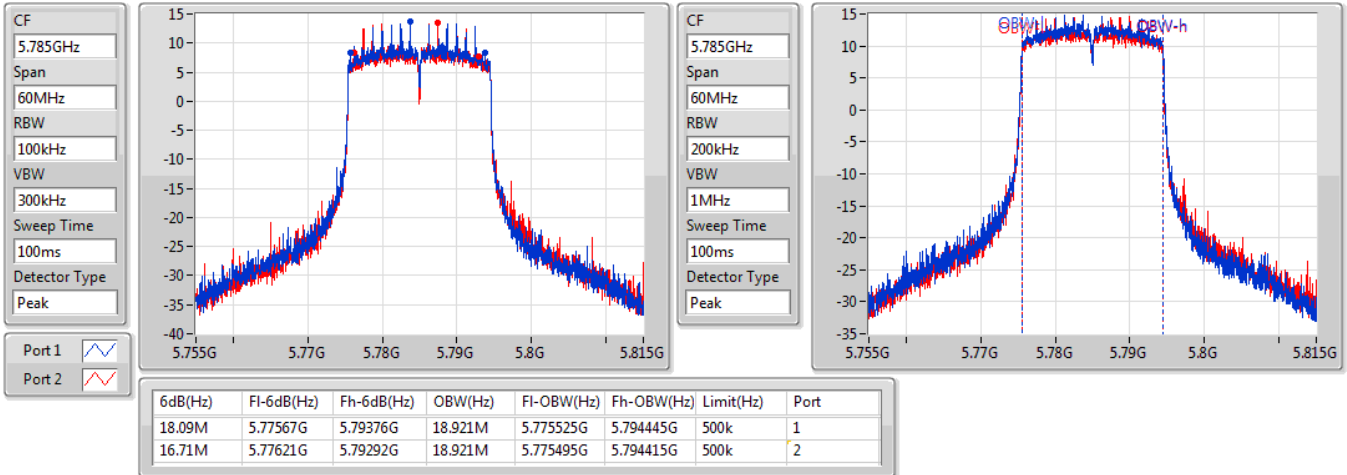

802.11ax HEW20-BF\_Nss1,(MCS0)\_2TX

EBW

5825MHz

25/12/2020

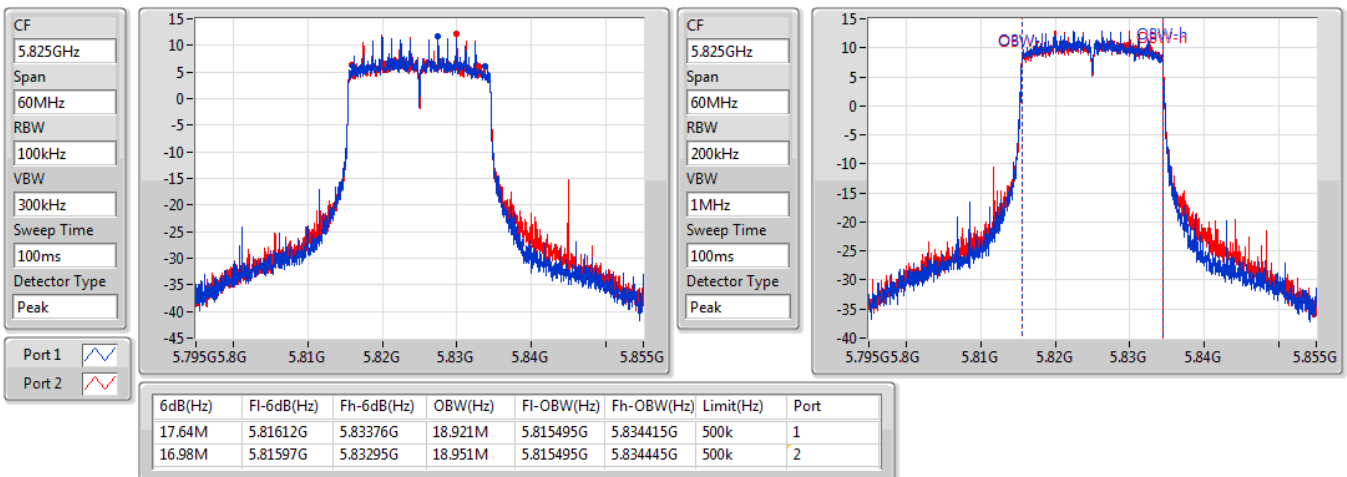

### 802.11ax HEW40-BF\_Nss1,(MCS0)\_2TX

EBW

5190MHz

25/12/2020

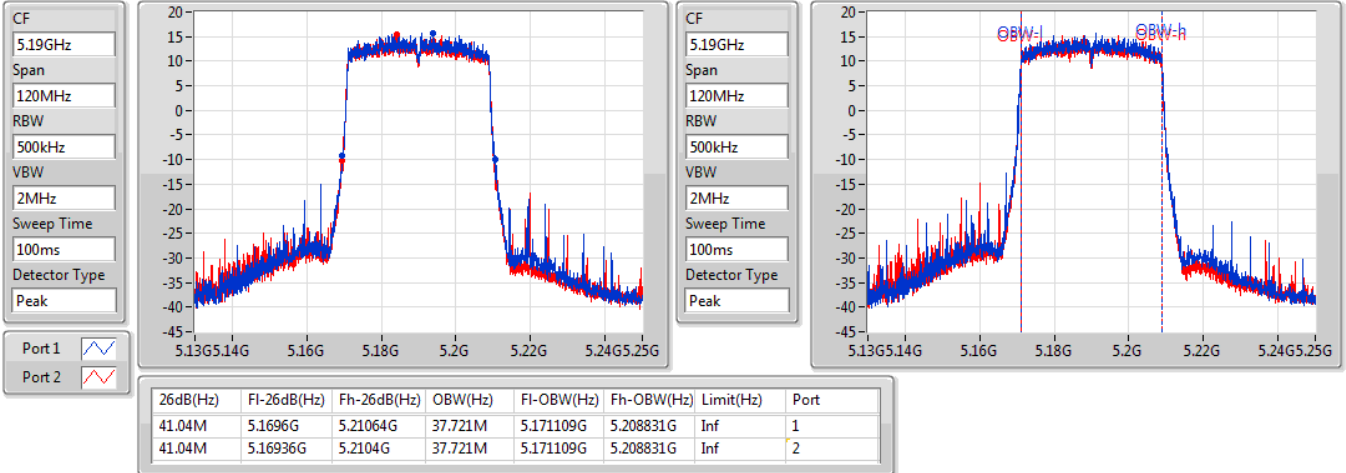

### 802.11ax HEW40-BF\_Nss1,(MCS0)\_2TX

EBW

5230MHz

25/12/2020

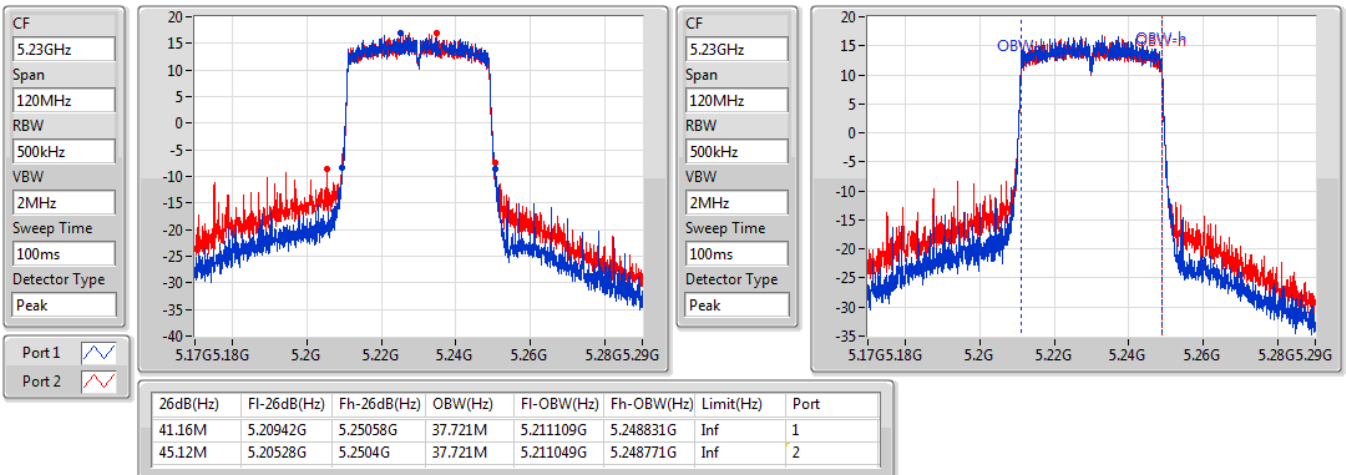

802.11ax HEW40-BF\_Nss1,(MCS0)\_2TX

EBW

5755MHz

25/12/2020

CF  
5.755GHz  
Span  
120MHz  
RBW  
100kHz  
VBW  
300kHz  
Sweep Time  
100ms  
Detector Type  
Peak

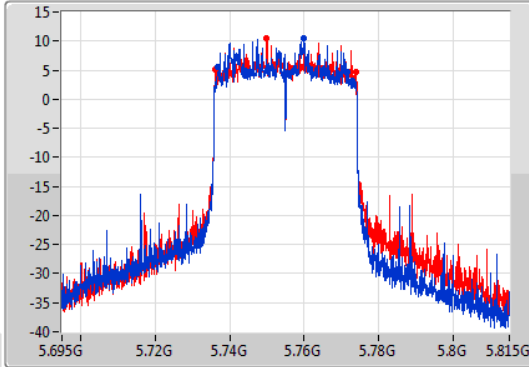

CF  
5.755GHz  
Span  
120MHz  
RBW  
500kHz  
VBW  
2MHz  
Sweep Time  
100ms  
Detector Type  
Peak

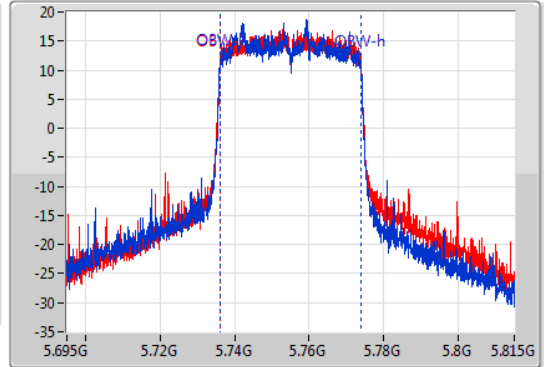

6dB(Hz)	Fl-6dB(Hz)	Fh-6dB(Hz)	OBW(Hz)	Fl-OBW(Hz)	Fh-OBW(Hz)	Limit(Hz)	Port
34.86M	5.73682G	5.77168G	37.721M	5.736049G	5.773771G	500k	1
37.62M	5.73622G	5.77384G	37.841M	5.736049G	5.773891G	500k	2

802.11ax HEW40-BF\_Nss1,(MCS0)\_2TX

EBW

5795MHz

25/12/2020

CF  
5.795GHz  
Span  
120MHz  
RBW  
100kHz  
VBW  
300kHz  
Sweep Time  
100ms  
Detector Type  
Peak

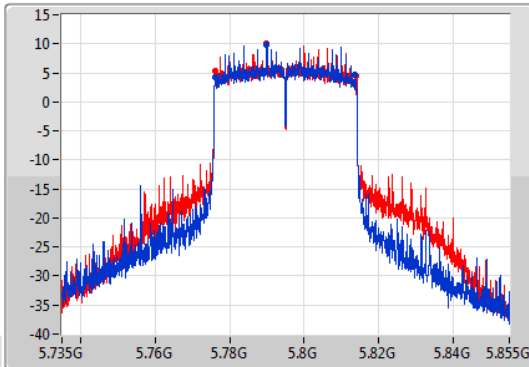

CF  
5.795GHz  
Span  
120MHz  
RBW  
500kHz  
VBW  
2MHz  
Sweep Time  
100ms  
Detector Type  
Peak

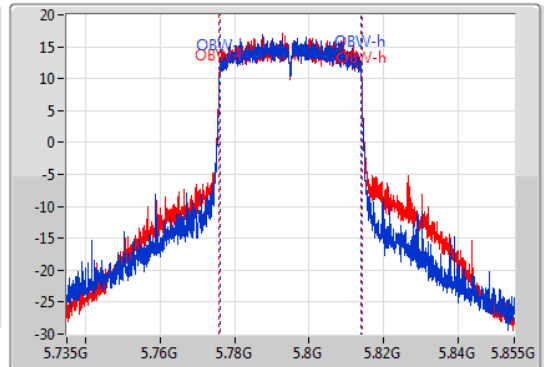

6dB(Hz)	Fl-6dB(Hz)	Fh-6dB(Hz)	OBW(Hz)	Fl-OBW(Hz)	Fh-OBW(Hz)	Limit(Hz)	Port
37.44M	5.77622G	5.81366G	37.961M	5.77599G	5.813951G	500k	1
37.74M	5.77622G	5.81396G	38.201M	5.77587G	5.81407G	500k	2

802.11ax HEW80-BF\_Nss1,(MCS0)\_2TX

EBW

5210MHz

25/12/2020

CF  
5.21GHz  
Span  
240MHz  
RBW  
1MHz  
VBW  
3MHz  
Sweep Time  
100ms  
Detector Type  
Peak  
Port 1  
Port 2

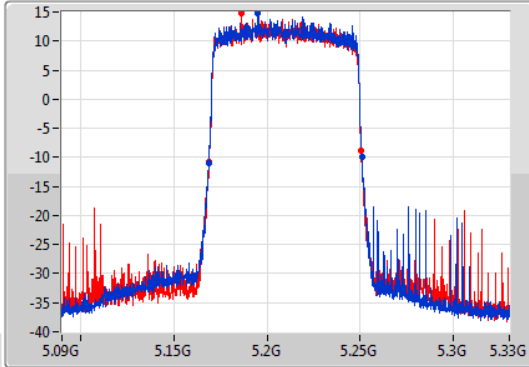

CF  
5.21GHz  
Span  
240MHz  
RBW  
1MHz  
VBW  
3MHz  
Sweep Time  
100ms  
Detector Type  
Peak

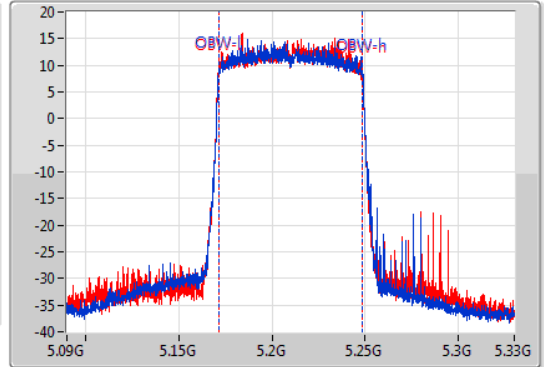

26dB(Hz)	Fl-26dB(Hz)	Fh-26dB(Hz)	OBW(Hz)	Fl-OBW(Hz)	Fh-OBW(Hz)	Limit(Hz)	Port
82.32M	5.1686G	5.25092G	77.121M	5.171379G	5.248501G	Inf	1
81.84M	5.16884G	5.25068G	76.882M	5.171379G	5.248261G	Inf	2

802.11ax HEW80-BF\_Nss1,(MCS0)\_2TX

EBW

5775MHz

25/12/2020

CF  
5.775GHz  
Span  
240MHz  
RBW  
100kHz  
VBW  
300kHz  
Sweep Time  
100ms  
Detector Type  
Peak  
Port 1  
Port 2

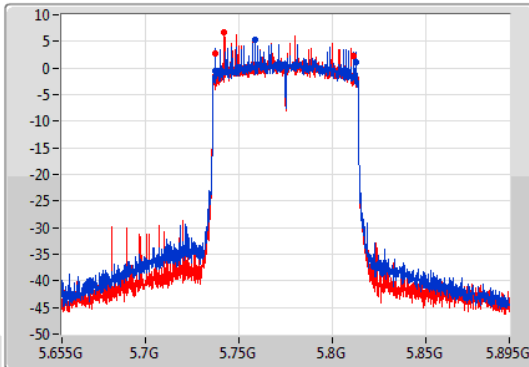

CF  
5.775GHz  
Span  
240MHz  
RBW  
1MHz  
VBW  
3MHz  
Sweep Time  
100ms  
Detector Type  
Peak

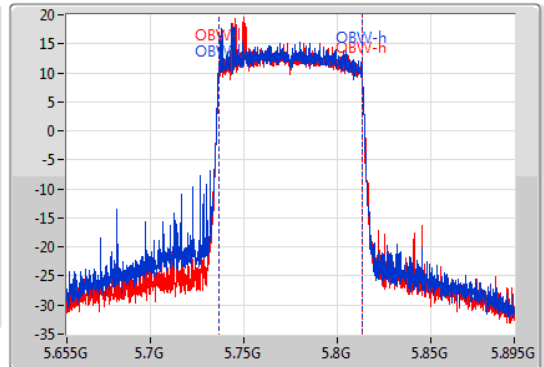

6dB(Hz)	Fl-6dB(Hz)	Fh-6dB(Hz)	OBW(Hz)	Fl-OBW(Hz)	Fh-OBW(Hz)	Limit(Hz)	Port
75.48M	5.73708G	5.81256G	77.121M	5.736379G	5.813501G	500k	1
73.8M	5.73744G	5.81124G	76.882M	5.736499G	5.813381G	500k	2





**Summary**

Mode	Total Power (dBm)	Total Power (W)
5.15-5.25GHz	-	-
802.11a_Nss1,(6Mbps)_2TX	28.73	0.74645
802.11ax HEW20-BF_Nss1,(MCS0)_2TX	27.64	0.58076
802.11ax HEW40-BF_Nss1,(MCS0)_2TX	27.59	0.57412
802.11ax HEW80-BF_Nss1,(MCS0)_2TX	24.14	0.25942
5.725-5.85GHz	-	-
802.11a_Nss1,(6Mbps)_2TX	29.35	0.86099
802.11ax HEW20-BF_Nss1,(MCS0)_2TX	27.91	0.61802
802.11ax HEW40-BF_Nss1,(MCS0)_2TX	27.56	0.57016
802.11ax HEW80-BF_Nss1,(MCS0)_2TX	24.66	0.29242



**Result**

Mode	Result	DG (dBi)	Port 1 (dBm)	Port 2 (dBm)	Total Power (dBm)	Power Limit (dBm)
802.11a_Nss1,(6Mbps)_2TX	-	-	-	-	-	-
5180MHz	Pass	2.12	22.88	22.45	25.68	30.00
5200MHz	Pass	2.12	25.46	25.36	28.42	30.00
5240MHz	Pass	2.12	25.71	25.73	28.73	30.00
5745MHz	Pass	2.08	26.51	26.16	29.35	30.00
5785MHz	Pass	2.08	26.25	26.06	29.17	30.00
5825MHz	Pass	2.08	25.72	25.45	28.60	30.00
802.11ax HEW20-BF_Nss1,(MCS0)_2TX	-	-	-	-	-	-
5180MHz	Pass	5.13	23.71	23.32	26.53	30.00
5200MHz	Pass	5.13	24.00	24.04	27.03	30.00
5240MHz	Pass	5.13	24.49	24.77	27.64	30.00
5745MHz	Pass	5.09	24.07	24.66	27.39	30.00
5785MHz	Pass	5.09	24.53	24.40	27.48	30.00
5825MHz	Pass	5.09	24.79	25.00	27.91	30.00
802.11ax HEW40-BF_Nss1,(MCS0)_2TX	-	-	-	-	-	-
5190MHz	Pass	5.13	22.69	22.30	25.51	30.00
5230MHz	Pass	5.13	24.02	25.08	27.59	30.00
5755MHz	Pass	5.09	24.38	24.24	27.32	30.00
5795MHz	Pass	5.09	24.63	24.47	27.56	30.00
802.11ax HEW80-BF_Nss1,(MCS0)_2TX	-	-	-	-	-	-
5210MHz	Pass	5.13	21.17	21.09	24.14	30.00
5775MHz	Pass	5.09	21.79	21.51	24.66	30.00

**DG** = Directional Gain; **Port X** = Port X output power



Summary

Mode	PD (dBm/RBW)
5.15-5.25GHz	-
802.11a_Nss1,(6Mbps)_2TX	16.20
802.11ax HEW20-BF_Nss1,(MCS0)_2TX	13.56
802.11ax HEW40-BF_Nss1,(MCS0)_2TX	10.74
802.11ax HEW80-BF_Nss1,(MCS0)_2TX	5.92
5.725-5.85GHz	-
802.11a_Nss1,(6Mbps)_2TX	15.26
802.11ax HEW20-BF_Nss1,(MCS0)_2TX	11.54
802.11ax HEW40-BF_Nss1,(MCS0)_2TX	8.78
802.11ax HEW80-BF_Nss1,(MCS0)_2TX	3.95

RBW = 500 kHz for 5.725-5.85GHz band / 1MHz for other band;

**Result**

Mode	Result	DG (dBi)	Port 1 (dBm/RBW)	Port 2 (dBm/RBW)	PD (dBm/RBW)	PD Limit (dBm/RBW)
802.11a_Nss1,(6Mbps)_2TX	-	-	-	-	-	-
5180MHz	Pass	5.13	10.42	10.14	13.20	17.00
5200MHz	Pass	5.13	12.88	12.89	15.83	17.00
5240MHz	Pass	5.13	13.22	13.22	16.20	17.00
5745MHz	Pass	5.09	12.71	12.12	15.26	30.00
5785MHz	Pass	5.09	12.37	12.01	15.11	30.00
5825MHz	Pass	5.09	11.53	11.44	14.34	30.00
802.11ax HEW20-BF_Nss1,(MCS0)_2TX	-	-	-	-	-	-
5180MHz	Pass	5.13	9.23	9.02	11.98	17.00
5200MHz	Pass	5.13	10.22	10.35	12.77	17.00
5240MHz	Pass	5.13	10.26	11.04	13.56	17.00
5745MHz	Pass	5.09	8.61	8.59	11.54	30.00
5785MHz	Pass	5.09	8.78	8.27	11.46	30.00
5825MHz	Pass	5.09	7.95	8.24	11.01	30.00
802.11ax HEW40-BF_Nss1,(MCS0)_2TX	-	-	-	-	-	-
5190MHz	Pass	5.13	6.03	5.42	8.73	17.00
5230MHz	Pass	5.13	7.27	8.50	10.74	17.00
5755MHz	Pass	5.09	5.46	6.44	8.78	30.00
5795MHz	Pass	5.09	5.81	5.74	8.72	30.00
802.11ax HEW80-BF_Nss1,(MCS0)_2TX	-	-	-	-	-	-
5210MHz	Pass	5.13	1.79	4.80	5.92	17.00
5775MHz	Pass	5.09	1.28	0.85	3.95	30.00

**DG** = Directional Gain; **RBW** = 500 kHz for 5.725-5.85GHz band / 1MHz for other band;

**PD** = trace bin-by-bin of each transmits port summing can be performed maximum power density; **Port X** = Port X power density;

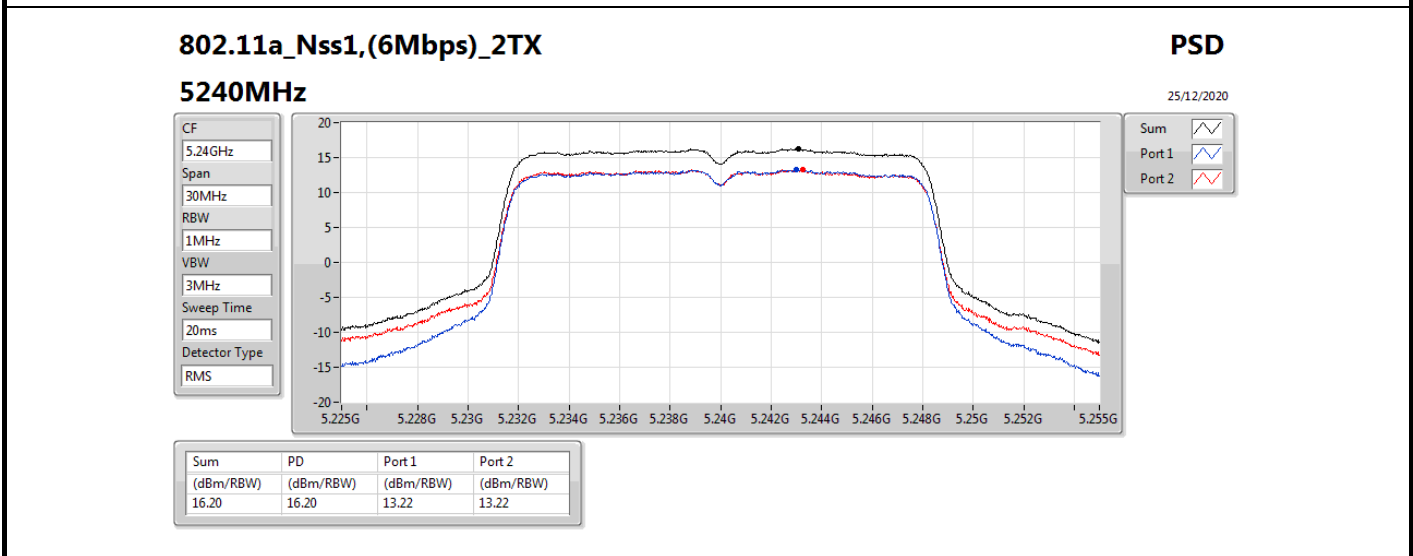
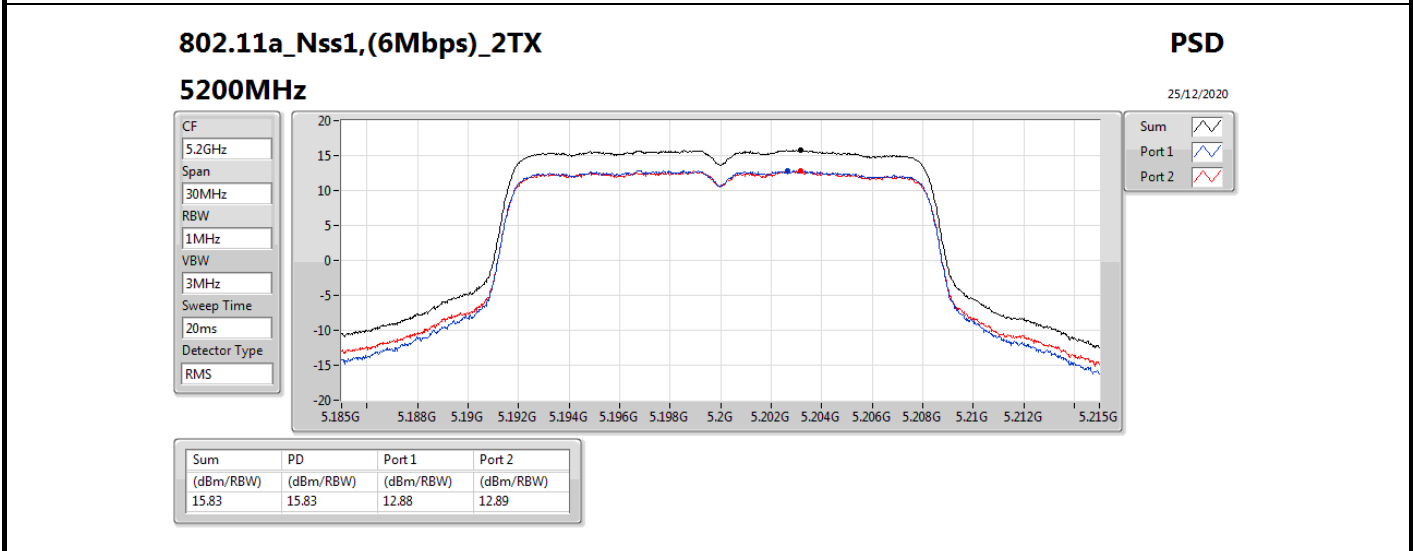
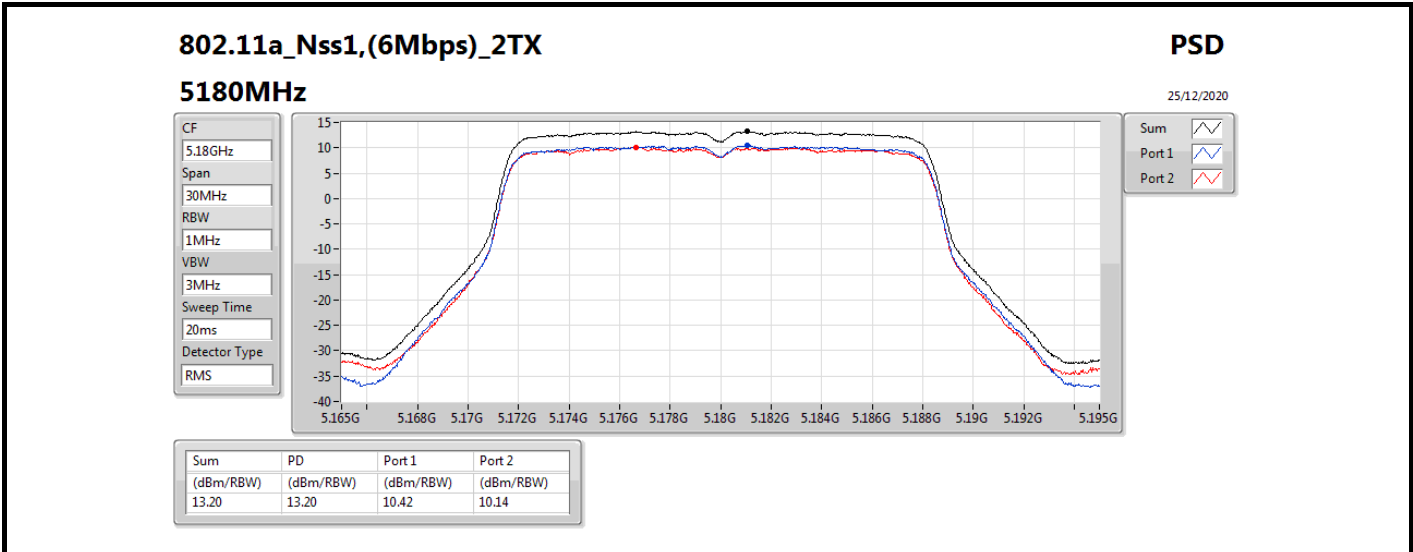

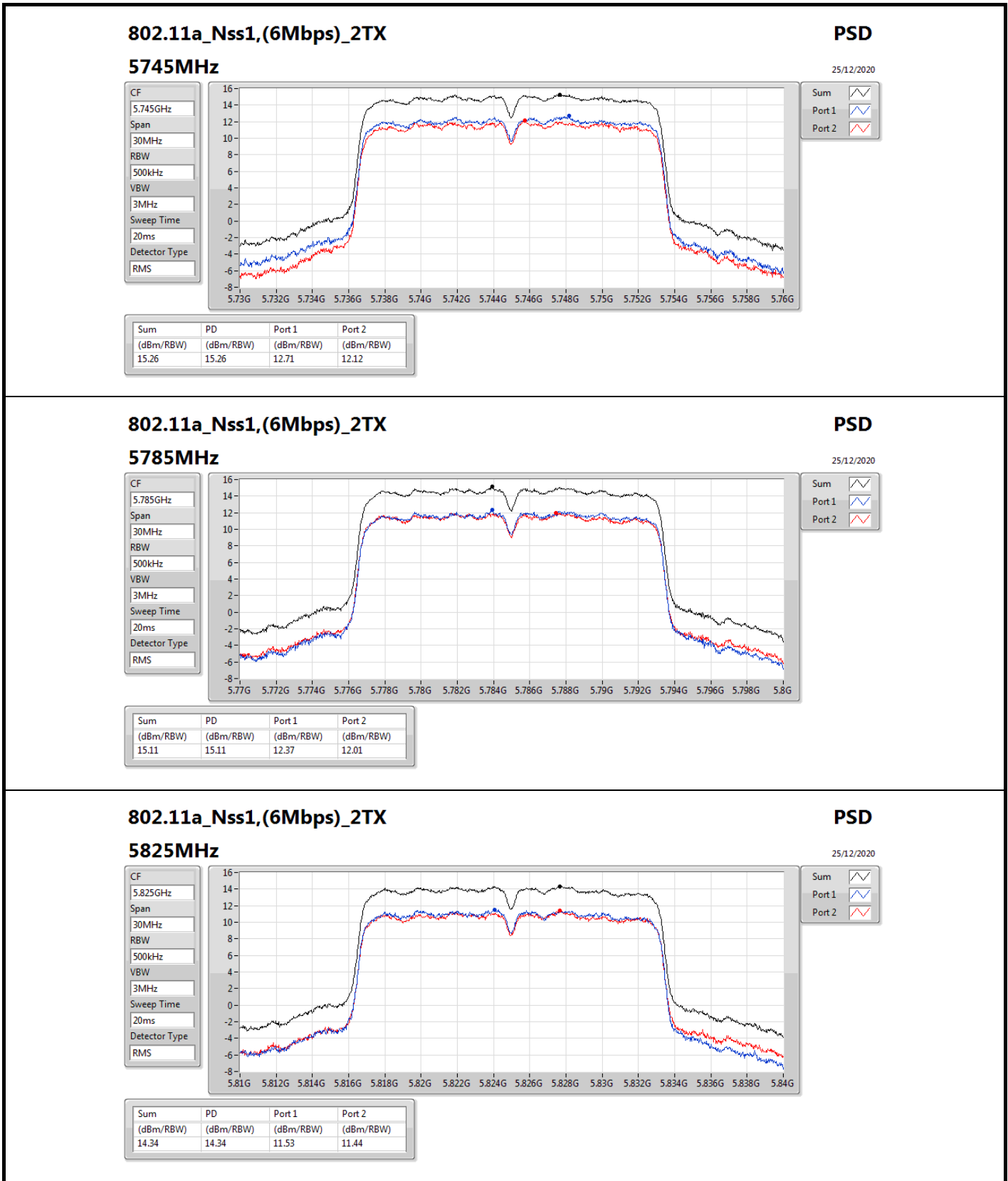

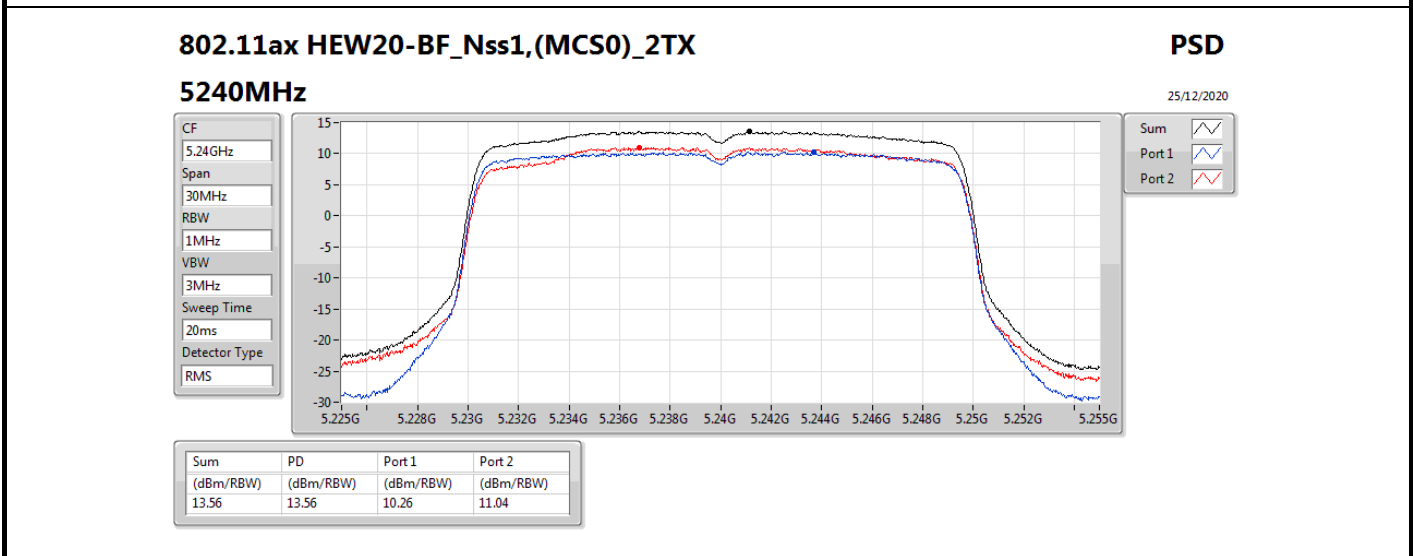
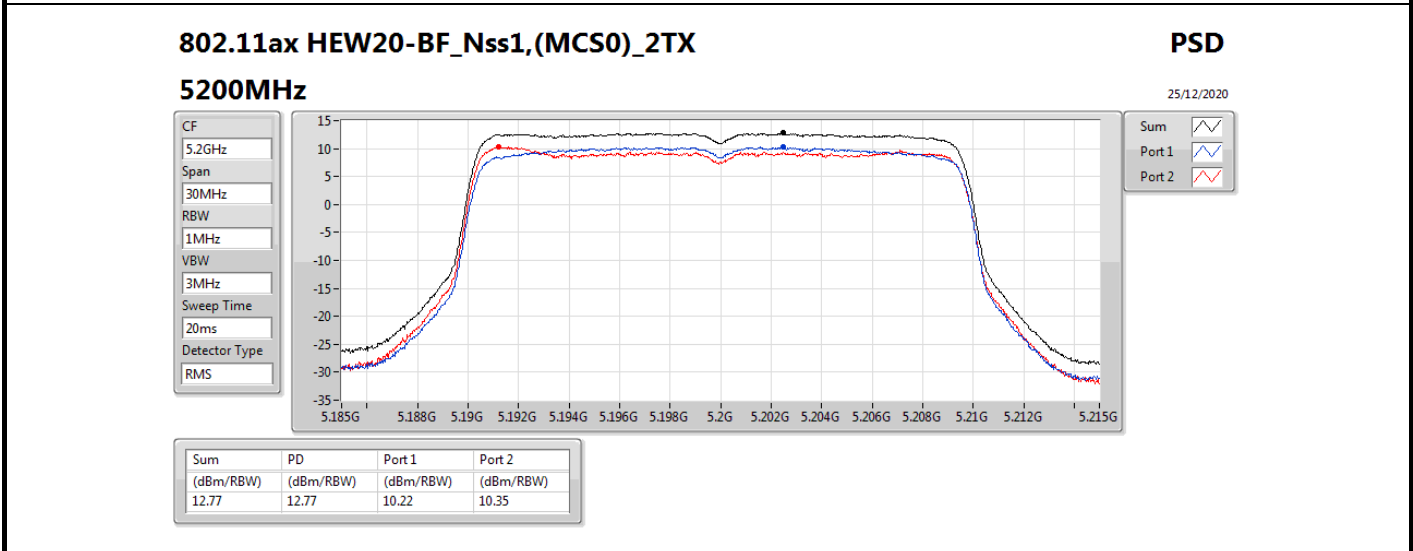
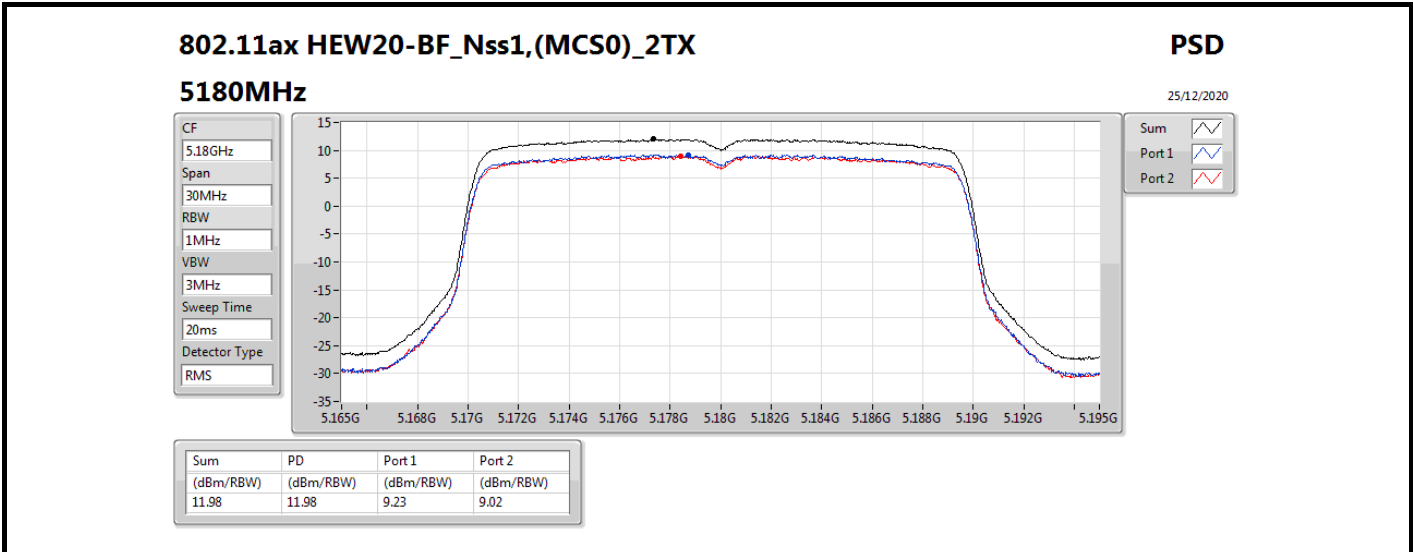

802.11ax HEW20-BF\_Nss1,(MCS0)\_2TX



PSD

5745MHz

25/12/2020

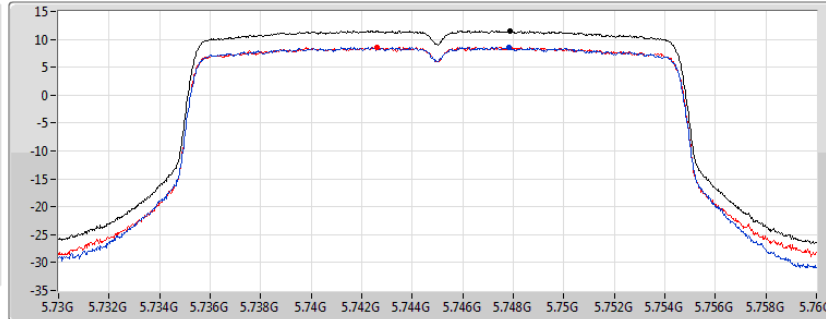
CF  
5.745GHz  
Span  
30MHz  
RBW  
500kHz  
VBW  
3MHz  
Sweep Time  
20ms  
Detector Type  
RMS



Sum   
Port 1   
Port 2 

Sum	PD	Port 1	Port 2
(dBm/RBW)	(dBm/RBW)	(dBm/RBW)	(dBm/RBW)
11.54	11.54	8.61	8.59

802.11ax HEW20-BF\_Nss1,(MCS0)\_2TX



PSD

5785MHz

25/12/2020

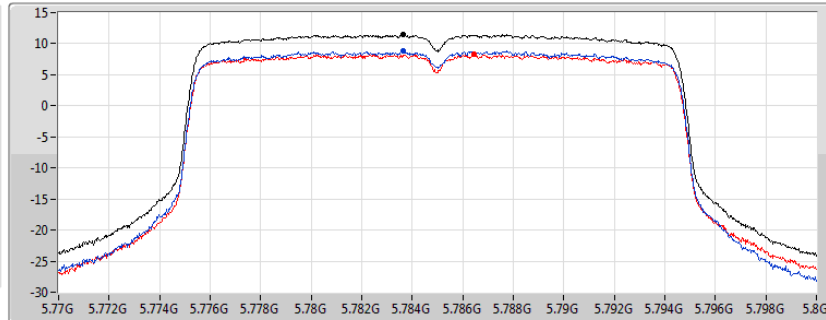
CF  
5.785GHz  
Span  
30MHz  
RBW  
500kHz  
VBW  
3MHz  
Sweep Time  
20ms  
Detector Type  
RMS



Sum   
Port 1   
Port 2 

Sum	PD	Port 1	Port 2
(dBm/RBW)	(dBm/RBW)	(dBm/RBW)	(dBm/RBW)
11.46	11.46	8.78	8.27

802.11ax HEW20-BF\_Nss1,(MCS0)\_2TX



PSD

5825MHz

25/12/2020

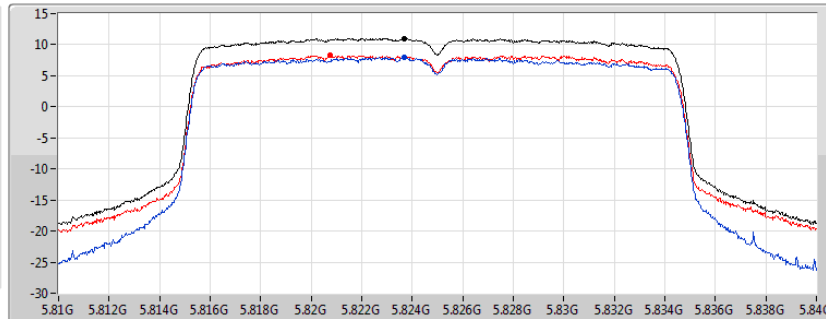
CF  
5.825GHz  
Span  
30MHz  
RBW  
500kHz  
VBW  
3MHz  
Sweep Time  
20ms  
Detector Type  
RMS



Sum   
Port 1   
Port 2 

Sum	PD	Port 1	Port 2
(dBm/RBW)	(dBm/RBW)	(dBm/RBW)	(dBm/RBW)
11.01	11.01	7.95	8.24



802.11ax HEW40-BF\_Nss1,(MCS0)\_2TX

PSD

5190MHz

25/12/2020

CF  
5.19GHz  
Span  
60MHz  
RBW  
1MHz  
VBW  
3MHz  
Sweep Time  
20ms  
Detector Type  
RMS

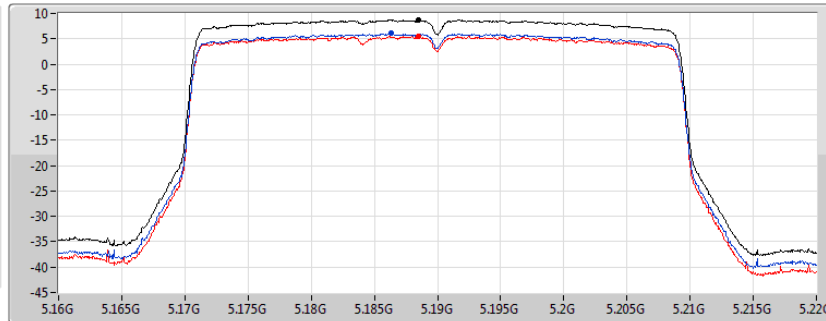

Sum  
Port 1  
Port 2

Sum	PD	Port 1	Port 2
(dBm/RBW)	(dBm/RBW)	(dBm/RBW)	(dBm/RBW)
8.73	8.73	6.03	5.42

802.11ax HEW40-BF\_Nss1,(MCS0)\_2TX

PSD

5230MHz

25/12/2020

CF  
5.23GHz  
Span  
60MHz  
RBW  
1MHz  
VBW  
3MHz  
Sweep Time  
20ms  
Detector Type  
RMS

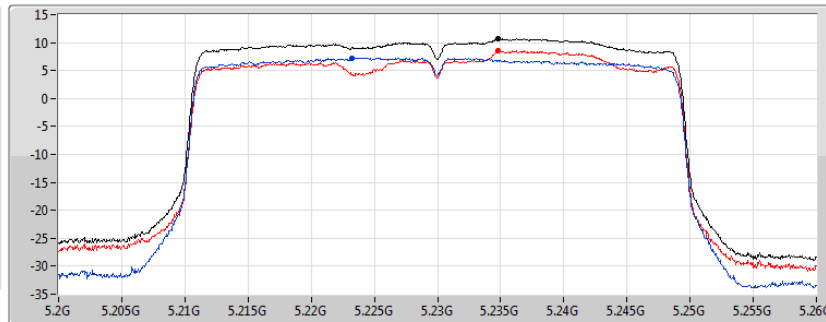

Sum  
Port 1  
Port 2

Sum	PD	Port 1	Port 2
(dBm/RBW)	(dBm/RBW)	(dBm/RBW)	(dBm/RBW)
10.74	10.74	7.27	8.50

802.11ax HEW40-BF\_Nss1,(MCS0)\_2TX

PSD

5755MHz

25/12/2020

CF  
5.755GHz  
Span  
60MHz  
RBW  
500kHz  
VBW  
3MHz  
Sweep Time  
20ms  
Detector Type  
RMS

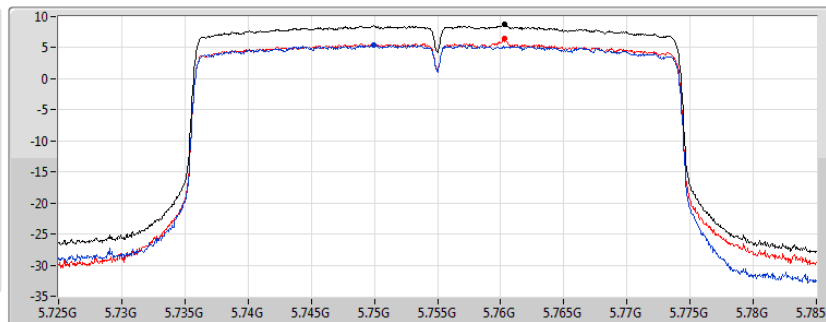

Sum  
Port 1  
Port 2

Sum	PD	Port 1	Port 2
(dBm/RBW)	(dBm/RBW)	(dBm/RBW)	(dBm/RBW)
8.78	8.78	5.46	6.44

802.11ax HEW40-BF\_Nss1,(MCS0)\_2TX



PSD

5795MHz

25/12/2020

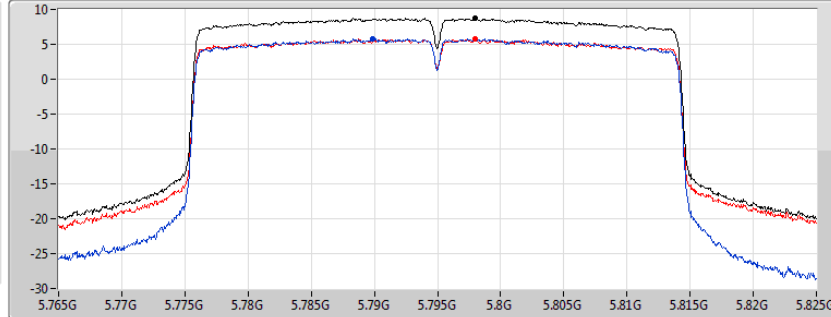
CF  
5.795GHz  
Span  
60MHz  
RBW  
500kHz  
VBW  
3MHz  
Sweep Time  
20ms  
Detector Type  
RMS



Sum   
Port 1   
Port 2 

Sum	PD	Port 1	Port 2
(dBm/RBW)	(dBm/RBW)	(dBm/RBW)	(dBm/RBW)
8.72	8.72	5.81	5.74

802.11ax HEW80-BF\_Nss1,(MCS0)\_2TX



PSD

5210MHz

25/12/2020

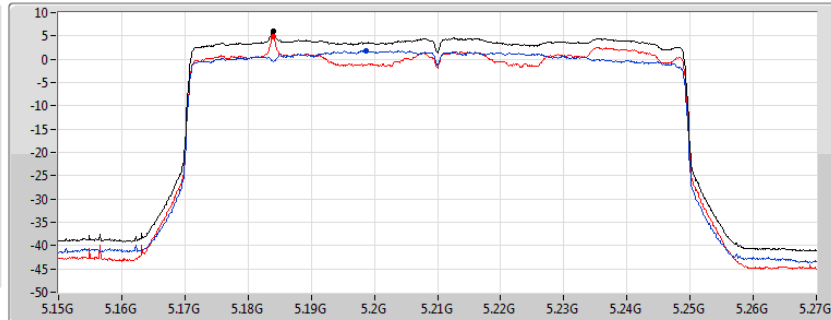
CF  
5.21GHz  
Span  
120MHz  
RBW  
1MHz  
VBW  
3MHz  
Sweep Time  
20ms  
Detector Type  
RMS



Sum   
Port 1   
Port 2 

Sum	PD	Port 1	Port 2
(dBm/RBW)	(dBm/RBW)	(dBm/RBW)	(dBm/RBW)
5.92	5.92	1.79	4.80

802.11ax HEW80-BF\_Nss1,(MCS0)\_2TX



PSD

5775MHz

25/12/2020

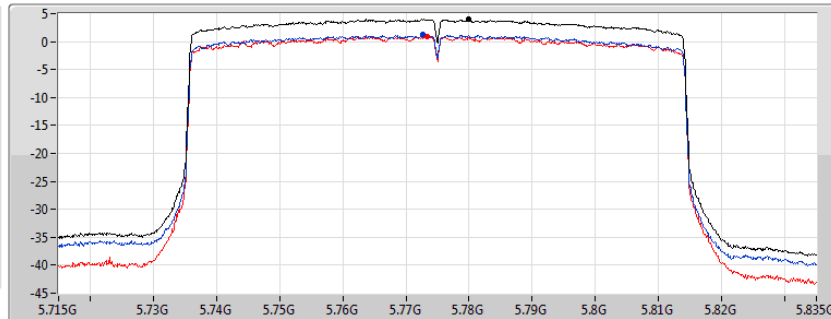
CF  
5.775GHz  
Span  
120MHz  
RBW  
500kHz  
VBW  
3MHz  
Sweep Time  
20ms  
Detector Type  
RMS



Sum   
Port 1   
Port 2 

Sum	PD	Port 1	Port 2
(dBm/RBW)	(dBm/RBW)	(dBm/RBW)	(dBm/RBW)
3.95	3.95	1.28	0.85



**Summary**

Mode	Result	Type	Freq (Hz)	Level (dBuV/m)	Limit (dBuV/m)	Margin (dB)	Condition
Mode 1	Pass	PK	60.07M	36.69	40.00	-3.31	Vertical

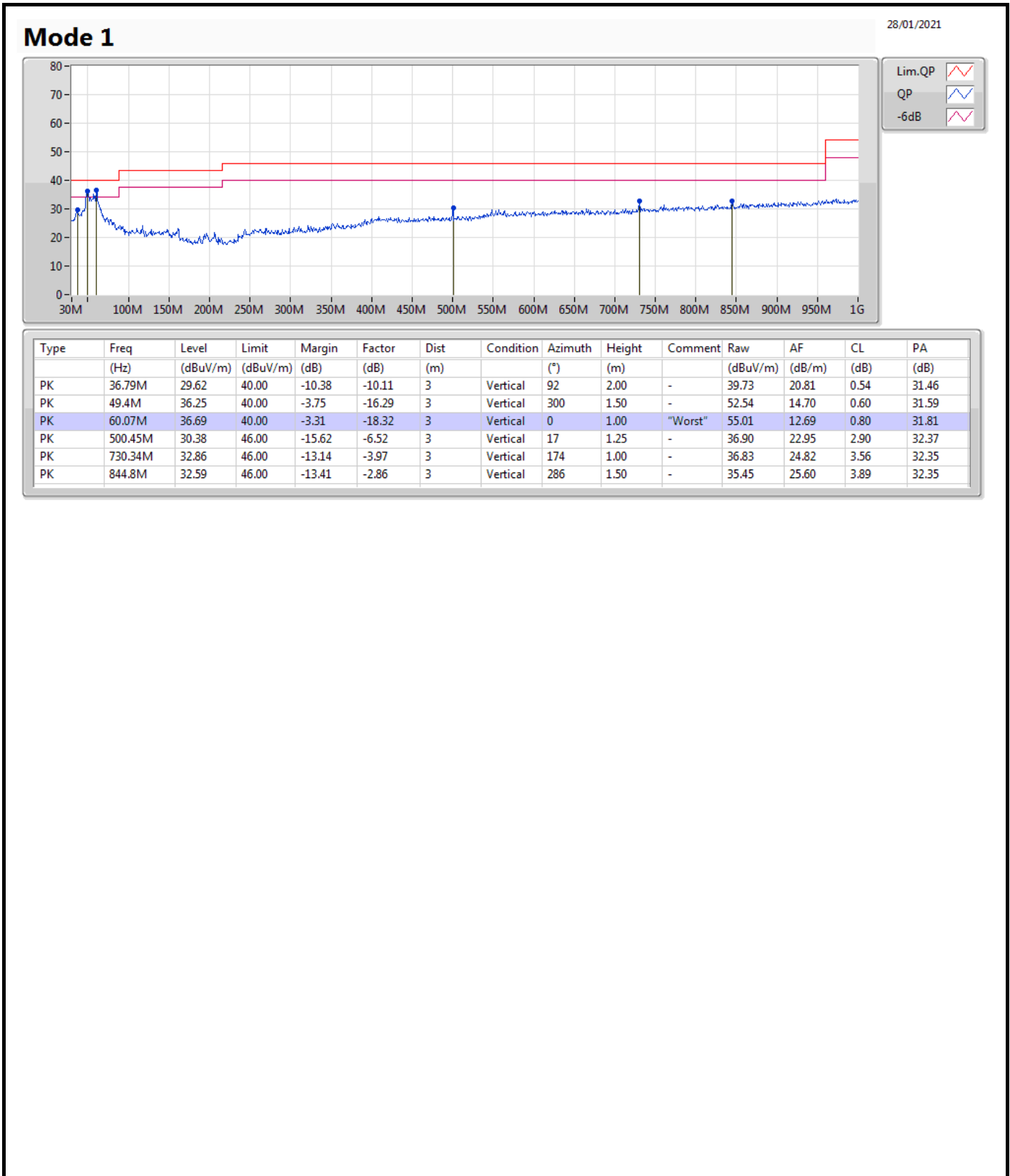

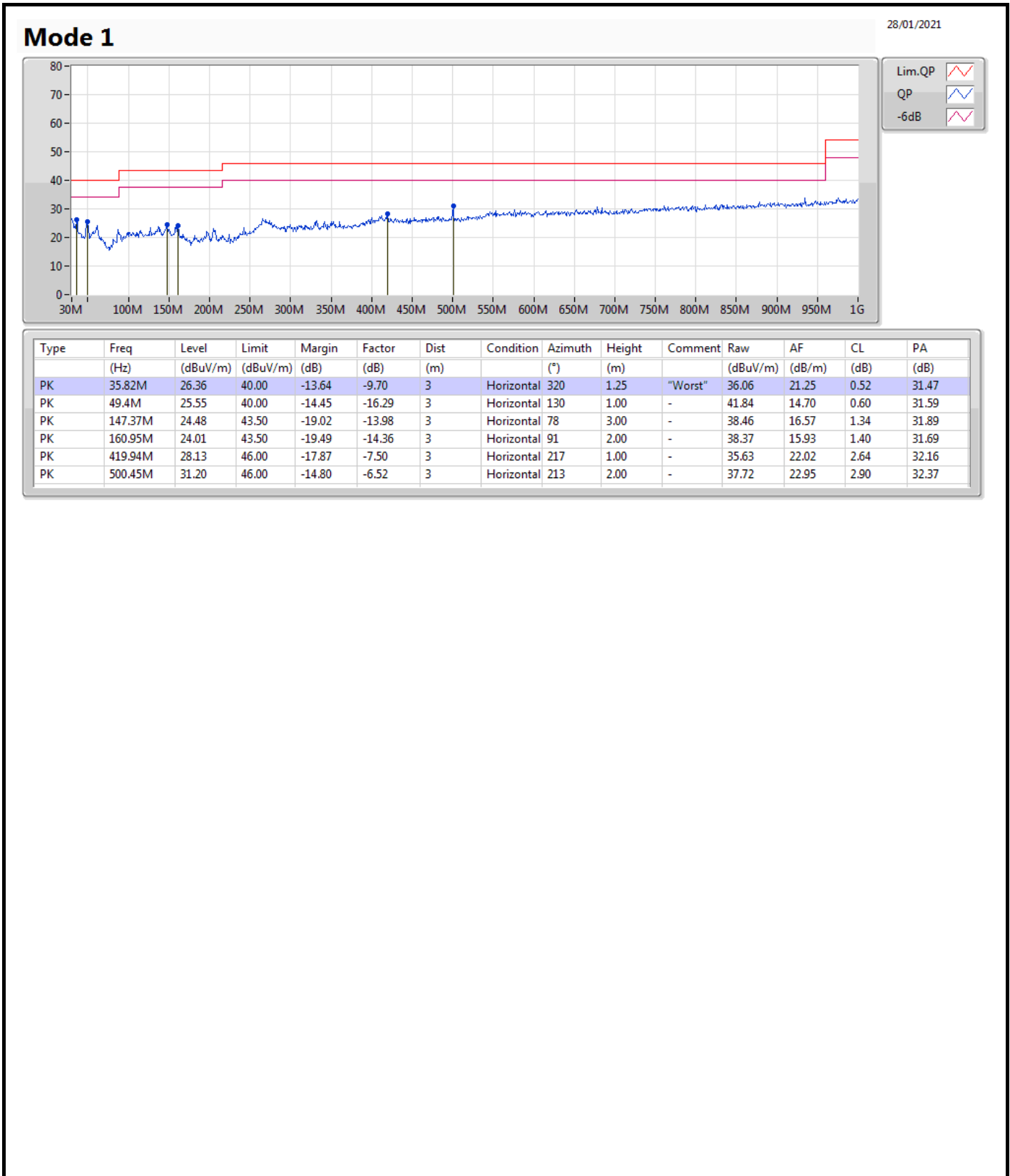



Summary

Mode	Result	Type	Freq (Hz)	Level (dBuV/m)	Limit (dBuV/m)	Margin (dB)	Dist (m)	Condition	Azimuth (°)	Height (m)	Comments
5.725-5.85GHz	-	-	-	-	-	-	-	-	-	-	-
802.11ax HEW80-BF_Nss1,(MCS0)_2TX	Pass	PK	5.651G	67.86	68.94	-1.08	3	Vertical	269	1.93	-

802.11a\_Nss1,(6Mbps)\_2TX

07/12/2020

5180MHz\_TX

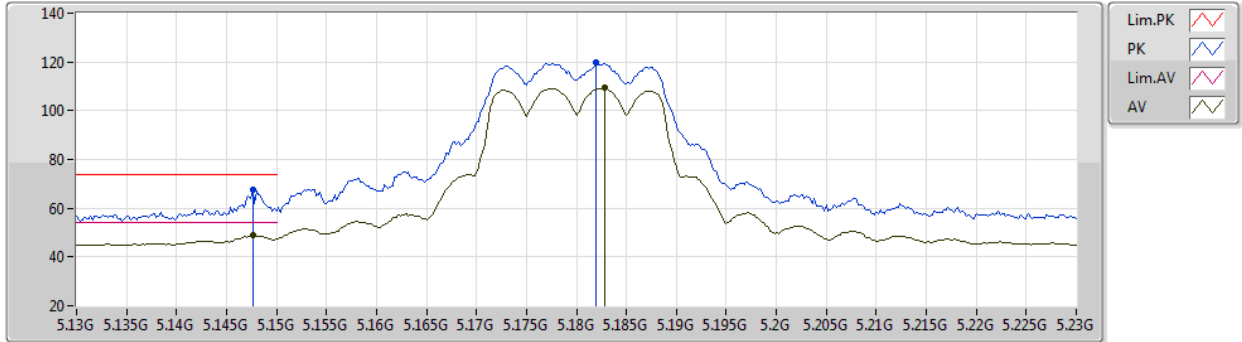

EUT Z\_2TX  
Setting 23  
02-B-C-5-10

Type	Freq (Hz)	Level (dBuV/m)	Limit (dBuV/m)	Margin (dB)	Raw (dBuV)	Dist (m)	Condition	Azimuth (°)	Height (m)	Comment	AF (dB)	CL (dB)	PA (dB)
PK	5.1476G	67.51	74.00	-6.49	60.79	3	Vertical	259	2.10	-	33.45	5.00	31.73
AV	5.1476G	48.73	54.00	-5.27	42.01	3	Vertical	259	2.10	-	33.45	5.00	31.73
PK	5.182G	119.59	Inf	-Inf	112.75	3	Vertical	259	2.10	-	33.48	5.06	31.70
AV	5.1828G	109.55	Inf	-Inf	102.70	3	Vertical	259	2.10	-	33.48	5.07	31.70



802.11a\_Nss1,(6Mbps)\_2TX

07/12/2020

5180MHz\_TX

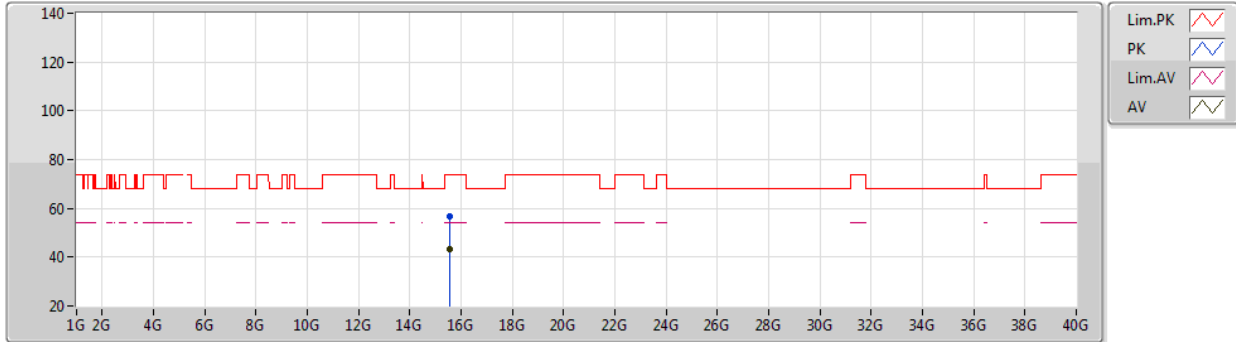

EUT\_Z\_2TX  
Setting 23  
01-A-B-2

Type	Freq (Hz)	Level (dBuV/m)	Limit (dBuV/m)	Margin (dB)	Raw (dBuV)	Dist (m)	Condition	Azimuth (°)	Height (m)	Comment	AF (dB)	CL (dB)	PA (dB)
PK	15.54436G	56.59	74.00	-17.41	44.02	3	Vertical	360	1.04	-	38.19	9.21	34.83
AV	15.5445G	43.51	54.00	-10.49	30.94	3	Vertical	360	1.04	-	38.19	9.21	34.83



802.11a\_Nss1,(6Mbps)\_2TX

07/12/2020

5180MHz\_TX

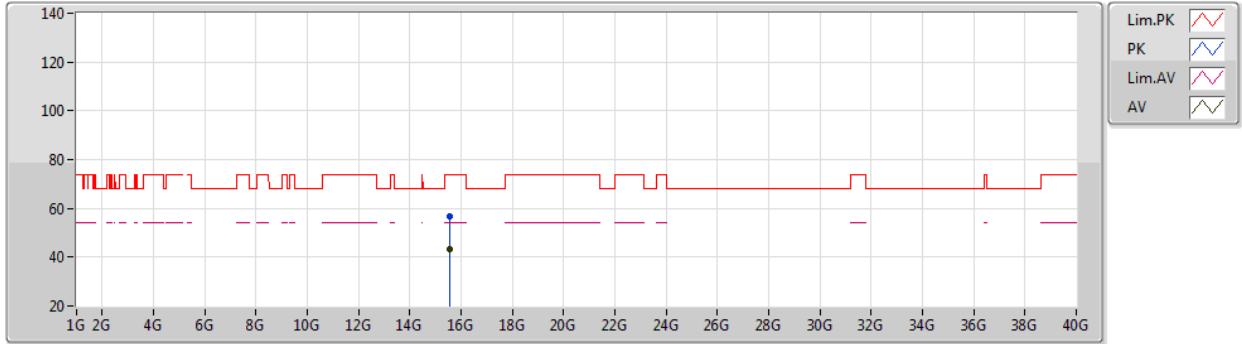

EUT\_Z\_2TX  
Setting 23  
01-A-B-2

Type	Freq (Hz)	Level (dBuV/m)	Limit (dBuV/m)	Margin (dB)	Raw (dBuV)	Dist (m)	Condition	Azimuth (°)	Height (m)	Comment	AF (dB)	CL (dB)	PA (dB)
PK	15.5361G	56.81	74.00	-17.19	44.25	3	Horizontal	46	1.80	-	38.17	9.21	34.82
AV	15.53698G	43.27	54.00	-10.73	30.71	3	Horizontal	46	1.80	-	38.17	9.21	34.82

802.11a\_Nss1,(6Mbps)\_2TX

07/12/2020

5200MHz\_TX

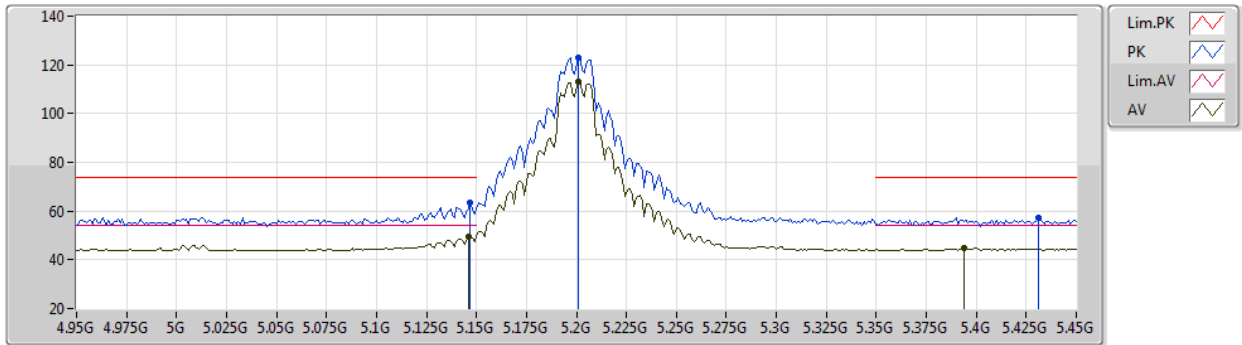

EUT\_Z\_2TX  
Setting 26  
01-A-B-2-10

Type	Freq (Hz)	Level (dBuV/m)	Limit (dBuV/m)	Margin (dB)	Raw (dBuV)	Dist (m)	Condition	Azimuth (°)	Height (m)	Comment	AF (dB)	CL (dB)	PA (dB)
PK	5.147G	63.69	74.00	-10.31	60.55	3	Vertical	258	2.07	-	32.60	5.17	34.63
AV	5.146G	49.68	54.00	-4.32	46.54	3	Vertical	258	2.07	-	32.60	5.17	34.63
PK	5.201G	122.94	Inf	-Inf	119.69	3	Vertical	258	2.07	-	32.70	5.20	34.65
AV	5.201G	112.91	Inf	-Inf	109.66	3	Vertical	258	2.07	-	32.70	5.20	34.65
PK	5.431G	57.37	74.00	-16.63	53.39	3	Vertical	258	2.07	-	33.32	5.40	34.74
AV	5.394G	44.82	54.00	-9.18	40.99	3	Vertical	258	2.07	-	33.16	5.39	34.72

802.11a\_Nss1,(6Mbps)\_2TX

07/12/2020

5200MHz\_TX

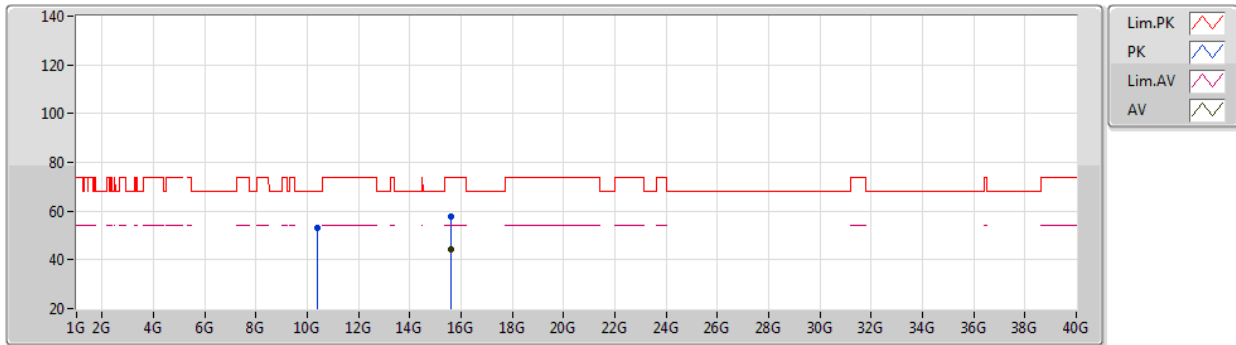

EUT Z\_2TX  
Setting 26  
01-A-B-2

Type	Freq (Hz)	Level (dBuV/m)	Limit (dBuV/m)	Margin (dB)	Raw (dBuV)	Dist (m)	Condition	Azimuth (°)	Height (m)	Comment	AF (dB)	CL (dB)	PA (dB)
PK	10.39618G	52.91	68.20	-15.29	42.62	3	Vertical	318	2.02	-	38.20	7.44	35.35
PK	15.59488G	57.87	74.00	-16.13	45.24	3	Vertical	311	1.06	-	38.29	9.22	34.88
AV	15.59992G	44.37	54.00	-9.63	31.73	3	Vertical	311	1.06	-	38.30	9.22	34.88



802.11a\_Nss1,(6Mbps)\_2TX

07/12/2020

5200MHz\_TX

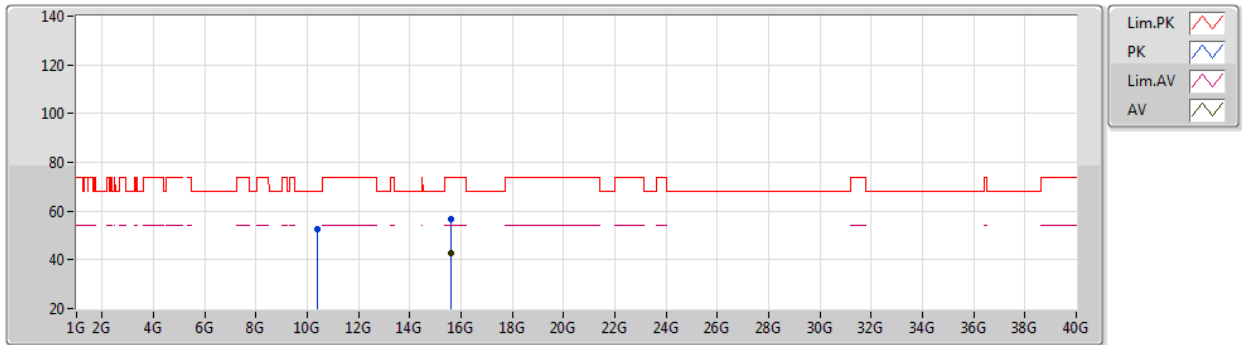

EUT\_Z\_2TX  
Setting 26  
01-A-B-2

Type	Freq (Hz)	Level (dBuV/m)	Limit (dBuV/m)	Margin (dB)	Raw (dBuV)	Dist (m)	Condition	Azimuth (°)	Height (m)	Comment	AF (dB)	CL (dB)	PA (dB)
PK	10.40156G	52.63	68.20	-15.57	42.34	3	Horizontal	228	1.03	-	38.20	7.44	35.35
PK	15.59268G	56.70	74.00	-17.30	44.06	3	Horizontal	319	1.80	-	38.29	9.22	34.87
AV	15.5902G	42.88	54.00	-11.12	30.25	3	Horizontal	319	1.80	-	38.28	9.22	34.87

802.11a\_Nss1,(6Mbps)\_2TX

07/12/2020

5240MHz\_TX

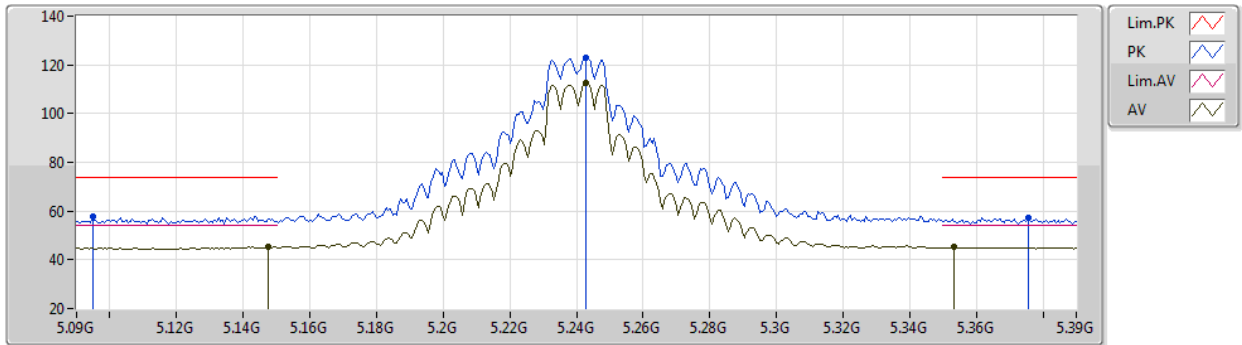

EUT\_Z\_2TX  
Setting 27  
02-B-C-5-10

Type	Freq (Hz)	Level (dBuV/m)	Limit (dBuV/m)	Margin (dB)	Raw (dBuV)	Dist (m)	Condition	Azimuth (°)	Height (m)	Comment	AF (dB)	CL (dB)	PA (dB)
PK	5.0948G	57.99	74.00	-16.01	51.47	3	Vertical	327	2.14	-	33.39	4.89	31.76
AV	5.1476G	45.50	54.00	-8.50	38.78	3	Vertical	327	2.14	-	33.45	5.00	31.73
PK	5.243G	123.11	Inf	-Inf	116.10	3	Vertical	327	2.14	-	33.59	5.08	31.66
AV	5.243G	112.74	Inf	-Inf	105.73	3	Vertical	327	2.14	-	33.59	5.08	31.66
PK	5.3756G	57.29	74.00	-16.71	50.07	3	Vertical	327	2.14	-	33.78	5.01	31.57
AV	5.3534G	45.15	54.00	-8.85	37.96	3	Vertical	327	2.14	-	33.75	5.02	31.58

802.11a\_Nss1,(6Mbps)\_2TX

07/12/2020

5240MHz\_TX

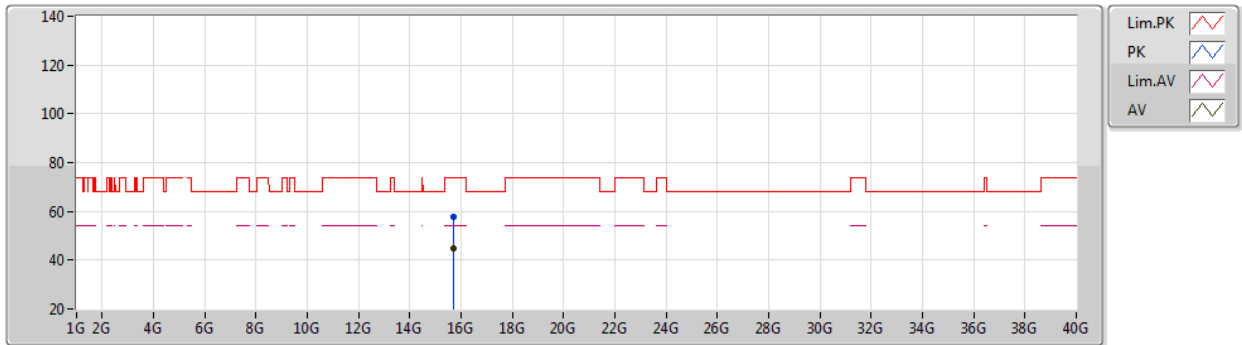

EUT Z\_2TX  
Setting 27  
02-B-C-5

Type	Freq (Hz)	Level (dBuV/m)	Limit (dBuV/m)	Margin (dB)	Raw (dBuV)	Dist (m)	Condition	Azimuth (°)	Height (m)	Comment	AF (dB)	CL (dB)	PA (dB)
PK	15.7182G	57.88	74.00	-16.12	43.43	3	Vertical	305	1.81	-	38.22	9.10	32.87
AV	15.7231G	44.86	54.00	-9.14	30.43	3	Vertical	305	1.81	-	38.20	9.10	32.87



802.11a\_Nss1,(6Mbps)\_2TX

07/12/2020

5240MHz\_TX

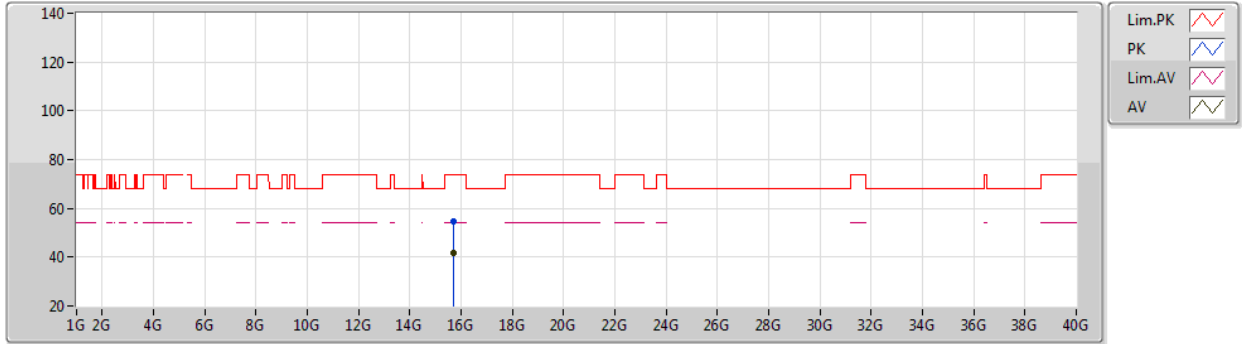

EUT\_Z\_2TX  
Setting 27  
02-B-C-5

Type	Freq (Hz)	Level (dBuV/m)	Limit (dBuV/m)	Margin (dB)	Raw (dBuV)	Dist (m)	Condition	Azimuth (°)	Height (m)	Comment	AF (dB)	CL (dB)	PA (dB)
PK	15.7281G	54.87	74.00	-19.13	40.45	3	Horizontal	53	2.44	-	38.19	9.10	32.87
AV	15.7229G	41.88	54.00	-12.12	27.45	3	Horizontal	53	2.44	-	38.20	9.10	32.87



802.11a\_Nss1,(6Mbps)\_2TX

07/12/2020

5745MHz\_TX

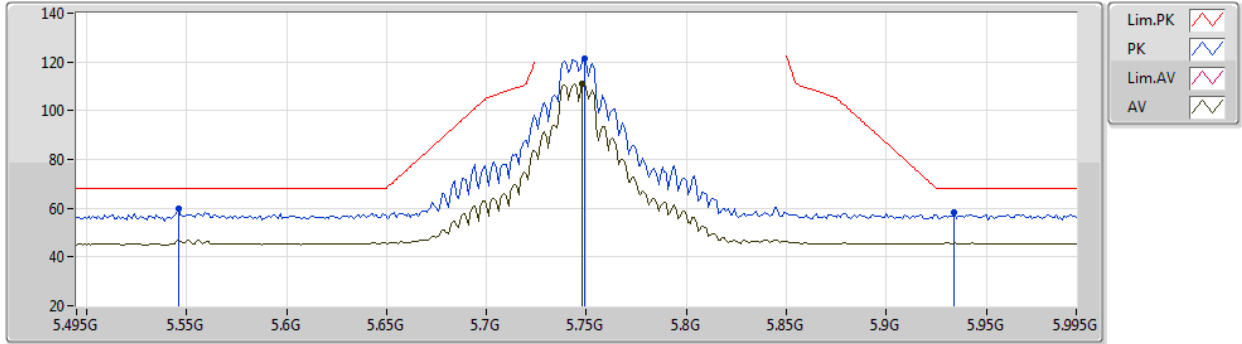

EUT\_Z\_2TX  
Setting 27  
02-B-C-5-10

Type	Freq (Hz)	Level (dBuV/m)	Limit (dBuV/m)	Margin (dB)	Raw (dBuV)	Dist (m)	Condition	Azimuth (°)	Height (m)	Comment	AF (dB)	CL (dB)	PA (dB)
PK	5.546G	59.59	68.20	-8.61	52.01	3	Vertical	219	1.85	-	33.90	5.15	31.47
PK	5.749G	121.34	Inf	-Inf	113.95	3	Vertical	219	1.85	-	33.80	5.05	31.46
AV	5.748G	111.14	Inf	-Inf	103.75	3	Vertical	219	1.85	-	33.80	5.05	31.46
PK	5.934G	58.08	68.20	-10.12	50.00	3	Vertical	219	1.85	-	34.13	5.40	31.45



802.11a\_Nss1,(6Mbps)\_2TX

07/12/2020

5745MHz\_TX

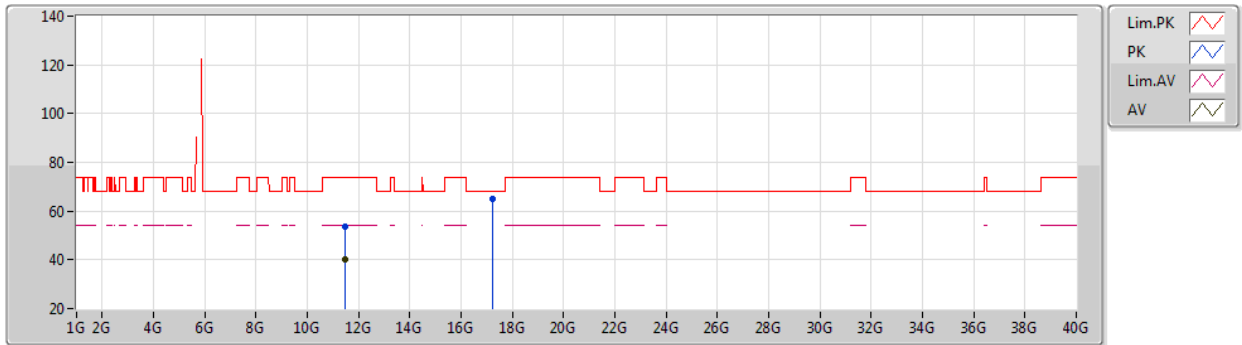

EUT Z\_2TX  
Setting 27  
02-B-C-5

Type	Freq (Hz)	Level (dBuV/m)	Limit (dBuV/m)	Margin (dB)	Raw (dBuV)	Dist (m)	Condition	Azimuth (°)	Height (m)	Comment	AF (dB)	CL (dB)	PA (dB)
PK	11.4842G	53.58	74.00	-20.42	39.92	3	Vertical	348	2.35	-	38.89	7.62	32.85
AV	11.488G	40.12	54.00	-13.88	26.46	3	Vertical	348	2.35	-	38.89	7.62	32.85
PK	17.2263G	64.97	68.20	-3.23	46.21	3	Vertical	64	1.00	-	42.42	9.32	32.98

802.11a\_Nss1,(6Mbps)\_2TX

07/12/2020

5745MHz\_TX

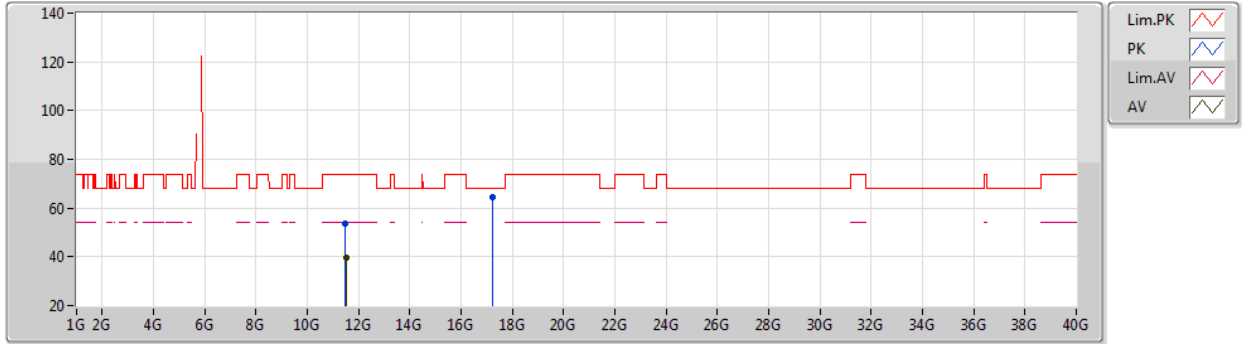

EUT\_Z\_2TX  
Setting 27  
02-B-C-5

Type	Freq (Hz)	Level (dBuV/m)	Limit (dBuV/m)	Margin (dB)	Raw (dBuV)	Dist (m)	Condition	Azimuth (°)	Height (m)	Comment	AF (dB)	CL (dB)	PA (dB)
PK	11.4792G	53.39	74.00	-20.61	39.74	3	Horizontal	96	1.80	-	38.88	7.62	32.85
AV	11.5059G	39.61	54.00	-14.39	25.93	3	Horizontal	96	1.80	-	38.90	7.63	32.85
PK	17.2414G	64.47	68.20	-3.73	45.63	3	Horizontal	287	2.95	-	42.50	9.32	32.98



802.11a\_Nss1,(6Mbps)\_2TX

07/12/2020

5785MHz\_TX

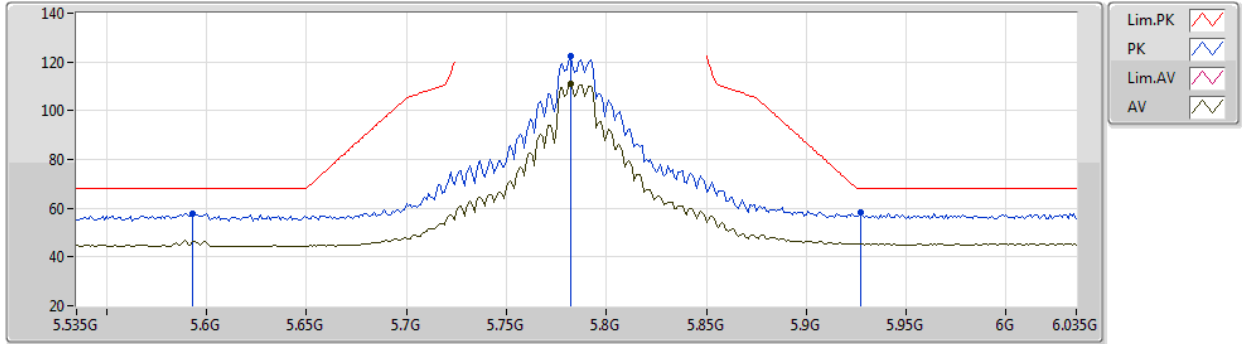

EUT\_Z\_2TX  
Setting 27  
01-A-B-2-10

Type	Freq (Hz)	Level (dBuV/m)	Limit (dBuV/m)	Margin (dB)	Raw (dBuV)	Dist (m)	Condition	Azimuth (°)	Height (m)	Comment	AF (dB)	CL (dB)	PA (dB)
PK	5.593G	57.86	68.20	-10.34	53.39	3	Vertical	165	1.93	-	33.79	5.40	34.72
PK	5.782G	122.19	Inf	-Inf	117.12	3	Vertical	165	1.93	-	34.23	5.49	34.65
AV	5.782G	111.28	Inf	-Inf	106.21	3	Vertical	165	1.93	-	34.23	5.49	34.65
PK	5.927G	58.05	68.20	-10.15	52.24	3	Vertical	165	1.93	-	34.91	5.50	34.60



802.11a\_Nss1,(6Mbps)\_2TX

07/12/2020

5785MHz\_TX

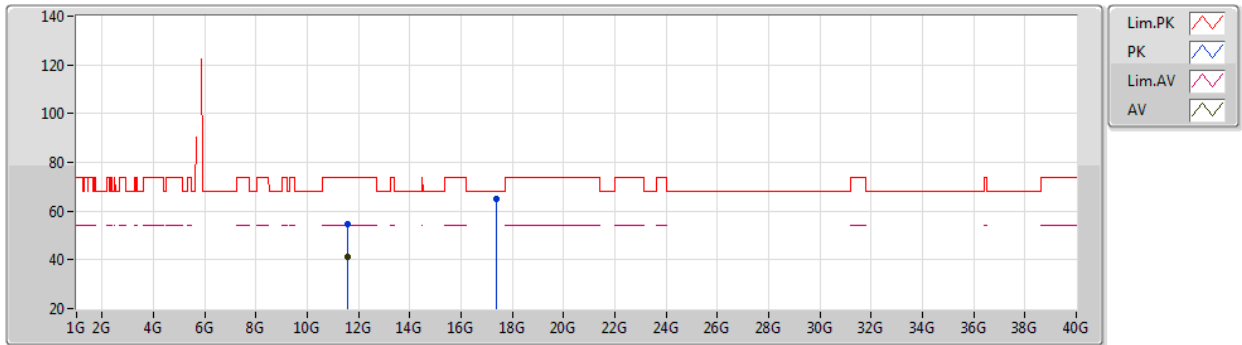

EUT Z\_2TX  
Setting 27  
01-A-B-2

Type	Freq (Hz)	Level (dBuV/m)	Limit (dBuV/m)	Margin (dB)	Raw (dBuV)	Dist (m)	Condition	Azimuth (°)	Height (m)	Comment	AF (dB)	CL (dB)	PA (dB)
PK	11.56866G	54.54	74.00	-19.46	43.14	3	Vertical	337	1.04	-	38.40	7.85	34.85
AV	11.56792G	41.11	54.00	-12.89	29.71	3	Vertical	337	1.04	-	38.40	7.85	34.85
PK	17.3541G	65.19	68.20	-3.01	47.24	3	Vertical	319	1.11	-	42.12	9.77	33.94

802.11a\_Nss1,(6Mbps)\_2TX

07/12/2020

5785MHz\_TX

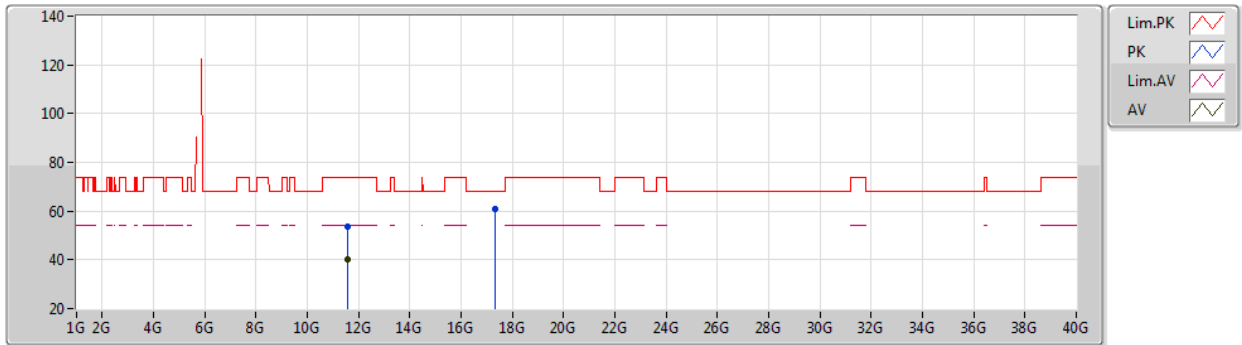

EUT\_Z\_2TX  
Setting 27  
01-A-B-2

Type	Freq (Hz)	Level (dBuV/m)	Limit (dBuV/m)	Margin (dB)	Raw (dBuV)	Dist (m)	Condition	Azimuth (°)	Height (m)	Comment	AF (dB)	CL (dB)	PA (dB)
PK	11.57182G	53.55	74.00	-20.45	42.16	3	Horizontal	32	1.59	-	38.40	7.85	34.86
AV	11.57426G	40.36	54.00	-13.64	28.97	3	Horizontal	32	1.59	-	38.40	7.85	34.86
PK	17.3428G	60.89	68.20	-7.31	42.99	3	Horizontal	311	1.80	-	42.07	9.77	33.94

802.11a\_Nss1,(6Mbps)\_2TX

07/12/2020

5825MHz\_TX

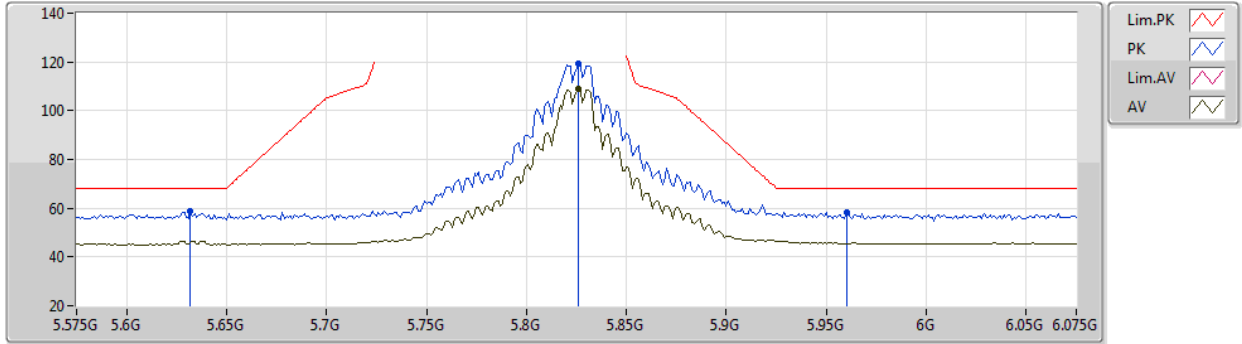

EUT\_Z\_2TX  
Setting 27  
02-B-C-5-10

Type	Freq (Hz)	Level (dBuV/m)	Limit (dBuV/m)	Margin (dB)	Raw (dBuV)	Dist (m)	Condition	Azimuth (°)	Height (m)	Comment	AF (dB)	CL (dB)	PA (dB)
PK	5.632G	58.87	68.20	-9.33	51.30	3	Vertical	224	1.76	-	33.87	5.17	31.47
PK	5.826G	119.44	Inf	-Inf	111.94	3	Vertical	224	1.76	-	33.88	5.08	31.46
AV	5.826G	109.09	Inf	-Inf	101.59	3	Vertical	224	1.76	-	33.88	5.08	31.46
PK	5.96G	58.23	68.20	-9.97	50.04	3	Vertical	224	1.76	-	34.16	5.48	31.45

802.11a\_Nss1,(6Mbps)\_2TX

07/12/2020

5825MHz\_TX



EUT\_Z\_2TX  
Setting 27  
02-B-C-5

Type	Freq (Hz)	Level (dBuV/m)	Limit (dBuV/m)	Margin (dB)	Raw (dBuV)	Dist (m)	Condition	Azimuth (°)	Height (m)	Comment	AF (dB)	CL (dB)	PA (dB)
PK	11.6673G	53.10	74.00	-20.90	39.27	3	Vertical	295	2.07	-	39.03	7.68	32.88
AV	11.6509G	39.73	54.00	-14.27	25.91	3	Vertical	295	2.07	-	39.02	7.68	32.88
PK	17.4813G	62.35	68.20	-5.85	42.21	3	Vertical	58	1.01	-	43.80	9.35	33.01

802.11a\_Nss1,(6Mbps)\_2TX

07/12/2020

5825MHz\_TX

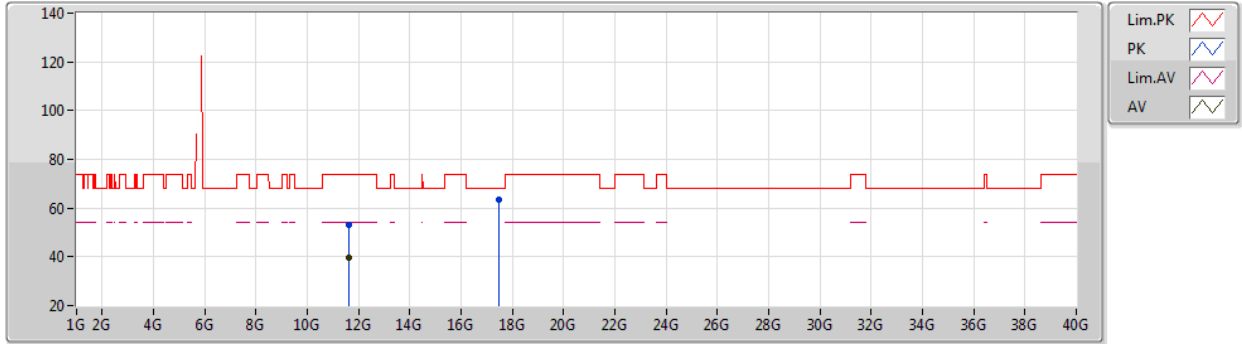

EUT\_Z\_2TX  
Setting 27  
02-B-C-5

Type	Freq (Hz)	Level (dBuV/m)	Limit (dBuV/m)	Margin (dB)	Raw (dBuV)	Dist (m)	Condition	Azimuth (°)	Height (m)	Comment	AF (dB)	CL (dB)	PA (dB)
PK	11.6456G	53.00	74.00	-21.00	39.18	3	Horizontal	123	2.16	-	39.02	7.68	32.88
AV	11.6404G	39.90	54.00	-14.10	26.10	3	Horizontal	123	2.16	-	39.01	7.67	32.88
PK	17.4665G	63.50	68.20	-4.70	43.44	3	Horizontal	60	2.86	-	43.72	9.35	33.01



802.11ax HEW20-BF\_Nss1,(MCS0)\_2TX

07/12/2020

5180MHz\_TX

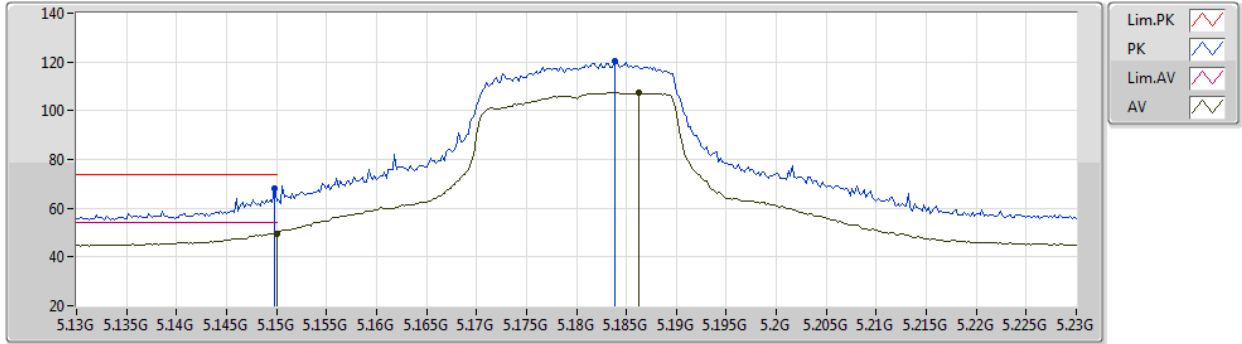

EUT Z\_2TX  
Setting 26  
02-B-C-5-10

Type	Freq (Hz)	Level (dBuV/m)	Limit (dBuV/m)	Margin (dB)	Raw (dBuV)	Dist (m)	Condition	Azimuth (°)	Height (m)	Comment	AF (dB)	CL (dB)	PA (dB)
PK	5.1498G	67.85	74.00	-6.15	61.13	3	Vertical	2	1.70	-	33.45	5.00	31.73
AV	5.15G	49.67	54.00	-4.33	42.95	3	Vertical	2	1.70	-	33.45	5.00	31.73
PK	5.1838G	120.45	Inf	-Inf	113.60	3	Vertical	2	1.70	-	33.48	5.07	31.70
AV	5.1862G	107.41	Inf	-Inf	100.55	3	Vertical	2	1.70	-	33.49	5.07	31.70

802.11ax HEW20-BF\_Nss1,(MCS0)\_2TX

07/12/2020

5180MHz\_TX

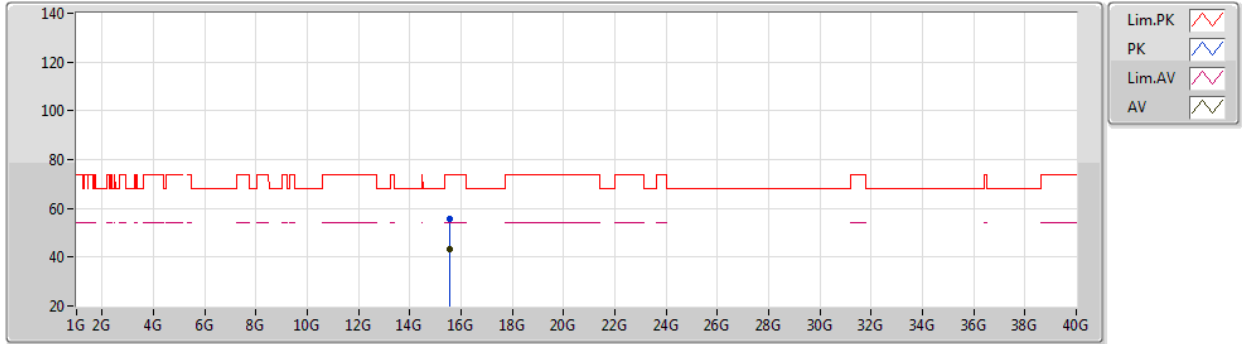

EUT\_Z\_2TX  
Setting 26  
01-A-B-2

Type	Freq (Hz)	Level (dBuV/m)	Limit (dBuV/m)	Margin (dB)	Raw (dBuV)	Dist (m)	Condition	Azimuth (°)	Height (m)	Comment	AF (dB)	CL (dB)	PA (dB)
PK	15.54068G	55.89	74.00	-18.11	43.32	3	Vertical	71	2.80	-	38.18	9.21	34.82
AV	15.54188G	43.24	54.00	-10.76	30.67	3	Vertical	71	2.80	-	38.18	9.21	34.82

802.11ax HEW20-BF\_Nss1,(MCS0)\_2TX

07/12/2020

5180MHz\_TX

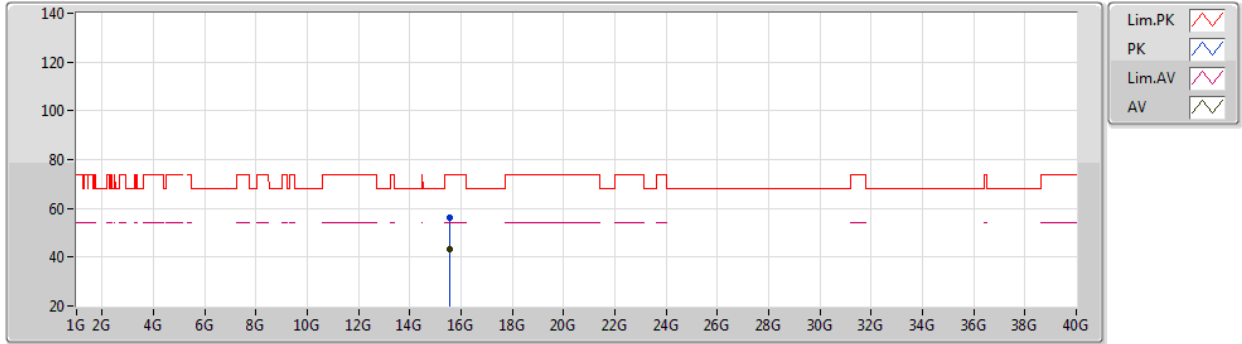

EUT\_Z\_2TX  
Setting 26  
01-A-B-2

Type	Freq (Hz)	Level (dBuV/m)	Limit (dBuV/m)	Margin (dB)	Raw (dBuV)	Dist (m)	Condition	Azimuth (°)	Height (m)	Comment	AF (dB)	CL (dB)	PA (dB)
PK	15.5412G	55.97	74.00	-18.03	43.40	3	Horizontal	138	1.96	-	38.18	9.21	34.82
AV	15.54442G	43.02	54.00	-10.98	30.45	3	Horizontal	138	1.96	-	38.19	9.21	34.83

802.11ax HEW20-BF\_Nss1,(MCS0)\_2TX

07/12/2020

5200MHz\_TX

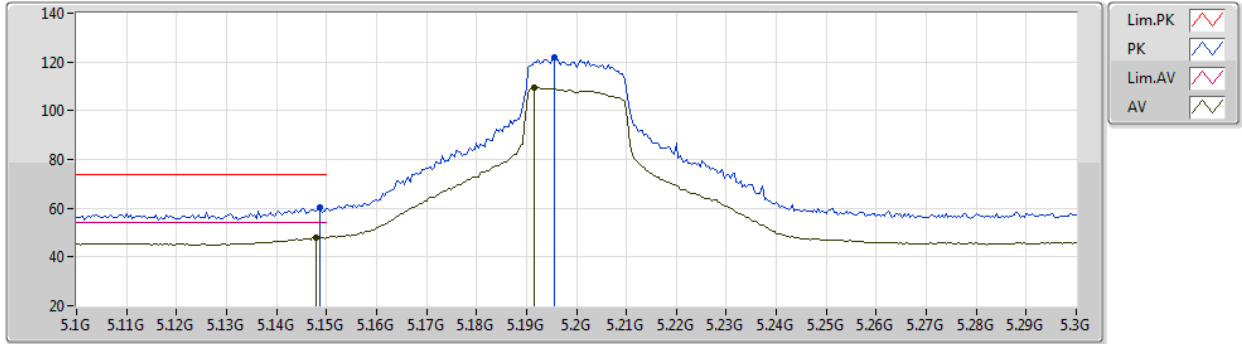

EUT\_Z\_2TX  
Setting 27  
02-B-C-5-10

Type	Freq (Hz)	Level (dBuV/m)	Limit (dBuV/m)	Margin (dB)	Raw (dBuV)	Dist (m)	Condition	Azimuth (°)	Height (m)	Comment	AF (dB)	CL (dB)	PA (dB)
PK	5.1488G	60.37	74.00	-13.63	53.65	3	Vertical	338	2.18	-	33.45	5.00	31.73
AV	5.148G	47.94	54.00	-6.06	41.22	3	Vertical	338	2.18	-	33.45	5.00	31.73
PK	5.1956G	121.89	Inf	-Inf	114.99	3	Vertical	338	2.18	-	33.50	5.09	31.69
AV	5.1916G	109.49	Inf	-Inf	102.62	3	Vertical	338	2.18	-	33.49	5.08	31.70

802.11ax HEW20-BF\_Nss1,(MCS0)\_2TX

07/12/2020

5200MHz\_TX

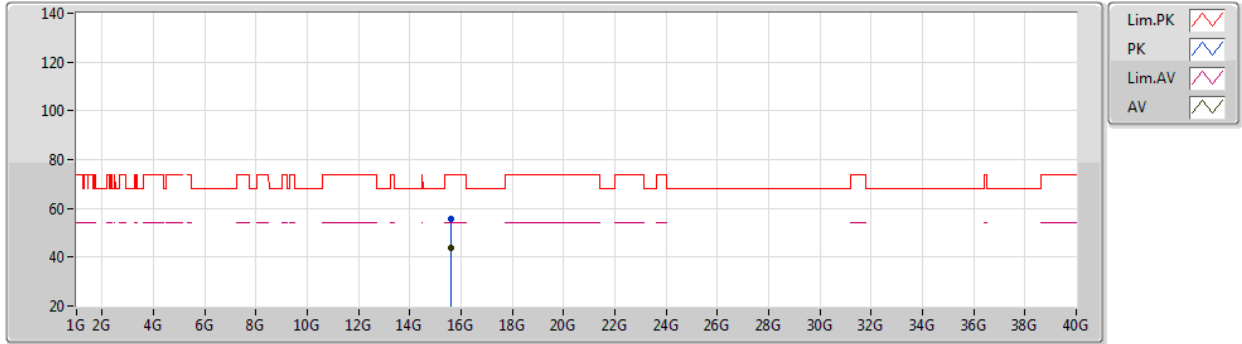

EUT\_Z\_2TX  
Setting 27  
01-A-B-2

Type	Freq (Hz)	Level (dBuV/m)	Limit (dBuV/m)	Margin (dB)	Raw (dBuV)	Dist (m)	Condition	Azimuth (°)	Height (m)	Comment	AF (dB)	CL (dB)	PA (dB)
PK	15.6022G	55.90	74.00	-18.10	43.26	3	Vertical	155	2.61	-	38.30	9.22	34.88
AV	15.60414G	43.59	54.00	-10.41	30.96	3	Vertical	155	2.61	-	38.30	9.22	34.89

802.11ax HEW20-BF\_Nss1,(MCS0)\_2TX

07/12/2020

5200MHz\_TX

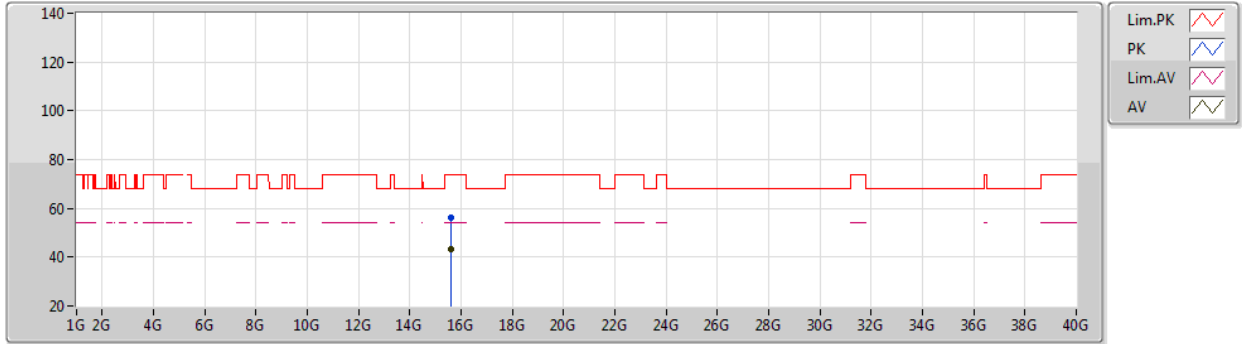

EUT Z\_2TX  
Setting 27  
01-A-B-2

Type	Freq (Hz)	Level (dBuV/m)	Limit (dBuV/m)	Margin (dB)	Raw (dBuV)	Dist (m)	Condition	Azimuth (°)	Height (m)	Comment	AF (dB)	CL (dB)	PA (dB)
PK	15.59964G	56.29	74.00	-17.71	43.65	3	Horizontal	266	1.01	-	38.30	9.22	34.88
AV	15.59892G	43.13	54.00	-10.87	30.49	3	Horizontal	266	1.01	-	38.30	9.22	34.88

802.11ax HEW20-BF\_Nss1,(MCS0)\_2TX

07/12/2020

5240MHz\_TX

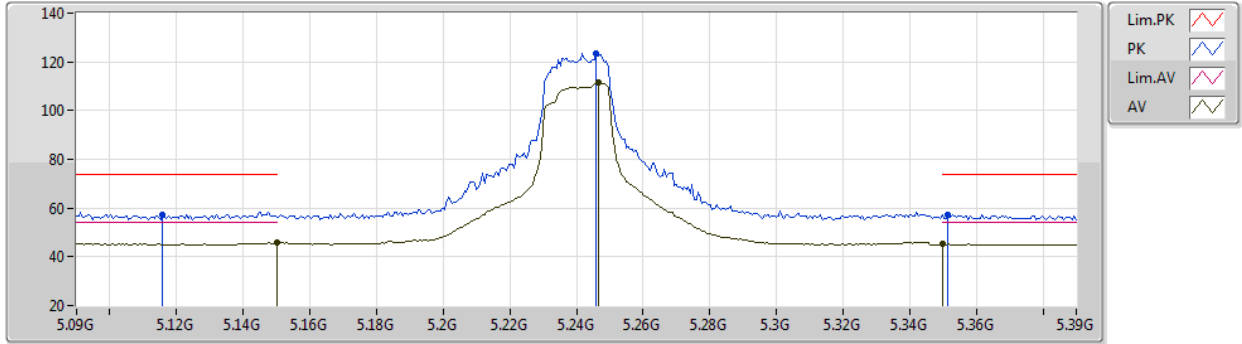

EUT\_Z\_2TX  
Setting 27  
02-B-C-5-10

Type	Freq (Hz)	Level (dBuV/m)	Limit (dBuV/m)	Margin (dB)	Raw (dBuV)	Dist (m)	Condition	Azimuth (°)	Height (m)	Comment	AF (dB)	CL (dB)	PA (dB)
PK	5.1158G	57.50	74.00	-16.50	50.90	3	Vertical	257	2.29	-	33.42	4.93	31.75
AV	5.15G	45.73	54.00	-8.27	39.01	3	Vertical	257	2.29	-	33.45	5.00	31.73
PK	5.246G	123.38	Inf	-Inf	116.37	3	Vertical	257	2.29	-	33.59	5.08	31.66
AV	5.2466G	111.56	Inf	-Inf	104.55	3	Vertical	257	2.29	-	33.59	5.08	31.66
PK	5.3516G	57.45	74.00	-16.55	50.26	3	Vertical	257	2.29	-	33.75	5.02	31.58
AV	5.35G	45.14	54.00	-8.86	37.95	3	Vertical	257	2.29	-	33.75	5.02	31.58

802.11ax HEW20-BF\_Nss1,(MCS0)\_2TX

07/12/2020

5240MHz\_TX

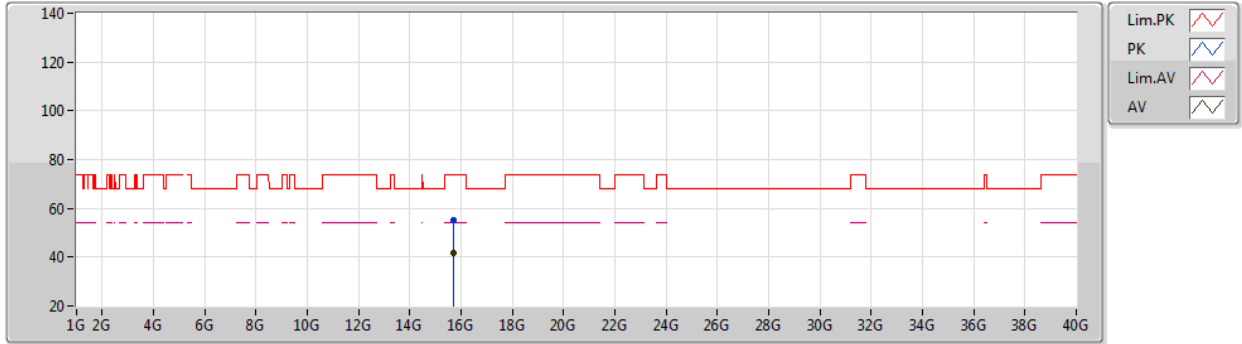

EUT Z\_2TX  
Setting 27  
01-A-B-2

Type	Freq (Hz)	Level (dBuV/m)	Limit (dBuV/m)	Margin (dB)	Raw (dBuV)	Dist (m)	Condition	Azimuth (°)	Height (m)	Comment	AF (dB)	CL (dB)	PA (dB)
PK	15.72074G	54.93	74.00	-19.07	42.30	3	Vertical	311	1.81	-	38.40	9.24	35.01
AV	15.72044G	41.58	54.00	-12.42	28.94	3	Vertical	311	1.81	-	38.40	9.24	35.00



802.11ax HEW20-BF\_Nss1,(MCS0)\_2TX

07/12/2020

5240MHz\_TX

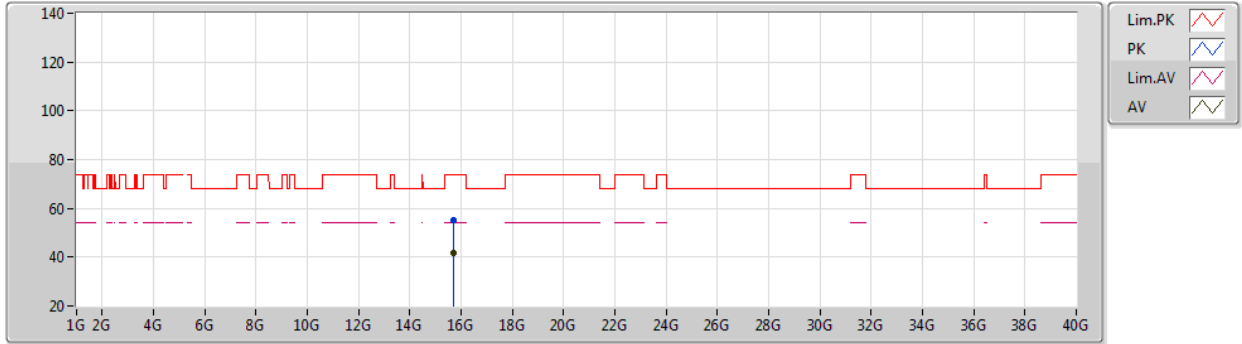

EUT Z\_2TX  
Setting 27  
01-A-B-2

Type	Freq (Hz)	Level (dBuV/m)	Limit (dBuV/m)	Margin (dB)	Raw (dBuV)	Dist (m)	Condition	Azimuth (°)	Height (m)	Comment	AF (dB)	CL (dB)	PA (dB)
PK	15.71508G	55.25	74.00	-18.75	42.61	3	Horizontal	174	1.63	-	38.40	9.24	35.00
AV	15.71732G	41.57	54.00	-12.43	28.93	3	Horizontal	174	1.63	-	38.40	9.24	35.00



802.11ax HEW20-BF\_Nss1,(MCS0)\_2TX

07/12/2020

5745MHz\_TX

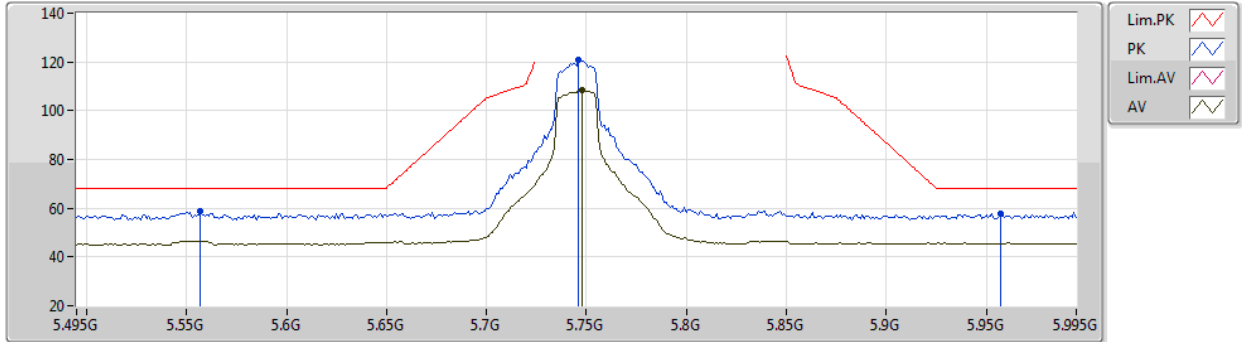

EUT\_Z\_2TX  
Setting 27  
02-B-C-5-10

Type	Freq (Hz)	Level (dBuV/m)	Limit (dBuV/m)	Margin (dB)	Raw (dBuV)	Dist (m)	Condition	Azimuth (°)	Height (m)	Comment	AF (dB)	CL (dB)	PA (dB)
PK	5.557G	58.65	68.20	-9.55	51.06	3	Vertical	353	1.88	-	33.90	5.16	31.47
PK	5.746G	120.76	Inf	-Inf	113.37	3	Vertical	353	1.88	-	33.80	5.05	31.46
AV	5.748G	108.57	Inf	-Inf	101.18	3	Vertical	353	1.88	-	33.80	5.05	31.46
PK	5.957G	57.73	68.20	-10.47	49.55	3	Vertical	353	1.88	-	34.16	5.47	31.45

802.11ax HEW20-BF\_Nss1,(MCS0)\_2TX

07/12/2020

5745MHz\_TX

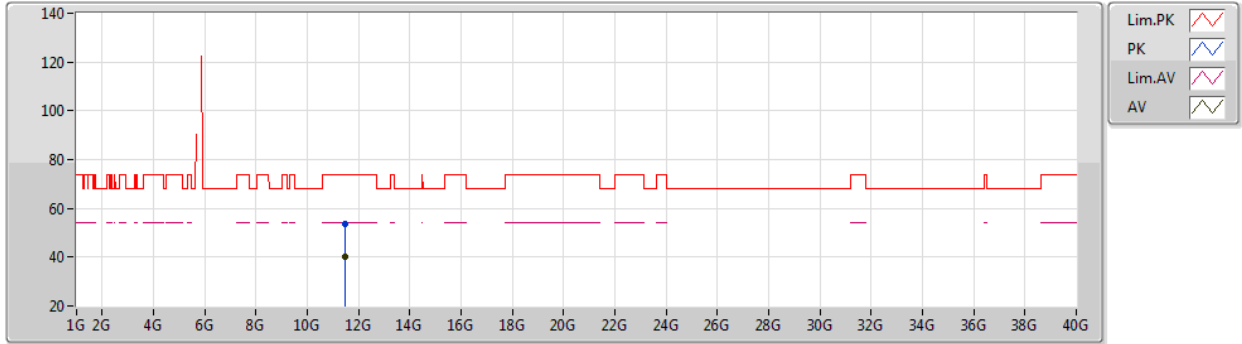

EUT\_Z\_2TX  
Setting 27  
01-A-B-2

Type	Freq (Hz)	Level (dBuV/m)	Limit (dBuV/m)	Margin (dB)	Raw (dBuV)	Dist (m)	Condition	Azimuth (°)	Height (m)	Comment	AF (dB)	CL (dB)	PA (dB)
PK	11.48688G	53.39	74.00	-20.61	42.00	3	Vertical	195	1.80	-	38.40	7.82	34.83
AV	11.48514G	40.06	54.00	-13.94	28.67	3	Vertical	195	1.80	-	38.40	7.82	34.83

802.11ax HEW20-BF\_Nss1,(MCS0)\_2TX

07/12/2020

5745MHz\_TX

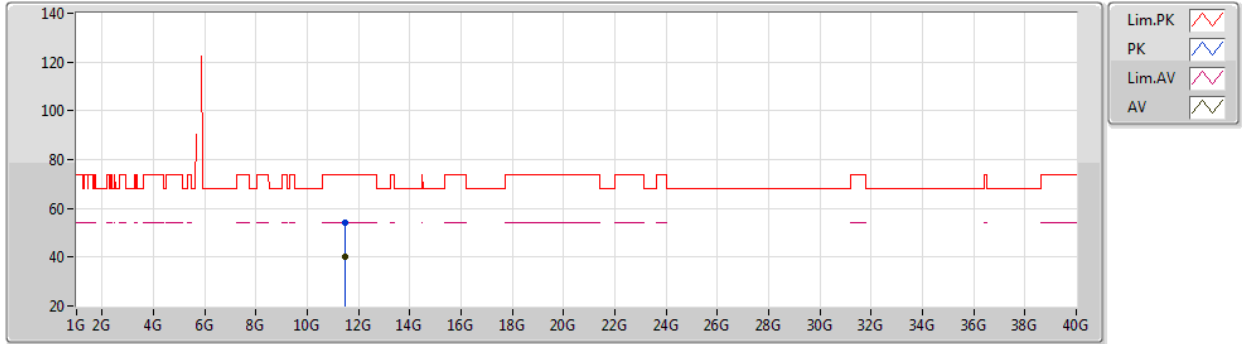

EUT\_Z\_2TX  
Setting 27  
01-A-B-2

Type	Freq (Hz)	Level (dBuV/m)	Limit (dBuV/m)	Margin (dB)	Raw (dBuV)	Dist (m)	Condition	Azimuth (°)	Height (m)	Comment	AF (dB)	CL (dB)	PA (dB)
PK	11.49094G	54.30	74.00	-19.70	42.91	3	Horizontal	155	2.03	-	38.40	7.82	34.83
AV	11.48848G	39.98	54.00	-14.02	28.59	3	Horizontal	155	2.03	-	38.40	7.82	34.83

802.11ax HEW20-BF\_Nss1,(MCS0)\_2TX

07/12/2020

5785MHz\_TX

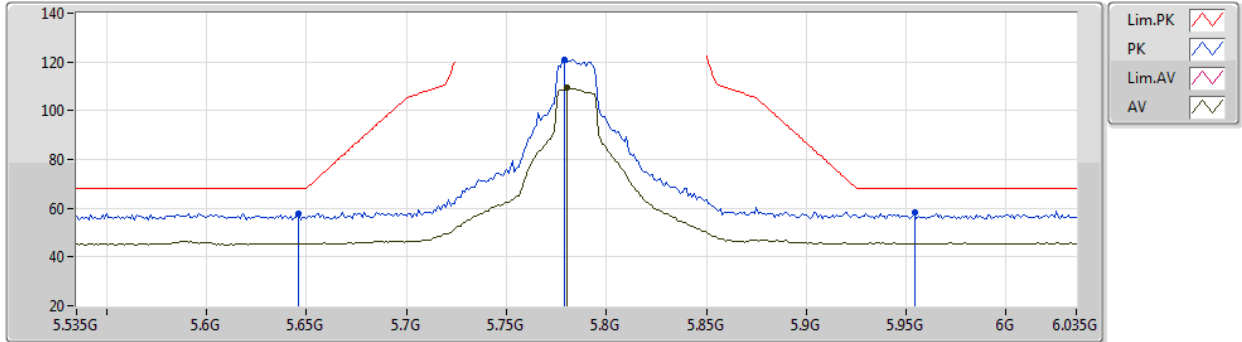

EUT\_Z\_2TX  
Setting 27  
02-B-C-5-10

Type	Freq (Hz)	Level (dBuV/m)	Limit (dBuV/m)	Margin (dB)	Raw (dBuV)	Dist (m)	Condition	Azimuth (°)	Height (m)	Comment	AF (dB)	CL (dB)	PA (dB)
PK	5.646G	57.96	68.20	-10.24	50.43	3	Vertical	222	1.80	-	33.85	5.15	31.47
PK	5.779G	120.72	Inf	-Inf	113.36	3	Vertical	222	1.80	-	33.80	5.02	31.46
AV	5.78G	109.23	Inf	-Inf	101.87	3	Vertical	222	1.80	-	33.80	5.02	31.46
PK	5.954G	58.05	68.20	-10.15	49.89	3	Vertical	222	1.80	-	34.15	5.46	31.45

802.11ax HEW20-BF\_Nss1,(MCS0)\_2TX

07/12/2020

5785MHz\_TX

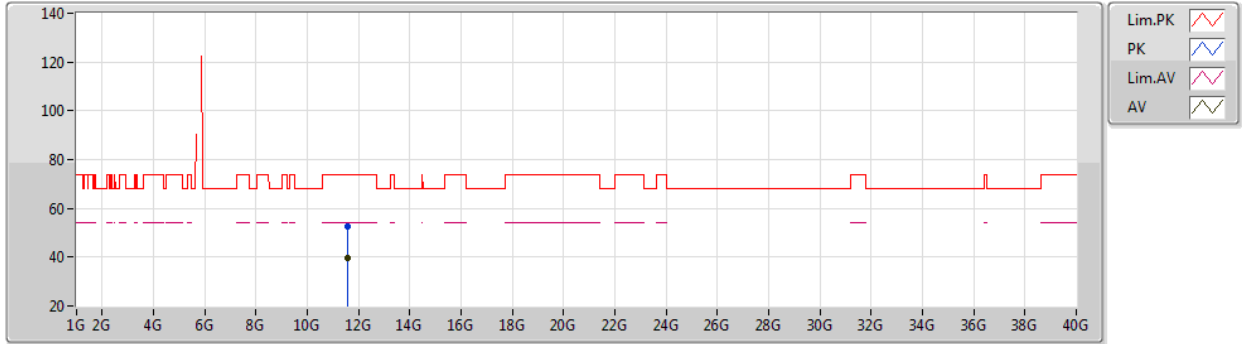

EUT\_Z\_2TX  
Setting 27  
01-A-B-2

Type	Freq (Hz)	Level (dBuV/m)	Limit (dBuV/m)	Margin (dB)	Raw (dBuV)	Dist (m)	Condition	Azimuth (°)	Height (m)	Comment	AF (dB)	CL (dB)	PA (dB)
PK	11.57056G	52.79	74.00	-21.21	41.40	3	Vertical	262	2.38	-	38.40	7.85	34.86
AV	11.57302G	39.73	54.00	-14.27	28.34	3	Vertical	262	2.38	-	38.40	7.85	34.86

802.11ax HEW20-BF\_Nss1,(MCS0)\_2TX

07/12/2020

5785MHz\_TX

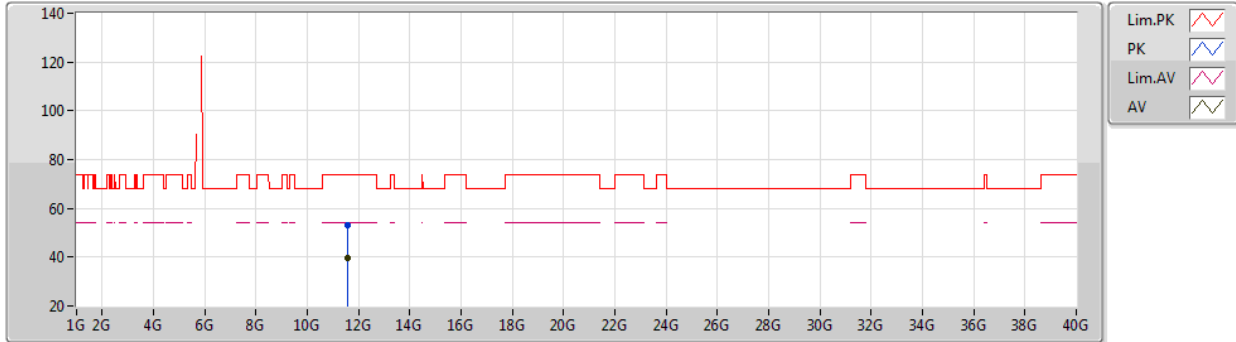

EUT\_Z\_2TX  
Setting 27  
01-A-B-2

Type	Freq (Hz)	Level (dBuV/m)	Limit (dBuV/m)	Margin (dB)	Raw (dBuV)	Dist (m)	Condition	Azimuth (°)	Height (m)	Comment	AF (dB)	CL (dB)	PA (dB)
PK	11.56714G	53.19	74.00	-20.81	41.79	3	Horizontal	247	1.68	-	38.40	7.85	34.85
AV	11.56996G	39.63	54.00	-14.37	28.24	3	Horizontal	247	1.68	-	38.40	7.85	34.86

802.11ax HEW20-BF\_Nss1,(MCS0)\_2TX

07/12/2020

5825MHz\_TX

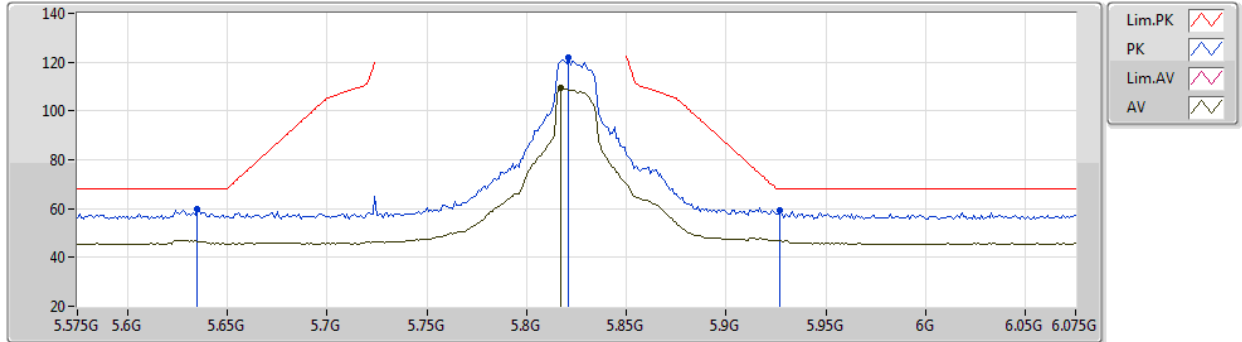

EUT\_Z\_2TX  
Setting 27  
01-A-G-2-10

Type	Freq (Hz)	Level (dBuV/m)	Limit (dBuV/m)	Margin (dB)	Raw (dBuV)	Dist (m)	Condition	Azimuth (°)	Height (m)	Comment	AF (dB)	CL (dB)	PA (dB)
PK	5.635G	60.08	68.20	-8.12	52.52	3	Vertical	283	2.23	-	33.86	5.17	31.47
PK	5.821G	122.00	Inf	-Inf	114.54	3	Vertical	283	2.23	-	33.86	5.06	31.46
AV	5.817G	109.28	Inf	-Inf	101.84	3	Vertical	283	2.23	-	33.85	5.05	31.46
PK	5.927G	59.25	68.20	-8.95	51.19	3	Vertical	283	2.23	-	34.13	5.38	31.45



802.11ax HEW20-BF\_Nss1,(MCS0)\_2TX

07/12/2020

5825MHz\_TX

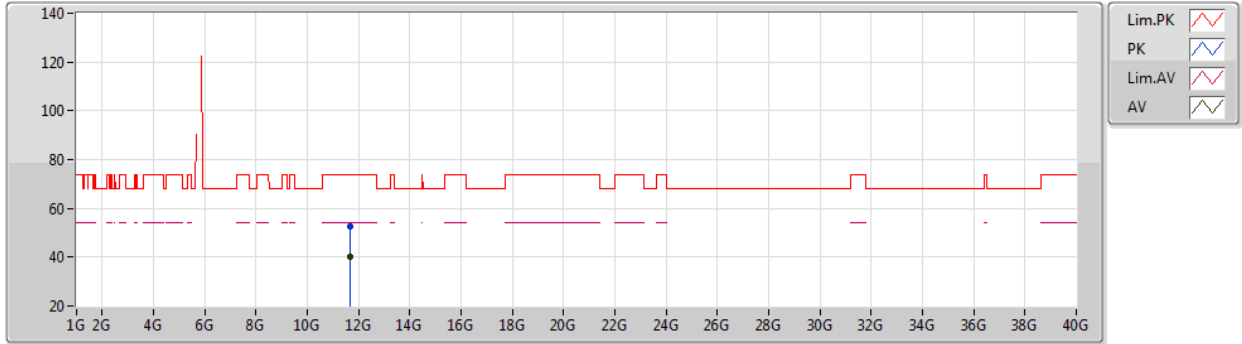

EUT\_Z\_2TX  
Setting 27  
01-A-B-2

Type	Freq (Hz)	Level (dBuV/m)	Limit (dBuV/m)	Margin (dB)	Raw (dBuV)	Dist (m)	Condition	Azimuth (°)	Height (m)	Comment	AF (dB)	CL (dB)	PA (dB)
PK	11.65204G	52.65	74.00	-21.35	41.20	3	Vertical	106	1.24	-	38.45	7.88	34.88
AV	11.64976G	39.96	54.00	-14.04	28.51	3	Vertical	106	1.24	-	38.45	7.88	34.88

802.11ax HEW20-BF\_Nss1,(MCS0)\_2TX

07/12/2020

5825MHz\_TX

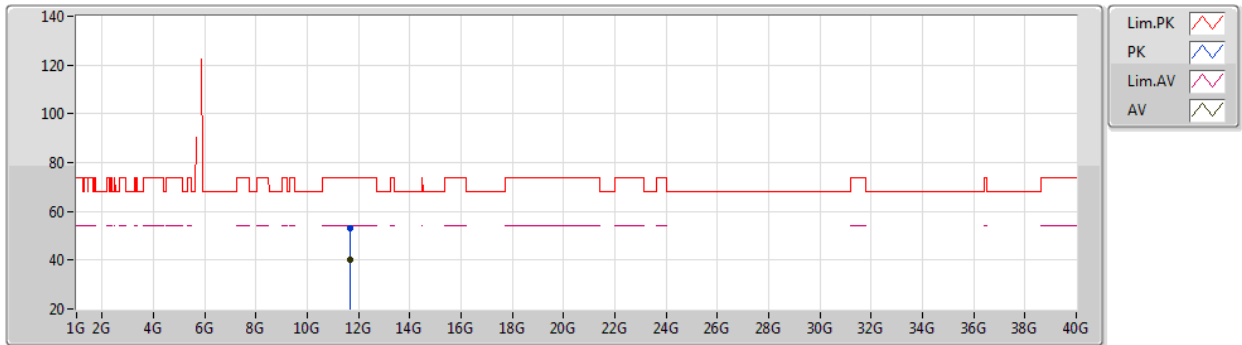

EUT\_Z\_2TX  
Setting 27  
01-A-B-2

Type	Freq (Hz)	Level (dBuV/m)	Limit (dBuV/m)	Margin (dB)	Raw (dBuV)	Dist (m)	Condition	Azimuth (°)	Height (m)	Comment	AF (dB)	CL (dB)	PA (dB)
PK	11.64762G	53.17	74.00	-20.83	41.72	3	Horizontal	64	1.76	-	38.45	7.88	34.88
AV	11.64792G	40.00	54.00	-14.00	28.55	3	Horizontal	64	1.76	-	38.45	7.88	34.88

802.11ax HEW40-BF\_Nss1,(MCS0)\_2TX

07/12/2020

5190MHz\_TX

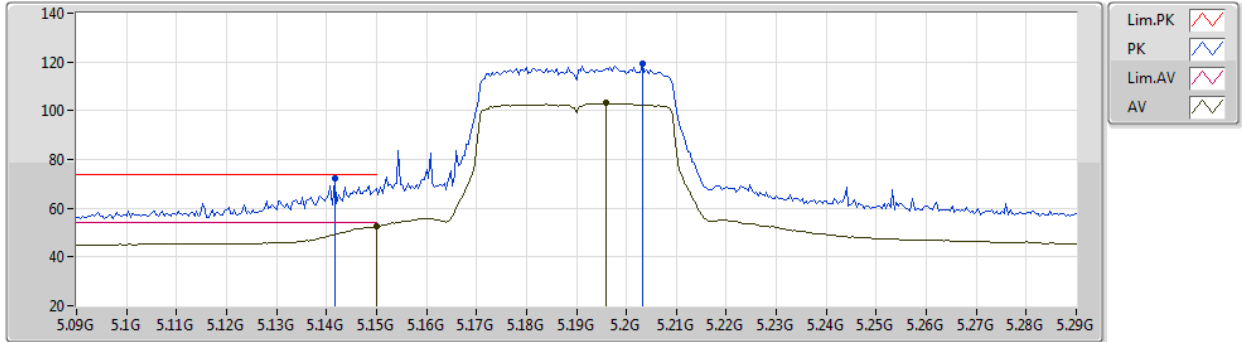

EUT\_Z\_2TX  
Setting 25  
01-A-C-5-10

Type	Freq (Hz)	Level (dBuV/m)	Limit (dBuV/m)	Margin (dB)	Raw (dBuV)	Dist (m)	Condition	Azimuth (°)	Height (m)	Comment	AF (dB)	CL (dB)	PA (dB)
PK	5.1416G	72.43	74.00	-1.57	69.29	3	Vertical	207	1.80	-	32.60	5.17	34.63
AV	5.15G	52.71	54.00	-1.29	49.57	3	Vertical	207	1.80	-	32.60	5.17	34.63
PK	5.2032G	119.44	Inf	-Inf	116.18	3	Vertical	207	1.80	-	32.71	5.20	34.65
AV	5.196G	103.04	Inf	-Inf	99.80	3	Vertical	207	1.80	-	32.69	5.20	34.65

802.11ax HEW40-BF\_Nss1,(MCS0)\_2TX

07/12/2020

5190MHz\_TX

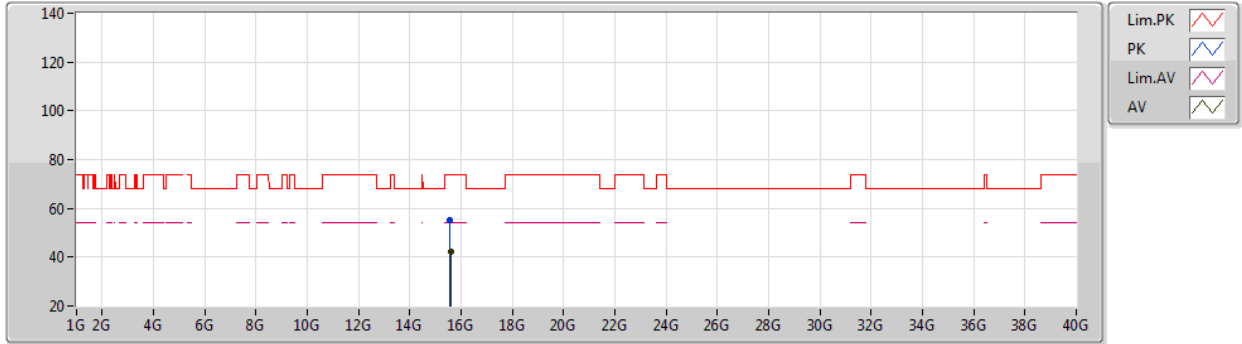

EUT\_Z\_2TX  
Setting 25  
01-A-B-2

Type	Freq (Hz)	Level (dBuV/m)	Limit (dBuV/m)	Margin (dB)	Raw (dBuV)	Dist (m)	Condition	Azimuth (°)	Height (m)	Comment	AF (dB)	CL (dB)	PA (dB)
PK	15.56796G	55.36	74.00	-18.64	42.76	3	Vertical	197	1.80	-	38.24	9.21	34.85
AV	15.58398G	42.01	54.00	-11.99	29.39	3	Vertical	197	1.80	-	38.27	9.22	34.87

802.11ax HEW40-BF\_Nss1,(MCS0)\_2TX

07/12/2020

5190MHz\_TX

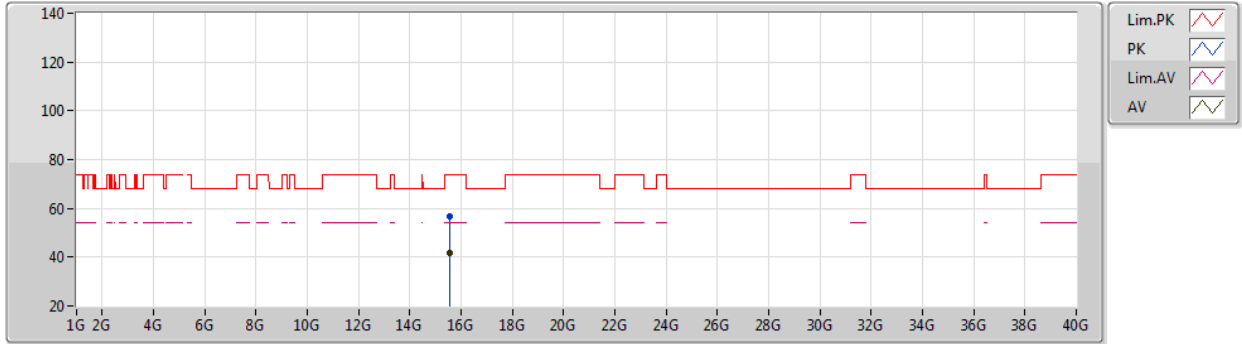

EUT\_Z\_2TX  
Setting 25  
01-A-B-2

Type	Freq (Hz)	Level (dBuV/m)	Limit (dBuV/m)	Margin (dB)	Raw (dBuV)	Dist (m)	Condition	Azimuth (°)	Height (m)	Comment	AF (dB)	CL (dB)	PA (dB)
PK	15.56796G	56.81	74.00	-17.19	44.21	3	Horizontal	83	1.80	-	38.24	9.21	34.85
AV	15.57544G	41.84	54.00	-12.16	29.23	3	Horizontal	83	1.80	-	38.25	9.22	34.86

802.11ax HEW40-BF\_Nss1,(MCS0)\_2TX

07/12/2020

5230MHz\_TX

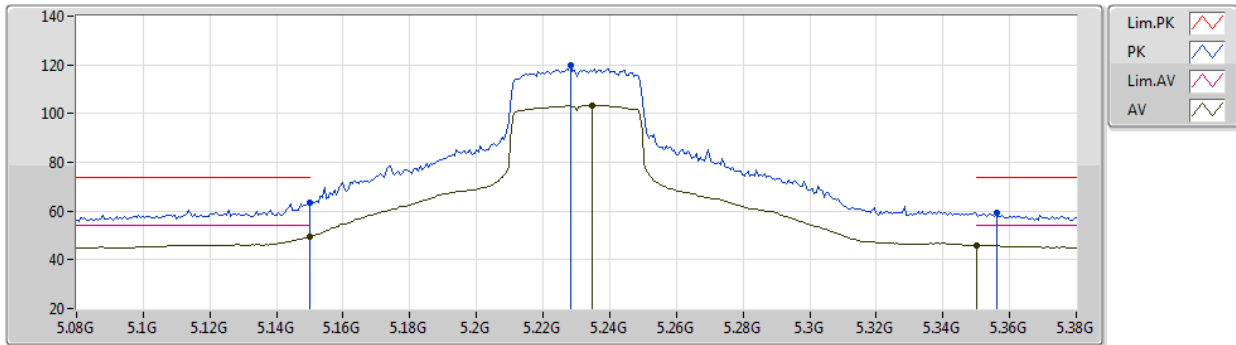

EUT Z\_2TX  
Setting 27  
02-B-C-5-10

Type	Freq (Hz)	Level (dBuV/m)	Limit (dBuV/m)	Margin (dB)	Raw (dBuV)	Dist (m)	Condition	Azimuth (°)	Height (m)	Comment	AF (dB)	CL (dB)	PA (dB)
PK	5.15G	63.40	74.00	-10.60	56.68	3	Vertical	357	2.04	-	33.45	5.00	31.73
AV	5.15G	49.48	54.00	-4.52	42.76	3	Vertical	357	2.04	-	33.45	5.00	31.73
PK	5.2282G	119.62	Inf	-Inf	112.64	3	Vertical	357	2.04	-	33.56	5.09	31.67
AV	5.2348G	103.37	Inf	-Inf	96.39	3	Vertical	357	2.04	-	33.57	5.08	31.67
PK	5.356G	59.26	74.00	-14.74	52.06	3	Vertical	357	2.04	-	33.76	5.02	31.58
AV	5.35G	45.86	54.00	-8.14	38.67	3	Vertical	357	2.04	-	33.75	5.03	31.59

802.11ax HEW40-BF\_Nss1,(MCS0)\_2TX

07/12/2020

5230MHz\_TX

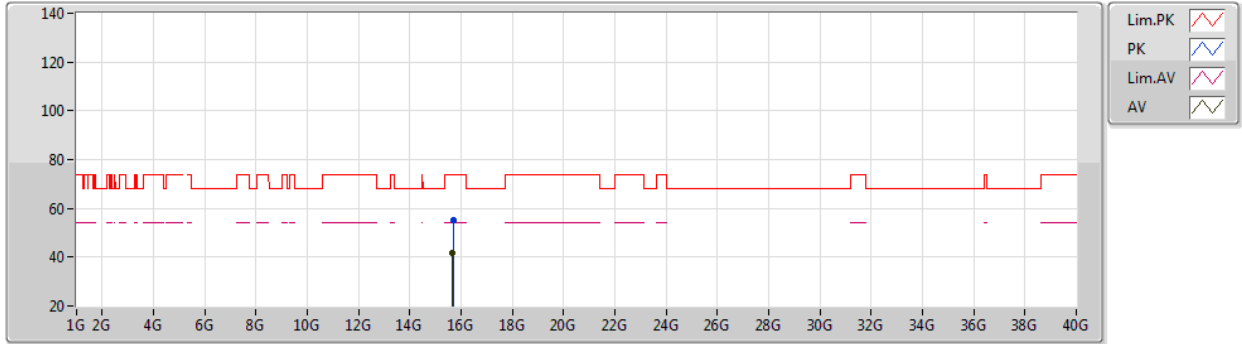

EUT\_Z\_2TX  
Setting 27  
01-A-B-2

Type	Freq (Hz)	Level (dBuV/m)	Limit (dBuV/m)	Margin (dB)	Raw (dBuV)	Dist (m)	Condition	Azimuth (°)	Height (m)	Comment	AF (dB)	CL (dB)	PA (dB)
PK	15.69744G	55.12	74.00	-18.88	42.46	3	Vertical	297	1.80	-	38.40	9.24	34.98
AV	15.67716G	41.54	54.00	-12.46	28.88	3	Vertical	297	1.80	-	38.38	9.24	34.96

802.11ax HEW40-BF\_Nss1,(MCS0)\_2TX

07/12/2020

5230MHz\_TX

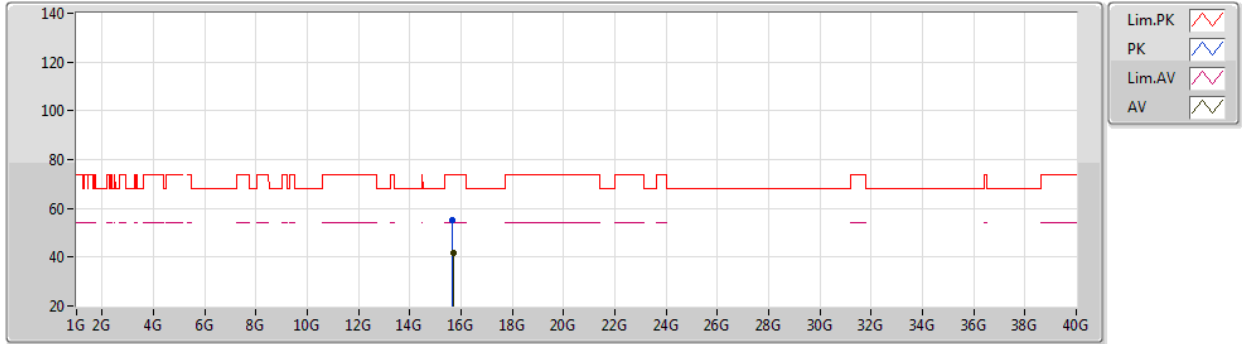

EUT\_Z\_2TX  
Setting 27  
01-A-B-2

Type	Freq (Hz)	Level (dBuV/m)	Limit (dBuV/m)	Margin (dB)	Raw (dBuV)	Dist (m)	Condition	Azimuth (°)	Height (m)	Comment	AF (dB)	CL (dB)	PA (dB)
PK	15.67776G	55.43	74.00	-18.57	42.77	3	Horizontal	114	1.80	-	38.38	9.24	34.96
AV	15.68262G	41.63	54.00	-12.37	28.98	3	Horizontal	114	1.80	-	38.38	9.24	34.97



802.11ax HEW40-BF\_Nss1,(MCS0)\_2TX

07/12/2020

5755MHz\_TX

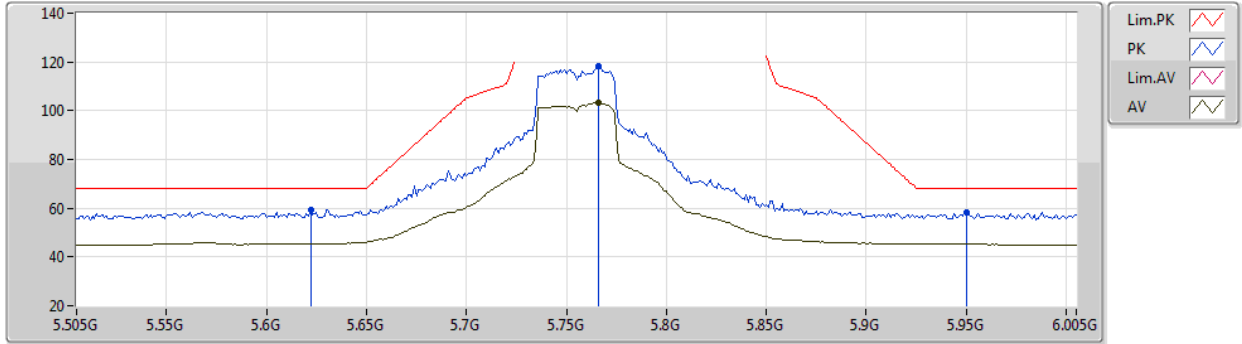

EUT Z\_2TX  
Setting 27  
02-B-C-5-10

Type	Freq (Hz)	Level (dBuV/m)	Limit (dBuV/m)	Margin (dB)	Raw (dBuV)	Dist (m)	Condition	Azimuth (°)	Height (m)	Comment	AF (dB)	CL (dB)	PA (dB)
PK	5.622G	59.56	68.20	-8.64	51.97	3	Vertical	313	1.88	-	33.88	5.18	31.47
PK	5.766G	118.37	Inf	-Inf	111.00	3	Vertical	313	1.88	-	33.80	5.03	31.46
AV	5.766G	103.45	Inf	-Inf	96.08	3	Vertical	313	1.88	-	33.80	5.03	31.46
PK	5.95G	58.07	68.20	-10.13	49.92	3	Vertical	313	1.88	-	34.15	5.45	31.45

802.11ax HEW40-BF\_Nss1,(MCS0)\_2TX

07/12/2020

5755MHz\_TX

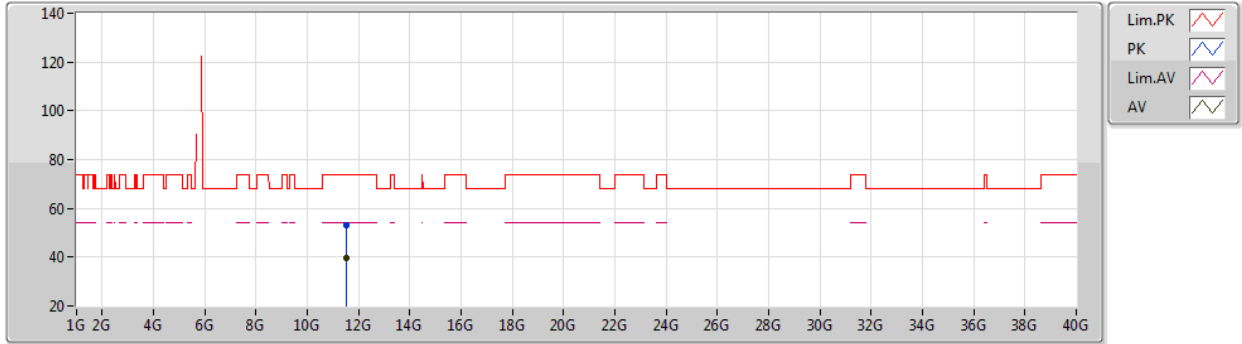

EUT\_Z\_2TX  
Setting 27  
01-A-B-2

Type	Freq (Hz)	Level (dBuV/m)	Limit (dBuV/m)	Margin (dB)	Raw (dBuV)	Dist (m)	Condition	Azimuth (°)	Height (m)	Comment	AF (dB)	CL (dB)	PA (dB)
PK	11.51378G	53.10	74.00	-20.90	41.70	3	Vertical	351	2.93	-	38.40	7.83	34.83
AV	11.50688G	39.41	54.00	-14.59	28.01	3	Vertical	351	2.93	-	38.40	7.83	34.83

802.11ax HEW40-BF\_Nss1,(MCS0)\_2TX

07/12/2020

5755MHz\_TX

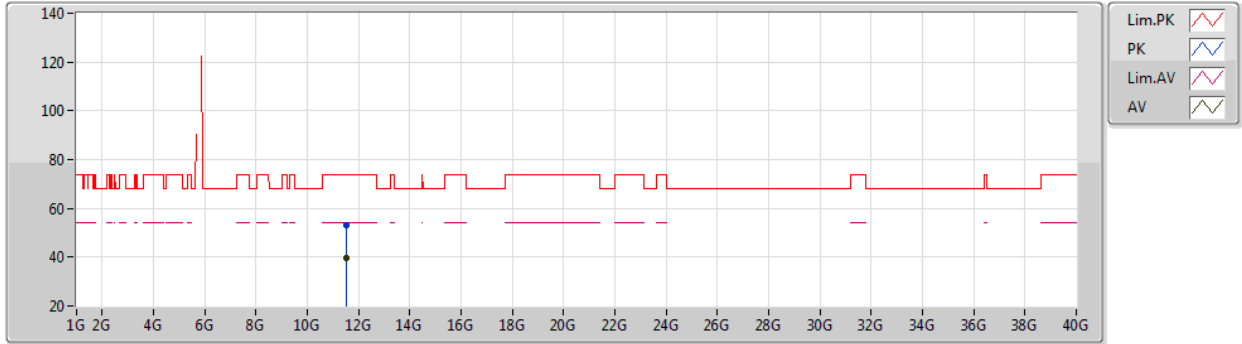

EUT\_Z\_2TX  
Setting 27  
01-A-B-2

Type	Freq (Hz)	Level (dBuV/m)	Limit (dBuV/m)	Margin (dB)	Raw (dBuV)	Dist (m)	Condition	Azimuth (°)	Height (m)	Comment	AF (dB)	CL (dB)	PA (dB)
PK	11.51366G	52.92	74.00	-21.08	41.52	3	Horizontal	276	2.71	-	38.40	7.83	34.83
AV	11.51116G	39.43	54.00	-14.57	28.03	3	Horizontal	276	2.71	-	38.40	7.83	34.83

802.11ax HEW40-BF\_Nss1,(MCS0)\_2TX

07/12/2020

5795MHz\_TX

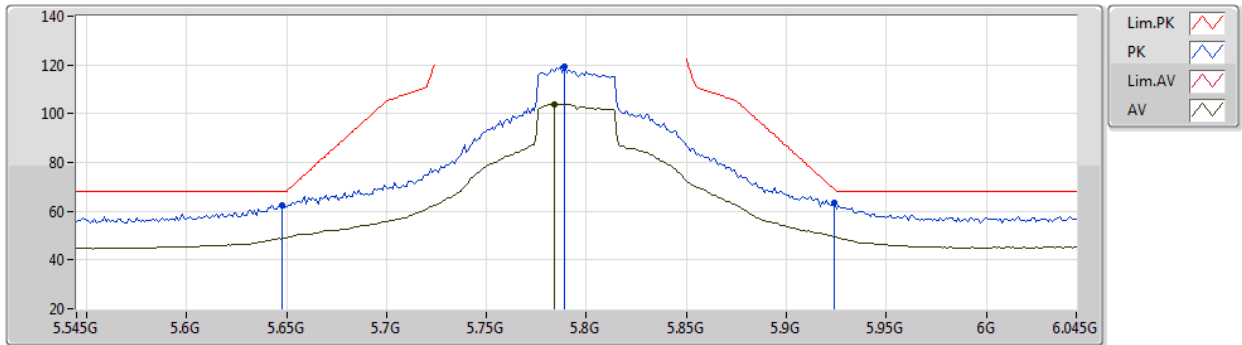

EUT\_Z\_2TX  
Setting 27  
02-B-C-5-10

Type	Freq (Hz)	Level (dBuV/m)	Limit (dBuV/m)	Margin (dB)	Raw (dBuV)	Dist (m)	Condition	Azimuth (°)	Height (m)	Comment	AF (dB)	CL (dB)	PA (dB)
PK	5.648G	62.47	68.20	-5.73	54.94	3	Vertical	294	1.87	-	33.85	5.15	31.47
PK	5.789G	119.30	Inf	-Inf	111.95	3	Vertical	294	1.87	-	33.80	5.01	31.46
AV	5.784G	104.00	Inf	-Inf	96.64	3	Vertical	294	1.87	-	33.80	5.02	31.46
PK	5.924G	63.29	68.94	-5.65	55.25	3	Vertical	294	1.87	-	34.12	5.37	31.45

802.11ax HEW40-BF\_Nss1,(MCS0)\_2TX

07/12/2020

5795MHz\_TX

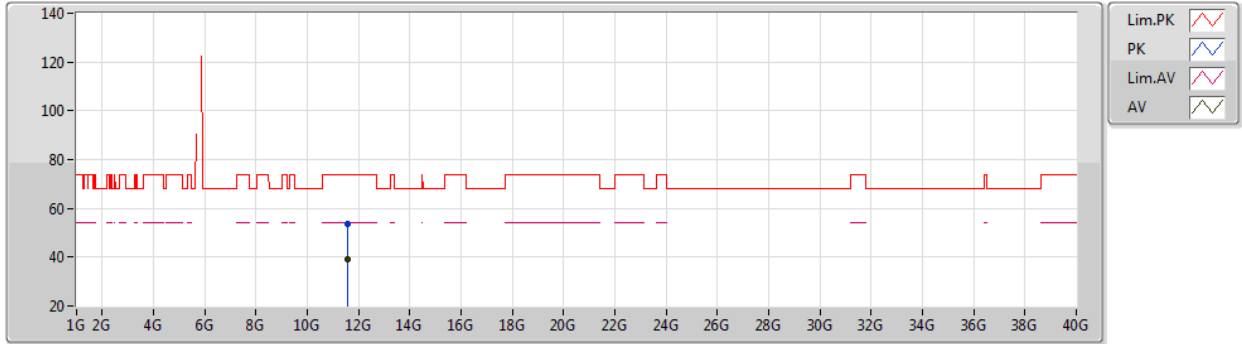

EUT\_Z\_2TX  
Setting 27  
01-A-B-2

Type	Freq (Hz)	Level (dBuV/m)	Limit (dBuV/m)	Margin (dB)	Raw (dBuV)	Dist (m)	Condition	Azimuth (°)	Height (m)	Comment	AF (dB)	CL (dB)	PA (dB)
PK	11.59236G	53.39	74.00	-20.61	41.99	3	Vertical	234	2.55	-	38.40	7.86	34.86
AV	11.58886G	39.29	54.00	-14.71	27.89	3	Vertical	234	2.55	-	38.40	7.86	34.86

802.11ax HEW40-BF\_Nss1,(MCS0)\_2TX

07/12/2020

5795MHz\_TX

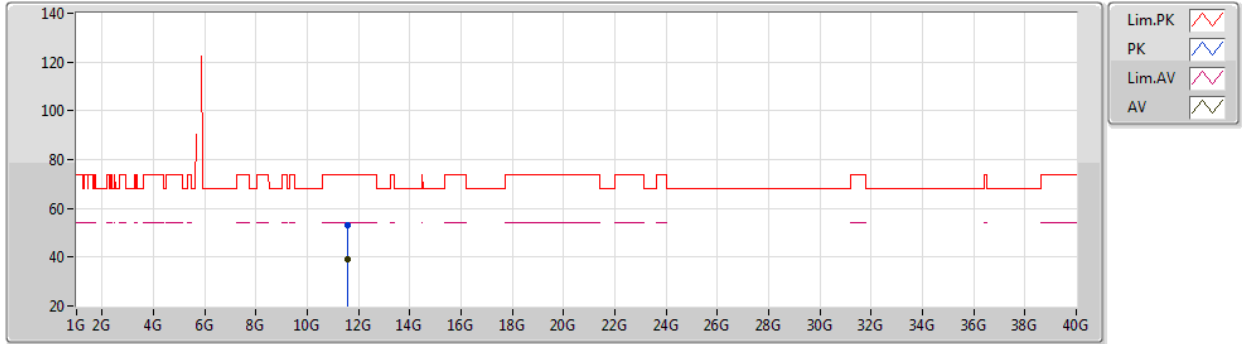

EUT\_Z\_2TX  
Setting 27  
01-A-B-2

Type	Freq (Hz)	Level (dBuV/m)	Limit (dBuV/m)	Margin (dB)	Raw (dBuV)	Dist (m)	Condition	Azimuth (°)	Height (m)	Comment	AF (dB)	CL (dB)	PA (dB)
PK	11.5914G	52.89	74.00	-21.11	41.49	3	Horizontal	247	2.90	-	38.40	7.86	34.86
AV	11.58902G	39.32	54.00	-14.68	27.92	3	Horizontal	247	2.90	-	38.40	7.86	34.86

802.11ax HEW80-BF\_Nss1,(MCS0)\_2TX

07/12/2020

5210MHz\_TX

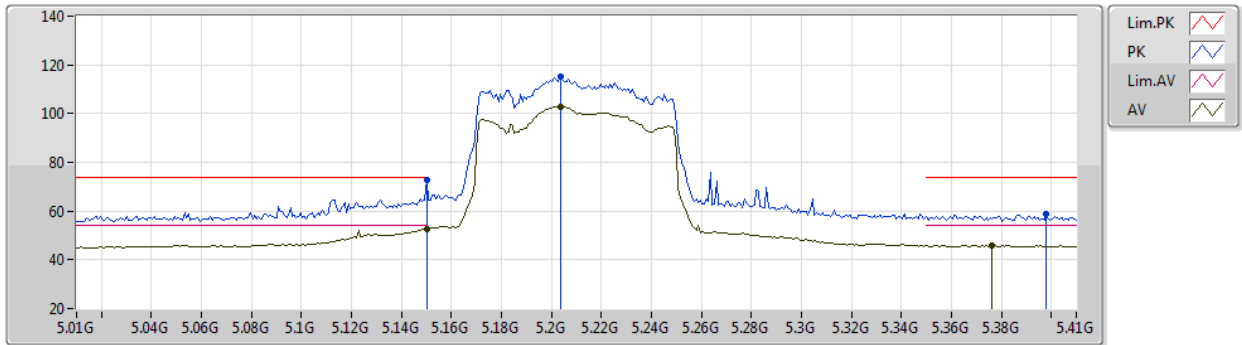

EUT\_Z\_2TX  
Setting 24  
01-A-C-5-10

Type	Freq (Hz)	Level (dBuV/m)	Limit (dBuV/m)	Margin (dB)	Raw (dBuV)	Dist (m)	Condition	Azimuth (°)	Height (m)	Comment	AF (dB)	CL (dB)	PA (dB)
PK	5.15G	72.68	74.00	-1.32	69.54	3	Vertical	339	1.80	-	32.60	5.17	34.63
AV	5.15G	52.68	54.00	-1.32	49.54	3	Vertical	339	1.80	-	32.60	5.17	34.63
PK	5.2036G	115.00	Inf	-Inf	111.74	3	Vertical	339	1.80	-	32.71	5.20	34.65
AV	5.2036G	102.96	Inf	-Inf	99.70	3	Vertical	339	1.80	-	32.71	5.20	34.65
PK	5.398G	58.91	74.00	-15.09	55.04	3	Vertical	339	1.80	-	33.19	5.40	34.72
AV	5.3764G	46.09	54.00	-7.91	42.37	3	Vertical	339	1.80	-	33.06	5.38	34.72

802.11ax HEW80-BF\_Nss1,(MCS0)\_2TX

07/12/2020

5210MHz\_TX

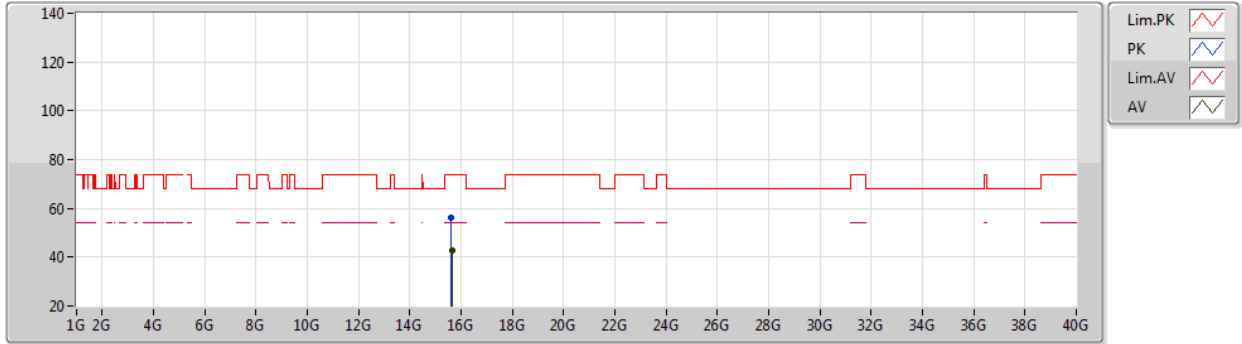

EUT\_Z\_2TX  
Setting 24  
01-A-B-2

Type	Freq (Hz)	Level (dBuV/m)	Limit (dBuV/m)	Margin (dB)	Raw (dBuV)	Dist (m)	Condition	Azimuth (°)	Height (m)	Comment	AF (dB)	CL (dB)	PA (dB)
PK	15.61554G	56.17	74.00	-17.83	43.53	3	Vertical	237	1.80	-	38.32	9.22	34.90
AV	15.63282G	42.76	54.00	-11.24	30.12	3	Vertical	237	1.80	-	38.33	9.23	34.92



802.11ax HEW80-BF\_Nss1,(MCS0)\_2TX

07/12/2020

5210MHz\_TX

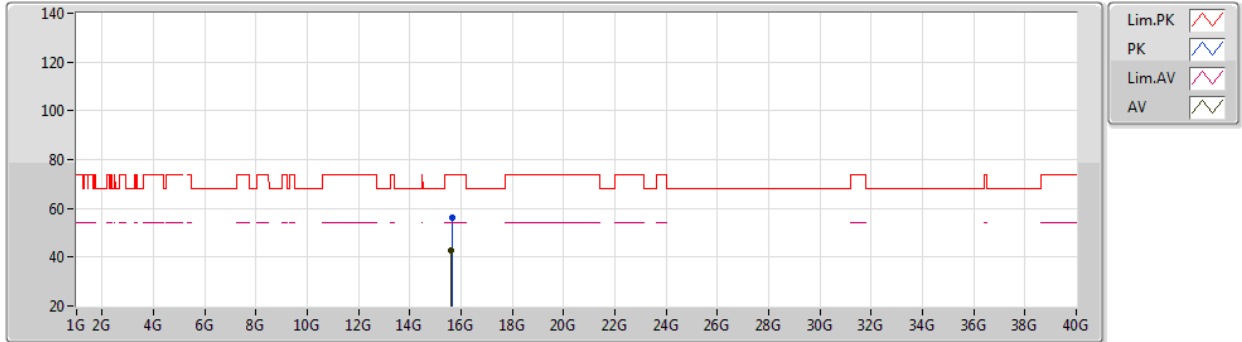

EUT\_Z\_2TX  
Setting 24  
01-A-B-2

Type	Freq (Hz)	Level (dBuV/m)	Limit (dBuV/m)	Margin (dB)	Raw (dBuV)	Dist (m)	Condition	Azimuth (°)	Height (m)	Comment	AF (dB)	CL (dB)	PA (dB)
PK	15.63258G	56.13	74.00	-17.87	43.49	3	Horizontal	360	1.80	-	38.33	9.23	34.92
AV	15.615G	42.98	54.00	-11.02	30.35	3	Horizontal	360	1.80	-	38.31	9.22	34.90

802.11ax HEW80-BF\_Nss1,(MCS0)\_2TX

07/12/2020

5775MHz\_TX

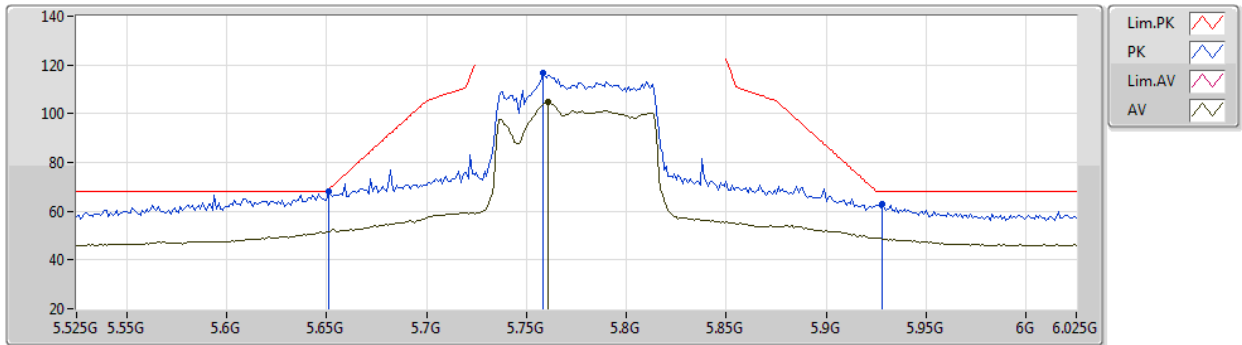

EUT Z\_2TX  
Setting 25  
01-A-C-5-10

Type	Freq (Hz)	Level (dBuV/m)	Limit (dBuV/m)	Margin (dB)	Raw (dBuV)	Dist (m)	Condition	Azimuth (°)	Height (m)	Comment	AF (dB)	CL (dB)	PA (dB)
PK	5.651G	67.86	68.94	-1.08	63.23	3	Vertical	269	1.93	-	33.90	5.43	34.70
PK	5.758G	116.78	Inf	-Inf	111.83	3	Vertical	269	1.93	-	34.13	5.48	34.66
AV	5.761G	104.77	Inf	-Inf	99.81	3	Vertical	269	1.93	-	34.14	5.48	34.66
PK	5.928G	62.72	68.20	-5.48	56.91	3	Vertical	269	1.93	-	34.91	5.50	34.60

802.11ax HEW80-BF\_Nss1,(MCS0)\_2TX

07/12/2020

5775MHz\_TX

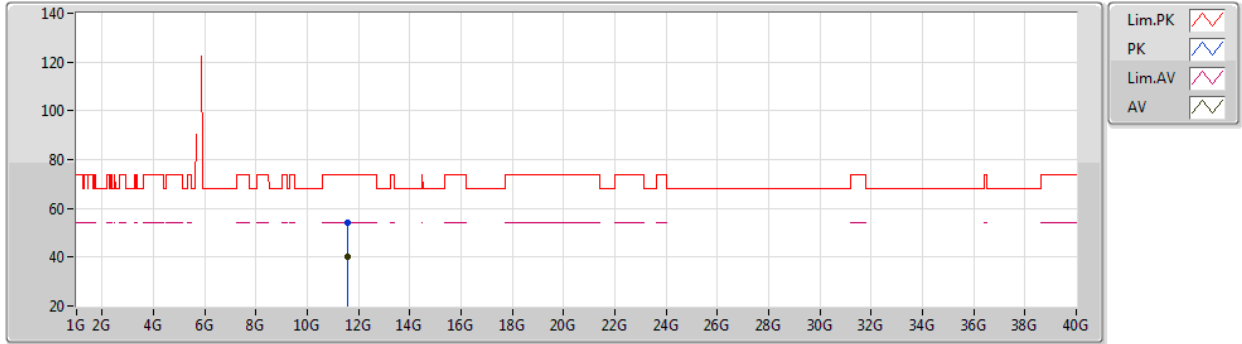

EUT Z\_2TX  
Setting 25  
01-A-B-2

Type	Freq (Hz)	Level (dBuV/m)	Limit (dBuV/m)	Margin (dB)	Raw (dBuV)	Dist (m)	Condition	Azimuth (°)	Height (m)	Comment	AF (dB)	CL (dB)	PA (dB)
PK	11.55028G	54.07	74.00	-19.93	42.68	3	Vertical	59	1.80	-	38.40	7.84	34.85
AV	11.55396G	40.32	54.00	-13.68	28.93	3	Vertical	59	1.80	-	38.40	7.84	34.85

802.11ax HEW80-BF\_Nss1,(MCS0)\_2TX

07/12/2020

5775MHz\_TX

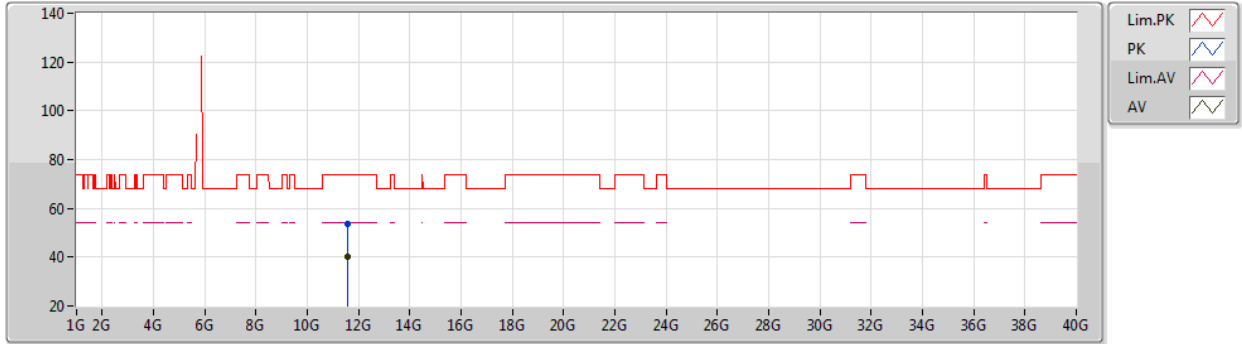

EUT\_Z\_2TX  
Setting 25  
01-A-B-2

Type	Freq (Hz)	Level (dBuV/m)	Limit (dBuV/m)	Margin (dB)	Raw (dBuV)	Dist (m)	Condition	Azimuth (°)	Height (m)	Comment	AF (dB)	CL (dB)	PA (dB)
PK	11.5536G	53.58	74.00	-20.42	42.19	3	Horizontal	181	1.80	-	38.40	7.84	34.85
AV	11.55096G	40.14	54.00	-13.86	28.75	3	Horizontal	181	1.80	-	38.40	7.84	34.85



**Summary**

Mode	Result	Type	Freq (Hz)	Level (dBuV/m)	Limit (dBuV/m)	Margin (dB)	Condition
Mode 1	Pass	AV	1.12586G	28.54	54.00	-25.46	Vertical

