

FCC Test Report (WLAN)

Report No.: RFBCKS-WTW-P20110426

FCC ID: K7S-03685

Test Model: MX8500

Series Model: MX85EC, MX85WH, MX85MS

Received Date: Nov. 12, 2020

Test Date: Nov. 12 to Dec. 12, 2020

Issued Date: Dec. 15, 2020

Applicant: Belkin International, Inc.

Address: 12045 East Waterfront Drive, Playa Vista, CA 90094

Issued By: Bureau Veritas Consumer Products Services (H.K.) Ltd., Taoyuan Branch
Lin Kou Laboratories

Lab Address: No. 47-2, 14th Ling, Chia Pau Vil., Lin Kou Dist., New Taipei City, Taiwan

**FCC Registration /
Designation Number:** 198487 / TW2021



This report is for your exclusive use. Any copying or replication of this report to or for any other person or entity, or use of our name or trademark, is permitted only with our prior written permission. This report sets forth our findings solely with respect to the test samples identified herein. The results set forth in this report are not indicative or representative of the quality or characteristics of the lot from which a test sample was taken or any similar or identical product unless specifically and expressly noted. Our report includes all of the tests requested by you and the results thereof based upon the information that you provided to us. You have 60 days from date of issuance of this report to notify us of any material error or omission caused by our negligence, provided, however, that such notice shall be in writing and shall specifically address the issue you wish to raise. A failure to raise such issue within the prescribed time shall constitute your unqualified acceptance of the completeness of this report, the tests conducted and the correctness of the report contents. Unless specific mention, the uncertainty of measurement has been explicitly taken into account to declare the compliance or non-compliance to the specification.

Table of Contents

| | |
|--|-----------|
| Release Control Record | 4 |
| 1 Certificate of Conformity | 5 |
| 2 Summary of Test Results | 6 |
| 2.1 Measurement Uncertainty..... | 6 |
| 2.2 Modification Record..... | 6 |
| 3 General Information | 7 |
| 3.1 General Description of EUT..... | 7 |
| 3.2 Description of Test Modes..... | 10 |
| 3.2.1 Test Mode Applicability and Tested Channel Detail..... | 11 |
| 3.3 Duty Cycle of Test Signal..... | 13 |
| 3.4 Description of Support Units..... | 14 |
| 3.4.1 Configuration of System under Test..... | 14 |
| 3.5 General Description of Applied Standards and References..... | 15 |
| 4 Test Types and Results | 16 |
| 4.1 Radiated Emission and Bandedge Measurement..... | 16 |
| 4.1.1 Limits of Radiated Emission and Bandedge Measurement..... | 16 |
| 4.1.2 Test Instruments..... | 17 |
| 4.1.3 Test Procedures..... | 18 |
| 4.1.4 Deviation from Test Standard..... | 18 |
| 4.1.5 Test Setup..... | 19 |
| 4.1.6 EUT Operating Conditions..... | 20 |
| 4.1.7 Test Results..... | 21 |
| 4.2 Conducted Emission Measurement..... | 41 |
| 4.2.1 Limits of Conducted Emission Measurement..... | 41 |
| 4.2.2 Test Instruments..... | 41 |
| 4.2.3 Test Procedures..... | 42 |
| 4.2.4 Deviation from Test Standard..... | 42 |
| 4.2.5 Test Setup..... | 42 |
| 4.2.6 EUT Operating Conditions..... | 42 |
| 4.2.7 Test Results..... | 43 |
| 4.3 Transmit Power Measurement..... | 45 |
| 4.3.1 Limits of Transmit Power Measurement..... | 45 |
| 4.3.2 Test Setup..... | 45 |
| 4.3.3 Test Instruments..... | 45 |
| 4.3.4 Test Procedure..... | 45 |
| 4.3.5 Deviation from Test Standard..... | 45 |
| 4.3.6 EUT Operating Conditions..... | 45 |
| 4.3.7 Test Result..... | 46 |
| 4.4 Occupied Bandwidth Measurement..... | 50 |
| 4.4.1 Test Setup..... | 50 |
| 4.4.2 Test Instruments..... | 50 |
| 4.4.3 Test Procedure..... | 50 |
| 4.4.4 Test Result..... | 51 |
| 4.5 Peak Power Spectral Density Measurement..... | 63 |
| 4.5.1 Limits of Peak Power Spectral Density Measurement..... | 63 |
| 4.5.2 Test Setup..... | 63 |
| 4.5.3 Test Instruments..... | 63 |
| 4.5.4 Test Procedures..... | 63 |
| 4.5.5 Deviation from Test Standard..... | 63 |
| 4.5.6 EUT Operating Conditions..... | 63 |
| 4.5.7 Test Results..... | 64 |
| 4.6 Frequency Stability..... | 68 |

| | | |
|----------|--|-----------|
| 4.6.1 | Limits of Frequency Stability Measurement | 68 |
| 4.6.2 | Test Setup..... | 68 |
| 4.6.3 | Test Instruments | 68 |
| 4.6.4 | Test Procedure | 68 |
| 4.6.5 | Deviation from Test Standard | 69 |
| 4.6.6 | EUT Operating Condition | 69 |
| 4.6.7 | Test Results | 69 |
| 4.7 | 6dB Bandwidth Measurement..... | 70 |
| 4.7.1 | Limits of 6dB Bandwidth Measurement..... | 70 |
| 4.7.2 | Test Setup..... | 70 |
| 4.7.3 | Test Instruments | 70 |
| 4.7.4 | Test Procedure | 70 |
| 4.7.5 | Deviation from Test Standard | 70 |
| 4.7.6 | EUT Operating Condition | 70 |
| 4.7.7 | Test Results | 71 |
| 5 | Pictures of Test Arrangements..... | 73 |
| | Annex A- Radiated Out of Band Emission (OOBE) Measurement (For U-NII-3 band)..... | 74 |
| | Annex B- Band Edge Measurement..... | 77 |
| | Appendix – Information of the Testing Laboratories | 82 |

Release Control Record

| Issue No. | Description | Date Issued |
|----------------------|------------------|---------------|
| RFBCKS-WTW-P20110426 | Original release | Dec. 15, 2020 |

1 Certificate of Conformity

Product: Linksys Tri-Band 802.11ax Wireless Router

Brand: Linksys

Test Model: MX8500

Series Model: MX85EC, MX85WH, MX85MS

Sample Status: Engineering sample

Applicant: Belkin International, Inc.

Test Date: Nov. 12 to Dec. 12, 2020

Standards: 47 CFR FCC Part 15, Subpart E (Section 15.407)
ANSI C63.10:2013

The above equipment has been tested by **Bureau Veritas Consumer Products Services (H.K.) Ltd., Taoyuan Branch**, and found compliance with the requirement of the above standards. The test record, data evaluation & Equipment Under Test (EUT) configurations represented herein are true and accurate accounts of the measurements of the sample's RF characteristics under the conditions specified in this report.

Prepared by : Annie Chang, **Date:** Dec. 15, 2020
Annie Chang / Senior Specialist

Approved by : Rex Lai, **Date:** Dec. 15, 2020
Rex Lai / Associate Technical Manager

2 Summary of Test Results

| 47 CFR FCC Part 15, Subpart E (Section 15.407) | | | |
|--|--|--------|--|
| FCC Clause | Test Item | Result | Remarks |
| 15.407(b)(6) | AC Power Conducted Emissions | Pass | Meet the requirement of limit. Minimum passing margin is -13.15dB at 0.39219MHz. |
| 15.407(b)(1/2/3/4(i/ii)/6) | Radiated Emissions & Band Edge Measurement | Pass | Meet the requirement of limit. Minimum passing margin is -1.19dB at 5150.00MHz. |
| 15.407(a)(1/2/3) | Max Average Transmit Power | Pass | Meet the requirement of limit. |
| --- | Occupied Bandwidth Measurement | - | Reference only. |
| 15.407(a)(1/2/3) | Peak Power Spectral Density | Pass | Meet the requirement of limit. |
| 15.407(e) | 6dB bandwidth | Pass | Meet the requirement of limit. (U-NII-3 Band only) |
| 15.407(g) | Frequency Stability | Pass | Meet the requirement of limit. |
| 15.203 | Antenna Requirement | Pass | Antenna connector is i-pex (MHF) not a standard connector. |

Note:

1. For U-NII-3 band compliance with rule part 15.407(b)(4)(i), the OOB test plots were recorded in Annex A. Test Procedures refer to report 4.1.3.
2. For U-NII-1 band compliance with rule 15.407(b) of the band-edge items, the test plots were recorded in Annex B. Test Procedures refer to report 4.1.3.
3. Determining compliance based on the results of the compliance measurement, not taking into account measurement instrumentation uncertainty.

2.1 Measurement Uncertainty

Where relevant, the following measurement uncertainty levels have been estimated for tests performed on the EUT as specified in CISPR 16-4-2:

| Measurement | Frequency | Expanded Uncertainty (k=2) (\pm) |
|------------------------------------|----------------|--------------------------------------|
| Conducted Emissions at mains ports | 150kHz ~ 30MHz | 3.00 dB |
| Conducted Emissions | 9kHz ~ 40GHz | 2.63 dB |
| Radiated Emissions up to 1 GHz | 9kHz ~ 30MHz | 2.61 dB |
| | 30MHz ~ 1GHz | 5.43 dB |
| Radiated Emissions above 1 GHz | Above 1GHz | 5.42 dB |

2.2 Modification Record

There were no modifications required for compliance.

3 General Information

3.1 General Description of EUT

| | |
|-----------------------|--|
| Product | Linksys Tri-Band 802.11ax Wireless Router |
| Brand | Linksys |
| Test Model | MX8500 |
| Series Model | MX85EC, MX85WH, MX85MS |
| Model Difference | Marketing Differentiation |
| Sample Status | Engineering sample |
| Driver version | SPF11.3_CS_v1.12_CBP |
| Power Supply Rating | 12Vdc from adapter |
| Modulation Type | 802.11a: BPSK, QPSK, 16QAM, 64QAM 802.11ac: BPSK, QPSK, 16QAM, 64QAM, 256QAM 802.11ax: BPSK, QPSK, 16QAM, 64QAM, 256QAM, 1024QAM |
| Modulation Technology | OFDM, OFDMA |
| Transfer Rate | 802.11a: 54/48/36/24/18/12/9/6Mbps 802.11n (20MHz/40MHz): up to 600Mbps 802.11ac (20MHz/40MHz/80MHz): up to 1733.3Mbps 802.11ax (20MHz/40MHz/80MHz): up to 2402Mbps |
| Operating Frequency | 5180 ~ 5240MHz, 5745 ~ 5825MHz |
| Number of Channel | 5180 ~ 5240MHz: 802.11a, 802.11n (20MHz), 802.11ac (20MHz), 802.11ax (20MHz): 4 802.11n (40MHz), 802.11ac (40MHz), 802.11ax (40MHz): 2 802.11ac (80MHz), 802.11ax (80MHz): 1 5745 ~ 5825MHz: 802.11a, 802.11n (20MHz), 802.11ac (20MHz), 802.11ax (20MHz): 5 802.11n (40MHz), 802.11ac (40MHz), 802.11ax (40MHz): 2 802.11ac (80MHz), 802.11ax (80MHz): 1 |
| Output Power | 5180 ~ 5240MHz: CDD Mode: 653.703mW Beamforming Mode: 601.802mW 5745 ~ 5825MHz: CDD Mode: 689.979mW Beamforming Mode: 507.757mW |
| Antenna Type | Refer to Note |
| Antenna Connector | Refer to Note |
| Accessory Device | Refer to Note |
| Cable Supplied | NA |

Note:

1. The EUT incorporates a MIMO function. Physically, the EUT provides 4 completed transmitters and 4 receivers.

| Modulation Mode | CDD Mode | Beamforming Mode | TX Function |
|------------------|----------|------------------|-------------|
| 802.11a | Support | Not Support | 4TX |
| 802.11n (20MHz) | Support | Not Support | 4TX |
| 802.11n (40MHz) | Support | Not Support | 4TX |
| 802.11ac (20MHz) | Support | Support | 4TX |
| 802.11ac (40MHz) | Support | Support | 4TX |
| 802.11ac (80MHz) | Support | Support | 4TX |
| 802.11ax (20MHz) | Support | Support | 4TX |
| 802.11ax (40MHz) | Support | Support | 4TX |
| 802.11ax (80MHz) | Support | Support | 4TX |

* The bandwidth and modulation are similar for 20MHz/40MHz on 802.11n mode and 20MHz/40MHz on 802.11n mode and 20MHz/40MHz on 802.11ax mode. Therefore the investigated worst case is the representative mode in test report. (Final test mode refer section 3.2.1)

* For 802.11n/ac/ax, CDD mode and Beamforming mode are presented in power output test item. For other test items, CDD mode is the worst case for final tests after pretesting.

2. The following antennas were provided to the EUT.

| Antenna Type | Dipole on PCB | |
|-------------------|-------------------|-------------------|
| Antenna Connector | i-pex (MHF) | |
| Antenna No. | Gain (dBi) | |
| | 5150MHz ~ 5250MHz | 5745MHz ~ 5825MHz |
| Ant1=5GA | 4.9 | 5.4 |
| Ant2=5GB | 5.1 | 4.8 |
| Ant3=5GC | 4.1 | 5.7 |
| Ant4=5GD | 3.0 | 5.8 |

The following antenna allocation table was provided to the EUT.

| 5G Antenna port | | 5G Antenna port | | TX Function | |
|-----------------|-----|-----------------|-----|-------------|------------|
| Degree -45° | 5GC | Degree +45° | 5GD | MIMO | Correlated |
| Degree -45° | 5GA | Degree +45° | 5GB | MIMO | |

All antennas are dipole type. Thus antennas are all used the same type, the difference is only in the placement direction. According this condition, 2GA1 / 2GA2 are cross-polarization, 2GB1 / 2GB2 are cross-polarization, 5GA and 5GC locates on the opposite side of the device. The Degree -45° means the angle we see when facing towards to the antenna. This means if we look at 5GA(-45°) in front of us, the 5GC at the opposite side will be +45°. Therefore, it is sure that 5GA and 5GC have exactly 90-degree angle difference and they are cross-polarized. The same situation are with 5GB and 5GD. 6GA and 6GC locates on the opposite side of the device. The Degree +45° means the angle we see when facing towards to the antenna. This means if we look at 6GA(+45°) in front of us, the 6GC at the opposite side will be -45°. Therefore, it is sure that 6GA and 6GC have exactly 90-degree angle difference and are cross-polarized. The same situation are with 6GB and 6GD.

The above Antenna information is declared by manufacturer and for more detailed features description, please refer to the manufacturer's specifications, the laboratory shall not be held responsible.

3. The following Filters were provided to the EUT.

◇ Filter Soshin

◇ Filter ACX

After pre-tested, **Filter Soshin** was the worst case for final tset.

4. The EUT uses following adapter.

| Adapter 1 | |
|--------------|--|
| Brand | Ktec |
| Model | KSAS0501200400HU |
| Input Power | 100-240Vac, 50/60Hz, 1.2A |
| Output Power | 12Vdc, 4.0A |
| Power Cord | AC 2-Pin, Non-shielded DC cable (1.5m) |
| Adapter 2 | |
| Brand | APD |
| Model | WA-48B12FU |
| Input Power | 100-240Vac, 50/60Hz, 1.5A |
| Output Power | 12Vdc, 4.0A |
| Power Cord | AC 2-Pin, Non-shielded DC cable (1.5m) |

The above two adapters were pre-tested, and Adapter 1 was the worst case for final test.

5. WiFi 2.4GHz, 5GHz & 6E technologies can transmit at same time.
6. Spurious emission of the simultaneous operation (WiFi 2.4GHz, 5GHz & 6E technologies) has been evaluated and no non-compliance was found.
7. The above EUT information is declared by manufacturer and for more detailed features description, please refer to the manufacturer's specifications or user's manual.

3.2 Description of Test Modes

For 5180 ~ 5240MHz:

4 channels are provided for 802.11a, 802.11n (20MHz), 802.11ac (20MHz), 802.11ax (20MHz):

| Channel | Frequency | Channel | Frequency |
|---------|-----------|---------|-----------|
| 36 | 5180 MHz | 44 | 5220 MHz |
| 40 | 5200 MHz | 48 | 5240 MHz |

2 channels are provided for 802.11n (40MHz), 802.11ac (40MHz), 802.11ax (40MHz):

| Channel | Frequency | Channel | Frequency |
|---------|-----------|---------|-----------|
| 38 | 5190 MHz | 46 | 5230 MHz |

1 channel is provided for 802.11ac (80MHz), 802.11ax (80MHz):

| Channel | Frequency |
|---------|-----------|
| 42 | 5210MHz |

For 5745 ~ 5825MHz:

5 channels are provided for 802.11a, 802.11n (20MHz), 802.11ac (20MHz), 802.11ax (20MHz):

| Channel | Frequency | Channel | Frequency |
|---------|-----------|---------|-----------|
| 149 | 5745MHz | 161 | 5805MHz |
| 153 | 5765MHz | 165 | 5825MHz |
| 157 | 5785MHz | | |

2 channels are provided for 802.11n (40MHz), 802.11ac (40MHz), 802.11ax (40MHz):

| Channel | Frequency | Channel | Frequency |
|---------|-----------|---------|-----------|
| 151 | 5755MHz | 159 | 5795MHz |

1 channel is provided for 802.11ac (80MHz), 802.11ax (80MHz):

| Channel | Frequency |
|---------|-----------|
| 155 | 5775MHz |

3.2.1 Test Mode Applicability and Tested Channel Detail

| EUT Configure Mode | Applicable To | | | | Description |
|--------------------|---------------|-------|-----|------|-------------|
| | RE≥1G | RE<1G | PLC | APCM | |
| - | √ | √ | √ | √ | - |

Where **RE≥1G**: Radiated Emission above 1GHz & Bandedge Measurement

RE<1G: Radiated Emission below 1GHz

PLC: Power Line Conducted Emission

APCM: Antenna Port Conducted Measurement

Radiated Emission Test (Above 1GHz):

Pre-Scan has been conducted to determine the worst-case mode from all possible combinations between available modulations, data rates and antenna ports (if EUT with antenna diversity architecture).

Following channel(s) was (were) selected for the final test as listed below.

| EUT Configure Mode | Mode | Frequency Band (MHz) | Available Channel | Tested Channel | Modulation Technology | Data Rate (Mbps) |
|--------------------|------------------|----------------------|-------------------|----------------|-----------------------|------------------|
| CDD Mode | | | | | | |
| - | 802.11a | 5180-5240 | 36 to 48 | 36, 40, 48 | OFDM | 6.0 |
| | 802.11ax (20MHz) | | 36 to 48 | 36, 40, 48 | OFDMA | MCS0 |
| | 802.11ax (40MHz) | | 38 to 46 | 38, 46 | OFDMA | MCS0 |
| | 802.11ax (80MHz) | | 42 | 42 | OFDMA | MCS0 |
| - | 802.11a | 5745-5825 | 149 to 165 | 149, 157, 165 | OFDM | 6.0 |
| | 802.11ax (20MHz) | | 149 to 165 | 149, 157, 165 | OFDMA | MCS0 |
| | 802.11ax (40MHz) | | 151 to 159 | 151, 159 | OFDMA | MCS0 |
| | 802.11ax (80MHz) | | 155 | 155 | OFDMA | MCS0 |

Radiated Emission Test (Below 1GHz):

Pre-Scan has been conducted to determine the worst-case mode from all possible combinations between available modulations, data rates and antenna ports (if EUT with antenna diversity architecture).

Following channel(s) was (were) selected for the final test as listed below.

| EUT Configure Mode | Mode | Frequency Band (MHz) | Available Channel | Tested Channel | Modulation Technology | Data Rate (Mbps) |
|--------------------|------------------|----------------------|-------------------|----------------|-----------------------|------------------|
| CDD Mode | | | | | | |
| - | 802.11ax (20MHz) | 5180-5240 | 36 to 48 | 157 | OFDMA | MCS0 |
| - | 802.11ax (20MHz) | 5745-5825 | 149 to 165 | | OFDMA | MCS0 |

Power Line Conducted Emission Test:

Pre-Scan has been conducted to determine the worst-case mode from all possible combinations between available modulations, data rates and antenna ports (if EUT with antenna diversity architecture).

Following channel(s) was (were) selected for the final test as listed below.

| EUT Configure Mode | Mode | Frequency Band (MHz) | Available Channel | Tested Channel | Modulation Technology | Data Rate (Mbps) |
|--------------------|------------------|----------------------|-------------------|----------------|-----------------------|------------------|
| CDD Mode | | | | | | |
| - | 802.11ax (20MHz) | 5180-5240 | 36 to 48 | 157 | OFDMA | MCS0 |
| - | 802.11ax (20MHz) | 5745-5825 | 149 to 165 | | OFDMA | MCS0 |

Antenna Port Conducted Measurement:

- This item includes all test value of each mode, but only includes spectrum plot of worst value of each mode.
- Pre-Scan has been conducted to determine the worst-case mode from all possible combinations between available modulations, data rates and antenna ports (if EUT with antenna diversity architecture).
- Following channel(s) was (were) selected for the final test as listed below.

| EUT Configure Mode | Mode | Frequency Band (MHz) | Available Channel | Tested Channel | Modulation Technology | Data Rate (Mbps) |
|--|-------------------|----------------------|-------------------|----------------|-----------------------|------------------|
| CDD Mode | | | | | | |
| - | 802.11a | 5180-5240 | 36 to 48 | 36, 40, 48 | OFDM | 6.0 |
| | 802.11ac (20MHz)* | | 36 to 48 | 36, 40, 48 | OFDM | 6.5 |
| | 802.11ac (40MHz)* | | 38 to 46 | 38, 46 | OFDM | 13.5 |
| | 802.11ac (80MHz)* | | 42 | 42 | OFDM | 65.0 |
| | 802.11ax (20MHz) | | 36 to 48 | 36, 40, 48 | OFDMA | MCS0 |
| | 802.11ax (40MHz) | | 38 to 46 | 38, 46 | OFDMA | MCS0 |
| | 802.11ax (80MHz) | | 42 | 42 | OFDMA | MCS0 |
| - | 802.11a | 5745-5825 | 149 to 165 | 149, 157, 165 | OFDM | 6.0 |
| | 802.11ac (20MHz)* | | 149 to 165 | 149, 157, 165 | OFDM | 6.5 |
| | 802.11ac (40MHz)* | | 151 to 159 | 151, 159 | OFDM | 13.5 |
| | 802.11ac (80MHz)* | | 155 | 155 | OFDM | 65.0 |
| | 802.11ax (20MHz) | | 149 to 165 | 149, 157, 165 | OFDMA | MCS0 |
| | 802.11ax (40MHz) | | 151 to 159 | 151, 159 | OFDMA | MCS0 |
| | 802.11ax (80MHz) | | 155 | 155 | OFDMA | MCS0 |
| *802.11ac (20MHz), 802.11ac (40MHz), 802.11ac (80MHz) are for Conducted Output Power Measurement only. | | | | | | |
| Beamforming Mode (Conducted Power Measurement only) | | | | | | |
| - | 802.11ac (20MHz) | 5180-5240 | 36 to 48 | 36, 40, 48 | OFDM | 6.5 |
| | 802.11ac (40MHz) | | 38 to 46 | 38, 46 | OFDM | 13.5 |
| | 802.11ac (80MHz) | | 42 | 42 | OFDM | 65.0 |
| | 802.11ax (20MHz) | | 36 to 48 | 36, 40, 48 | OFDMA | MCS0 |
| | 802.11ax (40MHz) | | 38 to 46 | 38, 46 | OFDMA | MCS0 |
| | 802.11ax (80MHz) | | 42 | 42 | OFDMA | MCS0 |
| - | 802.11ac (20MHz) | 5745-5825 | 149 to 165 | 149, 157, 165 | OFDM | 6.5 |
| | 802.11ac (40MHz) | | 151 to 159 | 151, 159 | OFDM | 13.5 |
| | 802.11ac (80MHz) | | 155 | 155 | OFDM | 65.0 |
| | 802.11ax (20MHz) | | 149 to 165 | 149, 157, 165 | OFDMA | MCS0 |
| | 802.11ax (40MHz) | | 151 to 159 | 151, 159 | OFDMA | MCS0 |
| | 802.11ax (80MHz) | | 155 | 155 | OFDMA | MCS0 |

Test Condition:

| Applicable to | Environmental Conditions | Input Power | Tested by |
|---------------|----------------------------------|--------------|----------------------|
| RE≥1G | 22deg. C, 64%RH, 25deg. C, 68%RH | 120Vac, 60Hz | Ian Chang, Dalen Dai |
| RE<1G | 25deg. C, 68%RH | 120Vac, 60Hz | Dalen Dai |
| PLC | 25deg. C, 75%RH | 120Vac, 60Hz | Ian Chang |
| APCM | 25deg. C, 76%RH | 120Vac, 60Hz | Saxon Lee |

3.3 Duty Cycle of Test Signal

Duty cycle of test signal is < 98%, duty factor is required.

802.11a: Duty cycle = 1.44/1.555 = 0.926, Duty factor = $10 \cdot \log(1/0.926) = 0.33$

802.11ax (20MHz): Duty cycle = 5.49/5.715 = 0.961, Duty factor = $10 \cdot \log(1/0.961) = 0.17$

802.11ax (40MHz): Duty cycle = 5.475/5.685 = 0.963, Duty factor = $10 \cdot \log(1/0.963) = 0.16$

802.11ax (80MHz): Duty cycle = 5.49/5.67 = 0.968, Duty factor = $10 \cdot \log(1/0.968) = 0.14$

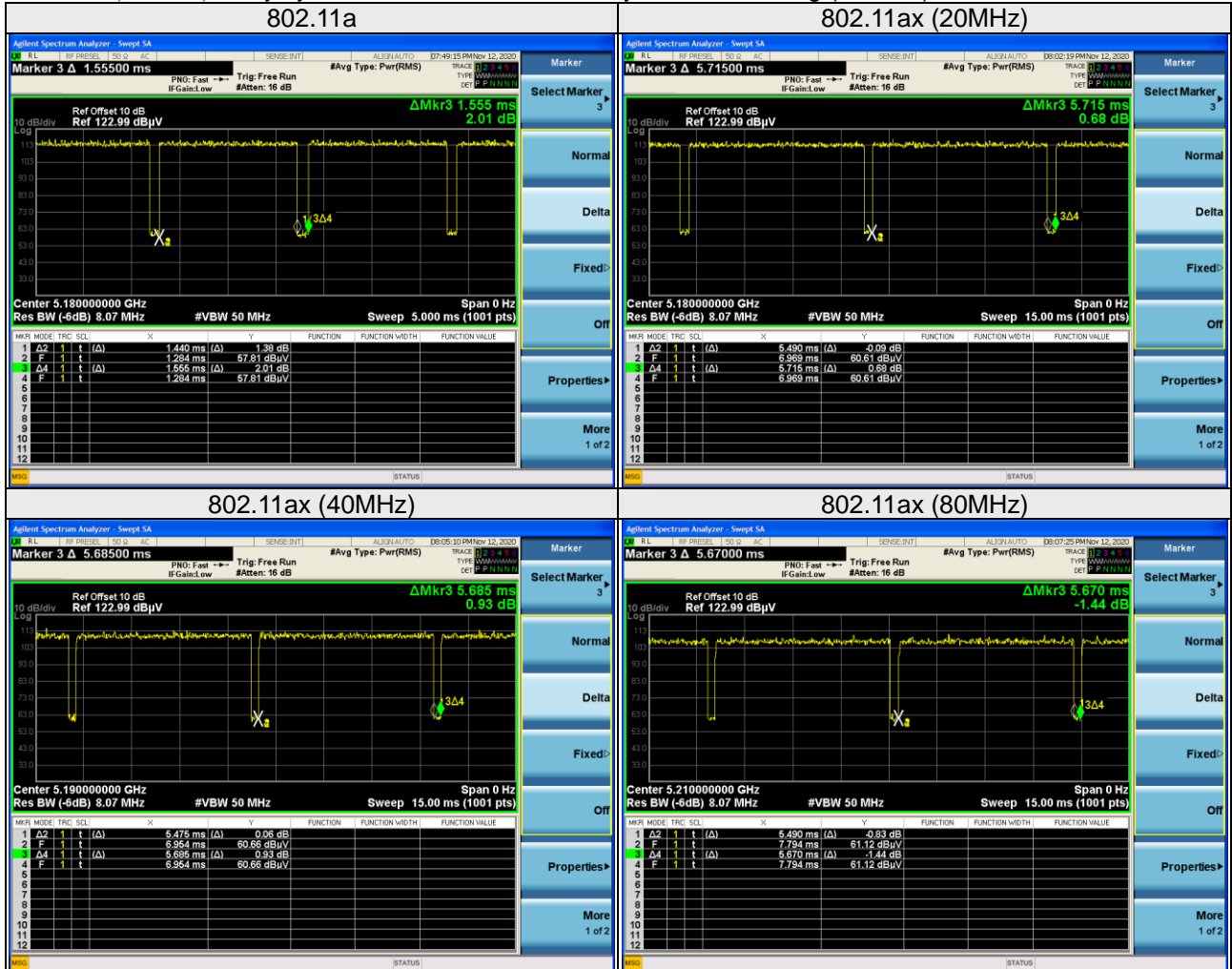

3.4 Description of Support Units

The EUT has been tested as an independent unit together with other necessary accessories or support units. The following support units or accessories were used to form a representative test configuration during the tests.

| ID | Product | Brand | Model No. | Serial No. | FCC ID | Remarks |
|----|---------------------|--------|-----------|------------|--------|-----------------|
| A. | Notebook PC | Lenove | 81LG | PF1NF9V2 | N/A | Provided by Lab |
| B. | LAN Load | N/A | N/A | N/A | N/A | Provided by Lab |
| C. | USB 3.0 Flash Drive | HP | v250w | N/A | N/A | Provided by Lab |

Note:

1. All power cords of the above support units are non-shielded (1.8m).
2. Item A acted as communication partners to transfer data.

| ID | Cable Descriptions | Qty. | Length (m) | Shielding (Yes/No) | Cores (Qty.) | Remarks |
|----|--------------------|------|------------|--------------------|--------------|--------------------------------|
| 1. | LAN cable | 1 | 10 | N | 0 | Provided by Lab (RJ45, Cat.5e) |
| 2. | LAN cable | 4 | 1 | N | 0 | Provided by Lab (RJ45, Cat.5e) |
| 3. | DC cable | 1 | 1.5 | N | 0 | Supplied by client |

Note: The core(s) is(are) originally attached to the cable(s).

3.4.1 Configuration of System under Test

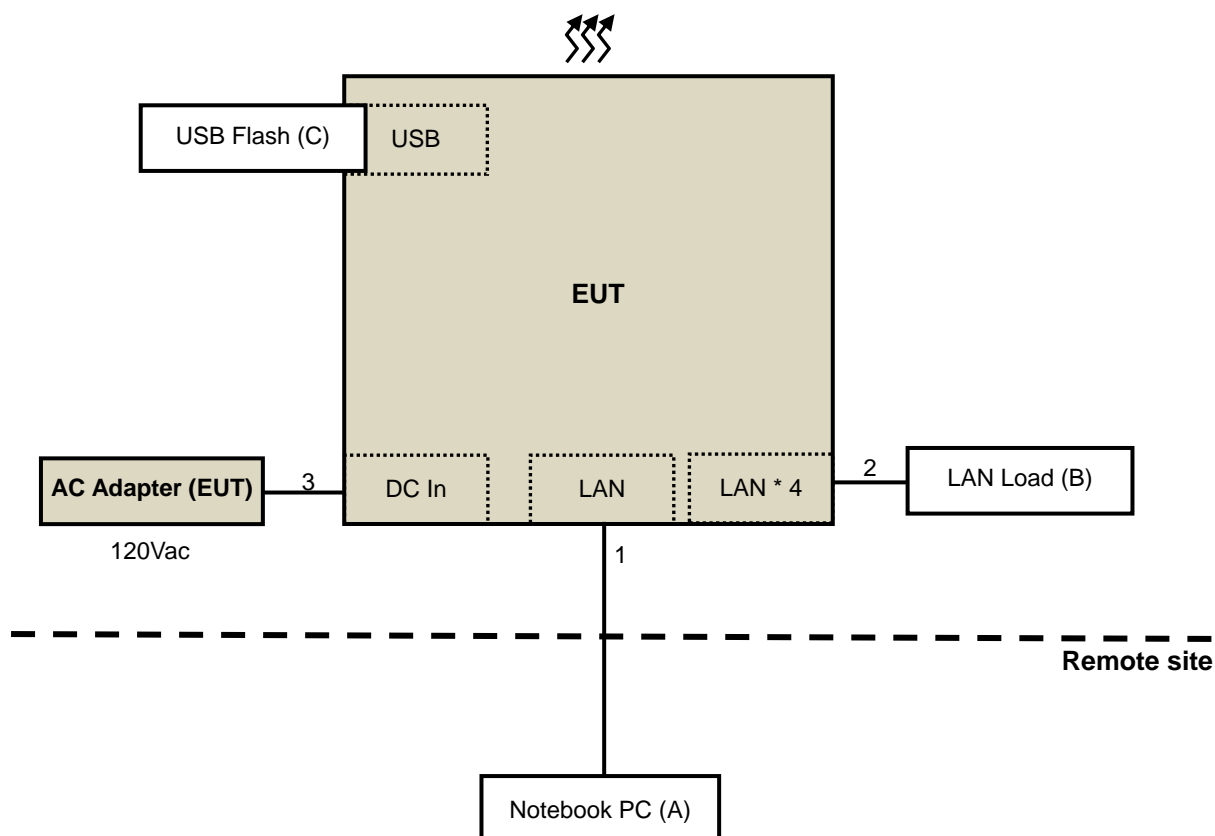

3.5 General Description of Applied Standards and References

The EUT is a RF Product. According to the specifications of the manufacturer, it must comply with the requirements of the following standards and references:

Test standard:

FCC Part 15, Subpart E (15.407)

ANSI C63.10:2013

All test items have been performed and recorded as per the above standards.

References Test Guidance:

KDB 789033 D02 General UNII Test Procedure New Rules v02r01

KDB 662911 D01 Multiple Transmitter Output v02r01

All test items have been performed as a reference to the above KDB test guidance.

4 Test Types and Results

4.1 Radiated Emission and Bandedge Measurement

4.1.1 Limits of Radiated Emission and Bandedge Measurement

Radiated emissions which fall in the restricted bands must comply with the radiated emission limits specified as below table.

| Frequencies (MHz) | Field Strength (microvolts/meter) | Measurement Distance (meters) |
|-------------------|-----------------------------------|-------------------------------|
| 0.009 ~ 0.490 | 2400/F(kHz) | 300 |
| 0.490 ~ 1.705 | 24000/F(kHz) | 30 |
| 1.705 ~ 30.0 | 30 | 30 |
| 30 ~ 88 | 100 | 3 |
| 88 ~ 216 | 150 | 3 |
| 216 ~ 960 | 200 | 3 |
| Above 960 | 500 | 3 |

Note:

1. The lower limit shall apply at the transition frequencies.
2. Emission level (dBuV/m) = 20 log Emission level (uV/m).
3. For frequencies above 1000MHz, the field strength limits are based on average detector, however, the peak field strength of any emission shall not exceed the maximum permitted average limits, specified above by more than 20dB under any condition of modulation.

Limits of unwanted emission out of the restricted bands

| Applicable To | | Limit | |
|--|---|---|---|
| 789033 D02 General UNII Test Procedure New Rules v02r01 | | Field Strength at 3m | |
| | | PK: 74 (dBuV/m) | AV: 54 (dBuV/m) |
| Frequency Band | Applicable To | EIRP Limit | Equivalent Field Strength at 3m |
| 5150~5250 MHz | 15.407(b)(1) | PK: -27 (dBm/MHz) | PK: 68.2(dBuV/m) |
| 5250~5350 MHz | 15.407(b)(2) | | |
| 5470~5725 MHz | 15.407(b)(3) | | |
| 5725~5850 MHz | <input checked="" type="checkbox"/> 15.407(b)(4)(i) | PK: -27 (dBm/MHz) ^{*1} PK: 10 (dBm/MHz) ^{*2} PK: 15.6 (dBm/MHz) ^{*3} PK: 27 (dBm/MHz) ^{*4} | PK: 68.2(dBuV/m) ^{*1} PK: 105.2 (dBuV/m) ^{*2} PK: 110.8(dBuV/m) ^{*3} PK: 122.2 (dBuV/m) ^{*4} |
| | <input type="checkbox"/> 15.407(b)(4)(ii) | Emission limits in section 15.247(d) | |
| ^{*1} beyond 75 MHz or more above of the band edge. | | ^{*2} below the band edge increasing linearly to 10 dBm/MHz at 25 MHz above. | |
| ^{*3} below the band edge increasing linearly to a level of 15.6 dBm/MHz at 5 MHz above. | | ^{*4} from 5 MHz above or below the band edge increasing linearly to a level of 27 dBm/MHz at the band edge. | |

Note: The following formula is used to convert the equipment isotropic radiated power (eirp) to field strength:

$$E = \frac{1000000\sqrt{30P}}{3} \mu\text{V/m, where P is the eirp (Watts).}$$

4.1.2 Test Instruments

| DESCRIPTION & MANUFACTURER | MODEL NO. | SERIAL NO. | CALIBRATED DATE | CALIBRATED UNTIL |
|---|----------------------|--------------|-----------------|------------------|
| HP Preamplifier | 8447D | 2432A03504 | Feb. 19, 2020 | Feb. 18, 2021 |
| HP Preamplifier | 8449B | 3008A01201 | Feb. 20, 2020 | Feb. 19, 2021 |
| MITEQ Preamplifier | AMF-6F-260400-33-8P | 892164 | Feb. 19, 2020 | Feb. 18, 2021 |
| Agilent TEST RECEIVER | N9038A | MY51210129 | Mar. 18, 2020 | Mar. 17, 2021 |
| Schwarzbeck Antenna | VULB 9168 | 139 | Nov. 6, 2020 | Nov. 5, 2021 |
| Schwarzbeck Antenna | VHBA 9123 | 480 | Jun. 3, 2019 | Jun. 2, 2021 |
| Schwarzbeck Horn Antenna | BBHA-9170 | 212 | Nov. 24, 2019 | Nov. 23, 2020 |
| | | | Nov. 22, 2020 | Nov. 21, 2021 |
| EMCO Horn Antenna | 3115 | 00028257 | Nov. 24, 2019 | Nov. 23, 2020 |
| | | | Nov. 22, 2020 | Nov. 21, 2021 |
| ADT. Turn Table | TT100 | 0306 | NA | NA |
| ADT. Tower | AT100 | 0306 | NA | NA |
| Software | Radiated_V7.6.15.9.5 | NA | NA | NA |
| SUHNER RF cable With 4dB PAD | SF102 | Cable-CH6-01 | Jul. 9, 2020 | Jul. 8, 2021 |
| EMEC RF cable With 3/4dB PAD | EM102-KMKM | 01 | Aug. 21, 2020 | Aug. 20, 2021 |
| KEYSIGHT MIMO Powermeasurement Test set | U2021XA | U2021XA-001 | Jun. 16, 2020 | Jun. 15, 2021 |
| KEYSIGHT Spectrum Analyzer | N9030A | MY54490260 | Jul. 22, 2020 | Jul. 21, 2021 |
| Loop Antenna EMCI | LPA600 | 270 | Aug. 23, 2019 | Aug. 22, 2021 |
| Highpass filter Wainwright Instruments | WHK 3.1/18G-10SS | SN 8 | NA | NA |
| ROHDE & SCHWARZ Spectrum Analyzer | FSV40 | 101042 | Sep. 8, 2020 | Sep. 7, 2021 |
| Anritsu Power Sensor | MA2411B | 0738404 | Apr. 13, 2020 | Apr. 12, 2021 |
| Anritsu Power Meter | ML2495A | 0842014 | Apr. 13, 2020 | Apr. 12, 2021 |

- NOTE:** 1. The calibration interval of the above test instruments is 12/24 months. And the calibrations are traceable to NML/ROC and NIST/USA.
2. The horn antenna and HP preamplifier (model: 8449B) are used only for the measurement of emission frequency above 1GHz if tested.
3. The test was performed in Chamber No. 6.

4.1.3 Test Procedures

For Radiated emission below 30MHz

- a. The EUT was placed on the top of a rotating table 0.8 meters above the ground at a 3 meter chamber room. The table was rotated 360 degrees to determine the position of the highest radiation.
- b. The EUT was set 3 meters away from the interference-receiving antenna, which was mounted on the top of a variable-height antenna tower.
- c. Parallel, perpendicular, and ground-parallel orientations of the antenna are set to make the measurement.
- d. For each suspected emission, the EUT was arranged to its worst case and the rotatable table was turned from 0 degrees to 360 degrees to find the maximum reading.
- e. The test-receiver system was set to Quasi-Peak Detect Function and Specified Bandwidth with Maximum Hold Mode.

Note:

1. The resolution bandwidth and video bandwidth of test receiver/spectrum analyzer is 9kHz at frequency below 30MHz.

For Radiated emission above 30MHz

- a. The EUT was placed on the top of a rotating table 0.8 meters (for 30MHz ~ 1GHz) / 1.5 meters (for above 1GHz) above the ground at 3 meter chamber room for test. The table was rotated 360 degrees to determine the position of the highest radiation.
- b. The EUT was set 3 meters away from the interference-receiving antenna, which was mounted on the top of a variable-height antenna tower.
- c. The height of antenna is varied from one meter to four meters above the ground to determine the maximum value of the field strength. Both horizontal and vertical polarizations of the antenna are set to make the measurement.
- d. For each suspected emission, the EUT was arranged to its worst case and then the antenna was tuned to heights from 1 meter to 4 meters and the rotatable table was turned from 0 degrees to 360 degrees to find the maximum reading.
- e. The test-receiver system was set to quasi-peak detect function and specified bandwidth with maximum hold mode when the test frequency is below 1 GHz.
- f. The test-receiver system was set to peak and average detect function and specified bandwidth with maximum hold mode when the test frequency is above 1 GHz. If the peak reading value also meets average limit, measurement with the average detector is unnecessary.

Note:

1. The resolution bandwidth and video bandwidth of test receiver/spectrum analyzer is 120kHz for Quasi-peak detection (QP) at frequency below 1GHz.
2. The resolution bandwidth of test receiver/spectrum analyzer is 1 MHz and the video bandwidth is 3 MHz for Peak detection (PK) at frequency above 1GHz.
3. The resolution bandwidth of test receiver/spectrum analyzer is 1MHz and the video bandwidth is $\geq 1/T$ (Duty cycle < 98%) or 10Hz (Duty cycle $\geq 98\%$) for Average detection (AV) at frequency above 1GHz.
(802.11a: RBW = 1MHz, VBW = 750Hz; 802.11ax (20MHz): RBW = 1MHz, VBW = 200Hz;
802.11ax (40MHz): RBW = 1MHz, VBW = 200Hz; 802.11ax (80MHz): RBW = 1MHz, VBW = 200Hz)
4. All modes of operation were investigated and the worst-case emissions are reported.

4.1.4 Deviation from Test Standard

No deviation.

4.1.5 Test Setup

For Radiated emission below 30MHz

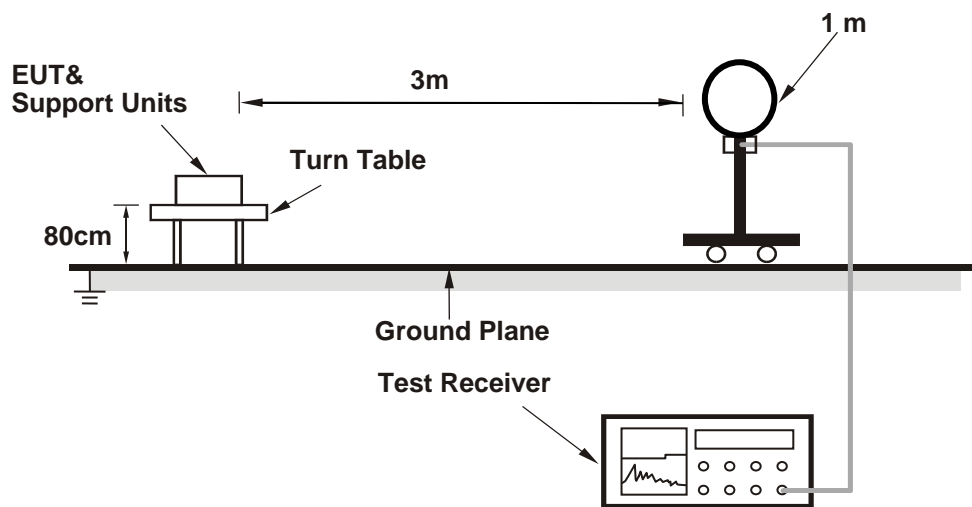

For Radiated emission 30MHz to 1GHz

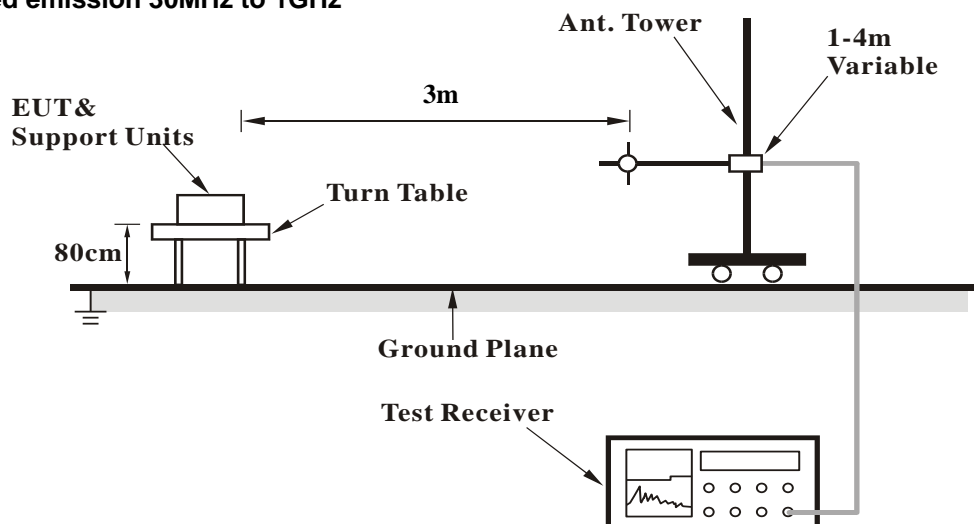

For Radiated emission above 1GHz

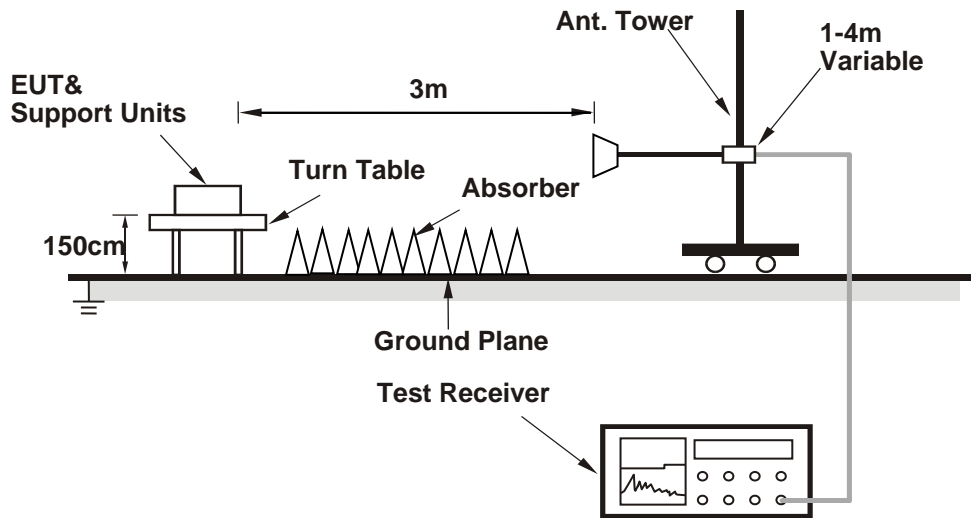

For the actual test configuration, please refer to the attached file (Test Setup Photo).

4.1.6 EUT Operating Conditions

- a. Placed the EUT on the testing table.
- b. Prepared a notebook to act as a communication partner and placed it outside of testing area.
- c. The communication partner connected with EUT via a RJ45 cable and ran a test program (provided by manufacturer) to enable EUT under transmission condition continuously at specific channel frequency.
- d. The communication partner sent data to EUT by command "PING".
- e. The communication partner read and wrote messages from USB Flash via EUT.

4.1.7 Test Results

Above 1GHz data:

CDD Mode

802.11a

| | | | |
|------------------------|--------------|--------------------------|---------------------------|
| RF Mode | TX 802.11a | Channel | CH 36 : 5180 MHz |
| Frequency Range | 1GHz ~ 40GHz | Detector Function | Peak (PK) Average (AV) |

| Antenna Polarity & Test Distance : Horizontal at 3 m | | | | | | | | |
|--|-----------------|-------------------------|----------------|-------------|--------------------|----------------------|------------------|--------------------------|
| No | Frequency (MHz) | Emission Level (dBuV/m) | Limit (dBuV/m) | Margin (dB) | Antenna Height (m) | Table Angle (Degree) | Raw Value (dBuV) | Correction Factor (dB/m) |
| 1 | 5150.00 | 64.00 PK | 74.00 | -10.00 | 2.75 H | 325 | 54.29 | 9.71 |
| 2 | 5150.00 | 52.61 AV | 54.00 | -1.39 | 2.75 H | 325 | 42.90 | 9.71 |
| 3 | *5180.00 | 116.77 PK | | | 2.75 H | 325 | 107.00 | 9.77 |
| 4 | *5180.00 | 108.59 AV | | | 2.75 H | 325 | 98.82 | 9.77 |
| 5 | #10360.00 | 57.70 PK | 68.20 | -10.50 | 4.00 H | 348 | 41.60 | 16.10 |

| Antenna Polarity & Test Distance : Vertical at 3 m | | | | | | | | |
|--|-----------------|-------------------------|----------------|-------------|--------------------|----------------------|------------------|--------------------------|
| No | Frequency (MHz) | Emission Level (dBuV/m) | Limit (dBuV/m) | Margin (dB) | Antenna Height (m) | Table Angle (Degree) | Raw Value (dBuV) | Correction Factor (dB/m) |
| 1 | 5150.00 | 63.60 PK | 74.00 | -10.40 | 1.42 V | 43 | 53.89 | 9.71 |
| 2 | 5150.00 | 51.75 AV | 54.00 | -2.25 | 1.42 V | 43 | 42.04 | 9.71 |
| 3 | *5180.00 | 116.53 PK | | | 1.42 V | 43 | 106.76 | 9.77 |
| 4 | *5180.00 | 108.31 AV | | | 1.42 V | 43 | 98.54 | 9.77 |
| 5 | #10360.00 | 56.75 PK | 68.20 | -11.45 | 1.57 V | 148 | 40.65 | 16.10 |

Remarks:

1. Emission Level(dBuV/m) = Raw Value(dBuV) + Correction Factor(dB/m)
2. Correction Factor(dB/m) = Antenna Factor(dB/m) + Cable Factor(dB) – Pre-Amplifier Factor(dB)
3. Margin value = Emission Level – Limit value
4. The other emission levels were very low against the limit.
5. " * ": Fundamental frequency.
6. " # ": The radiated frequency is out of the restricted band.

| | | | |
|------------------------|--------------|--------------------------|---------------------------|
| RF Mode | TX 802.11a | Channel | CH 40 : 5200 MHz |
| Frequency Range | 1GHz ~ 40GHz | Detector Function | Peak (PK) Average (AV) |

Antenna Polarity & Test Distance : Horizontal at 3 m

| No | Frequency (MHz) | Emission Level (dBuV/m) | Limit (dBuV/m) | Margin (dB) | Antenna Height (m) | Table Angle (Degree) | Raw Value (dBuV) | Correction Factor (dB/m) |
|----|-----------------|-------------------------|----------------|-------------|--------------------|----------------------|------------------|--------------------------|
| 1 | *5200.00 | 121.85 PK | | | 2.47 H | 312 | 112.05 | 9.80 |
| 2 | *5200.00 | 113.95 AV | | | 2.47 H | 312 | 104.15 | 9.80 |
| 3 | #10400.00 | 57.51 PK | 68.20 | -10.69 | 1.62 H | 234 | 41.39 | 16.12 |

Antenna Polarity & Test Distance : Vertical at 3 m

| No | Frequency (MHz) | Emission Level (dBuV/m) | Limit (dBuV/m) | Margin (dB) | Antenna Height (m) | Table Angle (Degree) | Raw Value (dBuV) | Correction Factor (dB/m) |
|----|-----------------|-------------------------|----------------|-------------|--------------------|----------------------|------------------|--------------------------|
| 1 | *5200.00 | 121.49 PK | | | 1.46 V | 51 | 111.69 | 9.80 |
| 2 | *5200.00 | 113.08 AV | | | 1.46 V | 51 | 103.28 | 9.80 |
| 3 | #10400.00 | 56.68 PK | 68.20 | -11.52 | 1.84 V | 124 | 40.56 | 16.12 |

Remarks:

1. Emission Level(dBuV/m) = Raw Value(dBuV) + Correction Factor(dB/m)
2. Correction Factor(dB/m) = Antenna Factor(dB/m) + Cable Factor(dB) – Pre-Amplifier Factor(dB)
3. Margin value = Emission Level – Limit value
4. The other emission levels were very low against the limit.
5. " * ": Fundamental frequency.
6. " # ": The radiated frequency is out of the restricted band.

| | | | |
|------------------------|--------------|--------------------------|---------------------------|
| RF Mode | TX 802.11a | Channel | CH 48 : 5240 MHz |
| Frequency Range | 1GHz ~ 40GHz | Detector Function | Peak (PK) Average (AV) |

Antenna Polarity & Test Distance : Horizontal at 3 m

| No | Frequency (MHz) | Emission Level (dBuV/m) | Limit (dBuV/m) | Margin (dB) | Antenna Height (m) | Table Angle (Degree) | Raw Value (dBuV) | Correction Factor (dB/m) |
|----|-----------------|-------------------------|----------------|-------------|--------------------|----------------------|------------------|--------------------------|
| 1 | *5240.00 | 121.86 PK | | | 2.75 H | 318 | 111.85 | 10.01 |
| 2 | *5240.00 | 114.21 AV | | | 2.75 H | 318 | 104.20 | 10.01 |
| 3 | 5350.00 | 62.86 PK | 74.00 | -11.14 | 2.75 H | 318 | 52.18 | 10.68 |
| 4 | 5350.00 | 50.70 AV | 54.00 | -3.30 | 2.75 H | 318 | 40.02 | 10.68 |
| 5 | #10480.00 | 57.21 PK | 68.20 | -10.99 | 1.47 H | 152 | 41.18 | 16.03 |

Antenna Polarity & Test Distance : Vertical at 3 m

| No | Frequency (MHz) | Emission Level (dBuV/m) | Limit (dBuV/m) | Margin (dB) | Antenna Height (m) | Table Angle (Degree) | Raw Value (dBuV) | Correction Factor (dB/m) |
|----|-----------------|-------------------------|----------------|-------------|--------------------|----------------------|------------------|--------------------------|
| 1 | *5240.00 | 121.24 PK | | | 1.41 V | 56 | 111.23 | 10.01 |
| 2 | *5240.00 | 113.68 AV | | | 1.41 V | 56 | 103.67 | 10.01 |
| 3 | 5350.00 | 62.42 PK | 74.00 | -11.58 | 1.41 V | 56 | 51.74 | 10.68 |
| 4 | 5350.00 | 50.37 AV | 54.00 | -3.63 | 1.41 V | 56 | 39.69 | 10.68 |
| 5 | #10480.00 | 56.55 PK | 68.20 | -11.65 | 1.49 V | 36 | 40.52 | 16.03 |

Remarks:

1. Emission Level(dBuV/m) = Raw Value(dBuV) + Correction Factor(dB/m)
2. Correction Factor(dB/m) = Antenna Factor(dB/m) + Cable Factor(dB) – Pre-Amplifier Factor(dB)
3. Margin value = Emission Level – Limit value
4. The other emission levels were very low against the limit.
5. " * " : Fundamental frequency.
6. " # " : The radiated frequency is out of the restricted band.

| | | | |
|------------------------|--------------|--------------------------|---------------------------|
| RF Mode | TX 802.11a | Channel | CH 149 : 5745 MHz |
| Frequency Range | 1GHz ~ 40GHz | Detector Function | Peak (PK) Average (AV) |

Antenna Polarity & Test Distance : Horizontal at 3 m

| No | Frequency (MHz) | Emission Level (dBuV/m) | Limit (dBuV/m) | Margin (dB) | Antenna Height (m) | Table Angle (Degree) | Raw Value (dBuV) | Correction Factor (dB/m) |
|----|-----------------|-------------------------|----------------|-------------|--------------------|----------------------|------------------|--------------------------|
| 1 | #5561.40 | 62.54 PK | 68.20 | -5.66 | 2.09 H | 327 | 51.46 | 11.08 |
| 2 | *5745.00 | 121.85 PK | | | 2.09 H | 327 | 111.32 | 10.53 |
| 3 | *5745.00 | 113.74 AV | | | 2.09 H | 327 | 103.21 | 10.53 |
| 4 | #6006.95 | 63.34 PK | 68.20 | -4.86 | 2.09 H | 327 | 52.55 | 10.79 |
| 5 | 11490.00 | 59.45 PK | 74.00 | -14.55 | 1.86 H | 253 | 41.15 | 18.30 |
| 6 | 11490.00 | 49.04 AV | 54.00 | -4.96 | 1.86 H | 253 | 30.74 | 18.30 |

Antenna Polarity & Test Distance : Vertical at 3 m

| No | Frequency (MHz) | Emission Level (dBuV/m) | Limit (dBuV/m) | Margin (dB) | Antenna Height (m) | Table Angle (Degree) | Raw Value (dBuV) | Correction Factor (dB/m) |
|----|-----------------|-------------------------|----------------|-------------|--------------------|----------------------|------------------|--------------------------|
| 1 | #5568.52 | 59.34 PK | 68.20 | -8.86 | 1.00 V | 169 | 48.32 | 11.02 |
| 2 | *5745.00 | 120.93 PK | | | 1.00 V | 169 | 110.40 | 10.53 |
| 3 | *5745.00 | 113.13 AV | | | 1.00 V | 169 | 102.60 | 10.53 |
| 4 | #6020.25 | 59.36 PK | 68.20 | -8.84 | 1.00 V | 169 | 48.58 | 10.78 |
| 5 | 11490.00 | 59.23 PK | 74.00 | -14.77 | 1.08 V | 314 | 40.93 | 18.30 |
| 6 | 11490.00 | 48.96 AV | 54.00 | -5.04 | 1.08 V | 314 | 30.66 | 18.30 |

Remarks:

1. Emission Level(dBuV/m) = Raw Value(dBuV) + Correction Factor(dB/m)
2. Correction Factor(dB/m) = Antenna Factor(dB/m) + Cable Factor(dB) – Pre-Amplifier Factor(dB)
3. Margin value = Emission Level – Limit value
4. The other emission levels were very low against the limit.
5. " * ": Fundamental frequency.
6. " # ": The radiated frequency is out of the restricted band.

| | | | |
|------------------------|--------------|--------------------------|---------------------------|
| RF Mode | TX 802.11a | Channel | CH 157 : 5785 MHz |
| Frequency Range | 1GHz ~ 40GHz | Detector Function | Peak (PK) Average (AV) |

Antenna Polarity & Test Distance : Horizontal at 3 m

| No | Frequency (MHz) | Emission Level (dBuV/m) | Limit (dBuV/m) | Margin (dB) | Antenna Height (m) | Table Angle (Degree) | Raw Value (dBuV) | Correction Factor (dB/m) |
|----|-----------------|-------------------------|----------------|-------------|--------------------|----------------------|------------------|--------------------------|
| 1 | #5645.48 | 62.11 PK | 68.20 | -6.09 | 2.22 H | 325 | 51.38 | 10.73 |
| 2 | *5785.00 | 120.73 PK | | | 2.22 H | 325 | 110.28 | 10.45 |
| 3 | *5785.00 | 112.81 AV | | | 2.22 H | 325 | 102.36 | 10.45 |
| 4 | #5961.35 | 62.76 PK | 68.20 | -5.44 | 2.22 H | 325 | 52.14 | 10.62 |
| 5 | 11570.00 | 59.32 PK | 74.00 | -14.68 | 1.93 H | 267 | 40.79 | 18.53 |
| 6 | 11570.00 | 48.84 AV | 54.00 | -5.16 | 1.93 H | 267 | 30.31 | 18.53 |

Antenna Polarity & Test Distance : Vertical at 3 m

| No | Frequency (MHz) | Emission Level (dBuV/m) | Limit (dBuV/m) | Margin (dB) | Antenna Height (m) | Table Angle (Degree) | Raw Value (dBuV) | Correction Factor (dB/m) |
|----|-----------------|-------------------------|----------------|-------------|--------------------|----------------------|------------------|--------------------------|
| 1 | #5599.87 | 62.18 PK | 68.20 | -6.02 | 1.50 V | 316 | 51.45 | 10.73 |
| 2 | *5785.00 | 119.78 PK | | | 1.50 V | 316 | 109.33 | 10.45 |
| 3 | *5785.00 | 111.90 AV | | | 1.50 V | 316 | 101.45 | 10.45 |
| 4 | #6016.45 | 63.21 PK | 68.20 | -4.99 | 1.50 V | 316 | 52.43 | 10.78 |
| 5 | 11570.00 | 59.18 PK | 74.00 | -14.82 | 1.14 V | 320 | 40.65 | 18.53 |
| 6 | 11570.00 | 48.73 AV | 54.00 | -5.27 | 1.14 V | 320 | 30.20 | 18.53 |

Remarks:

1. Emission Level(dBuV/m) = Raw Value(dBuV) + Correction Factor(dB/m)
2. Correction Factor(dB/m) = Antenna Factor(dB/m) + Cable Factor(dB) – Pre-Amplifier Factor(dB)
3. Margin value = Emission Level – Limit value
4. The other emission levels were very low against the limit.
5. " * ": Fundamental frequency.
6. " # ": The radiated frequency is out of the restricted band.

| | | | |
|------------------------|--------------|--------------------------|---------------------------|
| RF Mode | TX 802.11a | Channel | CH 165 : 5825 MHz |
| Frequency Range | 1GHz ~ 40GHz | Detector Function | Peak (PK) Average (AV) |

Antenna Polarity & Test Distance : Horizontal at 3 m

| No | Frequency (MHz) | Emission Level (dBuV/m) | Limit (dBuV/m) | Margin (dB) | Antenna Height (m) | Table Angle (Degree) | Raw Value (dBuV) | Correction Factor (dB/m) |
|----|-----------------|-------------------------|----------------|-------------|--------------------|----------------------|------------------|--------------------------|
| 1 | #5556.65 | 62.12 PK | 68.20 | -6.08 | 2.03 H | 330 | 51.00 | 11.12 |
| 2 | *5825.00 | 120.24 PK | | | 2.03 H | 330 | 109.83 | 10.41 |
| 3 | *5825.00 | 112.43 AV | | | 2.03 H | 330 | 102.02 | 10.41 |
| 4 | #5989.85 | 63.16 PK | 68.20 | -5.04 | 2.03 H | 330 | 52.41 | 10.75 |
| 5 | 11650.00 | 59.29 PK | 74.00 | -14.71 | 1.90 H | 258 | 40.99 | 18.30 |
| 6 | 11650.00 | 48.70 AV | 54.00 | -5.30 | 1.90 H | 258 | 30.40 | 18.30 |

Antenna Polarity & Test Distance : Vertical at 3 m

| No | Frequency (MHz) | Emission Level (dBuV/m) | Limit (dBuV/m) | Margin (dB) | Antenna Height (m) | Table Angle (Degree) | Raw Value (dBuV) | Correction Factor (dB/m) |
|----|-----------------|-------------------------|----------------|-------------|--------------------|----------------------|------------------|--------------------------|
| 1 | #5640.73 | 61.88 PK | 68.20 | -6.32 | 1.50 V | 304 | 51.15 | 10.73 |
| 2 | *5825.00 | 119.71 PK | | | 1.50 V | 304 | 109.30 | 10.41 |
| 3 | *5825.00 | 112.04 AV | | | 1.50 V | 304 | 101.63 | 10.41 |
| 4 | #5993.65 | 63.02 PK | 68.20 | -5.18 | 1.50 V | 304 | 52.25 | 10.77 |
| 5 | 11650.00 | 59.12 PK | 74.00 | -14.88 | 1.09 V | 294 | 40.82 | 18.30 |
| 6 | 11650.00 | 48.67 AV | 54.00 | -5.33 | 1.09 V | 294 | 30.37 | 18.30 |

Remarks:

1. Emission Level(dBuV/m) = Raw Value(dBuV) + Correction Factor(dB/m)
2. Correction Factor(dB/m) = Antenna Factor(dB/m) + Cable Factor(dB) – Pre-Amplifier Factor(dB)
3. Margin value = Emission Level – Limit value
4. The other emission levels were very low against the limit.
5. " * ": Fundamental frequency.
6. " # ": The radiated frequency is out of the restricted band.

802.11ax (20MHz)

| | | | |
|------------------------|---------------------|--------------------------|---------------------------|
| RF Mode | TX 802.11ax (20MHz) | Channel | CH 36 : 5180 MHz |
| Frequency Range | 1GHz ~ 40GHz | Detector Function | Peak (PK) Average (AV) |

Antenna Polarity & Test Distance : Horizontal at 3 m

| No | Frequency (MHz) | Emission Level (dBuV/m) | Limit (dBuV/m) | Margin (dB) | Antenna Height (m) | Table Angle (Degree) | Raw Value (dBuV) | Correction Factor (dB/m) |
|----|-----------------|-------------------------|----------------|-------------|--------------------|----------------------|------------------|--------------------------|
| 1 | 5150.00 | 63.85 PK | 74.00 | -10.15 | 2.49 H | 319 | 54.14 | 9.71 |
| 2 | 5150.00 | 52.50 AV | 54.00 | -1.50 | 2.49 H | 319 | 42.79 | 9.71 |
| 3 | *5180.00 | 118.82 PK | | | 2.49 H | 319 | 109.05 | 9.77 |
| 4 | *5180.00 | 107.94 AV | | | 2.49 H | 319 | 98.17 | 9.77 |
| 5 | #10360.00 | 57.33 PK | 68.20 | -10.87 | 1.54 H | 236 | 41.23 | 16.10 |

Antenna Polarity & Test Distance : Vertical at 3 m

| No | Frequency (MHz) | Emission Level (dBuV/m) | Limit (dBuV/m) | Margin (dB) | Antenna Height (m) | Table Angle (Degree) | Raw Value (dBuV) | Correction Factor (dB/m) |
|----|-----------------|-------------------------|----------------|-------------|--------------------|----------------------|------------------|--------------------------|
| 1 | 5150.00 | 63.35 PK | 74.00 | -10.65 | 1.38 V | 53 | 53.64 | 9.71 |
| 2 | 5150.00 | 51.84 AV | 54.00 | -2.16 | 1.38 V | 53 | 42.13 | 9.71 |
| 3 | *5180.00 | 118.44 PK | | | 1.38 V | 53 | 108.67 | 9.77 |
| 4 | *5180.00 | 107.65 AV | | | 1.38 V | 53 | 97.88 | 9.77 |
| 5 | #10360.00 | 56.98 PK | 68.20 | -11.22 | 2.01 V | 168 | 40.88 | 16.10 |

Remarks:

1. Emission Level(dBuV/m) = Raw Value(dBuV) + Correction Factor(dB/m)
2. Correction Factor(dB/m) = Antenna Factor(dB/m) + Cable Factor(dB) – Pre-Amplifier Factor(dB)
3. Margin value = Emission Level – Limit value
4. The other emission levels were very low against the limit.
5. " * ": Fundamental frequency.
6. " # ": The radiated frequency is out of the restricted band.

| | | | |
|------------------------|---------------------|--------------------------|---------------------------|
| RF Mode | TX 802.11ax (20MHz) | Channel | CH 40 : 5200 MHz |
| Frequency Range | 1GHz ~ 40GHz | Detector Function | Peak (PK) Average (AV) |

Antenna Polarity & Test Distance : Horizontal at 3 m

| No | Frequency (MHz) | Emission Level (dBuV/m) | Limit (dBuV/m) | Margin (dB) | Antenna Height (m) | Table Angle (Degree) | Raw Value (dBuV) | Correction Factor (dB/m) |
|----|-----------------|-------------------------|----------------|-------------|--------------------|----------------------|------------------|--------------------------|
| 1 | 5150.00 | 64.16 PK | 74.00 | -9.84 | 2.63 H | 328 | 54.45 | 9.71 |
| 2 | 5150.00 | 52.68 AV | 54.00 | -1.32 | 2.63 H | 328 | 42.97 | 9.71 |
| 3 | *5200.00 | 123.49 PK | | | 2.63 H | 328 | 113.69 | 9.80 |
| 4 | *5200.00 | 112.53 AV | | | 2.63 H | 328 | 102.73 | 9.80 |
| 5 | #10400.00 | 57.54 PK | 68.20 | -10.66 | 1.56 H | 228 | 41.42 | 16.12 |

Antenna Polarity & Test Distance : Vertical at 3 m

| No | Frequency (MHz) | Emission Level (dBuV/m) | Limit (dBuV/m) | Margin (dB) | Antenna Height (m) | Table Angle (Degree) | Raw Value (dBuV) | Correction Factor (dB/m) |
|----|-----------------|-------------------------|----------------|-------------|--------------------|----------------------|------------------|--------------------------|
| 1 | 5150.00 | 63.17 PK | 74.00 | -10.83 | 1.51 V | 41 | 53.46 | 9.71 |
| 2 | 5150.00 | 51.94 AV | 54.00 | -2.06 | 1.51 V | 41 | 42.23 | 9.71 |
| 3 | *5200.00 | 122.84 PK | | | 1.51 V | 41 | 113.04 | 9.80 |
| 4 | *5200.00 | 111.93 AV | | | 1.51 V | 41 | 102.13 | 9.80 |
| 5 | #10400.00 | 56.38 PK | 68.20 | -11.82 | 2.14 V | 156 | 40.26 | 16.12 |

Remarks:

1. Emission Level(dBuV/m) = Raw Value(dBuV) + Correction Factor(dB/m)
2. Correction Factor(dB/m) = Antenna Factor(dB/m) + Cable Factor(dB) – Pre-Amplifier Factor(dB)
3. Margin value = Emission Level – Limit value
4. The other emission levels were very low against the limit.
5. " * ": Fundamental frequency.
6. " # ": The radiated frequency is out of the restricted band.

| | | | |
|------------------------|---------------------|--------------------------|---------------------------|
| RF Mode | TX 802.11ax (20MHz) | Channel | CH 48 : 5240 MHz |
| Frequency Range | 1GHz ~ 40GHz | Detector Function | Peak (PK) Average (AV) |

Antenna Polarity & Test Distance : Horizontal at 3 m

| No | Frequency (MHz) | Emission Level (dBuV/m) | Limit (dBuV/m) | Margin (dB) | Antenna Height (m) | Table Angle (Degree) | Raw Value (dBuV) | Correction Factor (dB/m) |
|----|-----------------|-------------------------|----------------|-------------|--------------------|----------------------|------------------|--------------------------|
| 1 | *5240.00 | 123.08 PK | | | 2.76 H | 316 | 113.07 | 10.01 |
| 2 | *5240.00 | 112.01 AV | | | 2.76 H | 316 | 102.00 | 10.01 |
| 3 | 5350.00 | 62.58 PK | 74.00 | -11.42 | 2.76 H | 316 | 51.90 | 10.68 |
| 4 | 5350.00 | 51.76 AV | 54.00 | -2.24 | 2.76 H | 316 | 41.08 | 10.68 |
| 5 | #10480.00 | 57.35 PK | 68.20 | -10.85 | 1.47 H | 114 | 41.32 | 16.03 |

Antenna Polarity & Test Distance : Vertical at 3 m

| No | Frequency (MHz) | Emission Level (dBuV/m) | Limit (dBuV/m) | Margin (dB) | Antenna Height (m) | Table Angle (Degree) | Raw Value (dBuV) | Correction Factor (dB/m) |
|----|-----------------|-------------------------|----------------|-------------|--------------------|----------------------|------------------|--------------------------|
| 1 | *5240.00 | 122.55 PK | | | 1.44 V | 42 | 112.54 | 10.01 |
| 2 | *5240.00 | 111.27 AV | | | 1.44 V | 42 | 101.26 | 10.01 |
| 3 | 5350.00 | 61.93 PK | 74.00 | -12.07 | 1.44 V | 42 | 51.25 | 10.68 |
| 4 | 5350.00 | 51.23 AV | 54.00 | -2.77 | 1.44 V | 42 | 40.55 | 10.68 |
| 5 | #10480.00 | 56.24 PK | 68.20 | -11.96 | 2.26 V | 285 | 40.21 | 16.03 |

Remarks:

1. Emission Level(dBuV/m) = Raw Value(dBuV) + Correction Factor(dB/m)
2. Correction Factor(dB/m) = Antenna Factor(dB/m) + Cable Factor(dB) – Pre-Amplifier Factor(dB)
3. Margin value = Emission Level – Limit value
4. The other emission levels were very low against the limit.
5. " * " : Fundamental frequency.
6. " # " : The radiated frequency is out of the restricted band.

| | | | |
|------------------------|---------------------|--------------------------|---------------------------|
| RF Mode | TX 802.11ax (20MHz) | Channel | CH 149 : 5745 MHz |
| Frequency Range | 1GHz ~ 40GHz | Detector Function | Peak (PK) Average (AV) |

Antenna Polarity & Test Distance : Horizontal at 3 m

| No | Frequency (MHz) | Emission Level (dBuV/m) | Limit (dBuV/m) | Margin (dB) | Antenna Height (m) | Table Angle (Degree) | Raw Value (dBuV) | Correction Factor (dB/m) |
|----|-----------------|-------------------------|----------------|-------------|--------------------|----------------------|------------------|--------------------------|
| 1 | #5618.87 | 61.73 PK | 68.20 | -6.47 | 2.06 H | 334 | 51.00 | 10.73 |
| 2 | *5745.00 | 121.16 PK | | | 2.06 H | 334 | 110.63 | 10.53 |
| 3 | *5745.00 | 113.08 AV | | | 2.06 H | 334 | 102.55 | 10.53 |
| 4 | #6009.80 | 63.10 PK | 68.20 | -5.10 | 2.06 H | 334 | 52.31 | 10.79 |
| 5 | 11490.00 | 59.19 PK | 74.00 | -14.81 | 1.83 H | 255 | 40.89 | 18.30 |
| 6 | 11490.00 | 48.65 AV | 54.00 | -5.35 | 1.83 H | 255 | 30.35 | 18.30 |

Antenna Polarity & Test Distance : Vertical at 3 m

| No | Frequency (MHz) | Emission Level (dBuV/m) | Limit (dBuV/m) | Margin (dB) | Antenna Height (m) | Table Angle (Degree) | Raw Value (dBuV) | Correction Factor (dB/m) |
|----|-----------------|-------------------------|----------------|-------------|--------------------|----------------------|------------------|--------------------------|
| 1 | #5621.73 | 62.65 PK | 68.20 | -5.55 | 1.50 V | 313 | 51.91 | 10.74 |
| 2 | *5745.00 | 120.33 PK | | | 1.50 V | 313 | 109.80 | 10.53 |
| 3 | *5745.00 | 112.46 AV | | | 1.50 V | 313 | 101.93 | 10.53 |
| 4 | #5986.52 | 62.69 PK | 68.20 | -5.51 | 1.50 V | 313 | 51.96 | 10.73 |
| 5 | 11490.00 | 59.04 PK | 74.00 | -14.96 | 1.13 V | 291 | 40.74 | 18.30 |
| 6 | 11490.00 | 48.51 AV | 54.00 | -5.49 | 1.13 V | 291 | 30.21 | 18.30 |

Remarks:

1. Emission Level(dBuV/m) = Raw Value(dBuV) + Correction Factor(dB/m)
2. Correction Factor(dB/m) = Antenna Factor(dB/m) + Cable Factor(dB) – Pre-Amplifier Factor(dB)
3. Margin value = Emission Level – Limit value
4. The other emission levels were very low against the limit.
5. " * ": Fundamental frequency.
6. " # ": The radiated frequency is out of the restricted band.

| | | | |
|------------------------|---------------------|--------------------------|---------------------------|
| RF Mode | TX 802.11ax (20MHz) | Channel | CH 157 : 5785 MHz |
| Frequency Range | 1GHz ~ 40GHz | Detector Function | Peak (PK) Average (AV) |

Antenna Polarity & Test Distance : Horizontal at 3 m

| No | Frequency (MHz) | Emission Level (dBuV/m) | Limit (dBuV/m) | Margin (dB) | Antenna Height (m) | Table Angle (Degree) | Raw Value (dBuV) | Correction Factor (dB/m) |
|----|-----------------|-------------------------|----------------|-------------|--------------------|----------------------|------------------|--------------------------|
| 1 | #5645.95 | 62.24 PK | 68.20 | -5.96 | 2.00 H | 333 | 51.51 | 10.73 |
| 2 | *5785.00 | 123.79 PK | | | 2.00 H | 333 | 113.34 | 10.45 |
| 3 | *5785.00 | 112.67 AV | | | 2.00 H | 333 | 102.22 | 10.45 |
| 4 | #6006.95 | 62.56 PK | 68.20 | -5.64 | 2.00 H | 333 | 51.77 | 10.79 |
| 5 | 11570.00 | 59.31 PK | 74.00 | -14.69 | 1.88 H | 259 | 40.78 | 18.53 |
| 6 | 11570.00 | 48.84 AV | 54.00 | -5.16 | 1.88 H | 259 | 30.31 | 18.53 |

Antenna Polarity & Test Distance : Vertical at 3 m

| No | Frequency (MHz) | Emission Level (dBuV/m) | Limit (dBuV/m) | Margin (dB) | Antenna Height (m) | Table Angle (Degree) | Raw Value (dBuV) | Correction Factor (dB/m) |
|----|-----------------|-------------------------|----------------|-------------|--------------------|----------------------|------------------|--------------------------|
| 1 | #5554.75 | 63.11 PK | 68.20 | -5.09 | 1.50 V | 304 | 51.98 | 11.13 |
| 2 | *5785.00 | 123.24 PK | | | 1.50 V | 304 | 112.79 | 10.45 |
| 3 | *5785.00 | 112.45 AV | | | 1.50 V | 304 | 102.00 | 10.45 |
| 4 | #5935.70 | 62.83 PK | 68.20 | -5.37 | 1.50 V | 304 | 52.33 | 10.50 |
| 5 | 11570.00 | 59.22 PK | 74.00 | -14.78 | 1.07 V | 295 | 40.69 | 18.53 |
| 6 | 11570.00 | 48.78 AV | 54.00 | -5.22 | 1.07 V | 295 | 30.25 | 18.53 |

Remarks:

1. Emission Level(dBuV/m) = Raw Value(dBuV) + Correction Factor(dB/m)
2. Correction Factor(dB/m) = Antenna Factor(dB/m) + Cable Factor(dB) – Pre-Amplifier Factor(dB)
3. Margin value = Emission Level – Limit value
4. The other emission levels were very low against the limit.
5. " * ": Fundamental frequency.
6. " # ": The radiated frequency is out of the restricted band.

| | | | |
|------------------------|---------------------|--------------------------|---------------------------|
| RF Mode | TX 802.11ax (20MHz) | Channel | CH 165 : 5825 MHz |
| Frequency Range | 1GHz ~ 40GHz | Detector Function | Peak (PK) Average (AV) |

Antenna Polarity & Test Distance : Horizontal at 3 m

| No | Frequency (MHz) | Emission Level (dBuV/m) | Limit (dBuV/m) | Margin (dB) | Antenna Height (m) | Table Angle (Degree) | Raw Value (dBuV) | Correction Factor (dB/m) |
|----|-----------------|-------------------------|----------------|-------------|--------------------|----------------------|------------------|--------------------------|
| 1 | #5615.09 | 61.38 PK | 68.20 | -6.82 | 2.52 H | 146 | 50.65 | 10.73 |
| 2 | *5825.00 | 121.77 PK | | | 2.52 H | 146 | 111.36 | 10.41 |
| 3 | *5825.00 | 113.83 AV | | | 2.52 H | 146 | 103.42 | 10.41 |
| 4 | #5958.71 | 62.33 PK | 68.20 | -5.87 | 2.52 H | 146 | 51.73 | 10.60 |
| 5 | 11650.00 | 59.43 PK | 74.00 | -14.57 | 1.47 H | 129 | 41.13 | 18.30 |
| 6 | 11650.00 | 48.97 AV | 54.00 | -5.03 | 1.47 H | 129 | 30.67 | 18.30 |

Antenna Polarity & Test Distance : Vertical at 3 m

| No | Frequency (MHz) | Emission Level (dBuV/m) | Limit (dBuV/m) | Margin (dB) | Antenna Height (m) | Table Angle (Degree) | Raw Value (dBuV) | Correction Factor (dB/m) |
|----|-----------------|-------------------------|----------------|-------------|--------------------|----------------------|------------------|--------------------------|
| 1 | #5615.00 | 61.54 PK | 68.20 | -6.66 | 1.42 V | 339 | 50.82 | 10.72 |
| 2 | *5825.00 | 120.95 PK | | | 1.42 V | 339 | 110.54 | 10.41 |
| 3 | *5825.00 | 113.22 AV | | | 1.42 V | 339 | 102.81 | 10.41 |
| 4 | #5987.11 | 62.73 PK | 68.20 | -5.47 | 1.42 V | 339 | 51.99 | 10.74 |
| 5 | 11650.00 | 58.55 PK | 74.00 | -15.45 | 2.23 V | 216 | 40.25 | 18.30 |
| 6 | 11650.00 | 48.28 AV | 54.00 | -5.72 | 2.23 V | 216 | 29.98 | 18.30 |

Remarks:

1. Emission Level(dBuV/m) = Raw Value(dBuV) + Correction Factor(dB/m)
2. Correction Factor(dB/m) = Antenna Factor(dB/m) + Cable Factor(dB) – Pre-Amplifier Factor(dB)
3. Margin value = Emission Level – Limit value
4. The other emission levels were very low against the limit.
5. " * ": Fundamental frequency.
6. " # ": The radiated frequency is out of the restricted band.

802.11ax (40MHz)

| | | | |
|------------------------|---------------------|--------------------------|---------------------------|
| RF Mode | TX 802.11ax (40MHz) | Channel | CH 38 : 5190 MHz |
| Frequency Range | 1GHz ~ 40GHz | Detector Function | Peak (PK) Average (AV) |

Antenna Polarity & Test Distance : Horizontal at 3 m

| No | Frequency (MHz) | Emission Level (dBuV/m) | Limit (dBuV/m) | Margin (dB) | Antenna Height (m) | Table Angle (Degree) | Raw Value (dBuV) | Correction Factor (dB/m) |
|----|-----------------|-------------------------|----------------|-------------|--------------------|----------------------|------------------|--------------------------|
| 1 | 5150.00 | 63.60 PK | 74.00 | -10.40 | 2.64 H | 330 | 53.89 | 9.71 |
| 2 | 5150.00 | 52.73 AV | 54.00 | -1.27 | 2.64 H | 330 | 43.02 | 9.71 |
| 3 | *5190.00 | 112.03 PK | | | 2.64 H | 330 | 102.24 | 9.79 |
| 4 | *5190.00 | 100.94 AV | | | 2.64 H | 330 | 91.15 | 9.79 |
| 5 | #10380.00 | 57.34 PK | 68.20 | -10.86 | 2.64 H | 330 | 41.23 | 16.11 |

Antenna Polarity & Test Distance : Vertical at 3 m

| No | Frequency (MHz) | Emission Level (dBuV/m) | Limit (dBuV/m) | Margin (dB) | Antenna Height (m) | Table Angle (Degree) | Raw Value (dBuV) | Correction Factor (dB/m) |
|----|-----------------|-------------------------|----------------|-------------|--------------------|----------------------|------------------|--------------------------|
| 1 | 5150.00 | 62.95 PK | 74.00 | -11.05 | 1.45 V | 67 | 52.94 | 10.01 |
| 2 | 5150.00 | 52.76 AV | 54.00 | -1.24 | 1.45 V | 67 | 42.75 | 10.01 |
| 3 | *5190.00 | 111.57 PK | | | 1.45 V | 67 | 101.48 | 10.09 |
| 4 | *5190.00 | 100.45 AV | | | 1.45 V | 67 | 90.36 | 10.09 |
| 5 | #10380.00 | 56.85 PK | 68.20 | -11.35 | 1.87 V | 49 | 40.66 | 16.19 |

Remarks:

1. Emission Level(dBuV/m) = Raw Value(dBuV) + Correction Factor(dB/m)
2. Correction Factor(dB/m) = Antenna Factor(dB/m) + Cable Factor(dB) – Pre-Amplifier Factor(dB)
3. Margin value = Emission Level – Limit value
4. The other emission levels were very low against the limit.
5. " * ": Fundamental frequency.
6. " # ": The radiated frequency is out of the restricted band.

| | | | |
|------------------------|---------------------|--------------------------|---------------------------|
| RF Mode | TX 802.11ax (40MHz) | Channel | CH 46 : 5230 MHz |
| Frequency Range | 1GHz ~ 40GHz | Detector Function | Peak (PK) Average (AV) |

Antenna Polarity & Test Distance : Horizontal at 3 m

| No | Frequency (MHz) | Emission Level (dBuV/m) | Limit (dBuV/m) | Margin (dB) | Antenna Height (m) | Table Angle (Degree) | Raw Value (dBuV) | Correction Factor (dB/m) |
|----|-----------------|-------------------------|----------------|-------------|--------------------|----------------------|------------------|--------------------------|
| 1 | 5150.00 | 66.61 PK | 74.00 | -7.39 | 2.53 H | 323 | 56.90 | 9.71 |
| 2 | 5150.00 | 52.79 AV | 54.00 | -1.21 | 2.53 H | 323 | 43.08 | 9.71 |
| 3 | *5230.00 | 119.02 PK | | | 2.53 H | 323 | 109.06 | 9.96 |
| 4 | *5230.00 | 109.09 AV | | | 2.53 H | 323 | 99.13 | 9.96 |
| 5 | 5350.00 | 62.81 PK | 74.00 | -11.19 | 2.53 H | 323 | 52.13 | 10.68 |
| 6 | 5350.00 | 52.01 AV | 54.00 | -1.99 | 2.53 H | 323 | 41.33 | 10.68 |
| 7 | #10460.00 | 57.38 PK | 68.20 | -10.82 | 1.55 H | 231 | 41.33 | 16.05 |

Antenna Polarity & Test Distance : Vertical at 3 m

| No | Frequency (MHz) | Emission Level (dBuV/m) | Limit (dBuV/m) | Margin (dB) | Antenna Height (m) | Table Angle (Degree) | Raw Value (dBuV) | Correction Factor (dB/m) |
|----|-----------------|-------------------------|----------------|-------------|--------------------|----------------------|------------------|--------------------------|
| 1 | 5150.00 | 65.18 PK | 74.00 | -8.82 | 1.47 V | 55 | 55.47 | 9.71 |
| 2 | 5150.00 | 52.25 AV | 54.00 | -1.75 | 1.47 V | 55 | 42.54 | 9.71 |
| 3 | *5230.00 | 118.58 PK | | | 1.47 V | 55 | 108.62 | 9.96 |
| 4 | *5230.00 | 108.69 AV | | | 1.47 V | 55 | 98.73 | 9.96 |
| 5 | 5350.00 | 62.52 PK | 74.00 | -11.48 | 1.47 V | 55 | 51.84 | 10.68 |
| 6 | 5350.00 | 51.81 AV | 54.00 | -2.19 | 1.47 V | 55 | 41.13 | 10.68 |
| 7 | #10460.00 | 56.23 PK | 68.20 | -11.97 | 1.89 V | 65 | 40.18 | 16.05 |

Remarks:

1. Emission Level(dBuV/m) = Raw Value(dBuV) + Correction Factor(dB/m)
2. Correction Factor(dB/m) = Antenna Factor(dB/m) + Cable Factor(dB) – Pre-Amplifier Factor(dB)
3. Margin value = Emission Level – Limit value
4. The other emission levels were very low against the limit.
5. " * ": Fundamental frequency.
6. " # ": The radiated frequency is out of the restricted band.

| | | | |
|------------------------|---------------------|--------------------------|---------------------------|
| RF Mode | TX 802.11ax (40MHz) | Channel | CH 151 : 5755 MHz |
| Frequency Range | 1GHz ~ 40GHz | Detector Function | Peak (PK) Average (AV) |

Antenna Polarity & Test Distance : Horizontal at 3 m

| No | Frequency (MHz) | Emission Level (dBuV/m) | Limit (dBuV/m) | Margin (dB) | Antenna Height (m) | Table Angle (Degree) | Raw Value (dBuV) | Correction Factor (dB/m) |
|----|-----------------|-------------------------|----------------|-------------|--------------------|----------------------|------------------|--------------------------|
| 1 | #5606.30 | 62.25 PK | 68.20 | -5.95 | 2.32 H | 330 | 51.52 | 10.73 |
| 2 | *5755.00 | 121.28 PK | | | 2.32 H | 330 | 110.78 | 10.50 |
| 3 | *5755.00 | 113.14 AV | | | 2.32 H | 330 | 102.64 | 10.50 |
| 4 | #5954.58 | 62.57 PK | 68.20 | -5.63 | 2.32 H | 330 | 51.98 | 10.59 |
| 5 | 11510.00 | 58.89 PK | 74.00 | -15.11 | 1.59 H | 284 | 40.52 | 18.37 |
| 6 | 11510.00 | 48.92 AV | 54.00 | -5.08 | 1.59 H | 284 | 30.55 | 18.37 |

Antenna Polarity & Test Distance : Vertical at 3 m

| No | Frequency (MHz) | Emission Level (dBuV/m) | Limit (dBuV/m) | Margin (dB) | Antenna Height (m) | Table Angle (Degree) | Raw Value (dBuV) | Correction Factor (dB/m) |
|----|-----------------|-------------------------|----------------|-------------|--------------------|----------------------|------------------|--------------------------|
| 1 | #5641.03 | 62.90 PK | 68.20 | -5.30 | 1.52 V | 346 | 52.17 | 10.73 |
| 2 | *5755.00 | 119.49 PK | | | 1.52 V | 346 | 108.99 | 10.50 |
| 3 | *5755.00 | 111.72 AV | | | 1.52 V | 346 | 101.22 | 10.50 |
| 4 | #6004.37 | 64.09 PK | 68.20 | -4.11 | 1.52 V | 346 | 53.29 | 10.80 |
| 5 | 11510.00 | 58.26 PK | 74.00 | -15.74 | 2.41 V | 51 | 39.89 | 18.37 |
| 6 | 11510.00 | 48.24 AV | 54.00 | -5.76 | 2.41 V | 51 | 29.87 | 18.37 |

Remarks:

1. Emission Level(dBuV/m) = Raw Value(dBuV) + Correction Factor(dB/m)
2. Correction Factor(dB/m) = Antenna Factor(dB/m) + Cable Factor(dB) – Pre-Amplifier Factor(dB)
3. Margin value = Emission Level – Limit value
4. The other emission levels were very low against the limit.
5. " * ": Fundamental frequency.
6. " # ": The radiated frequency is out of the restricted band.

| | | | |
|------------------------|---------------------|--------------------------|---------------------------|
| RF Mode | TX 802.11ax (40MHz) | Channel | CH 159 : 5795 MHz |
| Frequency Range | 1GHz ~ 40GHz | Detector Function | Peak (PK) Average (AV) |

Antenna Polarity & Test Distance : Horizontal at 3 m

| No | Frequency (MHz) | Emission Level (dBuV/m) | Limit (dBuV/m) | Margin (dB) | Antenna Height (m) | Table Angle (Degree) | Raw Value (dBuV) | Correction Factor (dB/m) |
|----|-----------------|-------------------------|----------------|-------------|--------------------|----------------------|------------------|--------------------------|
| 1 | #5639.03 | 61.33 PK | 68.20 | -6.87 | 1.39 H | 147 | 50.60 | 10.73 |
| 2 | *5795.00 | 120.20 PK | | | 1.39 H | 147 | 109.76 | 10.44 |
| 3 | *5795.00 | 112.02 AV | | | 1.39 H | 147 | 101.58 | 10.44 |
| 4 | #5931.66 | 62.37 PK | 68.20 | -5.83 | 1.39 H | 147 | 51.89 | 10.48 |
| 5 | 11590.00 | 59.70 PK | 74.00 | -14.30 | 2.03 H | 196 | 41.12 | 18.58 |
| 6 | 11590.00 | 48.84 AV | 54.00 | -5.16 | 2.03 H | 196 | 30.26 | 18.58 |

Antenna Polarity & Test Distance : Vertical at 3 m

| No | Frequency (MHz) | Emission Level (dBuV/m) | Limit (dBuV/m) | Margin (dB) | Antenna Height (m) | Table Angle (Degree) | Raw Value (dBuV) | Correction Factor (dB/m) |
|----|-----------------|-------------------------|----------------|-------------|--------------------|----------------------|------------------|--------------------------|
| 1 | #5559.45 | 63.33 PK | 68.20 | -4.87 | 1.58 V | 267 | 52.24 | 11.09 |
| 2 | *5795.00 | 110.90 PK | | | 1.58 V | 267 | 100.46 | 10.44 |
| 3 | *5795.00 | 100.60 AV | | | 1.58 V | 267 | 90.16 | 10.44 |
| 4 | #5941.22 | 62.69 PK | 68.20 | -5.51 | 1.58 V | 267 | 52.16 | 10.53 |
| 5 | 11590.00 | 58.61 PK | 74.00 | -15.39 | 2.25 V | 175 | 40.03 | 18.58 |
| 6 | 11590.00 | 48.24 AV | 54.00 | -5.76 | 2.25 V | 175 | 29.66 | 18.58 |

Remarks:

1. Emission Level(dBuV/m) = Raw Value(dBuV) + Correction Factor(dB/m)
2. Correction Factor(dB/m) = Antenna Factor(dB/m) + Cable Factor(dB) – Pre-Amplifier Factor(dB)
3. Margin value = Emission Level – Limit value
4. The other emission levels were very low against the limit.
5. " * ": Fundamental frequency.
6. " # ": The radiated frequency is out of the restricted band.

802.11ax (80MHz)

| | | | |
|------------------------|---------------------|--------------------------|---------------------------|
| RF Mode | TX 802.11ax (80MHz) | Channel | CH 42 : 5210 MHz |
| Frequency Range | 1GHz ~ 40GHz | Detector Function | Peak (PK) Average (AV) |

| Antenna Polarity & Test Distance : Horizontal at 3 m | | | | | | | | |
|--|-----------------|-------------------------|----------------|-------------|--------------------|----------------------|------------------|--------------------------|
| No | Frequency (MHz) | Emission Level (dBuV/m) | Limit (dBuV/m) | Margin (dB) | Antenna Height (m) | Table Angle (Degree) | Raw Value (dBuV) | Correction Factor (dB/m) |
| 1 | 5150.00 | 63.24 PK | 74.00 | -10.76 | 2.74 H | 320 | 53.53 | 9.71 |
| 2 | 5150.00 | 52.72 AV | 54.00 | -1.28 | 2.74 H | 320 | 43.01 | 9.71 |
| 3 | *5210.00 | 107.82 PK | | | 2.74 H | 320 | 97.97 | 9.85 |
| 4 | *5210.00 | 96.87 AV | | | 2.74 H | 320 | 87.02 | 9.85 |
| 5 | 5350.00 | 62.34 PK | 74.00 | -11.66 | 2.74 H | 320 | 51.66 | 10.68 |
| 6 | 5350.00 | 51.34 AV | 54.00 | -2.66 | 2.74 H | 320 | 40.66 | 10.68 |
| 7 | #10420.00 | 57.53 PK | 68.20 | -10.67 | 1.66 H | 251 | 41.44 | 16.09 |

| Antenna Polarity & Test Distance : Vertical at 3 m | | | | | | | | |
|--|-----------------|-------------------------|----------------|--------------|--------------------|----------------------|------------------|--------------------------|
| No | Frequency (MHz) | Emission Level (dBuV/m) | Limit (dBuV/m) | Margin (dB) | Antenna Height (m) | Table Angle (Degree) | Raw Value (dBuV) | Correction Factor (dB/m) |
| 1 | 5150.00 | 62.73 PK | 74.00 | -11.27 | 1.52 V | 61 | 53.02 | 9.71 |
| 2 | 5150.00 | 52.81 AV | 54.00 | -1.19 | 1.52 V | 61 | 43.10 | 9.71 |
| 3 | *5210.00 | 107.01 PK | | | 1.52 V | 61 | 97.16 | 9.85 |
| 4 | *5210.00 | 96.31 AV | | | 1.52 V | 61 | 86.46 | 9.85 |
| 5 | 5350.00 | 61.92 PK | 74.00 | -12.08 | 1.52 V | 61 | 51.24 | 10.68 |
| 6 | 5350.00 | 51.01 AV | 54.00 | -2.99 | 1.52 V | 61 | 40.33 | 10.68 |
| 7 | #10420.00 | 56.31 PK | 68.20 | -11.89 | 1.88 V | 201 | 40.22 | 16.09 |

Remarks:

1. Emission Level(dBuV/m) = Raw Value(dBuV) + Correction Factor(dB/m)
2. Correction Factor(dB/m) = Antenna Factor(dB/m) + Cable Factor(dB) – Pre-Amplifier Factor(dB)
3. Margin value = Emission Level – Limit value
4. The other emission levels were very low against the limit.
5. " * ": Fundamental frequency.
6. " # ": The radiated frequency is out of the restricted band.

| | | | |
|------------------------|---------------------|--------------------------|---------------------------|
| RF Mode | TX 802.11ax (80MHz) | Channel | CH 155 : 5775 MHz |
| Frequency Range | 1GHz ~ 40GHz | Detector Function | Peak (PK) Average (AV) |

Antenna Polarity & Test Distance : Horizontal at 3 m

| No | Frequency (MHz) | Emission Level (dBuV/m) | Limit (dBuV/m) | Margin (dB) | Antenna Height (m) | Table Angle (Degree) | Raw Value (dBuV) | Correction Factor (dB/m) |
|----|-----------------|-------------------------|----------------|-------------|--------------------|----------------------|------------------|--------------------------|
| 1 | #5645.55 | 64.68 PK | 68.20 | -3.52 | 2.13 H | 323 | 53.95 | 10.73 |
| 2 | *5775.00 | 113.94 PK | | | 2.13 H | 323 | 103.46 | 10.48 |
| 3 | *5775.00 | 106.36 AV | | | 2.13 H | 323 | 95.88 | 10.48 |
| 4 | #5966.99 | 62.40 PK | 68.20 | -5.80 | 2.13 H | 323 | 51.75 | 10.65 |
| 5 | 11550.00 | 59.04 PK | 74.00 | -14.96 | 1.69 H | 230 | 40.57 | 18.47 |
| 6 | 11550.00 | 49.16 AV | 54.00 | -4.84 | 1.69 H | 230 | 30.69 | 18.47 |

Antenna Polarity & Test Distance : Vertical at 3 m

| No | Frequency (MHz) | Emission Level (dBuV/m) | Limit (dBuV/m) | Margin (dB) | Antenna Height (m) | Table Angle (Degree) | Raw Value (dBuV) | Correction Factor (dB/m) |
|----|-----------------|-------------------------|----------------|-------------|--------------------|----------------------|------------------|--------------------------|
| 1 | #5646.18 | 63.85 PK | 68.20 | -4.35 | 1.67 V | 357 | 53.13 | 10.72 |
| 2 | *5775.00 | 112.63 PK | | | 1.67 V | 357 | 102.15 | 10.48 |
| 3 | *5775.00 | 105.16 AV | | | 1.67 V | 357 | 94.68 | 10.48 |
| 4 | #5964.19 | 63.65 PK | 68.20 | -4.55 | 1.67 V | 357 | 53.02 | 10.63 |
| 5 | 11550.00 | 58.63 PK | 74.00 | -15.37 | 1.74 V | 128 | 40.16 | 18.47 |
| 6 | 11550.00 | 51.70 AV | 54.00 | -2.30 | 1.74 V | 128 | 33.23 | 18.47 |

Remarks:

1. Emission Level(dBuV/m) = Raw Value(dBuV) + Correction Factor(dB/m)
2. Correction Factor(dB/m) = Antenna Factor(dB/m) + Cable Factor(dB) – Pre-Amplifier Factor(dB)
3. Margin value = Emission Level – Limit value
4. The other emission levels were very low against the limit.
5. " * ": Fundamental frequency.
6. " # ": The radiated frequency is out of the restricted band.

Below 1GHz Worst-Case Data:

CDD Mode

802.11ax (20MHz)

| | | | |
|------------------------|---------------------|--------------------------|-------------------|
| RF Mode | TX 802.11ax (20MHz) | Channel | CH 157 : 5785 MHz |
| Frequency Range | 9kHz ~ 1GHz | Detector Function | Quasi-Peak (QP) |

| Antenna Polarity & Test Distance : Horizontal at 3 m | | | | | | | | |
|--|-----------------|-------------------------|----------------|-------------|--------------------|----------------------|------------------|--------------------------|
| No | Frequency (MHz) | Emission Level (dBuV/m) | Limit (dBuV/m) | Margin (dB) | Antenna Height (m) | Table Angle (Degree) | Raw Value (dBuV) | Correction Factor (dB/m) |
| 1 | 43.29 | 23.85 QP | 40.00 | -16.15 | 1.46 H | 33 | 31.36 | -7.51 |
| 2 | 128.21 | 22.30 QP | 43.50 | -21.20 | 1.27 H | 214 | 30.59 | -8.29 |
| 3 | 211.20 | 23.13 QP | 43.50 | -20.37 | 1.89 H | 268 | 32.03 | -8.90 |
| 4 | 310.43 | 26.81 QP | 46.00 | -19.19 | 1.63 H | 228 | 30.89 | -4.08 |
| 5 | 443.32 | 27.21 QP | 46.00 | -18.79 | 2.37 H | 268 | 28.17 | -0.96 |
| 6 | 597.79 | 30.98 QP | 46.00 | -15.02 | 1.85 H | 178 | 28.75 | 2.23 |

Remarks:

1. Emission Level(dBuV/m) = Raw Value(dBuV) + Correction Factor(dB/m)
2. Correction Factor(dB/m) = Antenna Factor(dB/m) + Cable Factor(dB) – Pre-Amplifier Factor(dB)
3. Margin value = Emission Level – Limit value
4. The other emission levels were very low against the limit of frequency range 30MHz~1000MHz.
5. The emission levels were very low against the limit of frequency range 9kHz~30MHz: the amplitude of spurious emissions attenuated more than 20 dB below the permissible value to be report.

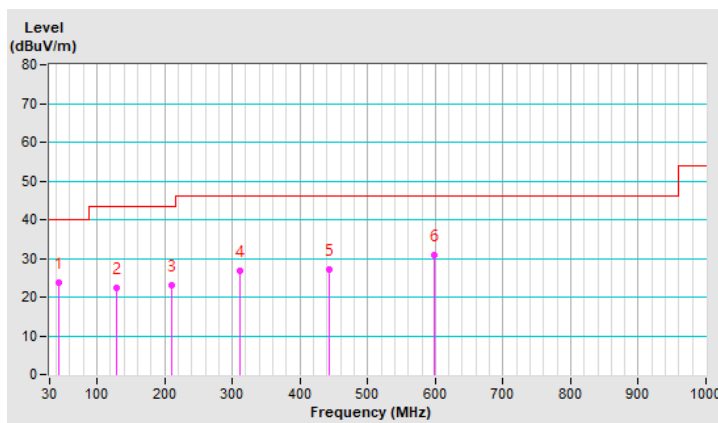

| | | | |
|------------------------|---------------------|--------------------------|-------------------|
| RF Mode | TX 802.11ax (20MHz) | Channel | CH 157 : 5785 MHz |
| Frequency Range | 9kHz ~ 1GHz | Detector Function | Quasi-Peak (QP) |

| Antenna Polarity & Test Distance : Vertical at 3 m | | | | | | | | |
|--|-----------------|-------------------------|----------------|-------------|--------------------|----------------------|------------------|--------------------------|
| No | Frequency (MHz) | Emission Level (dBuV/m) | Limit (dBuV/m) | Margin (dB) | Antenna Height (m) | Table Angle (Degree) | Raw Value (dBuV) | Correction Factor (dB/m) |
| 1 | 42.85 | 32.23 QP | 40.00 | -7.77 | 1.54 V | 259 | 39.75 | -7.52 |
| 2 | 83.59 | 27.60 QP | 40.00 | -12.40 | 1.34 V | 276 | 39.91 | -12.31 |
| 3 | 131.12 | 27.27 QP | 43.50 | -16.23 | 1.27 V | 208 | 35.27 | -8.00 |
| 4 | 167.98 | 25.34 QP | 43.50 | -18.16 | 1.94 V | 261 | 32.04 | -6.70 |
| 5 | 342.39 | 30.23 QP | 46.00 | -15.77 | 1.28 V | 268 | 33.66 | -3.43 |
| 6 | 591.58 | 31.27 QP | 46.00 | -14.73 | 1.71 V | 227 | 29.15 | 2.12 |

Remarks:

1. Emission Level(dBuV/m) = Raw Value(dBuV) + Correction Factor(dB/m)
2. Correction Factor(dB/m) = Antenna Factor(dB/m) + Cable Factor(dB) – Pre-Amplifier Factor(dB)
3. Margin value = Emission Level – Limit value
4. The other emission levels were very low against the limit of frequency range 30MHz~1000MHz.
5. The emission levels were very low against the limit of frequency range 9kHz~30MHz: the amplitude of spurious emissions attenuated more than 20 dB below the permissible value to be report.

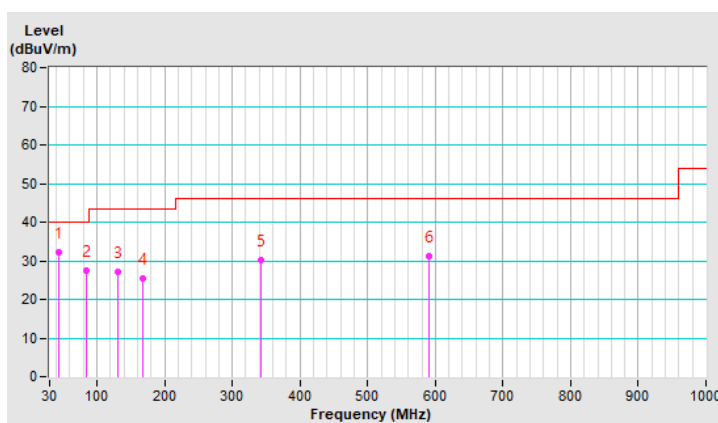

4.2 Conducted Emission Measurement

4.2.1 Limits of Conducted Emission Measurement

| Frequency (MHz) | Conducted Limit (dBuV) | |
|-----------------|------------------------|---------|
| | Quasi-peak | Average |
| 0.15 - 0.5 | 66 - 56 | 56 - 46 |
| 0.50 - 5.0 | 56 | 46 |
| 5.0 - 30.0 | 60 | 50 |

Note: 1. The lower limit shall apply at the transition frequencies.

2. The limit decreases in line with the logarithm of the frequency in the range of 0.15 to 0.50MHz.

4.2.2 Test Instruments

| Description & Manufacturer | Model No. | Serial No. | Cal. Date | Cal. Due |
|--|---------------|--------------|---------------|---------------|
| ROHDE & SCHWARZ TEST RECEIVER | ESCS30 | 100276 | Apr. 16, 2020 | Apr. 15, 2021 |
| R&S Artificial Mains Network (for EUT) | ENV216 | 101196 | Apr. 20, 2020 | Apr. 19, 2021 |
| LISN With Adapter (for EUT) | 101196 | NA | Apr. 20, 2020 | Apr. 19, 2021 |
| R&S Artificial Mains Network (for peripheral) | ESH3-Z5 | 100220 | Dec. 1, 2020 | Nov. 30, 2021 |
| Software | Cond_V7.3.7.4 | NA | NA | NA |
| RF cable (JYEBAO) With 10dB PAD | 5D-FB | Cable-C05.01 | Jan. 30, 2020 | Jan. 29, 2021 |
| LYNICS Terminator (For R&S LISN) | 0900510 | E1-01-305 | Feb. 17, 2020 | Feb. 16, 2021 |

Note: 1. The calibration interval of the above test instruments is 12 months and the calibrations are traceable to NML/ROC and NIST/USA.

2. The test was performed in Shielded Room No. 5. (Conduction 5)

4.2.3 Test Procedures

- The EUT was placed 0.4 meters from the conducting wall of the shielded room with EUT being connected to the power mains through a line impedance stabilization network (LISN). Other support units were connected to the power mains through another LISN. The two LISNs provide 50 ohm/ 50uH of coupling impedance for the measuring instrument.
- Both lines of the power mains connected to the EUT were checked for maximum conducted interference.
- The frequency range from 150kHz to 30MHz was searched. Emission levels under (Limit - 20dB) was not recorded.

Note: The resolution bandwidth and video bandwidth of test receiver is 9kHz for quasi-peak detection (QP) and average detection (AV) at frequency 0.15MHz-30MHz.

4.2.4 Deviation from Test Standard

No deviation.

4.2.5 Test Setup

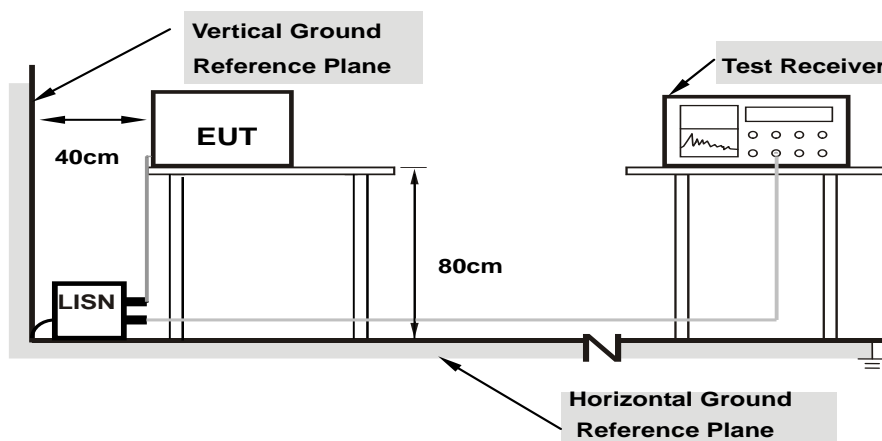

Note: 1.Support units were connected to second LISN.

For the actual test configuration, please refer to the attached file (Test Setup Photo).

4.2.6 EUT Operating Conditions

Same as 4.1.6.

4.2.7 Test Results

CDD Mode

802.11ax (20MHz)

| Phase | Line (L) | Detector Function | Quasi-Peak (QP) / Average (AV) |
|-------|----------|-------------------|--------------------------------|
|-------|----------|-------------------|--------------------------------|

| No | Freq. [MHz] | Corr. Factor (dB) | Reading Value | | Emission Level | | Limit | | Margin | |
|----------|----------------|-------------------------|---------------|--------------|----------------|--------------|--------------|--------------|---------------|---------------|
| | | | [dB (uV)] | | [dB (uV)] | | [dB (uV)] | | (dB) | |
| | | | Q.P. | AV. | Q.P. | AV. | Q.P. | AV. | Q.P. | AV. |
| 1 | 0.15781 | 19.49 | 28.78 | 11.95 | 48.27 | 31.44 | 65.58 | 55.58 | -17.31 | -24.14 |
| 2 | 0.20859 | 19.49 | 22.51 | 5.52 | 42.00 | 25.01 | 63.26 | 53.26 | -21.26 | -28.25 |
| 3 | 0.39219 | 19.51 | 19.31 | 15.36 | 38.82 | 34.87 | 58.02 | 48.02 | -19.20 | -13.15 |
| 4 | 0.80234 | 19.54 | 15.26 | 10.12 | 34.80 | 29.66 | 56.00 | 46.00 | -21.20 | -16.34 |
| 5 | 1.28125 | 19.56 | 16.95 | 9.73 | 36.51 | 29.29 | 56.00 | 46.00 | -19.49 | -16.71 |
| 6 | 1.79688 | 19.57 | 19.73 | 11.30 | 39.30 | 30.87 | 56.00 | 46.00 | -16.70 | -15.13 |
| 7 | 13.64844 | 19.98 | 9.00 | 4.45 | 28.98 | 24.43 | 60.00 | 50.00 | -31.02 | -25.57 |

Remarks:

1. Q.P. and AV. are abbreviations of quasi-peak and average individually.
2. The emission levels of other frequencies were very low against the limit.
3. Margin value = Emission level - Limit value
4. Correction factor = Insertion loss + Cable loss
5. Emission Level = Correction Factor + Reading Value.

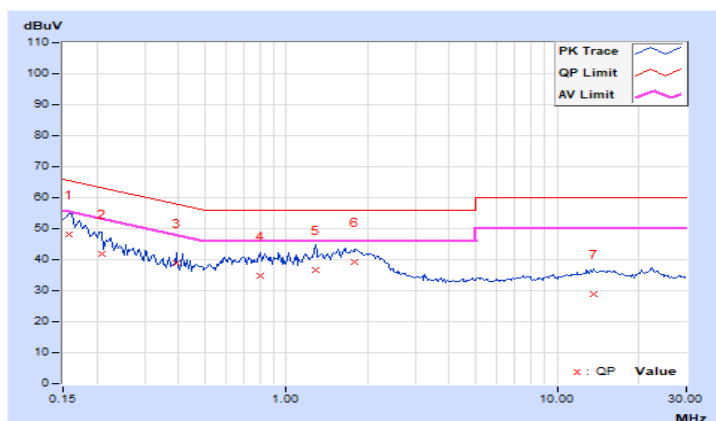

| | | | |
|-------|-------------|-------------------|--------------------------------|
| Phase | Neutral (N) | Detector Function | Quasi-Peak (QP) / Average (AV) |
|-------|-------------|-------------------|--------------------------------|

| No | Freq. [MHz] | Corr. Factor (dB) | Reading Value | | Emission Level | | Limit | | Margin | |
|----|----------------|-------------------------|---------------|------|----------------|-------|-----------|-------|--------|--------|
| | | | [dB (uV)] | | [dB (uV)] | | [dB (uV)] | | (dB) | |
| | | | Q.P. | AV. | Q.P. | AV. | Q.P. | AV. | Q.P. | AV. |
| 1 | 0.16953 | 19.53 | 26.26 | 8.58 | 45.79 | 28.11 | 64.98 | 54.98 | -19.19 | -26.87 |
| 2 | 0.32578 | 19.54 | 14.28 | 4.42 | 33.82 | 23.96 | 59.56 | 49.56 | -25.74 | -25.60 |
| 3 | 0.91953 | 19.57 | 12.71 | 4.73 | 32.28 | 24.30 | 56.00 | 46.00 | -23.72 | -21.70 |
| 4 | 1.77344 | 19.60 | 18.32 | 8.24 | 37.92 | 27.84 | 56.00 | 46.00 | -18.08 | -18.16 |
| 5 | 10.10547 | 19.83 | 8.17 | 2.53 | 28.00 | 22.36 | 60.00 | 50.00 | -32.00 | -27.64 |
| 6 | 22.99609 | 20.18 | 4.87 | 1.06 | 25.05 | 21.24 | 60.00 | 50.00 | -34.95 | -28.76 |

Remarks:

1. Q.P. and AV. are abbreviations of quasi-peak and average individually.
2. The emission levels of other frequencies were very low against the limit.
3. Margin value = Emission level - Limit value
4. Correction factor = Insertion loss + Cable loss
5. Emission Level = Correction Factor + Reading Value.

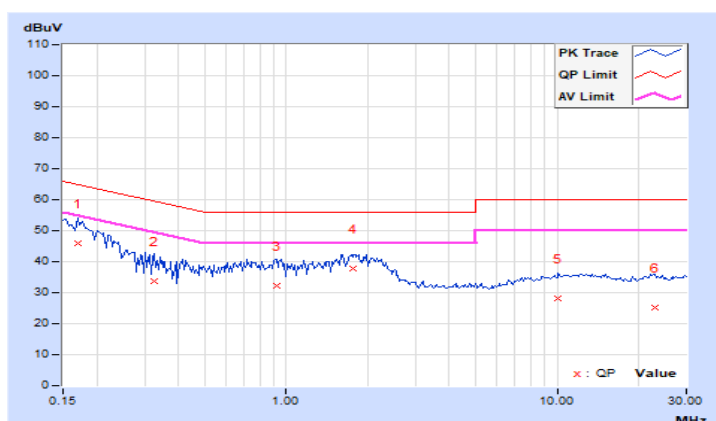

4.3 Transmit Power Measurement

4.3.1 Limits of Transmit Power Measurement

| Operation Band | EUT Category | | Limit |
|----------------|--------------|-----------------------------------|---|
| U-NII-1 | | Outdoor Access Point | 1 Watt (30 dBm) (Max. e.i.r.p \leq 125mW(21 dBm) at any elevation angle above 30 degrees as measured from the horizon) |
| | | Fixed point-to-point Access Point | 1 Watt (30 dBm) |
| | √ | Indoor Access Point | 1 Watt (30 dBm) |
| | | Mobile and Portable client device | 250mW (24 dBm) |
| U-NII-2A | | | 250mW (24 dBm) or 11 dBm+10 log B* |
| U-NII-2C | | | 250mW (24 dBm) or 11 dBm+10 log B* |
| U-NII-3 | √ | | 1 Watt (30 dBm) |

*B is the 26 dB emission bandwidth in megahertz

Per KDB 662911 Method of conducted output power measurement on IEEE 802.11 devices,

Array Gain = 0 dB (i.e., no array gain) for $N_{ANT} \leq 4$;

Array Gain = 0 dB (i.e., no array gain) for channel widths ≥ 40 MHz for any N_{ANT} ;

Array Gain = $5 \log(N_{ANT}/N_{SS})$ dB or 3 dB, whichever is less for 20-MHz channel widths with $N_{ANT} \geq 5$.

For power measurements on all other devices: Array Gain = $10 \log(N_{ANT}/N_{SS})$ dB.

4.3.2 Test Setup

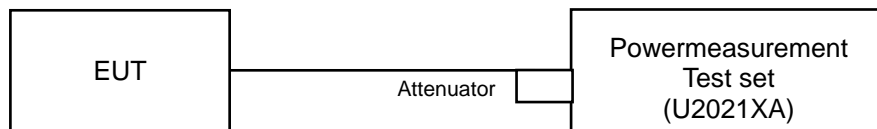

4.3.3 Test Instruments

Refer to section 4.1.2 to get information of above instrument.

4.3.4 Test Procedure

For Average Power Measurement

Method PM is used to perform output power measurement, trigger and gating function of wide band power meter is enabled to measure max output power of TX on burst and set the detector to AVERAGE. Duty factor is not added to measured value.

4.3.5 Deviation from Test Standard

No deviation.

4.3.6 EUT Operating Conditions

The software provided by client to enable the EUT under transmission condition continuously at lowest, middle and highest channel frequencies individually.

4.3.7 Test Result

CDD Mode

802.11a

| Chan. | Freq. (MHz) | Maximum Conducted Power (dBm) | | | | Total Power (mW) | Total Power (dBm) | Power Limit (dBm) | Pass / Fail |
|-------|-------------|-------------------------------|---------|---------|---------|------------------|-------------------|-------------------|-------------|
| | | Chain 0 | Chain 1 | Chain 2 | Chain 3 | | | | |
| 36 | 5180 | 18.62 | 18.11 | 17.91 | 18.50 | 270.088 | 24.32 | 30.00 | Pass |
| 40 | 5200 | 22.01 | 21.34 | 21.29 | 21.83 | 581.990 | 27.65 | 30.00 | Pass |
| 48 | 5240 | 22.09 | 20.66 | 21.71 | 21.96 | 583.509 | 27.66 | 30.00 | Pass |
| 149 | 5745 | 22.54 | 22.04 | 22.68 | 22.18 | 689.979 | 28.39 | 30.00 | Pass |
| 157 | 5785 | 22.63 | 21.96 | 22.57 | 22.19 | 686.562 | 28.37 | 30.00 | Pass |
| 165 | 5825 | 22.58 | 22.11 | 22.49 | 21.96 | 678.144 | 28.31 | 30.00 | Pass |

802.11ac (20MHz)

| Chan. | Freq. (MHz) | Maximum Conducted Power (dBm) | | | | Total Power (mW) | Total Power (dBm) | Power Limit (dBm) | Pass / Fail |
|-------|-------------|-------------------------------|---------|---------|---------|------------------|-------------------|-------------------|-------------|
| | | Chain 0 | Chain 1 | Chain 2 | Chain 3 | | | | |
| 36 | 5180 | 17.76 | 17.18 | 17.10 | 17.32 | 217.180 | 23.37 | 30.00 | Pass |
| 40 | 5200 | 21.72 | 21.23 | 21.29 | 21.61 | 560.796 | 27.49 | 30.00 | Pass |
| 48 | 5240 | 21.80 | 20.30 | 21.23 | 21.59 | 535.459 | 27.29 | 30.00 | Pass |
| 149 | 5745 | 21.30 | 20.86 | 21.13 | 20.71 | 504.274 | 27.03 | 30.00 | Pass |
| 157 | 5785 | 21.10 | 20.74 | 21.22 | 20.61 | 494.916 | 26.95 | 30.00 | Pass |
| 165 | 5825 | 21.05 | 20.82 | 21.14 | 20.47 | 489.578 | 26.90 | 30.00 | Pass |

802.11ac (40MHz)

| Chan. | Freq. (MHz) | Maximum Conducted Power (dBm) | | | | Total Power (mW) | Total Power (dBm) | Power Limit (dBm) | Pass / Fail |
|-------|-------------|-------------------------------|---------|---------|---------|------------------|-------------------|-------------------|-------------|
| | | Chain 0 | Chain 1 | Chain 2 | Chain 3 | | | | |
| 38 | 5190 | 14.75 | 14.16 | 14.18 | 14.59 | 110.871 | 20.45 | 30.00 | Pass |
| 46 | 5230 | 20.97 | 20.31 | 20.66 | 20.75 | 467.688 | 26.70 | 30.00 | Pass |
| 151 | 5755 | 22.07 | 21.20 | 21.42 | 20.72 | 549.598 | 27.40 | 30.00 | Pass |
| 159 | 5795 | 21.87 | 21.24 | 21.29 | 20.88 | 543.909 | 27.36 | 30.00 | Pass |

802.11ac (80MHz)

| Chan. | Freq. (MHz) | Maximum Conducted Power (dBm) | | | | Total Power (mW) | Total Power (dBm) | Power Limit (dBm) | Pass / Fail |
|-------|-------------|-------------------------------|---------|---------|---------|------------------|-------------------|-------------------|-------------|
| | | Chain 0 | Chain 1 | Chain 2 | Chain 3 | | | | |
| 42 | 5210 | 14.14 | 13.98 | 14.06 | 13.82 | 100.513 | 20.02 | 30.00 | Pass |
| 155 | 5775 | 19.94 | 19.23 | 19.26 | 18.82 | 342.922 | 25.35 | 30.00 | Pass |

802.11ax (20MHz)

| Chan. | Freq. (MHz) | Maximum Conducted Power (dBm) | | | | Total Power (mW) | Total Power (dBm) | Power Limit (dBm) | Pass / Fail |
|-------|-------------|-------------------------------|---------|---------|---------|------------------|-------------------|-------------------|-------------|
| | | Chain 0 | Chain 1 | Chain 2 | Chain 3 | | | | |
| 36 | 5180 | 18.44 | 17.79 | 17.74 | 18.00 | 252.466 | 24.02 | 30.00 | Pass |
| 40 | 5200 | 22.39 | 21.86 | 21.96 | 22.30 | 653.703 | 28.15 | 30.00 | Pass |
| 48 | 5240 | 22.59 | 21.20 | 22.02 | 22.32 | 643.206 | 28.08 | 30.00 | Pass |
| 149 | 5745 | 21.98 | 21.48 | 21.77 | 21.32 | 584.199 | 27.67 | 30.00 | Pass |
| 157 | 5785 | 21.71 | 21.38 | 21.87 | 21.26 | 573.131 | 27.58 | 30.00 | Pass |
| 165 | 5825 | 21.69 | 21.45 | 21.82 | 21.15 | 569.579 | 27.56 | 30.00 | Pass |

802.11ax (40MHz)

| Chan. | Freq. (MHz) | Maximum Conducted Power (dBm) | | | | Total Power (mW) | Total Power (dBm) | Power Limit (dBm) | Pass / Fail |
|-------|-------------|-------------------------------|---------|---------|---------|------------------|-------------------|-------------------|-------------|
| | | Chain 0 | Chain 1 | Chain 2 | Chain 3 | | | | |
| 38 | 5190 | 15.43 | 14.86 | 14.98 | 15.13 | 129.595 | 21.13 | 30.00 | Pass |
| 46 | 5230 | 21.63 | 20.97 | 21.33 | 21.44 | 545.719 | 27.37 | 30.00 | Pass |
| 151 | 5755 | 22.68 | 21.89 | 22.04 | 21.39 | 637.555 | 28.05 | 30.00 | Pass |
| 159 | 5795 | 22.55 | 21.92 | 21.93 | 21.52 | 633.345 | 28.02 | 30.00 | Pass |

802.11ax (80MHz)

| Chan. | Freq. (MHz) | Maximum Conducted Power (dBm) | | | | Total Power (mW) | Total Power (dBm) | Power Limit (dBm) | Pass / Fail |
|-------|-------------|-------------------------------|---------|---------|---------|------------------|-------------------|-------------------|-------------|
| | | Chain 0 | Chain 1 | Chain 2 | Chain 3 | | | | |
| 42 | 5210 | 14.79 | 14.38 | 14.65 | 14.28 | 113.512 | 20.55 | 30.00 | Pass |
| 155 | 5775 | 20.56 | 19.85 | 19.87 | 19.46 | 395.727 | 25.97 | 30.00 | Pass |

Beamforming Mode

802.11ac (20MHz)

| Chan. | Freq. (MHz) | Maximum Conducted Power (dBm) | | | | Total Power (mW) | Total Power (dBm) | Power Limit (dBm) | Pass / Fail |
|-------|-------------|-------------------------------|---------|---------|---------|------------------|-------------------|-------------------|-------------|
| | | Chain 0 | Chain 1 | Chain 2 | Chain 3 | | | | |
| 36 | 5180 | 17.76 | 17.18 | 17.10 | 17.32 | 217.180 | 23.37 | 27.99 | Pass |
| 40 | 5200 | 21.37 | 20.88 | 20.96 | 21.25 | 517.640 | 27.14 | 27.99 | Pass |
| 48 | 5240 | 21.43 | 19.96 | 20.91 | 21.27 | 495.357 | 26.95 | 27.99 | Pass |
| 149 | 5745 | 20.63 | 20.20 | 20.43 | 20.14 | 434.008 | 26.37 | 27.24 | Pass |
| 157 | 5785 | 20.45 | 20.07 | 20.60 | 19.97 | 426.669 | 26.30 | 27.24 | Pass |
| 165 | 5825 | 20.38 | 20.19 | 20.56 | 19.88 | 424.654 | 26.28 | 27.24 | Pass |

Note:

For 5180~5240MHz: Directional gain = $10 \log[(10^{G1/20} + 10^{G2/20} + \dots + 10^{GN/20})^2/4]$ = 8.01dBi > 6dBi, so the power limit shall be reduced to $30 - (8.01 - 6) = 27.99$ dBm.

For 5745~5825MHz: Directional gain = $10 \log[(10^{G1/20} + 10^{G2/20} + \dots + 10^{GN/20})^2/4]$ = 8.76dBi > 6dBi, so the power limit shall be reduced to $30 - (8.76 - 6) = 27.24$ dBm.

802.11ac (40MHz)

| Chan. | Freq. (MHz) | Maximum Conducted Power (dBm) | | | | Total Power (mW) | Total Power (dBm) | Power Limit (dBm) | Pass / Fail |
|-------|-------------|-------------------------------|---------|---------|---------|------------------|-------------------|-------------------|-------------|
| | | Chain 0 | Chain 1 | Chain 2 | Chain 3 | | | | |
| 38 | 5190 | 14.75 | 14.16 | 14.18 | 14.59 | 110.871 | 20.45 | 27.99 | Pass |
| 46 | 5230 | 20.97 | 20.31 | 20.66 | 20.75 | 467.688 | 26.70 | 27.99 | Pass |
| 151 | 5755 | 21.17 | 20.32 | 20.58 | 19.72 | 446.609 | 26.50 | 27.24 | Pass |
| 159 | 5795 | 21.07 | 20.34 | 20.42 | 20.03 | 446.929 | 26.50 | 27.24 | Pass |

Note:

For 5180~5240MHz: Directional gain = $10 \log[(10^{G1/20} + 10^{G2/20} + \dots + 10^{GN/20})^2/4]$ = 8.01dBi > 6dBi, so the power limit shall be reduced to $30 - (8.01 - 6) = 27.99$ dBm.

For 5745~5825MHz: Directional gain = $10 \log[(10^{G1/20} + 10^{G2/20} + \dots + 10^{GN/20})^2/4]$ = 8.76dBi > 6dBi, so the power limit shall be reduced to $30 - (8.76 - 6) = 27.24$ dBm.

802.11ac (80MHz)

| Chan. | Freq. (MHz) | Maximum Conducted Power (dBm) | | | | Total Power (mW) | Total Power (dBm) | Power Limit (dBm) | Pass / Fail |
|-------|-------------|-------------------------------|---------|---------|---------|------------------|-------------------|-------------------|-------------|
| | | Chain 0 | Chain 1 | Chain 2 | Chain 3 | | | | |
| 42 | 5210 | 14.14 | 13.98 | 14.06 | 13.82 | 100.513 | 20.02 | 27.99 | Pass |
| 155 | 5775 | 19.94 | 19.23 | 19.26 | 18.82 | 342.922 | 25.35 | 27.24 | Pass |

Note:

For 5180~5240MHz: Directional gain = $10 \log[(10^{G1/20} + 10^{G2/20} + \dots + 10^{GN/20})^2/4]$ = 8.01dBi > 6dBi, so the power limit shall be reduced to $30 - (8.01 - 6) = 27.99$ dBm.

For 5745~5825MHz: Directional gain = $10 \log[(10^{G1/20} + 10^{G2/20} + \dots + 10^{GN/20})^2/4]$ = 8.76dBi > 6dBi, so the power limit shall be reduced to $30 - (8.76 - 6) = 27.24$ dBm.

802.11ax (20MHz)

| Chan. | Freq. (MHz) | Maximum Conducted Power (dBm) | | | | Total Power (mW) | Total Power (dBm) | Power Limit (dBm) | Pass / Fail |
|-------|-------------|-------------------------------|---------|---------|---------|------------------|-------------------|-------------------|-------------|
| | | Chain 0 | Chain 1 | Chain 2 | Chain 3 | | | | |
| 36 | 5180 | 18.44 | 17.79 | 17.74 | 18.00 | 252.466 | 24.02 | 27.99 | Pass |
| 40 | 5200 | 22.03 | 21.48 | 21.59 | 21.97 | 601.802 | 27.79 | 27.99 | Pass |
| 48 | 5240 | 22.20 | 20.82 | 21.71 | 22.01 | 593.847 | 27.74 | 27.99 | Pass |
| 149 | 5745 | 21.35 | 20.94 | 21.19 | 20.63 | 507.757 | 27.06 | 27.24 | Pass |
| 157 | 5785 | 21.07 | 20.75 | 21.24 | 20.70 | 497.324 | 26.97 | 27.24 | Pass |
| 165 | 5825 | 20.99 | 20.79 | 21.29 | 20.45 | 491.056 | 26.91 | 27.24 | Pass |

Note:

For 5180~5240MHz: Directional gain = $10 \log[(10^{G1/20} + 10^{G2/20} + \dots + 10^{GN/20})^2/4] = 8.01\text{dBi} > 6\text{dBi}$, so the power limit shall be reduced to $30 - (8.01 - 6) = 27.99\text{dBm}$.

For 5745~5825MHz: Directional gain = $10 \log[(10^{G1/20} + 10^{G2/20} + \dots + 10^{GN/20})^2/4] = 8.76\text{dBi} > 6\text{dBi}$, so the power limit shall be reduced to $30 - (8.76 - 6) = 27.24\text{dBm}$.

802.11ax (40MHz)

| Chan. | Freq. (MHz) | Maximum Conducted Power (dBm) | | | | Total Power (mW) | Total Power (dBm) | Power Limit (dBm) | Pass / Fail |
|-------|-------------|-------------------------------|---------|---------|---------|------------------|-------------------|-------------------|-------------|
| | | Chain 0 | Chain 1 | Chain 2 | Chain 3 | | | | |
| 38 | 5190 | 15.43 | 14.86 | 14.98 | 15.13 | 129.595 | 21.13 | 27.99 | Pass |
| 46 | 5230 | 21.63 | 20.97 | 21.33 | 21.44 | 545.719 | 27.37 | 27.99 | Pass |
| 151 | 5755 | 21.76 | 21.08 | 21.05 | 20.42 | 515.706 | 27.12 | 27.24 | Pass |
| 159 | 5795 | 21.69 | 21.11 | 21.04 | 20.65 | 519.895 | 27.16 | 27.24 | Pass |

Note:

For 5180~5240MHz: Directional gain = $10 \log[(10^{G1/20} + 10^{G2/20} + \dots + 10^{GN/20})^2/4] = 8.01\text{dBi} > 6\text{dBi}$, so the power limit shall be reduced to $30 - (8.01 - 6) = 27.99\text{dBm}$.

For 5745~5825MHz: Directional gain = $10 \log[(10^{G1/20} + 10^{G2/20} + \dots + 10^{GN/20})^2/4] = 8.76\text{dBi} > 6\text{dBi}$, so the power limit shall be reduced to $30 - (8.76 - 6) = 27.24\text{dBm}$.

802.11ax (80MHz)

| Chan. | Freq. (MHz) | Maximum Conducted Power (dBm) | | | | Total Power (mW) | Total Power (dBm) | Power Limit (dBm) | Pass / Fail |
|-------|-------------|-------------------------------|---------|---------|---------|------------------|-------------------|-------------------|-------------|
| | | Chain 0 | Chain 1 | Chain 2 | Chain 3 | | | | |
| 42 | 5210 | 14.79 | 14.38 | 14.65 | 14.28 | 113.512 | 20.55 | 27.99 | Pass |
| 155 | 5775 | 20.56 | 19.85 | 19.87 | 19.46 | 395.727 | 25.97 | 27.24 | Pass |

Note:

For 5180~5240MHz: Directional gain = $10 \log[(10^{G1/20} + 10^{G2/20} + \dots + 10^{GN/20})^2/4] = 8.01\text{dBi} > 6\text{dBi}$, so the power limit shall be reduced to $30 - (8.01 - 6) = 27.99\text{dBm}$.

For 5745~5825MHz: Directional gain = $10 \log[(10^{G1/20} + 10^{G2/20} + \dots + 10^{GN/20})^2/4] = 8.76\text{dBi} > 6\text{dBi}$, so the power limit shall be reduced to $30 - (8.76 - 6) = 27.24\text{dBm}$.

4.4 Occupied Bandwidth Measurement

4.4.1 Test Setup

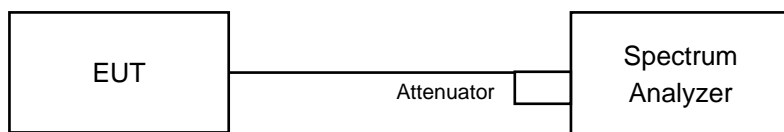

4.4.2 Test Instruments

Refer to section 4.1.2 to get information of above instrument.

4.4.3 Test Procedure

The transmitter output was connected to the spectrum analyzer through an attenuator. The bandwidth of the fundamental frequency was measured by spectrum analyzer with resolution bandwidth in the range of 1% to 5% of the anticipated emission bandwidth, and a video bandwidth at least 3x the resolution bandwidth and set the detector to SAMPLE. The width of a frequency band such that, below the lower and above the upper frequency limits, the mean powers emitted are each equal to a specified percentage 0.5 %of the total mean power of a given emission.

4.4.4 Test Result

CDD Mode

802.11a

| Chan. | Freq. (MHz) | Occupied Bandwidth (MHz) | | | |
|-------|-------------|--------------------------|---------|---------|---------|
| | | Chain 0 | Chain 1 | Chain 2 | Chain 3 |
| 36 | 5180 | 16.44 | 16.44 | 16.44 | 16.44 |
| 40 | 5200 | 16.68 | 16.68 | 16.68 | 16.68 |
| 48 | 5240 | 16.80 | 16.80 | 16.80 | 16.80 |

802.11ax (20MHz)

| Chan. | Freq. (MHz) | Occupied Bandwidth (MHz) | | | |
|-------|-------------|--------------------------|---------|---------|---------|
| | | Chain 0 | Chain 1 | Chain 2 | Chain 3 |
| 36 | 5180 | 18.96 | 18.96 | 18.96 | 18.96 |
| 40 | 5200 | 19.08 | 19.08 | 19.08 | 19.08 |
| 48 | 5240 | 19.32 | 19.32 | 19.32 | 19.20 |

802.11ax (40MHz)

| Chan. | Freq. (MHz) | Occupied Bandwidth (MHz) | | | |
|-------|-------------|--------------------------|---------|---------|---------|
| | | Chain 0 | Chain 1 | Chain 2 | Chain 3 |
| 38 | 5190 | 38.00 | 38.00 | 37.80 | 38.00 |
| 46 | 5230 | 37.80 | 38.00 | 37.80 | 37.80 |

802.11ax (80MHz)

| Chan. | Freq. (MHz) | Occupied Bandwidth (MHz) | | | |
|-------|-------------|--------------------------|---------|---------|---------|
| | | Chain 0 | Chain 1 | Chain 2 | Chain 3 |
| 42 | 5210 | 77.52 | 77.28 | 77.28 | 77.76 |

Spectrum Plot of Worst Value

802.11a

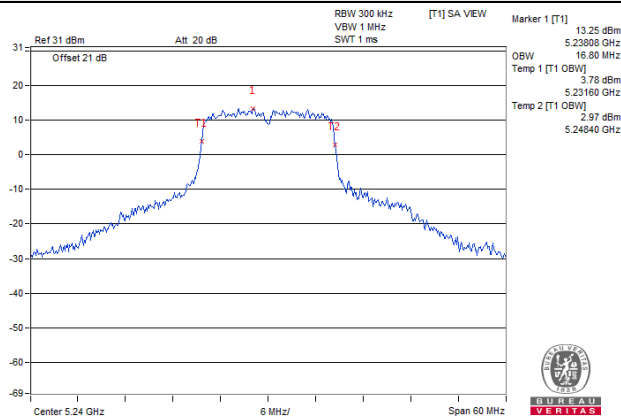

802.11ax (20MHz)

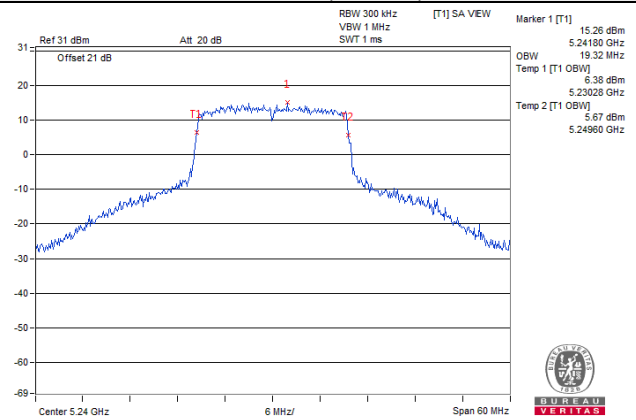

802.11ax (40MHz)

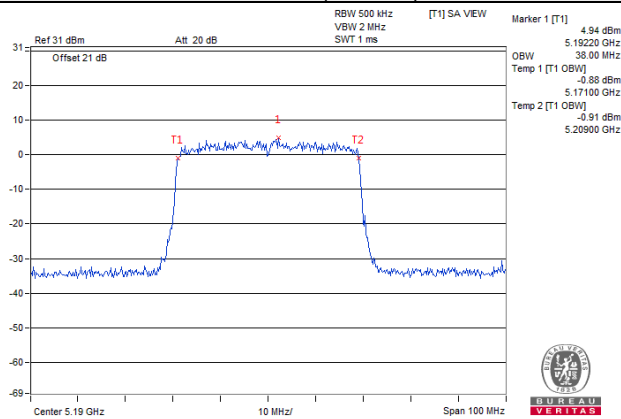

802.11ax (80MHz)

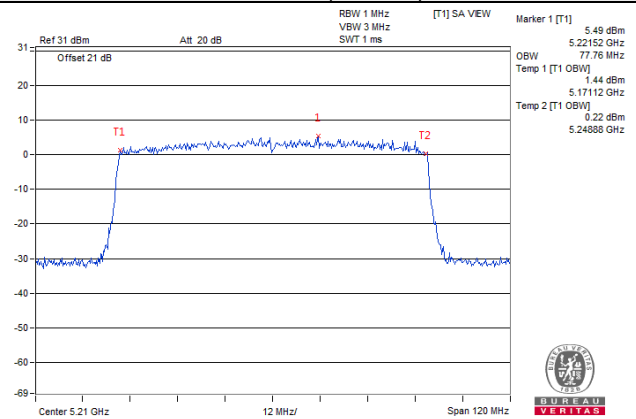

Spectrum Plot for near By DFS Band

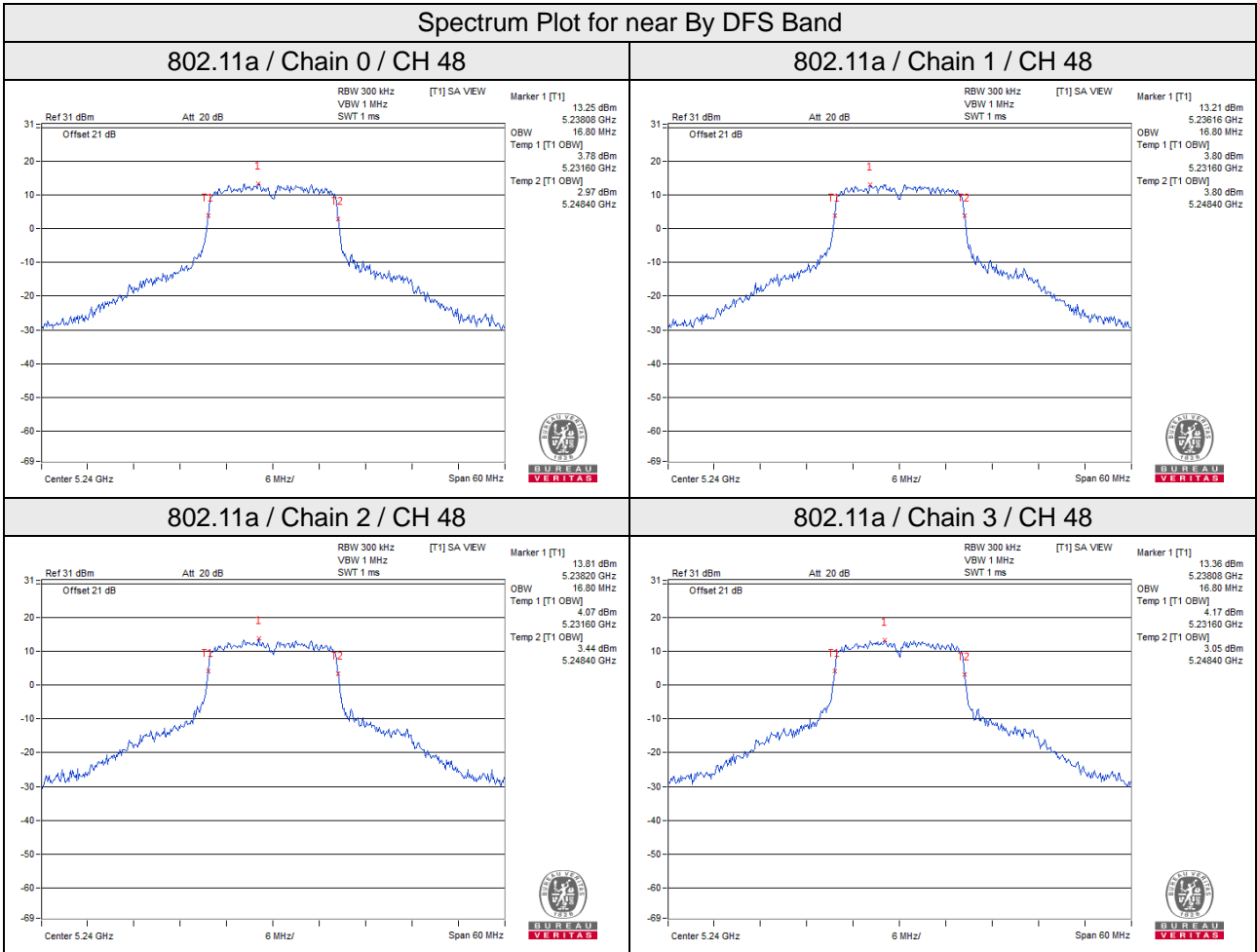

Spectrum Plot for near By DFS Band

802.11ax (20MHz) / Chain 0 / CH 48

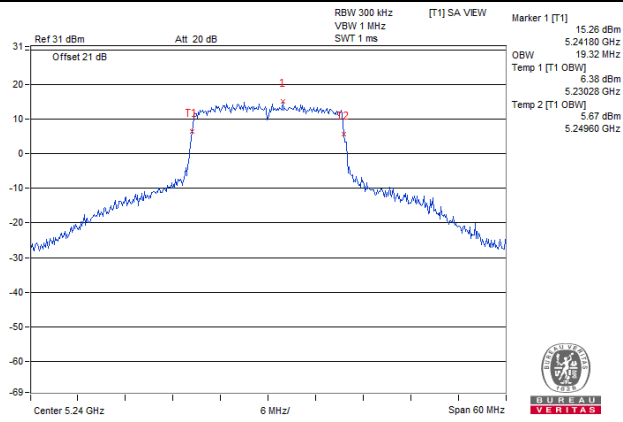

802.11ax (20MHz) / Chain 1 / CH 48

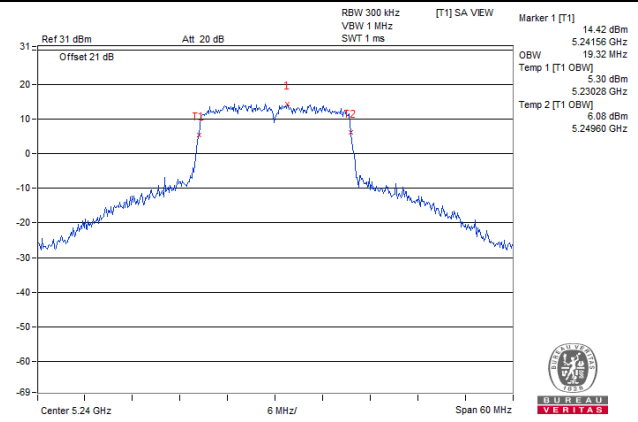

802.11ax (20MHz) / Chain 2 / CH 48

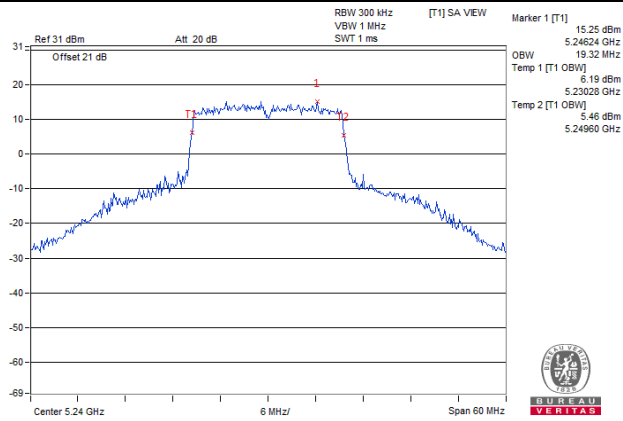

802.11ax (20MHz) / Chain 3 / CH 48

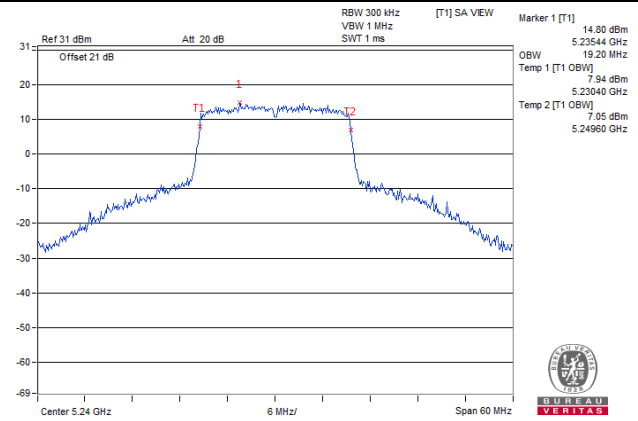

Spectrum Plot for near By DFS Band

802.11ax (40MHz) / Chain 0 / CH 46

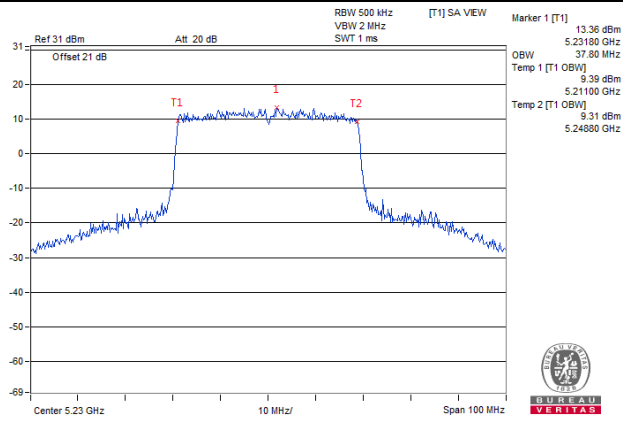

802.11ax (40MHz) / Chain 1 / CH 46

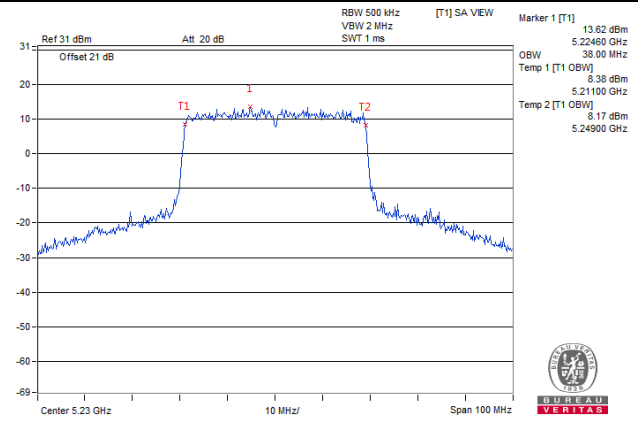

802.11ax (40MHz) / Chain 2 / CH 46

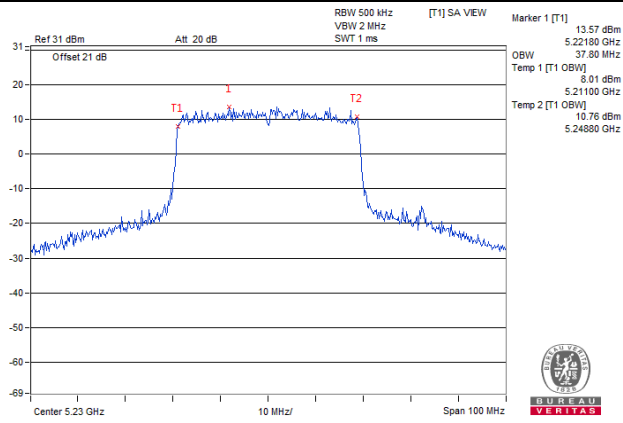

802.11ax (40MHz) / Chain 3 / CH 46

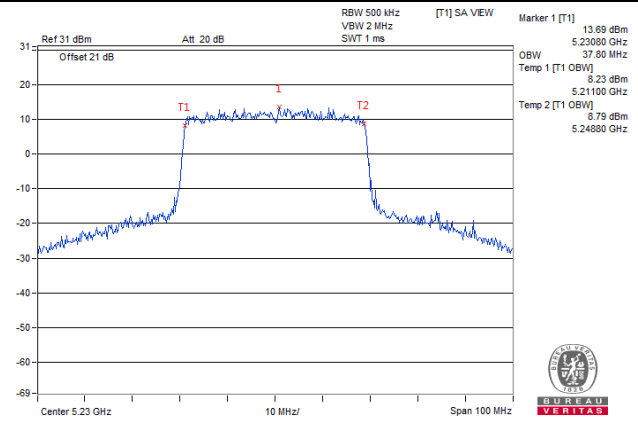

Spectrum Plot for near By DFS Band

802.11ax (80MHz) / Chain 0 / CH 42

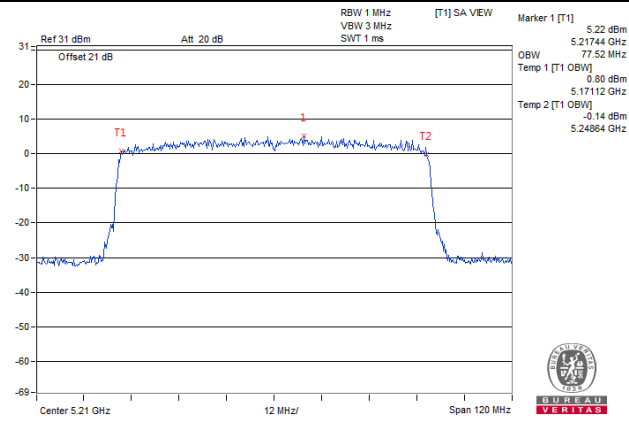

802.11ax (80MHz) / Chain 1 / CH 42

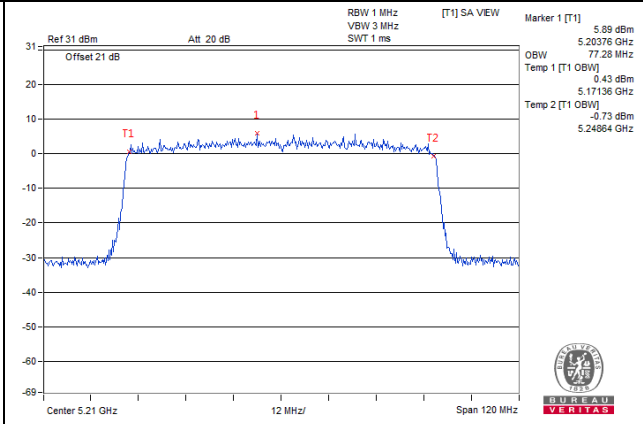

802.11ax (80MHz) / Chain 2 / CH 42

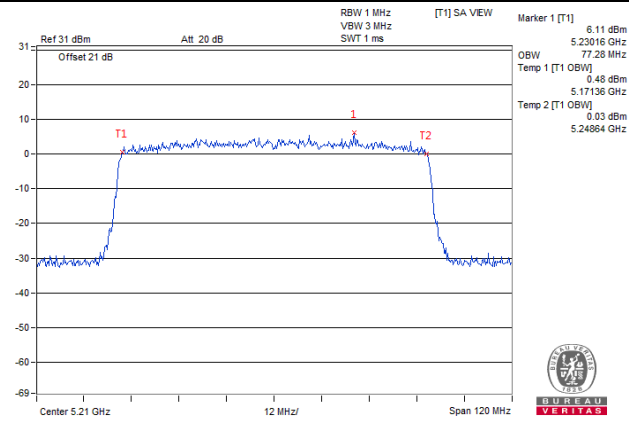

802.11ax (80MHz) / Chain 3 / CH 42

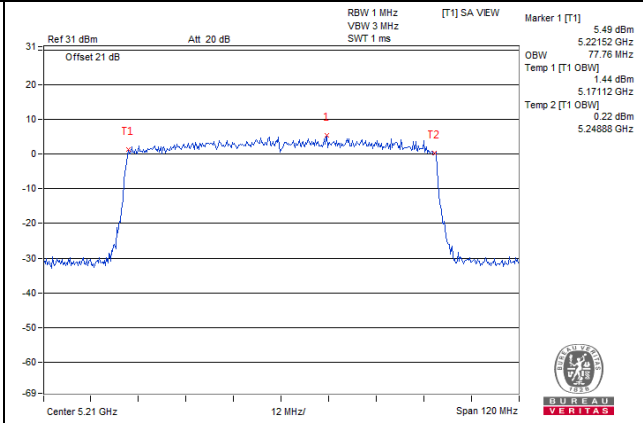

802.11a

| Chan. | Freq. (MHz) | Occupied Bandwidth (MHz) | | | |
|-------|-------------|--------------------------|---------|---------|---------|
| | | Chain 0 | Chain 1 | Chain 2 | Chain 3 |
| 149 | 5745 | 16.61 | 16.50 | 16.50 | 16.50 |
| 157 | 5785 | 16.50 | 16.50 | 16.50 | 16.50 |
| 165 | 5825 | 16.60 | 16.50 | 16.50 | 16.50 |

802.11ax (20MHz)

| Chan. | Freq. (MHz) | Occupied Bandwidth (MHz) | | | |
|-------|-------------|--------------------------|---------|---------|---------|
| | | Chain 0 | Chain 1 | Chain 2 | Chain 3 |
| 149 | 5745 | 18.96 | 19.00 | 19.00 | 19.10 |
| 157 | 5785 | 19.10 | 19.00 | 19.00 | 19.00 |
| 165 | 5825 | 19.00 | 19.10 | 19.10 | 19.10 |

802.11ax (40MHz)

| Chan. | Freq. (MHz) | Occupied Bandwidth (MHz) | | | |
|-------|-------------|--------------------------|---------|---------|---------|
| | | Chain 0 | Chain 1 | Chain 2 | Chain 3 |
| 151 | 5755 | 37.98 | 37.83 | 38.00 | 38.00 |
| 159 | 5795 | 37.83 | 37.83 | 37.83 | 37.83 |

802.11ax (80MHz)

| Chan. | Freq. (MHz) | Occupied Bandwidth (MHz) | | | |
|-------|-------------|--------------------------|---------|---------|---------|
| | | Chain 0 | Chain 1 | Chain 2 | Chain 3 |
| 155 | 5775 | 77.30 | 77.00 | 77.00 | 77.28 |

Spectrum Plot of Worst Value

802.11a

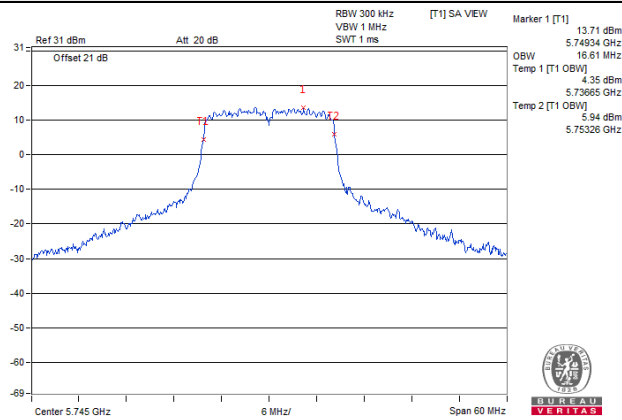

802.11ax (20MHz)

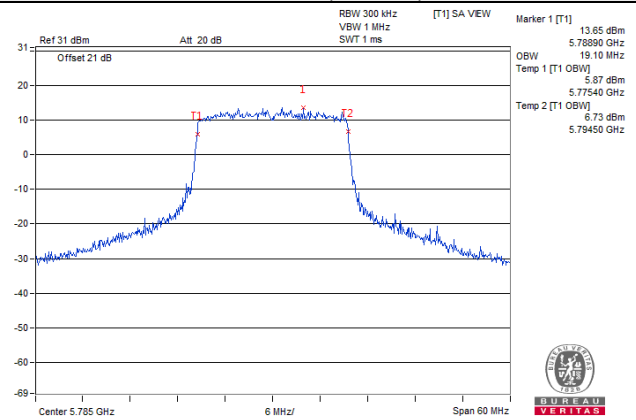

802.11ax (40MHz)

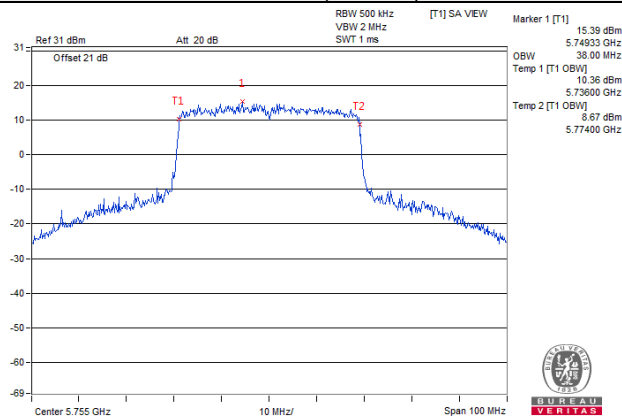

802.11ax (80MHz)

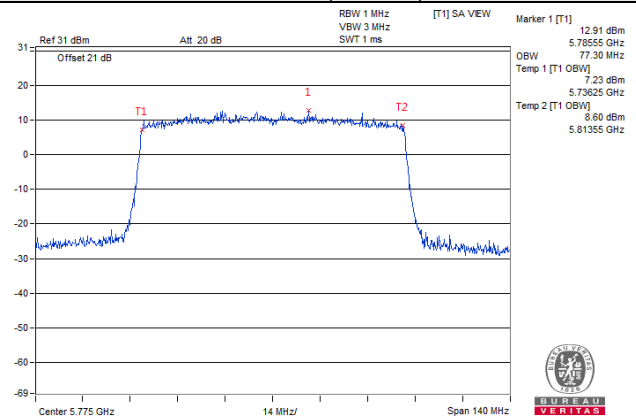

Spectrum Plot for near By DFS Band

802.11a / Chain 0 / CH 149

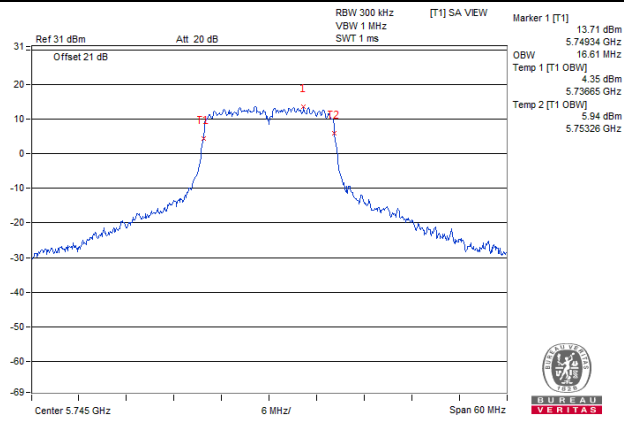

802.11a / Chain 1 / CH 149

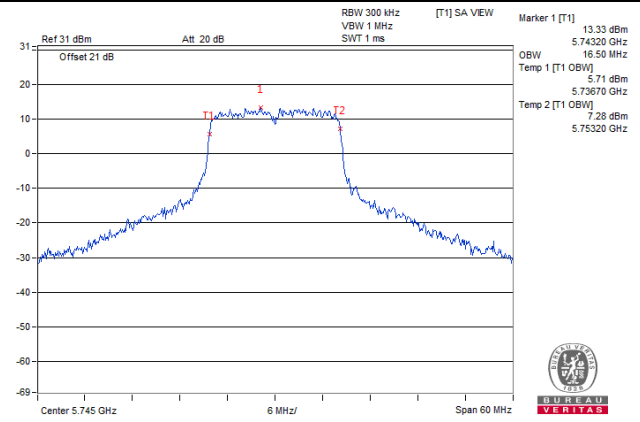

802.11a / Chain 2 / CH 149

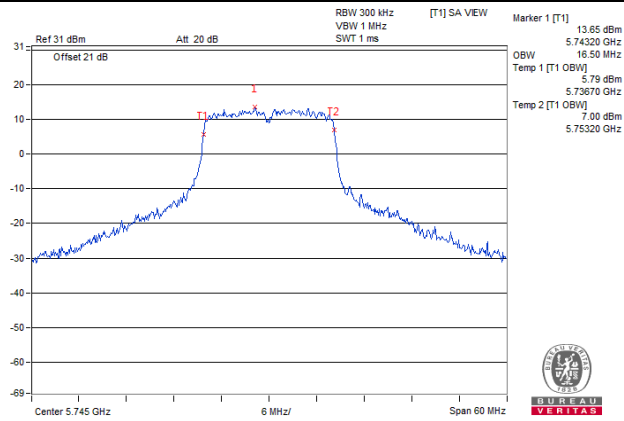

802.11a / Chain 3 / CH 149

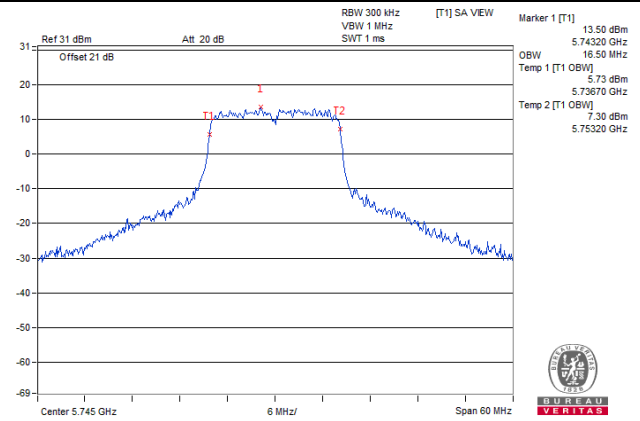

Spectrum Plot for near By DFS Band

802.11ax (20MHz) / Chain 0 / CH 149

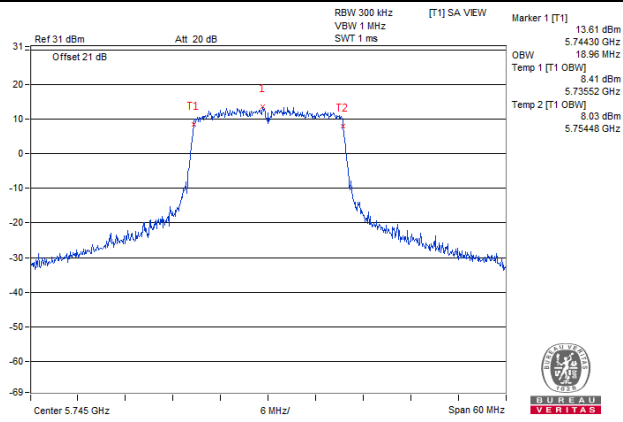

802.11ax (20MHz) / Chain 1 / CH 149

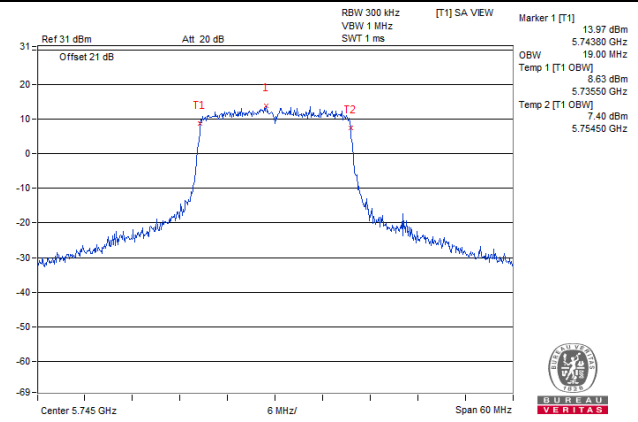

802.11ax (20MHz) / Chain 2 / CH 149

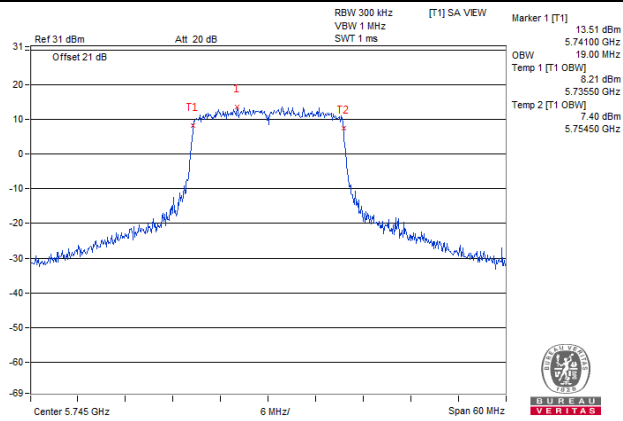

802.11ax (20MHz) / Chain 3 / CH 149

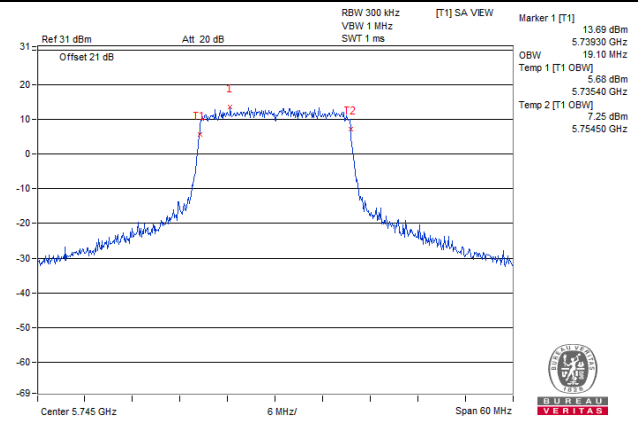

Spectrum Plot for near By DFS Band

802.11ax (40MHz) / Chain 0 / CH 151

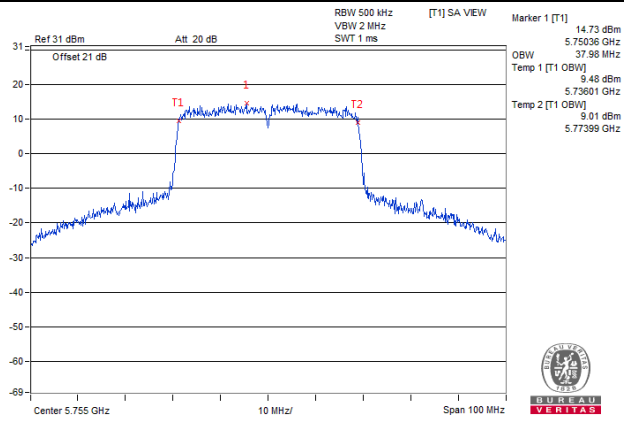

802.11ax (40MHz) / Chain 1 / CH 151

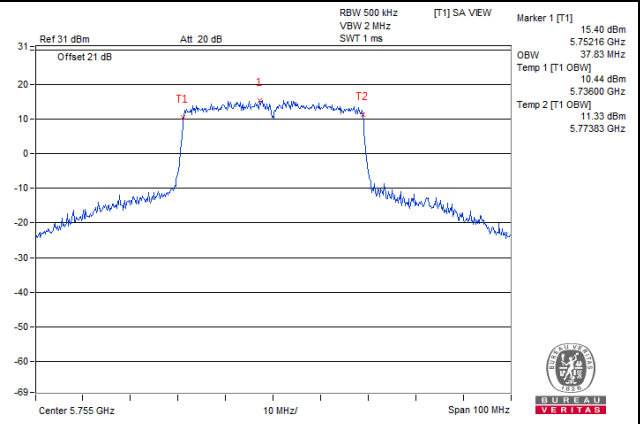

802.11ax (40MHz) / Chain 2 / CH 151

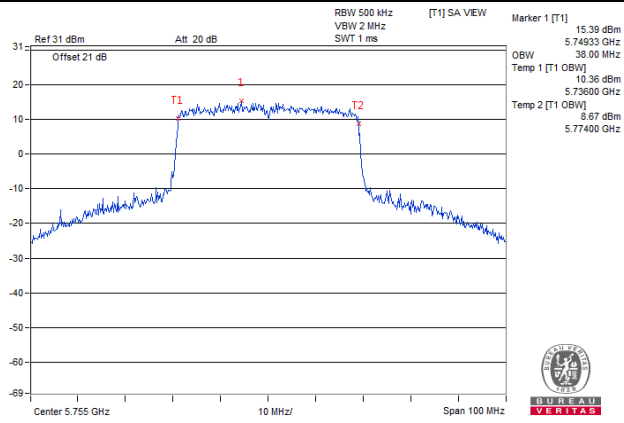

802.11ax (40MHz) / Chain 3 / CH 151

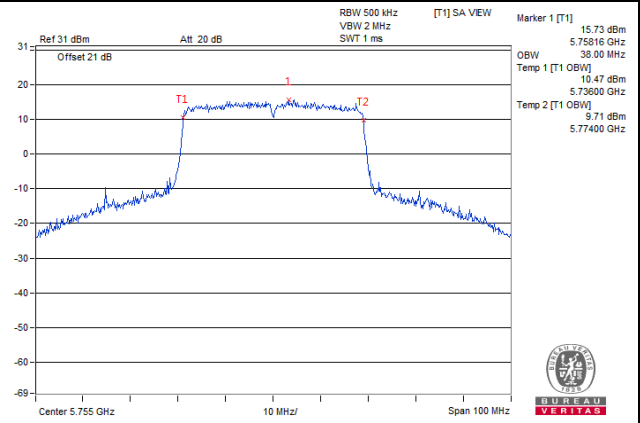

Spectrum Plot for near By DFS Band

802.11ax (80MHz) / Chain 0 / CH 155

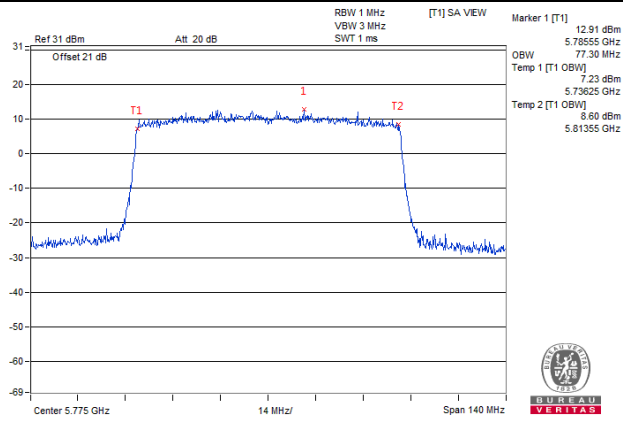

802.11ax (80MHz) / Chain 1 / CH 155

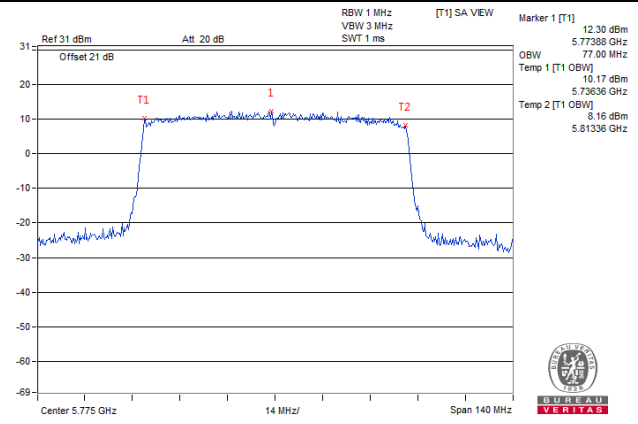

802.11ax (80MHz) / Chain 2 / CH 155

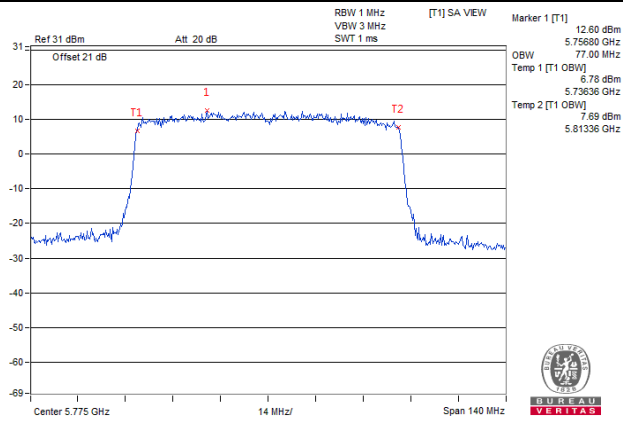

802.11ax (80MHz) / Chain 3 / CH 155

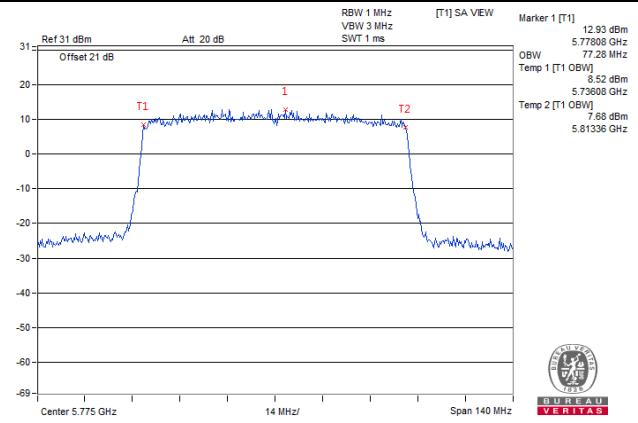

4.5 Peak Power Spectral Density Measurement

4.5.1 Limits of Peak Power Spectral Density Measurement

| Operation Band | EUT Category | | Limit |
|----------------|--------------|-----------------------------------|---------------|
| U-NII-1 | | Outdoor Access Point | 17dBm/ MHz |
| | | Fixed point-to-point Access Point | |
| | √ | Indoor Access Point | |
| | | Mobile and Portable client device | 11dBm/ MHz |
| U-NII-2A | | | 11dBm/ MHz |
| U-NII-2C | | | 11dBm/ MHz |
| U-NII-3 | √ | | 30dBm/ 500kHz |

4.5.2 Test Setup

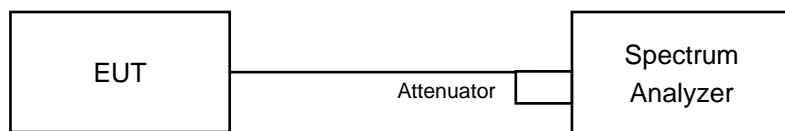

4.5.3 Test Instruments

Refer to section 4.1.2 to get information of above instrument.

4.5.4 Test Procedures

For U-NII-1 band:

Using method SA-2

- Set span to encompass the entire emission bandwidth (EBW) of the signal.
- Set RBW = 1MHz, Set VBW \geq 3 MHz, Detector = RMS
- Set Channel power measure = 1MHz
- Sweep time = auto, trigger set to "free run".
- Trace average at least 100 traces in power averaging mode.
- Record the max value and add 10 log (1/duty cycle)

For U-NII-3 band:

- Set span to encompass the entire emission bandwidth (EBW) of the signal.
- Set RBW = 500 kHz, Set VBW \geq 1 MHz, Detector = RMS
- Use the peak marker function to determine the maximum power level in any 500 kHz band segment within the fundamental EBW.
- Sweep time = auto, trigger set to "free run".
- Trace average at least 100 traces in power averaging mode.
- Record the max value and add 10 log (1/duty cycle)

4.5.5 Deviation from Test Standard

No deviation.

4.5.6 EUT Operating Conditions

Same as 4.3.6.

4.5.7 Test Results

CDD Mode

For U-NII-1 band:

802.11a

| Chan. | Freq. (MHz) | PSD w/o Duty Factor (dBm/MHz) | | | | Duty Factor (dB) | Total PSD with Duty Factor (dBm/MHz) | Max. Limit (dBm/MHz) | Pass / Fail |
|-------|-------------|-------------------------------|---------|---------|---------|------------------|--------------------------------------|----------------------|-------------|
| | | Chain 0 | Chain 1 | Chain 2 | Chain 3 | | | | |
| 36 | 5180 | 4.94 | 4.93 | 5.01 | 4.93 | 0.33 | 11.31 | 14.99 | Pass |
| 40 | 5200 | 8.52 | 8.37 | 8.45 | 8.41 | 0.33 | 14.79 | 14.99 | Pass |
| 48 | 5240 | 8.34 | 8.42 | 8.49 | 8.38 | 0.33 | 14.76 | 14.99 | Pass |

Note:

- Method E) 2) a) of power density measurement of KDB 662911 is using for calculating total power density. Total power density is summing entire spectra across corresponding frequency bins on the various outputs by computer.
- Directional gain = $10 \log[(10^{G1/20} + 10^{G2/20} + \dots + 10^{GN/20})^2/4] = 8.01 \text{dBi} > 6 \text{dBi}$, so the power density limit shall be reduced to $17 - (8.01 - 6) = 14.99 \text{dBm}$.
- Refer to section 3.3 for duty cycle spectrum plot.

802.11ax (20MHz)

| Chan. | Freq. (MHz) | PSD w/o Duty Factor (dBm/MHz) | | | | Duty Factor (dB) | Total PSD with Duty Factor (dBm/MHz) | Max. Limit (dBm/MHz) | Pass / Fail |
|-------|-------------|-------------------------------|---------|---------|---------|------------------|--------------------------------------|----------------------|-------------|
| | | Chain 0 | Chain 1 | Chain 2 | Chain 3 | | | | |
| 36 | 5180 | 4.26 | 4.28 | 4.36 | 4.47 | 0.17 | 10.54 | 14.99 | Pass |
| 40 | 5200 | 8.39 | 8.36 | 8.73 | 8.72 | 0.17 | 14.75 | 14.99 | Pass |
| 48 | 5240 | 8.61 | 8.67 | 8.68 | 8.71 | 0.17 | 14.86 | 14.99 | Pass |

Note:

- Method E) 2) a) of power density measurement of KDB 662911 is using for calculating total power density. Total power density is summing entire spectra across corresponding frequency bins on the various outputs by computer.
- Directional gain = $10 \log[(10^{G1/20} + 10^{G2/20} + \dots + 10^{GN/20})^2/4] = 8.01 \text{dBi} > 6 \text{dBi}$, so the power density limit shall be reduced to $17 - (8.01 - 6) = 14.99 \text{dBm}$.
- Refer to section 3.3 for duty cycle spectrum plot.

802.11ax (40MHz)

| Chan. | Freq. (MHz) | PSD w/o Duty Factor (dBm/MHz) | | | | Duty Factor (dB) | Total PSD with Duty Factor (dBm/MHz) | Max. Limit (dBm/MHz) | Pass / Fail |
|-------|-------------|-------------------------------|---------|---------|---------|------------------|--------------------------------------|----------------------|-------------|
| | | Chain 0 | Chain 1 | Chain 2 | Chain 3 | | | | |
| 38 | 5190 | -3.77 | -3.66 | -3.98 | -3.66 | 0.16 | 2.42 | 14.99 | Pass |
| 46 | 5230 | 4.57 | 4.45 | 4.59 | 4.58 | 0.16 | 10.73 | 14.99 | Pass |

Note:

- Method E) 2) a) of power density measurement of KDB 662911 is using for calculating total power density. Total power density is summing entire spectra across corresponding frequency bins on the various outputs by computer.
- Directional gain = $10 \log[(10^{G1/20} + 10^{G2/20} + \dots + 10^{GN/20})^2/4] = 8.01 \text{dBi} > 6 \text{dBi}$, so the power density limit shall be reduced to $17 - (8.01 - 6) = 14.99 \text{dBm}$.
- Refer to section 3.3 for duty cycle spectrum plot.

802.11ax (80MHz)

| Chan. | Freq. (MHz) | PSD w/o Duty Factor (dBm/MHz) | | | | Duty Factor (dB) | Total PSD with Duty Factor (dBm/MHz) | Max. Limit (dBm/MHz) | Pass / Fail |
|-------|-------------|-------------------------------|---------|---------|---------|------------------|--------------------------------------|----------------------|-------------|
| | | Chain 0 | Chain 1 | Chain 2 | Chain 3 | | | | |
| 42 | 5210 | -6.83 | -6.63 | -6.57 | -6.76 | 0.14 | -0.54 | 14.99 | Pass |

Note:

- Method E) 2) a) of power density measurement of KDB 662911 is using for calculating total power density. Total power density is summing entire spectra across corresponding frequency bins on the various outputs by computer.
- Directional gain = $10 \log[(10^{G1/20} + 10^{G2/20} + \dots + 10^{GN/20})^2/4] = 8.01 \text{dBi} > 6 \text{dBi}$, so the power density limit shall be reduced to $17 - (8.01 - 6) = 14.99 \text{dBm}$.
- Refer to section 3.3 for duty cycle spectrum plot.

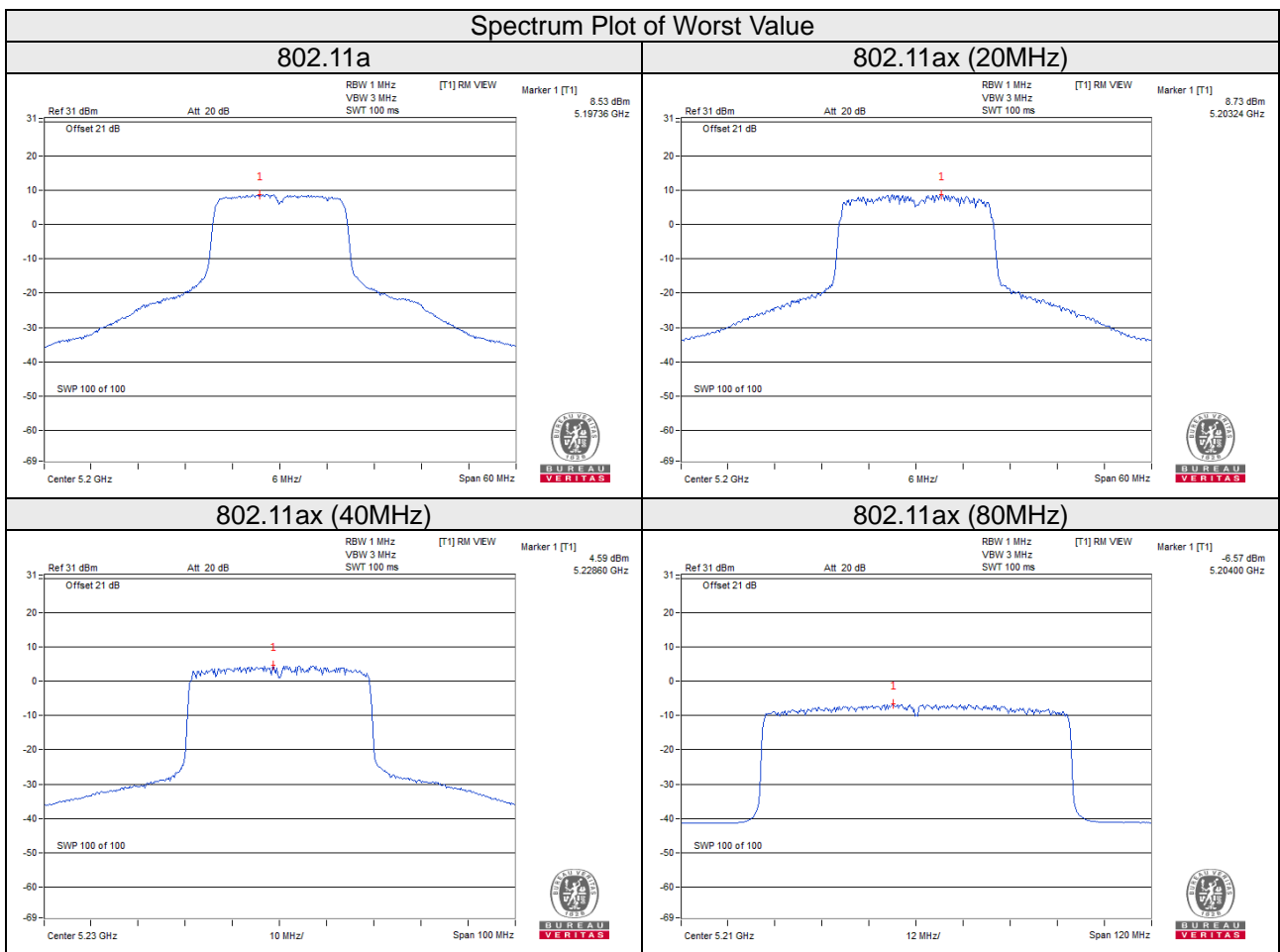

For U-NII-3 band:

802.11a

| Chan. | Freq. (MHz) | PSD w/o Duty Factor(dBm/500kHz) | | | | Duty Factor (dB) | Total PSD with Duty Factor (dBm/500kHz) | Limit (dBm/500k Hz) | Pass / Fail |
|-------|-------------|---------------------------------|---------|---------|---------|------------------|---|---------------------|-------------|
| | | Chain 0 | Chain 1 | Chain 2 | Chain 3 | | | | |
| 36 | 5180 | 0.26 | 0.07 | 0.16 | 0.26 | 0.33 | 6.54 | 27.24 | Pass |
| 40 | 5200 | -0.73 | -0.90 | -0.89 | -0.73 | 0.33 | 5.54 | 27.24 | Pass |
| 48 | 5240 | -1.07 | -1.34 | -1.19 | -1.25 | 0.33 | 5.14 | 27.24 | Pass |

Note:

1. Method E) 2) c) of power density measurement of KDB 662911 is using for calculating total power density, Measure and add $10 \log (N_{ANT})$ dB.
2. Directional gain = $10 \log[(10^{G1/20} + 10^{G2/20} + \dots + 10^{GN/20})^2/4]=8.76\text{dBi} > 6\text{dBi}$, so the power density limit shall be reduced to $30-(8.76-6) = 27.24\text{dBm}$.
3. Refer to section 3.3 for duty cycle spectrum plot.

802.11ax (20MHz)

| Chan. | Freq. (MHz) | PSD w/o Duty Factor(dBm/500kHz) | | | | Duty Factor (dB) | Total PSD with Duty Factor (dBm/500kHz) | Limit (dBm/500k Hz) | Pass / Fail |
|-------|-------------|---------------------------------|---------|---------|---------|------------------|---|---------------------|-------------|
| | | Chain 0 | Chain 1 | Chain 2 | Chain 3 | | | | |
| 36 | 5180 | -1.86 | -1.97 | -1.92 | -1.88 | 0.17 | 4.29 | 27.24 | Pass |
| 40 | 5200 | -2.14 | -2.10 | -2.09 | -2.29 | 0.17 | 4.04 | 27.24 | Pass |
| 48 | 5240 | -2.97 | -2.49 | -2.52 | -2.50 | 0.17 | 3.58 | 27.24 | Pass |

Note:

1. Method E) 2) c) of power density measurement of KDB 662911 is using for calculating total power density, Measure and add $10 \log (N_{ANT})$ dB.
2. Directional gain = $10 \log[(10^{G1/20} + 10^{G2/20} + \dots + 10^{GN/20})^2/4]=8.76\text{dBi} > 6\text{dBi}$, so the power density limit shall be reduced to $30-(8.76-6) = 27.24\text{dBm}$.
3. Refer to section 3.3 for duty cycle spectrum plot.

802.11ax (40MHz)

| Chan. | Freq. (MHz) | PSD w/o Duty Factor(dBm/500kHz) | | | | Duty Factor (dB) | Total PSD with Duty Factor (dBm/500kHz) | Limit (dBm/500k Hz) | Pass / Fail |
|-------|-------------|---------------------------------|---------|---------|---------|------------------|---|---------------------|-------------|
| | | Chain 0 | Chain 1 | Chain 2 | Chain 3 | | | | |
| 151 | 5755 | -3.50 | -3.54 | -3.43 | -3.49 | 0.16 | 2.69 | 27.24 | Pass |
| 159 | 5795 | -4.82 | -4.55 | -4.62 | -4.92 | 0.16 | 1.46 | 27.24 | Pass |

Note:

1. Method E) 2) c) of power density measurement of KDB 662911 is using for calculating total power density, Measure and add $10 \log (N_{ANT})$ dB.
2. Directional gain = $10 \log[(10^{G1/20} + 10^{G2/20} + \dots + 10^{GN/20})^2/4]=8.76\text{dBi} > 6\text{dBi}$, so the power density limit shall be reduced to $30-(8.76-6) = 27.24\text{dBm}$.
3. Refer to section 3.3 for duty cycle spectrum plot.

802.11ax (80MHz)

| Chan. | Freq. (MHz) | PSD w/o Duty Factor(dBm/500kHz) | | | | Duty Factor (dB) | Total PSD with Duty Factor (dBm/500kHz) | Limit (dBm/500k Hz) | Pass / Fail |
|-------|-------------|---------------------------------|---------|---------|---------|------------------|---|---------------------|-------------|
| | | Chain 0 | Chain 1 | Chain 2 | Chain 3 | | | | |
| 155 | 5775 | -9.67 | -9.47 | -9.58 | -9.59 | 0.14 | -3.42 | 27.24 | Pass |

Note:

- Method E) 2) c) of power density measurement of KDB 662911 is using for calculating total power density, Measure and add $10 \log(N_{ANT})$ dB.
- Directional gain = $10 \log[(10^{G1/20} + 10^{G2/20} + \dots + 10^{GN/20})^2/4] = 8.76\text{dBi} > 6\text{dBi}$, so the power density limit shall be reduced to $30 - (8.76 - 6) = 27.24\text{dBm}$.
- Refer to section 3.3 for duty cycle spectrum plot.

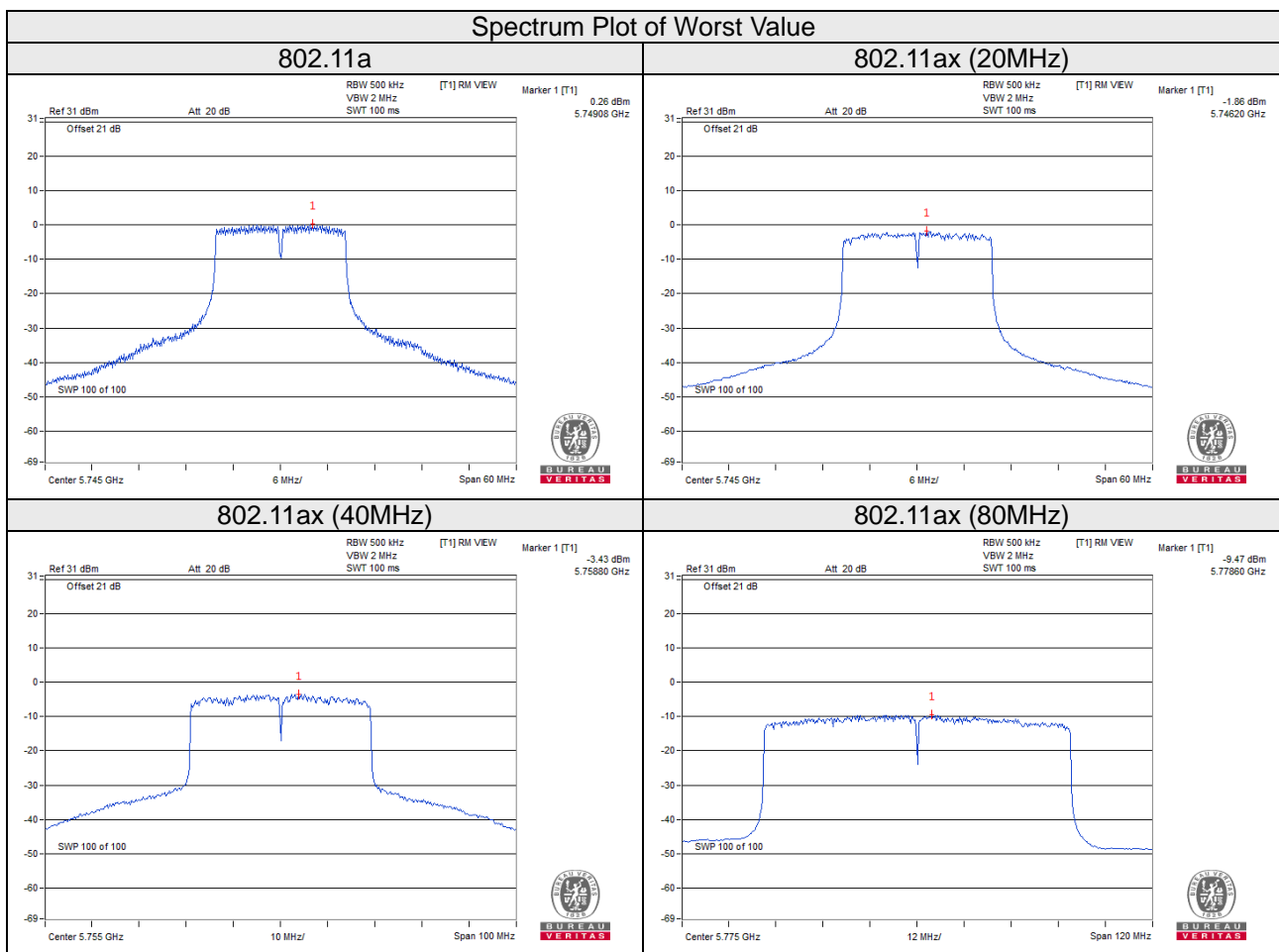

4.6 Frequency Stability

4.6.1 Limits of Frequency Stability Measurement

The frequency of the carrier signal shall be maintained within band of operation

4.6.2 Test Setup

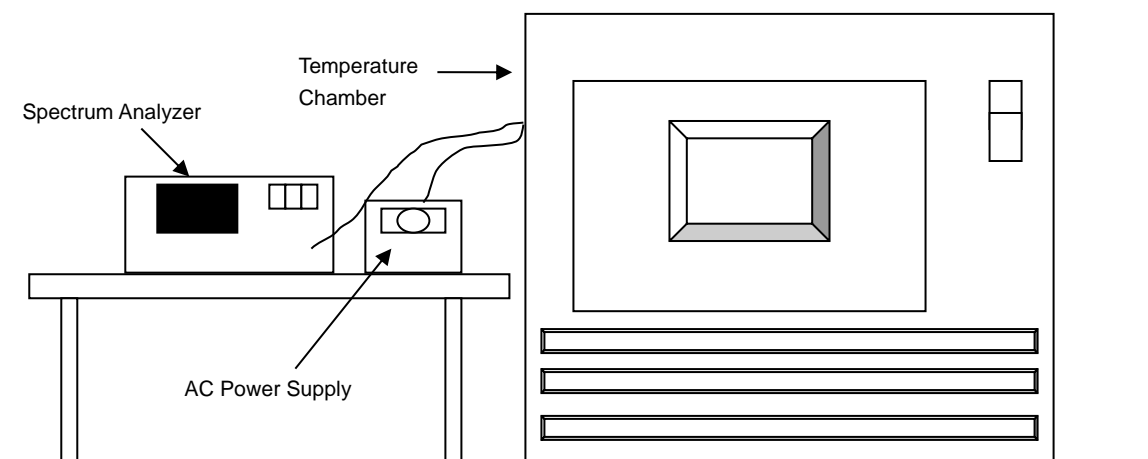

4.6.3 Test Instruments

| Description & Manufacturer | Model No. | Serial No. | Cal. Date | Cal. Due |
|-----------------------------------|-----------|------------|---------------|--------------|
| ROHDE & SCHWARZ Spectrum Analyzer | FSV 40 | 101042 | Sep. 8, 2020 | Sep. 7, 2021 |
| Temperature & Humidity Chamber | MHU-225AU | 920409 | May 22, 2020 | May 21, 2021 |
| DIGITAL POWER METER IDRC | CP-240 | 240515 | Sep. 10, 2020 | Sep. 9, 2021 |
| AC Power Source ExTech | CFW-105 | E000603 | NA | NA |

Note: The calibration interval of the above test instruments is 12 months and the calibrations are traceable to NML/ROC and NIST/USA.

4.6.4 Test Procedure

- The EUT was placed inside the environmental test chamber and powered by nominal AC voltage.
- Turn the EUT on and couple its output to a spectrum analyzer.
- Turn the EUT off and set the chamber to the highest temperature specified.
- Allow sufficient time (approximately 30 min) for the temperature of the chamber to stabilize, turn the EUT on and measure the operating frequency after 2, 5, and 10 minutes.
- Repeat step d with the temperature chamber set to the next desired temperature.
- The test chamber was allowed to stabilize at +20 degree C for a minimum of 30 minutes. The supply voltage was then adjusted on the EUT from 85% to 115% and the frequency record.

4.6.5 Deviation from Test Standard

No deviation.

4.6.6 EUT Operating Condition

Set the EUT transmit at un-modulation mode to test frequency stability.

4.6.7 Test Results

CDD Mode

| Frequency Stability Versus Temp. | | | | | | | | | |
|----------------------------------|--------------------|--------------------------|--------|--------------------------|--------|--------------------------|--------|--------------------------|--------|
| Operating Frequency: 5180MHz | | | | | | | | | |
| Temp. (°C) | Power Supply (Vac) | 0 Minute | | 2 Minute | | 5 Minute | | 10 Minute | |
| | | Measured Frequency (MHz) | Result | Measured Frequency (MHz) | Result | Measured Frequency (MHz) | Result | Measured Frequency (MHz) | Result |
| 50 | 120 | 5179.9955 | Pass | 5179.9971 | Pass | 5179.9987 | Pass | 5179.9991 | Pass |
| 40 | 120 | 5180.0031 | Pass | 5180.0019 | Pass | 5180.0027 | Pass | 5180.0033 | Pass |
| 30 | 120 | 5179.9810 | Pass | 5179.9805 | Pass | 5179.9803 | Pass | 5179.9822 | Pass |
| 20 | 120 | 5180.0008 | Pass | 5179.9998 | Pass | 5180.0002 | Pass | 5179.9985 | Pass |
| 10 | 120 | 5179.9756 | Pass | 5179.9777 | Pass | 5179.9788 | Pass | 5179.9774 | Pass |
| 0 | 120 | 5179.9914 | Pass | 5179.9925 | Pass | 5179.9923 | Pass | 5179.9887 | Pass |
| -10 | 120 | 5180.0135 | Pass | 5180.0175 | Pass | 5180.0138 | Pass | 5180.0162 | Pass |
| -20 | 120 | 5180.0004 | Pass | 5180.0040 | Pass | 5179.9998 | Pass | 5179.9999 | Pass |
| -30 | 120 | 5179.9777 | Pass | 5179.9782 | Pass | 5179.9760 | Pass | 5179.9782 | Pass |

| Frequency Stability Versus Voltage | | | | | | | | | |
|------------------------------------|--------------------|--------------------------|--------|--------------------------|--------|--------------------------|--------|--------------------------|--------|
| Operating Frequency: 5180MHz | | | | | | | | | |
| Temp. (°C) | Power Supply (Vac) | 0 Minute | | 2 Minute | | 5 Minute | | 10 Minute | |
| | | Measured Frequency (MHz) | Result | Measured Frequency (MHz) | Result | Measured Frequency (MHz) | Result | Measured Frequency (MHz) | Result |
| 20 | 138 | 5180.0012 | Pass | 5179.9988 | Pass | 5179.9996 | Pass | 5179.9977 | Pass |
| | 120 | 5180.0008 | Pass | 5179.9998 | Pass | 5180.0002 | Pass | 5179.9985 | Pass |
| | 102 | 5179.9998 | Pass | 5180.0008 | Pass | 5180.0002 | Pass | 5179.9982 | Pass |

4.7 6dB Bandwidth Measurement

4.7.1 Limits of 6dB Bandwidth Measurement

The minimum of 6dB Bandwidth Measurement is 0.5MHz.

4.7.2 Test Setup

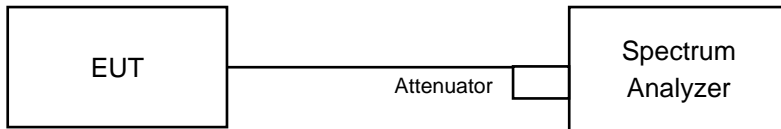

4.7.3 Test Instruments

Refer to section 4.1.2 to get information of above instrument.

4.7.4 Test Procedure

- Set resolution bandwidth (RBW) = 100kHz
- Set the video bandwidth (VBW) $\geq 3 \times$ RBW, Detector = Peak.
- Trace mode = max hold.
- Sweep = auto couple.
- Measure the maximum width of the emission that is constrained by the frequencies associated with the two amplitude points (upper and lower) that are attenuated by 6 dB relative to the maximum level measured in the fundamental emission

4.7.5 Deviation from Test Standard

No deviation.

4.7.6 EUT Operating Condition

The software provided by client to enable the EUT under transmission condition continuously at lowest, middle and highest channel frequencies individually.

4.7.7 Test Results

CDD Mode

802.11a

| Channel | Frequency (MHz) | 6dB Bandwidth (MHz) | | | | Minimum Limit (MHz) | Pass / Fail |
|---------|-----------------|---------------------|---------|---------|---------|---------------------|-------------|
| | | Chain 0 | Chain 1 | Chain 2 | Chain 3 | | |
| 149 | 5745 | 16.34 | 16.34 | 16.34 | 16.34 | 0.5 | Pass |
| 157 | 5785 | 16.37 | 16.37 | 16.36 | 16.36 | 0.5 | Pass |
| 165 | 5825 | 16.36 | 16.35 | 16.36 | 16.37 | 0.5 | Pass |

802.11ax (20MHz)

| Channel | Frequency (MHz) | 6dB Bandwidth (MHz) | | | | Minimum Limit (MHz) | Pass / Fail |
|---------|-----------------|---------------------|---------|---------|---------|---------------------|-------------|
| | | Chain 0 | Chain 1 | Chain 2 | Chain 3 | | |
| 149 | 5745 | 18.87 | 18.93 | 18.93 | 18.97 | 0.5 | Pass |
| 157 | 5785 | 18.96 | 18.95 | 18.97 | 18.97 | 0.5 | Pass |
| 165 | 5825 | 18.94 | 19.00 | 18.95 | 18.93 | 0.5 | Pass |

802.11ax (40MHz)

| Channel | Frequency (MHz) | 6dB Bandwidth (MHz) | | | | Minimum Limit (MHz) | Pass / Fail |
|---------|-----------------|---------------------|---------|---------|---------|---------------------|-------------|
| | | Chain 0 | Chain 1 | Chain 2 | Chain 3 | | |
| 151 | 5755 | 37.57 | 37.88 | 37.92 | 37.81 | 0.5 | Pass |
| 159 | 5795 | 37.83 | 37.68 | 37.90 | 37.91 | 0.5 | Pass |

802.11ax (80MHz)

| Channel | Frequency (MHz) | 6dB Bandwidth (MHz) | | | | Minimum Limit (MHz) | Pass / Fail |
|---------|-----------------|---------------------|---------|---------|---------|---------------------|-------------|
| | | Chain 0 | Chain 1 | Chain 2 | Chain 3 | | |
| 155 | 5775 | 77.37 | 77.18 | 77.44 | 77.97 | 0.5 | Pass |

Spectrum Plot of Worst Value

802.11a

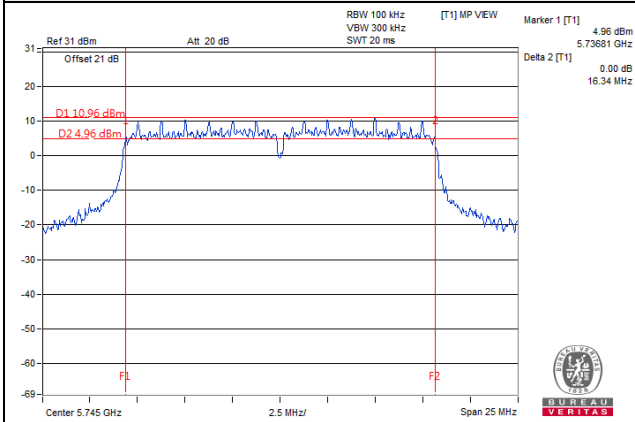

802.11ax (20MHz)

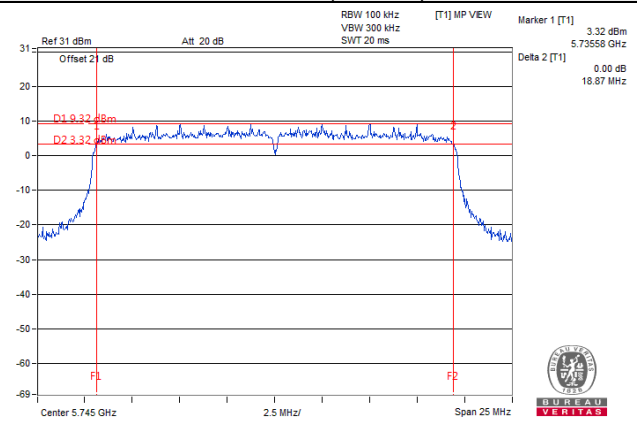

802.11ax (40MHz)

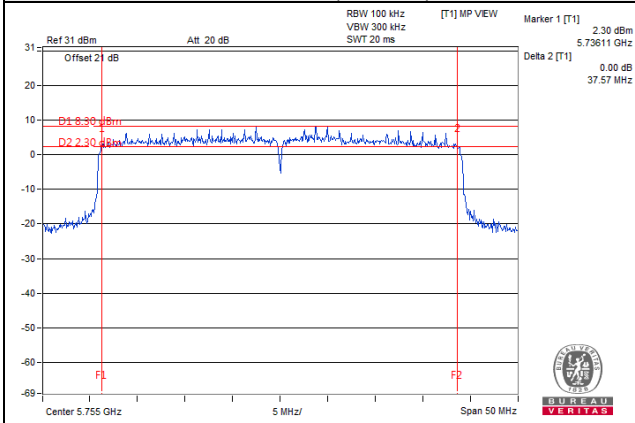

802.11ax (80MHz)

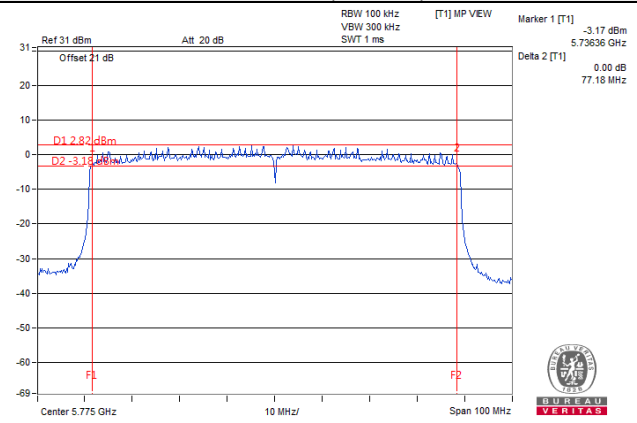

5 Pictures of Test Arrangements

Please refer to the attached file (Test Setup Photo).

Annex A- Radiated Out of Band Emission (OOBE) Measurement (For U-NII-3 band)

CDD Mode

802.11a

CH 149 5745 MHz

Horizontal

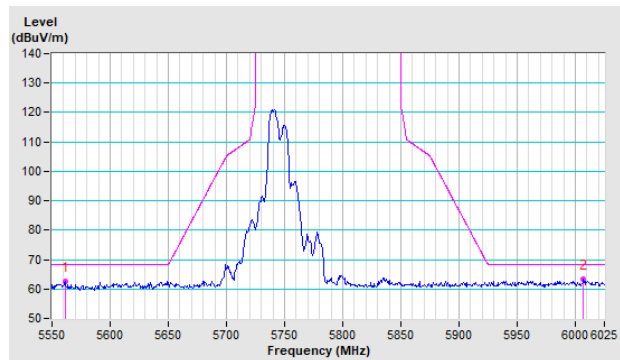

Vertical

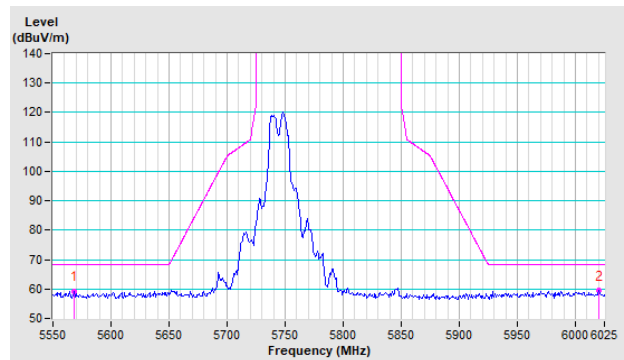

CH 157 5785 MHz

Horizontal

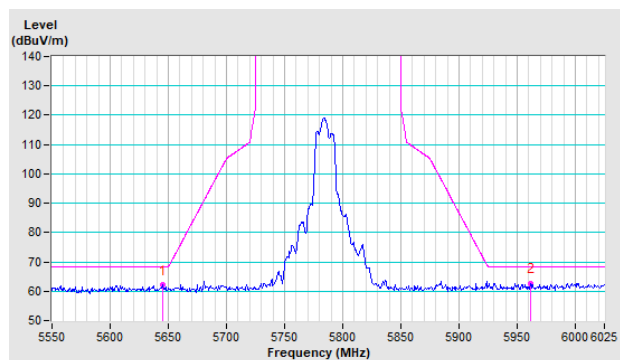

Vertical

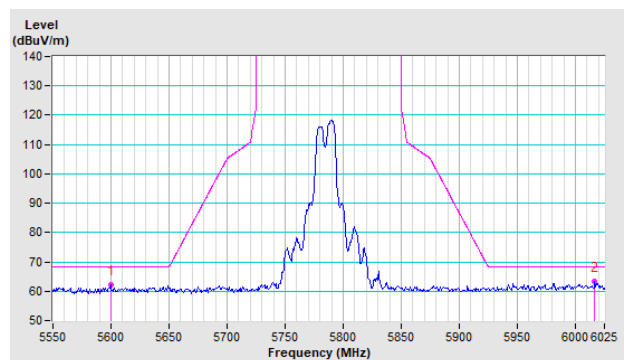

CH 165 5825 MHz

Horizontal

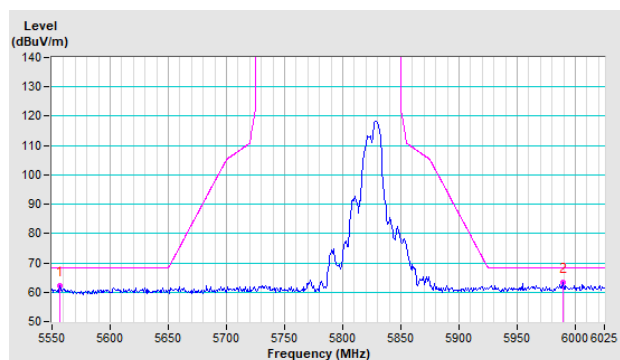

Vertical

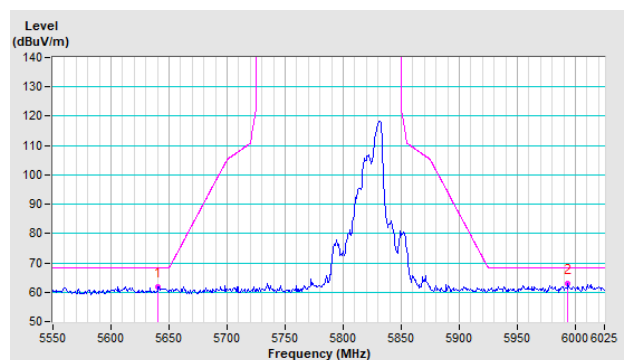

802.11ax (20MHz)

CH 149 5745 MHz

Horizontal

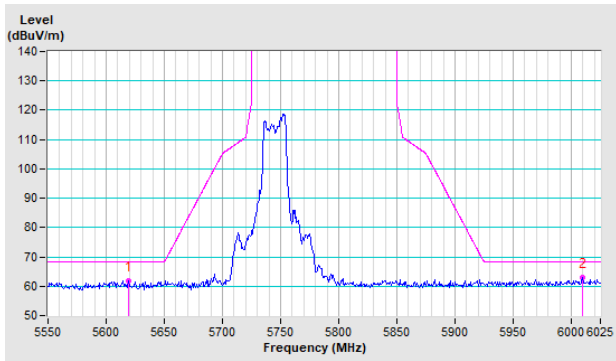

Vertical

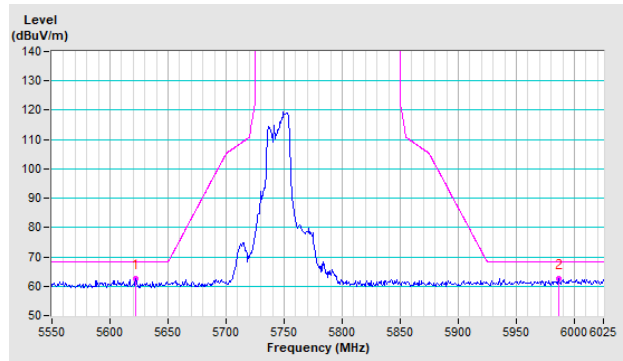

CH 157 5785 MHz

Horizontal

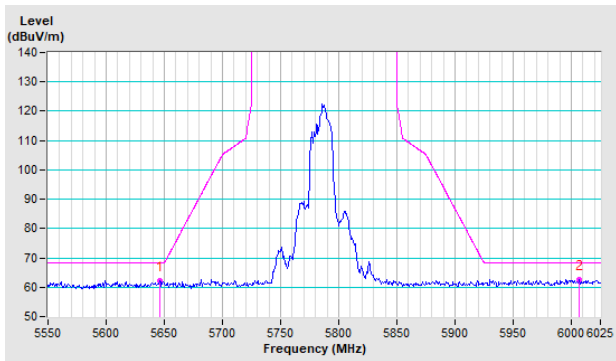

Vertical

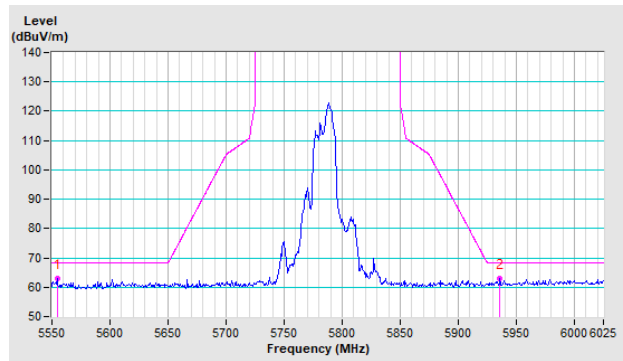

CH 165 5825 MHz

Horizontal

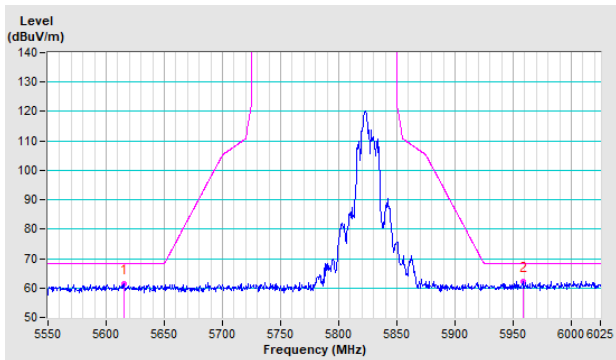

Vertical

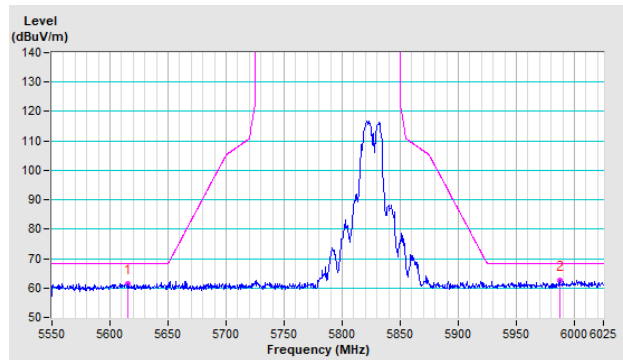

802.11ax (40MHz)

CH 151 5755 MHz

Horizontal

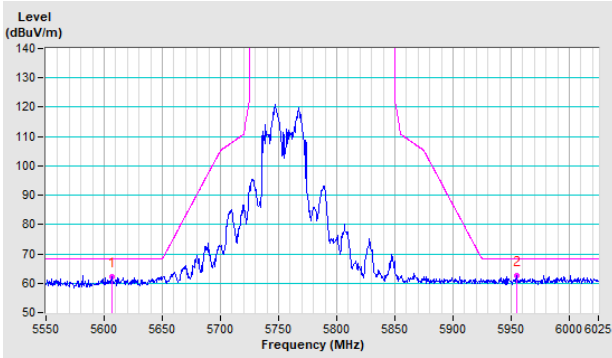

Vertical

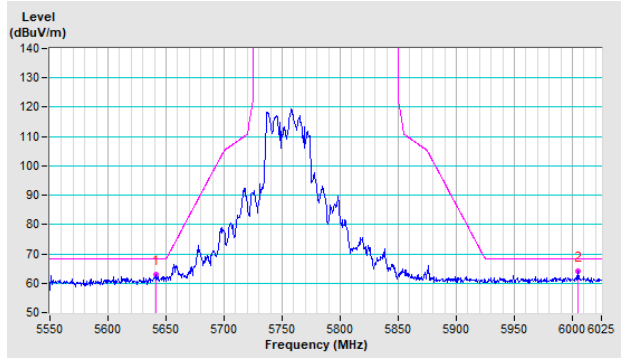

CH 159 5795 MHz

Horizontal

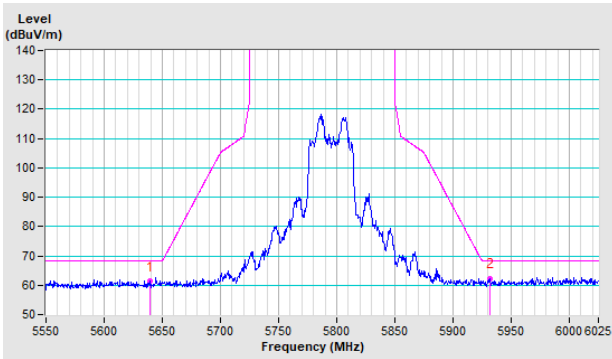

Vertical

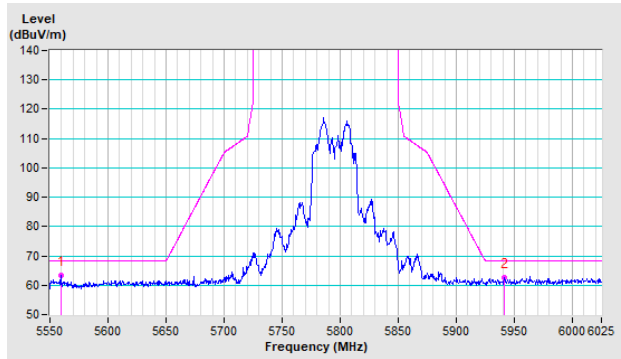

802.11ax (80MHz)

CH 155 5775 MHz

Horizontal

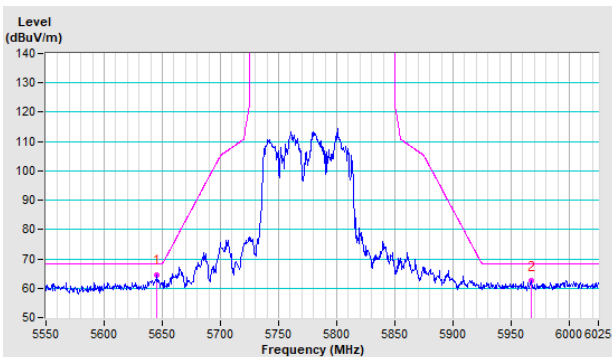

Vertical

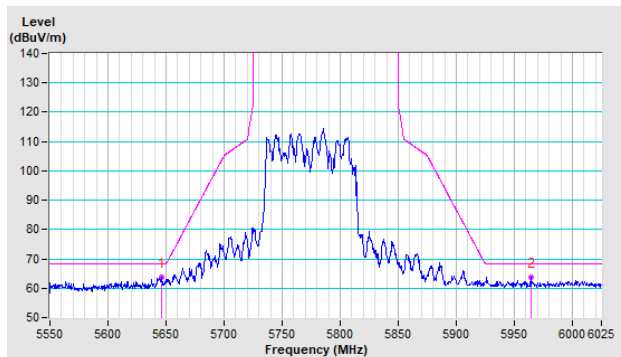

Annex B- Band Edge Measurement

CDD Mode

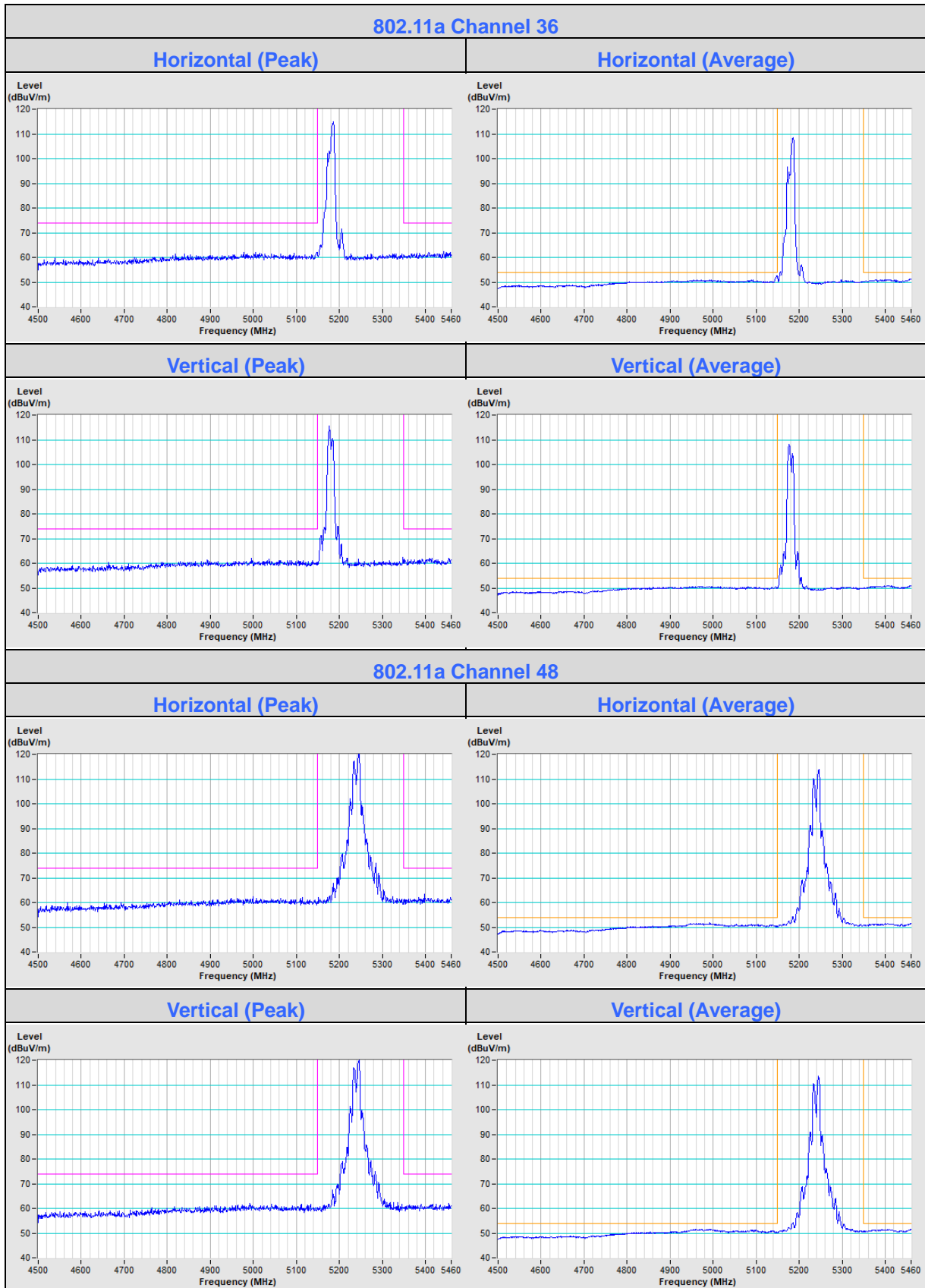

802.11ax (20MHz) Channel 36

Horizontal (Peak)

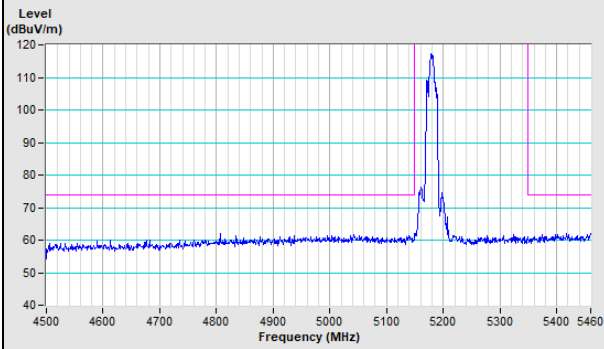

Horizontal (Average)

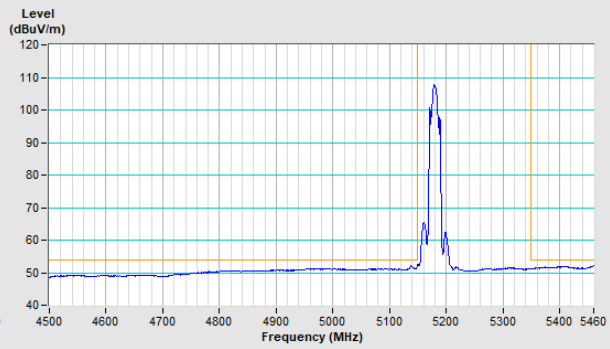

Vertical (Peak)

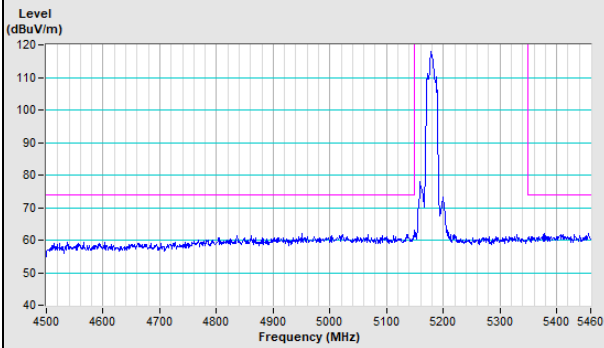

Vertical (Average)

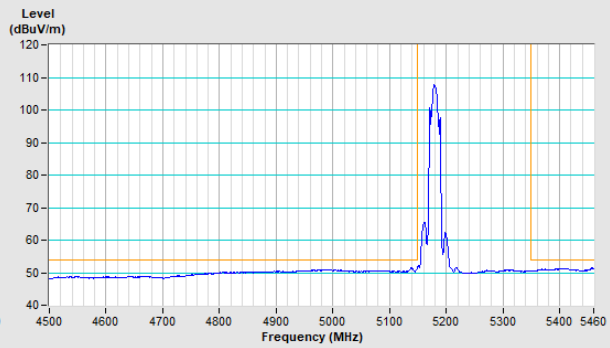

802.11ax (20MHz) Channel 40

Horizontal (Peak)

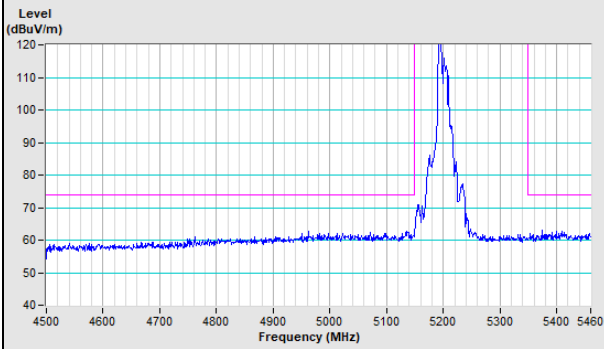

Horizontal (Average)

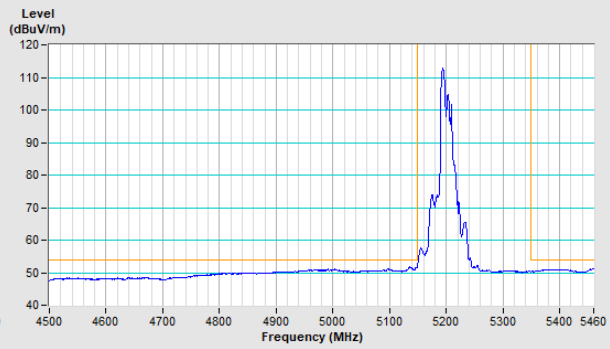

Vertical (Peak)

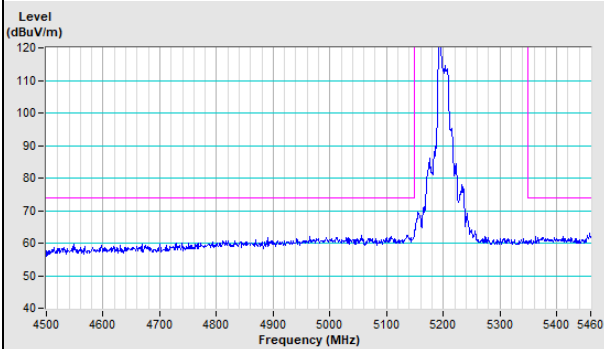

Vertical (Average)

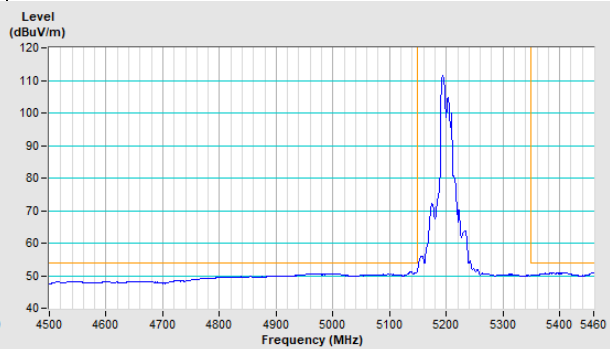

802.11ax (20MHz) Channel 48

Horizontal (Peak)

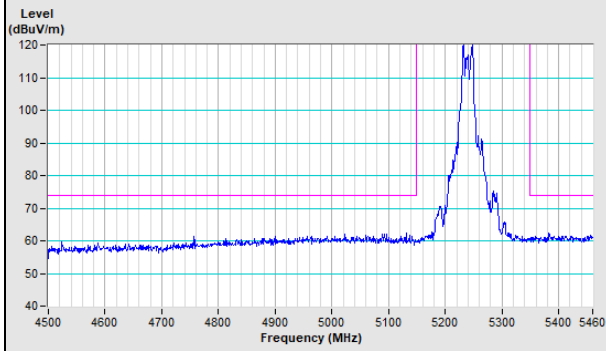

Horizontal (Average)

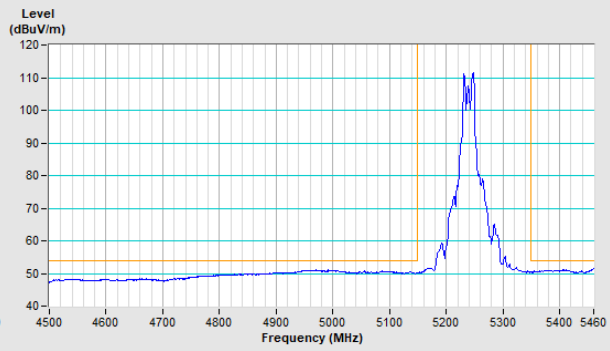

Vertical (Peak)

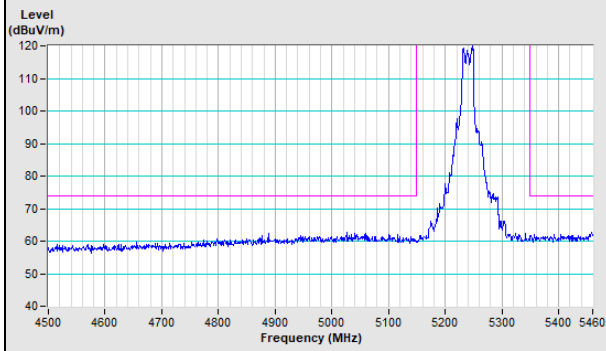

Vertical (Average)

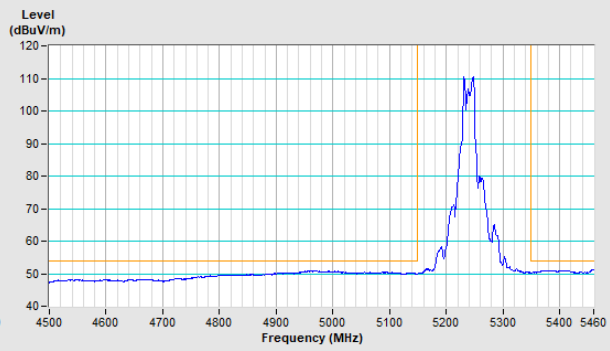

802.11ax (40MHz) Channel 38

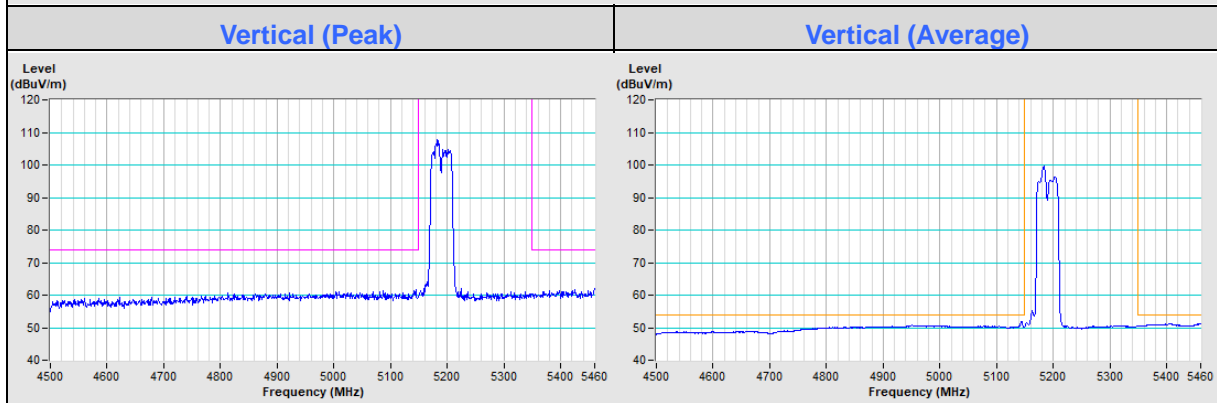
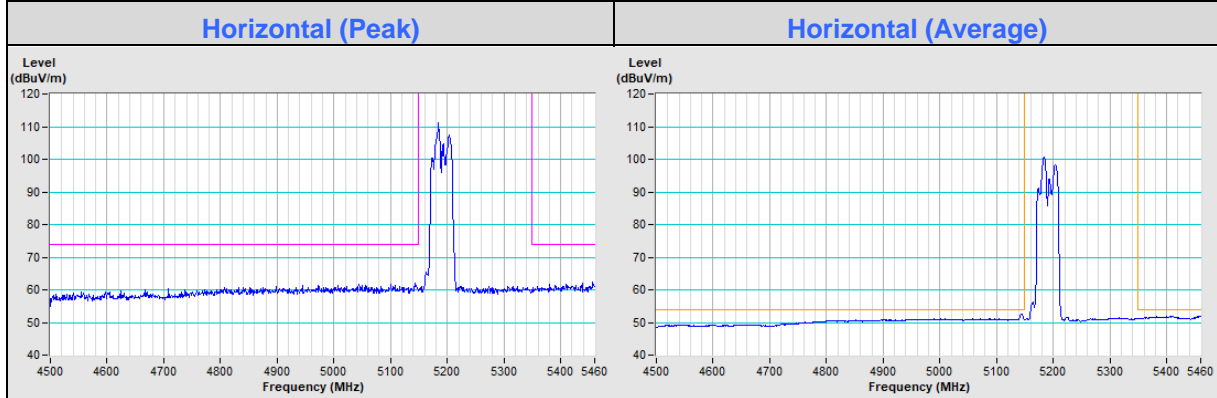

802.11ax (40MHz) Channel 46

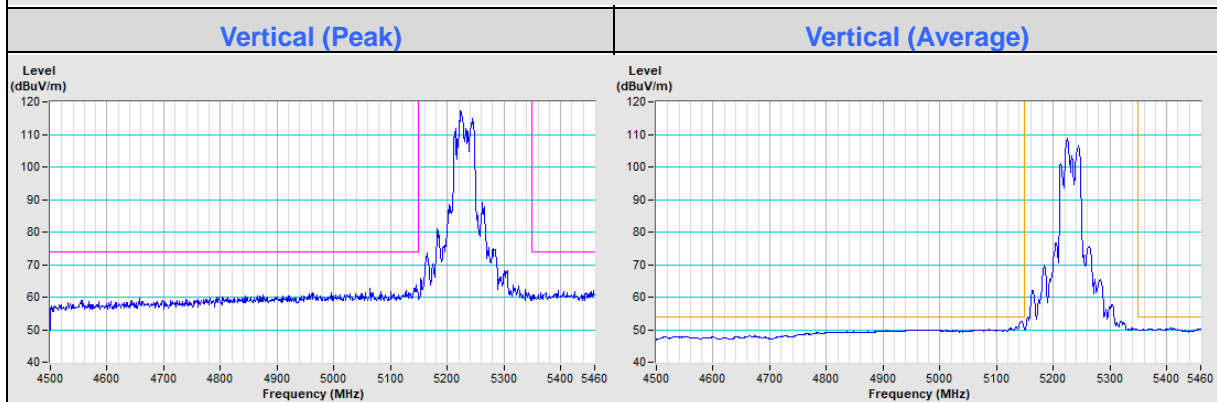
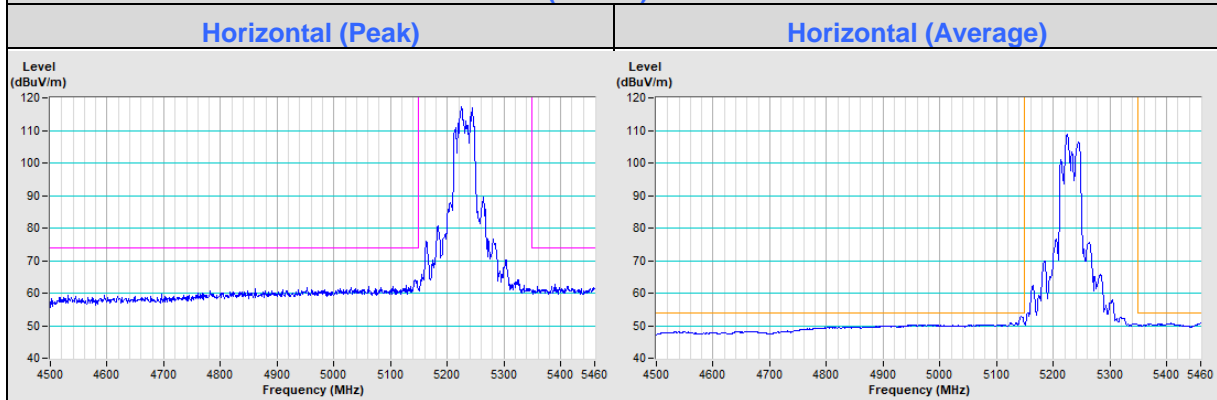

802.11ax (80MHz) Channel 42

Horizontal (Peak)

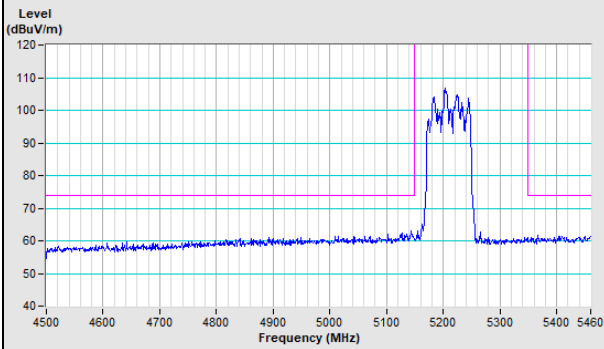

Horizontal (Average)

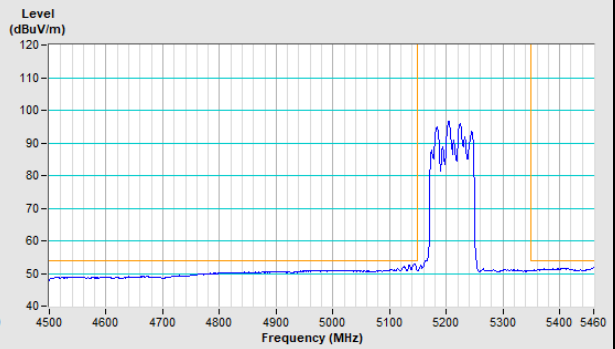

Vertical (Peak)

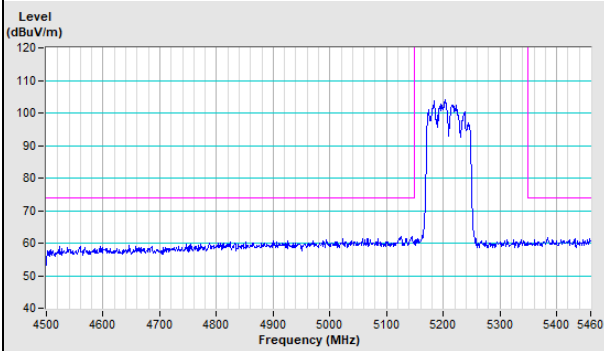

Vertical (Average)

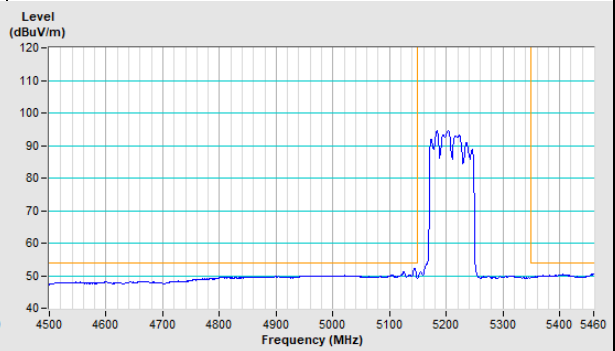

Appendix – Information of the Testing Laboratories

We, Bureau Veritas Consumer Products Services (H.K.) Ltd., Taoyuan Branch, were founded in 1988 to provide our best service in EMC, Radio, Telecom and Safety consultation. Our laboratories are FCC recognized accredited test firms and accredited and approved according to ISO/IEC 17025.

If you have any comments, please feel free to contact us at the following:

Lin Kou EMC/RF Lab

Tel: 886-2-26052180

Fax: 886-2-26051924

Hsin Chu EMC/RF/Telecom Lab

Tel: 886-3-6668565

Fax: 886-3-6668323

Hwa Ya EMC/RF/Safety Lab

Tel: 886-3-3183232

Fax: 886-3-3270892

Email: service.adt@tw.bureauveritas.com

Web Site: www.bureauveritas-adt.com

The address and road map of all our labs can be found in our web site also.

--- END ---