

DECLARATION OF COMPLIANCE SAR RF EXPOSURE EVALUATION

Test Lab

CELLTECH LABS INC.
Testing and Engineering Services
1955 Moss Court
Kelowna, B.C.
Canada V1Y 9L3
Phone: 250-448-7047
Fax: 250-448-7046
e-mail: info@celltechlabs.com
web site: www.celltechlabs.com

Applicant Information

GIANT ELECTRONICS LTD.
7/F, Elite Industrial Bldg.
135-137 Hoi Bun Road
Kwun Tong, Kowloon
Hong Kong

Rule Part(s):	FCC 47 CFR §2.1093; IC RSS-102 Issue 1 (Provisional)
Test Procedure(s):	FCC OET Bulletin 65, Supplement C (Edition 01-01)
Device Type:	Portable UHF FRS/GMRS PTT Radio Transceiver
FCC IDENTIFIER:	K7GT5500
Model(s):	T5500 / T5510 / T5520 / T5550
Modulation:	FM (UHF)
Tx Frequency Range(s):	462.5500 - 462.7250 MHz (GMRS Channels 15-22) 462.5625 - 462.7125 MHz (FRS/GMRS Channels 1-7) 467.5625 - 467.7125 MHz (FRS Channels 8-14)
RF Output Power Tested:	0.275 Watts ERP (GMRS 462.7125 MHz)
Antenna Type(s) Tested:	Fixed
Battery Type(s) Tested:	NiCd (4.2 V, 600mAh), Alkaline x3 (1.5 V AA) Alkaline Type 1: Duracell Procell (2850 mAh) Alkaline Type 2: Energizer E-Squared (3135 mAh)
Body-Worn Accessories Tested:	Plastic Belt-Clip (P/N: KEM-P5960A) Earbud with Lapel-Microphone (P/N: NTN8870C) Headset with Boom-Microphone (P/N: NTN8868B)
Max. SAR Measured:	0.296 W/kg - Face-held (50% duty cycle) 0.260 W/kg - Body-worn (50% duty cycle)

Celltech Labs Inc. declares under its sole responsibility that this wireless portable device has demonstrated compliance with the Specific Absorption Rate (SAR) RF exposure requirements specified in FCC 47 CFR §2.1093 and Health Canada's Safety Code 6. The device was tested in accordance with the measurement standards and procedures specified in FCC OET Bulletin 65, Supplement C (Edition 01-01) and Industry Canada RSS-102 Issue 1 (Provisional) for the General Population / Uncontrolled Exposure environment. All measurements were performed in accordance with the SAR system manufacturer recommendations.

I attest to the accuracy of data. All measurements were performed by me or were made under my supervision and are correct to the best of my knowledge and belief. I assume full responsibility for the completeness of these measurements and vouch for the qualifications of all persons taking them.

This test report shall not be reproduced partially, or in full, without the prior written approval of Celltech Labs Inc. The results and statements contained in this report pertain only to the device(s) evaluated.



Russell W. Pipe
Senior Compliance Technologist
Celltech Labs Inc.



TABLE OF CONTENTS		
1.0	INTRODUCTION.....	3
2.0	DESCRIPTION OF DUT.....	3
3.0	SAR MEASUREMENT SYSTEM	4
4.0	MEASUREMENT SUMMARY.....	5
5.0	DETAILS OF SAR EVALUATION.....	6
6.0	EVALUATION PROCEDURES.....	6
7.0	SYSTEM PERFORMANCE CHECK.....	7
8.0	SIMULATED EQUIVALENT TISSUES.....	8
9.0	SAR SAFETY LIMITS.....	8
10.0	ROBOT SYSTEM SPECIFICATIONS.....	9
11.0	PROBE SPECIFICATION.....	10
12.0	PLANAR PHANTOM.....	10
13.0	VALIDATION PHANTOM.....	10
14.0	DEVICE HOLDER.....	10
15.0	TEST EQUIPMENT LIST.....	11
16.0	MEASUREMENT UNCERTAINTIES.....	12-13
17.0	REFERENCES.....	14
	APPENDIX A - SAR MEASUREMENT DATA.....	15
	APPENDIX B - SYSTEM PERFORMANCE CHECK DATA.....	16
	APPENDIX C - SYSTEM VALIDATION PROCEDURES.....	17
	APPENDIX D - PROBE CALIBRATION.....	18
	APPENDIX E - MEASURED FLUID DIELECTRIC PARAMETERS.....	19
	APPENDIX F - SAR TEST SETUP & DUT PHOTOGRAPHS.....	20

1.0 INTRODUCTION

This measurement report demonstrates compliance of the Giant Electronics Ltd. Models: T5500 / T5510 / T5520 / T5550 Portable UHF FRS/GMRS PTT Radio Transceiver FCC ID: K7GT5500 with the SAR (Specific Absorption Rate) RF exposure requirements specified in FCC 47 CFR §2.1093 (see reference [1]), and Health Canada’s Safety Code 6 (see reference [2]) for the General Population / Uncontrolled Exposure environment. The test procedures described in FCC OET Bulletin 65, Supplement C (Edition 01-01) (see reference [3]) and IC RSS-102 Issue 1 (Provisional) (see reference [4]), were employed. A description of the product and operating configuration, detailed summary of the test results, methodology and procedures used in the evaluation, equipment used, and the various provisions of the rules are included within this test report.

2.0 DESCRIPTION OF DEVICE UNDER TEST (DUT)

Rule Part(s)	FCC 47 CFR §2.1093		
IC Rule Part(s)	RSS-102 Issue 1 (Provisional)		
Test Procedure	FCC OET Bulletin 65, Supplement C (01-01)		
Device Type	Portable UHF FRS/GMRS PTT Radio Transceiver		
FCC IDENTIFIER	K7GT5500		
Model(s)	T5500 / T5510 / T5520 / T5550		
Serial No.	# 3 (Production Unit)		
Modulation	FM (UHF)		
Tx Frequency Range(s)	462.5500 - 462.7250 MHz (GMRS Channels 15-22)		
	462.5625 - 462.7125 MHz (FRS/GMRS Channels 1-7)		
	467.5625 - 467.7125 MHz (FRS Channels 8-14)		
RF Output Power Tested	0.275 Watts ERP (GMRS 462.7125 MHz)		
Battery Type(s) Tested	NiCd	4.2 V	600mAh
	Alkaline	1.5 V AA (x3)	Duracell Procell 2850mAh
Energizer E-Squared 3135mAh			
Antenna Type(s) Tested	Fixed		
Body-Worn Accessories Tested	Plastic Belt-Clip (P/N: KEM-P5960A)		
	Earbud with Lapel-Microphone (P/N: NTN8870C)		
	Headset with Boom-Microphone (P/N: NTN8868B)		

3.0 SAR MEASUREMENT SYSTEM

Celltech Labs Inc. SAR measurement facility utilizes the Dosimetric Assessment System (DASY™) manufactured by Schmid & Partner Engineering AG (SPEAG™) of Zurich, Switzerland. The DASY4 measurement system is comprised of the measurement server, robot controller, computer, near-field probe, probe alignment sensor, specific anthropomorphic mannequin (SAM) phantom, and various planar phantoms for brain and/or body SAR evaluations. The robot is a six-axis industrial robot performing precise movements to position the probe to the location (points) of maximum electromagnetic field (EMF). A cell controller system contains the power supply, robot controller, teach pendant (Joystick), and remote control, is used to drive the robot motors. The Staubli robot is connected to the cell controller to allow software manipulation of the robot. A data acquisition electronic (DAE) circuit performs the signal amplification, signal multiplexing, AD-conversion, offset measurements, mechanical surface detection, collision detection, etc. is connected to the Electro-optical coupler (EOC). The EOC performs the conversion from the optical into digital electric signal of the DAE and transfers data to the DASY4 measurement server. The DAE4 utilizes a highly sensitive electrometer-grade preamplifier with auto-zeroing, a channel and gain-switching multiplexer, a fast 16-bit AD-converter and a command decoder and control logic unit. Transmission to the DASY4 measurement server is accomplished through an optical downlink for data and status information and an optical uplink for commands and clock lines. The mechanical probe-mounting device includes two different sensor systems for frontal and sidewise probe contacts. The sensor systems are also used for mechanical surface detection and probe collision detection. The robot uses its own controller with a built in VME-bus computer.



DASY4 SAR Measurement System with validation phantom



DASY4 SAR Measurement System with Plexiglas planar phantom

4.0 MEASUREMENT SUMMARY

SAR EVALUATION RESULTS

Test Type	Freq. (MHz)	Chan.	Test Mode	Start Power (ERP)	Battery Type	Antenna Position	Body-Worn Accessory	Separation Distance to Planar Phantom (cm)	Measured SAR 1g (W/kg)		SAR Drift (dB)	Scaled SAR 1g (W/kg)	
									Duty Cycle			Duty Cycle	
									100%	50%		100%	50%
Face	462.7125	7	CW	0.275 W	NiCd	Fixed	-	2.5	0.462	0.231	-0.504	0.519	0.260
Face	462.7125	7	CW	0.275 W	Duracell Alkaline	Fixed	-	2.5	0.462	0.231	-0.524	0.521	0.261
Face	462.7125	7	CW	0.275 W	Energizer Alkaline	Fixed	-	2.5	0.527	0.264	-0.501	0.591	0.296
Body	462.7125	7	CW	0.275 W	NiCd	Fixed	Belt-Clip Earbud	1.5	0.455	0.228	-0.583	0.520	0.260
Body	462.7125	7	CW	0.275 W	NiCd	Fixed	Belt-Clip Headset	1.5	0.391	0.196	-0.541	0.443	0.221
Body	462.7125	7	CW	0.275 W	Duracell Alkaline	Fixed	Belt-Clip Earbud	1.5	0.364	0.182	-0.515	0.410	0.205
Body	462.7125	7	CW	0.275 W	Duracell Alkaline	Fixed	Belt-Clip Headset	1.5	0.393	0.197	-0.514	0.442	0.221

ANSI / IEEE C95.1 1992 - SAFETY LIMIT
BRAIN / BODY: 1.6 W/kg (averaged over 1 gram)
Spatial Peak - Uncontrolled Exposure / General Population

Dielectric Constant ϵ_r	450 MHz Brain		450 MHz Body		Ambient Temperature	Brain: 24.0 °C	Body: 25.1 °C
	IEEE Target	Measured	IEEE Target	Measured	Fluid Temperature	Brain: 21.7 °C	Body: 22.8 °C
	43.5 (\pm 5%)	42.4	56.7 (\pm 5%)	56.5	Atmospheric Pressure	Brain: 108.5 kPa	Body: 107.5 kPa
Conductivity σ (mho/m)	450 MHz Brain		450 MHz Body		Relative Humidity	30%	
	IEEE Target	Measured	IEEE Target	Measured	Fluid Depth	\geq 15 cm	
	0.87 (\pm 5%)	0.83	0.94 (\pm 5%)	0.92	ρ (Kg/m ³)	1000	

Note(s):

- The measurement results were obtained with the DUT tested in the conditions described in this report. Detailed measurement data and plots showing the maximum SAR location of the DUT are reported in Appendix A.
- The transmission band of the DUT is less than 10 MHz, therefore mid channel data only is reported (per FCC OET Bulletin 65, Supplement C, Edition 01-01 - see reference [3]).
- The DUT was evaluated for SAR with NiCd battery pack and Duracell Procell alkaline batteries. To report a SAR comparison between alternate alkaline battery types, the evaluation was repeated for the highest SAR level configuration of the Duracell Procell alkaline batteries (face-held) using Energizer E-Squared alkaline batteries.
- The power drifts measured by the DASY system over the duration of the SAR evaluations were $>5\%$. The drifts were subsequently added to the measured SAR levels to report scaled SAR results as shown in the above table.
- SAR versus Time drift evaluations were performed for the duration of the area scan measurement in the test configurations that reported the highest SAR levels for each battery type tested. A SAR versus Time drift evaluation was also performed using an external power source connected to the DUT for the highest scaled SAR level configuration. See Appendix A (SAR Test Plots) for SAR versus Time drift evaluation plots.
- The ambient and fluid temperatures were measured prior to, and during, the fluid dielectric parameter check and the SAR evaluation. The temperatures listed were consistent for all measurement periods.
- The dielectric parameters of the simulated tissues were measured prior to the evaluation using an 85070C Dielectric Probe Kit and an 8753E Network Analyzer (see Appendix E for printout of measured fluid dielectric parameters).
- The SAR evaluations were performed within 24 hours of the system performance check.

5.0 DETAILS OF SAR EVALUATION

The Giant Electronics Ltd. Models: T5500 / T5510 / T5520 / T5550 Portable UHF FRS/GMRS PTT Radio Transceiver FCC ID: K7GT5500 was compliant for localized Specific Absorption Rate (General Population/Uncontrolled Exposure) based on the test provisions and conditions described below. The detailed test setup photographs are shown in Appendix F.

1. The DUT was evaluated in a face-held configuration with the front of the radio placed parallel to the outer surface of the planar phantom. A 2.5 cm separation distance was maintained between the front side of the DUT and the outer surface of the planar phantom for the duration of the tests.
2. The DUT was tested in a body-worn configuration with the back of the radio placed parallel to the outer surface of the planar phantom. The attached plastic belt-clip was touching the planar phantom and provided a 1.5 cm separation distance between the back of the DUT and the outer surface of the planar phantom. The DUT was evaluated for body-worn SAR with the Earbud/Lapel-Microphone accessory, and the Headset/Boom-Microphone accessory.
3. The conducted output power of the DUT could not be measured for the SAR evaluations due to a non-detachable antenna. The DUT was evaluated for SAR at the maximum conducted power level set by the manufacturer.
4. The DUT was evaluated for SAR at the maximum ERP level measured prior to the SAR evaluation on a 3-meter Open Area Test Site using signal substitution method in accordance with ANSI TIA/EIA-603-A-2001.
5. The power drifts measured by the DASY system during the SAR evaluations were >5%. The power drifts were subsequently added to the measured SAR levels to report scaled SAR results as shown in the test data table (page 5).
6. SAR versus time drift evaluations were performed for the duration of the area scan measurement in the test configurations that reported the highest SAR levels for each battery type tested. A SAR versus Time drift evaluation was also performed using an external power source connected to the DUT for the highest scaled SAR level configuration. The SAR versus time drift evaluation plots are shown in Appendix A (SAR Test Plots).
7. The area scan evaluation was performed with fully charged NiCd and alkaline batteries. After the area scan evaluation was completed the batteries were replaced with fully charged batteries prior to the zoom scan evaluation.
8. The DUT was tested in unmodulated continuous transmit operation (Continuous Wave mode at 100% duty cycle) with the transmit key constantly depressed. For a push-to-talk device the 50% duty cycle compensation reported assumes a transmit/receive cycle of equal time base.
9. The SAR evaluations were performed using a Plexiglas planar phantom.
10. A stack of low-density, low-loss dielectric foamed polystyrene was used in place of the device holder.

6.0 EVALUATION PROCEDURES

- a. (i) The evaluation was performed in the applicable area of the phantom depending on the type of device being tested. For devices held to the ear during normal operation, both the left and right ear positions were evaluated using the SAM phantom.
(ii) For body-worn and face-held devices a planar phantom was used.
- b. The SAR was determined by a pre-defined procedure within the DASY4 software. Upon completion of a reference and optical surface check, the exposed region of the phantom was scanned near the inner surface with a grid spacing of 15mm x 15mm.

An area scan was determined as follows:

- c. Based on the defined area scan grid, a more detailed grid is created to increase the points by a factor of 10. The interpolation function then evaluates all field values between corresponding measurement points.
- d. A linear search is applied to find all the candidate maxima. Subsequently, all maxima are removed that are >2 dB from the global maximum. The remaining maxima are then used to position the cube scans.

A 1g and 10g spatial peak SAR was determined as follows:

- e. Extrapolation is used to find the points between the dipole center of the probe and the surface of the phantom. This data cannot be measured, since the center of the dipoles is 2.7 mm away from the tip of the probe and the distance between the surface and the lowest measuring point is 1.4 mm (see probe calibration document in Appendix D). The extrapolation was based on trivariate quadratics computed from the previously calculated 3D interpolated points nearest the phantom surface.
- f. Interpolated data is used to calculate the average SAR over 1g and 10g cubes by spatially discretizing the entire measured cube. The volume used to determine the averaged SAR is a 1mm grid (42875 interpolated points).
- g. A zoom scan volume of 32 mm x 32 mm x 30 mm (5 x 5 x 7 points) centered at the peak SAR location determined from the area scan is used for all zoom scans for devices with a transmit frequency < 800 MHz. Zoom scans for frequencies ≥ 800 MHz are determined with a scan volume of 30 mm x 30 mm x 30 mm (7 x 7 x 7) to ensure complete capture of the peak spatial-average SAR.

7.0 SYSTEM PERFORMANCE CHECK

Prior to the SAR evaluation a system check was performed with a Plexiglas planar phantom and a 450MHz dipole (see Appendix C for system validation procedures). The dielectric parameters of the simulated brain tissue fluid were measured prior to the system performance check using an 85070C Dielectric Probe Kit and an 8753E Network Analyzer (see Appendix E for printout of measured fluid dielectric parameters). A forward power of 250mW was applied to the dipole and the system was verified to a tolerance of $\pm 10\%$ (see Appendix B for system performance check test plot).

SYSTEM PERFORMANCE CHECK													
Test Date	450MHz Equiv. Tissue	SAR 1g (W/kg)		Dielectric Constant ϵ_r		Conductivity σ (mho/m)		ρ (Kg/m ³)	Amb. Temp. (°C)	Fluid Temp. (°C)	Fluid Depth (cm)	Humid. (%)	Barom. Press. (kPa)
		IEEE Target	Measured	IEEE Target	Measured	IEEE Target	Measured						
02/26/04	Brain	1.23 ($\pm 10\%$)	1.27 (+3.3)	43.5 $\pm 5\%$	42.4	0.87 $\pm 5\%$	0.83	1000	23.5	21.5	≥ 15	30	108.5

Note(s):

- The ambient and fluid temperatures were measured prior to, and during, the fluid dielectric parameter check and the system performance check. The temperatures listed in the table above were consistent for all measurement periods.

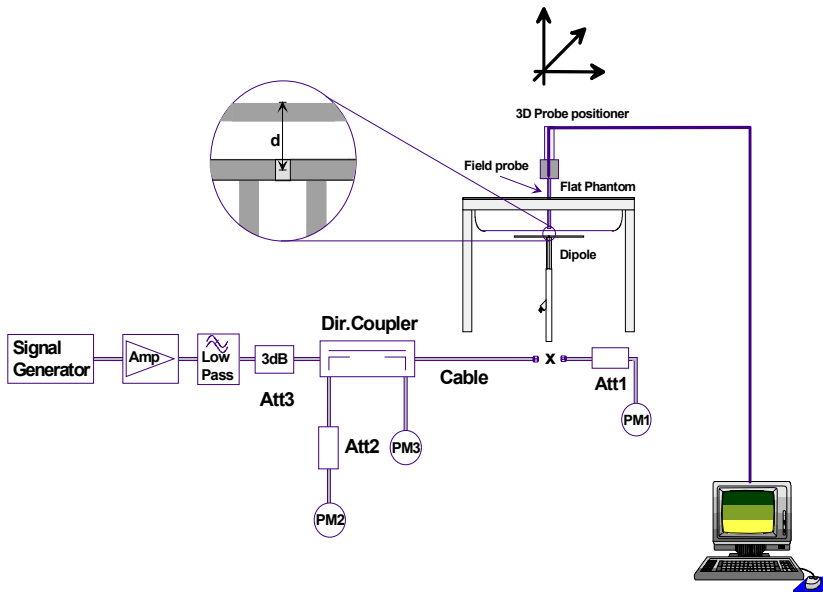
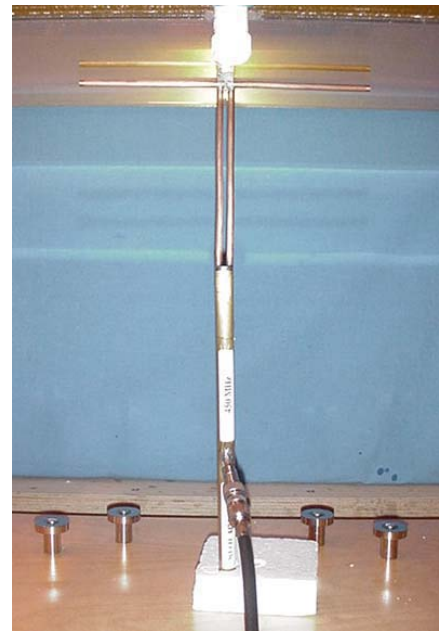

Figure 1. System Performance Check Setup Diagram



450 MHz Dipole Setup

8.0 SIMULATED EQUIVALENT TISSUES

The 450MHz brain and body simulated tissues mixtures consist of a viscous gel using hydroxethylcellulose (HEC) gelling agent and saline solution. Preservation with a bactericide is added and visual inspection is made to ensure air bubbles are not trapped during the mixing process. The fluid was prepared according to standardized procedures, and measured for dielectric parameters (permittivity and conductivity).

SIMULATED TISSUE MIXTURES		
INGREDIENT	450MHz Brain (System Check & DUT Evaluation)	450MHz Body (DUT Evaluation)
Water	38.56 %	52.00 %
Sugar	56.32 %	45.65 %
Salt	3.95 %	1.75 %
HEC	0.98 %	0.50 %
Bactericide	0.19 %	0.10 %

9.0 SAR SAFETY LIMITS

EXPOSURE LIMITS	SAR (W/kg)	
	(General Population / Uncontrolled Exposure Environment)	(Occupational / Controlled Exposure Environment)
Spatial Average (averaged over the whole body)	0.08	0.4
Spatial Peak (averaged over any 1g of tissue)	1.60	8.0
Spatial Peak (hands/wrists/feet/ankles averaged over 10g)	4.0	20.0

Notes:

1. Uncontrolled environments are defined as locations where there is potential exposure of individuals who have no knowledge or control of their potential exposure.
2. Controlled environments are defined as locations where there is potential exposure of individuals who have knowledge of their potential exposure and can exercise control over their exposure.

10.0 ROBOT SYSTEM SPECIFICATIONS

Specifications

POSITIONER: Stäubli Unimation Corp. Robot Model: RX60L
Repeatability: 0.02 mm
No. of axis: 6

Data Acquisition Electronic (DAE) System

Cell Controller

Processor: AMD Athlon XP 2400+
Clock Speed: 2.0 GHz
Operating System: Windows XP Professional

Data Converter

Features: Signal Amplifier, multiplexer, A/D converter, and control logic
Software: DASY4 software
Connecting Lines: Optical downlink for data and status info.
 Optical uplink for commands and clock

DASY4 Measurement Server

Function: Real-time data evaluation for field measurements and surface detection
Hardware: PC/104 166MHz Pentium CPU; 32 MB chipdisk; 64 MB RAM
Connections: COM1, COM2, DAE, Robot, Ethernet, Service Interface

E-Field Probe

Model: ET3DV6
Serial No.: 1590
Construction: Triangular core fiber optic detection system
Frequency: 10 MHz to 6 GHz
Linearity: ± 0.2 dB (30 MHz to 3 GHz)

Phantom(s)

Evaluation Phantom

Type: Planar Phantom
Shell Material: Plexiglas
Bottom Thickness: 2.0 mm \pm 0.1 mm
Outer Dimensions: 75.0 cm (L) x 22.5 cm (W) x 20.5 cm (H); Back Plane: 25.7 cm (H)

Validation Phantom (≤ 450 MHz)

Type: Planar Phantom
Shell Material: Plexiglas
Bottom Thickness: 6.2 mm \pm 0.1 mm
Outer Dimensions: 86.0 cm (L) x 39.5 cm (W) x 21.8 cm (H)

11.0 PROBE SPECIFICATION (ET3DV6)

Construction:	Symmetrical design with triangular core Built-in shielding against static charges PEEK enclosure material (resistant to organic solvents, e.g. glycol)
Calibration:	In air from 10 MHz to 2.5 GHz In brain simulating tissue at frequencies of 900 MHz and 1.8 GHz (accuracy $\pm 8\%$)
Frequency:	10 MHz to > 6 GHz; Linearity: ± 0.2 dB (30 MHz to 3 GHz)
Directivity:	± 0.2 dB in brain tissue (rotation around probe axis) ± 0.4 dB in brain tissue (rotation normal to probe axis)
Dynamic Range:	5 μ W/g to > 100 mW/g; Linearity: ± 0.2 dB
Surface Detection:	± 0.2 mm repeatability in air and clear liquids over diffuse reflecting surfaces
Dimensions:	Overall length: 330 mm Tip length: 16 mm Body diameter: 12 mm Tip diameter: 6.8 mm Distance from probe tip to dipole centers: 2.7 mm
Application:	General dosimetry up to 3 GHz Compliance tests of mobile phone



ET3DV6 E-Field Probe

12.0 PLANAR PHANTOM

The planar phantom is constructed of Plexiglas material with a 2.0 mm shell thickness for face-held and body-worn SAR evaluations of handheld radio transceivers. The planar phantom is mounted on the side of the DASY4 system table.



Plexiglas Planar Phantom

13.0 VALIDATION PLANAR PHANTOM

The validation planar phantom is constructed of Plexiglas material with a 6.0 mm shell thickness for SAR validations at 450MHz and below. The validation planar phantom is mounted in the table of the DASY4 compact system.



Validation Planar Phantom

14.0 DEVICE HOLDER

The DASY4 device holder has two scales for device rotation (with respect to the body axis) and the device inclination (with respect to the line between the ear openings). The plane between the ear openings and the mouth tip has a rotation angle of 65° . The bottom plate contains three pair of bolts for locking the device holder. The device holder positions are adjusted to the standard measurement positions in the three sections.



Device Holder

15.0 TEST EQUIPMENT LIST

TEST EQUIPMENT	SERIAL NO.	CALIBRATION DATE
Schmid & Partner DASY4 System	-	-
DASY4 Measurement Server	1078	N/A
-Robot	599396-01	N/A
-ET3DV6 E-Field Probe	1590	May 2003
-300MHz Validation Dipole	135	Oct 2003
-450MHz Validation Dipole	136	Nov 2003
-900MHz Validation Dipole	054	June 2003
-1800MHz Validation Dipole	247	June 2003
-2450MHz Validation Dipole	150	Sept 2003
-Plexiglas Planar Phantom	161	N/A
-Validation Planar Phantom	137	N/A
HP 85070C Dielectric Probe Kit	N/A	N/A
Gigatronics 8651A Power Meter	8650137	April 2003
Gigatronics 8652A Power Meter	1835267	April 2003
Power Sensor 80701A	1833542	April 2003
Power Sensor 80701A	1834350	April 2003
HP E4408B Spectrum Analyzer	US39240170	Dec 2003
HP 8594E Spectrum Analyzer	3543A02721	April 2003
HP 8753E Network Analyzer	US38433013	May 2003
HP 8648D Signal Generator	3847A00611	May 2003
Amplifier Research 5S1G4 Power Amplifier	26235	N/A

16.0 MEASUREMENT UNCERTAINTIES

UNCERTAINTY BUDGET FOR DEVICE EVALUATION						
Error Description	Uncertainty Value ±%	Probability Distribution	Divisor	C_i 1g	Standard Uncertainty ±% (1g)	V_i or V_{eff}
Measurement System						
Probe calibration	± 4.8	Normal	1	1	± 4.8	∞
Axial isotropy of the probe	± 4.7	Rectangular	√3	(1- c_p)	± 1.9	∞
Spherical isotropy of the probe	± 9.6	Rectangular	√3	(c_p)	± 3.9	∞
Spatial resolution	± 0.0	Rectangular	√3	1	± 0.0	∞
Boundary effects	± 5.5	Rectangular	√3	1	± 3.2	∞
Probe linearity	± 4.7	Rectangular	√3	1	± 2.7	∞
Detection limit	± 1.0	Rectangular	√3	1	± 0.6	∞
Readout electronics	± 1.0	Normal	1	1	± 1.0	∞
Response time	± 0.8	Rectangular	√3	1	± 0.5	∞
Integration time	± 1.4	Rectangular	√3	1	± 0.8	∞
RF ambient conditions	± 3.0	Rectangular	√3	1	± 1.7	∞
Mech. constraints of robot	± 0.4	Rectangular	√3	1	± 0.2	∞
Probe positioning	± 2.9	Rectangular	√3	1	± 1.7	∞
Extrapolation & integration	± 3.9	Rectangular	√3	1	± 2.3	∞
Test Sample Related						
Device positioning	± 6.0	Normal	√3	1	± 6.7	12
Device holder uncertainty	± 5.0	Normal	√3	1	± 5.9	8
Power drift	± 5.0	Rectangular	√3		± 2.9	∞
Phantom and Setup						
Phantom uncertainty	± 4.0	Rectangular	√3	1	± 2.3	∞
Liquid conductivity (target)	± 5.0	Rectangular	√3	0.6	± 1.7	∞
Liquid conductivity (measured)	± 5.0	Rectangular	√3	0.6	± 1.7	∞
Liquid permittivity (target)	± 5.0	Rectangular	√3	0.6	± 1.7	∞
Liquid permittivity (measured)	± 5.0	Rectangular	√3	0.6	± 1.7	∞
Combined Standard Uncertainty					± 13.3	
Expanded Uncertainty (k=2)					± 26.6	

Measurement Uncertainty Table in accordance with IEEE Standard 1528-2003 (see reference [5])

MEASUREMENT UNCERTAINTIES (Cont.)

UNCERTAINTY BUDGET FOR SYSTEM VALIDATION						
Error Description	Uncertainty Value ±%	Probability Distribution	Divisor	C_i 1g	Standard Uncertainty ±% (1g)	V_i or V_{eff}
Measurement System						
Probe calibration	± 4.8	Normal	1	1	± 4.8	∞
Axial isotropy of the probe	± 4.7	Rectangular	√3	(1- c_p)	± 1.9	∞
Spherical isotropy of the probe	± 9.6	Rectangular	√3	(c_p)	± 3.9	∞
Spatial resolution	± 0.0	Rectangular	√3	1	± 0.0	∞
Boundary effects	± 5.5	Rectangular	√3	1	± 3.2	∞
Probe linearity	± 4.7	Rectangular	√3	1	± 2.7	∞
Detection limit	± 1.0	Rectangular	√3	1	± 0.6	∞
Readout electronics	± 1.0	Normal	1	1	± 1.0	∞
Response time	± 0.8	Rectangular	√3	1	± 0.5	∞
Integration time	± 1.4	Rectangular	√3	1	± 0.8	∞
RF ambient conditions	± 3.0	Rectangular	√3	1	± 1.7	∞
Mech. constraints of robot	± 0.4	Rectangular	√3	1	± 0.2	∞
Probe positioning	± 2.9	Rectangular	√3	1	± 1.7	∞
Extrapolation & integration	± 3.9	Rectangular	√3	1	± 2.3	∞
Dipole						
Dipole Axis to Liquid Distance	± 2.0	Rectangular	√3	1	± 1.2	∞
Input Power	± 4.7	Rectangular	√3	1	± 2.7	∞
Phantom and Setup						
Phantom uncertainty	± 4.0	Rectangular	√3	1	± 2.3	∞
Liquid conductivity (target)	± 5.0	Rectangular	√3	0.6	± 1.7	∞
Liquid conductivity (measured)	± 5.0	Rectangular	√3	0.6	± 1.7	∞
Liquid permittivity (target)	± 5.0	Rectangular	√3	0.6	± 1.7	∞
Liquid permittivity (measured)	± 5.0	Rectangular	√3	0.6	± 1.7	∞
Combined Standard Uncertainty					± 9.9	
Expanded Uncertainty (k=2)					± 19.8	

Measurement Uncertainty Table in accordance with IEEE Standard 1528-2003 (see reference [5])

17.0 REFERENCES

- [1] Federal Communications Commission, "Radiofrequency radiation exposure evaluation: portable devices", Rule Part 47 CFR §2.1093: 1999.
- [2] Health Canada, "Limits of Human Exposure to Radiofrequency Electromagnetic Fields in the Frequency Range from 3 kHz to 300 GHz", Safety Code 6.
- [3] Federal Communications Commission, "Evaluating Compliance with FCC Guidelines for Human Exposure to Radio frequency Electromagnetic Fields", OET Bulletin 65, Supplement C (Edition 01-01), FCC, Washington, D.C.: June 2001.
- [4] Industry Canada, "Evaluation Procedure for Mobile and Portable Radio Transmitters with respect to Health Canada's Safety Code 6 for Exposure of Humans to Radio Frequency Fields", Radio Standards Specification RSS-102 Issue 1 (Provisional): September 1999.
- [5] IEEE Standard 1528-2003, "Recommended Practice for Determining the Peak Spatial-Average Specific Absorption Rate (SAR) in the Human Head from Wireless Communications Devices: Measurement Techniques".

Test Report S/N:	021704-479K7G
Test Date(s):	February 26, 2004
Test Type:	FCC/IC SAR Evaluation

APPENDIX A - SAR MEASUREMENT DATA

Face-Held SAR - 4.2V 600mAh NiCd Battery Pack

Date Tested: 02/26/04

DUT: Giant Electronics Ltd. Model: T5500; Type: Portable UHF FRS/GMRS PTT Radio Transceiver; Serial: #3

Ambient Temp: 24.0 °C; Fluid Temp: 21.7 °C; Barometric Pressure: 108.5 kPa; Humidity: 30%

4.2V 600mAh NiCd Battery Pack

Communication System: FM UHF

RF Output Power: 0.275 Watts (ERP)

Frequency: 462.7125 MHz; Channel 7; Duty Cycle: 1:1

Medium: HSL450 ($\sigma = 0.83$ mho/m; $\epsilon_r = 42.4$; $\rho = 1000$ kg/m³)

- Probe: ET3DV6 - SN1590; ConvF(7.9, 7.9, 7.9); Calibrated: 15/05/2003
- Sensor-Surface: 4mm (Mechanical Surface Detection)
- Electronics: DAE3 Sn353; Calibrated: 19/12/2003
- Phantom: Planar; Type: Plexiglas; Serial: 161
- Measurement SW: DASY4, V4.2 Build 12; Postprocessing SW: SEMCAD, V1.8 Build 94

Face-Held - 2.5 cm Separation Distance to Planar Phantom/Area Scan (7x13x1):

Measurement grid: dx=15mm, dy=15mm

Face-Held - 2.5 cm Separation Distance to Planar Phantom/Zoom Scan (5x5x7)/Cube 0:

Measurement grid: dx=8mm, dy=8mm, dz=5mm

Peak SAR (extrapolated) = 0.713 W/kg

SAR(1 g) = 0.462 mW/g; SAR(10 g) = 0.328 mW/g

Reference Value = 23.7 V/m

Power Drift = -0.504 dB

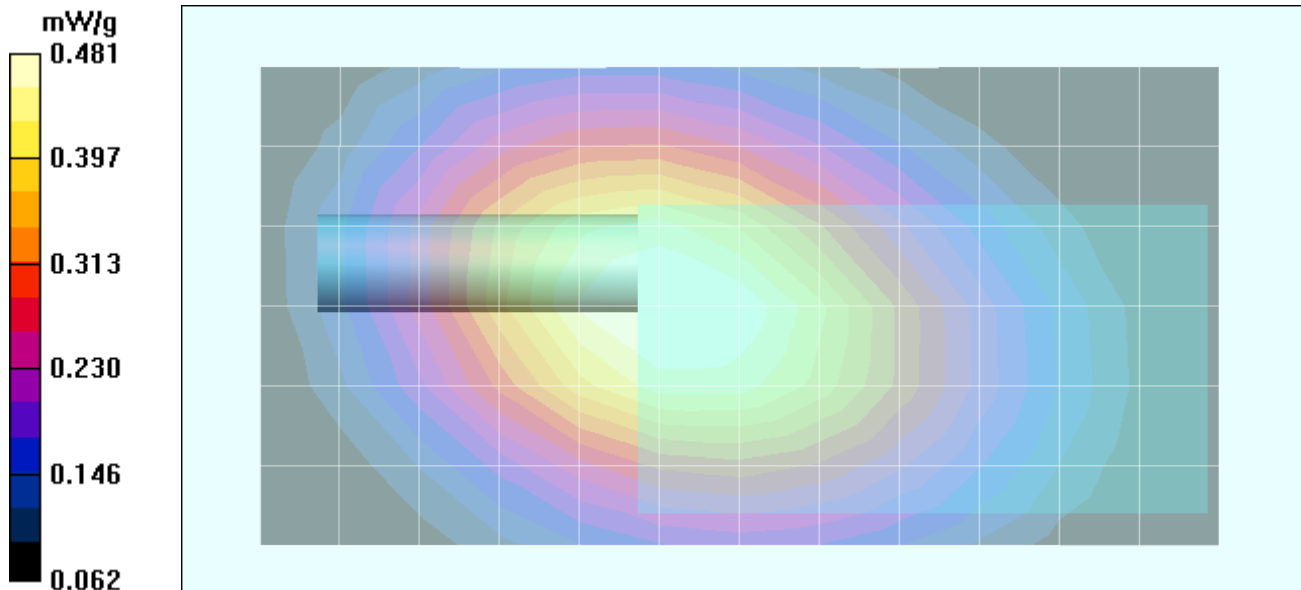

SAR versus Time - 15 minutes - 4.2V 600mAh NiCd Battery Pack

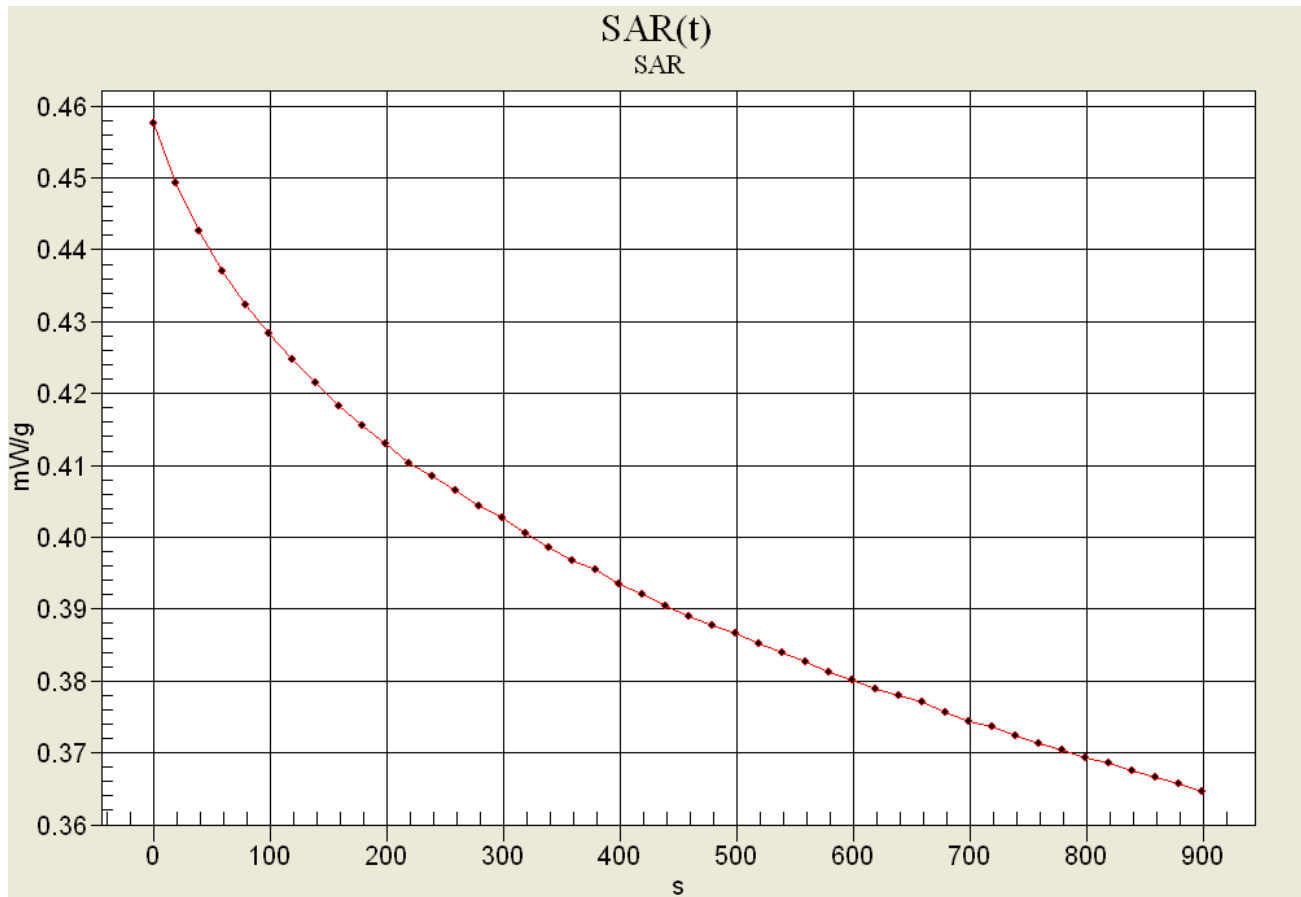

Initial SAR Value: 0.458 mW/g - Start
 6:40 SAR Value: 0.394 mW/g (-0.654 dB drift) - Zoom Scan Duration
 End SAR Value: 0.365 mW/g (-0.986 dB drift) - Area Scan Duration

Face-Held SAR - 2850mAh Alkaline Batteries (Duracell ProCell)

Date Tested: 02/26/04

DUT: Giant Electronics Ltd. Model: T5500; Type: Portable UHF FRS/GMRS PTT Radio Transceiver; Serial: #3

Ambient Temp: 24.0 °C; Fluid Temp: 21.7 °C; Barometric Pressure: 108.5 kPa; Humidity: 30%

1.5V 2850mAh Duracell ProCell AA Alkaline Batteries (x3)
 Communication System: FM UHF
 RF Output Power: 0.275 Watts (ERP)
 Frequency: 462.7125 MHz; Channel 7; Duty Cycle: 1:1
 Medium: HSL450 ($\sigma = 0.83$ mho/m; $\epsilon_r = 42.4$; $\rho = 1000$ kg/m³)

- Probe: ET3DV6 - SN1590; ConvF(7.9, 7.9, 7.9); Calibrated: 15/05/2003
- Sensor-Surface: 4mm (Mechanical Surface Detection)
- Electronics: DAE3 Sn353; Calibrated: 19/12/2003
- Phantom: Planar; Type: Plexiglas; Serial: 161
- Measurement SW: DASy4, V4.2 Build 12; Postprocessing SW: SEMCAD, V1.8 Build 94

Face-Held - 2.5 cm Separation Distance to Planar Phantom/Area Scan (7x13x1):

Measurement grid: dx=15mm, dy=15mm

Face-Held - 2.5 cm Separation Distance to Planar Phantom/Zoom Scan (5x5x7)/Cube 0:

Measurement grid: dx=8mm, dy=8mm, dz=5mm

Peak SAR (extrapolated) = 0.709 W/kg

SAR(1 g) = 0.462 mW/g; SAR(10 g) = 0.328 mW/g

Reference Value = 23.5 V/m

Power Drift = -0.524 dB

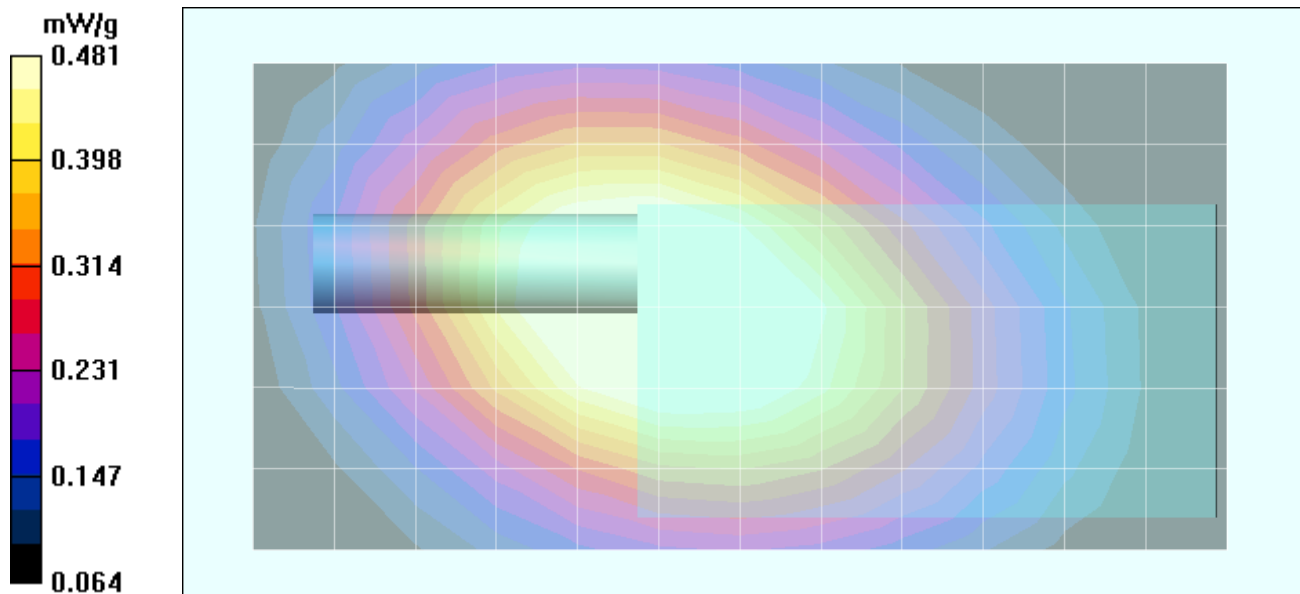

Face-Held SAR - 3135mAh Alkaline Batteries (Energizer E-Squared)

Date Tested: 02/26/04

DUT: Giant Electronics Ltd. Model: T5500; Type: Portable UHF FRS/GMRS PTT Radio Transceiver; Serial: #3

Ambient Temp: 24.0 °C; Fluid Temp: 21.7 °C; Barometric Pressure: 108.5 kPa; Humidity: 30%

1.5V 3135mAh Energizer E-Squared AA Alkaline Batteries (x3)

Communication System: FM UHF

RF Output Power: 0.275 Watts (ERP)

Frequency: 462.7125 MHz; Channel 7; Duty Cycle: 1:1

Medium: HSL450 ($\sigma = 0.83$ mho/m; $\epsilon_r = 42.4$; $\rho = 1000$ kg/m³)

- Probe: ET3DV6 - SN1590; ConvF(7.9, 7.9, 7.9); Calibrated: 15/05/2003
- Sensor-Surface: 4mm (Mechanical Surface Detection)
- Electronics: DAE3 Sn353; Calibrated: 19/12/2003
- Phantom: Planar; Type: Plexiglas; Serial: 161
- Measurement SW: DASY4, V4.2 Build 12; Postprocessing SW: SEMCAD, V1.8 Build 94

Face-Held - 2.5 cm Separation Distance to Planar Phantom/Area Scan (7x13x1):

Measurement grid: dx=15mm, dy=15mm

Face-Held - 2.5 cm Separation Distance to Planar Phantom/Zoom Scan (5x5x7)/Cube 0:

Measurement grid: dx=8mm, dy=8mm, dz=5mm

Peak SAR (extrapolated) = 0.807 W/kg

SAR(1 g) = 0.527 mW/g; SAR(10 g) = 0.374 mW/g

Reference Value = 25.3 V/m

Power Drift = -0.501 dB

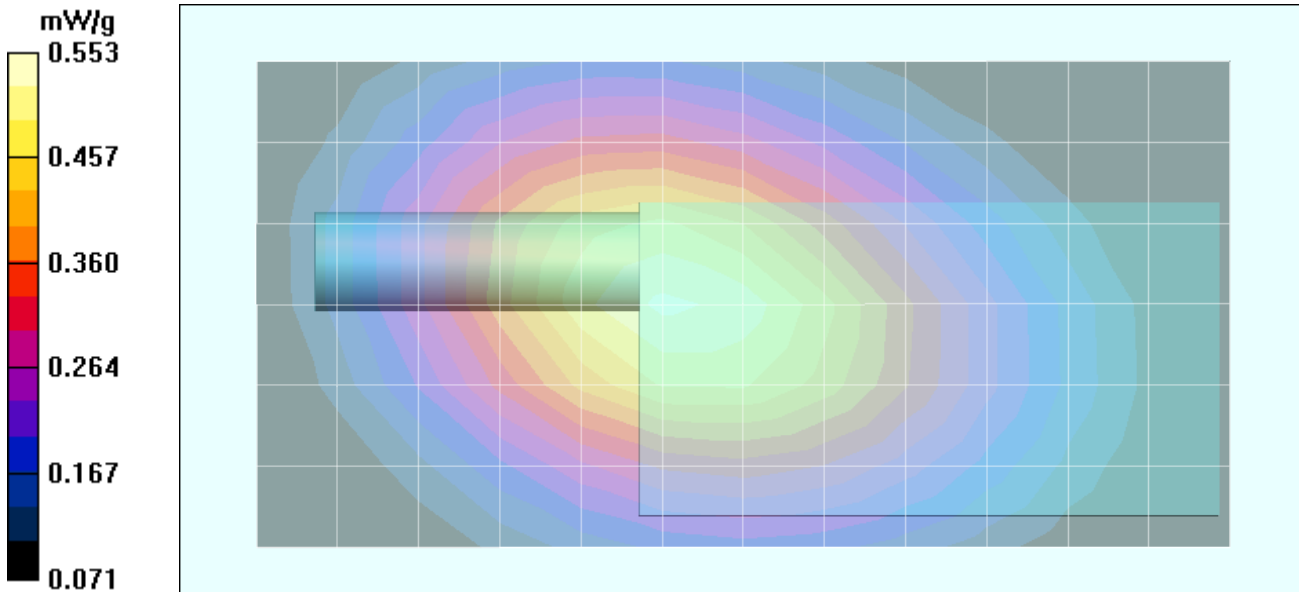

Z-Axis Scan

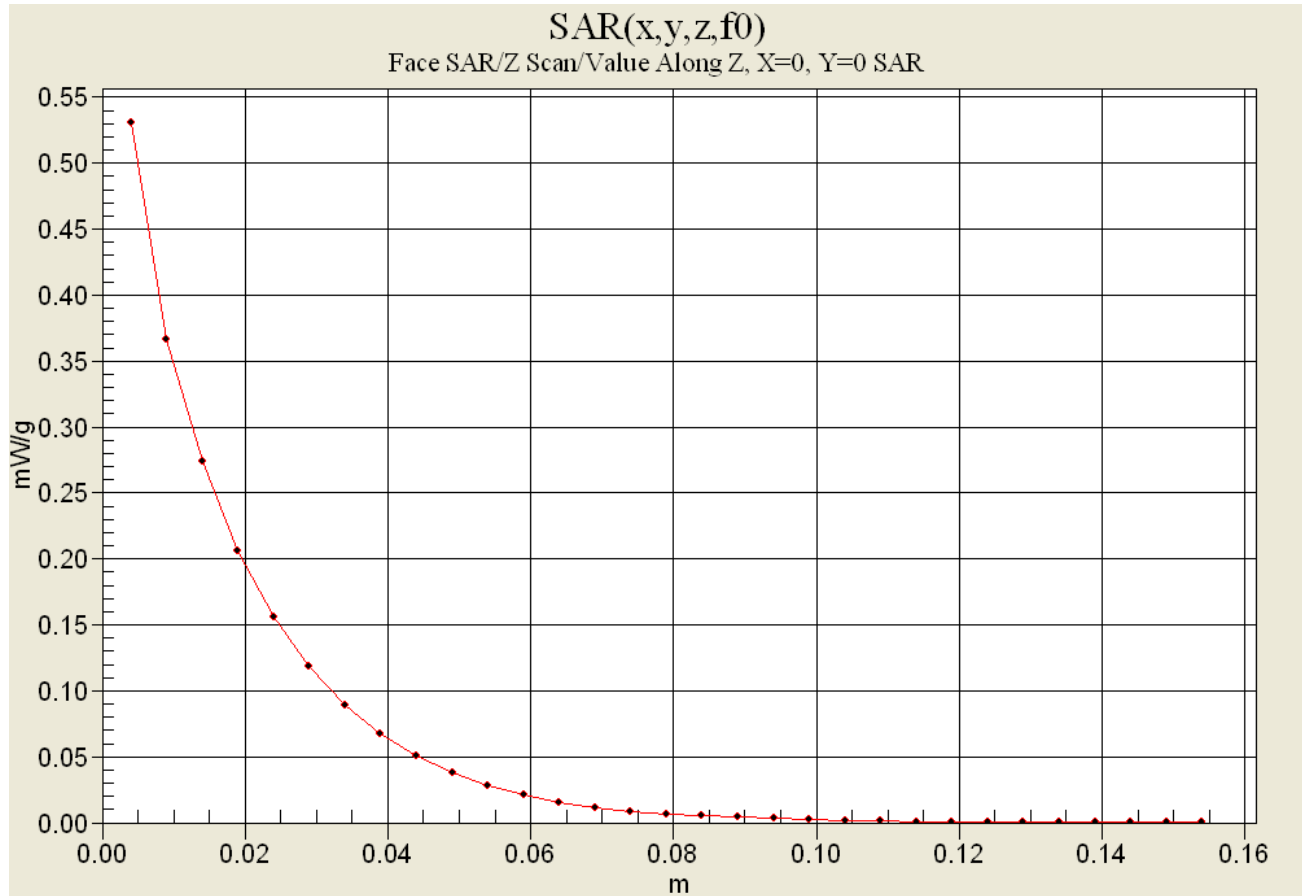

SAR versus Time - 15 minutes - 3135mAh Alkaline Batteries (Energizer E-Squared)

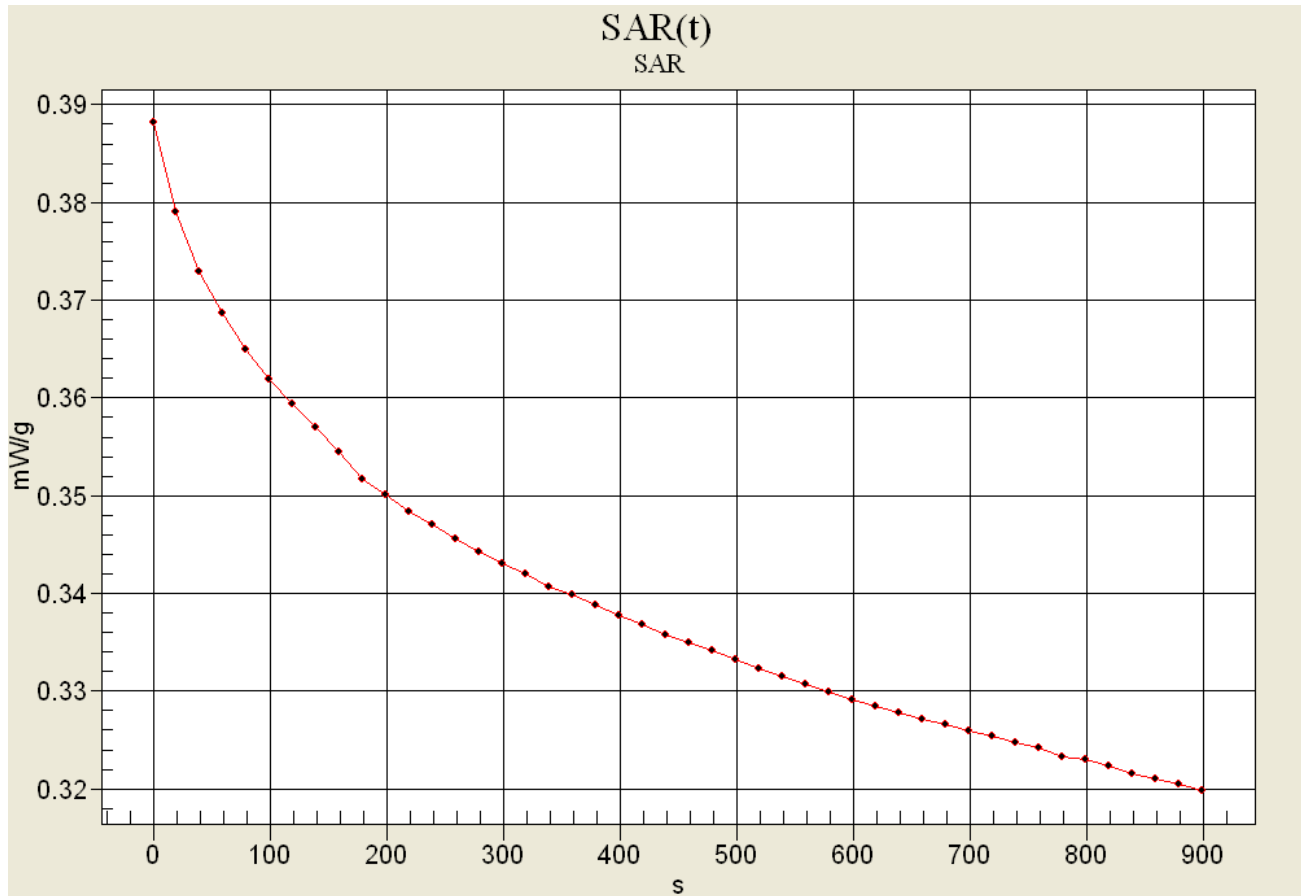

Initial SAR Value: 0.388 mW/g - Start
 6:40 SAR Value: 0.338 mW/g (-0.599 dB drift) - Zoom Scan Duration
 End SAR Value: 0.320 mW/g - (-0.837 dB drift) - Area Scan Duration

SAR versus Time - 15 minutes - External Power Source

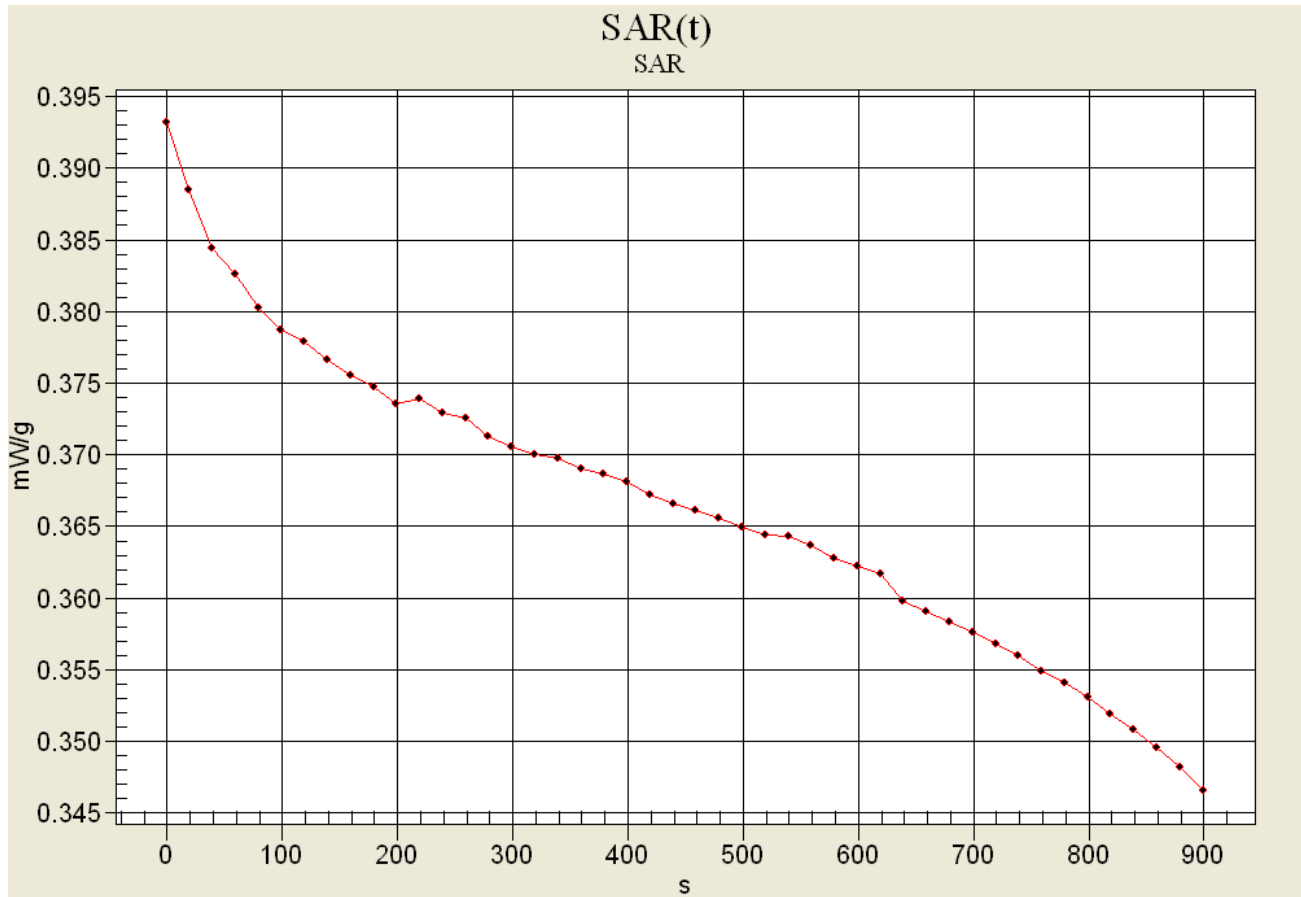

Initial SAR Value: 0.393 mW/g - Start
 6:40 SAR Value: 0.368 mW/g (-0.285 dB drift) - Zoom Scan Duration
 End SAR Value: 0.347 mW/g (-0.541 dB drift) - Area Scan Duration

Body-Worn SAR - 4.2V 600mAh NiCd Battery Pack

Dated Tested: 02/26/04

DUT: Giant Electronics Ltd. Model: T5500; Type: Portable UHF FRS/GMRS PTT Radio Transceiver; Serial: #3

Ambient Temp: 25.1 °C; Fluid Temp: 22.8 °C; Barometric Pressure: 107.5 kPa; Humidity: 30%

Body Worn Accessories: Plastic Belt-Clip, Earbud with Lapel-Microphone

4.2V 600mAh NiCd Battery Pack
 Communication System: FM UHF
 RF Output Power: 0.275 Watts (ERP)
 Frequency: 462.7125 MHz; Channel 7; Duty Cycle: 1:1
 Medium: M450 ($\sigma = 0.92$ mho/m; $\epsilon_r = 56.5$; $\rho = 1000$ kg/m³)

- Probe: ET3DV6 - SN1590; ConvF(8.1, 8.1, 8.1); Calibrated: 15/05/2003
- Sensor-Surface: 4mm (Mechanical Surface Detection)
- Electronics: DAE3 Sn353; Calibrated: 19/12/2003
- Phantom: Planar; Type: Plexiglas; Serial: 161
- Measurement SW: DASY4, V4.2 Build 12; Postprocessing SW: SEMCAD, V1.8 Build 94

Body-Worn - 1.5 cm Plastic Belt-Clip Separation Distance to Planar Phantom/Area Scan (7x13x1):

Measurement grid: dx=15mm, dy=15mm

Body-Worn - 1.5 cm Plastic Belt-Clip Separation Distance to Planar Phantom/Zoom Scan (5x5x7)/Cube 0:

Measurement grid: dx=8mm, dy=8mm, dz=5mm

Peak SAR (extrapolated) = 0.713 W/kg

SAR(1 g) = 0.455 mW/g; SAR(10 g) = 0.317 mW/g

Reference Value = 22.2 V/m

Power Drift = -0.583 dB

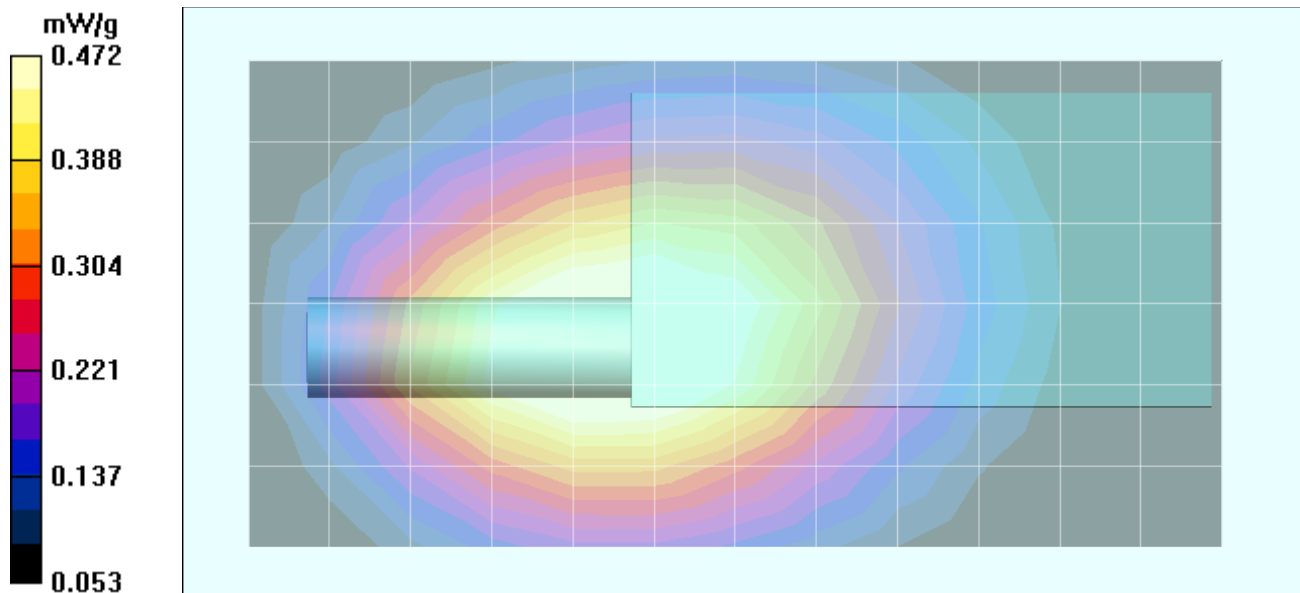

Z-Axis Scan

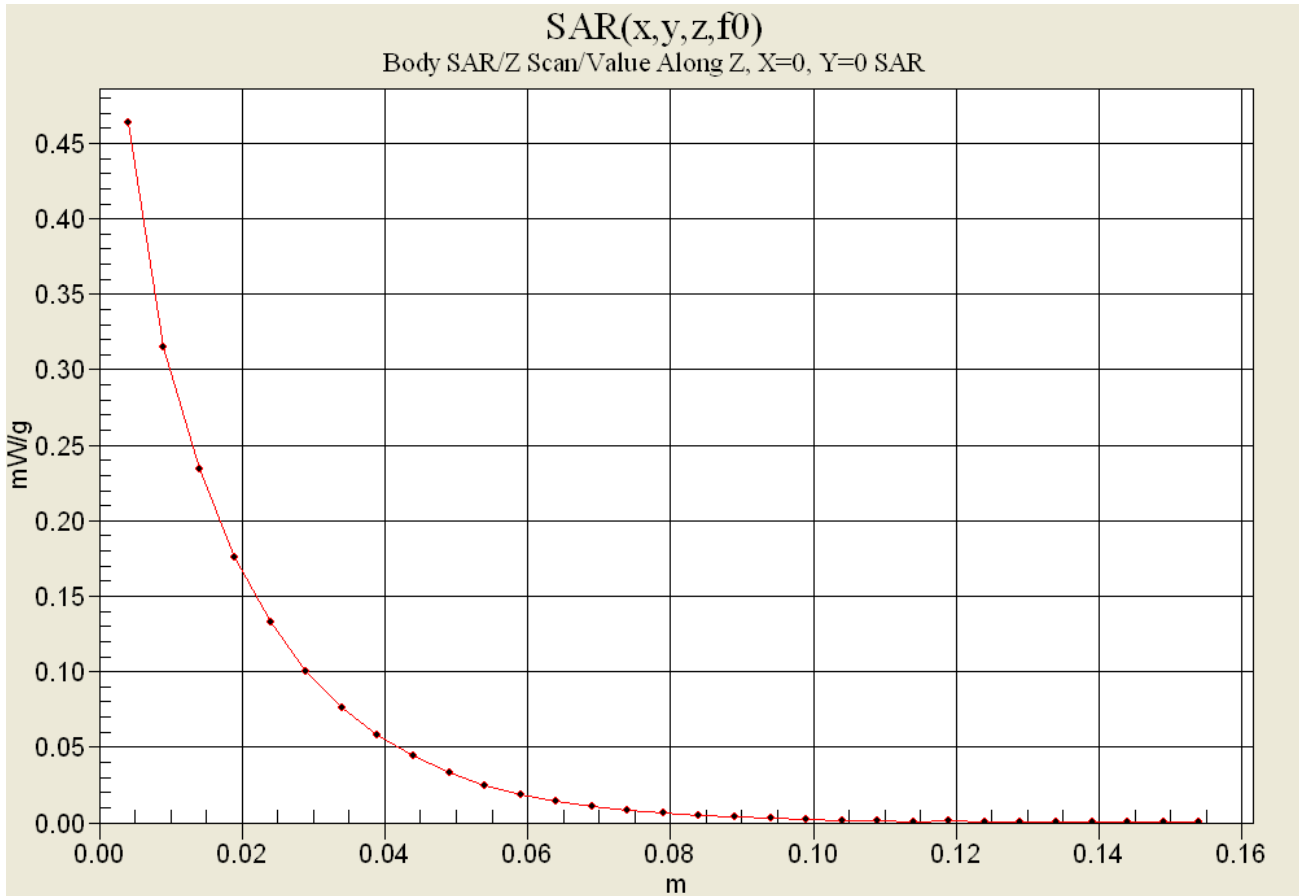

Body-Worn SAR - 4.2V 600mAh NiCd Battery Pack

Date Tested: 02/26/04

DUT: Giant Electronics Ltd. Model: T5500; Type: Portable UHF FRS/GMRS PTT Radio Transceiver; Serial: #3

Ambient Temp: 25.1 °C; Fluid Temp: 22.8 °C; Barometric Pressure: 107.5 kPa; Humidity: 30%

Body Worn Accessories: Plastic Belt-Clip, Headset with Boom-Microphone

4.2V 600mAh NiCd Battery Pack
 Communication System: FM UHF
 RF Output Power: 0.275 Watts (ERP)
 Frequency: 462.7125 MHz; Channel 7; Duty Cycle: 1:1
 Medium: M450 ($\sigma = 0.92$ mho/m; $\epsilon_r = 56.5$; $\rho = 1000$ kg/m³)

- Probe: ET3DV6 - SN1590; ConvF(8.1, 8.1, 8.1); Calibrated: 15/05/2003
- Medium: M450 ($\sigma = 0.92$ mho/m; $\epsilon_r = 56.5$; $\rho = 1000$ kg/m³)
- Sensor-Surface: 4mm (Mechanical Surface Detection)
- Electronics: DAE3 Sn353; Calibrated: 19/12/2003
- Phantom: Planar; Type: Plexiglas; Serial: 161
- Measurement SW: DASY4, V4.2 Build 12; Postprocessing SW: SEMCAD, V1.8 Build 94

Body-Worn - 1.5 cm Plastic Belt-Clip Separation Distance to Planar Phantom/Area Scan (7x13x1):

Measurement grid: dx=15mm, dy=15mm

Body-Worn - 1.5 cm Plastic Belt-Clip Separation Distance to Planar Phantom/Zoom Scan (5x5x7)/Cube 0:

Measurement grid: dx=8mm, dy=8mm, dz=5mm

Peak SAR (extrapolated) = 0.615 W/kg

SAR(1 g) = 0.391 mW/g; SAR(10 g) = 0.272 mW/g

Reference Value = 20.4 V/m

Power Drift = -0.541 dB

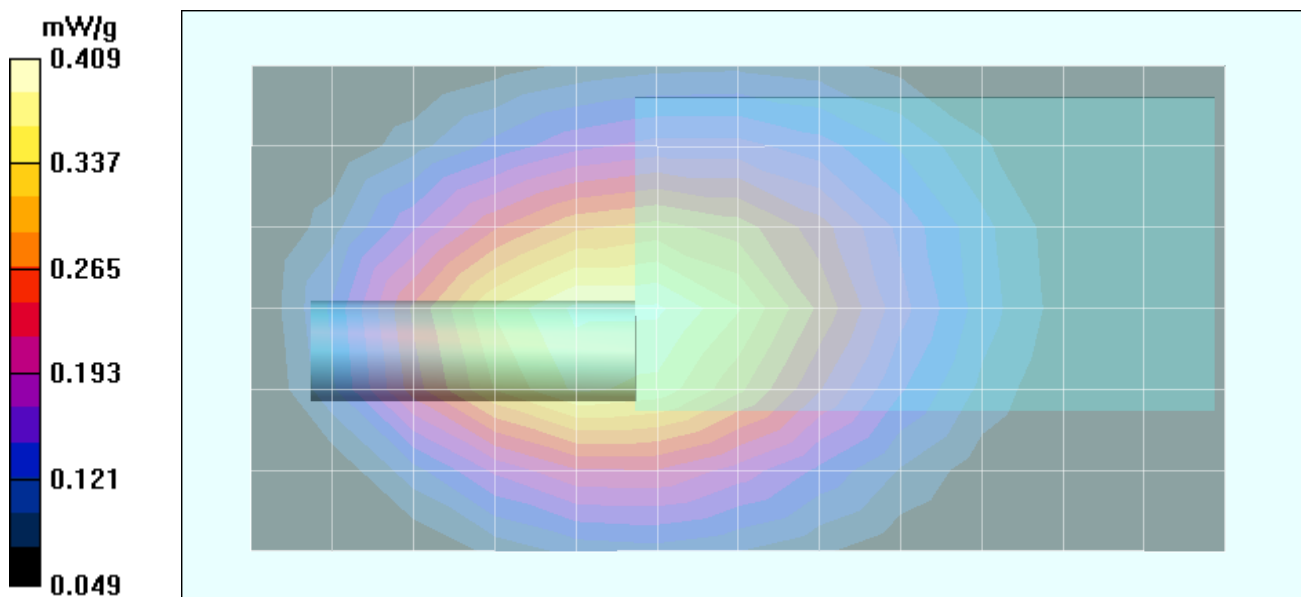

Body-Worn SAR - 2850mAh Alkaline Batteries (Duracell ProCell)

Date Tested: 02/26/04

DUT: Giant Electronics Ltd. Model: T5500; Type: Portable UHF FRS/GMRS PTT Radio Transceiver; Serial: #3

Ambient Temp: 25.1 °C; Fluid Temp: 22.8 °C; Barometric Pressure: 107.5 kPa; Humidity: 30%

Body Worn Accessories: Plastic Belt-Clip, Earbud with Lapel-Microphone

1.5V Duracell ProCell AA Alkaline Batteries (x3)

Communication System: FM UHF

RF Output Power: 0.275 Watts (ERP)

Frequency: 462.7125 MHz; Channel 7; Duty Cycle: 1:1

Medium: M450 ($\sigma = 0.92$ mho/m; $\epsilon_r = 56.5$; $\rho = 1000$ kg/m³)

- Probe: ET3DV6 - SN1590; ConvF(8.1, 8.1, 8.1); Calibrated: 15/05/2003
- Sensor-Surface: 4mm (Mechanical Surface Detection)
- Electronics: DAE3 Sn353; Calibrated: 19/12/2003
- Phantom: Planar; Type: Plexiglas; Serial: 161
- Measurement SW: DASY4, V4.2 Build 12; Postprocessing SW: SEMCAD, V1.8 Build 94

Body-Worn - 1.5 cm Plastic Belt-Clip Separation Distance to Planar Phantom/Area Scan (7x13x1):

Measurement grid: dx=15mm, dy=15mm

Body-Worn - 1.5 cm Plastic Belt-Clip Separation Distance to Planar Phantom/Zoom Scan (5x5x7)/Cube 0:

Measurement grid: dx=8mm, dy=8mm, dz=5mm

Peak SAR (extrapolated) = 0.571 W/kg

SAR(1 g) = 0.364 mW/g; SAR(10 g) = 0.256 mW/g

Reference Value = 19.6 V/m

Power Drift = -0.515 dB

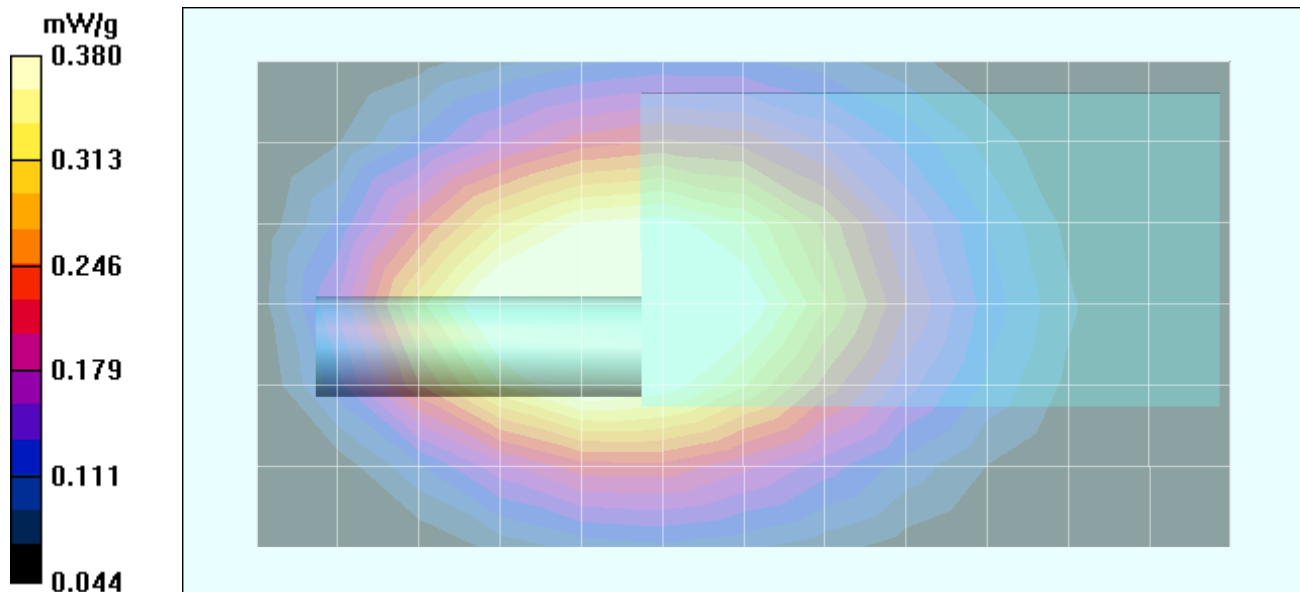

Body-Worn SAR - 2850mAh Alkaline Batteries (Duracell ProCell)

Date Tested: 02/26/04

DUT: Giant Electronics Ltd. Model: T5500; Type: Portable UHF FRS/GMRS PTT Radio Transceiver; Serial: #3

Ambient Temp: 25.1 °C; Fluid Temp: 22.8 °C; Barometric Pressure: 107.5 kPa; Humidity: 30%

Body Worn Accessories: Plastic Belt-Clip, Headset with Boom-Microphone

1.5V Duracell ProCell AA Alkaline Batteries (x3)

Communication System: FM UHF

RF Output Power: 0.275 Watts (ERP)

Frequency: 462.7125 MHz; Channel 7; Duty Cycle: 1:1

Medium: M450 ($\sigma = 0.92$ mho/m; $\epsilon_r = 56.5$; $\rho = 1000$ kg/m³)

- Probe: ET3DV6 - SN1590; ConvF(8.1, 8.1, 8.1); Calibrated: 15/05/2003
- Sensor-Surface: 4mm (Mechanical Surface Detection)
- Electronics: DAE3 Sn353; Calibrated: 19/12/2003
- Phantom: Planar; Type: Plexiglas; Serial: 161
- Measurement SW: DASy4, V4.2 Build 12; Postprocessing SW: SEMCAD, V1.8 Build 94

Body-Worn - 1.5 cm Plastic Belt-Clip Separation Distance to Planar Phantom/Area Scan (7x13x1):

Measurement grid: dx=15mm, dy=15mm

Body-Worn - 1.5 cm Plastic Belt-Clip Separation Distance to Planar Phantom/Zoom Scan (5x5x7)/Cube 0:

Measurement grid: dx=8mm, dy=8mm, dz=5mm

Peak SAR (extrapolated) = 0.615 W/kg

SAR(1 g) = 0.393 mW/g; SAR(10 g) = 0.274 mW/g

Reference Value = 19.9 V/m

Power Drift = -0.514 dB

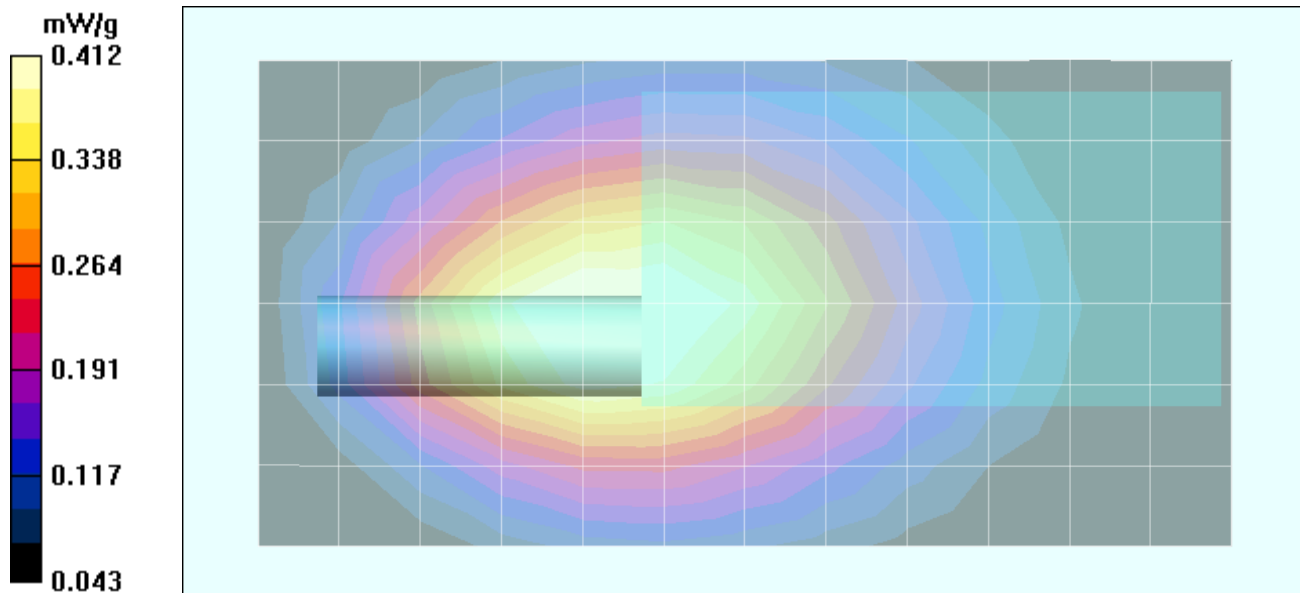

Test Report S/N:	021704-479K7G
Test Date(s):	February 26, 2004
Test Type:	FCC/IC SAR Evaluation

APPENDIX B - SYSTEM PERFORMANCE CHECK DATA

System Performance Check - 450 MHz Dipole

Date Tested: 02/26/04

DUT: Dipole 450 MHz; Model: D450V2; Type: System Performance Check; Serial: 136

Ambient Temp: 23.5 °C; Fluid Temp: 21.5 °C; Barometric Pressure: 108.5 kPa; Humidity: 30%

Communication System: CW
 Forward Conducted Power: 250mW
 Frequency: 450 MHz; Duty Cycle: 1:1
 Medium: HSL450 ($\sigma = 0.83$ mho/m; $\epsilon_r = 42.4$; $\rho = 1000$ kg/m³)

- Probe: ET3DV6 - SN1590; ConvF(7.9, 7.9, 7.9); Calibrated: 15/05/2003
- Sensor-Surface: 4mm (Mechanical Surface Detection)
- Electronics: DAE3 Sn353; Calibrated: 19/12/2003
- Phantom: Validation Planar; Type: Planar; Serial: 137
- Measurement SW: DASY4, V4.2 Build 12; Postprocessing SW: SEMCAD, V1.8 Build 94

450 MHz System Performance Check/Area Scan (6x11x1):

Measurement grid: dx=15mm, dy=15mm

450 MHz System Performance Check/Zoom Scan (7x7x7)/Cube 0:

Measurement grid: dx=5mm, dy=5mm, dz=5mm
 Peak SAR (extrapolated) = 2.21 W/kg
SAR(1 g) = 1.27 mW/g; SAR(10 g) = 0.823 mW/g
 Reference Value = 40 V/m
 Power Drift = -0.0 dB

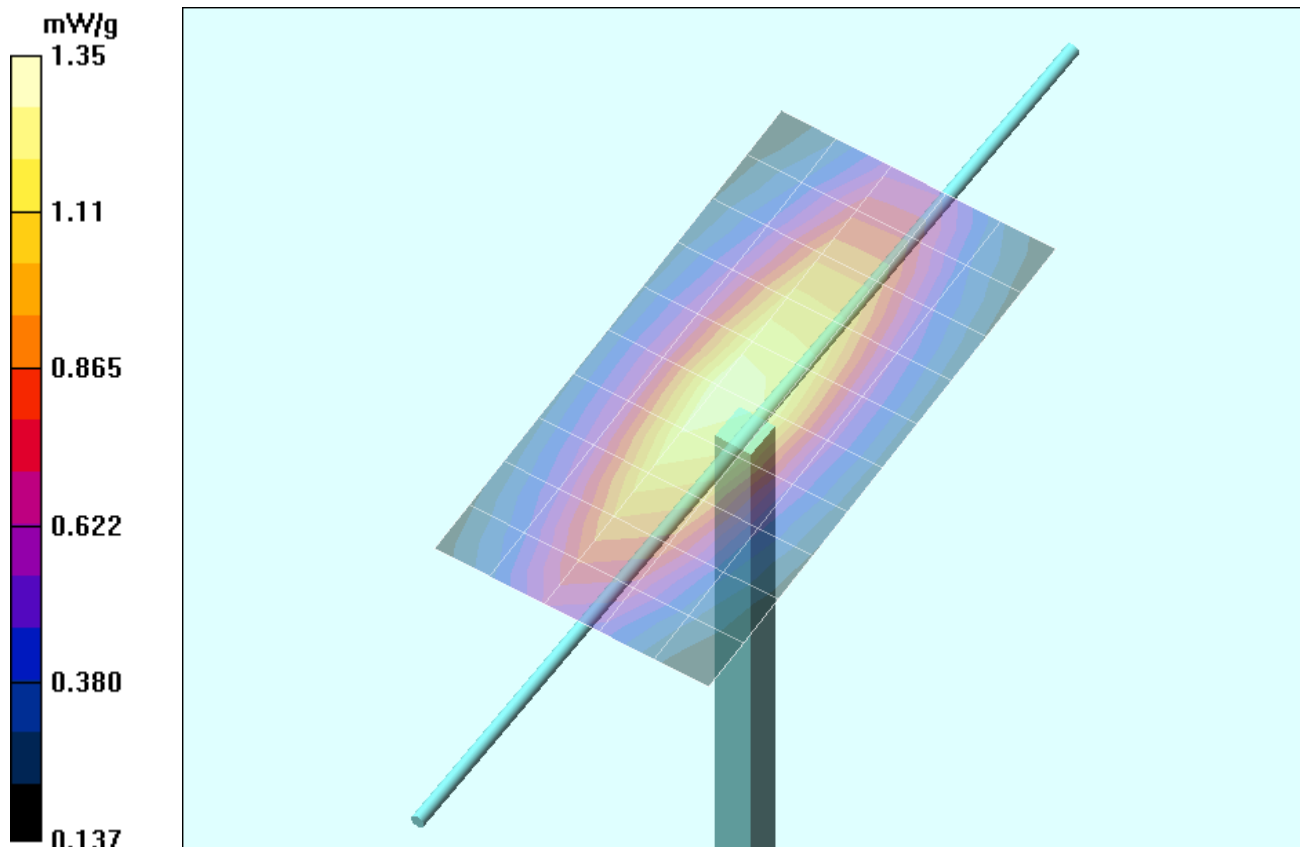

Z-Axis Scan

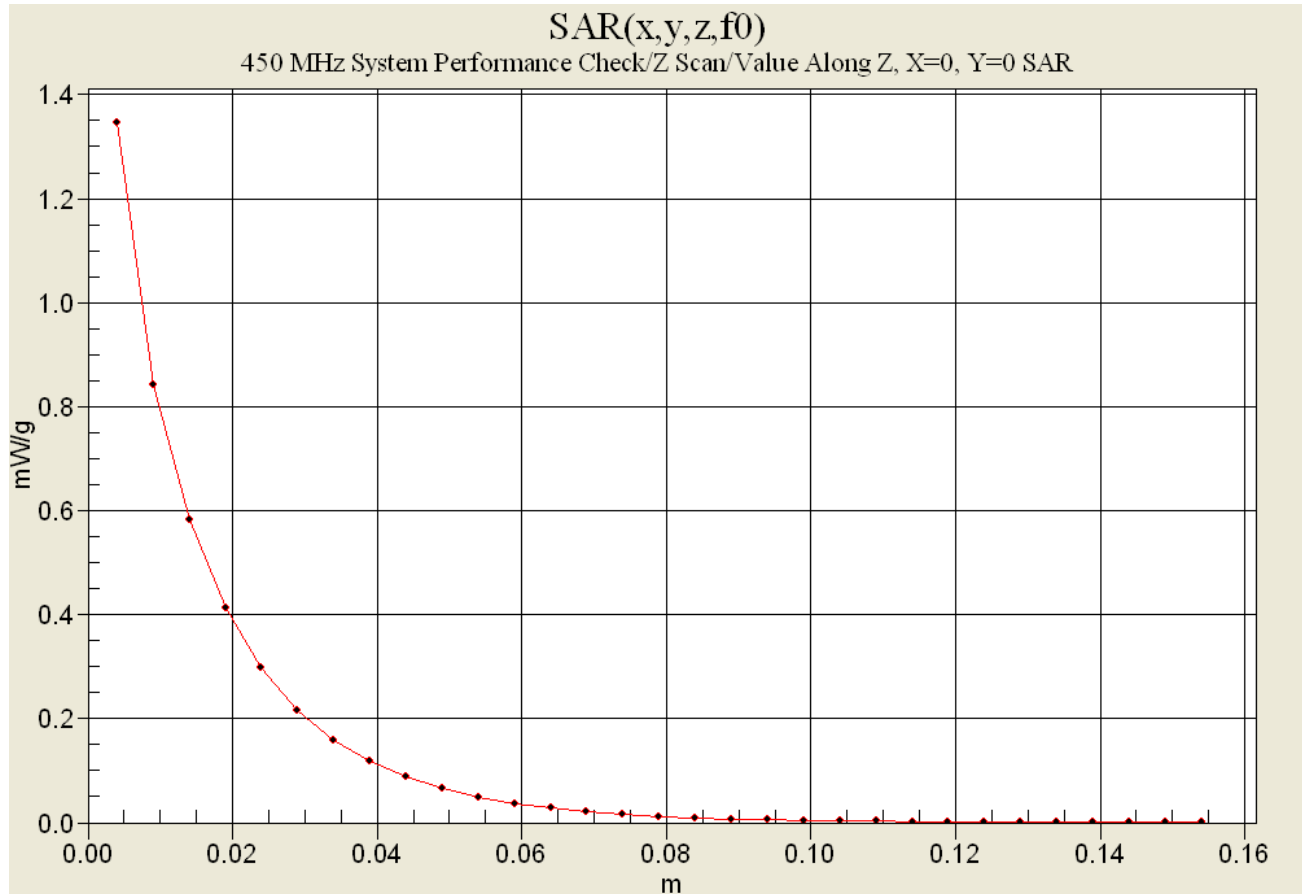

Test Report S/N:	021704-479K7G
Test Date(s):	February 26, 2004
Test Type:	FCC/IC SAR Evaluation

APPENDIX C - SYSTEM VALIDATION

450MHz SYSTEM VALIDATION DIPOLE

Type:

450MHz Validation Dipole

Serial Number:

136

Place of Calibration:

Celltech Labs Inc.

Date of Calibration:

November 4, 2003

Celltech Labs Inc. hereby certifies that this device has been calibrated on the date indicated above.

Calibrated by:

Spencer Watson

Approved by:

Russell W. Pope

1. Dipole Construction & Electrical Characteristics

The validation dipole was constructed in accordance with the IEEE Std “Recommended Practice for Determining the Spatial-Peak Specific Absorption Rate (SAR) in the Human Body Due to Wireless Communications Devices: Experimental Techniques”. The electrical properties were measured using an HP 8753E Network Analyzer. The network analyzer was calibrated to the validation dipole N-type connector feed point using an HP85032E Type N calibration kit. The dipole was placed parallel to a planar phantom at a separation distance of 15.0mm from the simulating fluid using a loss-less dielectric spacer. The measured input impedance is:

Feed point impedance at 450MHz $\text{Re}\{Z\} = 49.982\Omega$

$\text{Im}\{Z\} = 7.2324\Omega$

Return Loss at 450MHz

-22.597dB

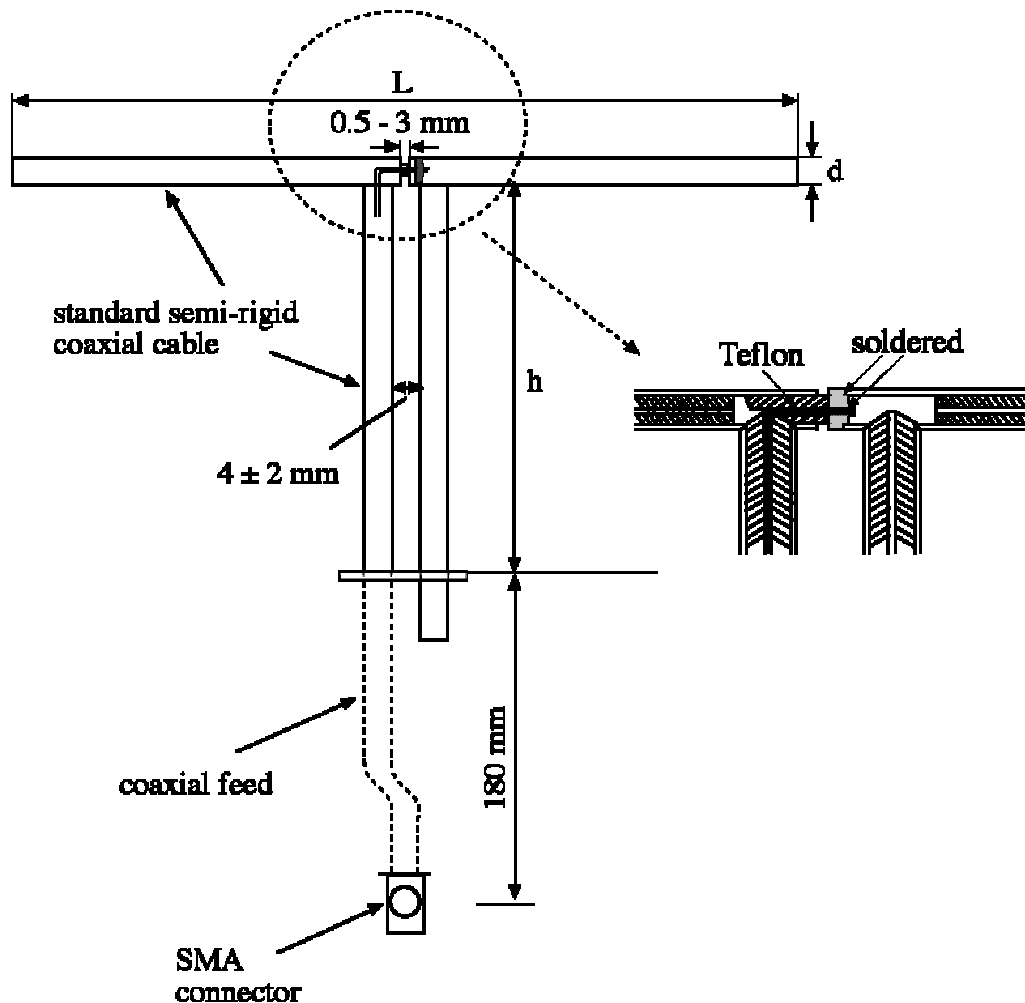

CH1 S11 1 U FS 1: 49.982 Ω 7.2324 Ω 2.5579 nH 4 Nov 2003 12:04:21 450.000 000 MHz

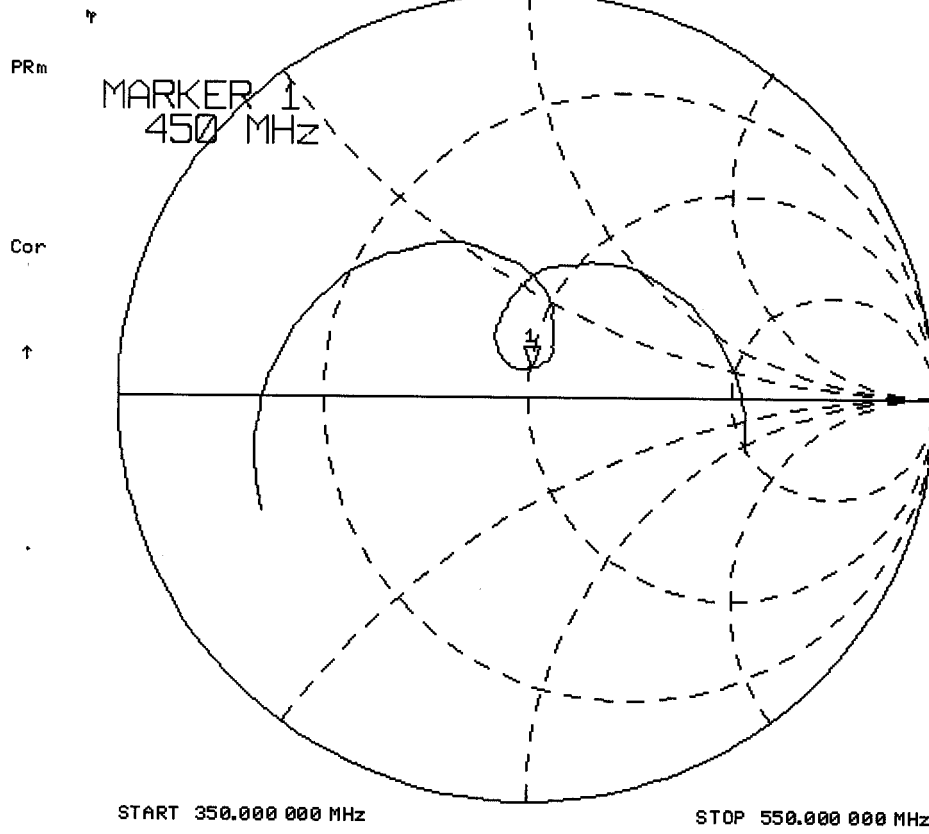

[CH1] S11 LOG 10 dB/REF 0 dB 4 Nov 2003 12:06:24
1:-22.597 dB 450.000 000 MHz

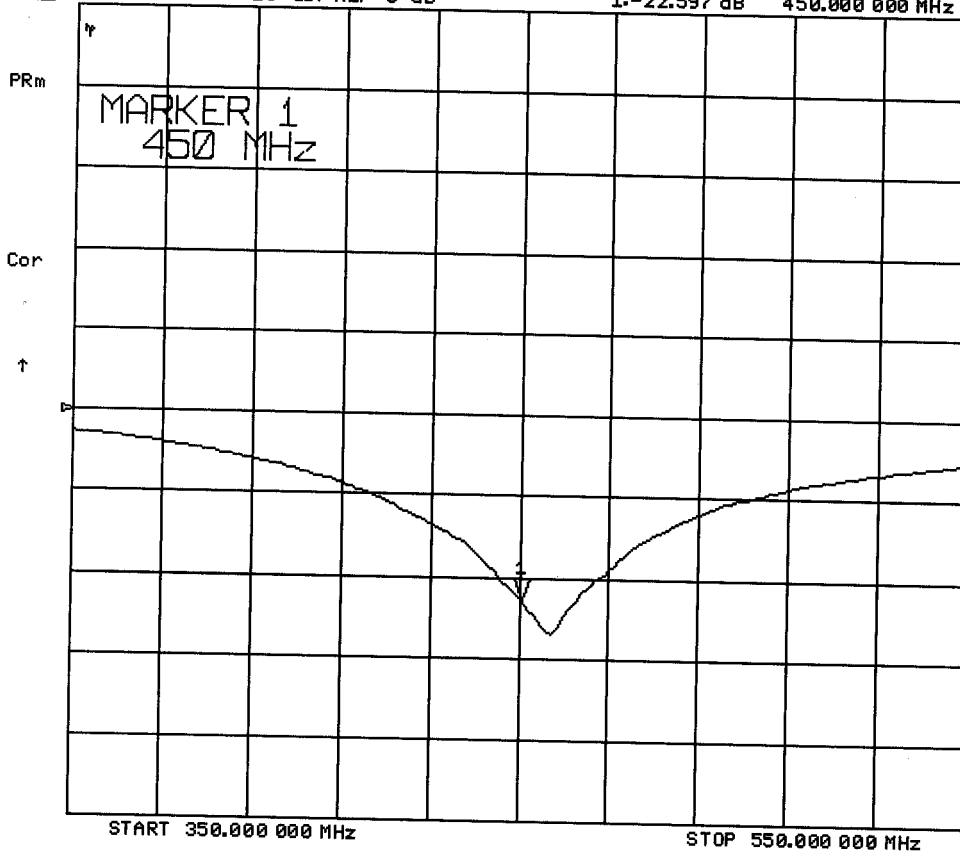

2. Validation Dipole Dimensions

Frequency (MHz)	L (mm)	h (mm)	d (mm)
300	420.0	250.0	6.2
450	288.0	167.0	6.2
835	161.0	89.8	3.6
900	149.0	83.3	3.6
1450	89.1	51.7	3.6
1800	72.0	41.7	3.6
1900	68.0	39.5	3.6
2000	64.5	37.5	3.6
2450	51.8	30.6	3.6
3000	41.5	25.0	3.6

3. Validation Phantom

The validation phantom was constructed using relatively low-loss tangent Plexiglas material. The inner dimensions of the phantom are as follows:

Length: 83.5 cm
 Width: 36.9 cm
 Height: 21.8 cm

The bottom section of the validation phantom is constructed of 6.2 ± 0.1 mm Plexiglas.

4. Dimensions of Plexiglas Planar Phantom

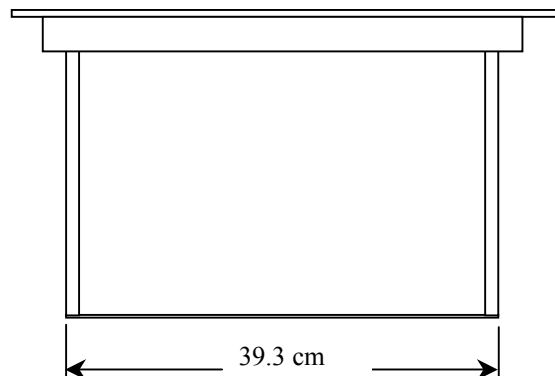
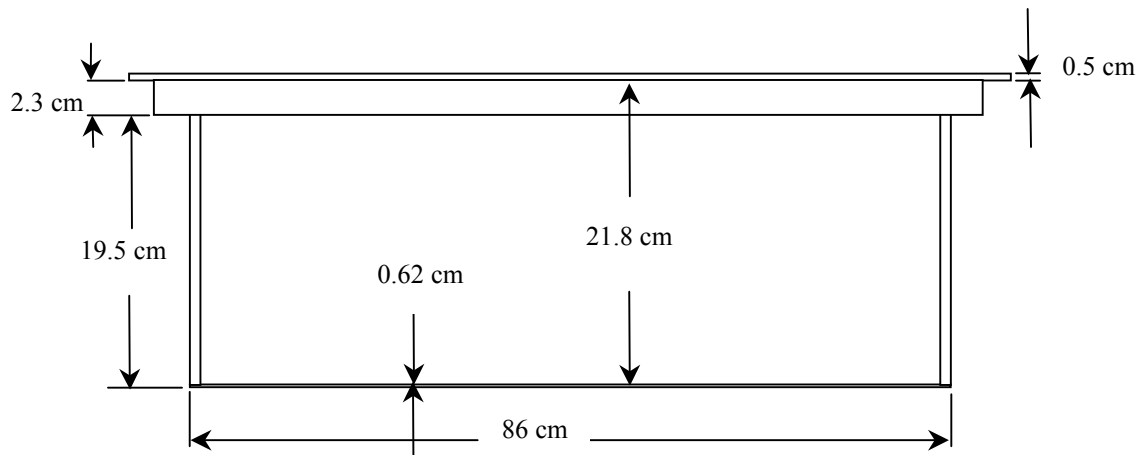
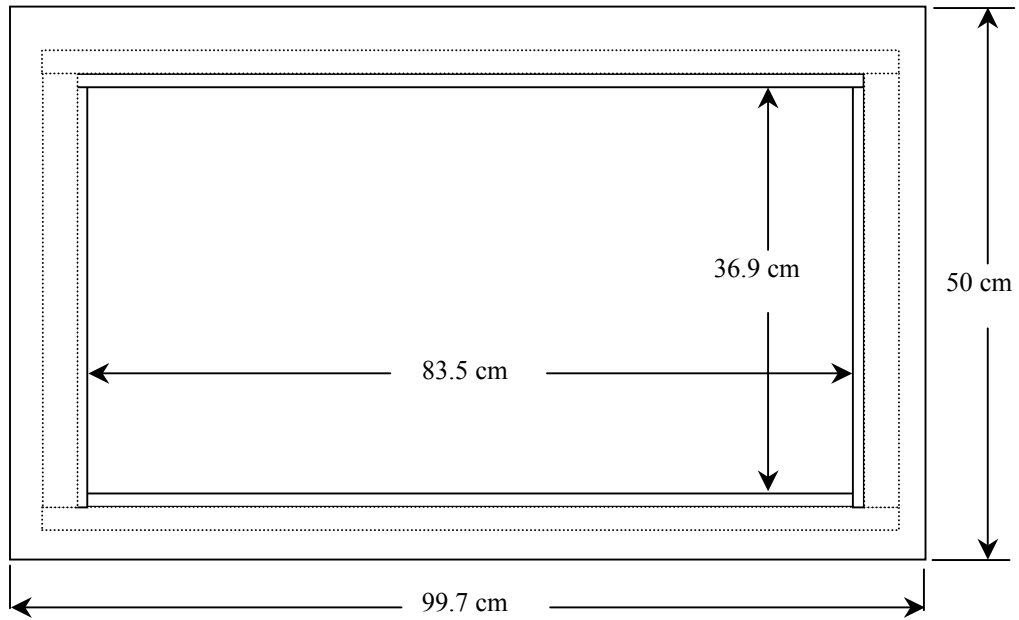

5. 450MHz System Validation Setup



450MHz System Validation Setup



6. Measurement Conditions

The planar phantom was filled with brain simulating tissue having the following parameters at 450MHz:

Relative Permittivity:	43.7
Conductivity:	0.88 mho/m
Fluid Temperature:	22.0 °C
Fluid Depth:	≥ 15.0 cm

Environmental Conditions:

Ambient Temperature:	22.1 °C
Humidity:	49 %
Barometric Pressure:	102.8 kPa

The 450MHz simulated brain tissue mixture consists of the following ingredients:

Ingredient	Percentage by weight
Water	38.56%
Sugar	56.32%
Salt	3.95%
HEC	0.98%
Dowicil 75	0.19%
450MHz Target Dielectric Parameters at 22 °C	$\epsilon_r = 43.5$ $\sigma = 0.87 \text{ S/m}$

7. SAR Measurement

The SAR measurement was performed with the E-field probe in mechanical detection mode only. The setup and determination of the forward power into the dipole was performed using the following procedures.

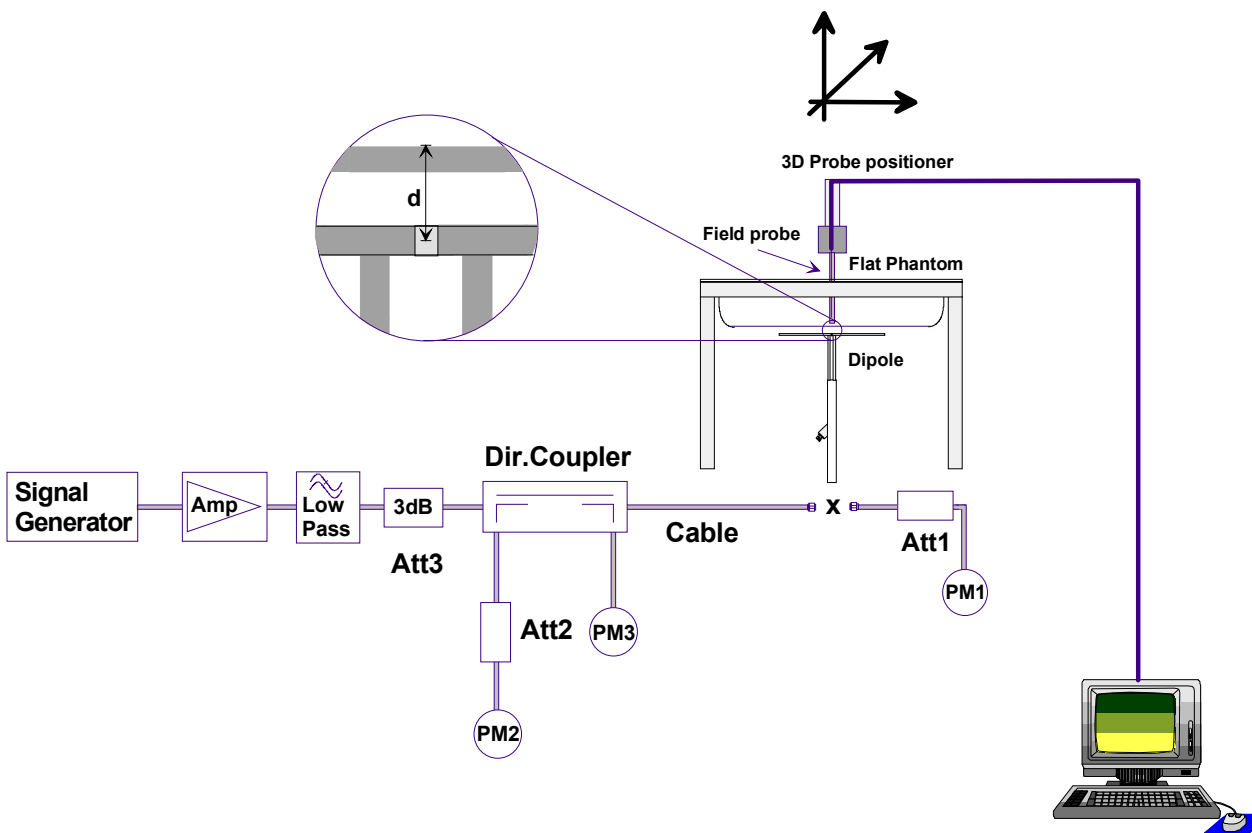

First the power meter PM1 (including attenuator Att1) is connected to the cable to measure the forward power at the location of the dipole connector (X). The signal generator is adjusted for the desired forward power at the dipole connector (taking into account the attenuation of Att1) as read by power meter PM2. After connecting the cable to the dipole, the signal generator is readjusted for the same reading at power meter PM2. If the signal generator does not allow adjustment in 0.01dB steps, the remaining difference at PM2 must be taken into consideration. PM3 records the reflected power from the dipole to ensure that the value is not changed from the previous value. The reflected power should be 20dB below the forward power.

8. Validation Dipole SAR Test Results

Ten SAR measurements were performed in order to achieve repeatability and to establish an average target value.

Validation Measurement	SAR @ 0.25W Input averaged over 1g	SAR @ 1W Input averaged over 1g	SAR @ 0.25W Input averaged over 10g	SAR @ 1W Input averaged over 10g	Peak SAR @ 0.25W Input
Test 1	1.29	5.16	0.810	3.24	2.28
Test 2	1.31	5.24	0.827	3.31	2.31
Test 3	1.30	5.20	0.823	3.29	2.29
Test 4	1.30	5.20	0.822	3.29	2.29
Test 5	1.29	5.16	0.819	3.28	2.28
Test 6	1.30	5.20	0.826	3.30	2.28
Test 7	1.31	5.24	0.826	3.30	2.30
Test 8	1.31	5.24	0.829	3.32	2.30
Test 9	1.30	5.20	0.822	3.29	2.28
Test 10	1.31	5.24	0.822	3.29	2.33
Average Value	1.30	5.21	0.823	3.29	2.29

The results have been normalized to 1W (forward power) into the dipole.

IEEE Target over 1cm³ (1g) of tissue: 1.23 mW/g (+/- 10%)

Averaged over 1cm (1g) of tissue: 5.21 mW/g

Averaged over 10cm (10g) of tissue: 3.29 mW/g

Test Date: 11/04/03

DUT: Dipole 450MHz; Model: D450V2; Type: System Performance Check; Serial: 136

Ambient Temp: 22.1°C; Fluid Temp: 22.0°C; Barometric Pressure: 102.8 kPa; Humidity: 49%

Communication System: CW
Forward Conducted Power: 250 mW
Frequency: 450 MHz; Duty Cycle: 1:1
Medium: HSL450 ($\sigma = 0.88$ mho/m, $\epsilon_r = 43.7$, $\rho = 1000$ kg/m³)

- Probe: ET3DV6 - SN1387; ConvF(7.5, 7.5, 7.5); Calibrated: 26/02/2003
- Sensor-Surface: 4mm (Mechanical Surface Detection)
- Electronics: DAE3 Sn370; Calibrated: 19/05/2003
- Phantom: Validation Planar; Type: Plexiglas; Serial: 137
- Measurement SW: DASY4, V4.1 Build 47; Postprocessing SW: SEMCAD, V1.6 Build 116

450 MHz Validation/Area Scan (6x11x1): Measurement grid: dx=15mm, dy=15mm

Reference Value = 39 V/m

Power Drift = -0.08 dB

Maximum value of SAR = 1.3 mW/g

450 MHz Validation/Zoom Scan 8 (7x7x7)/Cube 0: Measurement grid: dx=5mm, dy=5mm, dz=5mm

Peak SAR (extrapolated) = 2.28 W/kg

SAR(1 g) = 1.3 mW/g; SAR(10 g) = 0.822 mW/g

Reference Value = 39 V/m

Power Drift = 0.08 dB

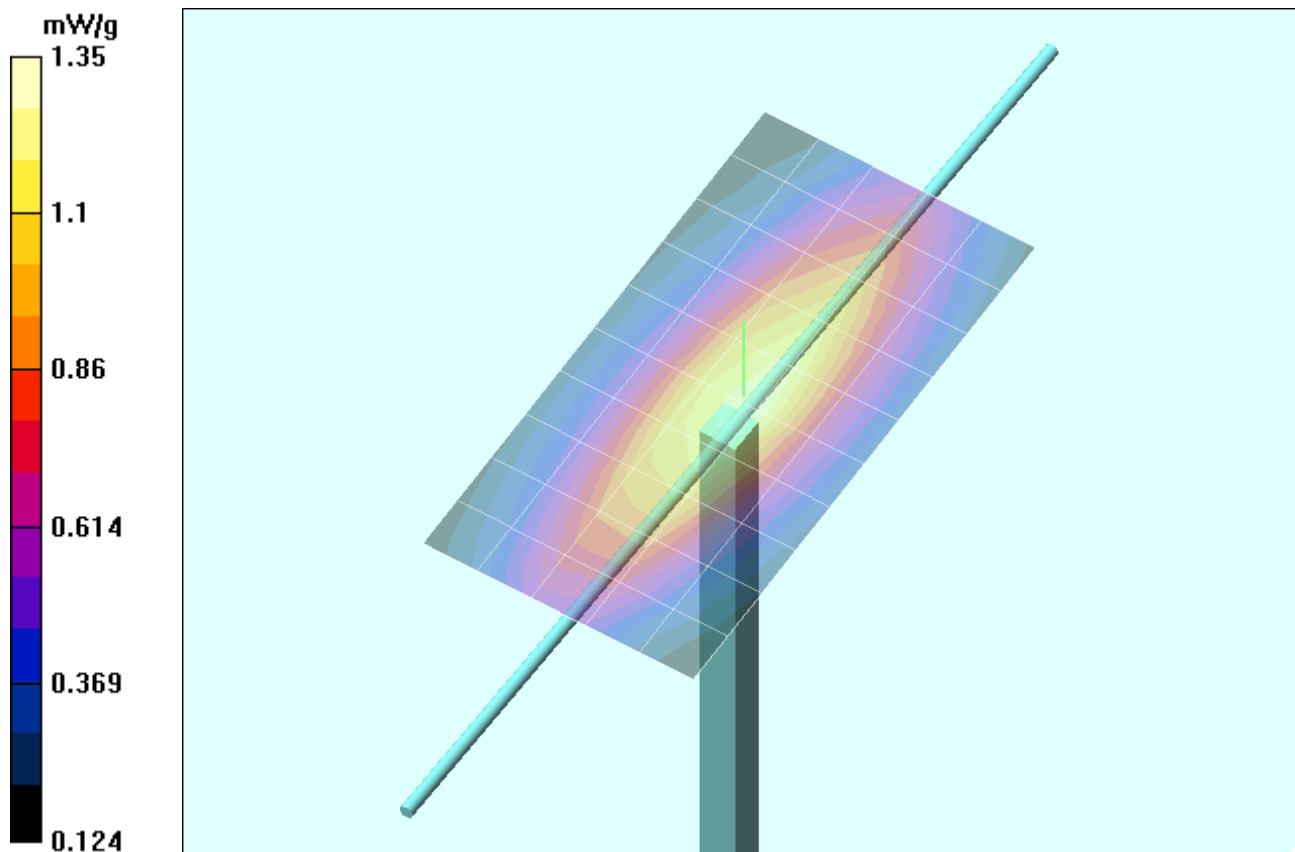

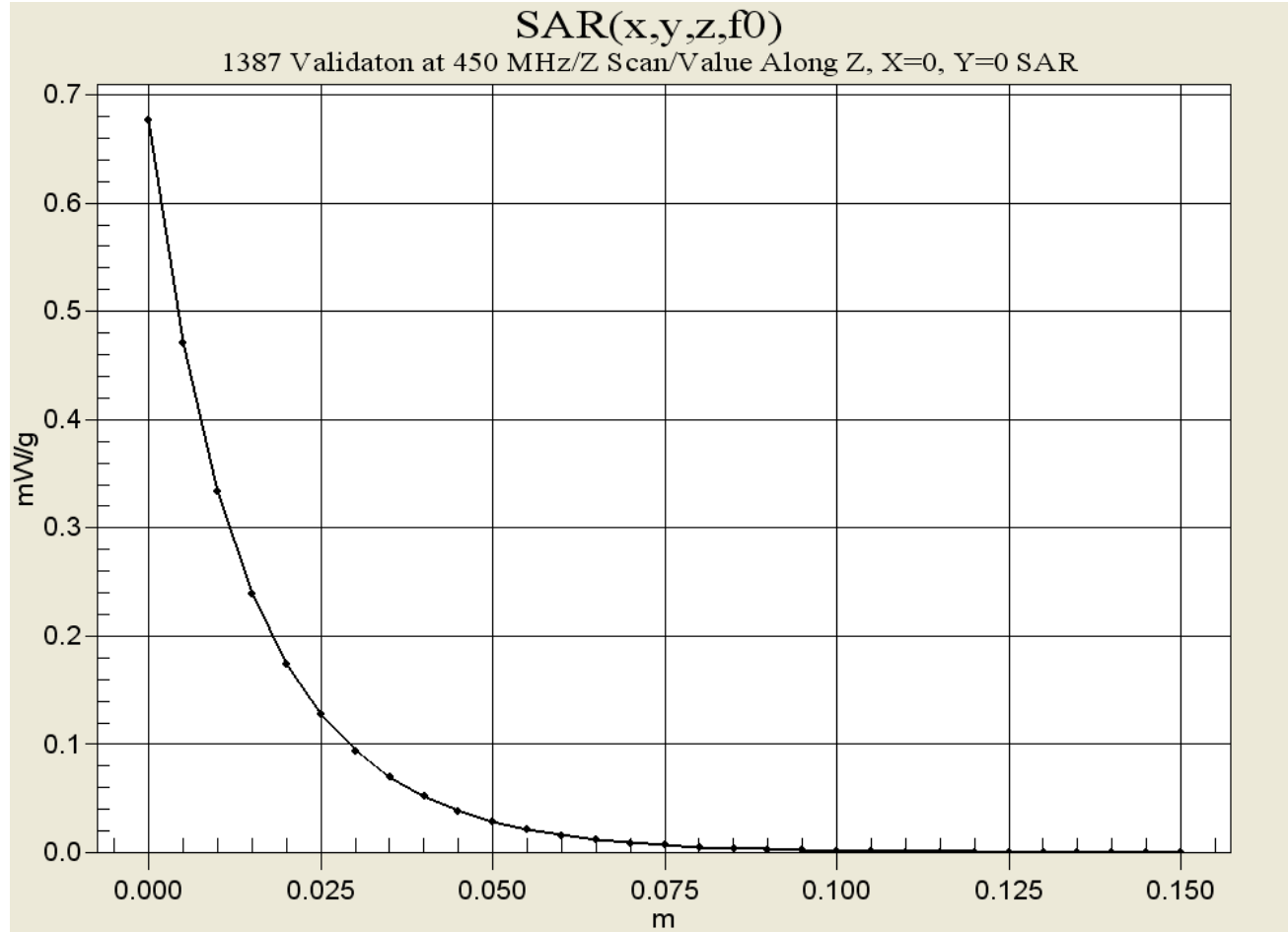

450MHz System Validation

Measured Fluid Dielectric Parameters (Brain)



November 04, 2003

Frequency	ϵ'	ϵ''
350.000000 MHz	46.2660	40.8224
360.000000 MHz	45.9937	40.0986
370.000000 MHz	45.7556	39.4543
380.000000 MHz	45.5625	38.7387
390.000000 MHz	45.2820	38.1140
400.000000 MHz	45.0146	37.4981
410.000000 MHz	44.7508	36.9734
420.000000 MHz	44.5046	36.4917
430.000000 MHz	44.2494	35.9460
440.000000 MHz	43.9621	35.5647
450.000000 MHz	43.7384	35.2106
460.000000 MHz	43.5513	34.7930
470.000000 MHz	43.2846	34.3970
480.000000 MHz	43.0654	33.9576
490.000000 MHz	42.8566	33.6391
500.000000 MHz	42.6744	33.2270
510.000000 MHz	42.5036	32.8459
520.000000 MHz	42.3492	32.5261
530.000000 MHz	42.1783	32.1727
540.000000 MHz	41.9985	31.7385
550.000000 MHz	41.8097	31.4862

Test Report S/N:	021704-479K7G
Test Date(s):	February 26, 2004
Test Type:	FCC/IC SAR Evaluation

APPENDIX D - PROBE CALIBRATION

Client **Celltech Labs**

CALIBRATION CERTIFICATE																															
Object(s)	ET3DV6 - SN:1590																														
Calibration procedure(s)	QA CAL-01.v2 Calibration procedure for dosimetric E-field probes																														
Calibration date:	May 15, 2003																														
Condition of the calibrated item	In Tolerance (according to the specific calibration document)																														
<p>This calibration statement documents traceability of M&TE used in the calibration procedures and conformity of the procedures with the ISO/IEC 17025 international standard.</p> <p>All calibrations have been conducted in the closed laboratory facility: environment temperature 22 +/- 2 degrees Celsius and humidity < 75%.</p> <p>Calibration Equipment used (M&TE critical for calibration)</p> <table border="1"> <thead> <tr> <th>Model Type</th> <th>ID #</th> <th>Cal Date (Calibrated by, Certificate No.)</th> <th>Scheduled Calibration</th> </tr> </thead> <tbody> <tr> <td>RF generator HP 8684C</td> <td>US3642U01700</td> <td>4-Aug-99 (SPEAG, in house check Aug-02)</td> <td>In house check: Aug-05</td> </tr> <tr> <td>Power sensor E4412A</td> <td>MY41495277</td> <td>2-Apr-03 (METAS, No 252-0250)</td> <td>Apr-04</td> </tr> <tr> <td>Power sensor HP 8481A</td> <td>MY41092180</td> <td>18-Sep-02 (Agilent, No. 20020918)</td> <td>Sep-03</td> </tr> <tr> <td>Power meter EPM E4419B</td> <td>GB41293874</td> <td>2-Apr-03 (METAS, No 252-0250)</td> <td>Apr-04</td> </tr> <tr> <td>Network Analyzer HP 8753E</td> <td>US38432426</td> <td>3-May-00 (Agilent, No. 8702K094602)</td> <td>In house check: May 03</td> </tr> <tr> <td>Fluke Process Calibrator Type 702</td> <td>SN: 6295803</td> <td>3-Sep-01 (ELCAL, No.2360)</td> <td>Sep-03</td> </tr> </tbody> </table>				Model Type	ID #	Cal Date (Calibrated by, Certificate No.)	Scheduled Calibration	RF generator HP 8684C	US3642U01700	4-Aug-99 (SPEAG, in house check Aug-02)	In house check: Aug-05	Power sensor E4412A	MY41495277	2-Apr-03 (METAS, No 252-0250)	Apr-04	Power sensor HP 8481A	MY41092180	18-Sep-02 (Agilent, No. 20020918)	Sep-03	Power meter EPM E4419B	GB41293874	2-Apr-03 (METAS, No 252-0250)	Apr-04	Network Analyzer HP 8753E	US38432426	3-May-00 (Agilent, No. 8702K094602)	In house check: May 03	Fluke Process Calibrator Type 702	SN: 6295803	3-Sep-01 (ELCAL, No.2360)	Sep-03
Model Type	ID #	Cal Date (Calibrated by, Certificate No.)	Scheduled Calibration																												
RF generator HP 8684C	US3642U01700	4-Aug-99 (SPEAG, in house check Aug-02)	In house check: Aug-05																												
Power sensor E4412A	MY41495277	2-Apr-03 (METAS, No 252-0250)	Apr-04																												
Power sensor HP 8481A	MY41092180	18-Sep-02 (Agilent, No. 20020918)	Sep-03																												
Power meter EPM E4419B	GB41293874	2-Apr-03 (METAS, No 252-0250)	Apr-04																												
Network Analyzer HP 8753E	US38432426	3-May-00 (Agilent, No. 8702K094602)	In house check: May 03																												
Fluke Process Calibrator Type 702	SN: 6295803	3-Sep-01 (ELCAL, No.2360)	Sep-03																												
Calibrated by:	Name Nicola Verber	Function Technician	Signature 																												
Approved by:	Name Katja Polovic	Function Laboratory Director	Signature 																												
Date issued: May 15, 2003																															
<p>This calibration certificate is issued as an intermediate solution until the accreditation process (based on ISO/IEC 17025 International Standard) for Calibration Laboratory of Schmid & Partner Engineering AG is completed.</p>																															

Probe ET3DV6

SN:1590

Manufactured:	March 19, 2001
Last calibration:	April 26, 2002
Recalibrated:	May 15, 2003

Calibrated for DASY Systems

(Note: non-compatible with DASY2 system!)

DASY - Parameters of Probe: ET3DV6 SN:1590**Sensitivity in Free Space****Diode Compression**

NormX	1.76 $\mu\text{V}/(\text{V}/\text{m})^2$	DCP X	92	mV
NormY	1.91 $\mu\text{V}/(\text{V}/\text{m})^2$	DCP Y	92	mV
NormZ	1.66 $\mu\text{V}/(\text{V}/\text{m})^2$	DCP Z	92	mV

Sensitivity in Tissue Simulating Liquid

Head 900 MHz $\epsilon_r = 41.5 \pm 5\%$ $\sigma = 0.97 \pm 5\%$ mho/m

Valid for f=800-1000 MHz with Head Tissue Simulating Liquid according to EN 50361, P1528-200X

ConvF X	7.0 $\pm 9.5\%$ (k=2)	Boundary effect:	
ConvF Y	7.0 $\pm 9.5\%$ (k=2)	Alpha	0.33
ConvF Z	7.0 $\pm 9.5\%$ (k=2)	Depth	2.56

Head 1800 MHz $\epsilon_r = 40.0 \pm 5\%$ $\sigma = 1.40 \pm 5\%$ mho/m

Valid for f=1710-1910 MHz with Head Tissue Simulating Liquid according to EN 50361, P1528-200X

ConvF X	5.5 $\pm 9.5\%$ (k=2)	Boundary effect:	
ConvF Y	5.5 $\pm 9.5\%$ (k=2)	Alpha	0.44
ConvF Z	5.5 $\pm 9.5\%$ (k=2)	Depth	2.69

Boundary Effect

Head 900 MHz Typical SAR gradient: 5 % per mm

Probe Tip to Boundary		1 mm	2 mm
SAR _{be} [%]	Without Correction Algorithm	8.7	5.0
SAR _{be} [%]	With Correction Algorithm	0.3	0.5

Head 1800 MHz Typical SAR gradient: 10 % per mm

Probe Tip to Boundary		1 mm	2 mm
SAR _{be} [%]	Without Correction Algorithm	12.3	8.5
SAR _{be} [%]	With Correction Algorithm	0.2	0.1

Sensor Offset

Probe Tip to Sensor Center	2.7	mm
Optical Surface Detection	1.4 \pm 0.2	mm

Receiving Pattern (ϕ), $\theta = 0^\circ$

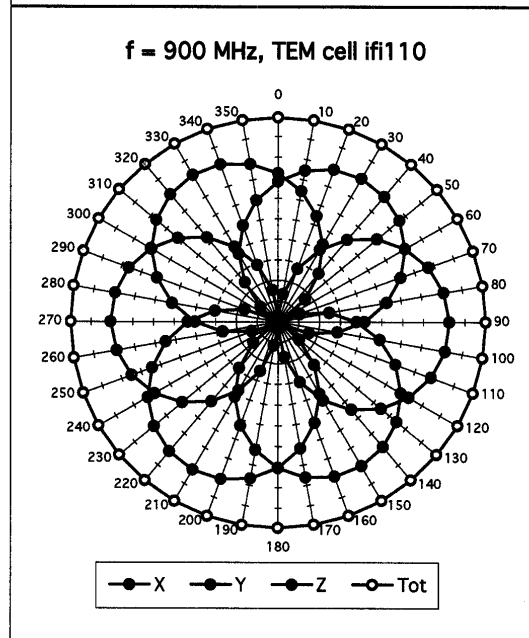
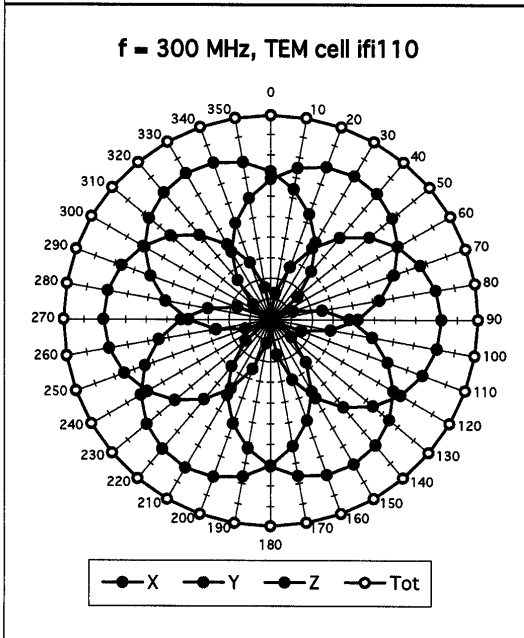
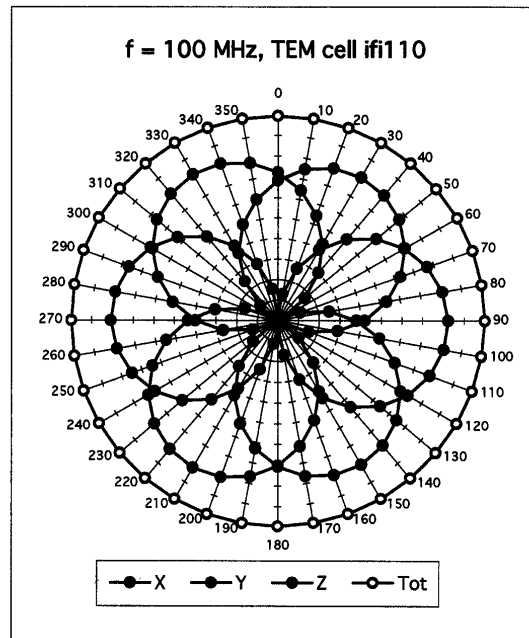
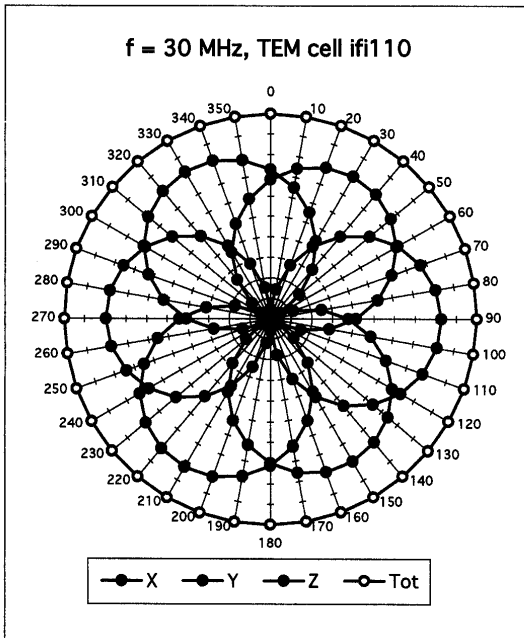

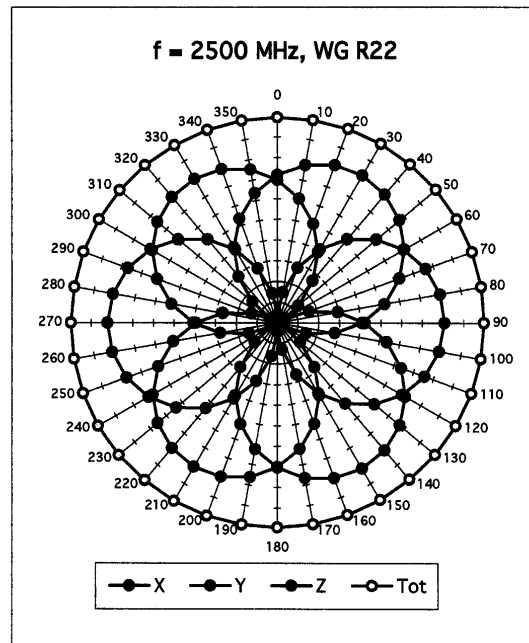
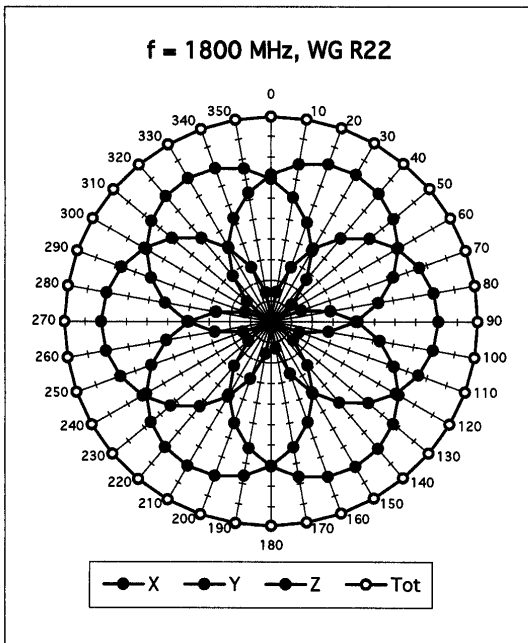

Isotropy Error (ϕ), $\theta = 0^\circ$

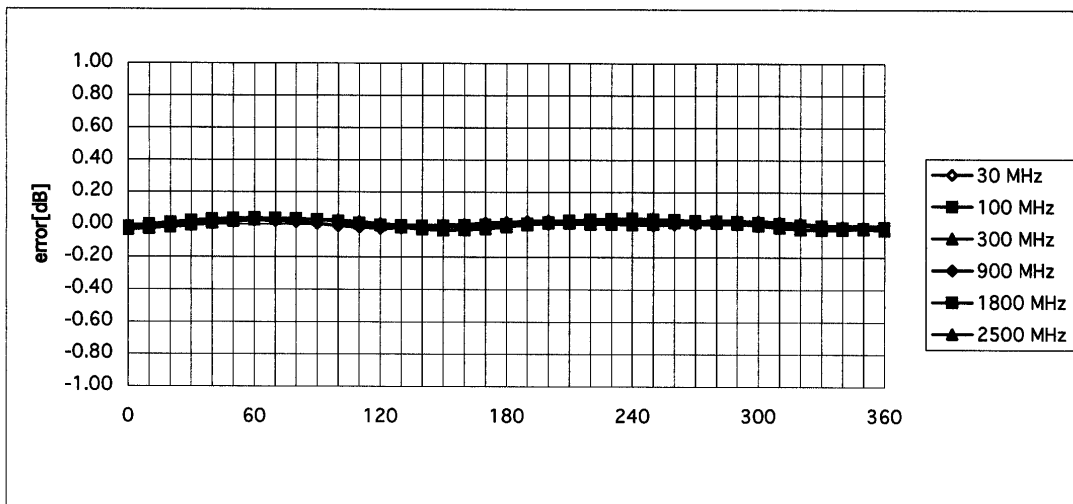

Frequency Response of E-Field

(TEM-Cell:ifi110, Waveguide R22)

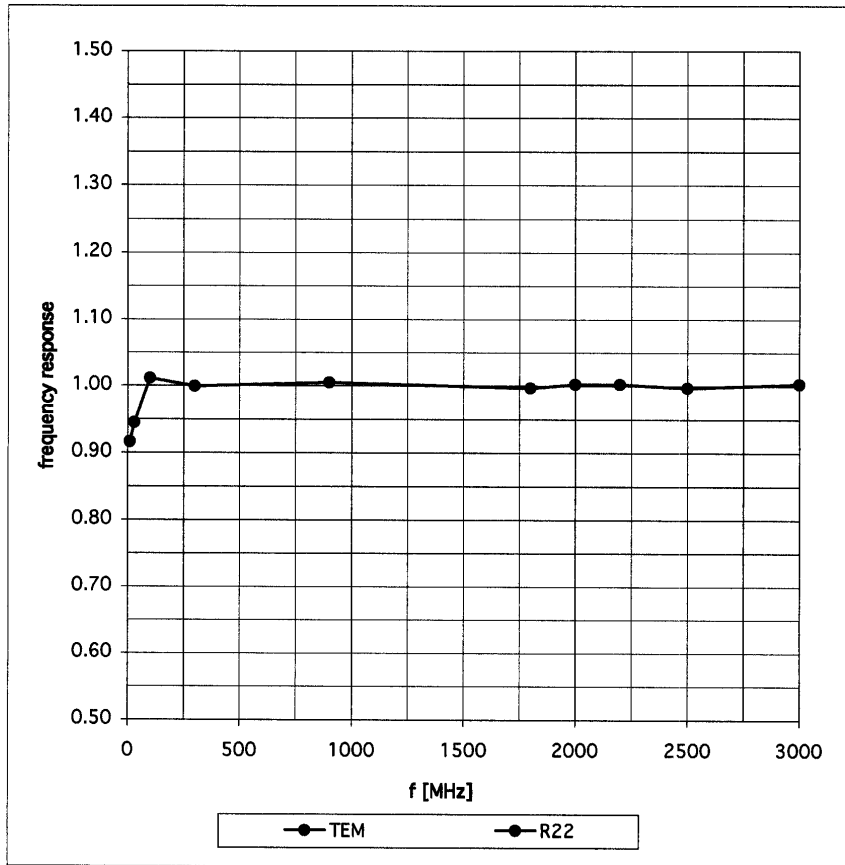

Dynamic Range f(SAR_{brain})

(Waveguide R22)

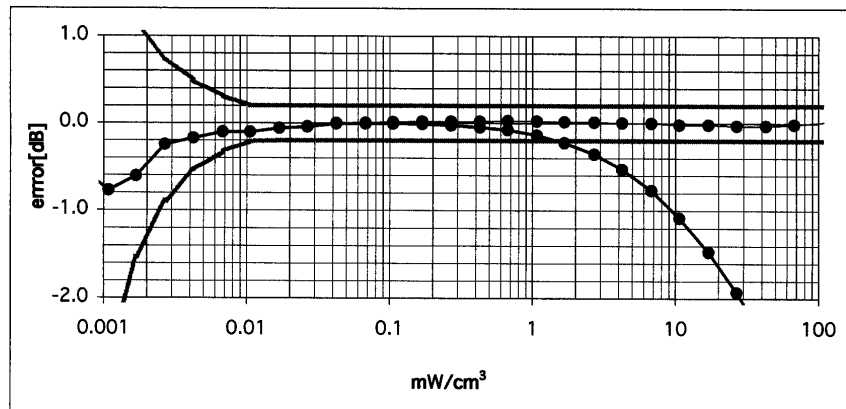
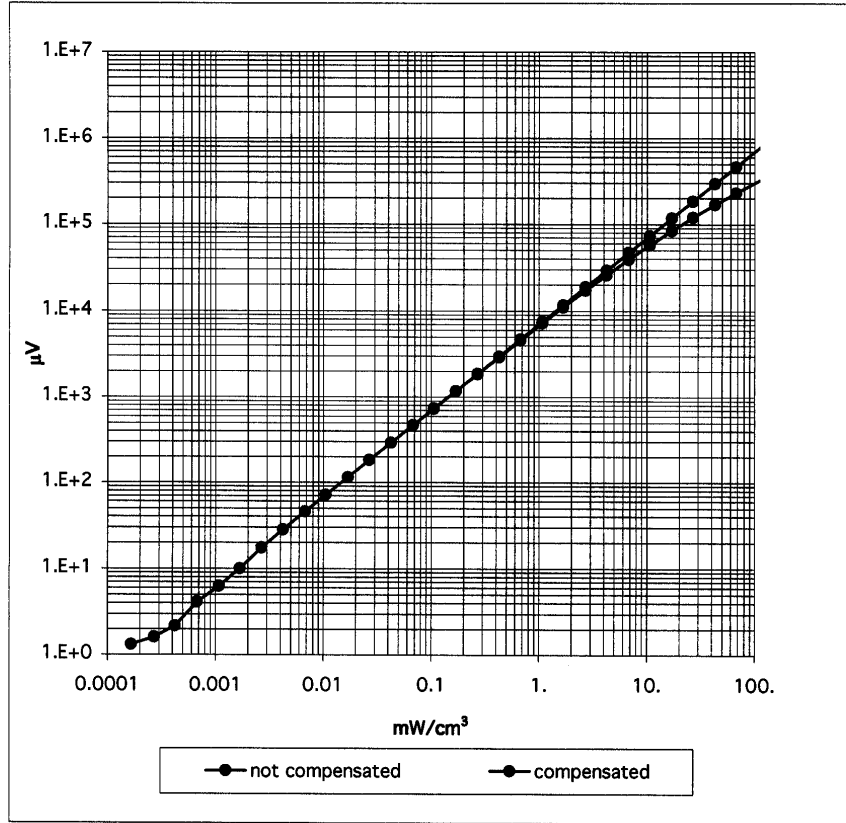

Conversion Factor Assessment

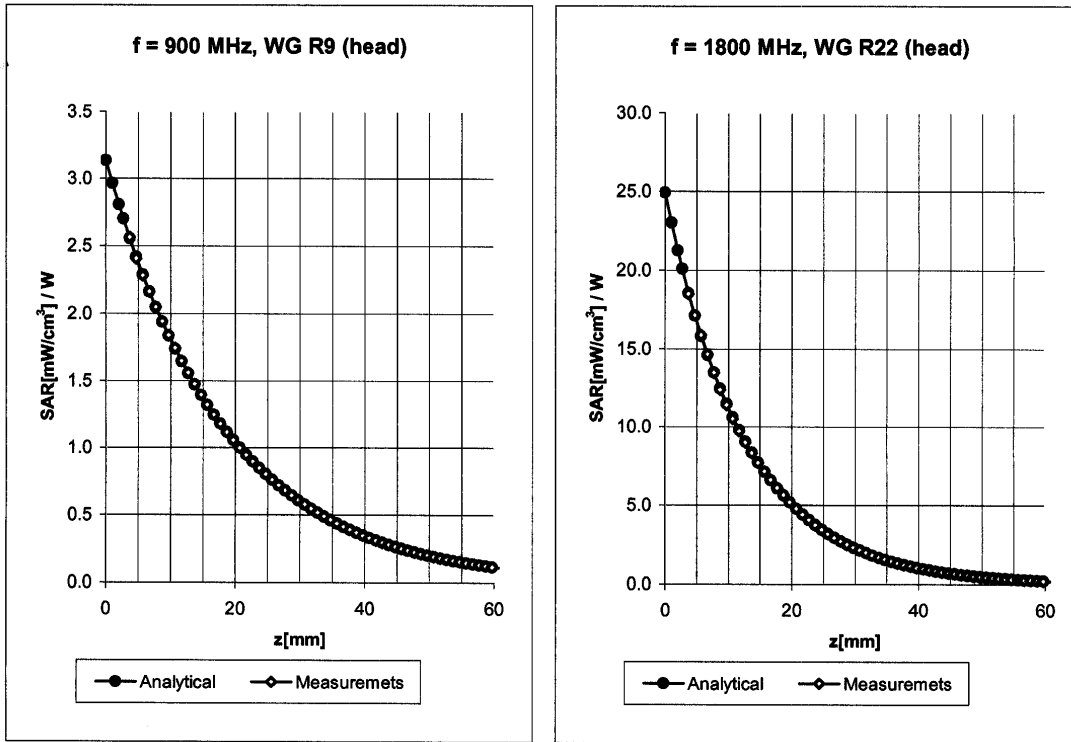

Head 900 MHz $\epsilon_r = 41.5 \pm 5\%$ $\sigma = 0.97 \pm 5\%$ mho/m

Valid for f=800-1000 MHz with Head Tissue Simulating Liquid according to EN 50361, P1528-200X

ConvF X	7.0 ± 9.5% (k=2)	Boundary effect:
ConvF Y	7.0 ± 9.5% (k=2)	Alpha 0.33
ConvF Z	7.0 ± 9.5% (k=2)	Depth 2.56

Head 1800 MHz $\epsilon_r = 40.0 \pm 5\%$ $\sigma = 1.40 \pm 5\%$ mho/m

Valid for f=1710-1910 MHz with Head Tissue Simulating Liquid according to EN 50361, P1528-200X

ConvF X	5.5 ± 9.5% (k=2)	Boundary effect:
ConvF Y	5.5 ± 9.5% (k=2)	Alpha 0.44
ConvF Z	5.5 ± 9.5% (k=2)	Depth 2.69

Conversion Factor Assessment

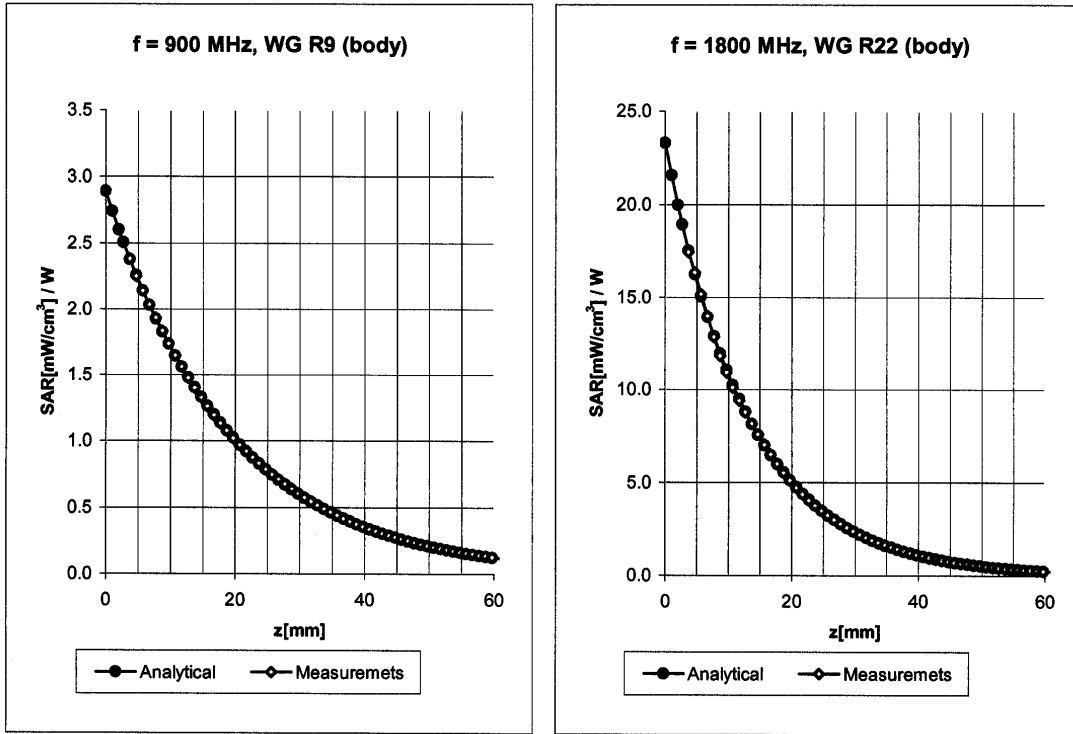

Body 900 MHz $\epsilon_r = 55.0 \pm 5\%$ $\sigma = 1.05 \pm 5\%$ mho/m

Valid for f=800-1000 MHz with Body Tissue Simulating Liquid according to OET 65 Suppl. C

ConvF X	6.8 $\pm 9.5\%$ (k=2)	Boundary effect:
ConvF Y	6.8 $\pm 9.5\%$ (k=2)	Alpha 0.34
ConvF Z	6.8 $\pm 9.5\%$ (k=2)	Depth 2.61

Body 1800 MHz $\epsilon_r = 53.3 \pm 5\%$ $\sigma = 1.52 \pm 5\%$ mho/m

Valid for f=1710-1910 MHz with Body Tissue Simulating Liquid according to OET 65 Suppl. C

ConvF X	5.0 $\pm 9.5\%$ (k=2)	Boundary effect:
ConvF Y	5.0 $\pm 9.5\%$ (k=2)	Alpha 0.52
ConvF Z	5.0 $\pm 9.5\%$ (k=2)	Depth 2.69

Conversion Factor Assessment

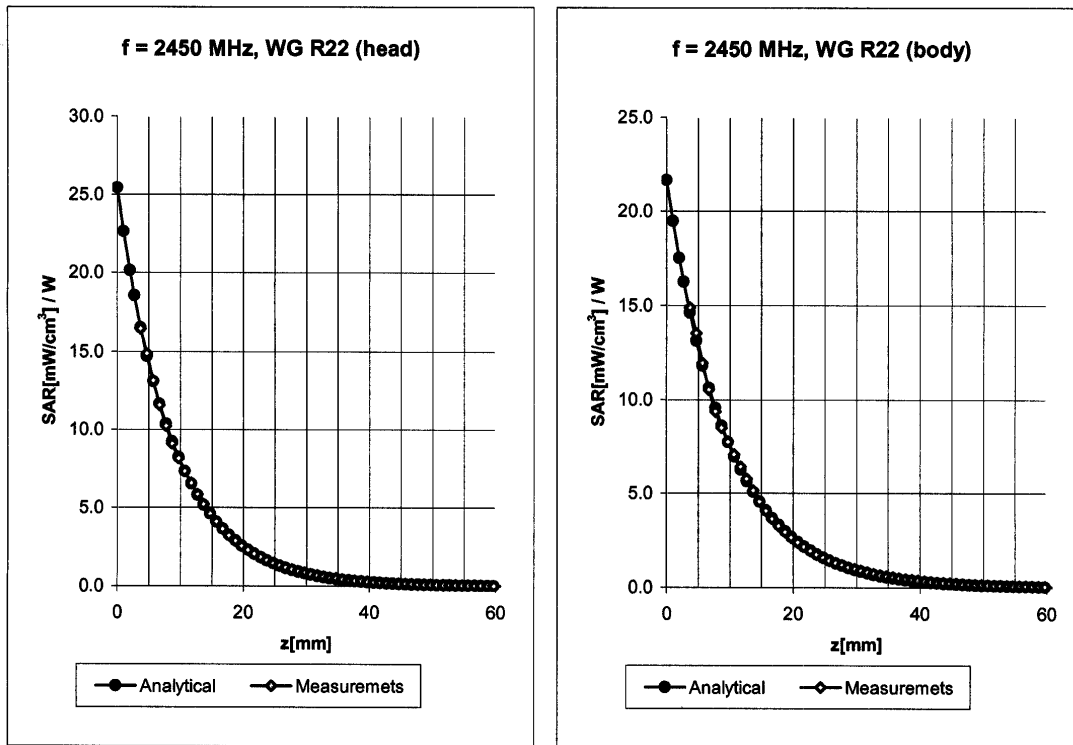

Head 2450 MHz $\epsilon_r = 39.2 \pm 5\%$ $\sigma = 1.80 \pm 5\%$ mho/m

Valid for f=2400-2500 MHz with Head Tissue Simulating Liquid according to EN 50361, P1528-200X

ConvF X	5.0 ± 8.9% (k=2)	Boundary effect:
ConvF Y	5.0 ± 8.9% (k=2)	Alpha 0.88
ConvF Z	5.0 ± 8.9% (k=2)	Depth 1.92

Body 2450 MHz $\epsilon_r = 52.7 \pm 5\%$ $\sigma = 1.95 \pm 5\%$ mho/m

Valid for f=2400-2500 MHz with Body Tissue Simulating Liquid according to OET 65 Suppl. C

ConvF X	4.4 ± 8.9% (k=2)	Boundary effect:
ConvF Y	4.4 ± 8.9% (k=2)	Alpha 0.90
ConvF Z	4.4 ± 8.9% (k=2)	Depth 1.87

Deviation from Isotropy in HSL

Error (θ, ϕ), $f = 900$ MHz

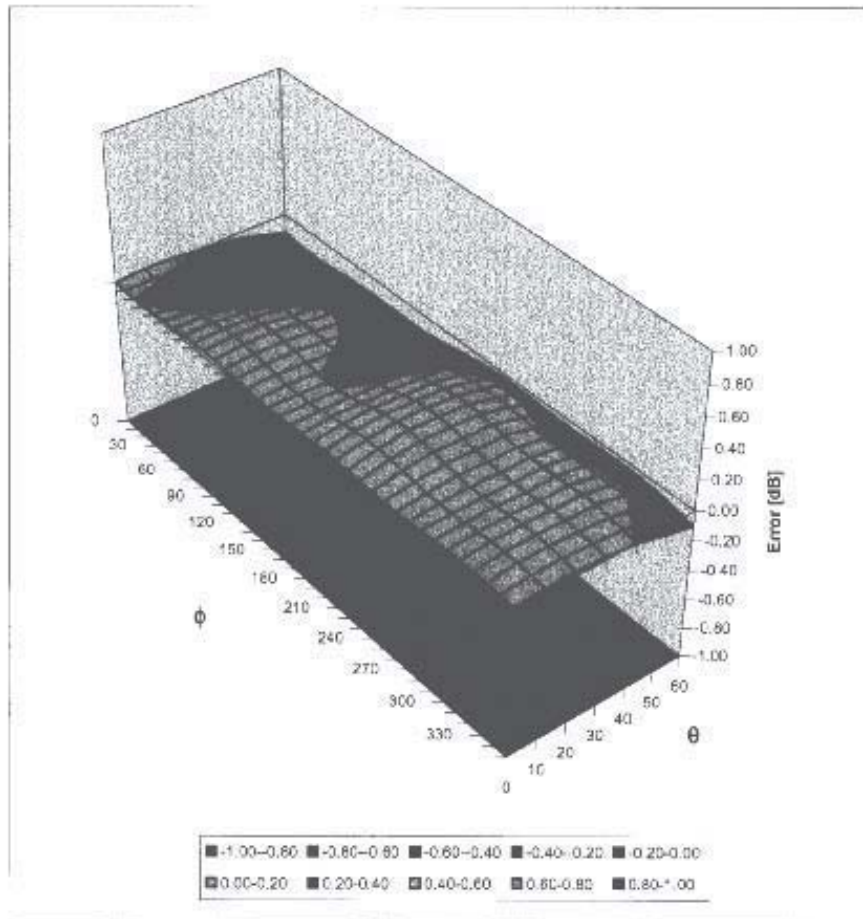

Additional Conversion Factors for Dosimetric E-Field Probe

Type:

ET3DV6

Serial Number:

1590

Place of Assessment:

Zurich

Date of Assessment:

May 19, 2003

Probe Calibration Date:

May 15, 2003

Schmid & Partner Engineering AG hereby certifies that conversion factor(s) of this probe have been evaluated on the date indicated above. The assessment was performed using the FDTD numerical code SEMCAD of Schmid & Partner Engineering AG. Since the evaluation is coupled with measured conversion factors, it has to be recalculated yearly, i.e., following the re-calibration schedule of the probe. The uncertainty of the numerical assessment is based on the extrapolation from measured value at 900 MHz or at 1800 MHz.

Assessed by:

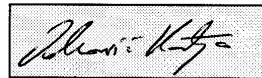

Dosimetric E-Field Probe ET3DV6 SN:1590Conversion factor (\pm standard deviation)

150 MHz	ConvF	9.6 \pm 8%	$\epsilon_r = 52.3 \pm 5\%$ $\sigma = 0.76 \pm 5\%$ mho/m (head tissue)
300 MHz	ConvF	8.3 \pm 8%	$\epsilon_r = 45.3 \pm 5\%$ $\sigma = 0.87 \pm 5\%$ mho/m (head tissue)
450 MHz	ConvF	7.9 \pm 8%	$\epsilon_r = 43.5 \pm 5\%$ $\sigma = 0.87 \pm 5\%$ mho/m (head tissue)
150 MHz	ConvF	9.2 \pm 8%	$\epsilon_r = 61.9 \pm 5\%$ $\sigma = 0.80 \pm 5\%$ mho/m (body tissue)
450 MHz	ConvF	8.1 \pm 8%	$\epsilon_r = 56.7 \pm 5\%$ $\sigma = 0.94 \pm 5\%$ mho/m (body tissue)

Test Report S/N:	021704-479K7G
Test Date(s):	February 26, 2004
Test Type:	FCC/IC SAR Evaluation

APPENDIX E - MEASURED FLUID DIELECTRIC PARAMETERS

450 MHz System Performance Check & DUT Evaluation (Face)

Measured Fluid Dielectric Parameters (Brain)

February 26, 2004

Frequency	ϵ'	ϵ''
350.000000 MHz	44.9020	38.4743
360.000000 MHz	44.6172	37.8449
370.000000 MHz	44.3722	37.2446
380.000000 MHz	44.0853	36.5723
390.000000 MHz	43.8381	36.0253
400.000000 MHz	43.5469	35.5327
410.000000 MHz	43.3433	34.9916
420.000000 MHz	43.0749	34.6345
430.000000 MHz	42.8263	34.1268
440.000000 MHz	42.5671	33.7393
450.000000 MHz	42.3656	33.3519
460.000000 MHz	42.1418	33.0032
470.000000 MHz	41.8889	32.6388
480.000000 MHz	41.7155	32.2690
490.000000 MHz	41.5117	31.8847
500.000000 MHz	41.3175	31.5145
510.000000 MHz	41.0972	31.1468
520.000000 MHz	40.8655	30.8610
530.000000 MHz	40.7220	30.5719
540.000000 MHz	40.5604	30.1940
550.000000 MHz	40.3729	29.9508

450 MHz DUT Evaluation (Body)

Measured Fluid Dielectric Parameters (Muscle)

February 26, 2004

Frequency	ϵ'	ϵ''
350.000000 MHz	58.3575	43.1402
360.000000 MHz	58.0996	42.3256
370.000000 MHz	57.9256	41.5390
380.000000 MHz	57.7013	40.8778
390.000000 MHz	57.5459	40.1822
400.000000 MHz	57.3526	39.4829
410.000000 MHz	57.2481	38.7784
420.000000 MHz	57.0654	38.2408
430.000000 MHz	56.8469	37.6340
440.000000 MHz	56.7006	37.1075
450.000000 MHz	56.4994	36.6613
460.000000 MHz	56.4308	36.2720
470.000000 MHz	56.3052	35.8995
480.000000 MHz	56.1931	35.3936
490.000000 MHz	56.0068	34.9399
500.000000 MHz	55.8283	34.5713
510.000000 MHz	55.6646	34.1618
520.000000 MHz	55.5327	33.7934
530.000000 MHz	55.3695	33.4118
540.000000 MHz	55.2940	32.9658
550.000000 MHz	55.1292	32.6751

Test Report S/N:	021704-479K7G
Test Date(s):	February 26, 2004
Test Type:	FCC/IC SAR Evaluation

APPENDIX F - SAR TEST SETUP & DUT PHOTOGRAPHS

FACE-HELD SAR TEST SETUP PHOTOGRAPHS
2.5 cm Separation Distance from Front of Radio to Planar Phantom

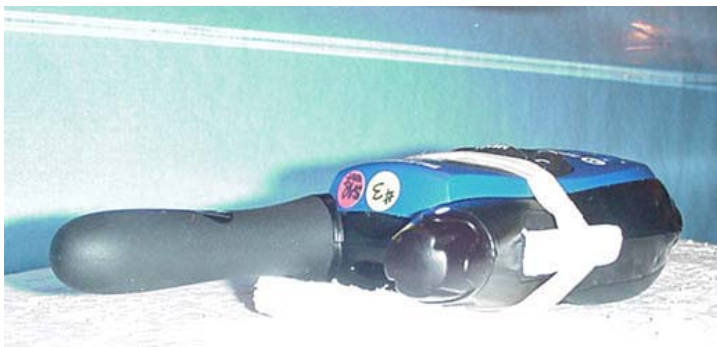
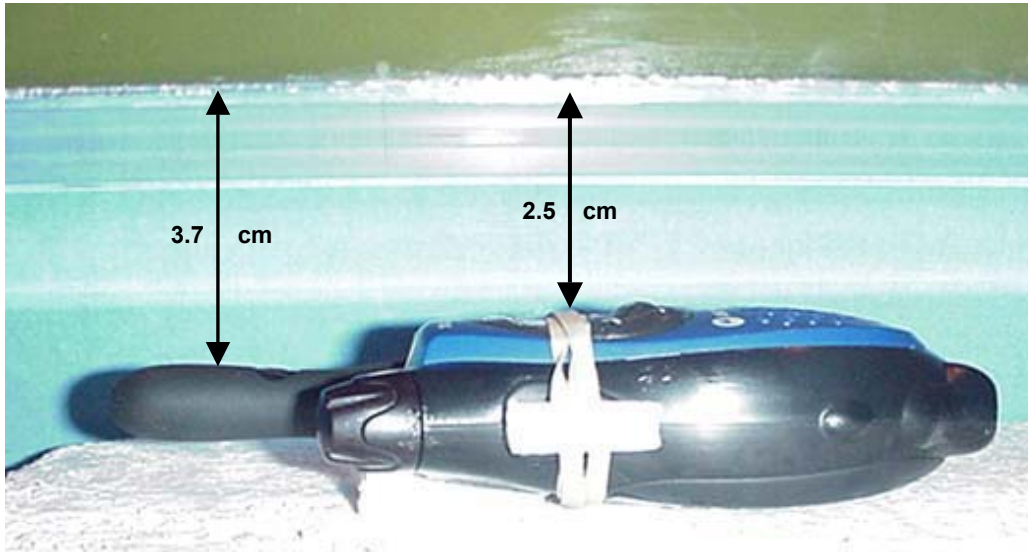

BODY-WORN SAR TEST SETUP PHOTOGRAPHS
1.5 cm Plastic Belt-Clip Separation Distance to Planar Phantom
with Earbud/Lapel-Microphone Accessory

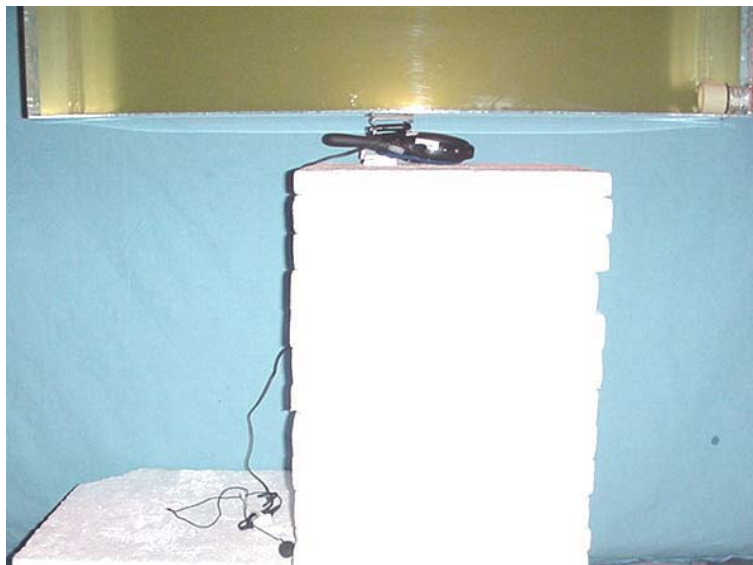
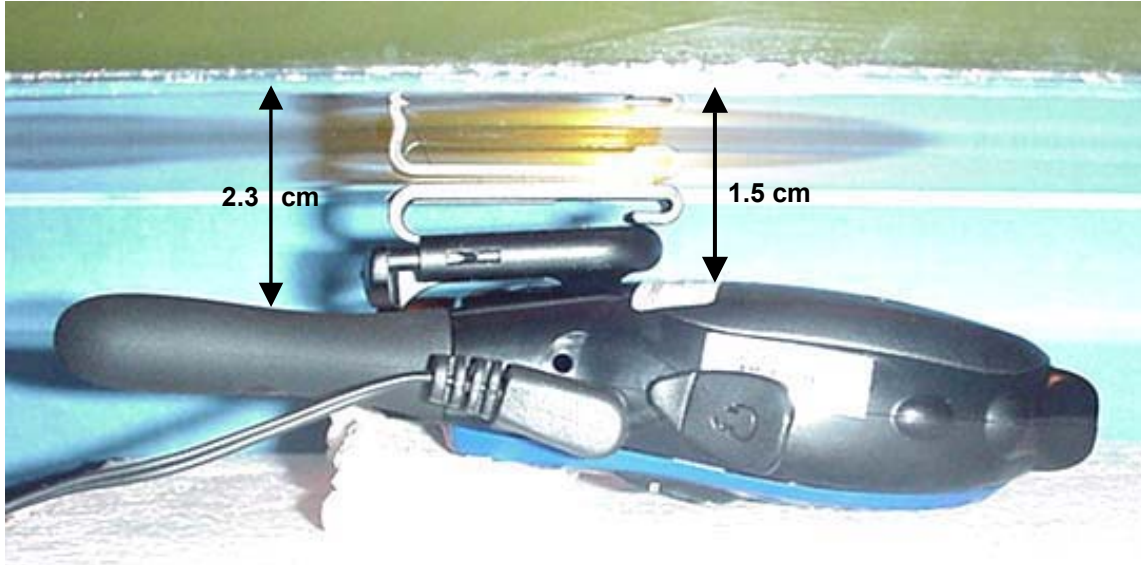

BODY-WORN SAR TEST SETUP PHOTOGRAPHS
1.5 cm Plastic Belt-Clip Separation Distance to Planar Phantom
with Headset/Boom-Microphone Accessory

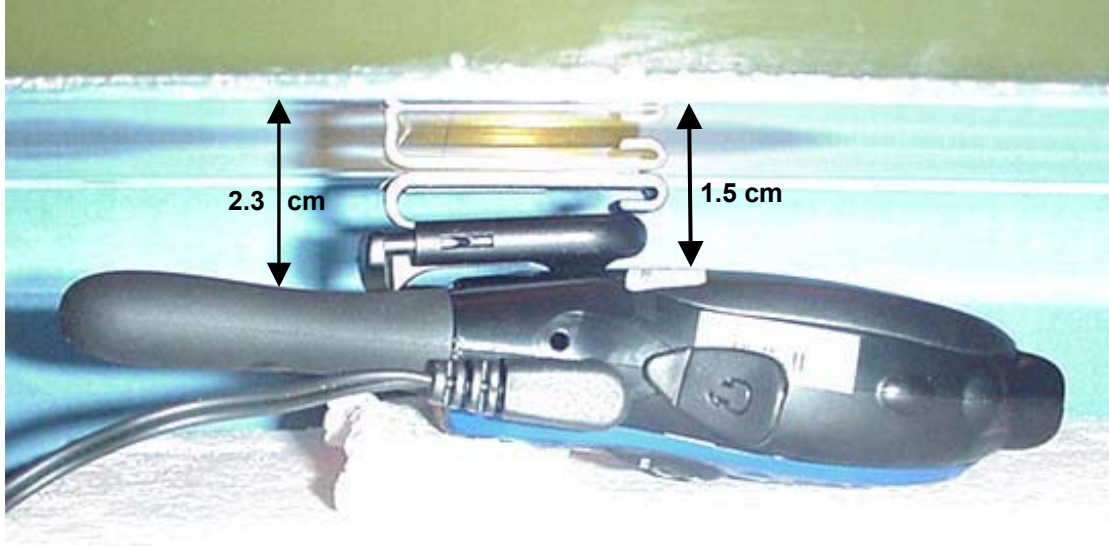

DUT PHOTOGRAPHS



Front of DUT



Back of DUT



Back of DUT with Plastic Belt-Clip

DUT PHOTOGRAPHS



Left Side of DUT with Plastic Belt-Clip



Right Side of DUT with Plastic Belt-Clip



Plastic Belt-Clip Accessory

DUT PHOTOGRAPHS



DUT Battery Compartment



DUT with NiCd Battery Pack



DUT with Duracell Procell AA Alkaline Batteries



DUT with Energizer E-Squared AA Alkaline Batteries



Top of DUT



Bottom of DUT

DUT PHOTOGRAPHS



DUT with Earbud/Lapel- Microphone accessory



DUT with Headset/Boom-Microphone accessory