

## SYSTEM DESCRIPTION AND INSTALLATION MANUAL JetWave™ System

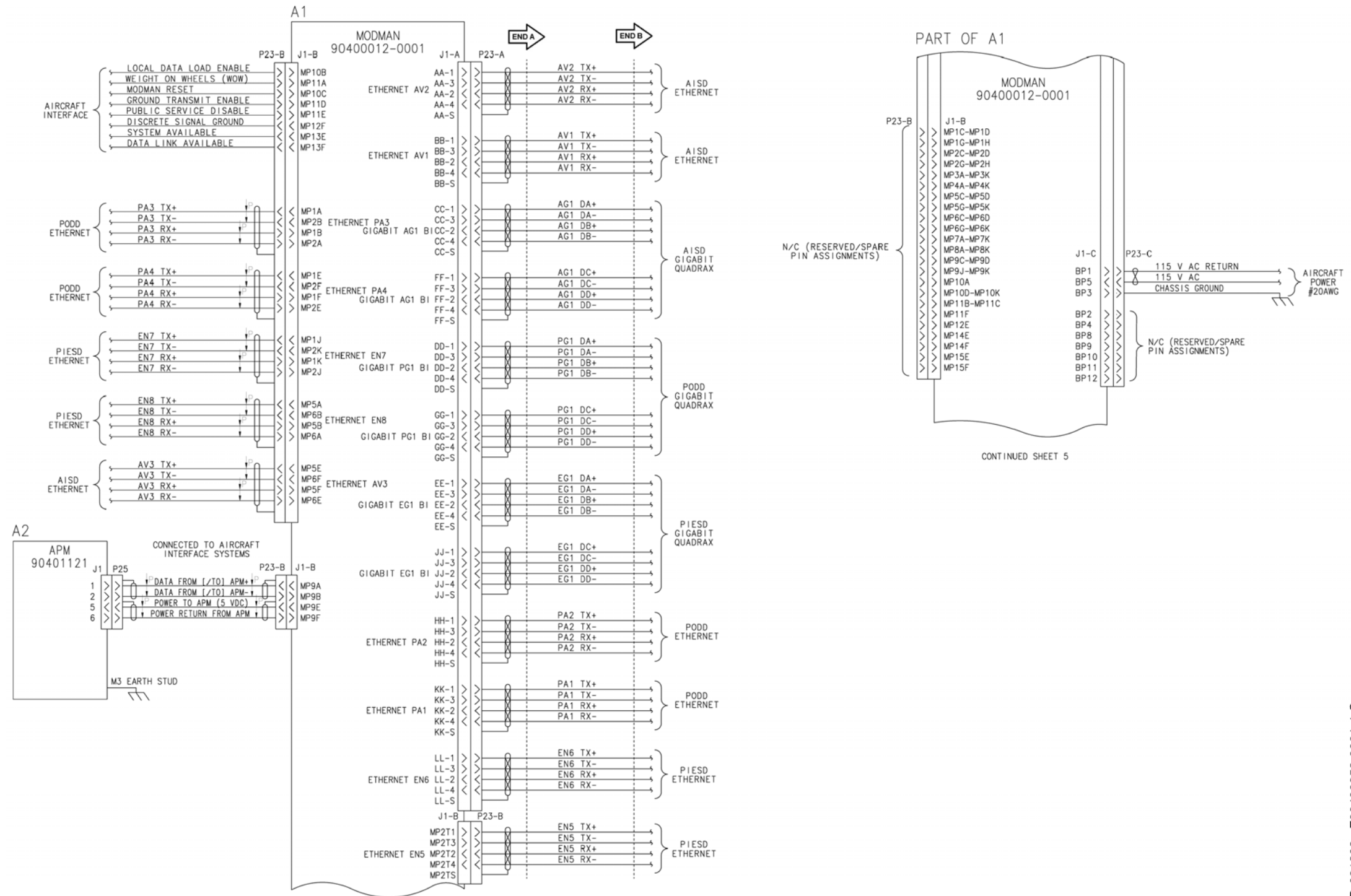
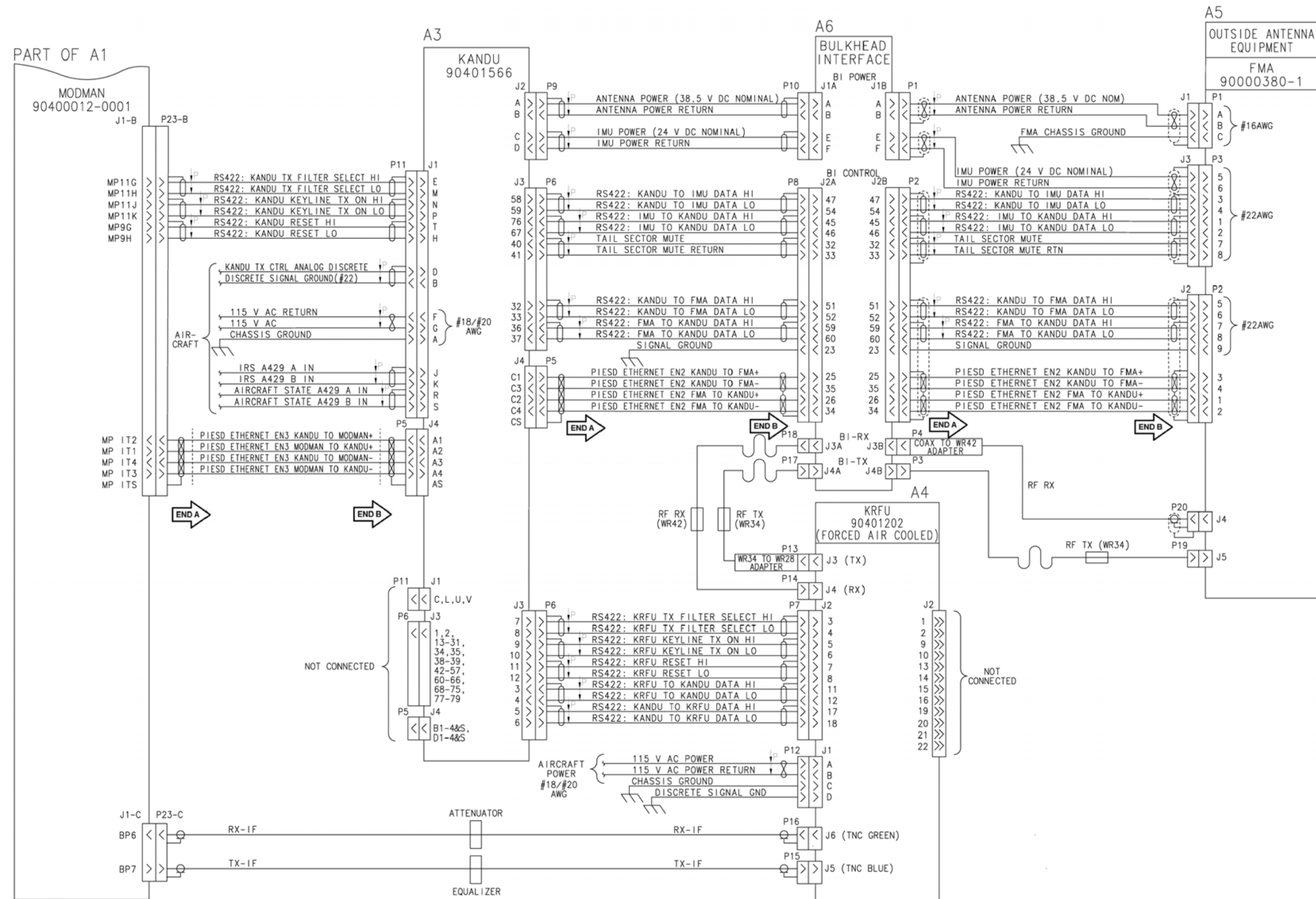


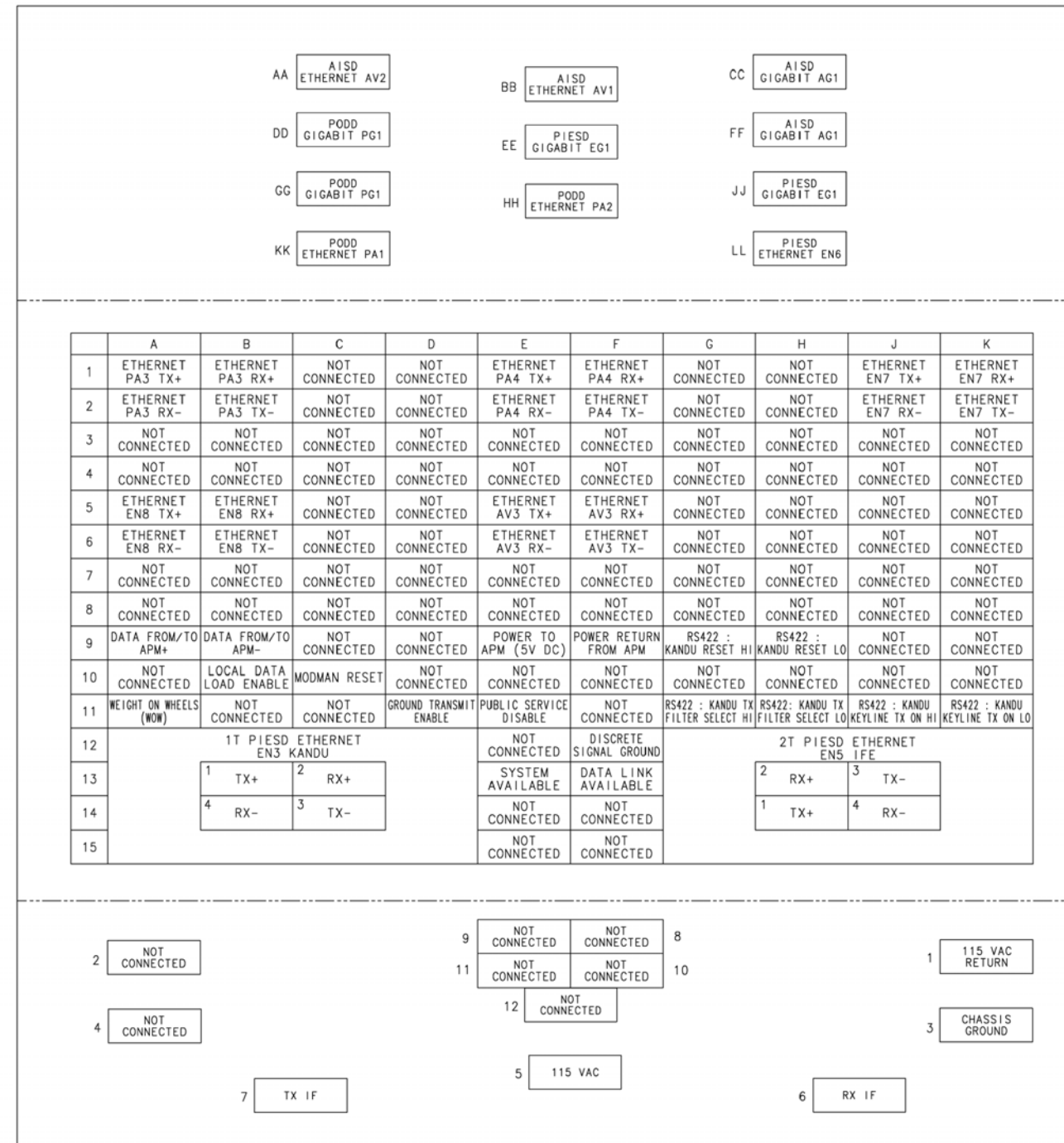
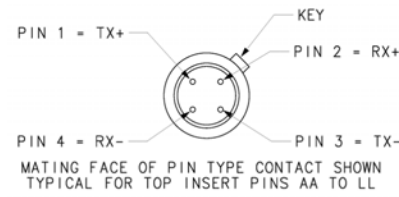
Figure 4-35. (Sheet 4 of 8) JetWave™ System Interconnect Diagram - FMA (KRFU Inside Aircraft Fuselage), (90400259-0001, REV C)

## SYSTEM DESCRIPTION AND INSTALLATION MANUAL JetWave™ System

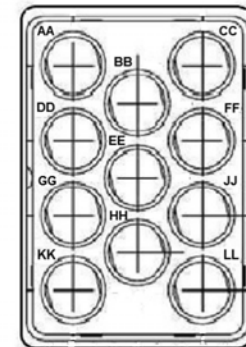


ID-621890 E90400259-0001-5-C

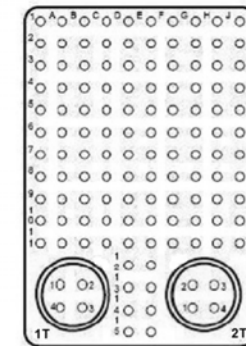
Figure 4-35. (Sheet 5 of 8) JetWave™ System Interconnect Diagram - FMA (KRFU Inside Aircraft Fuselage), (90400259-0001, REV C)



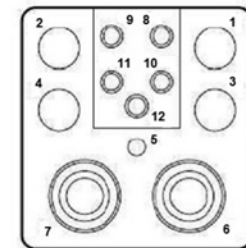
TOP INSERT



MIDDLE INSERT



BOTTOM INSERT



CONTACT ASSIGNMENTS FOR MODMAN A1J1  
VIEW SHOWN ON MATING FACE

ID-621891 E90400259-0001-6-C

Figure 4-35. (Sheet 6 of 8) JetWave™ System Interconnect Diagram - FMA (KRFU Inside Aircraft Fuselage), (90400259-0001, REV C)

TABLE 1 : APM A2J1 CONNECTOR PIN ASSIGNMENTS

PIN NUMBER	SIGNAL NAME
1	DATA FROM [/TO] APM +
2	DATA FROM [/TO] APM -
3	NOT CONNECTED
4	NOT CONNECTED
5	POWER TO APM (5 V DC)
6	POWER RETURN FROM APM
7-13	NOT CONNECTED

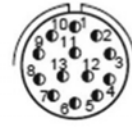


TABLE 2: KANDU A3J1 CONNECTOR PIN ASSIGNMENTS

PIN NO	PIN DESIGNATION
A	CHASSIS GROUND
B	DISCRETE SIGNAL GROUND
C	NOT CONNECTED
D	KANDU TX CONTROL ANALOG DISCRETE
E	RS422: KANDU TX FILTER SELECT HI
F	115 V AC RETURN
G	115 V AC
H	RS422: KANDU RESET LO
J	IRS A429 A IN
K	IRS A429 B IN
L	NOT CONNECTED
M	RS422: KANDU TX FILTER SELECT LO
N	RS422: KANDU KEYLINE TX ON HI
P	RS422: KANDU KEYLINE TX ON LO
R	AIRCRAFT STATE A429 A IN
S	AIRCRAFT STATE A429 B IN
T	RS422: KANDU RESET HI
U	NOT CONNECTED
V	NOT CONNECTED

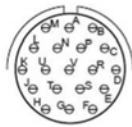
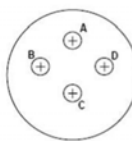


TABLE 3: KANDU A3J2 CONNECTOR PIN ASSIGNMENTS

PIN NO	PIN DESIGNATION
A	ANTENNA POWER (38.5 V DC NOMINAL)
B	ANTENNA POWER RETURN
C	IMU POWER (24 V DC NOMINAL)
D	IMU POWER RETURN



CONTACT LEGEND, EXCEPT KANDU J4 (QUADRIX INTERFACE) AND MODMAN (ARINC 600 CONTACTS)



TABLE 4 : KANDU A3J3 CONNECTOR PIN ASSIGNMENTS

PIN NO	PIN DESIGNATION	PIN NO	PIN DESIGNATION
1	NOT CONNECTED	41	TAIL SECTOR MUTE RETURN
2	NOT CONNECTED	42	NOT CONNECTED
3	RS422: KRFU TO KANDU DATA HI	43	NOT CONNECTED
4	RS422: KRFU TO KANDU DATA LO	44	NOT CONNECTED
5	RS422: KANDU TO KRFU DATA HI	45	NOT CONNECTED
6	RS422: KANDU TO KRFU DATA LO	46	NOT CONNECTED
7	RS422: KRFU TX FILTER SELECT HI	47	NOT CONNECTED
8	RS422: KRFU TX FILTER SELECT LO	48	NOT CONNECTED
9	RS422: KRFU KEYLINE TX ON HI	49	NOT CONNECTED
10	RS422: KRFU KEYLINE TX ON LO	50	NOT CONNECTED
11	RS422: KRFU RESET HI	51	NOT CONNECTED
12	RS422: KRFU RESET LO	52	NOT CONNECTED
13	NOT CONNECTED	53	NOT CONNECTED
14	NOT CONNECTED	54	NOT CONNECTED
15	NOT CONNECTED	55	NOT CONNECTED
16	NOT CONNECTED	56	NOT CONNECTED
17	NOT CONNECTED	57	NOT CONNECTED
18	NOT CONNECTED	58	RS422: KANDU TO IMU DATA HI
19	NOT CONNECTED	59	RS422: KANDU TO IMU DATA LO
20	NOT CONNECTED	60	NOT CONNECTED
21	NOT CONNECTED	61	NOT CONNECTED
22	NOT CONNECTED	62	NOT CONNECTED
23	NOT CONNECTED	63	NOT CONNECTED
24	NOT CONNECTED	64	NOT CONNECTED
25	NOT CONNECTED	65	NOT CONNECTED
26	NOT CONNECTED	66	NOT CONNECTED
27	NOT CONNECTED	67	RS422: IMU TO KANDU DATA LO
28	NOT CONNECTED	68	NOT CONNECTED
29	NOT CONNECTED	69	NOT CONNECTED
30	NOT CONNECTED	70	NOT CONNECTED
31	NOT CONNECTED	71	NOT CONNECTED
32	RS422: KANDU TO FMA DATA HI	72	NOT CONNECTED
33	RS422: KANDU TO FMA DATA LO	73	NOT CONNECTED
34	NOT CONNECTED	74	NOT CONNECTED
35	NOT CONNECTED	75	NOT CONNECTED
36	RS422: FMA TO KANDU DATA HI	76	RS422: IMU TO KANDU DATA HI
37	RS422: FMA TO KANDU DATA LO	77	NOT CONNECTED
38	NOT CONNECTED	78	NOT CONNECTED
39	NOT CONNECTED	79	NOT CONNECTED
40	TAIL SECTOR MUTE		

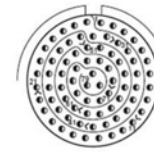


TABLE 6 : KRFU A4J1 CONNECTOR PIN ASSIGNMENTS

PIN NO	PIN DESIGNATION
A	115 V AC POWER
B	115 V AC POWER RETURN
C	CHASSIS GROUND
D	DISCRETE SIGNAL GROUND

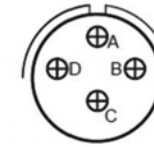


TABLE 7 : KRFU A4J2 CONNECTOR PIN ASSIGNMENTS

PIN NO	PIN DESIGNATION
1	NOT CONNECTED
2	NOT CONNECTED
3	RS422 : KRFU TX FILTER SELECT HI
4	RS422 : KRFU TX FILTER SELECT LO
5	RS422 : KRFU KEYLINE TX ON HI
6	RS422 : KRFU KEYLINE TX ON LO
7	RS422 : KRFU RESET HI
8	RS422 : KRFU RESET LO
9	NOT CONNECTED
10	NOT CONNECTED
11	RS422 : KRFU TO KANDU DATA HI
12	RS422 : KRFU TO KANDU DATA LO
13	NOT CONNECTED
14	NOT CONNECTED
15	NOT CONNECTED
16	NOT CONNECTED
17	RS422 : KANDU TO KRFU DATA HI
18	RS422 : KANDU TO KRFU DATA LO
19	NOT CONNECTED
20	NOT CONNECTED
21	NOT CONNECTED
22	NOT CONNECTED

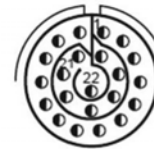


TABLE 5 : KANDU A3J4 CONNECTOR PIN ASSIGNMENTS

PIN NO	PIN DESIGNATION
A-1	PIESD ETHERNET EN3 KANDU TO MODMAN+
A-3	PIESD ETHERNET EN3 KANDU TO MODMAN-
A-2	PIESD ETHERNET EN3 MODMAN TO KANDU+
A-4	PIESD ETHERNET EN3 MODMAN TO KANDU-
A-S	PIESD ETHERNET EN3 SHIELD
B-1	NOT CONNECTED
B-3	NOT CONNECTED
B-2	NOT CONNECTED
B-4	NOT CONNECTED
B-S	NOT CONNECTED
C-1	PIESD ETHERNET EN2 KANDU TO FMA+
C-3	PIESD ETHERNET EN2 KANDU TO FMA-
C-2	PIESD ETHERNET EN2 FMA TO KANDU+
C-4	PIESD ETHERNET EN2 FMA TO KANDU-
C-S	PIESD ETHERNET EN2 SHIELD
D-1	NOT CONNECTED
D-3	NOT CONNECTED
D-2	NOT CONNECTED
D-4	NOT CONNECTED
D-S	NOT CONNECTED

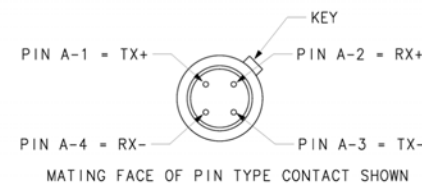
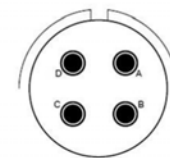


Figure 4-35. (Sheet 7 of 8) JetWave™ System Interconnect Diagram - FMA (KRFU Inside Aircraft Fuselage), (90400259-0001, REV C)

## SYSTEM DESCRIPTION AND INSTALLATION MANUAL JetWave™ System

TABLE 8 : BULKHEAD INTERFACE – POWER A6J1A & A6J1B CONNECTOR PIN ASSIGNMENTS

PIN NO	PIN DESIGNATION
A	ANTENNA POWER (38.5 V DC NOM)
B	ANTENNA POWER RETURN
C	NOT CONNECTED
D	NOT CONNECTED
E	IMU POWER (24 V DC NOMINAL)
F	IMU POWER RETURN
G	NOT CONNECTED
H	NOT CONNECTED

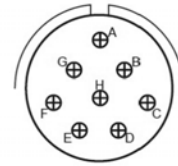


TABLE 10 : OAE FMA A5P1 CONNECTOR PIN ASSIGNMENTS

PIN NO	PIN DESIGNATION
A	ANTENNA POWER (38.5 V DC NOM)
B	ANTENNA POWER RETURN
C	FMA CHASSIS GROUND
D	NOT CONNECTED

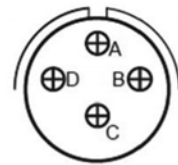


TABLE 11 : OAE FMA A5P3 CONNECTOR PIN ASSIGNMENTS

PIN NO	PIN DESIGNATION
1	RS422: IMU TO KANDU DATA HI
2	RS422: IMU TO KANDU DATA LO
3	RS422: KANDU TO IMU DATA HI
4	RS422: KANDU TO IMU DATA LO
5	IMU POWER (24 V DC NOMINAL)
6	IMU POWER RETURN
7	TAIL SECTOR MUTE
8	TAIL SECTOR MUTE RETURN
9	NOT CONNECTED
10	NOT CONNECTED
11	NOT CONNECTED
12	NOT CONNECTED
13	NOT CONNECTED



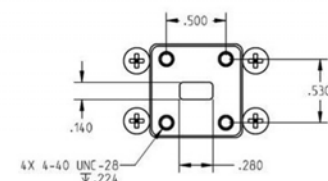
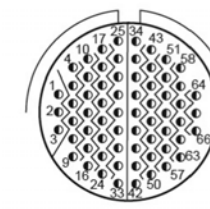
TABLE 12 : OAE FMA A5P2 CONNECTOR PIN ASSIGNMENTS

PIN NO	PIN DESIGNATION
1	PIESD ETHERNET EN2 FMA TO KANDU+
2	PIESD ETHERNET EN2 FMA TO KANDU-
3	PIESD ETHERNET EN2 KANDU TO FMA+
4	PIESD ETHERNET EN2 KANDU TO FMA-
5	RS422: KANDU TO FMA DATA HI
6	RS422: KANDU TO FMA DATA LO
7	RS422: FMA TO KANDU DATA HI
8	RS422: FMA TO KANDU DATA LO
9	SIGNAL GROUND
10	NOT CONNECTED
11	NOT CONNECTED
12	NOT CONNECTED
13	NOT CONNECTED

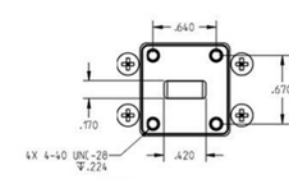


TABLE 9 : BULKHEAD INTERFACE – CONTROL A6J2A & A6J2B CONNECTOR PIN ASSIGNMENTS FOR KRFU INSTALLED INSIDE PRESSURIZED AREA

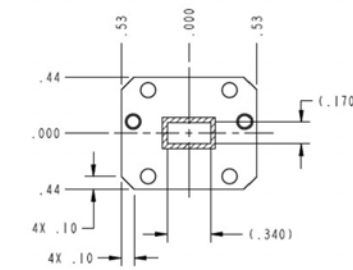
PIN NO	PIN DESIGNATION	PIN NO	PIN DESIGNATION
1	NOT CONNECTED	34	PIESD ETHERNET EN2 FMA TO KANDU-
2	NOT CONNECTED	35	PIESD ETHERNET EN2 KANDU TO FMA-
3	NOT CONNECTED	36	NOT CONNECTED
4	NOT CONNECTED	37	NOT CONNECTED
5	NOT CONNECTED	38	NOT CONNECTED
6	NOT CONNECTED	39	NOT CONNECTED
7	NOT CONNECTED	40	NOT CONNECTED
8	NOT CONNECTED	41	NOT CONNECTED
9	NOT CONNECTED	42	NOT CONNECTED
10	NOT CONNECTED	43	NOT CONNECTED
11	NOT CONNECTED	44	NOT CONNECTED
12	NOT CONNECTED	45	RS422: IMU TO KANDU DATA HI
13	NOT CONNECTED	46	RS422: IMU TO KANDU DATA LO
14	NOT CONNECTED	47	RS422: KANDU TO IMU DATA HI
15	NOT CONNECTED	48	NOT CONNECTED
16	NOT CONNECTED	49	NOT CONNECTED
17	NOT CONNECTED	50	NOT CONNECTED
18	NOT CONNECTED	51	RS422: KANDU TO FMA DATA HI
19	NOT CONNECTED	52	RS422: KANDU TO FMA DATA LO
20	NOT CONNECTED	53	NOT CONNECTED
21	NOT CONNECTED	54	RS422: KANDU TO IMU DATA LO
22	NOT CONNECTED	55	NOT CONNECTED
23	SIGNAL GROUND	56	NOT CONNECTED
24	NOT CONNECTED	57	NOT CONNECTED
25	PIESD ETHERNET EN2 KANDU TO FMA+	58	NOT CONNECTED
26	PIESD ETHERNET EN2 FMA TO KANDU+	59	RS422: FMA TO KANDU DATA HI
27	NOT CONNECTED	60	RS422: FMA TO KANDU DATA LO
28	NOT CONNECTED	61	NOT CONNECTED
29	NOT CONNECTED	62	NOT CONNECTED
30	NOT CONNECTED	63	NOT CONNECTED
31	NOT CONNECTED	64	NOT CONNECTED
32	TAIL SECTOR MUTE	65	NOT CONNECTED
33	TAIL SECTOR MUTE RETURN	66	NOT CONNECTED



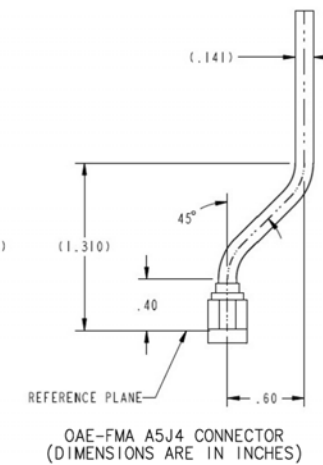
MATING FACE OF KRFU A4J3  
MATING FACE OF B1 A6J4A & A6J4B  
(DIMENSIONS ARE IN INCHES)



MATING FACE OF KRFU A4J4  
MATING FACE OF B1 A6J3A & A6J3B  
(DIMENSION ARE IN INCHES)



MATING FACE OF OAE-FMA A5J5  
(DIMENSIONS ARE IN INCHES)



OAE-FMA A5J4 CONNECTOR  
(DIMENSIONS ARE IN INCHES)

CONTACT LEGEND, EXCEPT KANDU J4 (QUADRIX INTERFACE) AND MODMAN (ARINC 600 CONTACTS)

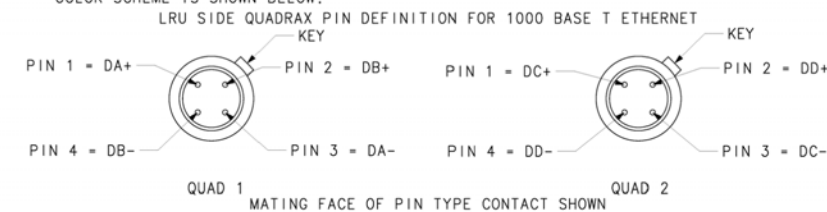


Figure 4-35. (Sheet 8 of 8) JetWave™ System Interconnect Diagram - FMA (KRFU Inside Aircraft Fuselage), (90400259-0001, REV C)

## SYSTEM DESCRIPTION AND INSTALLATION MANUAL JetWave™ System

NOTES, UNLESS OTHERWISE SPECIFIED:

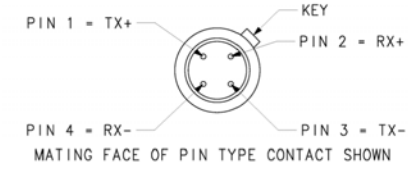
1. ALL CABLING SHOULD BE IN ACCORDANCE EITHER WITH *SAE AS50881: WIRING AEROSPACE VEHICLE STANDARD* OR AS PER AIRFRAME MANUFACTURER'S REQUIREMENTS.
2. WIRE SIZE RECOMMENDATIONS:  
UNLESS OTHERWISE SPECIFIED ALL SIGNAL WIRES SHALL BE #24AWG.
  - (A) RECOMMENDED TO USE SHIELDED TWISTED PAIR M27500G24SD2T23 OR EQUIVALENT.
  - (B) RECOMMENDED TO USE SHIELDED TWISTED PAIR M27500G16SD2T23 OR EQUIVALENT FOR ANTENNA POWER, ANTENNA POWER RETURN, IMU POWER AND IMU POWER RETURN.
  - (C) RECOMMENDED TO USE ARINC 664 COMPLIANT STAR QUAD CABLE FOR ETHERNET INTERFACES TERMINATING ON QUADRAX RECEPTACLES.
  - (D) GXA LRU QUADRAX TERMINATIONS ARE WITH PIN TYPE CONTACTS.
  - (E) ETHERNET STAR QUAD WIRE TERMINATIONS SHOULD NOT DISTORT NATURAL WIRE TWIST.
  - (F) NO WIRES ARE TO BE LEFT EXPOSED OUTSIDE (TO THE REAR) OF QUADRAX CONTACT SHELL.
  - (G) RECOMMENDED TO USE UNSHIELDED SINGLE CONDUCTOR WIRE FOR SIGNAL GROUND FOR OAE-FMA AND KRFU.
3. UNLESS OTHERWISE STATED, THE BONDING RESISTANCE SHOULD NOT EXCEED 0.005 Ω.
4. THE CHARACTERISTIC IMPEDANCE OF RS422 CABLES SHOULD MATCH RS422 DIFFERENTIAL SIGNAL TERMINAL IMPEDANCE REQUIREMENT OF 120 Ω±20%.
5. ALL CABLE SHIELDS SHOULD BE BONDED TO THE BACKSHELL OR CONNECTOR BODY.
6. MATING PLUGS SHOULD BE NICKEL-PLATED ALUMINUM, NICKEL PLATED COMPOSITE OR STAINLESS STEEL.
7. RF COAXIAL RECEPTACLES AND MATING CONNECTORS SHOULD BE NICKEL-PLATED BRASS.
8. (A) 10/100 MBPS ETHERNET AND GIGABIT ETHERNET INTERFACES ARE PROVISIONED IN THE THREE VLAN TAGGED ISOLATED DOMAINS
  - (i) PASSENGER OWNED DEVICES DOMAIN (PODD),
  - (ii) PASSENGER INFORMATION AND ENTERTAINMENT SERVICES DOMAIN (PIESD) AND
  - (iii) AIRLINE INFORMATION SERVICES DOMAIN (AISD).
- (B) EN2 AND EN3 ETHERNET INTERFACE OPERATE AT 10 Mbps.
- (C) INSTALLER TO CHOOSE THE ETHERNET INTERFACE AS DEFINED IN APM CONFIGURATION FILE.
9. ALL CABLE SHIELDS, EXCEPT ETHERNET SHIELDS TERMINATED TO QUADRAX CONTACTS, SHOULD BE TERMINATED TO A CONNECTOR BACKSHELL OR GROUNDING POINT DETERMINED BY THE AIRFRAME MANUFACTURER.
10. ALL SHIELDED TWISTED PAIR WIRE FOR ETHERNET INTERFACE SHOULD BE OF 100 Ω CONTROLLED IMPEDANCE.
11. (A) STAR QUAD CABLES SHOULD BE USED FOR GIGABIT ETHERNET INTERCONNECTIONS. RECOMMENDED PIN DEFINITION AND COLOR SCHEME IS SHOWN BELOW.



COLOR CODE FOR POINT TO POINT 1000BASE T ETHERNET CONFIGURATION		
PRIMARY LRU SIGNAL	WIRE COLOR	PERIPHERAL LRU SIGNAL
DA+	QUAD 1 - RED	DB+
DA-	QUAD 1 - BLUE	DB-
DB+	QUAD 1 - YELLOW	DA+
DB-	QUAD 1 - GREEN	DA-
DC+	QUAD 2 - RED	DD+
DC-	QUAD 2 - BLUE	DD-
DD+	QUAD 2 - YELLOW	DC+
DD-	QUAD 2 - GREEN	DC-

11. (B) GIGABIT ETHERNET INTERFACES AG1, PG1 AND EG1 SUPPORT 1000BASE-T (IEEE 802.3AB).
12. (A) SHIELDED TWISTED PAIR (2-PAIR) CABLES SHOULD BE USED FOR 10/100 MBPS ETHERNET INTERCONNECTIONS. RECOMMENDED PIN DEFINITIONS AND COLOR SCHEME IS SHOWN BELOW.

COLOR CODE FOR POINT TO POINT 10/100 BASE T ETHERNET WIRING		
PRIMARY LRU SIGNAL	WIRE COLOR	PERIPHERAL LRU SIGNAL
TX +	RED	RX +
TX -	BLUE	RX -
RX +	YELLOW	TX +
RX -	GREEN	TX -



- (B) ALL THE ETHERNET INTERFACES OPERATE ON 10/100 AUTO NEGOTIATED EXCEPT PIESD ETHERNET EN3 & PIESD ETHERNET EN2.
13. (A) GXA MODMAN, KANDU AND KRFU OPERATE ON AIRCRAFT POWER SUPPLY OF 115 VAC POWER (96 VRMS TO 122 VRMS WITH FREQUENCY RANGE OF MINIMUM 320 Hz TO 800 Hz). GXA FMA OPERATES ON 38.5 VDC/24 VDC VOLTAGE GENERATED BY KANDU.
  - (B) GXA DISCRETE SIGNALS ELECTRICAL SPECIFICATIONS ARE IN ACCORDANCE WITH ARINC SPECIFICATION 791/763 SECTION 2.9.6. AND 2.9.7, WITH MAXIMUM CONTROL VOLTAGE NOT EXCEEDING +36 VDC, GROUND (VALID) STATE DEFINED AS LESS THAN 3.5 VDC AND OPEN (INVALID) STATE DEFINED AS VOLTAGE LEVEL BETWEEN 18.5 TO 36 VDC OR RESISTANCE BETWEEN PIN AND AIRFRAME DC GROUND GREATER THAN 100 KΩ. THE MAXIMUM CURRENT FLOW IN THE STEADY STATE 'GROUND' STATE NOT TO EXCEED 20 MA.
  - (C) GXA KANDU LRU SUPPORTS TWO A429 RECEIVE ONLY INTERFACES. IRS A429 INTERFACE OPERATE ON HIGH SPEED AND AIRCRAFT STATE A429 INTERFACE IS CONFIGURABLE TO OPERATE ON BOTH HIGH AND LOW SPEEDS.

14. EMPTY CAVITY CONTACTS ARE INSTALLED BUT NO ELECTRICAL CONNECTIONS.

15. DENOTES TWISTED PAIR (TP). DENOTES TWISTED SHIELDED PAIR (TSP). DENOTES SHIELDED TWISTED CABLE (2 PAIR).

- DENOTES OVERBRAID. DENOTES QUADRAX TERMINATION WITH STAR QUAD WIRING. DENOTES QUADRAX CABLE/SHIELDED TWISTED PAIR

16. DENOTES CHASSIS GROUND. DENOTES RECTANGULAR WAVEGUIDE. DENOTES POWER CABLE. DENOTES FLEX/TWIST WAVEGUIDE.

IDENTIFIES CONNECTOR ROTATION OF WIRE WITH CLOCKWISE ROTATION: RED - GREEN - BLUE - YELLOW

IDENTIFIES CONNECTOR ROTATION OF WIRE WITH COUNTERCLOCKWISE ROTATION: RED - YELLOW - BLUE - GREEN

17. AIRPLANE PERSONALITY MODULE (APM)
  - (A) CABLE LENGTH BETWEEN MODMAN AND APM SHALL NOT EXCEED 3 METERS.
  - (B) RECOMMENDED TO USE 0.164-32 UNC-2A CORROSION RESISTANT MOUNTING FASTENERS. MOUNTING SCREWS TORQUE SHOULD NOT EXCEED 25 IN-LBS.
  - (C) APM RECEPTACLE A2J1 IS MIL-DTL-38999/20FB35PN, SERIES III, SHELL SIZE 11 (B) WITH INSERT 11-35 (13 PIN). MATES WITH D38999/26FB35SN OR EQUIVALENT.
  - (D) APM DC BONDING RESISTANCE SHOULD NOT EXCEED 2.5 mΩ.
  - (E) APM A2J1 CONNECTOR CONTACT ASSIGNMENTS SHOWN IN TABLE 1 (SHEET 7).
  - (F) APM CAN OPERATE WITHOUT THE NEED OF ANY FORCED AIR COOLING.
  - (G) APM BONDING MAY BE THROUGH CONTACT WITH BASE OF UNIT AND THROUGH A BONDING CABLE.
  - (H) APM TO MODMAN INTERCONNECT CABLE SHALL USE ARINC 664 COMPLIANT 2 SHIELDED TWISTED PAIR 24AWG (OR AEROSPACE GRADE SHIELDED CAT 5/CATE 5E MINIMUM). PART NO ECS 922404 OR EQUIVALENT.

(CONTINUED SHEET 2)

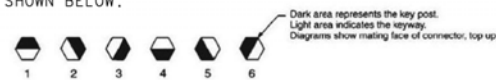
Figure 4-36. (Sheet 1 of 8) JetWave™ System Interconnect Diagram - FMA (KRFU Outside Aircraft Fuselage), (90401047-1, REV F)

## SYSTEM DESCRIPTION AND INSTALLATION MANUAL JetWave™ System

NOTES (CONTINUED FROM SHEET 1):

### 18. MODEM MANAGER (MODMAN)

- (A) LRU TO BE MOUNTED ONLY IN AN ARINC 600 TRAY WITH MATCHING CONNECTOR SCHEME.
- (B) THE MODMAN USES A STANDARD ARINC SPECIFICATION 600, SIZE 2 CONNECTOR. MATES WITH RADIAL NSXN2B875500 OR EQUIVALENT. THIS SINGLE RECEPTACLE INCLUDES THREE SEPARATE INSERTS (MODMAN A1J1-A, MODMAN A1J1-B, AND MODMAN A1J1-C).
  - (i) MODMAN A1J1-A : ARRANGEMENT Q11, SHELL SIZE 2 (11X SIZE 8 QUADRAX CAVITIES)CONNECTOR.
  - (ii) MODMAN A1J1-B : ARRANGEMENT 120Q2, SHELL SIZE 2 (11X #22 CONTACTS, 2 SIZE 8 QUADRAX CAVITIES) CONNECTOR.
  - (iii) MODMAN A1J1-C : ARRANGEMENT 12F5C2, SHELL SIZE 2 (4X #12 CONTACTS, 1X #16 CONTACT, 5X SIZE 16 OPTICAL CAVITIES, 2X SIZE 5 COAX CAVITIES). OPTICAL INTERFACES ARE NOT USED.
- (C) MODMAN BONDING IS THROUGH CONTACT WITH THE BASE OF THE UNIT.
- (D) DC BONDING RESISTANCE SHOULD NOT EXCEED 2.5 mΩ.
- (E) MODMAN A1J1 CONNECTOR CONTACT ASSIGNMENTS SHOWN ON SHEET 6.
- (F) MODMAN KEYING IS AS SHOWN BELOW.



	Receptacle (Modman)			Plug (Rack)		
Position	Left Post	Center Post	Right Post	Left Post	Center Post	Right Post
52	6	3	1	4	2	5

- (G) PDD ETHERNET PA1, PDD ETHERNET PA2, PDD ETHERNET PA3 AND PDD ETHERNET PA4 ARE DEFINED AS PER ARINC 791 PART 1 ALTERNATE CONFIGURATION.

### 19. FOR TX-IF AND RX-IF COAXIAL CABLE ASSEMBLY BETWEEN MODMAN A1J1-C AND THE KRFU A4J5 & A4J6 :

- (A) STRAIN RELIEF HEAT SHRINK SLEEVING OF LENGTH 0.5\* +/- 0.05\* SHOULD BE PROVIDED TO PREVENT STRESS CONCENTRATION AT TX-IF AND RX-IF CABLE TERMINATIONS.
- (B) OVERBRAID/SLEEVE JACKETING SHOULD BE USED FOR PROTECTION OF WIRING BETWEEN BULKHEAD INTERFACE A6J3B AND A6J4B AND KRFU A4J5/A4J6. OVERBRAID MAY BE CONNECTED VIA CONNECTOR SHIELD/HOUSING OR DIRECTLY TO HOUSING.
- (C) COAXIAL CABLE WITH FOLLOWING SPECIFICATIONS RECOMMENDED FOR TX-IF AND RX-IF INTERCONNECTION BETWEEN MODMAN AND KRFU.
  - (i) THE MINIMUM CABLE INSERTION LOSS SHOULD BE 11 dB AT 950 MHz.
  - (ii) THE MAXIMUM CABLE INSERTION LOSS SHOULD NOT EXCEED 18 dB AT 1450 MHz AND 21.2 dB AT 1950 MHz.
  - (iii) THE NOMINAL CHARACTERISTIC IMPEDANCE : 50 Ω ± 2 Ω AT IF (950-1950 MHz) AND REFERENCE (50 MHz) FREQUENCIES.
  - (iv) MAXIMUM VOLTAGE STANDING WAVE RATIO (VSWR), AS MEASURED AGAINST 50 OHMS : 1.5:1 FROM 10 MHz TO 6 GHz.
  - (v) THE ISOLATION BETWEEN THE TX-IF CABLE AND THE RX-IF CABLE SHOULD BE A MINIMUM OF 120 dB AT 2150 MHz.
  - (vi) POWER HANDLING CAPABILITY : +5 dBm AT IF AND REFERENCE FREQUENCY RANGE (950-1950 MHz).
  - (vii) CABLE RUN ATTENUATION AT 50 MHz SHOULD NOT EXCEED 3.1 dB.
  - (viii) THE VARIATION IN CABLE LOSS BETWEEN TX-IF AND RX-IF COAX CABLES SHOULD NOT EXCEED 1 dB AT 1450 MHz.
- (D) TX-IF CABLE SHOULD BE BLUE BANDED NEAR TNC/N TYPE CONNECTOR ENDS. RX-IF CABLE SHOULD BE GREEN BANDED NEAR TNC CONNECTOR ENDS.
- (E) RECOMMENDED TO USE 10.5 dB EQUALIZER IN TX-IF COAX CABLE INTERCONNECT AND 10.5 dB ATTENUATOR IN RX-IF COAX CABLE INTERCONNECT BETWEEN MODMAN A1J1-C AND BULKHEAD INTERFACE IF THE COAX INTERCONNECTS LOSS BETWEEN MODMAN AND KRFU IS LESS THAN 6.5 dB AT 950 MHz. EQUALIZER MINICIRCUITS P/N TAT-10R5DC-1 AND ATTENUATOR MINICIRCUITS P/N TAT-10R5-1+ OR EQUIVALENT.
- (F) RECOMMENDED TO USE 4.8 dB EQUALIZER IN TX-IF COAX CABLE INTERCONNECT AND 4.8 dB ATTENUATOR IN RX-IF COAX CABLE INTERCONNECT BETWEEN MODMAN A1J1-C AND BULKHEAD INTERFACE IF THE COAX INTERCONNECTS LOSS BETWEEN MODMAN AND KRFU IS GREATER THAN OR EQUAL TO 6.5 dB BUT LESS THAN 11 dB AT 950 MHz. EQUALIZER MINICIRCUITS P/N TAT-4R8DC-1 AND ATTENUATOR MINICIRCUITS P/N TAT-4R8-1+ OR EQUIVALENT.

### 20. KA-BAND AIRCRAFT NETWORKING DATA UNIT (KANDU)

- (A) KANDU RECEPTACLE A3J1 IS MIL-DTL-38999/20FD19PN, SERIES III, FLANGE MOUNT RECEPTACLE, INSERT 15-19, NORMAL KEYING, WITH 19 PIN-TYPE CONTACTS OF SIZE 20 AWG. MATES WITH D38999/26FD19SN FOR AIRCRAFT INTERFACE.
- (B) KANDU RECEPTACLE A3J2 IS MIL-DTL-38999/20FC4SN, SERIES III, FLANGE MOUNT RECEPTACLE, INSERT 13-4, NORMAL KEYING, WITH 4 SOCKET-TYPE CONTACTS OF SIZE 16 AWG. MATES WITH D38999/26FC4PN FOR POWER OUTPUT.

### 20. KA-BAND AIRCRAFT NETWORKING DATA UNIT (KANDU)(CONTINUED)

- (C) KANDU RECEPTACLE A3J3 IS MIL-DTL-38999/20FG35PN, SERIES III, FLANGE MOUNT RECEPTACLE, INSERT 21-35, NORMAL KEYING, WITH 79 PIN-TYPE CONTACTS OF SIZE 22 AWG. MATES WITH D38999/26FG35SN FOR CONTROL INTERFACE.
- (D) KANDU RECEPTACLE A3J4 IS TVP00RQF-21-75P (AMPHENOL)/ EQUIVALENT. MATES WITH TV06RQF-21-75S(AMPHENOL) OR EQUIVALENT FOR ETHERNET INTERFACE.
- (E) THE 16 AWG WIRE ROUTING FOR THE INTERCONNECT BETWEEN THE KANDU A3J2 AND OAE-FMA - A5P1 SHOULD NOT CAUSE THE ROUND TRIP WIRING INTERCONNECTION RESISTANCE TO EXCEED 0.326 Ω. FOR ANTENNA POWER DURING NORMAL OPERATION, THE MAXIMUM STEADY STATE POWER CONSUMPTION DURING NORMAL FMA ANTENNA OPERATION IS 135 WATTS.
- (F) KANDU BONDING TO THE AIRCRAFT SHOULD BE ACHIEVED THROUGH THE MOUNTING STRUCTURE (FASTENERS) AND KANDU A3J1-A.
- (G) KANDU CONNECTOR CONTACT ASSIGNMENTS SHOWN IN TABLES 2, 3, 4 AND 5 (SHEET 7).

### 21. KA-BAND RADIO FREQUENCY UNIT (KRFU)

- (A) KRFU RECEPTACLE A4J1 IS MIL-DTL-38999/20FC4PN, SERIES III, FLANGE MOUNT RECEPTACLE, INSERT 13-4, NORMAL KEYING, WITH 4 PIN-TYPE CONTACTS OF SIZE 16 AWG. MATES WITH D38999/26FC4SN FOR POWER INPUT.
- (B) KRFU RECEPTACLE A4J2 IS MIL-DTL-38999/20FC35PN, SERIES III, FLANGE MOUNT RECEPTACLE, INSERT 13-35, NORMAL KEYING, WITH 22 PIN-TYPE CONTACTS OF SIZE 22 AWG. MATES WITH D38999/26FC35SN FOR CONTROL INTERFACE.
- (C) KRFU RECEPTACLE A4J3 IS WR28 WAVEGUIDE, M3922/54-003. MATES WITH M3922/59-005 THROUGH HOLE FLANGE TYPE WR-28 WAVEGUIDE FLANGE PER MIL-DTL-3922/54 (UG599/U) [0.112-40 UNC-2B] FOR RF TX INTERFACE. REFER TO SDIM FOR SEMI-RIGID, FLEXIBLE WAVEGUIDE COMPONENTS AND RF PLUMBING DETAILS. RECOMMEND TO USE WR28 TO WR34 WAVEGUIDE TRANSITION ADAPTOR AT KRFU A4J3 END.
- (D) KRFU RECEPTACLE A4J4 IS WR42 WAVEGUIDE, M3922/54-001. MATES WITH M3922/59-003 THROUGH HOLE FLANGE TYPE WR42 WAVEGUIDE FLANGE PER MIL-DTL-3922/54 (UG595/U) [0.112-40 UNC-2B] FOR RF RX INTERFACE.
- (E) RECOMMENDED TO USE WR42 TO 2.92 MM WAVEGUIDE TO COAX ADAPTER AT KRFU A4J4 END.
- (F) KRFU RECEPTACLE A4J5 IS TNC FEMALE PER MIL C-87104/2. MATES WITH TNC MALE PER MIL-C-87104/2 FOR TX-IF INTERFACE (LABELED BLUE).
- (G) KRFU RECEPTACLE A4J6 IS TNC FEMALE PER MIL C-87104/2. MATES WITH TNC MALE PER MIL-C-87104/2 FOR RX-IF INTERFACE (LABELED GREEN).
- (H) STRAIN RELIEF HEAT SHRINK SLEEVING OF LENGTH 0.5\*±0.05\* SHOULD BE PROVIDED TO PREVENT STRESS CONCENTRATION AT COAX CABLE TERMINATIONS. RECOMMEND TO USE BLUE COLOR CABLE SHRINK FOR THE TX-IF COAX CABLE AND GREEN COLOR CABLE SHRINK FOR THE RX-IF COAX CABLE.
- (I) COAXIAL CABLE WITH FOLLOWING SPECIFICATIONS RECOMMENDED FOR RECEIVE PATH INTERCONNECTION BETWEEN BETWEEN KRFU A4J4 AND OAE-FMA A5J4
  - (i) THE FREQUENCY RANGE OF OPERATION : 19.2 GHz TO 21.2 GHz.
  - (ii) THE NOMINAL CHARACTERISTIC IMPEDANCE : 50 Ω.
- (J) THE TRANSMIT AND RECEIVE INTERCONNECT ASSEMBLIES BETWEEN KRFU AND OAE-FMA SHOULD HAVE VSWR BETTER THAN OR EQUAL TO 1.5:1 OVER FREQUENCY RANGE OF OPERATION.
- (K) THE TRANSMIT PATH INTERCONNECT LOSSES BETWEEN THE OAE-FMA AND KRFU SHOULD NOT EXCEED 1.5 dB.
- (L) THE RECEIVE PATH INTERCONNECT LOSSES BETWEEN THE OAE-FMA AND KRFU SHOULD NOT EXCEED 2.9 dB.
- (M) THE TRANSMITTER FREQUENCY RANGE OF OPERATION : 29 GHz TO 30 GHz.
- (N) KRFU POWER AND CONTROL CONNECTOR CONTACT ASSIGNMENTS SHOWN IN TABLES 6 AND 7 (SHEET 7).
- (O) KRFU BONDING TO THE AIRCRAFT SHOULD BE ACHIEVED THROUGH THE MOUNTING FASTENERS ON THE KRFU AND KRFU A4J1-C.

(CONTINUED SHEET 3)

Figure 4-36. (Sheet 2 of 8) JetWave™ System Interconnect Diagram - FMA (KRFU Outside Aircraft Fuselage), (90401047-1, REV F)

SYSTEM DESCRIPTION AND INSTALLATION MANUAL  
JetWave™ System

NOTES (CONTINUED FROM SHEET 2):

22. BULKHEAD INTERFACE

- (A) RECOMMENDED TO USE MIL-DTL-38999 SERIES III, INSERT 19-35, NORMAL KEYING WITH 66 CONTACTS AS KANDU BULKHEAD CONTROL CONNECTOR FOR KANDU INTERWIRING TO OAE-FMA. TO BE LABELED AS BI-CONTROL.
- (B) RECOMMENDED TO USE MIL-DTL-38999 SERIES III, INSERT 17-8, NORMAL KEYING WITH 8 CONTACTS AS KANDU BULKHEAD POWER CONNECTOR. TO BE LABELED AS BI-POWER.
- (C) RECOMMENDED TO USE TNC/N-TYPE HERMETICALLY SEALED BULKHEAD INTERFACE PER MIL-C-87104/2 FOR ROUTING TX-IF SIGNALS BETWEEN MODMAN AND KRFU. TX-IF INTERFACE TO BE LABELED BLUE.
- (D) RECOMMENDED TO USE TNC HERMETICALLY SEALED BULKHEAD INTERFACE PER MIL-C-87104/2 FOR ROUTING RX-IF SIGNALS BETWEEN MODMAN AND KRFU. RX-IF INTERFACE TO BE LABELED GREEN.
- (E) THE BULKHEAD INTERFACE DESIGN COULD BE EITHER JAM-NUT OR FLANGE IN CONSULTATION. IF FLANGE DESIGN CONNECTOR IS USED, IT SHOULD BE INSTALLED SUCH THAT THE FLANGE IS LOCATED ON THE PRESSURIZED AREA OF THE AIRCRAFT. IF JAM NUT CONNECTOR IS USED, JAM-NUT CONNECTOR SHOULD UTILIZE A LOCK WIRE.
- (F) BULKHEAD INTERFACE SHOULD BE INSTALLED SUCH THAT RECEPTACLE PINS ARE ON THE PRESSURIZED AREA AND RECEPTACLE SOCKETS ARE ON UNPRESSURIZED SIDE OF THE AIRCRAFT.
- (G) BULKHEAD INTERFACE CONNECTOR CONTACT ASSIGNMENTS SHOWN IN TABLES 8 AND 9 (SHEET 8).

23. OUTSIDE ANTENNA EQUIPMENT - FUSELAGE MOUNT ANTENNA (OAE-FMA)

OAE-FMA CONNECTORS A5P1, A5P2 AND A5P3 ARE PENDENT TYPE PLUGS.

- (A) OAE-FMA POWER CONNECTOR A5P1 IS MIL-DTL-38999 SERIES III, PLUG, INSERT 13-4/26FC4PN, 4 PIN-TYPE CONTACTS OF SIZE 16 AWG. MATES WITH MIL-DTL-38999/20FC4SN.
- (B) OAE-FMA CONTROL CONNECTOR A5P2 IS MIL-DTL-38999 SERIES III, PLUG, INSERT 11-35/26FB35PN, 13 PIN-TYPE CONTACTS OF SIZE 22 AWG. MATES WITH MIL-DTL-38999/20FB35SN.
- (C) OAE-FMA IMU CONNECTOR A5P3 IS MIL-DTL-38999 SERIES III, PLUG, INSERT 11-35/26FB35PA, 13 PIN-TYPE CONTACTS OF SIZE 22 AWG. MATES WITH MIL-DTL-38999/20FB35SA.
- (D) OAE-FMA RECEPTACLE OAE-FMA A5J5 IS WR34 WAVEGUIDE. REFER TO SDIM FOR WAVEGUIDE PLUMBING AND FLANGE DETAILS.
- (E) OAE-FMA RECEPTACLE OAE-FMA A5J4 IS 2.92 MM COAX FEMALE. MATES WITH 2.92 MM MALE CONNECTOR.
- (F) OAE-FMA POWER AND CONTROL CONNECTOR CONTACT ASSIGNMENTS SHOWN IN TABLES 10, 11 AND 12 (SHEET 8).
- (G) OVERBRAID MAY BE CONNECTED VIA CONNECTOR SHIELD / HOUSING OR DIRECTLY TO HOUSING.
- (H) RESISTANCE FROM FMA BASE MOUNTING RING BONDING MEASUREMENT POINT TO ADAPTOR PLATE GROUNDING POINT SHOULD NOT EXCEED 2.5 mΩ.

24. THE OAE-FMA SHOULD BE BONDED TO THE ADAPTOR PLATE BY MEANS OF MOUNTING STRUCTURE (FASTENERS) AND/OR ADDITIONAL BONDING STRAPS.

25. THE BULKHEAD BACK PLATE, MOUNTING FASTENERS AND SEALANT SHOULD BE AS PER AIRFRAME MANUFACTURER'S REQUIREMENTS.

26. WIRING HARNESS OUTSIDE AIRCRAFT FUSELAGE

- (A) THE INTERCONNECT WIRING OUTSIDE AIRCRAFT FUSELAGE BETWEEN BULKHEAD POWER, BULKHEAD CONTROL RECEPTACLES, OAE-FMA POWER, OAE-FMA CONTROL, OAE-FMA IMU/TAIL SWITCH CONNECTORS AND KRFU IS MULTI-OCTOPUS.
- (B) WIRING HARNESS AND WAVEGUIDE BETWEEN BULKHEAD INTERFACE, OAE-FMA AND KRFU SHOULD BE SECURED TO THE ANTENNA MOUNT.
- (C) RECOMMENDED TO INTERFACE CONNECTOR PLUGS FOR OAE-FMA POWER, OAE-FMA CONTROL AND OAE-IMU/TAIL SWITCH CONNECTOR WITH SOCKET TYPE WIRING HARNESS RECEPTACLES WALL MOUNTED ON AN L-BRACKET FIRMLY FITTED ON THE ADAPTOR PLATE.
- (D) RECOMMENDED TO PROVIDE CONSIDERATION FOR MOISTURE CONTROL IN RF INTERCONNECT, IF NEED BE FOR SPECIFIC AIRCRAFT CONFIGURATION FOR WAVEGUIDE INTERCONNECT BETWEEN KRFU AND OAE-FMA. REFER TO SDIM FOR DETAILS.
- (E) WIRING OF TAIL SECTOR MUTE SWITCH IS OPTIONAL. INSTALLER MAY FINALIZE TAIL SECTOR MUTE SWITCH WIRING IN CONSULTATION WITH THE AIR FRAME MANUFACTURER BASED ON THE SAFETY ASSESSMENT OF SUSCEPTIBILITY OF EQUIPMENT IN THE TAIL TO RF RADIATION IN THE 29-30 GHZ RANGE.

27. RECOMMENDED TO PROVIDE WIRE ROUTE SEGREGATION BETWEEN RF, POWER, AND CONTROL SIGNALS WHILE WIRING OUTSIDE AIRCRAFT.

28. IT IS RECOMMENDED NOT TO USE 'NOT CONNECTED' PINS IDENTIFIED IN THE INTERCONNECTION DIAGRAM FOR ANY OTHER PURPOSE. HONEYWELL TO BE CONSULTED FOR ANY SUCH REQUIREMENTS.

29. RECOMMEND TO PROVISION OVERBRAIDING FOR THE WIRE ROUTING OUTSIDE THE AIRCRAFT.

ID-621896 E90401047-3-F

**Figure 4-36. (Sheet 3 of 8) JetWave™ System Interconnect Diagram - FMA (KRFU Outside Aircraft Fuselage), (90401047-1, REV F)**



## SYSTEM DESCRIPTION AND INSTALLATION MANUAL JetWave™ System

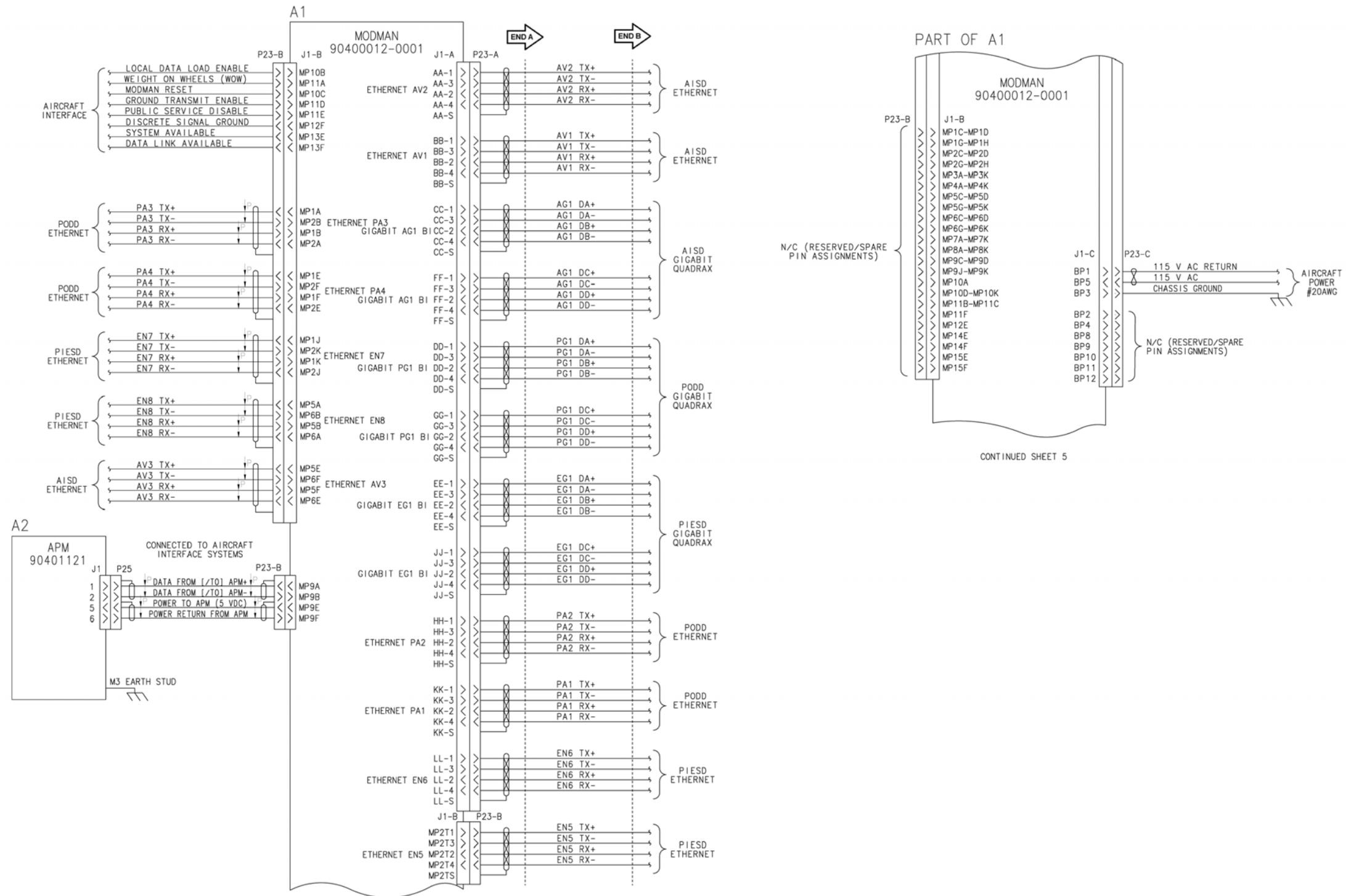


Figure 4-36. (Sheet 4 of 8) JetWave™ System Interconnect Diagram - FMA (KRFU Outside Aircraft Fuselage), (90401047-1, REV F)

## SYSTEM DESCRIPTION AND INSTALLATION MANUAL JetWave™ System

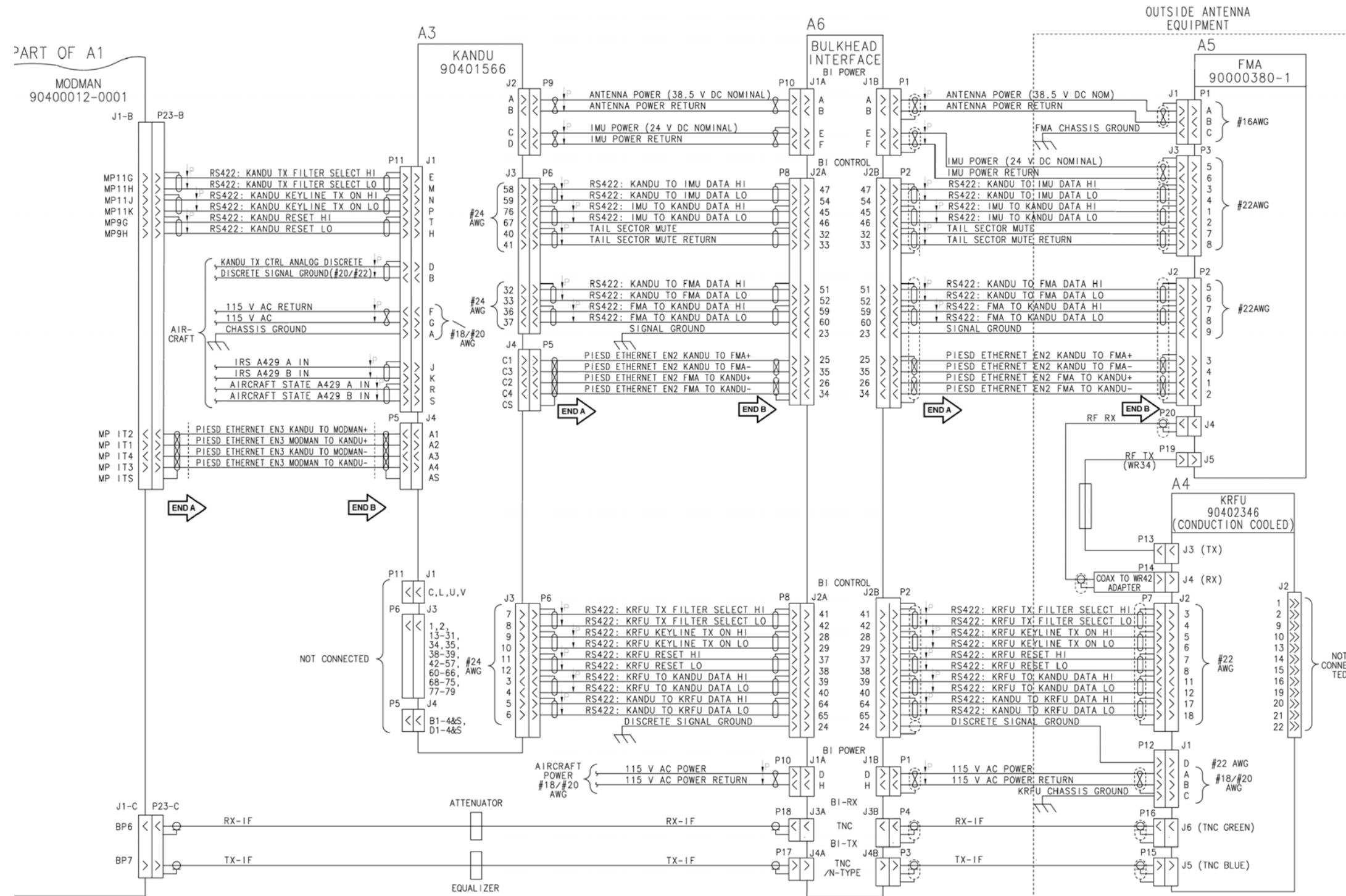


Figure 4-36. (Sheet 5 of 8) JetWave™ System Interconnect Diagram - FMA (KRFU Outside Aircraft Fuselage), (90401047-1, REV F)

SYSTEM DESCRIPTION AND INSTALLATION MANUAL  
JetWave™ System

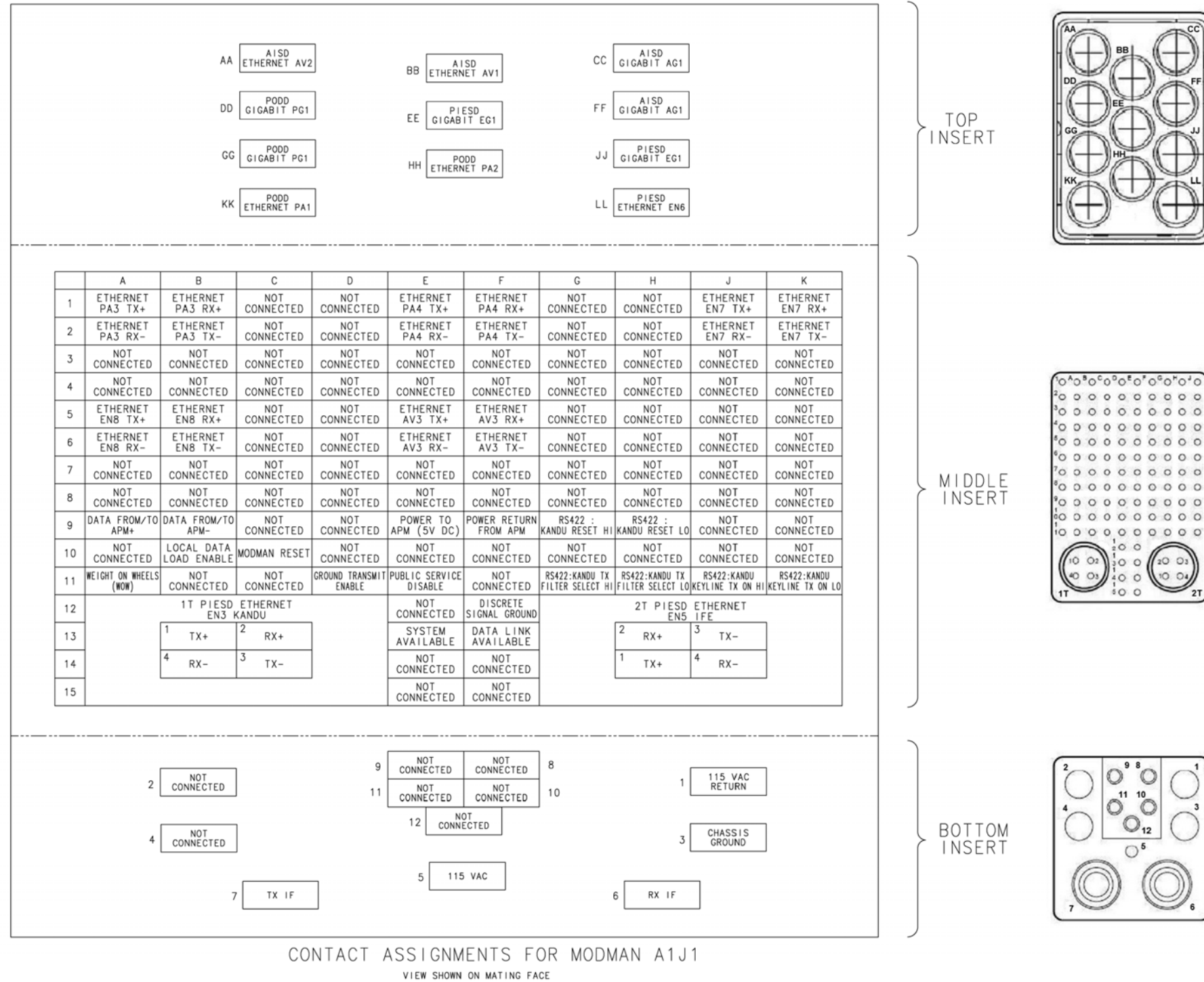
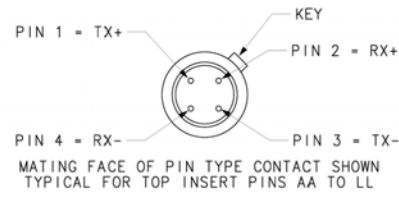


Figure 4-36. (Sheet 6 of 8) JetWave™ System Interconnect Diagram - FMA (KRFU Outside Aircraft Fuselage), (90401047-1, REV F)

## SYSTEM DESCRIPTION AND INSTALLATION MANUAL JetWave™ System

TABLE 1 : APM A2J1 CONNECTOR PIN ASSIGNMENTS

PIN NUMBER	SIGNAL NAME
1	DATA FROM [/TO] APM +
2	DATA FROM [/TO] APM -
3	NOT CONNECTED
4	NOT CONNECTED
5	POWER TO APM (5 V DC)
6	POWER RETURN FROM APM
7-13	NOT CONNECTED



TABLE 2: KANDU A3J1 CONNECTOR PIN ASSIGNMENTS

PIN NO	PIN DESIGNATION
A	CHASSIS GROUND
B	DISCRETE SIGNAL GROUND
C	NOT CONNECTED
D	KANDU TX CONTROL ANALOG DISCRETE
E	RS422: KANDU TX FILTER SELECT HI
F	115 V AC RETURN
G	115 V AC
H	RS422: KANDU RESET LO
J	IRS A429 A IN
K	IRS A429 B IN
L	NOT CONNECTED
M	RS422: KANDU TX FILTER SELECT LO
N	RS422: KANDU KEYLINE TX ON HI
P	RS422: KANDU KEYLINE TX ON LO
R	AIRCRAFT STATE A429 A IN
S	AIRCRAFT STATE A429 B IN
T	RS422: KANDU RESET HI
U	NOT CONNECTED
V	NOT CONNECTED

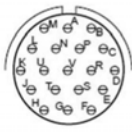
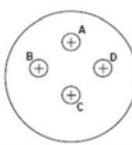


TABLE 3: KANDU A3J2 CONNECTOR PIN ASSIGNMENTS

PIN NO	PIN DESIGNATION
A	ANTENNA POWER (38.5 V DC NOMINAL)
B	ANTENNA POWER RETURN
C	IMU POWER (24 V DC NOMINAL)
D	IMU POWER RETURN



CONTACT LEGEND, EXCEPT KANDU J4 (QUADRAX INTERFACE) AND MODMAN (ARINC 600 CONTACTS)



TABLE 4 : KANDU A3J3 CONNECTOR PIN ASSIGNMENTS

PIN NO	PIN DESIGNATION	PIN NO	PIN DESIGNATION
1	NOT CONNECTED	41	TAIL SECTOR MUTE RETURN
2	NOT CONNECTED	42	NOT CONNECTED
3	RS422: KRFU TO KANDU DATA HI	43	NOT CONNECTED
4	RS422: KRFU TO KANDU DATA LO	44	NOT CONNECTED
5	RS422: KANDU TO KRFU DATA HI	45	NOT CONNECTED
6	RS422: KANDU TO KRFU DATA LO	46	NOT CONNECTED
7	RS422: KRFU TX FILTER SELECT HI	47	NOT CONNECTED
8	RS422: KRFU TX FILTER SELECT LO	48	NOT CONNECTED
9	RS422: KRFU KEYLINE TX ON HI	49	NOT CONNECTED
10	RS422: KRFU KEYLINE TX ON LO	50	NOT CONNECTED
11	RS422: KRFU RESET HI	51	NOT CONNECTED
12	RS422: KRFU RESET LO	52	NOT CONNECTED
13	NOT CONNECTED	53	NOT CONNECTED
14	NOT CONNECTED	54	NOT CONNECTED
15	NOT CONNECTED	55	NOT CONNECTED
16	NOT CONNECTED	56	NOT CONNECTED
17	NOT CONNECTED	57	NOT CONNECTED
18	NOT CONNECTED	58	RS422: KANDU TO IMU DATA HI
19	NOT CONNECTED	59	RS422: KANDU TO IMU DATA LO
20	NOT CONNECTED	60	NOT CONNECTED
21	NOT CONNECTED	61	NOT CONNECTED
22	NOT CONNECTED	62	NOT CONNECTED
23	NOT CONNECTED	63	NOT CONNECTED
24	NOT CONNECTED	64	NOT CONNECTED
25	NOT CONNECTED	65	NOT CONNECTED
26	NOT CONNECTED	66	NOT CONNECTED
27	NOT CONNECTED	67	RS422: IMU TO KANDU DATA LO
28	NOT CONNECTED	68	NOT CONNECTED
29	NOT CONNECTED	69	NOT CONNECTED
30	NOT CONNECTED	70	NOT CONNECTED
31	NOT CONNECTED	71	NOT CONNECTED
32	RS422: KANDU TO FMA DATA HI	72	NOT CONNECTED
33	RS422: KANDU TO FMA DATA LO	73	NOT CONNECTED
34	NOT CONNECTED	74	NOT CONNECTED
35	NOT CONNECTED	75	NOT CONNECTED
36	RS422: FMA TO KANDU DATA HI	76	RS422: IMU TO KANDU DATA HI
37	RS422: FMA TO KANDU DATA LO	77	NOT CONNECTED
38	NOT CONNECTED	78	NOT CONNECTED
39	NOT CONNECTED	79	NOT CONNECTED
40	TAIL SECTOR MUTE		

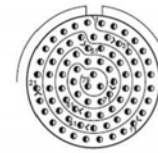


TABLE 6 : KRFU A4J1 CONNECTOR PIN ASSIGNMENTS

PIN NO	PIN DESIGNATION
A	115 V AC POWER
B	115 V AC POWER RETURN
C	CHASSIS GROUND
D	DISCRETE SIGNAL GROUND

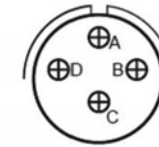


TABLE 7 : KRFU A4J2 CONNECTOR PIN ASSIGNMENTS

PIN NO	PIN DESIGNATION
1	NOT CONNECTED
2	NOT CONNECTED
3	RS422 : KRFU TX FILTER SELECT HI
4	RS422 : KRFU TX FILTER SELECT LO
5	RS422 : KRFU KEYLINE TX ON HI
6	RS422 : KRFU KEYLINE TX ON LO
7	RS422 : KRFU RESET HI
8	RS422 : KRFU RESET LO
9	NOT CONNECTED
10	NOT CONNECTED
11	RS422 : KRFU TO KANDU DATA HI
12	RS422 : KRFU TO KANDU DATA LO
13	NOT CONNECTED
14	NOT CONNECTED
15	NOT CONNECTED
16	NOT CONNECTED
17	RS422 : KANDU TO KRFU DATA HI
18	RS422 : KANDU TO KRFU DATA LO
19	NOT CONNECTED
20	NOT CONNECTED
21	NOT CONNECTED
22	NOT CONNECTED

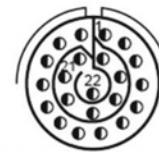


TABLE 5 : KANDU A3J4 CONNECTOR PIN ASSIGNMENTS

PIN NO	PIN DESIGNATION
A-1	PIESD ETHERNET EN3 KANDU TO MODMAN+
A-3	PIESD ETHERNET EN3 KANDU TO MODMAN-
A-2	PIESD ETHERNET EN3 MODMAN TO KANDU+
A-4	PIESD ETHERNET EN3 MODMAN TO KANDU-
A-S	PIESD ETHERNET EN3 SHIELD
B-1	NOT CONNECTED
B-3	NOT CONNECTED
B-2	NOT CONNECTED
B-4	NOT CONNECTED
B-S	NOT CONNECTED
C-1	PIESD ETHERNET EN2 KANDU TO FMA+
C-3	PIESD ETHERNET EN2 KANDU TO FMA-
C-2	PIESD ETHERNET EN2 FMA TO KANDU+
C-4	PIESD ETHERNET EN2 FMA TO KANDU-
C-S	PIESD ETHERNET EN2 SHIELD
D-1	NOT CONNECTED
D-3	NOT CONNECTED
D-2	NOT CONNECTED
D-4	NOT CONNECTED
D-S	NOT CONNECTED

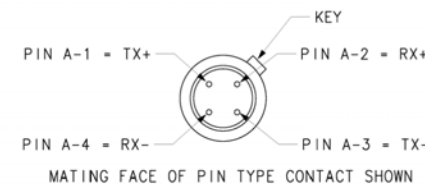
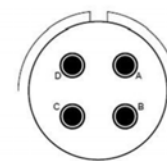


Figure 4-36. (Sheet 7 of 8) JetWave™ System Interconnect Diagram - FMA (KRFU Outside Aircraft Fuselage), (90401047-1, REV F)