



## Compliance Testing, LLC

Previously Flom Test Lab

RF, EMC and Safety Testing Experts Since 1963

toll-free: (866) 311-3268

fax: (480) 926-3598

<http://www.ComplianceTesting.com>

[info@ComplianceTesting.com](mailto:info@ComplianceTesting.com)

**Date:** April 7, 2010

**Applicant:** EMS Technologies Canada, Ltd  
400 Maple Grove Rd  
Ottawa, ON K2V 1B8  
Canada

**Attention of:** Ron Halka - Director, Business Process Improvement & Quality  
Ph: (613) 591-9064 Ext. 3244  
Fax: (613) 591-9107  
E-mail: [halka.r@emsaviation.com](mailto:halka.r@emsaviation.com)

**Equipment:** HSD-X  
**FCC ID:** K6KHSD-X  
**FCC Rules:** Part 87

Gentlemen:

Enclosed please find your copy of the Engineering Test Report for which you are subject to the restrictions as listed on the attached summary.

Once a Telecommunication Certification Body (TCB) issues a Grant the Federal Communication Commission (FCC) has 30 days to review the application and request added information. It is your decision whether or not to market the equipment subject to a possible recall before the end of the 30 days.

If your equipment is still retained by us, it will be returned to you 30 days after approval is achieved. Our invoice for services has been directed to your Accounts Payable Department.

For any additional information please contact us.

Thank you.

Sincerely yours,

John Erhard: Engineering Manager



## Summary of Restrictions

1. All submissions to the FCC are subject to **their** Examiner's interpretation.
2. Please allow from 60 to 90 days before hearing from the FCC with regard to any submission.
3. The FCC can set aside any action or modify any action, within 30 days. (FCC Rule 1.108, 1.113).
4. Under Rule 2.803, if device is not type accepted/certificated then it must **not** be sold, leased, offered for sale, imported, shipped or distributed or advertised for sale.
5. FCC can revoke its certificates at any time if the equipment does not meet or **continue** to meet their Rules. (Rule Parts 2.927, 2.939).
6. FCC can request a sample at any time (2.936).



**Compliance Testing, LLC**  
Previously Flom Test Lab  
*RF, EMC and Safety Testing Experts Since 1963*

toll-free: (866) 311-3268

fax: (480) 926-3598

<http://www.ComplianceTesting.com>  
[info@ComplianceTesting.com](mailto:info@ComplianceTesting.com)

**Date:** April 7, 2010

Federal Communications Commission  
Via: Electronic Filing

**Attention:** Authorization & Evaluation Division

**Applicant:** EMS Technologies Canada, Ltd  
**Equipment:** HSD-X  
**FCC ID:** K6KHSD-X  
**FCC Rules:** Part 87

Dear Gentleman:

On behalf of the Applicant, enclosed please find Application Form 731, Engineering Test Report and all pertinent documentation, the whole for approval of the referenced equipment as shown.

We trust the same is in order. Should you need any further information, kindly contact the writer who is authorized to act as agent.

Best regards,

John Erhard: Engineering Manager



**Compliance Testing, LLC**  
Previously Flom Test Lab  
*RF, EMC and Safety Testing Experts Since 1963*

toll-free: (866) 311-3268

fax: (480) 926-3598

<http://www.ComplianceTesting.com>  
[info@ComplianceTesting.com](mailto:info@ComplianceTesting.com)

## Test Report

for

**FCC ID: K6KHSD-X**

**Model: HSD-X**

to

**Federal Communications Commission**

Rule Part(s) 87

Date of report: April 7, 2010

**On the Behalf of the Applicant:** EMS Technologies Canada, Ltd

**At the Request of:** EMS Technologies Canada, Ltd  
400 Maple Grove Rd  
Ottawa, ON K2V 1B8  
Canada

**Attention of:** Ron Halka - Director, Business Process Improvement & Quality  
Ph: (613) 591-9064 Ext. 3244  
Fax: (613) 591-9107  
E-mail: [halka.r@emsaviation.com](mailto:halka.r@emsaviation.com)

Reviewed by:

John Erhard: Engineering Manager



### Test Report Revision History

Revision	Date	Revised By	Reason for revision
1.0	April 7, 2010	J. Erhard	Original Document

## List of Exhibits

(FCC **Certification** (Transmitters) - Revised 9/28/98)**Applicant:** EMS Technologies Canada, Ltd**FCC ID:** K6KHSD-X**By Applicant:**

1. Letter of Authorization
2. Confidentiality Request: 0.457 And 0.459
3. Identification Drawings, 2.1033(c)(11)
  - Label
  - Location of Label
  - Compliance Statement
  - Location of Compliance Statement
4. Photographs, 2.1033(c)(12)
5. Documentation: 2.1033(c)
  - (3) User Manual
  - (9) Tune Up Info
  - (10) Schematic Diagram
  - (10) Circuit Description
  - Block Diagram
  - Parts List
  - Active Devices

**By Compliance Testing:**

- A. Testimonial & Statement of Certification



**The Applicant has been cautioned as to the following:**

15.21 **Information to the User.**

The user's manual or instruction manual for an intentional radiator shall caution the user that changes or modifications not expressly approved by the party responsible for compliance could void the user's authority to operate the equipment.

15.27(a) **Special Accessories.**

Equipment marketed to a consumer must be capable of complying with the necessary regulations in the configuration in which the equipment is marketed. Where special accessories, such as shielded cables and/or special connectors are required to enable an unintentional or intentional radiator to comply with the emission limits in this part, the equipment must be marketed with, i.e. shipped and sold with, those special accessories. However, in lieu of shipping or packaging the special accessories with the unintentional or intentional radiator, the responsible party may employ other methods of ensuring that the special accessories are provided to the consumer, without additional charge.

Information detailing any alternative method used to supply the special accessories for a grant of equipment authorization or retained in the verification records, as appropriate. The party responsible for the equipment, as detailed in § 2.879 of this chapter, shall ensure that these special accessories are provided with the equipment. The instruction manual for such devices shall include appropriate instructions on the first page of text concerned with the installation of the device that these special accessories must be used with the device. It is the responsibility of the user to use the needed special accessories supplied with the equipment.



## Testimonial and Statement of Certification

**This is to Certify:**

1. **That** the application was prepared either by, or under the direct supervision of, the undersigned.
2. **That** the technical data supplied with the application was taken under my direction and supervision.
3. **That** the data was obtained on representative units, randomly selected.
4. **That**, to the best of my knowledge and belief, the facts set forth in the application and accompanying technical data is true and correct.

A handwritten signature in black ink that reads "John Erhard".

John Erhard: Engineering Manager

Certifying Engineer:





## Table of Contents

<u>Rule</u>	<u>Description</u>	<u>Page</u>
	Test Report	2
2.1033(c)(14)	Rule Summary	3
	Standard Test Conditions and Engineering Practices	4
2.1033(c)	General Information Required	5
	Test Results Summary	7
2.1046, 87.131	Carrier Output Power (Conducted)	8
2.1051, 87.139(i)(1)	Conducted Spurious Emissions	9
2.1053,	Field Strength of Spurious Radiation	23
2.1049, 87.139(i)(3)	Emission Masks (Occupied Bandwidth)	27
2.1055, 87.133(a)	Frequency Stability (Temperature Variation)	37
2.1055, 87.133(a)	Frequency Stability (Voltage Variation)	38
2.202(g)	Necessary Bandwidth and Emission Bandwidth	39
	Test Equipment Utilized	40
	Appendix	41



Required information per ISO 17025-2005, paragraph 5.10.2:

a) **Test Report**

b) Laboratory: Compliance Testing  
(FCC: 933597) 3356 N. San Marcos Place, Suite 107  
(Canada: IC 2044-A) Chandler, AZ 85225

c) Report Number: d1040006

d) Client: EMS Technologies Canada, Ltd  
400 Maple Grove Rd  
Ottawa, ON K2V 1B8  
Canada

e) Identification: FCC ID: K6KHSD-X  
Model: HSD-X

EUT Description: eNfusion HSD-X Aeronautical Satcom Terminal

f) EUT Condition: Not required unless specified in individual tests.

g) Report Date: April 7, 2010

h, j, k): As indicated in individual tests.

i) Sampling method: No sampling procedure used.

l) Measurement Uncertainty: In accordance with Compliance Testing internal quality manual.

m) Reviewed by:

John Erhard: Engineering Manager

n) Results: The results presented in this report relate only to the item tested.

o) Reproduction: This report must not be reproduced, except in full, without written permission from this laboratory.

Accessories used during testing:

Type	Quantity	Manufacturer	Model	Serial No.	FCC ID
None	None	None	None	None	None



Sub-part

2.1033(c)(14):

## Test and Measurement Data

All tests and measurement data shown were performed in accordance with FCC Rules and Regulations, Volume II; Part 2, Sub-part J, Sections 2.947, 2.1033(c), 2.1041, 2.1046, 2.1047, 2.1051, 2.1053, 2.1055, 2.1057 and the following individual Parts: 87.



## Standard Test Conditions and Engineering Practices

Except as noted herein, the following conditions and procedures were observed during the testing:

In accordance with ANSI/C63.4-2009, and unless otherwise indicated in the specific measurement results, the ambient temperature of the actual EUT was maintained within the range of 10° to 40°C (50° to 104 °F) unless the particular equipment requirements specify testing over a different temperature range. Also, unless otherwise indicated, the humidity levels were in the range of 10% to 87% relative humidity.

Measurement results, unless otherwise noted, are worst-case measurements.

### A2LA

“A2LA has accredited Compliance Testing in Chandler, AZ for technical competence in the field of Electrical testing. The accreditation covers the specific tests and types of tests listed on the agreed scope of accreditation. This laboratory meets the requirements of ISO 17025:2005 ‘General Requirements for the Competence of Testing and Calibration Laboratories’ and any additional program requirements in the identified field of testing.”

Please refer to [www.a2la.org](http://www.a2la.org) for current scope of accreditation.

Certificate number: 2152.01



TESTING CERT# 2152.01

**FCC OATS Reg. #933597**

**IC Reg. # 2044A-1**



### List of General Information Required for Certification

In Accordance with FCC Rules and Regulations,  
Volume II, Part 2 and to Part 87

Sub-part 2.1033 (c)(1):

**Name and Address of Applicant:** EMS Technologies Canada, Ltd  
400 Maple Grove Rd  
Ottawa, ON K2V 1B8  
Canada

**Manufacturer:** EMS Technologies Canada, Ltd  
400 Maple Grove Rd  
Ottawa, ON K2V 1B8  
Canada

(c)(2): **FCC ID:** K6KHSD-X

**Model Number:** HSD-X

(c)(3): **Instruction Manual(s):**

Please see attached exhibits

(c)(4): **Type of Emission:** BPSK, QPSK, QAM

(c)(5): **Frequency Range, MHz:** 1626.5 – 1660.5

(c)(6): **Power Rating, Watts:** 0.2  
\_\_\_\_\_ Switchable                        X   Variable                      \_\_\_\_\_ N/A

**FCC Grant Note:** None

(c)(7): **Maximum Allowable Power, Watts:** 60 W

**DUT Results:** Passes   X   Fails \_\_\_\_\_



Subpart 2.1033 (continued)

(c)(8): Voltages & currents in all elements in final RF stage, including final transistor or solid-state device:

Collector Current, A =	60 mA
Collector Voltage, Vdc =	3.8
Supply Voltage, Vdc =	3.8

(c)(9): **Tune-Up Procedure:**

Please see attached exhibits

(c)(10): **Circuit Diagram/Circuit Description:**

Including description of circuitry & devices provided for determining and stabilizing frequency, for suppression of spurious radiation, for limiting modulation and limiting power.

Please see attached exhibits

(c)(11): **Label Information:**

Please see attached exhibits

(c)(12): **Photographs:**

Please see attached exhibits

(c)(13): **Digital Modulation Description:**

Attached Exhibits  
 N/A

(c)(14): **Test and Measurement Data:**

Follows



## Test Results Summary

Specification	Test Name	Pass, Fail, N/A	Comments
2.1046, 87.131	Carrier Output Power (Conducted)	Pass	
2.1051, 87.139(i)(1)	Unwanted Emissions (Transmitter Conducted)	Pass	
2.1053	Field Strength of Spurious Radiation	Pass	
2.1049, 87.139(i)(3)	Emission Masks (Occupied Bandwidth)	Pass	See FCC waiver for allowable variance
2.1047	Audio Low Pass Filter (Voice Input)	N/A	The EUT does not contain an audio input
2.1047	Audio Frequency Response	N/A	The EUT does not contain an audio input
2.1047	Modulation Limiting	N/A	The EUT does not contain an audio input
2.1055, 87.133(a)	Frequency Stability (Temperature Variation)	Pass	
2.1055, 87.133(a)	Frequency Stability (Voltage Variation)	Pass	



Name of Test: Carrier Output Power (Conducted)  
Specification: 2.1046, 87.131  
Test Equipment Utilized: 0668, 04806, i00331

Engineer: J. Erhard  
Test Date: 4/5/2010

**Measurement Procedure**

The Equipment Under Test (EUT) was connected directly to a spectrum analyzer with the RBW set to 1 MHz and the VBW set to 3 X RBW which set the RBW greater than the transmit signal ensuring there was no signal suppression while measuring a modulated signal. The peak readings were taken for each modulation type and the result was then compared to the limit.

**Test Setup**

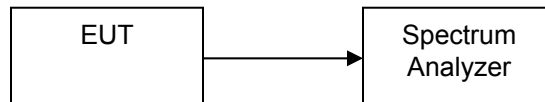

**BPSK Transmitter Peak Output Power**

Tuned Frequency MHz	Measured Power dBm	Measured Power W	Limit W	Result
1626.5	20.13	0.103	60	Pass
1643.5	19.95	0.099	60	Pass
1660.5	20.41	0.110	60	Pass

**QPSK Transmitter Peak Output Power**

Tuned Frequency MHz	Measured Power dBm	Measured Power W	Limit W	Result
1626.5	22.36	0.172	60	Pass
1643.5	22.36	0.172	60	Pass
1660.5	22.36	0.172	60	Pass

**QAM Transmitter Peak Output Power**

Tuned Frequency MHz	Measured Power dBm	Measured Power W	Limit W	Result
1626.5	23.01	0.200	60	Pass
1643.5	22.74	0.188	60	Pass
1660.5	22.48	0.175	60	Pass



**Name of Test:** Conducted Spurious Emissions  
**Specification:** 2.1051, 87.139(i)(1)  
**Test Equipment Utilized:** 0668, 04806, i00331

**Engineer:** J. Erhard  
**Test Date:** 4/6/2010

### Test Procedure

The EUT was connected directly to a spectrum analyzer to verify that the UUT met the requirements for spurious emissions. The RBW was set according to the requirements of 87139 (i)(1). The power was corrected for the measurement RBW bandwidth. The dBc limit, the DLNA and HPA rejection, and corrected power were summed together to determine the necessary dBm value of the EUT to provide a system rejection greater than the FCC limit. This necessary value was compared to the measured value to ensure compliance to the specification, which is expressed as the margin. A negative value indicates a passing result.

### Test Setup

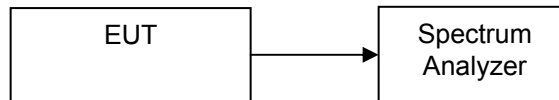

### BPSK 1626.5 MHz Conducted Spurious Emissions

Freq (MHz)	Limit (dBc)	RBW (MHz)	F Type DLNA with HPA-128 HPA Rejection (dB)	Measured Power (dBm)	Corrected Power (dBm)	Necessary Level (dBm)	Measured Level (dBm)	Margin (dB)
.010 to 700	-135	0.004	110	20.01	21.26	-3.74	-71.19	-67.45
700 to 1525	-135	0.004	83.3	20.01	21.26	-30.44	-69.52	-39.08
1525 to 1559	-203	0.004	122.2	20.01	21.26	-59.54	-74.5	-14.96
1559 to 1585	-155	1	112.3	20.13	20.13	-22.57	-51.36	-28.79
1585 to 1605	-143	1	95.7	20.13	20.13	-27.17	-49.06	-21.89
1605 to 1610	-117	1	62.5	20.13	20.13	-34.37	-47.8	-13.43
1610 to 1610.6	-95	1	40.5	20.13	20.13	-34.37	-46.58	-12.21
1610.6 to 1613.8	-49	1	40.4	20.13	20.13	11.53	-46.26	-57.79
1613.8 to 1614	-95	1	40.4	20.13	20.13	-34.47	-45.6	-11.13
1614 to 1620	-70	0.004	30.2	20.01	21.26	-18.54	-58.73	-40.19
1620 to 1624.5	-70	0.004	20.1	20.01	21.26	-28.64	-57.37	-28.73
1624.5 to 1625.5	-70	0.004	10	20.01	21.26	-38.74	-57.92	-19.18
1625.5 to 1626.5	-70	0.004	1.3	20.01	21.26	-47.44	-57.18	-9.74
1626.5 to 1660	-70	0.004	0.8	20.01	21.26	-47.94	-57.7	-9.76
1660 to 1670	-19.5	0.02	0.8	20.13	18.37	-0.33	-62.93	-62.60
1670 to 1735	-60	0.004	1.6	20.01	21.26	-37.14	-72.13	-34.99
1735 to 1865	-105	0.004	56	20.01	21.26	-27.74	-57.77	-30.03
1865 to 2260.5	-105	0.004	36.6	20.01	21.26	-47.14	-76.13	-28.99
2260.5 to 3250	-105	0.004	80	20.01	21.26	-3.74	-73.45	-69.71
3250 to 3330	-105	0.004	110	20.01	21.26	26.26	-12.09	-38.35
3330 to 4000	-105	0.004	100	20.01	21.26	16.26	-75.4	-91.66
4000 to 12000	-105	0.004	110	20.01	21.26	26.26	-25.16	-51.42
12000 to 18000	-70	0.004	75	20.01	21.26	26.26	-71.23	-97.49

**BPSK 1643.5 MHz Conducted Spurious Emissions**

Freq (MHz)	Limit (dBc)	RBW (MHz)	F Type DLNA with HPA-128 HPA Rejection (dB)	Measured Power (dBm)	Corrected Power (dBm)	Necessary Level (dBm)	Measured Level (dBm)	Margin (dB)
.010 to 700	-135	0.004	110	19.83	21.08	-3.92	-69.03	-65.11
700 to 1525	-135	0.004	83.3	19.83	21.08	-30.62	-70.55	-39.93
1525 to 1559	-203	0.004	122.2	19.83	21.08	-59.72	-71.38	-11.66
1559 to 1585	-155	1	112.3	19.95	19.95	-22.75	-51.03	-28.28
1585 to 1605	-143	1	95.7	19.95	19.95	-27.35	-49.24	-21.89
1605 to 1610	-117	1	62.5	19.95	19.95	-34.55	-46.85	-12.30
1610 to 1610.6	-95	1	40.5	19.95	19.95	-34.55	-47.49	-12.94
1610.6 to 1613.8	-49	1	40.4	19.95	19.95	11.35	-46.27	-57.62
1613.8 to 1614	-95	1	40.4	19.95	19.95	-34.65	-46.37	-11.72
1614 to 1620	-70	0.004	30.2	19.83	21.08	-18.72	-68.2	-49.48
1620 to 1624.5	-70	0.004	20.1	19.83	21.08	-28.82	-64.52	-35.70
1624.5 to 1625.5	-70	0.004	10	19.83	21.08	-38.92	-61.15	-22.23
1625.5 to 1626.5	-70	0.004	1.3	19.83	21.08	-47.62	-72.2	-24.58
1626.5 to 1660	-70	0.004	0.8	19.83	21.08	-48.12	-56.71	-8.59
1660 to 1670	-19.5	0.02	0.8	19.84	18.08	-0.62	-62.35	-61.73
1670 to 1735	-60	0.004	1.6	19.83	21.08	-37.32	-70.56	-33.24
1735 to 1865	-105	0.004	56	19.83	21.08	-27.92	-62.03	-34.11
1865 to 2260.5	-105	0.004	36.6	19.83	21.08	-47.32	-75.9	-28.58
2260.5 to 3250	-105	0.004	80	19.83	21.08	-3.92	-73.32	-69.40
3250 to 3330	-105	0.004	110	19.83	21.08	26.08	-26.61	-52.69
3330 to 4000	-105	0.004	100	19.83	21.08	16.08	-75.06	-91.14
4000 to 12000	-105	0.004	110	19.83	21.08	26.08	-41.11	-67.19
12000 to 18000	-70	0.004	75	19.83	21.08	26.08	-70.9	-96.98

**BPSK 1660.5 MHz Conducted Spurious Emissions**

Freq (MHz)	Limit (dBc)	RBW (MHz)	F Type DLNA with HPA-128 HPA Rejection (dB)	Measured Power (dBm)	Corrected Power (dBm)	Necessary Level (dBm)	Measured Level (dBm)	Margin (dB)
.010 to 700	-135	0.004	110	19.4	20.65	-4.35	-70.78	-66.43
700 to 1525	-135	0.004	83.3	19.4	20.65	-31.05	-70.06	-39.01
1525 to 1559	-203	0.004	122.2	19.4	20.65	-60.15	-72.48	-12.33
1559 to 1585	-155	1	112.3	20.41	20.41	-22.29	-51.44	-29.15
1585 to 1605	-143	1	95.7	20.41	20.41	-26.89	-48.8	-21.91
1605 to 1610	-117	1	62.5	20.41	20.41	-34.09	-45.59	-11.50
1610 to 1610.6	-95	1	40.5	20.41	20.41	-34.09	-45.11	-11.02
1610.6 to 1613.8	-49	1	40.4	20.41	20.41	11.81	-45.54	-57.35
1613.8 to 1614	-95	1	40.4	20.41	20.41	-34.19	-45.14	-10.95
1614 to 1620	-70	0.004	30.2	19.4	20.65	-19.15	-60.37	-41.22
1620 to 1624.5	-70	0.004	20.1	19.4	20.65	-29.25	-60.32	-31.07
1624.5 to 1625.5	-70	0.004	10	19.4	20.65	-39.35	-59.71	-20.36
1625.5 to 1626.5	-70	0.004	1.3	19.4	20.65	-48.05	-62.86	-14.81
1626.5 to 1660	-70	0.004	0.8	19.4	20.65	-48.55	-55.1	-6.55
1660 to 1670	-19.5	0.02	0.8	19.49	17.73	-0.97	-44.36	-43.39
1670 to 1735	-60	0.004	1.6	19.4	20.65	-37.75	-61.57	-23.82
1735 to 1865	-105	0.004	56	19.4	20.65	-28.35	-66.77	-38.42
1865 to 2260.5	-105	0.004	36.6	19.4	20.65	-47.75	-76.2	-28.45
2260.5 to 3250	-105	0.004	80	19.4	20.65	-4.35	-73.82	-69.47
3250 to 3330	-105	0.004	110	19.4	20.65	25.65	-33.53	-59.18
3330 to 4000	-105	0.004	100	19.4	20.65	15.65	-75.61	-91.26
4000 to 12000	-105	0.004	110	19.4	20.65	25.65	-53.67	-79.32
12000 to 18000	-70	0.004	75	19.4	20.65	25.65	-71.32	-96.97



## QPSK 1626.5 MHz Conducted Spurious Emissions

Freq (MHz)	Limit (dBc)	RBW (MHz)	F Type DLNA with HPA-128 HPA Rejection (dB)	Measured Power (dBm)	Corrected Power (dBm)	Necessary Level (dBm)	Measured Level (dBm)	Margin (dB)
.010 to 700	-135	0.004	110	21.86	23.11	-1.89	-69.88	-67.99
700 to 1525	-135	0.004	83.3	21.86	23.11	-28.59	-72.14	-43.55
1525 to 1559	-203	0.004	122.2	21.86	23.11	-57.69	-72.79	-15.10
1559 to 1585	-155	1	112.3	22.01	22.01	-20.69	-49.99	-29.30
1585 to 1605	-143	1	95.7	22.01	22.01	-25.29	-48.59	-23.30
1605 to 1610	-117	1	62.5	22.01	22.01	-32.49	-47.23	-14.74
1610 to 1610.6	-95	1	40.5	22.01	22.01	-32.49	-46.35	-13.86
1610.6 to 1613.8	-49	1	40.4	22.01	22.01	13.41	-46.28	-59.69
1613.8 to 1614	-95	1	40.4	22.01	22.01	-32.59	-45.52	-12.93
1614 to 1620	-70	0.004	30.2	21.86	23.11	-16.69	-57.06	-40.37
1620 to 1624.5	-70	0.004	20.1	21.86	23.11	-26.79	-55.37	-28.58
1624.5 to 1625.5	-70	0.004	10	21.86	23.11	-36.89	-57.40	-20.51
1625.5 to 1626.5	-70	0.004	1.3	21.86	23.11	-45.59	-56.71	-11.12
1626.5 to 1660	-70	0.004	0.8	21.86	23.11	-46.09	-57.41	-11.32
1660 to 1670	-19.5	0.02	0.8	22.08	20.32	1.62	-62.92	-64.54
1670 to 1735	-60	0.004	1.6	21.86	23.11	-35.29	-70.02	-34.73
1735 to 1865	-105	0.004	56	21.86	23.11	-25.89	-57.43	-31.54
1865 to 2260.5	-105	0.004	36.6	21.86	23.11	-45.29	-76.42	-31.13
2260.5 to 3250	-105	0.004	80	21.86	23.11	-1.89	-74.60	-72.71
3250 to 3330	-105	0.004	110	21.86	23.11	28.11	-2.87	-30.98
3330 to 4000	-105	0.004	100	21.86	23.11	18.11	-77.42	-95.53
4000 to 12000	-105	0.004	110	21.86	23.11	28.11	-16.48	-44.59
12000 to 18000	-70	0.004	75	21.86	23.11	28.11	-76.11	-104.22

**QPSK 1643.5 MHz Conducted Spurious Emissions**

Freq (MHz)	Limit (dBc)	RBW (MHz)	F Type DLNA with HPA-128 HPA Rejection (dB)	Measured Power (dBm)	Corrected Power (dBm)	Necessary Level (dBm)	Measured Level (dBm)	Margin (dB)
.010 to 700	-135	0.004	110	22.01	23.26	-1.74	-70.93	-69.19
700 to 1525	-135	0.004	83.3	22.01	23.26	-28.44	-71.14	-42.70
1525 to 1559	-203	0.004	122.2	22.01	23.26	-57.54	-73.24	-15.70
1559 to 1585	-155	1	112.3	22.36	22.36	-20.34	-50.88	-30.54
1585 to 1605	-143	1	95.7	22.36	22.36	-24.94	-49.03	-24.09
1605 to 1610	-117	1	62.5	22.36	22.36	-32.14	-47.11	-14.97
1610 to 1610.6	-95	1	40.5	22.36	22.36	-32.14	-45.04	-12.90
1610.6 to 1613.8	-49	1	40.4	22.36	22.36	13.76	-44.76	-58.52
1613.8 to 1614	-95	1	40.4	22.36	22.36	-32.24	-45.57	-13.33
1614 to 1620	-70	0.004	30.2	22.01	23.26	-16.54	-66.89	-50.35
1620 to 1624.5	-70	0.004	20.1	22.01	23.26	-26.64	-63.97	-37.33
1624.5 to 1625.5	-70	0.004	10	22.01	23.26	-36.74	-59.33	-22.59
1625.5 to 1626.5	-70	0.004	1.3	22.01	23.26	-45.44	-71.1	-25.66
1626.5 to 1660	-70	0.004	0.8	22.01	23.26	-45.94	-53.4	-7.46
1660 to 1670	-19.5	0.02	0.8	22.08	20.32	1.62	-61.85	-63.47
1670 to 1735	-60	0.004	1.6	22.01	23.26	-35.14	-70.64	-35.50
1735 to 1865	-105	0.004	56	22.01	23.26	-25.74	-62.64	-36.90
1865 to 2260.5	-105	0.004	36.6	22.01	23.26	-45.14	-76.24	-31.10
2260.5 to 3250	-105	0.004	80	22.01	23.26	-1.74	-73.71	-71.97
3250 to 3330	-105	0.004	110	22.01	23.26	28.26	-23.55	-51.81
3330 to 4000	-105	0.004	100	22.01	23.26	18.26	-76.47	-94.73
4000 to 12000	-105	0.004	110	22.01	23.26	28.26	-34.53	-62.79
12000 to 18000	-70	0.004	75	22.01	23.26	28.26	-71.42	-99.68



## QPSK 1660.5 MHz Conducted Spurious Emissions

Freq (MHz)	Limit (dBc)	RBW (MHz)	F Type DLNA with HPA-128 HPA Rejection (dB)	Measured Power (dBm)	Corrected Power (dBm)	Necessary Level (dBm)	Measured Level (dBm)	Margin (dB)
.010 to 700	-135	0.004	110	22.11	23.36	-1.64	-72.53	-70.89
700 to 1525	-135	0.004	83.3	22.11	23.36	-28.34	-70.54	-42.20
1525 to 1559	-203	0.004	122.2	22.11	23.36	-57.44	-73.4	-15.96
1559 to 1585	-155	1	112.3	22.36	22.36	-20.34	-50.05	-29.71
1585 to 1605	-143	1	95.7	22.36	22.36	-24.94	-47.6	-22.66
1605 to 1610	-117	1	62.5	22.36	22.36	-32.14	-45.61	-13.47
1610 to 1610.6	-95	1	40.5	22.36	22.36	-32.14	-45.58	-13.44
1610.6 to 1613.8	-49	1	40.4	22.36	22.36	13.76	-45.51	-59.27
1613.8 to 1614	-95	1	40.4	22.36	22.36	-32.24	-44.98	-12.74
1614 to 1620	-70	0.004	30.2	22.11	23.36	-16.44	-58.92	-42.48
1620 to 1624.5	-70	0.004	20.1	22.11	23.36	-26.54	-59.1	-32.56
1624.5 to 1625.5	-70	0.004	10	22.11	23.36	-36.64	-58.03	-21.39
1625.5 to 1626.5	-70	0.004	1.3	22.11	23.36	-45.34	-62.6	-17.26
1626.5 to 1660	-70	0.004	0.8	22.11	23.36	-45.84	-53.26	-7.42
1660 to 1670	-19.5	0.02	0.8	22.15	20.39	1.69	-44.54	-46.23
1670 to 1735	-60	0.004	1.6	22.11	23.36	-35.04	-58.32	-23.28
1735 to 1865	-105	0.004	56	22.11	23.36	-25.64	-67.05	-41.41
1865 to 2260.5	-105	0.004	36.6	22.11	23.36	-45.04	-76.02	-30.98
2260.5 to 3250	-105	0.004	80	22.11	23.36	-1.64	-73.72	-72.08
3250 to 3330	-105	0.004	110	22.11	23.36	28.36	-30.27	-58.63
3330 to 4000	-105	0.004	100	22.11	23.36	18.36	-75.79	-94.15
4000 to 12000	-105	0.004	110	22.11	23.36	28.36	-46.65	-75.01
12000 to 18000	-70	0.004	75	22.11	23.36	28.36	-71.21	-99.57

**QAM 1626.5 MHz Conducted Spurious Emissions**

Freq (MHz)	Limit (dBc)	RBW (MHz)	F Type DLNA with HPA-128 HPA Rejection (dB)	Measured Power (dBm)	Corrected Power (dBm)	Necessary Level (dBm)	Measured Level (dBm)	Margin (dB)
.010 to 700	-135	0.004	110	17.53	18.78	-6.22	-73.97	-67.75
700 to 1525	-135	0.004	83.3	17.53	18.78	-32.92	-72.86	-39.94
1525 to 1559	-203	0.004	122.2	17.53	18.78	-62.02	-73.77	-11.75
1559 to 1585	-155	1	112.3	23.01	23.01	-19.69	-55.53	-35.84
1585 to 1605	-143	1	95.7	23.01	23.01	-24.29	-51.41	-27.12
1605 to 1610	-117	1	62.5	23.01	23.01	-31.49	-48.99	-17.50
1610 to 1610.6	-95	1	40.5	23.01	23.01	-31.49	-48.20	-16.71
1610.6 to 1613.8	-49	1	40.4	23.01	23.01	14.41	-47.92	-62.33
1613.8 to 1614	-95	1	40.4	23.01	23.01	-31.59	-48.96	-17.37
1614 to 1620	-70	0.004	30.2	17.53	18.78	-21.02	-61.85	-40.83
1620 to 1624.5	-70	0.004	20.1	17.53	18.78	-31.12	-61.16	-30.04
1624.5 to 1625.5	-70	0.004	10	17.53	18.78	-41.22	-59.20	-17.98
1625.5 to 1626.5	-70	0.004	1.3	17.53	18.78	-49.92	-58.26	-8.34
1626.5 to 1660	-70	0.004	0.8	17.53	18.78	-50.42	-59.91	-9.49
1660 to 1670	-19.5	0.02	0.8	22.18	20.42	1.72	-65.05	-66.77
1670 to 1735	-60	0.004	1.6	17.53	18.78	-39.62	-70.67	-31.05
1735 to 1865	-105	0.004	56	17.53	18.78	-30.22	-57.75	-27.53
1865 to 2260.5	-105	0.004	36.6	17.53	18.78	-49.62	-79.15	-29.53
2260.5 to 3250	-105	0.004	80	17.53	18.78	-6.22	-78.68	-72.46
3250 to 3330	-105	0.004	110	17.53	18.78	23.78	2.30	-21.48
3330 to 4000	-105	0.004	100	17.53	18.78	13.78	-81.21	-94.99
4000 to 12000	-105	0.004	110	17.53	18.78	23.78	-27.17	-50.95
12000 to 18000	-70	0.004	75	17.53	18.78	23.78	-76.31	-100.09



## QAM 1643.5 MHz Conducted Spurious Emissions

Freq (MHz)	Limit (dBc)	RBW (MHz)	F Type DLNA with HPA-128 HPA Rejection (dB)	Measured Power (dBm)	Corrected Power (dBm)	Necessary Level (dBm)	Measured Level (dBm)	Margin (dB)
.010 to 700	-135	0.004	110	17.16	18.41	-6.59	-70.03	-63.44
700 to 1525	-135	0.004	83.3	17.16	18.41	-33.29	-73.24	-39.95
1525 to 1559	-203	0.004	122.2	17.16	18.41	-62.39	-73.34	-10.95
1559 to 1585	-155	1	112.3	22.74	22.74	-19.96	-55.45	-35.49
1585 to 1605	-143	1	95.7	22.74	22.74	-24.56	-50.11	-25.55
1605 to 1610	-117	1	62.5	22.74	22.74	-31.76	-49.05	-17.29
1610 to 1610.6	-95	1	40.5	22.74	22.74	-31.76	-48.86	-17.10
1610.6 to 1613.8	-49	1	40.4	22.74	22.74	14.14	-47.92	-62.06
1613.8 to 1614	-95	1	40.4	22.74	22.74	-31.86	-47.7	-15.84
1614 to 1620	-70	0.004	30.2	17.16	18.41	-21.39	-71.35	-49.96
1620 to 1624.5	-70	0.004	20.1	17.16	18.41	-31.49	-70.17	-38.68
1624.5 to 1625.5	-70	0.004	10	17.16	18.41	-41.59	-64.61	-23.02
1625.5 to 1626.5	-70	0.004	1.3	17.16	18.41	-50.29	-73.62	-23.33
1626.5 to 1660	-70	0.004	0.8	17.16	18.41	-50.79	-58.32	-7.53
1660 to 1670	-19.5	0.02	0.8	21.89	20.13	1.43	-63.39	-64.82
1670 to 1735	-60	0.004	1.6	17.16	18.41	-39.99	-71.85	-31.86
1735 to 1865	-105	0.004	56	17.16	18.41	-30.59	-62.11	-31.52
1865 to 2260.5	-105	0.004	36.6	17.16	18.41	-49.99	-80.17	-30.18
2260.5 to 3250	-105	0.004	80	17.16	18.41	-6.59	-78.32	-71.73
3250 to 3330	-105	0.004	110	17.16	18.41	23.41	-31.51	-54.92
3330 to 4000	-105	0.004	100	17.16	18.41	13.41	-82.09	-95.50
4000 to 12000	-105	0.004	110	17.16	18.41	23.41	-44.07	-67.48
12000 to 18000	-70	0.004	75	17.16	18.41	23.41	-75.61	-99.02





## QAM 1660.5 MHz Conducted Spurious Emissions

Freq (MHz)	Limit (dBc)	RBW (MHz)	F Type DLNA with HPA-128 HPA Rejection (dB)	Measured Power (dBm)	Corrected Power (dBm)	Necessary Level (dBm)	Measured Level (dBm)	Margin (dB)
.010 to 700	-135	0.004	110	16.79	18.04	-6.96	-72.14	-65.18
700 to 1525	-135	0.004	83.3	16.79	18.04	-33.66	-73.72	-40.06
1525 to 1559	-203	0.004	122.2	16.79	18.04	-62.76	-73.77	-11.01
1559 to 1585	-155	1	112.3	22.48	22.48	-20.22	-55.76	-35.54
1585 to 1605	-143	1	95.7	22.48	22.48	-24.82	-47.47	-22.65
1605 to 1610	-117	1	62.5	22.48	22.48	-32.02	-48.09	-16.07
1610 to 1610.6	-95	1	40.5	22.48	22.48	-32.02	-47.76	-15.74
1610.6 to 1613.8	-49	1	40.4	22.48	22.48	13.88	-47.01	-60.89
1613.8 to 1614	-95	1	40.4	22.48	22.48	-32.12	-47.3	-15.18
1614 to 1620	-70	0.004	30.2	16.79	18.04	-21.76	-61.63	-39.87
1620 to 1624.5	-70	0.004	20.1	16.79	18.04	-31.86	-61.54	-29.68
1624.5 to 1625.5	-70	0.004	10	16.79	18.04	-41.96	-63.15	-21.19
1625.5 to 1626.5	-70	0.004	1.3	16.79	18.04	-50.66	-64.86	-14.20
1626.5 to 1660	-70	0.004	0.8	16.79	18.04	-51.16	-59.06	-7.90
1660 to 1670	-19.5	0.02	0.8	21.69	19.93	1.23	-47.43	-48.66
1670 to 1735	-60	0.004	1.6	16.79	18.04	-40.36	-65.4	-25.04
1735 to 1865	-105	0.004	56	16.79	18.04	-30.96	-66.23	-35.27
1865 to 2260.5	-105	0.004	36.6	16.79	18.04	-50.36	-80.61	-30.25
2260.5 to 3250	-105	0.004	80	16.79	18.04	-6.96	-79.61	-72.65
3250 to 3330	-105	0.004	110	16.79	18.04	23.04	-39.43	-62.47
3330 to 4000	-105	0.004	100	16.79	18.04	13.04	-81.82	-94.86
4000 to 12000	-105	0.004	110	16.79	18.04	23.04	-56.62	-79.66
12000 to 18000	-70	0.004	75	16.79	18.04	23.04	-71.48	-94.52

### BPSK 1626.5 MHz Conducted Spurious Emissions

Freq (MHz)	Limit (dBc)	RBW (MHz)	Modified A Type DLNA with HPA-128 HPA Rejection (dB)	Measured Power (dBm)	Corrected Power (dBm)	Necessary Level (dBm)	Measured Level (dBm)	Margin (dB)
.010 to 700	-135	0.004	110	20.01	21.26	-3.74	-71.19	-67.45
700 to 1525	-135	0.004	83.3	20.01	21.26	-30.44	-69.52	-39.08
1525 to 1559	-203	0.004	122.2	20.01	21.26	-59.54	-74.5	-14.96
1559 to 1585	-155	1	101.3	20.13	20.13	-33.57	-51.36	-17.79
1585 to 1605	-143	1	88.7	20.13	20.13	-34.17	-49.06	-14.89
1605 to 1610	-117	1	62.5	20.13	20.13	-34.37	-47.8	-13.43
1610 to 1610.6	-95	1	40.5	20.13	20.13	-34.37	-46.58	-12.21
1610.6 to 1613.8	-49	1	40.4	20.13	20.13	11.53	-46.26	-57.79
1613.8 to 1614	-95	1	40.4	20.13	20.13	-34.47	-45.6	-11.13
1614 to 1620	-70	0.004	2.5	20.01	21.26	-46.24	-58.73	-12.49
1620 to 1626.5	-70	0.004	2.3	20.01	21.26	-46.44	-57.18	-10.74
1626.5 to 1660	-70	0.004	0.8	20.01	21.26	-47.94	-57.7	-9.76
1660 to 1670	-19.5	0.02	0.8	20.13	18.37	-0.33	-62.93	-62.60
1670 to 1735	-60	0.004	1.6	20.01	21.26	-37.14	-72.13	-34.99
1735 to 1865	-105	0.004	56	20.01	21.26	-27.74	-57.77	-30.03
1865 to 2260.5	-105	0.004	66.6	20.01	21.26	-17.14	-76.13	-58.99
2260.5 to 12000	-105	0.004	110	20.01	21.26	26.26	-12.09	-38.35
12000 to 18000	-70	0.004	75	20.01	21.26	26.26	-71.23	-97.49

### BPSK 1643.5 MHz Conducted Spurious Emissions

Freq (MHz)	Limit (dBc)	RBW (MHz)	Modified A Type DLNA with HPA-128 HPA Rejection (dB)	Measured Power (dBm)	Corrected Power (dBm)	Necessary Level (dBm)	Measured Level (dBm)	Margin (dB)
.010 to 700	-135	0.004	110	19.83	21.08	-3.92	-69.03	-65.11
700 to 1525	-135	0.004	83.3	19.83	21.08	-30.62	-70.55	-39.93
1525 to 1559	-203	0.004	122.2	19.83	21.08	-59.72	-71.38	-11.66
1559 to 1585	-155	1	101.3	19.95	19.95	-33.75	-51.03	-17.28
1585 to 1605	-143	1	88.7	19.95	19.95	-34.35	-49.24	-14.89
1605 to 1610	-117	1	62.5	19.95	19.95	-34.55	-46.85	-12.30
1610 to 1610.6	-95	1	40.5	19.95	19.95	-34.55	-47.49	-12.94
1610.6 to 1613.8	-49	1	40.4	19.95	19.95	11.35	-46.27	-57.62
1613.8 to 1614	-95	1	40.4	19.95	19.95	-34.65	-46.37	-11.72
1614 to 1620	-70	0.004	2.5	19.83	21.08	-46.42	-68.2	-21.78
1620 to 1626.5	-70	0.004	2.3	19.83	21.08	-46.62	-61.15	-14.53
1626.5 to 1660	-70	0.004	0.8	19.83	21.08	-48.12	-56.71	-8.59
1660 to 1670	-19.5	0.02	0.8	19.84	18.08	-0.62	-62.35	-61.73
1670 to 1735	-60	0.004	1.6	19.83	21.08	-37.32	-70.56	-33.24
1735 to 1865	-105	0.004	56	19.83	21.08	-27.92	-62.03	-34.11
1865 to 2260.5	-105	0.004	66.6	19.83	21.08	-17.32	-75.9	-58.58
2260.5 to 12000	-105	0.004	110	19.83	21.08	26.08	-26.61	-52.69
12000 to 18000	-70	0.004	75	19.83	21.08	26.08	-70.9	-96.98

**BPSK 1660.5 MHz Conducted Spurious Emissions**

Freq (MHz)	Limit (dBc)	RBW (MHz)	Modified A Type DLNA with HPA-128 HPA Rejection (dB)	Measured Power (dBm)	Corrected Power (dBm)	Necessary Level (dBm)	Measured Level (dBm)	Margin (dB)
.010 to 700	-135	0.004	110	19.4	20.65	-4.35	-70.78	-66.43
700 to 1525	-135	0.004	83.3	19.4	20.65	-31.05	-70.06	-39.01
1525 to 1559	-203	0.004	122.2	19.4	20.65	-60.15	-72.48	-12.33
1559 to 1585	-155	1	101.3	20.41	20.41	-33.29	-51.44	-18.15
1585 to 1605	-143	1	88.7	20.41	20.41	-33.89	-48.8	-14.91
1605 to 1610	-117	1	62.5	20.41	20.41	-34.09	-45.59	-11.50
1610 to 1610.6	-95	1	40.5	20.41	20.41	-34.09	-45.11	-11.02
1610.6 to 1613.8	-49	1	40.4	20.41	20.41	11.81	-45.54	-57.35
1613.8 to 1614	-95	1	40.4	20.41	20.41	-34.19	-45.14	-10.95
1614 to 1620	-70	0.004	2.5	19.4	20.65	-46.85	-60.37	-13.52
1620 to 1626.5	-70	0.004	2.3	19.4	20.65	-47.05	-59.71	-12.66
1626.5 to 1660	-70	0.004	0.8	19.4	20.65	-48.55	-55.1	-6.55
1660 to 1670	-19.5	0.02	0.8	19.49	17.73	-0.97	-44.36	-43.39
1670 to 1735	-60	0.004	1.6	19.4	20.65	-37.75	-61.57	-23.82
1735 to 1865	-105	0.004	56	19.4	20.65	-28.35	-66.77	-38.42
1865 to 2260.5	-105	0.004	66.6	19.4	20.65	-17.75	-76.2	-58.45
2260.5 to 12000	-105	0.004	110	19.4	20.65	25.65	-33.53	-59.18
12000 to 18000	-70	0.004	75	19.4	20.65	25.65	-71.32	-96.97

**QPSK 1626.5 MHz Conducted Spurious Emissions**

Freq (MHz)	Limit (dBc)	RBW (MHz)	Modified A Type DLNA with HPA-128 HPA Rejection (dB)	Measured Power (dBm)	Corrected Power (dBm)	Necessary Level (dBm)	Measured Level (dBm)	Margin (dB)
.010 to 700	-135	0.004	110	21.86	23.11	-1.89	-69.88	-67.99
700 to 1525	-135	0.004	83.3	21.86	23.11	-28.59	-72.14	-43.55
1525 to 1559	-203	0.004	122.2	21.86	23.11	-57.69	-72.79	-15.10
1559 to 1585	-155	1	101.3	22.01	22.01	-31.69	-49.99	-18.30
1585 to 1605	-143	1	88.7	22.01	22.01	-32.29	-48.59	-16.30
1605 to 1610	-117	1	62.5	22.01	22.01	-32.49	-47.23	-14.74
1610 to 1610.6	-95	1	40.5	22.01	22.01	-32.49	-46.35	-13.86
1610.6 to 1613.8	-49	1	40.4	22.01	22.01	13.41	-46.28	-59.69
1613.8 to 1614	-95	1	40.4	22.01	22.01	-32.59	-45.52	-12.93
1614 to 1620	-70	0.004	2.5	21.86	23.11	-44.39	-57.06	-12.67
1620 to 1626.5	-70	0.004	2.3	21.86	23.11	-44.59	-55.37	-10.78
1626.5 to 1660	-70	0.004	0.8	21.86	23.11	-46.09	-57.41	-11.32
1660 to 1670	-19.5	0.02	0.8	22.08	20.32	1.62	-62.92	-64.54
1670 to 1735	-60	0.004	1.6	21.86	23.11	-35.29	-70.02	-34.73
1735 to 1865	-105	0.004	56	21.86	23.11	-25.89	-57.43	-31.54
1865 to 2260.5	-105	0.004	66.6	21.86	23.11	-15.29	-76.42	-61.13
2260.5 to 12000	-105	0.004	110	21.86	23.11	28.11	-2.87	-30.98
12000 to 18000	-70	0.004	75	21.86	23.11	28.11	-76.11	-104.22

### QPSK 1643.5 MHz Conducted Spurious Emissions

Freq (MHz)	Limit (dBc)	RBW (MHz)	Modified A Type DLNA with HPA-128 HPA Rejection (dB)	Measured Power (dBm)	Corrected Power (dBm)	Necessary Level (dBm)	Measured Level (dBm)	Margin (dB)
.010 to 700	-135	0.004	110	22.01	23.26	-1.74	-70.93	-69.19
700 to 1525	-135	0.004	83.3	22.01	23.26	-28.44	-71.14	-42.70
1525 to 1559	-203	0.004	122.2	22.01	23.26	-57.54	-73.24	-15.70
1559 to 1585	-155	1	101.3	22.36	22.36	-31.34	-50.88	-19.54
1585 to 1605	-143	1	88.7	22.36	22.36	-31.94	-49.03	-17.09
1605 to 1610	-117	1	62.5	22.36	22.36	-32.14	-47.11	-14.97
1610 to 1610.6	-95	1	40.5	22.36	22.36	-32.14	-45.04	-12.90
1610.6 to 1613.8	-49	1	40.4	22.36	22.36	13.76	-44.76	-58.52
1613.8 to 1614	-95	1	40.4	22.36	22.36	-32.24	-45.57	-13.33
1614 to 1620	-70	0.004	2.5	22.01	23.26	-44.24	-66.89	-22.65
1620 to 1626.5	-70	0.004	2.3	22.01	23.26	-44.44	-59.33	-14.89
1626.5 to 1660	-70	0.004	0.8	22.01	23.26	-45.94	-53.40	-7.46
1660 to 1670	-19.5	0.02	0.8	22.08	20.32	1.62	-61.85	-63.47
1670 to 1735	-60	0.004	1.6	22.01	23.26	-35.14	-70.64	-35.50
1735 to 1865	-105	0.004	56	22.01	23.26	-25.74	-62.64	-36.90
1865 to 2260.5	-105	0.004	66.6	22.01	23.26	-15.14	-76.24	-61.10
2260.5 to 12000	-105	0.004	110	22.01	23.26	28.26	-23.55	-51.81
12000 to 18000	-70	0.004	75	22.01	23.26	28.26	-71.42	-99.68

### QPSK 1660.5 MHz Conducted Spurious Emissions

Freq (MHz)	Limit (dBc)	RBW (MHz)	Modified A Type DLNA with HPA-128 HPA Rejection (dB)	Measured Power (dBm)	Corrected Power (dBm)	Necessary Level (dBm)	Measured Level (dBm)	Margin (dB)
.010 to 700	-135	0.004	110	22.11	23.36	-1.64	-72.53	-70.89
700 to 1525	-135	0.004	83.3	22.11	23.36	-28.34	-70.54	-42.20
1525 to 1559	-203	0.004	122.2	22.11	23.36	-57.44	-73.40	-15.96
1559 to 1585	-155	1	101.3	22.36	22.36	-31.34	-50.05	-18.71
1585 to 1605	-143	1	88.7	22.36	22.36	-31.94	-47.60	-15.66
1605 to 1610	-117	1	62.5	22.36	22.36	-32.14	-45.61	-13.47
1610 to 1610.6	-95	1	40.5	22.36	22.36	-32.14	-45.58	-13.44
1610.6 to 1613.8	-49	1	40.4	22.36	22.36	13.76	-45.51	-59.27
1613.8 to 1614	-95	1	40.4	22.36	22.36	-32.24	-44.98	-12.74
1614 to 1620	-70	0.004	2.5	22.11	23.36	-44.14	-58.92	-14.78
1620 to 1626.5	-70	0.004	2.3	22.11	23.36	-44.34	-58.03	-13.69
1626.5 to 1660	-70	0.004	0.8	22.11	23.36	-45.84	-53.26	-7.42
1660 to 1670	-19.5	0.02	0.8	22.15	20.39	1.69	-44.54	-46.23
1670 to 1735	-60	0.004	1.6	22.11	23.36	-35.04	-58.32	-23.28
1735 to 1865	-105	0.004	56	22.11	23.36	-25.64	-67.05	-41.41
1865 to 2260.5	-105	0.004	66.6	22.11	23.36	-15.04	-76.02	-60.98
2260.5 to 12000	-105	0.004	110	22.11	23.36	28.36	-30.27	-58.63
12000 to 18000	-70	0.004	75	22.11	23.36	28.36	-71.21	-99.57

### QAM 1626.5 MHz Conducted Spurious Emissions

Freq (MHz)	Limit (dBc)	RBW (MHz)	Modified A Type DLNA with HPA-128 HPA Rejection (dB)	Measured Power (dBm)	Corrected Power (dBm)	Necessary Level (dBm)	Measured Level (dBm)	Margin (dB)
.010 to 700	-135	0.004	110	17.53	18.78	-6.22	-73.97	-67.75
700 to 1525	-135	0.004	83.3	17.53	18.78	-32.92	-72.86	-39.94
1525 to 1559	-203	0.004	122.2	17.53	18.78	-62.02	-73.77	-11.75
1559 to 1585	-155	1	101.3	23.01	23.01	-30.69	-55.53	-24.84
1585 to 1605	-143	1	88.7	23.01	23.01	-31.29	-51.41	-20.12
1605 to 1610	-117	1	62.5	23.01	23.01	-31.49	-48.99	-17.50
1610 to 1610.6	-95	1	40.5	23.01	23.01	37.28	-48.20	-85.48
1610.6 to 1613.8	-49	1	40.4	23.01	23.01	14.41	-47.92	-62.33
1613.8 to 1614	-95	1	40.4	23.01	23.01	-31.59	-48.96	-17.37
1614 to 1620	-70	0.004	2.5	17.53	18.78	-48.72	-61.85	-13.13
1620 to 1626.5	-70	0.004	2.3	17.53	18.78	-48.92	-58.26	-9.34
1626.5 to 1660	-70	0.004	0.8	17.53	18.78	-50.42	-59.91	-9.49
1660 to 1670	-19.5	0.02	0.8	22.18	20.42	1.72	-65.05	-66.77
1670 to 1735	-60	0.004	1.6	17.53	18.78	-39.62	-70.67	-31.05
1735 to 1865	-105	0.004	56	17.53	18.78	-30.22	-57.75	-27.53
1865 to 2260.5	-105	0.004	66.6	17.53	18.78	-19.62	-79.15	-59.53
2260.5 to 12000	-105	0.004	110	17.53	18.78	23.78	2.30	-21.48
12000 to 18000	-70	0.004	75	17.53	18.78	23.78	-76.31	-100.09

### QAM 1643.5 MHz Conducted Spurious Emissions

Freq (MHz)	Limit (dBc)	RBW (MHz)	Modified A Type DLNA with HPA-128 HPA Rejection (dB)	Measured Power (dBm)	Corrected Power (dBm)	Necessary Level (dBm)	Measured Level (dBm)	Margin (dB)
.010 to 700	-135	0.004	110	17.16	18.41	-6.59	-70.03	-63.44
700 to 1525	-135	0.004	83.3	17.16	18.41	-33.29	-73.24	-39.95
1525 to 1559	-203	0.004	122.2	17.16	18.41	-62.39	-73.34	-10.95
1559 to 1585	-155	1	101.3	22.74	22.74	-30.96	-55.45	-24.49
1585 to 1605	-143	1	88.7	22.74	22.74	-31.56	-50.11	-18.55
1605 to 1610	-117	1	62.5	22.74	22.74	-31.76	-49.05	-17.29
1610 to 1610.6	-95	1	40.5	22.74	22.74	-31.76	-48.86	-17.10
1610.6 to 1613.8	-49	1	40.4	22.74	22.74	14.14	-47.92	-62.06
1613.8 to 1614	-95	1	40.4	22.74	22.74	-31.86	-47.70	-15.84
1614 to 1620	-70	0.004	2.5	17.16	18.41	-49.09	-71.35	-22.26
1620 to 1626.5	-70	0.004	2.3	17.16	18.41	-49.29	-64.61	-15.32
1626.5 to 1660	-70	0.004	0.8	17.16	18.41	-50.79	-58.32	-7.53
1660 to 1670	-19.5	0.02	0.8	21.89	20.13	1.43	-63.39	-64.82
1670 to 1735	-60	0.004	1.6	17.16	18.41	-39.99	-71.85	-31.86
1735 to 1865	-105	0.004	56	17.16	18.41	-30.59	-62.11	-31.52
1865 to 2260.5	-105	0.004	66.6	17.16	18.41	-19.99	-80.17	-60.18
2260.5 to 12000	-105	0.004	110	17.16	18.41	23.41	-31.51	-54.92
12000 to 18000	-70	0.004	75	17.16	18.41	23.41	-75.61	-99.02



## QAM 1660.5 MHz Conducted Spurious Emissions

Freq (MHz)	Limit (dBc)	RBW (MHz)	Modified A Type DLNA with HPA-128 HPA Rejection (dB)	Measured Power (dBm)	Corrected Power (dBm)	Necessary Level (dBm)	Measured Level (dBm)	Margin (dB)
.010 to 700	-135	0.004	110	16.79	18.04	-6.96	-72.14	-65.18
700 to 1525	-135	0.004	83.3	16.79	18.04	-33.66	-73.72	-40.06
1525 to 1559	-203	0.004	122.2	16.79	18.04	-62.76	-73.77	-11.01
1559 to 1585	-155	1	101.3	22.48	22.48	-31.22	-55.76	-24.54
1585 to 1605	-143	1	88.7	22.48	22.48	-31.82	-47.47	-15.65
1605 to 1610	-117	1	62.5	22.48	22.48	-32.02	-48.09	-16.07
1610 to 1610.6	-95	1	40.5	22.48	22.48	-32.02	-47.76	-15.74
1610.6 to 1613.8	-49	1	40.4	22.48	22.48	13.88	-47.01	-60.89
1613.8 to 1614	-95	1	40.4	22.48	22.48	-32.12	-47.30	-15.18
1614 to 1620	-70	0.004	2.5	16.79	18.04	-49.46	-61.63	-12.17
1620 to 1626.5	-70	0.004	2.3	16.79	18.04	-49.66	-61.54	-11.88
1626.5 to 1660	-70	0.004	0.8	16.79	18.04	-51.16	-59.06	-7.90
1660 to 1670	-19.5	0.02	0.8	21.69	19.93	1.23	-47.43	-48.66
1670 to 1735	-60	0.004	1.6	16.79	18.04	-40.36	-65.40	-25.04
1735 to 1865	-105	0.004	56	16.79	18.04	-30.96	-66.23	-35.27
1865 to 2260.5	-105	0.004	66.6	16.79	18.04	-20.36	-80.61	-60.25
2260.5 to 12000	-105	0.004	110	16.79	18.04	23.04	-39.43	-62.47
12000 to 18000	-70	0.004	75	16.79	18.04	23.04	-71.48	-94.52



**Name of Test:** Field Strength of Spurious Radiation  
**Specification:** 2.1053,  
**Test Equipment Utilized:** 0668, 04806, i00103, i00331

**Engineer:** J. Erhard  
**Test Date:** 4/7/2010

### Test Procedure

- A) Connect the equipment as illustrated
- B) Adjust the spectrum analyzer for the following settings:
  - 1) Resolution Bandwidth 100 kHz (<1 GHz), 1 MHz (> 1GHz).
  - 2) Video Bandwidth  $\geq 3$  times Resolution Bandwidth, or 30 kHz
  - 3) Sweep Speed  $\leq 2000$  Hz/second
  - 4) Detector Mode = Mean or Average Power
- C) Place the transmitter to be tested on the turntable in the standard test site. The transmitter is transmitting into a non-radiating load that is placed on the turntable. The RF cable to this load should be of minimum length.
- D) For each spurious measurement the test antenna should be adjusted to the correct length for the frequency involved. This length may be determined from a calibration ruler supplied with the equipment. Measurements shall be made from the lowest radio frequency generated in the equipment to the tenth harmonic of the carrier, except for the region close to the carrier equal to  $\pm$  the test bandwidth (see section 1.3.4.4).
- E) For each spurious frequency, raise and lower the test antenna from 1 m to 4 m to obtain a maximum reading on the spectrum analyzer with the test antenna at horizontal polarity. Repeat this procedure to obtain the highest possible reading. Record this maximum reading.
- F) Repeat step E) for each spurious frequency with the test antenna polarized vertically.
- G) Reconnect the equipment as illustrated.
- H) Keep the spectrum analyzer adjusted as in step B).
- I) Remove the transmitter and replace it with a substitution antenna (the antenna should be half-wavelength for each frequency involved). The center of the substitution antenna should be approximately at the same location as the center of the transmitter. At lower frequencies, where the substitution antenna is very long, this will be impossible to achieve when the antenna is polarized vertically. In such case the lower end of the antenna should be 0.3 m above the ground.
- J) Feed the substitution antenna at the transmitter end with a signal generator connected to the antenna by means of a non-radiating cable. With the antennas at both ends horizontally polarized and with the signal generator tuned to a particular spurious frequency, raise and lower the test antenna to obtain a maximum reading at the spectrum analyzer. Adjust the level of the signal generator output until the previously recorded maximum reading for this set of conditions is obtained. This should be done carefully repeating the adjustment of the test antenna and generator output.
- K) Repeat step J) with both antennas vertically polarized for each spurious frequency.
- L) Calculate power in dBm into a reference ideal half-wave dipole antenna by reducing the readings obtained in steps J) and K) by the power loss in the cable between the generator and the antenna and further corrected for the gain of the substitution antenna used relative to an ideal half-wave dipole antenna.
- M) The levels recorded in step L) are absolute levels of radiated spurious emissions in dBm. The radiated spurious emissions in dB can be calculated by the following:

Radiated spurious emissions dB =  $10\log_{10}(\text{TX power in watts}/0.001)$  – the levels in step I)

*NOTE: It is permissible that other antennas provided can be referenced to a dipole.*

### Test Setup

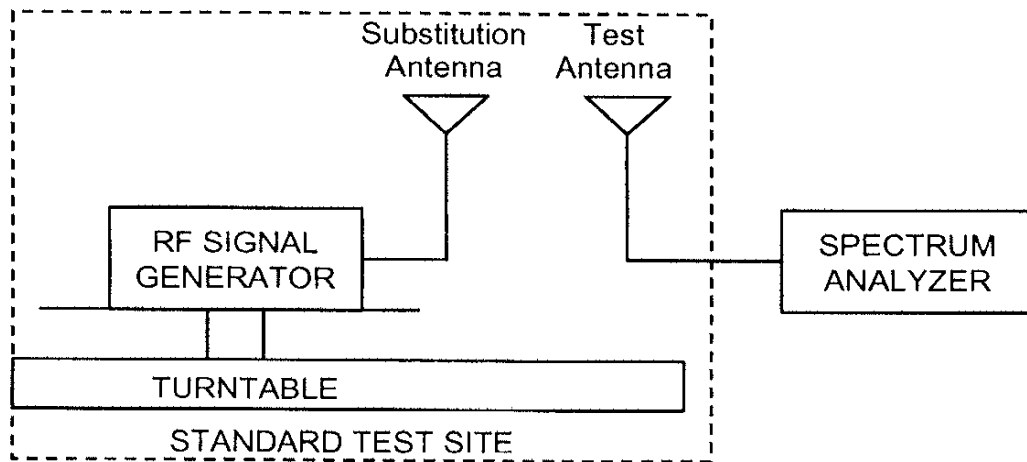
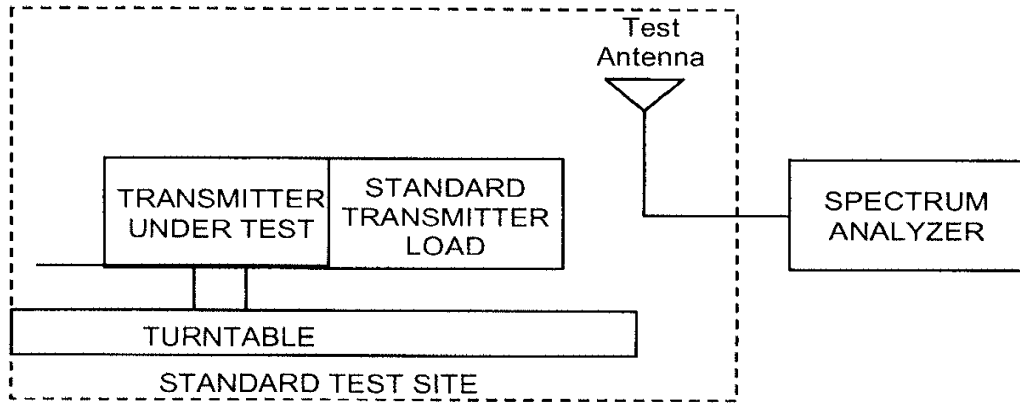



**BPSK 1626.5 MHz Radiated Spurious Emissions**

Emission Frequency (MHz)	Measured Level (dBm)	Limit (dBm)	Result
3253.0	-59.47	-13	Pass
4879.5	-58.35	-13	Pass
6506.0	-56.39	-13	Pass

**BPSK 1643.5 MHz Radiated Spurious Emissions**

Emission Frequency (MHz)	Measured Level (dBm)	Limit (dBm)	Result
3287.0	-60.22	-13	Pass
4930.5	-52.12	-13	Pass
6574.0	-55.98	-13	Pass

**BPSK 1660.5 MHz Radiated Spurious Emissions**

Emission Frequency (MHz)	Measured Level (dBm)	Limit (dBm)	Result
3321.0	-60.19	-13	Pass
4981.5	-56.49	-13	Pass
6642.0	-56.49	-13	Pass

**QPSK 1626.5 MHz Radiated Spurious Emissions**

Emission Frequency (MHz)	Measured Level (dBm)	Limit (dBm)	Result
3253.0	-60.24	-13	Pass
4879.5	-58.11	-13	Pass
6506.0	-57.13	-13	Pass

**QPSK 1643.5 MHz Radiated Spurious Emissions**

Emission Frequency (MHz)	Measured Level (dBm)	Limit (dBm)	Result
3287.0	-60.68	-13	Pass
4930.5	-57.41	-13	Pass
6574.0	-57.13	-13	Pass

**QPSK 1660.5 MHz Radiated Spurious Emissions**

Emission Frequency (MHz)	Measured Level (dBm)	Limit (dBm)	Result
3321.0	-58.56	-13	Pass
4981.5	-57.06	-13	Pass
6642.0	-55.33	-13	Pass



**QAM 1626.5 MHz Radiated Spurious Emissions**

Emission Frequency (MHz)	Measured Level (dBm)	Limit (dBm)	Result
3253.0	-59.99	-13	Pass
4879.5	-57.63	-13	Pass
6506.0	-55.94	-13	Pass

**QAM 1643.5 MHz Radiated Spurious Emissions**

Emission Frequency (MHz)	Measured Level (dBm)	Limit (dBm)	Result
3287.0	-58.95	-13	Pass
4930.5	-57.41	-13	Pass
6574.0	-56.8	-13	Pass

**QAM 1660.5 MHz Radiated Spurious Emissions**

Emission Frequency (MHz)	Measured Level (dBm)	Limit (dBm)	Result
3321.0	-59.52	-13	Pass
4981.5	-57.66	-13	Pass
6642.0	-57.01	-13	Pass

No other emissions were detected.

**Name of Test:** Emission Masks (Occupied Bandwidth)  
**Specification:** 2.1049, 87.139(i)(3) **Engineer:** J. Erhard  
**Test Equipment Utilized:** 0668, 04806, i00331 **Test Date:** 4/6/2010

The EUT was connected directly to a spectrum analyzer to verify that the EUT meets the required emissions mask. A reference level plot is provided to verify that the peak power was established prior to testing the mask. The transmitter is digital modulation therefore no data input is required to measure the emission mask. The RBW was set as close as possible to 1% of the occupied bandwidth to ensure accurate readings.

**Test Setup**

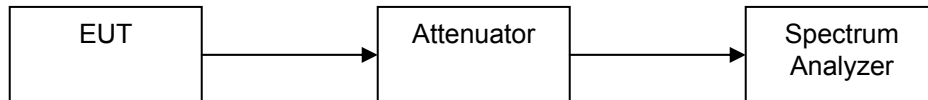

**BPSK Emissions Mask**

**BPSK 1626.5 MHz Reference**

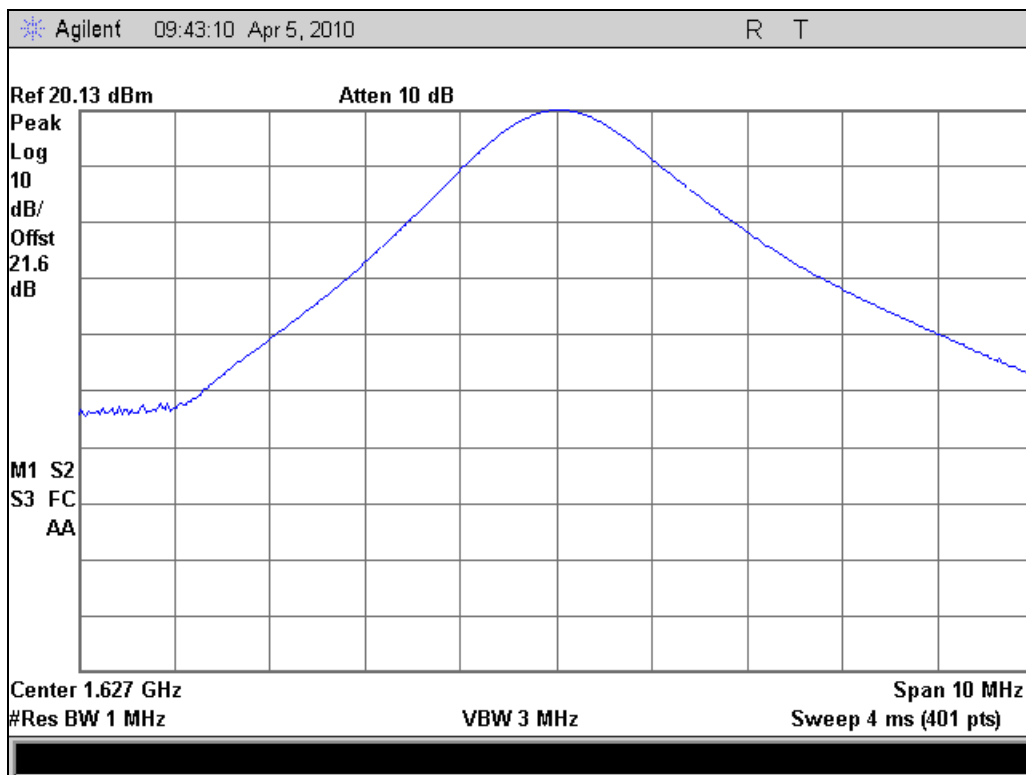



### BPSK 1643.5 MHz Reference

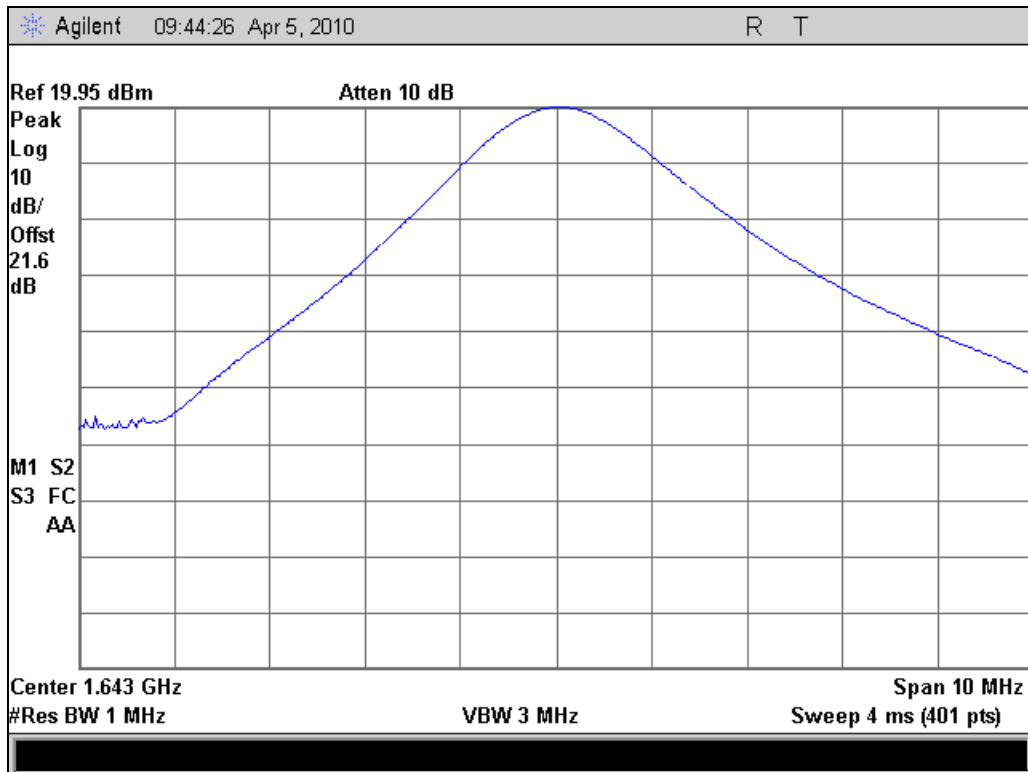

### BPSK 1660.5 MHz Reference

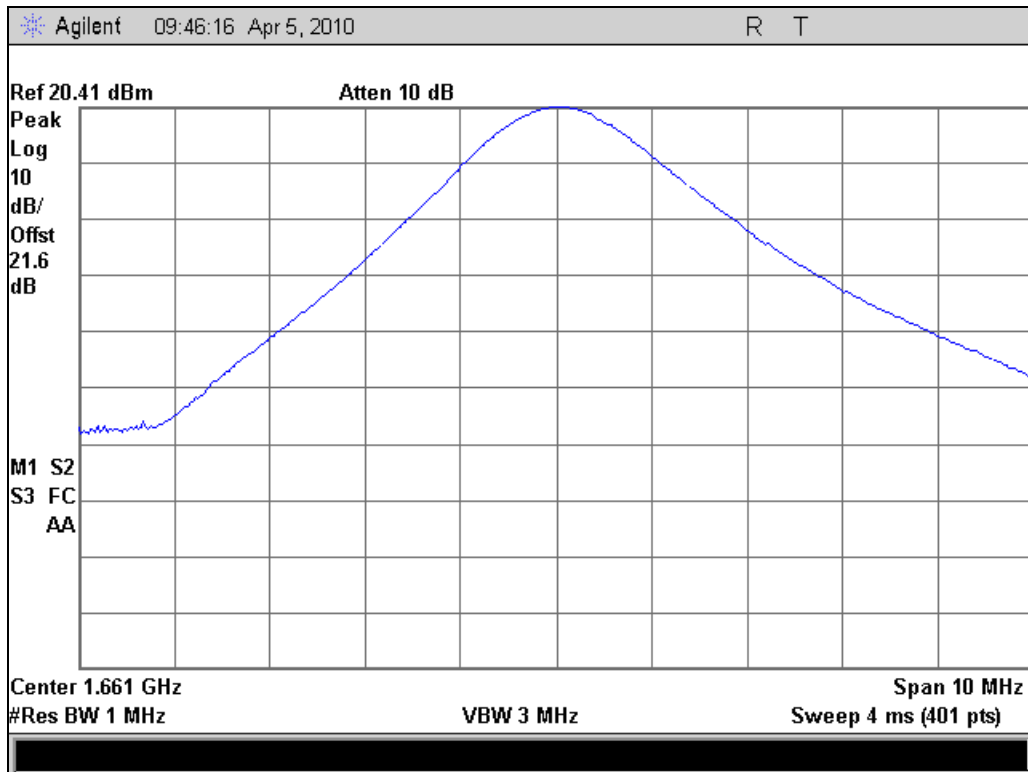

BPSK 1626.5 MHz 21K0G1D

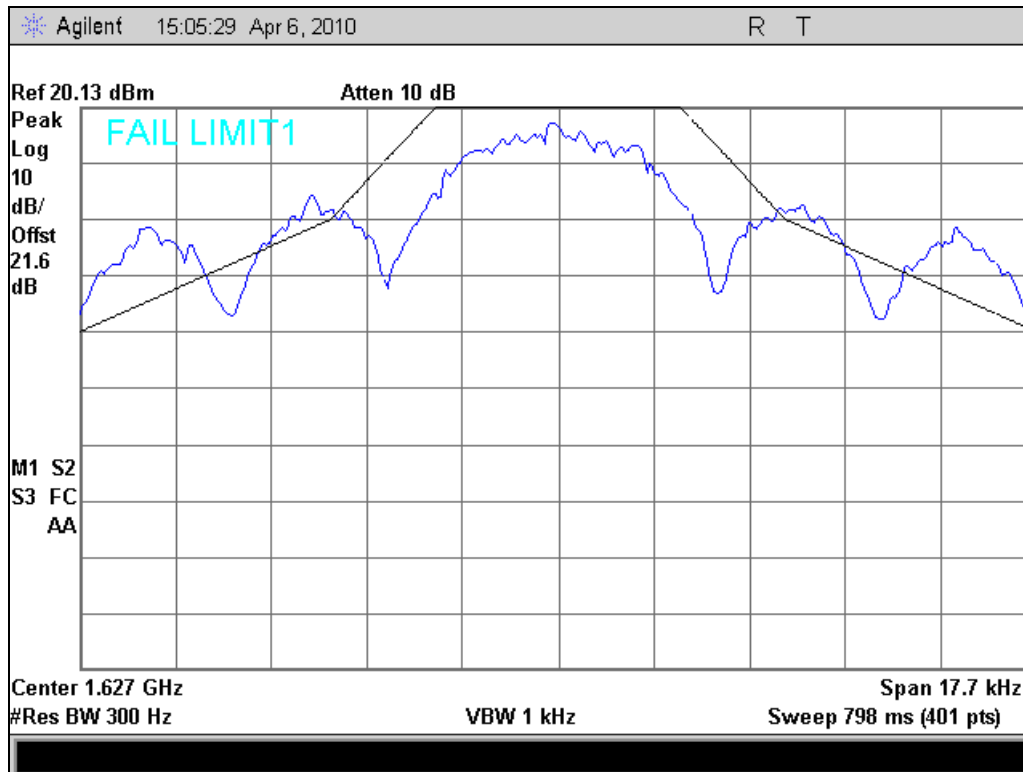

BPSK 1643.5 MHz 21K0G1D

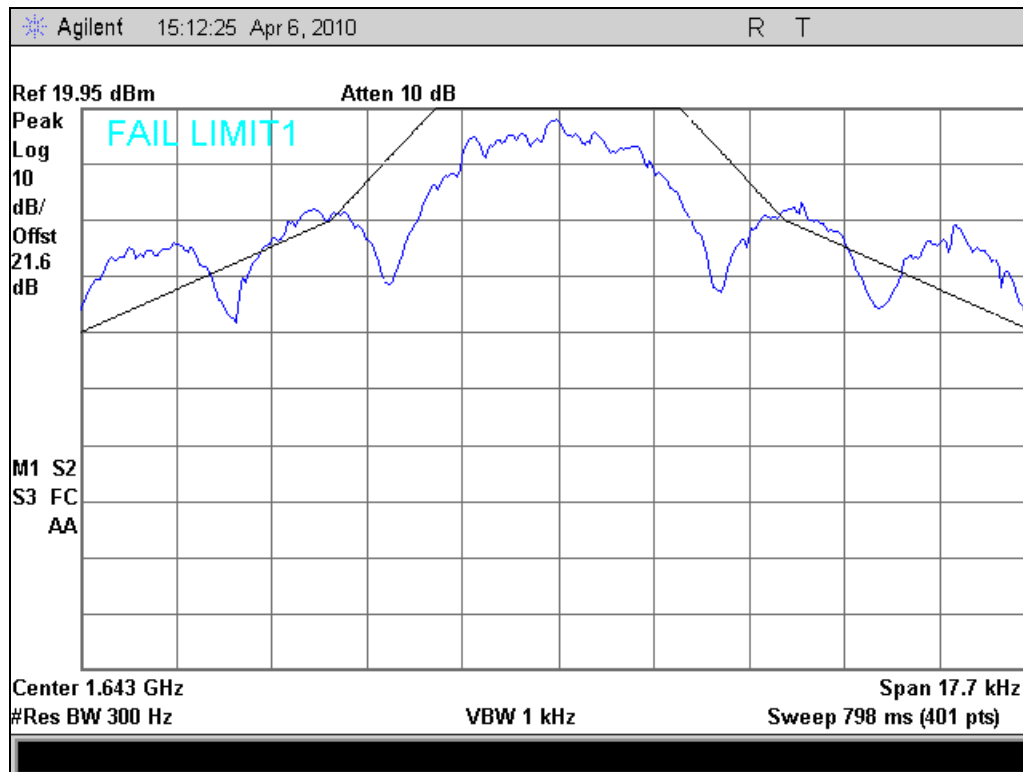

BPSK 1660.5 MHz 21K0G1D

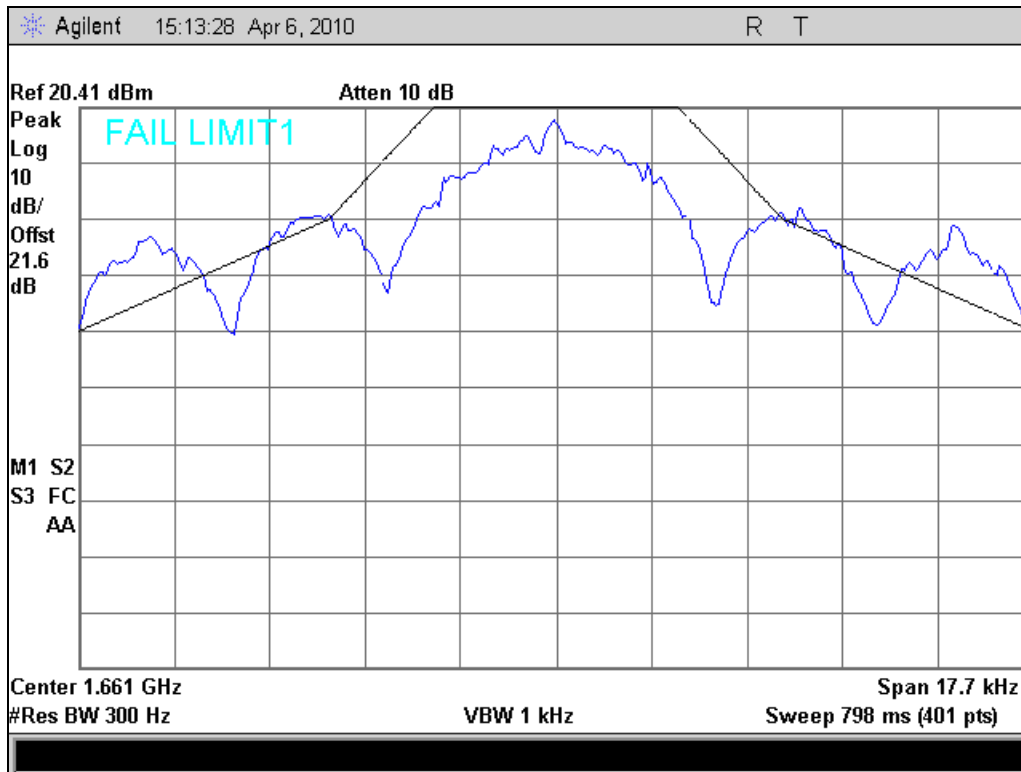

A waiver has been granted for this modulation type and bandwidth.



### QPSK Emissions Mask

#### QPSK 1626.5 MHz Reference

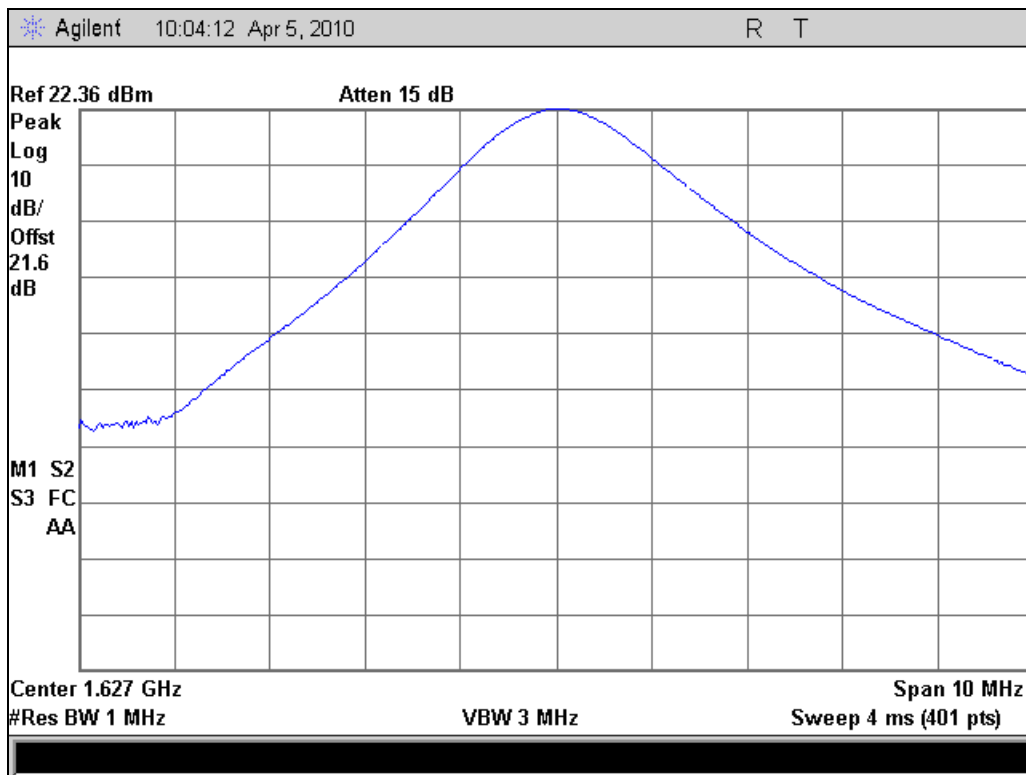

#### QPSK 1643.5 MHz Reference

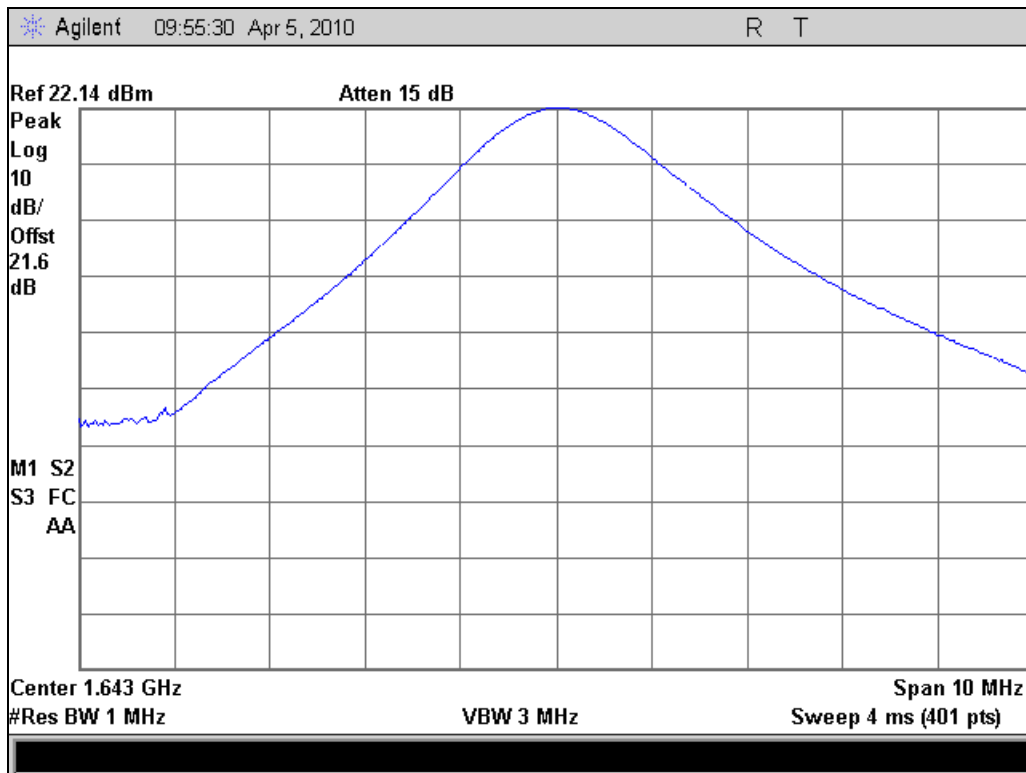



### QPSK 1660.5 MHz Reference

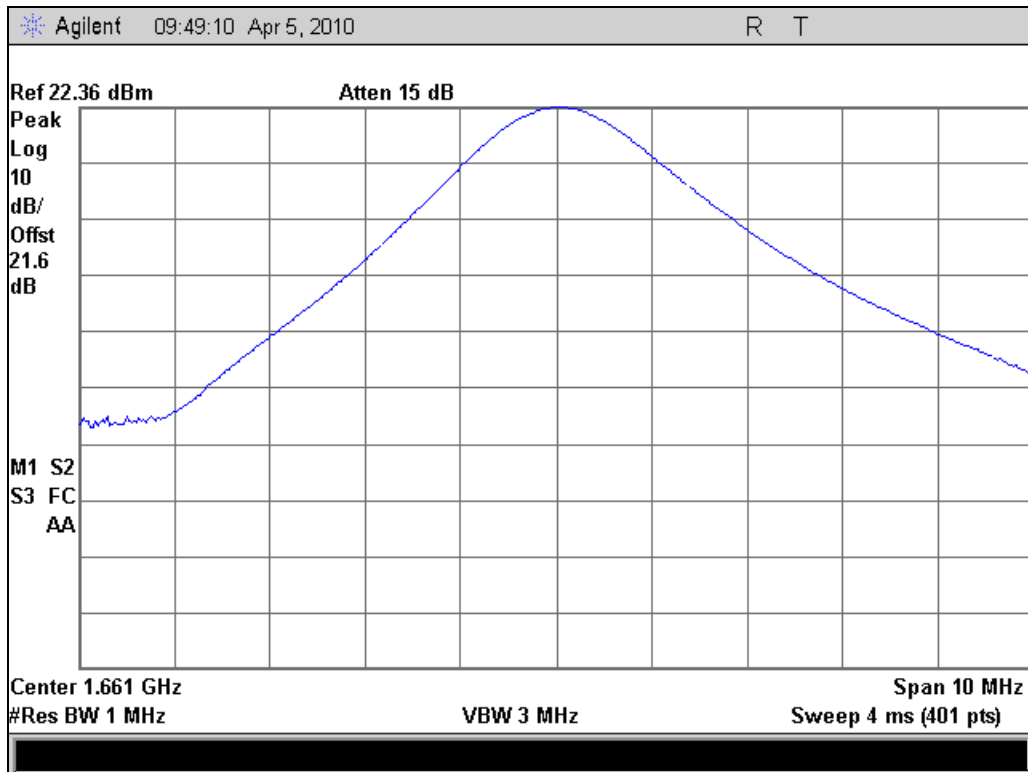

### QPSK 1626.5 MHz 7K20G1E

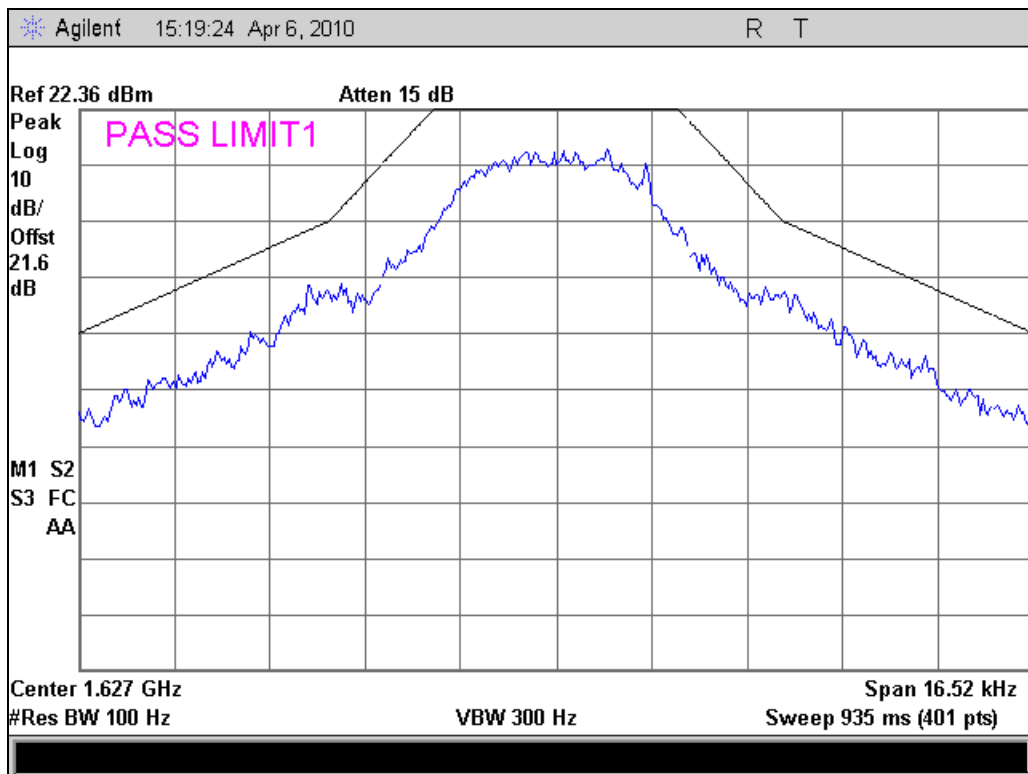





### QPSK 1643.5 MHz 7K20G1E

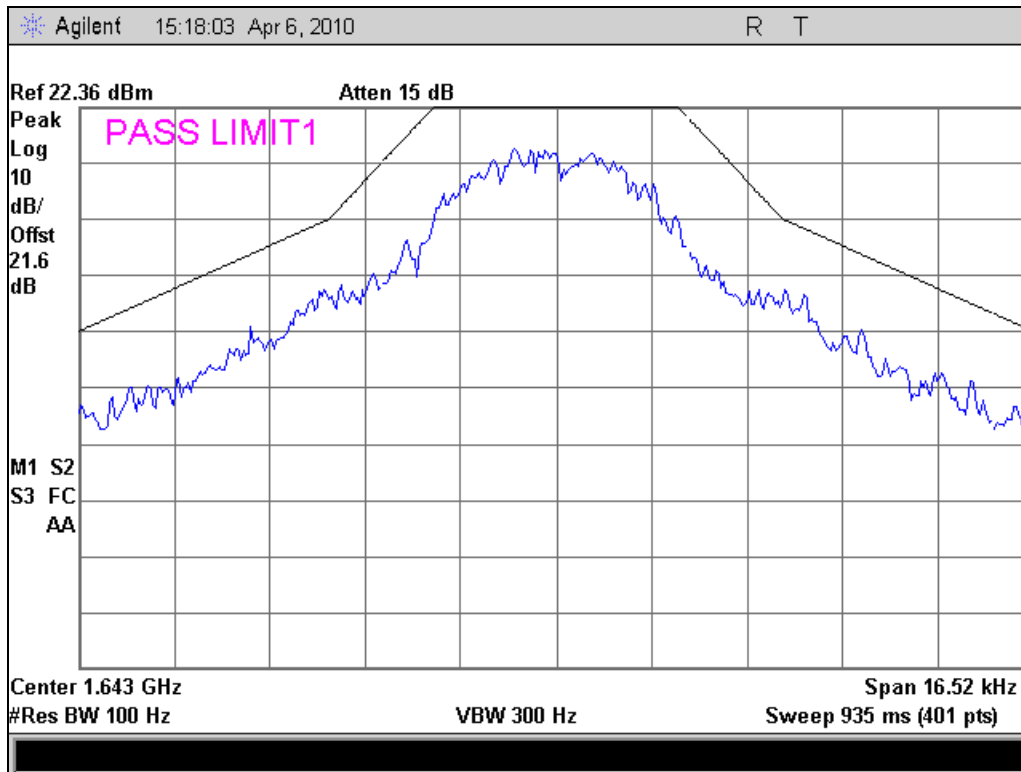

### QPSK 1660.5 MHz 7K20G1E

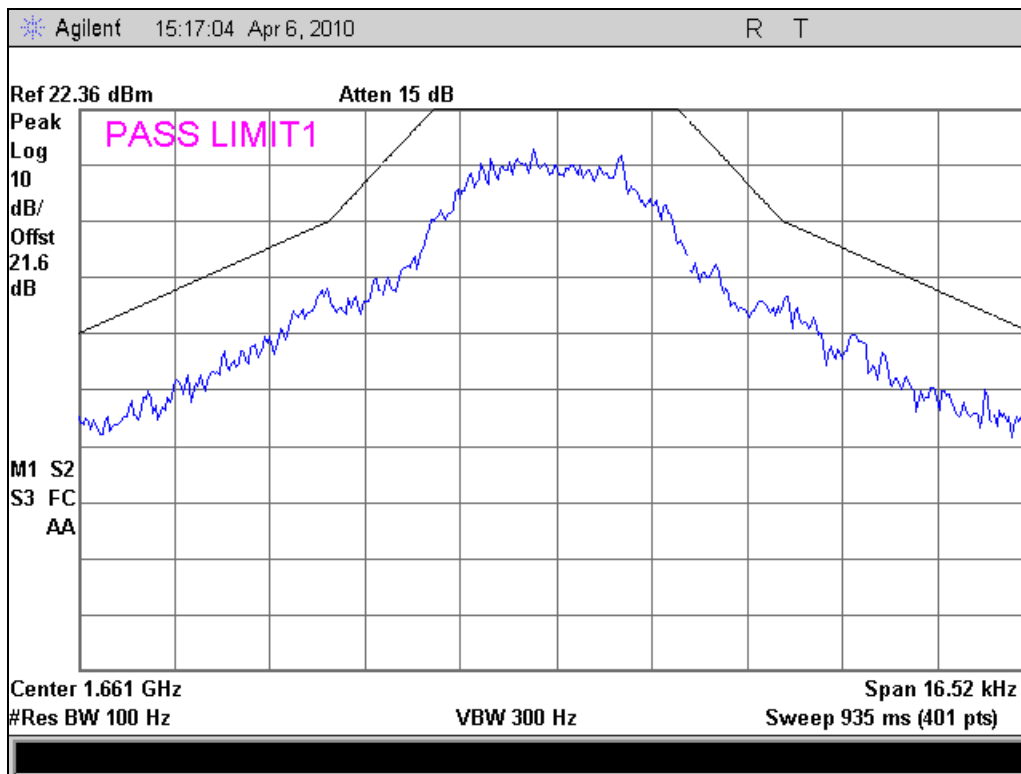



### QAM Emissions Mask

#### QAM 1626.5 MHz Reference

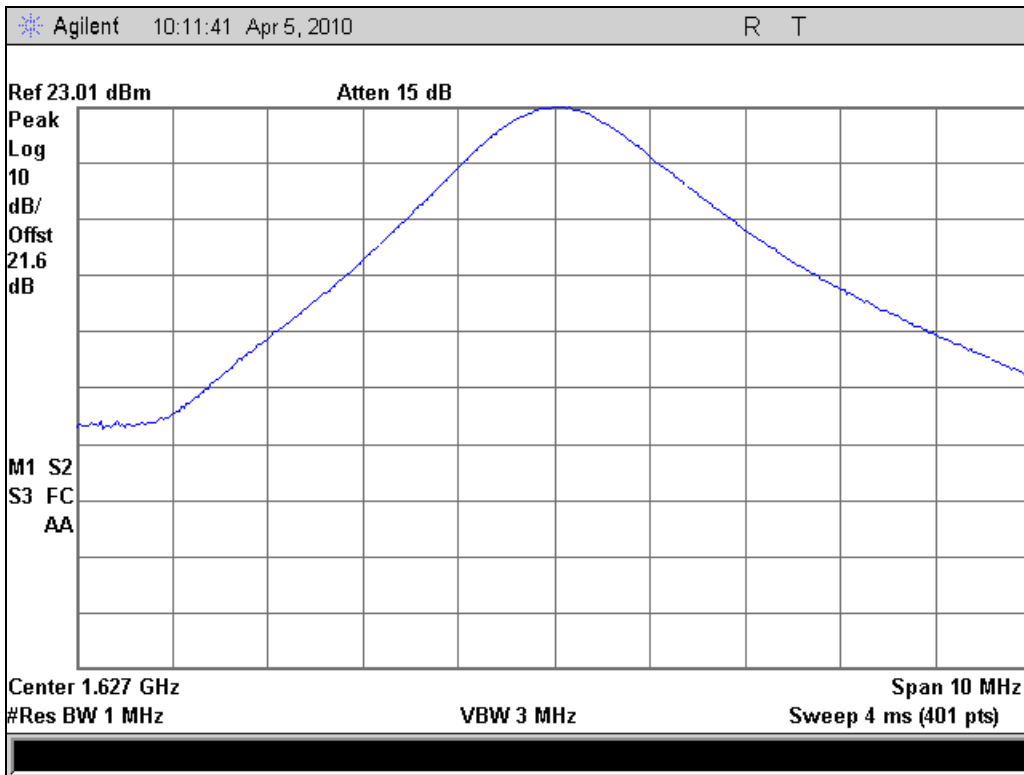

#### QAM 1643.5 MHz Reference

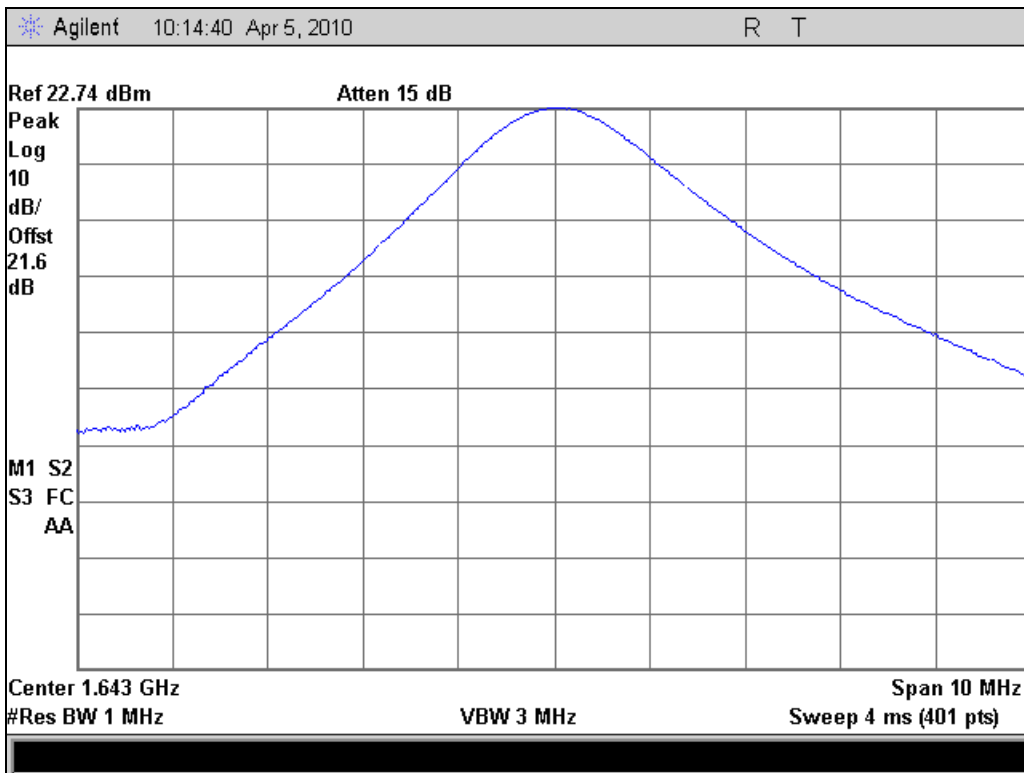



### QAM 1660.5 MHz Reference

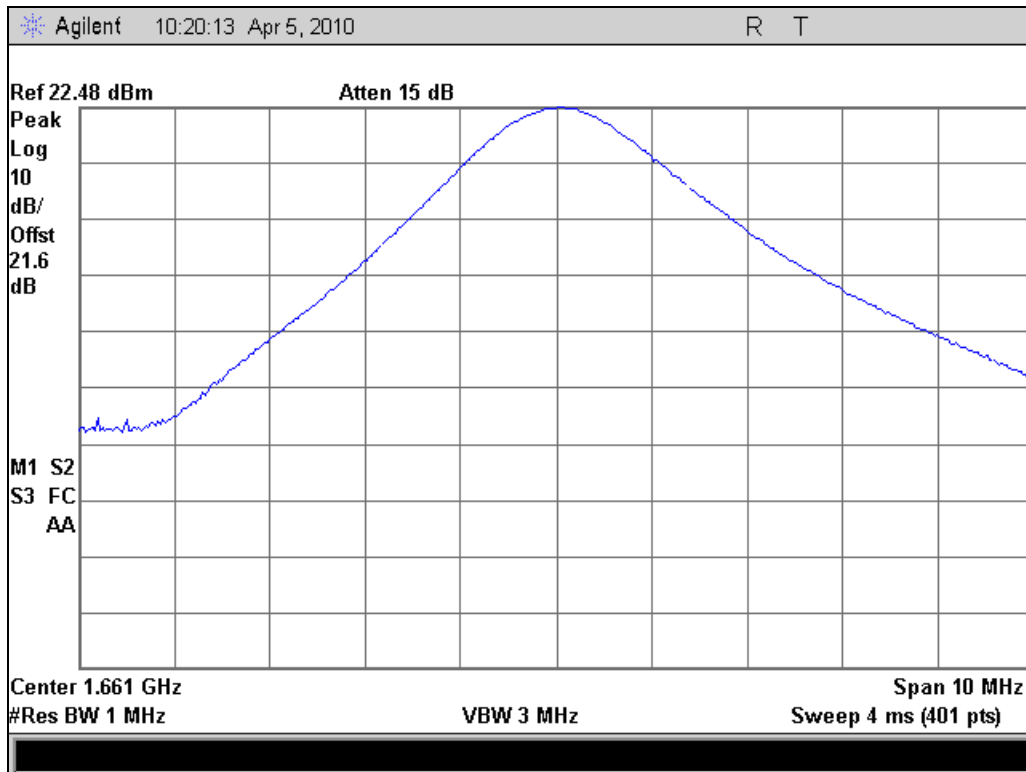

### QAM 1626.5 MHz 40K0G1E

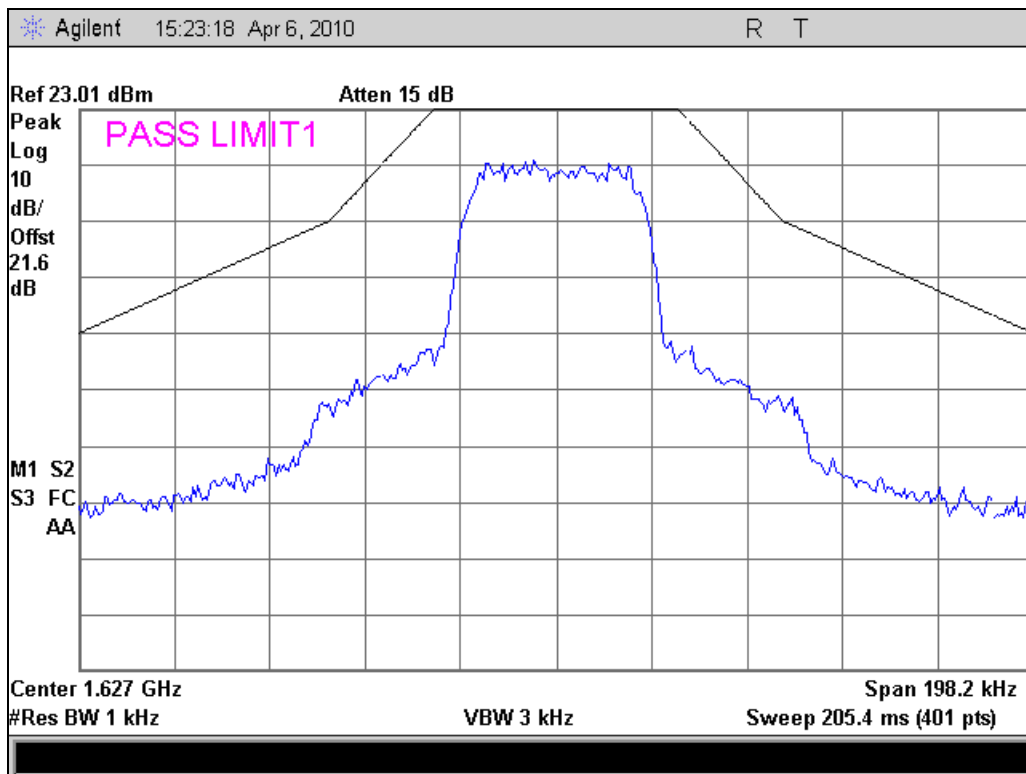

QAM 1643.5 MHz 40K0G1E

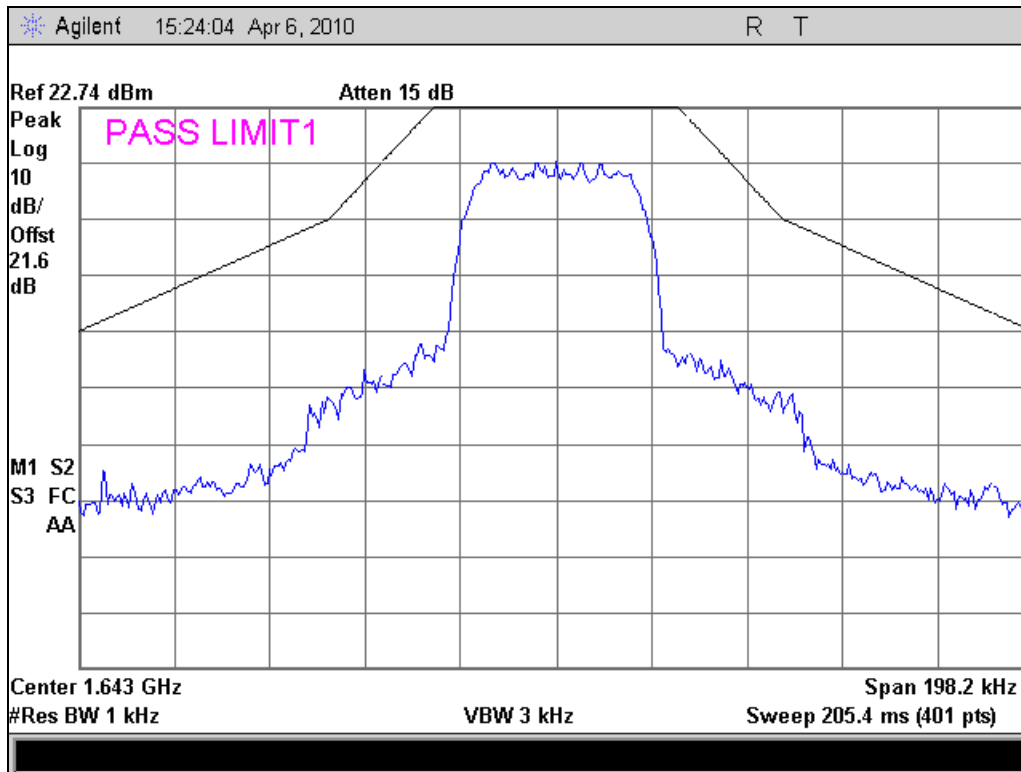

QAM 1660.5 MHz 40K0G1E

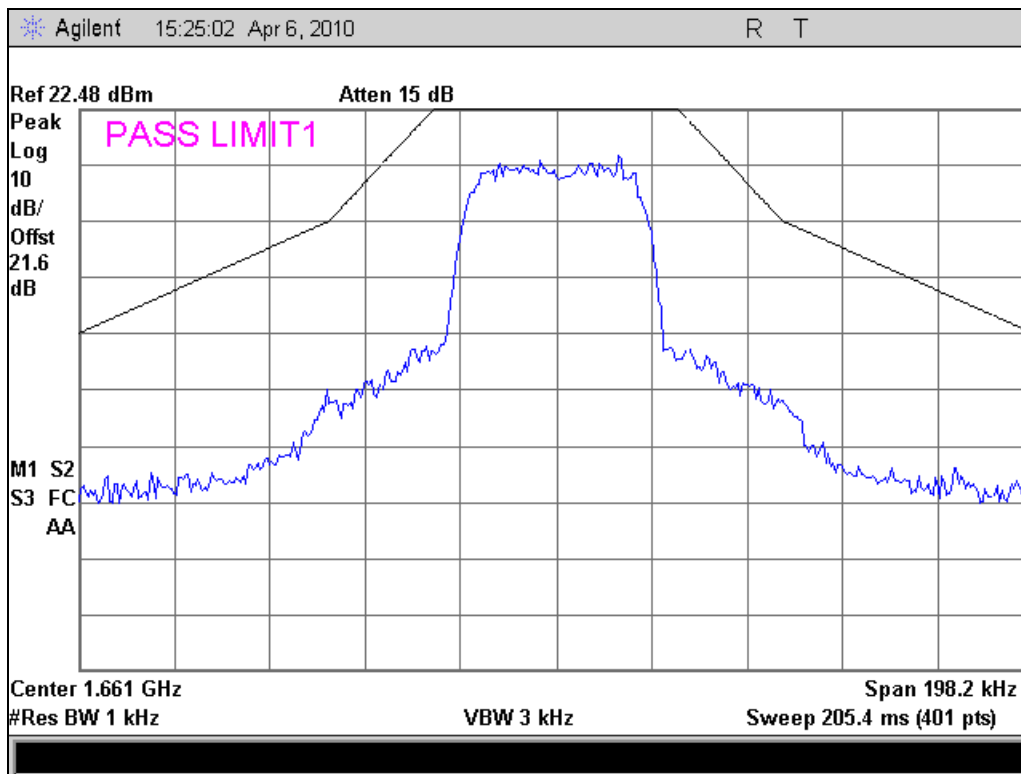

A waiver has been granted for this modulation type.

**Name of Test:** Frequency Stability (Temperature Variation)  
**Specification:** 87.133(a) **Engineer:** J. Erhard  
**Test Equipment Utilized:** 04010, 05123, i00027, i00029 **Test Date:** 4/2/2010

### Measurement Procedure

The EUT was placed in an environmental test chamber and the RF output was connected directly to a frequency counter. The temperature was varied from -30°C to 50°C in 10°C increments. After a sufficient time for temperature stabilization the RF output frequency was measured.

### Measurement Setup

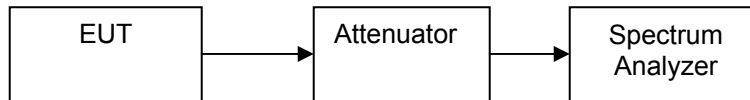

### Measurement Results

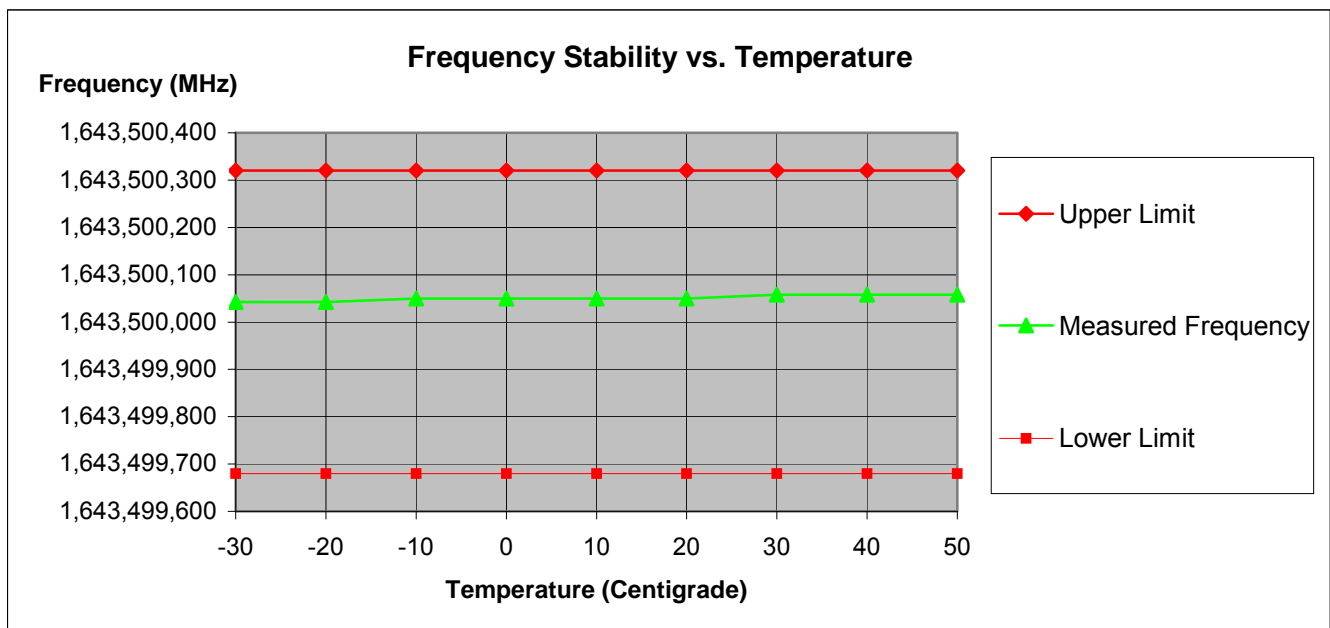

**Name of Test:** Frequency Stability (Voltage Variation)  
**Specification:** 87.133(a)  
**Test Equipment Utilized:** 04010, 05123, i00027, i00029

**Engineer:** J. Erhard  
**Test Date:** 4/2/2010

### Measurement Procedure

The EUT was placed in a temperature chamber at  $20 \pm 5^\circ\text{C}$  and connected directly to a spectrum analyzer. The power supply voltage to the EUT was varied from 85% to 115% of the nominal value and the RF output was measured. This was measured with a 400 Hz 115 VAC supply.

### Measurement Setup

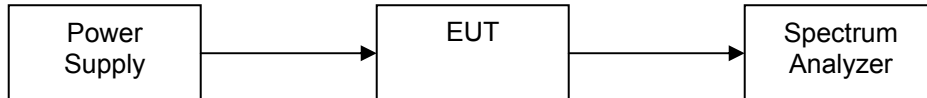

### Measurement Results

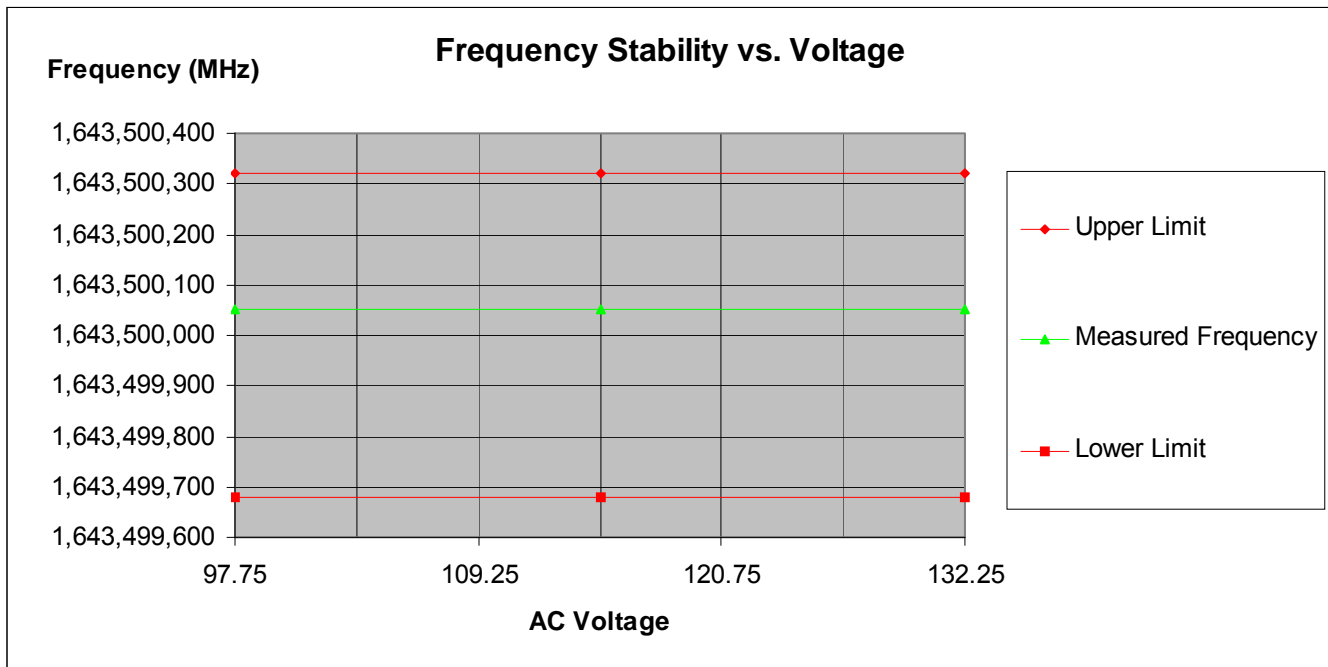



Name of Test: Necessary Bandwidth and Emission Bandwidth  
Specification: 2.202(g) Engineer: J. Erhard

**BPSK**

Modulation = 21K0G1D

Necessary Bandwidth Calculation:

- Signal States (S) = 2
- Data Rate (D) = 3
- Constant Factor (K) = 3.5
- Necessary Bandwidth (B<sub>N</sub>), kHz = 2\*D\*K / LOG<sub>2</sub>(S)

**QPSK**

Modulation = 7K20G1E

Necessary Bandwidth Calculation:

- Signal States (S) = 4
- Data Rate (D) = 5.6
- Constant Factor (K) = 1.29
- Necessary Bandwidth (B<sub>N</sub>), kHz = 2\*D\*K / LOG<sub>2</sub>(S)

**QAM**

Modulation = 40K0G1E

Necessary Bandwidth Calculation:

- Signal States (S) = 16
- Data Rate (D) = 134.4
- Constant Factor (K) = 0.6
- Necessary Bandwidth (B<sub>N</sub>), kHz = 2\*D\*K / LOG<sub>2</sub>(S)

Modulation = 40K0G1D

Necessary Bandwidth Calculation:

- Signal States (S) = 16
- Data Rate (D) = 134.4
- Constant Factor (K) = 0.6
- Necessary Bandwidth (B<sub>N</sub>), kHz = 2\*D\*K / LOG<sub>2</sub>(S)

**Test Equipment Utilized****Compliance Testing**

Asset#	Manufacturer	Model	Description	Last Calibration	Calibration Due
i00027	Tenney	Tenney Jr	Temperature Test Chamber	12/8/2009	12/8/2010
i00029	HP	8563E	Spectrum Analyzer	6/8/2009	6/8/2010
i00103	EMCO	3115	Horn Antenna	11/25/2008	11/25/2010
i00331	Agilent	E4407B	Spectrum Analyzer	11/0/2009	11/3/2010

**EMS**

Asset#	Manufacturer	Model	Description	Last Calibration	Calibration Due
0668	Weinschel	49-30-34	30 dB Power Attenuator	NCR	NCR
04010	Xantrex	XHR 40-25	Variable DC Power Supply	2/26/2010	3/26/2011
04806	California Instruments	801RP	400 Hz AC Supply	3/1/2010	4/1/2011
05123	California Instruments	801RP	400 Hz AC Supply	10/1/2009	11/1/2010

In addition to the above listed equipment standard RF connectors and cables were utilized in the testing of the described equipment. Prior to testing these components were tested to verify proper operation.





**Appendix**

**LNA Specifications**

**2.2.4.3.2.2 Type F - Transmit Port to Antenna Port**

The path from the transmit port to the antenna port should have the following characteristics:

Frequency (MHz)			Rejection
0.0	to	1525.0	>80 dB
1525.0	to	1559.0	> 120 dB
1559.0	to	1585.0	> 111 dB
1585.0	to	1605.0	> 95 dB
1605.0	to	1610.0	> 62 dB
1610.0	to	1614.0	> 40 dB
1614.0	to	1620.0	> 30 dB
1620.0	to	1624.5	> 20 dB
1624.5	to	1625.5	> 10 dB
1625.5	to	1626.5	Decreases
1626.5	to	1633.0	Insertion loss < 1.3 dB
1633.0	to	1660.5	Insertion loss < 0.8 dB
1660.5	to	1735.0	Increases
1735.0	to	1865.0	> 50 dB
1865.0	to	3250.0	> 20 dB
3250.0	to	3330.0	> 50 dB
3330.0	to	4000.0	> 40 dB
4000.0	to	12000.0	> 50 dB
12000.0	to	18000.0	> 15 dB

**2.2.4.3.3 Modified Type A Diplexer/LNA - For Protection of GPS and GLONASS**

**Transmit Port to Antenna Port**

The path from the transmit port to the antenna port should have the following characteristics:

Frequency (MHz)	Rejection
0.0 to 1525.0	> 80 dB
1525.0 to 1559.0	> 120 dB
1559.0 to 1585.0	> 100 dB
1585.0 to 1605.0	> 88 dB
1605.0 to 1610.0	> 62 dB
1610.0 to 1614.0	> 40 dB
1614.0 to 1626.5	> Decreases
1626.5 to 1631.5	Insertion loss < 2.3 dB
1631.5 to 1660.5	Insertion loss < 0.8 dB
1660.5 to 1735.0	Increases
1735.0 to 12000.0	> 50 dB
12000.0 to 18000.0	> 15 dB



### HSD-128 PA Specification

#### 3.1.9 Out-Of-Band Gain

Frequency	Gain
0-700MHz	At least 30dB below the in-band value
700-1626.5MHz	Linear variation from value at 700MHz to value at 1626.5MHz (gain in dB, frequency on linear scale)
1660.5-2400MHz	Linear variation from value at 1660.5MHz to value at 2400MHz (gain in dB, frequency on linear scale)
2400-18,000MHz	At least 60dB below the in-band value

**Table 3.1-1 Out-Of-Band Gain**

END OF TEST REPORT